

BHAVNAGAR MUNICIPAL CORPORATION



Bid Documents For

**PROPOSED DEVELOPMENT OF NIGHT SHELTER AT FULSAR, FOR
BHAVNAGAR MUNICIPAL CORPORATION (B.M.C), BHAVANAGAR**

NOTICE INVITING TENDER & QUALIFICATION CRITERIA

ARCHITECTS:

CHINTAN SACHAPARA
ARCHITECTS

EXECUTIVE ENGINEER
Building Department
Bhavnagar Municipal
Corporation
Mangalsinhji Road,

3,SHAHIBAUG,ABOVE HOME DÉCOR,WAGHA WADI ROAD,
BHAVNAGAR
PHONE : 9428401640

Bhavnagar – 364 001

BHAVNAGAR MUNICIPAL CORPORATION	
Notice Inviting On-Line Tender	
Tender Notice No. BUILDING / Fulsar-Night Selter/ 2024-25	
Department Name	: Building Department
IFB No.	: BUILDING / Fulsar-Night Selter / 2024-25 (Second Attempt)
Name of Project	: NIGHT SELTER (GOV. DAY-NULM)
Name of Work	: PROPOSED DEVELOPMENT OF NIGHT SHELTER AT FULSAR, FOR BHAVNAGAR MUNICIPAL CORPORATION, (B.M.C) BHAVANAGAR
Tender Type	: Open – Percentage rate Tender
Estimated Contract Value (INR)	: 11,99,40,841.00
Period of Completion (in month)	: 32 (THIRTY TWO) Months Including Monsoon period
Bidder Nationality	: LCB (Local Competition Bidding)
Qualification Of Bidder	: Duly registered with R&B in Class "AA" Class & Above and Special Building Category-I
Bid Call (Nos)	: 1
Tender Currency Type	: Single
Tender Currency Settings	: Indian Rupee(INR)
Joint Venture / Consortium	: N.A.
Rebate	: N.A.
Amount Details	
Bid Document Fee	: Rs.18000.00 + 3240.00 (18% GST) =

	21240.00 in the Form of DD only/-(Rs. Twenty One Thousand Two Hundred Fourty Only)
Bid Document Fee Payable To	: Commissioner, Bhavnagar Municipal corporation, Bhavnagar
Bid Security /EMD(INR)	: Rs. 12,00,000.00 (Rs. Twelve Lakhs Only.)(only D.D.)
Bid Security/ EMD in favour of	: Commissioner, Bhavnagar Municipal Corporation, Bhavnagar
Tender Dates	
Bid Document Downloading Start Date	: Dt. 20/12/2024
Bid Document Downloading End Date	: Dt. 30/12/2024 18:00
Pre-Bid Meeting &Time	: No
Last Date &Time of Online Bid Submission	: Dt. 30/12/2024 18:00
Physical Submission of EMD Document Fee PQ Bid & Supporting all documents	: Dt. 30/12/2024 to Dt. 02/1/2025 up to 06:10pm office of the Executive Engineer, Building Department, BMC-Bhavnagar
Opening Of Bid(Online) & TechnicalBid	: Dt. 03/01/2025, 17:00
Penalty	0.10 % of contract value per day to the maximum amount of 10% of contract value
Opening Of PriceBid (Online)	: Intimation through letter.
Bid Validity Period	: 180 Days
<u>Qualification of Bidder:</u>	Tenderer shall be required to submit the enlisted documents in hard copy along with the Qualification Bid. If documents are insufficient or it does not match the required criteria mentioned below, then the Price Bid of the tenderer shall not be opened.

Mainly tenderer shall fulfill following Technical & Financial pre- qualification criteria as a main contractor. The tenderer shall fulfill the following all points A to Q requirements /experiences for qualification.

A. The Bidder must have achieved average annual turnover during last three financial years, ending on 31st March 2024 of Rs. **359.82 LAKHS.**

B. The Bidder shall have positive Net worth for latest financial year (2023-24) of Rs. **119.94 LAKHS** as on 31st March 2024.

C. The Bidder must have experience of successful completion of similar work on its own in India within last 7 years as on date of bid submission

(a) One Project of minimum value Rs.80% of the Project Value

OR

(b) Two Projects of minimum value Rs.50% of the Project Value each

OR

(c) Three Projects of minimum value 40% of the Project Value of each

Note: Similar work shall mean Construction of Building Work as mentioned in tender documents in any of government organizations only. like **R&B/Govt./Semi Govt./PSUs/Government Undertaking /Government Companies Department**

D. Available Bid Capacity (ABC) - must be more than the estimated tender cost.

Note: Available Bid Capacity (ABC) will be derived by the following method. ABC is calculated as $ABC = 2 * A * N - B$

Where,

A = Maximum value of works executed in any

one year during the last five years (updated to present price level by applying enhancement factor) taking into account the completed as well as works in progress.

N=Number of year sprescribed for completion of the works for which tenders are invited.i.e.12/12= 1.00

B=Valueofexistingcommitmentsandon-goingworkstobecompletedduringthatnext Nyear (period of completion oftheworksforthetendersare invited.)

Note: The statements/certificate showing the value of existing commitments and ongoingworksaswellasthestipulatedperiodofco mpletionremaining

foreachoftheworkslistedshould be signed by the respective Employer or his authorized representative, not belowtherankofanExecutiveEngineerorequivalente nt.

E. ThecostofmaterialsuppliedbytheGovernme nt/Clientshallnotbetakenintoaccountforexp eriencepurpose.

F. An attested copy of registration with R&B etc. **Registration required: "AA" Class & Above and Special Catogary Building-I. Bank Solvency of Current Financial Year (2024-25) (20% of Tender amount.) of any Nationalized/Scheduled Bank except Co-operative Bank.**

G. Following enhancement factors will be used for the cost of works executed andfinancialfigurestoarriveatcommonbasef orthevalueofthe workscompletedinIndia.Cutoff month shallbeconsideredfrom monthoftendersubmission.

Year	Multiplying factor
Immediate last year of the assessment year*	1.1
Second	1.21
Third	1.33
Fourth	1.46
Fifth	1.61
Sixth	1.77
Seventh	1.95

*Here assessment year shall be reckoned from year and month in which tender is submitted.

- H. The experience of Joint Venture/Back-to-back work/Nominated Sub-contractors by agencies shall not be considered.
- I. The Bidders should submit Solvency Certificate minimum value of Rs. **(20% of Tender amount.)** issued by schedule bank / Nationalized bank only and should be valid for at least up to six months from the date of submission.
(Considering validity as 1 year from date of issue of Solvency Certificate)
- J. The Bidders should submit the list of the works already completed during last 7 years in prescribed Performa and attested copies of certificates issued by head of the office concerned for completed work.
- K. The Bidders shall submit Declaration regarding the work on hand with the bidder in prescribed Performa. Attested copies of work orders, interim certificate if any shall also be attached as supporting documents for above.
- L. The Bidders shall submit the attested copy of partnership deed, power of attorney, et

	<p>c.</p> <p>M. Joint Ventures shall not be allowed.</p> <p>N. Even though the Bidder meets the above criteria, they are subject to be disqualified if they have</p> <p>i) Made misleading or false presentations in the forms, statements and attachments submitted in proof of the qualification requirements ; and/ or</p> <p>ii) During verification if it is found from client that of poor performance such as abandoning the works, for financial failure or abnormal delay in work etc.</p> <p>iii) Regarding Litigation, in case where Bidder or JV partner or MOU Partner is involved in illegal practice like any activities of corruption, coercive practice or debarred/blacklisted in last 2 years by Any Govt / Organization in respect of performance of Bidder / MOU partner / JV partner, BMC authority requires that bidders under this contract, observe the highest standard of ethics during the procurement and execution of such contracts.</p> <p>(1) Will reject a proposal for award if it determines that the bidder has engaged in any corrupt or fraudulent practices in competing for this contract in past history and</p> <p>(2) Will reject a proposal if it found debarred/blacklisted by any State Govt. / Govt. of India/ Semi Government/ PSU in last 10 years.</p>
--	---

	<p>iv) The bidder or MOU partner shall not be under any Insolvency Bankruptcy code (IBC) resolution process at National Company Law Tribunal (NCLT) or under any Corporate Debt Restructuring (CDR) mode in the past 10 years in India from the date of the submission of the bid.</p> <p>Q. The Bidder shall note that in case the Bidder/MOU partner is blacklisted/stated as defaulter/banned participating in tenders by any of government agencies / semigovernment agencies/PSUs in India during last 10 years then in that case, the Bidder will be disqualified though the bidder satisfies all the pre-qualification conditions mentioned above, and the bidder will be debarred for next 3 years from participating in tender process for BMC.</p> <p>P. Bidders should be selected based on quality work done by them and if necessary tender committee will inspect bidders ongoing and completed work.</p> <p>Q. The decision of the commissioner to quality the bidder will be the final.</p> <p>R. Conditional Tenders will be outrightly rejected.</p> <p>S. The applicant must submit this confirmation letter on Rs.300.00 stamp paper with notary for Operating and Maintenance of proposed work shall include labour, all materials, plants, plants casualities, fertilizers, pesticides, tools, watering security of premises shall be responsibility of the Tenderer during the course of work and 2 years after the time of completion certificate from authority and all charges for the same borne by the</p>
--	---

Contractor (Tenderer). 1% from every running bill shall be deducted towards SECURITY DEPOSITE of Operating and Maintenance of proposed work. ~~IF WILL~~ ~~BEREAL ESEDA FETR~~ ~~COMPLETION PERIOD OF 24~~ ~~MONTHS OF~~ &M:

- T. If work is not completed within time limit, penalty of 0.10% per day will be deducted from running bill and it will be up to 10%.
- U. FDR For EMD and SD, or bank guarantee issued by state bank of India will not be accepted. Bidder should submit FDR or bank guarantee issued by another nationalized bank only.
- V. Bidders shall quote the rate with all taxes including GST. No extra payment for GST will be done by BMC.

VARIATION IN QUANTITIES

Schedule of prices contain estimated quantities and actual quantities as executed becomes payable at agreed rates. However, accepted rates will be valid till variation in quantities up to any extent of the quantities so specified.

- W. Other terms and conditions of the tenders shall be read and considered as a part of the tender documents. The rates/prices quoted by the bidders will be final and any sort of escalation will not be considered.

Note:

Star Rate, Price Escalation, price Variation in any items of Schedule-B / Extra item will Not be given by Bhavnagar Municipal Corporation. If Same will be stated in any Bid Documents

	will not be Considered.
Remarks	<p>: Only Offer of those shall be opened whose EMD & Tender Fee evidence is received electronically along with the bids. However, for the purpose of realization of Demand Draft, bidders shall send them in original through RPAD/Speed Post/Reg. A. D. so as they reach to the office of Executive Engineers</p> <p>- Building Dept., Bhavnagar Municipal Corporation, Bhavnagar during office hours between Dt. 30/12/2024 to Dt. 02/01/2025. Penetrative action shall be imposed for not submitting the supporting documents in original to E.E. by bidder. All the successful bids, if possible, will be physical document opened on 03/01/2025, 17:00 in presence of tender committee at the City Engineer's Office, Commercial stage will be opened after approved this tender document Bhavnagar Municipal Corporation, Bhavnagar. FDR FOR EMD OR SD, OR BANK GAURANTEE issued by state bank of India will not be accepted</p>
General Terms & Conditions	<p>: Bidders who wish to participate in this E-Tender will have to procure valid digital certificate as per information Technology Act 2000. Bidders can procure this certificate from any of the Government approved certifying agency i.e. (n) Code Solution.</p> <p>DOWNLOAD OF TENDER DOCUMENT:</p> <p>The tender document for this work is available only in digital format which can be downloaded free of cost by the bidder.</p> <p>SUBMISSION OF TENDER:</p> <p>Tenderer shall submit their offer in electronic format on above mentioned website or before the scheduled date and time as</p>

mentioned, after Digitally Signing the same.

Bidders shall upload the tender documents after submitting the DD details for tender fees and EMD in form of DD/Bank Guarantee details online. The Demand Draft toward Tender Document fees can be submitted along with Earnest Money Deposit before the due date as specified above.

This should be as per details given online and it should be drawn before last date of the uploading of the tender

The intending bidders shall have to submit the following documents in Physical form along with the EMD and tender fees.

- (a) Documents required for evaluation as sought in different annexure duly digitally signed.
- (b) Power of attorney.
- (c) Company's profile and certificate of Registration of company under the law.

The Bidder should submit price Bid digitally only. **Price bid in physical form shall Not be accepted** and any such offer if received by Bhavnagar Municipal Corporation same will be outrightly rejected.

Technical bid in physical form is not required to be submitted by all bidders. However, non-submission of technical bid does not absolve bidders from and liability of the tender. Only successful bidders have to submit the technical bid duly signed in physical form upon intimation from BMC.

OPENING OF TENDER:

	<p>The Technical Bid will be opened on the specified date online on website https://tender.nprocure.com/ Bidders or their representative who wish to participate in online tender opening can log on to www.tender.nprocure.com on the due date and time, mark their presence and participate in online tender opening. Bidders who wish to remain present at Bhavnagar Municipal Corporation, only one representative of each firm will be allowed to remain present.</p>
<p>Information for online participation</p>	<ol style="list-style-type: none"> 1. Internet site address for e-Tendering activities will be www.tender.nprocure.com 2. Interested bidders can view detailed tender notice and download tender documents from the above-mentioned website. 3. Bidders who wish to participate in online tender have to register with the website through the "New User Registration" link provided on the home page. Bidder will create login id & password on their own in registration process. 4. Bidders who wish to participate in this tender need to procure Digital Certificate as per Information Technology Act-2000 using that they can digitally sign their electronic bids. Bidders can procure the same from many of the CCA approved certifying agencies, or they may contact (n) code Solution at below mentioned address and they will assist them in procuring the same. Bidders who already have a valid Digital Certificate need not to procure the same. In case bidders need any clarification regarding online participation, they can contact M/S (n) code Solution

	<p>301, G.N.F.C. Info Tower, NeargrantBhagwatiHotel, Ahmedabad380015, India. Tel: +917926857316 Tel: +917926857317 Tel: +917926857318 E-Mail: URL: www.tender.nprocure.com</p> <p>5. Bidderswho wishtoparticipateine- Tenderneedtofilldatainpredefinedformssoften derfee,EMD, PQ(Technical)orexperiencedetailsandPricebi d only.</p> <p>6. Biddershoulduploadscancopiesofreferenced ocumentsinsupportoftheireligibilityofthe bid.</p> <p>7. Afterfillingdatainpredefined formsbiddersneedtoclickonfinalsubmissionli nktosubmittheirencryptedbid.</p> <p>BiddercanalsosubmitDocumentFees,EMD,Techn icalbiddocument&ReferenceDocumentsinhard copyifsuchinstructionsaregivenbytenderingauth ority.</p>
OfficerInvitingBids	ExecutiveEngineer, BuildingDepartment, B havnagar Municipal Corporation, Bhavnagar.
BidOpeningAuthorityMem bersincommittee	(1) City Engineer (2) Executive Engineer Building Department.) (3) ChiefAccountant (4) ChiefAuditor
Address	Building Department, Bhavnagar Municipal Corporation, Sir Mangalsinhji Road, Bhavnagar
ContactPerson	For further details of any query regarding the tender Contact to: Executive Engineer (Building Department), Bhavnagar Municipal Corporation., Sir Mangal sinhji Road,

	Bhavnagar-364001 Mobilen.9978400961 E-mail: building_bmcgujarat@gmail.com
--	--

Date : /12/2024
Place: Bhavnagar

**Executive Engineer
Building Department
Bhavnagar Municipal Corporation**

FORM B- 1

OMD" B v!

**EXECUTIVE ENGINEER, BUILDING DEPARTMENT,
BHAVNAGAR MUNICIPAL CORPORATION,
BHAVNAGAR**

**PERCENTAGE RATE TENDER AND CONTRACT FOR
WORKS**

SFDM DF8G] 8SFJFZL NZJF/] 8f0Z VGI SMg8FS8

Name of Work:
કામનું નામ

**PROPOSED DEVELOPMENT OF NIGHT SHELTER
AT FULSAR, FOR BHAVNAGAR MUNICIPAL
CORPORATION, BHAVNAGAR**

Division:-

**EXECUTIVE ENGINEER, BUILDING DEPARTMENT,
BHAVNAGAR MUNICIPAL CORPORATION,
BHAVNAGAR**

8f0Z VF%I F TFZLB TFP **As per NIT** 8f0Z : JLSFZJFGL Kf, L TFZLB TFP ...**As per NIT** (Online)
; DI 0 SRZLGF SFDSFHGF 18:00 S, FSM; jw

Issue To - શ્રી

G[VF%I P

IJEFULI IC; FAGLX

OPENED BY

The City
Engineer, in presence of tender Committee
Bhavnagar Municipal Corporation,
Bhavnagar

ON DATE

**EXECUTIVE ENGINEER,
BUILDING DEPARTMENT,
BHAVNAGAR MUNICIPAL
CORPORATION, BHAVNAGAR**

SFI 5F, S . HGZ

MEMORANDUM OF WORKS IN BRIEF

1. Name of work : **PROPOSED DEVELOPMENT OF NIGHT SHELTER AT FULSAR, FOR BHAVNAGAR MUNICIPAL CORPORATION, (B.M.C) BHAVNAGAR**

2. Estimated Cost : Rs. **11,99,40,841.00**

3. Earnest Money : Rs **12,00,000.00**

4. Validity period of tender offered **180 days from the stipulated date of receiving of the tender but no modification shall be allowed after the last submission date of tender.**

5. Security Deposit

A (Total 5.0% of contract value, This will be deposited as under)

of Initial S.D. @ 2.50% of contract value (Not less than EMD) in cash or in the In the form of pay order/DD/FDR/Bank Encashable at BHAVNAGAR Only)	2.50% of contract value
To be deducted from current bill at: 10.00% to buildup remaining 2.50% Of SD value	2.50% of contract value
Total deposit at 5.00% of contract Value	5.00% contract value

B Performance Guarantee

Performance Guarantee @ 5.00% of actual work amount in form of F.D.R. or Bank Guarantee of Nationalized or Scheduled bank in favour of Commissioner, Municipal Corporation, Bhavnagar. (To be submitted on completion of work & before final payment)

Performance guarantee will be released after defect liability period is over.

6. Time allowed for completion of the work : **32 months (INCLUDING MONSOON PERIOD)**

7. Other details

(I) The tender must be submitted to **EXECUTIVE ENGINEER,
BUILDING DEPARTMENT,
BHAVNAGAR MUNICIPAL CORPORATION,
BHAVNAGAR by e-submission as
per the schedule mentioned in the tender
notice**

(ii) Mode of Sending the tender : as mentioned in the tender notice

(iii) Description essential to be NA

made on sealed cover :

(iv) Mode of quoting rate : Figures as well as in words in Schedule "B"

TENDER

Date: _____

To,
Executive Engineer,
BUILDING DEPARTMENT,
Bhavnagar municipal Corporation,
BHAVNAGAR.

Dear Sirs,

We hereby offer to execute the proposed work **PROPOSED DEVELOPMENT OF NIGHT SHELTER AT FULSAR, FOR BHAVNAGAR MUNICIPAL CORPORATION ,(B.M.C) BHAVANAGAR**

Under PERCENTAGE RATE contract at the respective rates as mentioned in the accompanying schedule of quantities and rates (schedule-B).

We have studied the site and have read the terms and conditions of work, drawings, special conditions, articles of agreement, conditions of contracts and specifications.

We agree to finish the entire work within **32 (thirty Two) months** (INCLUDING MONSOON PERIOD)from the date of order for commencement of work.

We have deposited as earnest money a sum of **RUPEES ELEVEN LAKHS NINTY NINE THOUSAND FOUR HUNDRED NINE ONLY** with you, which amount is not to bear any interest and we do hereby agree that this sum shall be forfeited by you if we fail to execute the contract when called upon to do so, in the event of your accepting our tender.

Yours faithfully,

Name in capital letters : _____

Name of firm : _____

Name of directors : _____

Name of partners : _____

TENDER TO BE SUBMITTED BY e-submission as mentioned in the tender notice

Article of Agreement

This Articles of Agreement is made on the ___day of ___2024 between The Executive Engineer, BUILDING DEPARTMENT, Bhavnagar Municipal Corporation, Bhavnagar. (here in after called " The Owner ")

On one part an _____

Whose registered office is situated at _____

(here in after called "The Contractor") of the other part

WHEREAS the owner is desirous of constructing **PROPOSED DEVELOPMENT OF NIGHT SHELTER AT FULSAR, FOR BHAVNAGAR MUNICIPAL CORPORATION, (B.M.C) BHAVANAGAR** (here in after called "The Work") at Bhikda canal near shampara bridge, Bhavnagar, and has caused Drawings and Bills of Quantities showing and describing the work to be done and prepared by and under the direction of **Architect CHINTAN SACHAPARA** and whereas the Contractor has supplied the owner with a full priced copy of said Bills of Quantities (which copy is here in after referred to as "the Contract Bills") and whereas the said Drawings (here in after referred to as "the Contract Drawings") and the Contract Bills have been signed by or on behalf of the parties here to: and whereas the Contractor has deposited the sum of **RUPEES ELEVEN LAKHS NINTY NINE THOUSAND FOUR HUNDRED NINE ONLY** with the Owner for the due performance of this Agreement.

NOW IT IS HEREBY AGREED AS FOLLOWS :

1. For the consideration here in after mentioned the Contract will upon and subject to the conditions annexed carry out and complete the work shown upon the contract drawings and described by or referred to in the Contract Bills and in the said conditions.
2. The Owner will pay the Contractor the sum of **(RUPEES ELEVEN CORERS NINTY NINE LAKHS FORTY THOUSAND EIGHT HUNDRED FORTY ONE ONLY)** (here in after referred to as "the Contract Sum") of such other sum as shall become payable here under at the times as in the manner specified in the said conditions.
3. The term "The Architect " in Conditions shall mean the said
CHINTAN SACHAPARA
ARCHITECTS

3, SHAHIBAUG, ABOVE HOME DÉCOR, WAGHA WADI ROAD,
BHAVNAGAR
PHONE : 9428401640
4. or in the event of his death or ceasing to be the Architect for the purpose of this Contract, such other person as the Owner shall nominate for that purpose, not being a person to whom the Contractor shall object for reasons considered to be sufficient by an arbitrator appointed in accordance with the said Conditions Provided always that no person subsequently appointed to be the Architect under this contract shall be entitled to disregard or overrule any certificate or opinion or decision or approval or instruction given or expressed by the Architect for the time being.

2. The said condition and appendix there to shall be read and construed as Forming part of this Agreement, and the parties hereto shall respectively abide by, submit themselves to the conditions and perform the agreements on their parts respectively in such conditions contained.

AS WITNESS the hands of the said Parties.

Signed by the said
in the presence of

Owner

Witness : _____

Name : _____

Address : _____

Signed by the said

Contractor.

Witness : _____

Name : _____

Address : _____

Bank Guarantee is applicable only when the estimated cost of work is more than Rs. 50 lacs.

BANK GUARANTEE

Where _____ as _____ M/s _____ (hereinafter called the Tenderer) is desirous and preferred to tender for works in accordance with the terms and conditions of tender for the work of **PROPOSED DEVELOPMENT OF NIGHT SHELTER AT FULSAR, FOR BHAVNAGAR MUNICIPAL CORPORATION, (B.M.C) BHAVANAGAR** and where as We Bank, agree _____ to give the tenderer a guarantee for the Earnest Money.

1. Therefore, we hereby affirm that we are guarantors on behalf of the Tenderer up to total rupees _____ in words) Rs. _____ (in figures) and we undertake to pay to The Commissioner, Bhavnagar Municipal Corporation, Bhavnagar up to his first written demand, without demur, without delay and without the necessity of a previous notice of judicial or administrative procedures and without the necessity to prove to the Bank the defects or shortcomings or debits of the contractor any sum within the limit of Rs. _____.
2. We further agree that the Guarantee herein contained, shall remain in full force and effect during the period that would be taken for the acceptance of tender. However, unless a demand of claim under this guarantee is made on us in writing on or before the _____ (Date to be specified – will not be less than 180 days from the stipulated date of receiving the tender) we shall be discharged from all liabilities under the guarantee thereafter.
3. We undertake not to revoke the guarantee during its currency except with the previous consent of, The Commissioner, Bhavnagar Municipal Corporation, Bhavnagar in writing.
4. We lastly undertake not to revoke the guarantee for any charge in constitution of the Tenderer of of the Bank.

Date

Signature & Seal of

Guarantor _____

Bank Address _____

5. The contractor shall have to furnish PAN and intimate I.T. ward under which he is accessed.
6. Copies of certificated as regards previous experience, if any, must accompany the tender.
7. Declaration showing all works on hand with the Contractor and the value of works that remains to be executed in each case must accompany the tender.
8. All pages of Schedule 'A' and 'B' and specifications should be initialed by the Contractor.
9. All corrections, erasures and overwriting should be initialed by the Contractor.

10. Discrepancies and adjustment of Errors :

Any error in quantity or amount in Schedule 'B' showing items of work to be carried out shall be adjusted in accordance with the following rules.

- (a) In the event of a discrepancy between description in words and figures quoted by a tenderer in the rates column, the description in words shall prevail.

(b) In the event of an error occurring in the 'amount' column of the Schedule 'B' showing items of work, as a result of wrong multiplication of the unit rate and quantity; the unit rate shall be regarded as firm and multiplication shall be amended on the basis of the rate.

(c) All errors in totaling in 'amount' column in carrying forward totals shall be corrected.

(d) Any rounding of amount against "items" or in "totals" shall be ignored.

P

The tendered sum so altered shall for the purpose of the tender be substituted for the sum originally tendered and considered for acceptance.

10. (i) It may please be noted that the tender will be considered as invalid, especially, if the requirements as per instruction No. 1 to 10 above are not complied with before submitting the tender. Also please read carefully the face sheet and 'General Rules and Directions for the guidance of contractor's of this form.

(ii) Right is reserved to reject any or all tender(s) without assigning any reason(s) therefore.

10-A The tender documents shall have to be filled in either ink or by ball pen.

11. In addition to the above, the tender will also be liable to be rejected outright if-

(i) The tenderer proposes any alteration in the work specified or in the time allowed for carrying out the work or any condition or correction in any code or mode of Schedule 'B' or specifications.

any of the page of the tender is/are removed or replaced.

(ii) all corrections, additions or pasted slips are not initialed by the tenderer.

(iii) Any erasure is made by him in the tender and.

(iv) The tenderer or in the case of a firm, each partner or the person holding the power of attorney thereof does not sign or signature is/are not attested by a witness on page 15 of the tender in the space provided for the purpose.

11. A certificate of registration as approved contractor should be attached with tender.

Pages 5 & 6 are E-tendering of B-1 Tender Forms only

DATA SHEET for B-1 E-Tendering

(A) Details of Tender Item :-

Sr. No.	Name of Work	Estimated Tender Value (Rs. in lacs)	EMD (Rs. in lacs)	Tender fee in Rs.	Total Security Deposit @ 10%	Period for Completion of Work
1	2	3	4	5	6	7
1	PROPOSED DEVELOPMENT OF NIGHT SHELTER AT FULSAR, FOR BHAVNAGAR MUNICIPAL CORPORATION, (B.M.C) BHAVANAGAR	11,99,40,841.00	12,00,000.00	18000/- +18% GST= 21,240.00(Non refundable)	1,19,94,085.00	32 Months (INCLUDING MONSOON PERIOD)

(B) **Eligibility: Registered in "AA" Class and Above And Sp cat Building-I.**

- (C) Schedule for e-tendering is fixed as under:
- (i) Site Visit (if any) Bidder should visit before filling the tender.
- (ii) Dowloading of tender documents **From Date As per NiT.**
Start & End Date Upto Date As per NiT .
- (iii) Online submission of bid Upto Date As per NiT.**
- (iv) Submission of EMD, Tender fee Submmision in electronic format only through Online by scanning and then the same should Be sent in original to **EXECUTIVE ENGINEER, BUILDING DEPARTMENT, BHAVNAGAR MUNICIPAL CORPORATION, BHAVNAGAR** **by As per NiT Evaluation done by Submitted hard copy only.**
- (v) Online Opening of Bid on Date As per NiT**
Venue: The City Engineer, in presence of tender Committee Bhavnagar Municipal Corporation, Bhavnagar
- (vi) Bid Validity period **180 Days from the end date of Downloading Bids.**
- Bidders can download the tender documents free of cost from the website www.tender.nprocure.com
 - Bidders have to submit bid in Electronic format on above mentioned website till the date & time shown above.
 - Offers (Financial Bid) in physical form will not be accepted in any case.
Bidders who wish to participate in online tenders will have to procure / should have legally valid Digital Certificate (Class-III) as per information Technology Act-2000 using which they can sign their electronic bids. Bidders can procure the same from any of the license certifying Authority of India or can contract (n) code solution – a division of GNFC Ltd., who are licensed certifying Authority by Govt. of India.
- (D) (i) Bid Inviting authority **EXECUTIVE ENGINEER, BUILDING DEPARTMENT, BHAVNAGAR MUNICIPAL CORPORATION, BHAVNAGAR**
- (ii) Bid Opening Authority The City Engineer, in presence of tender Committee Bhavnagar Municipal Corporation, Bhavnagar
- (E) Mode of Quoting Rates Percentage premium or rebate in words and figures

The list of certifying agencies are as mentionrd under:

<u>Sr. No.</u>	<u>Name of certifying Agency</u>	<u>Website address</u>
1.	(n) Code solution (G.N.F.C)	www.gnvfc.com
2.	Safecrypt	www.safecrypt.com
3.	TCS	www.tcs.-ca.tcs.co.in
4.	MTNL	www.mtnltrustline.com

at the end of Schedule-B

As a result of E-tendering the information / Instructiond on Pages 7 to 13 following may be read as modified below:-

Page - 7: para 5 is deleted and Paras 4, 9 and 12 on these pages are substituted as under.

NOTICE INVITING TENDER:

4. Bid document can be downloaded & Submitted in Electronic Format on web site

www.tender.nprocure.com from **per NiT**

9. The bidder should quote his bid premium or rebate at the end of schedule B. If he do not wish to quote premium or rebate, he should indicate "at par" in the blank space preceding "% above / below" in schedule B. Thereafter he should work out and indicate the offered bid amount both in words and figures in schedule B.

12. The Technical bid will be opened at 16.00 hours on **As per NiT** in the presence of bidderes who may choose to remain present in the office of the Bid opening Authority Specified in bid document.

Page-8 Vf 5FGf p5ZGL ; RGF ZP! GLR[D]HA ; WFZL JFRJL VGF; RGF \$ TYF 5 ZN U6JLP

2.1(i) The Financia; Bids shall be offered in Electronic format only on online website www.tender.nprocure.com till the date and time shown on Page 2 supra.

(ii) **Payment of tender fee and earnest money deposit:** Demand draft for E.M.D. & tender fee shall be submitted in electronic format only through online (by scanning)while uploading the bid.This submission shall mean that E.M.D. & tender fees **in DD format** is received for purpose of opening the bid.Accordingly offer of those shall be opened whose E.M.D.

& tender fees is received electronically.However for the purpose of realization of D.D. bidder shall send the D.D in original to **EXECUTIVE ENGINEER, BUILDING DEPARTMENT,**

BHAVNAGAR MUNICIPAL CORPORATION, BHAVNAGAR by **As per NiT** till 15:00 hours.

Any documents in supporting of tender bid shall be submitted in electronic formate through online (by scanning etc.) & haed copy will be accepted separately.” if tender fee and E.M.D. is not paid as shown in bid document action to hold his registration in abeyance shall be taken and his E-tendering code will be cancelled for one year.(dated 18-1-2008 & 27-11-2008)

page-9 Instructuion 8: words "digitally" be added between "be" and "Initialled"

Instruction 9, 10, 10A and! ZS are deleted

Instruction 11: is renumbered as 9 and subtitled as under: - "9" In addition to the above, the bid will also be liable to be rejected if :-

(i) The bidder proposes any alteration in the work specified or in the time allowed for carrying out the work or any condition or correction made in any code or mode of Schedule-B or Specifications.

(ii) The bidder or the person authorised to sign on behalf of the bidder does not digitally sign the bid offer.

Page-11 The writing in lower part of this page begining with "OR" is deleted and Rules 2 and 4 are modofied as under:-"2" The bidder or the person authorised to sign digitally on bahalf of the bidder shall sign the bid document. The Copy of legal status of bidder (partnership Deed or Articles of Association of the Company) alongwith authority to sign digitally on behalf of the bidder will be frnished alongwith other documents to be despatched physically. "4" The words "at what rate, he is willing to undertake each items of work in second line of this instruction may be substituted to read as at what percentage above or below he is willing to undertake the work"

Page-12 Instruction No. 11 is deleted.

Page-13 Instruction No. 17 is substituted as under.

Signature of the contractor:

Signature of the
**EXECUTIVE ENGINEER,
BUILDING DEPARTMENT,
BHAVNAGAR MUNICIPAL CORPORATION,
BHAVNAGAR**

NOTICE INVITING TENDERS

1. Tenders are inviting on behalf of Governor of state of the Gujarat for work as per page number on of this booklet. The work is estimated to cost of **Rs11,99,40,841.00** this estimate however, is given as a rough guide.
2. **The work are required to be completed within 32 Months(Including monsoon period) as per the terms of the contract conditions.**
3. The contractor whose name is borne of the approved list of contractors of Gujarat State R&B Dept/W.R.D. with **"AA" Class & Above AND Sp Cat Building-I with Roads and Building Deptt. Of Govt. of Gujarat** will be permitted to tender. Not more than one tender shall be submitted by a contractor or by a firm of contractors. No two or more concerns in which an individual is interested as a proprietor and/ or a partner shall tender for the execution of the same work .if they do so, all such tender shall be liable to be rejected.

4. Applications for issue of tender documents shall be submitted to
EXECUTIVE ENGINEER, BUILDING DEPARTMENT, BHAVNAGAR MUNICIPAL CORPORATION,
BHAVNAGAR So as to reach his office not later then DATE as per mentioned time

5. Tender documents consisting of condition, specification, Schedule(s) of quantities of the various classes of work to be done, the conditions of contract etc. will be issued on (date) Dt. **As per NiT**
6. Copies of other drawings and documents pertain to tender and signed for the purpose of identification by the Accepting Officer or his accredited representative will be open for inspection by tender at the following offices during working hours between the dates mentioned in clause 5 above.
 - (a) **EXECUTIVE ENGINEER, BUILDING DEPARTMENT, BHAVNAGAR MUNICIPAL CORPORATION, BHAVNAGAR**
 - (b)
7. Tenderer are advised to visit the site sufficiently in advance of the date fixed for submission of the tender. A tenderer shall be deemed to have full knowledge of all the relevant documents samples, site etc. whether he inspects them or not.
8. Submission of a tender by tenderer implies that he has read this notice and all other contract documents and has made himself aware of the scope and specification of the work to be done and of conditions and rates at which stores, tool and plant etc. will be issued to him, by Government and local conditions and other factors bearing on the execution of the works.
9. A tender should quote in figures as well as in words the rate(s) tendered. The amount for each item should be worked out and the requisite total given. Special care shall be taken to write rates in figures as well as in words and the amount in figures only and in such a way that interpolation is not possible. The total amount shall be written both in figures and in words. In case of figures the words Rs. should be written before the figure of rupees and the words 'paise' after the decimal figure e.g. Rs. 2.15 p. and in case of words the words 'Rupees' should precede and the words 'paise' should be written at the end. Unless the rate is in whole rupees and followed by the word 'only', it should invariably be upto two places of decimal.
10. All rates shall be quoted on the tender form.
11. The tender for the works shall not be witnessed by a contractor or a contractor who himself / themselves has/have tendered or who may and has/have tender for the same works. Failure to observe this condition shall render the tender of the contractor tendering, as well as of those witnessing the tender, liable to rejection.
12. Tender shall be received Registered Post A.D/Courier by **As per NiT** shall be opened on **As per NiT** in the presence of tenders who may be present as per the rule of 4" General Rules and Directions for the Guidance of Contractors" Printed in this form.
13. ~~In the case of contractors who have not furnished standing security, the tender shall have to furnish earnest money. Treasury Challan / Deposit at call Receipt issued in favour of "Managing Director, Tourism Corporation of Gujarat Ltd, Gandhinagar Payable at Gandhinagar" by a scheduled or Nationalized bank . A contractor exempted from depositing earnest money/security in individual case (s) shall attach with the tender an attested copy of the letter exempting him from depositing earnest money/security and shall produce the original when called upon to do so.~~
14. A tender shall submit the tender which satisfied each and every condition laid down in this notice and tender documents, failing which the tender will be liable to be rejected.
15. The Governor of the State of Gujarat/ **The Commissioner, Bhavnagar Municipal Corporation, Bhavnagar** does not bind himself to accept the lowest or any tender or to give any reasons for the decision.
16. This notice of tender shall form part of the contract documents For and behalf of Governor for the state of Gujarat/ **The Commissioner, Bhavnagar Municipal Corporation, Bhavnagar**
17. **The Commissioner, Bhavnagar Municipal Corporation, Bhavnagar, reserves the rights to reject any or all tenders without assigning any reason thereof.**

Date:

Signature.....
Designation.....

FORM - B 1 / OMD" v B !

**EXECUTIVE ENGINEER, BUILDING DEPARTMENT, BHAVNAGAR
MUNICIPAL CORPORATION,
BHAVNAGAR**

PERCENTAGE TENDER AND CONTRACT FOR WORKS

SFDM DF8[G] 8SFJFZL v NZJF/ 8gOZ VG[SM8FS8

ADDITIONAL INSTUCTIONS TO PERSONS TENDERING 8gOZ EZGFZG[JWFZFL ; JRGFVM

1. **Competency of Tender** – No contract will be awarded except to responsible bidders capable of performing the class of works contemplated. Before the award of the contract, any bidder may be required to show that he has the necessary facilities, experience, ability and financial resources to perform the work in satisfactory manner within in the time stipulated. Contractor may be required to furnish the department with the statement as to their experience and their financial status.
2. Tender will be deemed to have inspected the site and to have satisfied as to the nature of all works, all existing roads, water-way and other means of communication and access to and from the site and work and the building that may be required for temporary purpose in connection with the construction, completion and maintenance of the works and must make his own inquiries as to work, yard sites and depot, and dumps and as to acquisition of such additional sites and areas as may be necessary for temporary purpose for constructing, completing and maintaining the works.
- 2.1 The tenders shall be received only under “**Registered Post**” ‘or’ by Express Delivery should be adopted under any circumstances
 I : Late tenders (i.e. tender received after the specified time of opening), delayed tenders (i.e. tenders received before the time of opening but after due date and time of receipt of tenders) and post tenders offers shall not be opened and considered at all.
 II : The tenders received after time & the date specified in the tender notice shall not be received by the concerned office,
 III : Necessary records should be maintained for refusal of such tenders in the registers for receiving tenders and should be initialed by the concerned Engineer.
- 3 **Payment:-** The tender must understand clearly that the rates quoted are for completed works and include all costs due to labour, scaffolding plant, supervision, service works, power, royalties and octroi etc. , and to include all extras to cover the cost of night work if and when required and no claim for additional payment beyond the price/rates quoted will be entertained and the tenderer will not be entitled subsequently to make any claim on the ground of misrepresentation or on the ground that he was supplied with information given by any person (whether the member is the employee of Public Works Department or not) . Any failure on his part to obtain all necessary information for the purpose of making his tender and filling the several prices and rates therein shall not relieve him from any risks or liabilities arising out. Of or consequent upon the submission of the tender.
4. **Tender Forms** – Every ‘blank’ in the form of the tender and in the schedule must be filled up by the tenderer and must return the document sent herewith.
5. Erasures- Person tendering are informed that no erasures or alterations by them in the text of the document sent herewith will be allowed and any such erasures or alternations will be disregarded.If there is any error in hiswriting,no overwriting should be done,the wrong word or a figure should be struck out and the correct one written above or near it in unambiguous way.Each correction should be initialed.

Contractors to please read this Carefully: SM8FS8ZIM[GLRGL AFATMSF/HL 5JJS JFRJF IJGTL KP

1. The percentage in Schedule ‘B’ must be given in words and figures. Amount thus worked out must also be entered in column and grand total of amount must be struck out by the tenderer.
 1P JW[S]VMKFLG 8SFJFZLGF NZ XaNM TDPH VFSOFDF VF5JFP 8gOZ EZGFZG[VF ZLT[AGTL ZSD 56 BFGFDAGMVL VG[ZSDGM[S] ; ZJF/MDSJMP
2. If the tender is taken in favour of the company, a power of attorney in favour of the person who may have signed the tender for the company must accompany the tender.
 ZP SM. S5GLG[GFD[8gOZ , JFDVVFj I]CMI TM S5GL JTL 8gOZ 5Z ; CLSZGF j I ISTG[VIWST SZT]DBt I FZGFD]8gOZ ; FY[ZH] SZJFGZCXP
3. ~~Solvency certificate of a Bank of an amount up to 20% of the tendered cost plus the amount of works on hand still to be executed will have to be produced by the contractor.~~
 #P 8gOZDA EZL S] BR" Jttf AFSL CMI TjF CFY WZL A5FDGL ZSDGF Z_ 8SF HB, I ZSD VU[ABC]5DF65+ SM8FS8ZLZH] SZJFGZCXP
4. ~~Challan for earnest money @ 1% of the estimated cost must accompany the tender. Tenderer may pay earnest money up to Rs.50,000 in cash or in the form of Crossed Demand Draft or fixed deposit of~~

~~fixed deposit at call receipts with a validity period of not less than six months of Nationalised or Scheduled or Co-operative Bank having 5 year standing drawn in favour of Managing Director, Tourism Corporation Executive Engineer/Divisional Officer concerned. Earnest money by cheque & Bank Guarantee shall not be accepted. vide R & BD G.R. No. TNC/1090/(100) (4) C dated 4-11-2000) However in respect of the works estimated to cost above Rs. laacs, the amount of earnest money in excess of Rs..... can be offered by the contractor, at his choice, in the form of Bank Guarantee of the Scheduled Bank or Nationalised Bank only. The Bank Guarantee in such cases will be furnished in the following form. In such cases also, the amount of earnest money first Rs.50,000 will paid only in the form of cash or crossed demand drafts or fixed deposit receipts or deposit at call receipts worth the validity period of not less than 6 months of the nationalised or Scheduled or Co-operative Banks having five years standing.~~

If the contractor do not turn up to pay the Security Deposit and execute contract agreement within specified (or extended) time after intimation to him about acceptance of this offer, the earnest money paid for this work will be forfeited and according to clause -1 of this tender form tenderer's tender shall be rejected and then according to aforesaid provision of tender, action to blacklist the contractor will be initiated without Delay.

5. The contractor shall have to furnish Income Tax Clearance Certificate before his tender is accepted and intimate assessment number and ward under which he is assessed.

5P 5MTFG) 8g0Z : JLSFZ I T] 5C] F Sltg8S8Z] VFJSJZ] RST] SI FG] 5DF65+ ZH] SZJ] 50X] VG] VFSFZ6L GAZ VG] H] C9/ VFSFZ6L SZF. CMI T] JF] VUJG] HF6 SZJFGL ZCXP

6. Copies of certificate as regards previous experience, if any, must accompany the tender.

&P VUFpGM SM. VG] EJ CMI TM T] VUJG] 5DF65+ GL GS, M 8g0ZM; FY[ZH] SZJFGL ZCXP

7. Declaration showing all works on hand with the Contractor and the value of works that remains to be executed in each case must accompany the tender.

*P NZS S] DASltg8S8ZGF CFY 5ZGF AWF SFD VG] SZJFGL AFSL CMI T] JF SFDGF D] I VUJGM VFSZF 8g0Z ; FY[SZJFGM ZCXP

8. All pages of Schedule 'A' and 'B' and specifications should be initialed by the Contractor.

(P VG]]R cSc VG] cBc GF TDFD 5FG VG] IJUTM 5Z Sltg8S8Z] 8] S] ; CL SZJLP

9. All corrections, erasures and overwriting should be initialed by the Contractor.

)P TDFD ;]WFZ4 K]KFS VG] W]B] , F , BF6 5Z Sltg8S8Z] 8] S] ; CL SZJLP

10 Discrepancies and adjustment of Errors : S ; Z VU] IJ ; UIT VG] IC ; FA HMU 0

Any error in quantity or amount in Schedule 'B' showing items of works to be carried out shall be adjusted in accordance with the following rules.

CFY WZJFG SFD]GL AFAT NX]JTL VG]]R cBc DFGF HyYF VYJF ZSDGL SM. 56 E] , R] GLRGF IGI DM VG] FZ ; ZEZ SZJFDFVFXP

a) In the event of a discrepancy between description in words and figures quoted by a tenderer in the rates column, the description in words shall prevail.

sSf 8g0Z EZGFZ] NZGF BFGFDFV H6FJ] , XaNMI VG] VFSOF J]R] SM. V ; UITGF S] DFXaNMIDFAH6FJ] , ZSD Dfg] ZFBJFDFVFXP

b) In the event of an error occurring in the 'amount' coloumn of the Schedule 'B' showing items Of work, as a result of wrong multiplication of the unit rate and quantity; the unit rate shall be regarded as firm and multiplication shall be amended on the basis of the rate.

sBf V]SD NZ VG] HyYFGF B]BF U]B]FSZGF SFZ6] SFDGL AFATM NX]JTL VH] ;]R ccBcc GF BFGFDFYL ZSDDFV E] , H6F] TM V]SD NZ Dfg] ZFBJFDFVFX] VG] NZGF V]WFZ] U]B]FSZ ;]WFZJFDFVFXP

c) All errors in totalling in 'amount' column in carrying forward totals shall be corrected.

sUF ZSDGF BFGFDFYL TDH VFU/ BRTF ; ZJF/ FGL TDFD E] , M ;]WFZJFDFVFXP

d) Any rounding of amount against "items" or in "totals" shall be ignored.

sWf ccAFATMcc VYJF cc ; ZJF/ Fcc ; FD] 5Z] VFSO] SZ] , SM. 56 AFAT w] FGDA ,]JFDFVFX] GCLP

The tendered sum so altered shall for the purpose of the tender be substituted for the sum originally tendered and considered for acceptance.

8g0Z Df8] 8g0ZDFANX]FJ] , ZSDDFV SZJFDFVFX] , VF 5]SFZGF QZOFZ 8g0ZDFV E] , ZSDG] AN ,]D] S] : JLS]TL Df8]]JRFZJFDFVFXP

10. i) It may please be noted that the tender will be considered as invalid, especially, if the requirements as per instruction No.1 to 10 above are not complied with before submitting the tender. Also please read carefully the face sheet and 'General Rules and Directions for the guidance of contractor's of this form.

! _P] P 8g0Z ZH] SZTF 5C] F BF ; SZLG] p5ZGL ; RTF G] ! YL ! _ DFG] H-ZL] FTMG] 5F , G SZJFDFVFX]]GCL CMI TM 8g0Z VDFg] U6JFDFVFX] T]GL G]W ,]F]JGTL K] J/L VF OMDG] DJB 5Q8 VG] Sltg8S8ZGF DFUNXG Df8] ; FDFg] IGI DM VG] ; RGFV] 56 SF/HL5]]S JFRJF]JGTL K]P

10. ii) Right is reserved to reject any or all tender(s) without assigning any reason (s) therefore.

! _P] ZP SM. 56 SFZ6 NX]F]]F] ; JF] SM. 56 S]AWF 8g0ZMV : JLSFZ SZJFGM CS VAFIWT ZC] K]P

10-A The tender documents shall have to be filled in.

11. In addition to the above, the tender will also be liable to be rejected outright if
- The tenderer proposes any alteration in the work specified or in the time allowed for carrying out the work or any condition or correction made in any code or mode or Schedule 'B' or specifications.
 - Any of the page of the tender is/ are removed or replaced
 - All corrections, additions or pasted slips are not initialed by the tenderer.
 - Any erasure is made by him in the tender and.
 - The tenderer or in the case of a firm, each partner or the person holding the power of attorney thereof does not sign or signature is /are not attested by a witness on page, 15 of the tender in the space provided for the purpose.

12. A certificate of registration as approved contractor should be attached with tender.

! f
p5ZGL AFATM p5ZFT 8p0Z GLRf; HUMDATZT VDFgl 9ZJFG[5F+ YXP
i) The tenderer proposes any alteration in the work specified or in the time allowed for carrying out the work or any condition or correction made in any code or mode or Schedule 'B' or specifications.
! f 8p0Z EZGFZ4 IGI T SFD VYJF SFD DF8[DHZ SZ, VYJF VG; JR B GF SM. SMO VYJF 5wWIT VYJF IJUTMDADSI, XZT VYJF ; WZFDFASM. OZOFZ ; RJTF CMI P
ii) Any of the page of the tender is/ are removed or replaced
Zf 8p0ZG[SM. 5FG[S]5FGF SF-L GfbI]q GfbI F CMI S[AN<1]q AN<1 F CMI
iii) All corrections, additions or pasted slips are not initialed by the tenderer.
#f AWF ; WZF WZF VYJF RIBFO, L SF5, LVM p5Z 8p0Z EZGFZ[8]S; CL G SZL CMI
iv) Any erasure is made by him in the tender and.
\$f 8p0ZDATD6[SM. KSKFS SZL CMI 4 VG
v) The tenderer or in the case of a firm, each partner or the person holding the power of attorney thereof does not sign or signature is /are not attested by a witness on page, 15 of the tender in the space provided for the purpose.
5f 8p0Z EZGFZ VYJF 5f-LGL AFATDANZS EFULNFZ VYJF T[VUG]DBtI FZGFD]WZFJGFZ jI IST ; CL G SZ[VYJF 8p0ZGF 5FGF ! 5 p5Z T[DF8]ZFBJFDFAVFJ, L HuI FDA; CL q ; CLVM p5Z SM. ; F1RLV[; FB SZL G CMI P

GFW6L JU"	DHZ NZ[SB, L ISDTG]SFD OF/JFX	GFW6L JU"	DHZ NZ[SB, L ISDTG]SFD OF/JFX
V	-FP ; FT , FB ; WL	S	-FP A[, FB ; WL
A	-FP RFZ , FB ; WL	0	-FP ; F. 9 CHEZ ; WL

s! f
DHZ SZ, ISDTGL DFICTL ; ICT CFY 5ZGF AFWSDFGL I FNLP
SX/ DHZ ; CSFZL DO/LG[SFI]F+ ; DUJH<, FDAZCX
HI FZ[; 1FD DHZ ; CSFZL DO/L TF, SF S[IH<, FDFSD[ZFBJF VFU/ G VFJ]TJF IS: ; FDFSD prR JULSZ6 WZFJTL
HL<, FGL DHZ ; CSFZL DO/LG[SFD VF5L XSXP
p5ZGL ; 3/L AFATM p5ZFT WZF DFUGF S[1] J AS ; CFI T SFDG[, FU]50X[GICP p5ZFT H[SFD]DFZ5 8SFYL VFKF
DHZLG[IC ;]CFI TJF SFD[DO/LVFG]KBF8GF WZF6[VF5JFDFAVFJX[GICP
VF p5ZFT GLR[D]HA SFD OF/JJF 5F+ TF U6FXP

p5I ST ISDT ; AWL DI FNf ; DUJSDGL DHZ YI, ISDT VUGL KP H[SFDGF EFU, F 5FOJFDFAVF]I F CFI tI FZ[, FU]50TL GYLP CFY 5ZGF ; 3/F SFDG[DHZ YI, ISDT TYF LJRZ6F CP/GF SFDGL ISDT ; ICT SFDG[S], ISDT4 ; CSFZL DO/L H[JUDAZHL: 8Z Y. CFI TGL GF6SLI DI FNFL + 6 U6L ZSD SZTR JWTL G CFI TH ; CSFZL DO/L JRFZ6F CP/G]SFD DJ/JJF CSSNFZ YXP
VF p5ZFT GLR[D]HAGABF ; 5SFZGATDH JWDf, ; FD ; G J5ZFT[CFI T]5SFZGFALR[H6FJ], SFD[56 DHZ ; CSFZL DO/LG[VF5JF5F+ GYLP
! f
Zf
#f
\$f
5f
&f

DF, ; FDFG JCG VUGFP
5FTE/SJF XFZSD VUGF
pt5FINT DF, ; FDFG S[Vg] DF, ; FDFGGL BZINL S]5ZF 5FOJF AFATP
5f 8 Sg8f, 4 JFBZ 5DU TYF S, Z SFD[HJF BF ; 5SFZGASDFP
CFBDLTF %, Fg8 Vg]5JZ OLGLXZGASDF[
U], 4 V[IF5L], 4 X8 ; 4 AFZVF[GAU, F ; 5G, 4 R[GCLh4 Afa0]JFI Z 0g; LU TDH VF 5SFZGAVgI SFD[H]DRA] 5DF6DA DF, ; FDFG J5ZFT[CFI] P
sVFWFZ HFCZ AFWSD IGUD ; U[C EFUV! GFOSZ[Z_ \$ TYF DF2DP IHP GATEZLBv !)v&v() TYF #vZvZ____ TYF TTP Z_v*vZ____Z GF 9ZFJFP

Tender documents for work as specified on Page no, -1 of this Booklet

DECLARATION FORM V[SZFZG]OMD"

- I/We hereby declare that I/We have visited the site and fully acquainted myself/ourselves with the local situations regarding materials, labour and other factors pertaining to the work before submitting this tender.
! P
C]q VD[VFYL V\$ZFZ S~ K]q SZLV[KLV[S]VF 8p0Z ZH]SZTR5C], F DP q VD[: Y/GL D], FSFT , LWL K]VG[SFDG], UTF DF, ; FDFG4 DHZ VG[ALW AFATMG], UTL : YFIGS 5IZI: YTLGL HFTvDFCLTL D]/JL KP
- I/We hereby declare that I/We have carefully studied the conditions of contract, specifications and other documents of this work and agree for execute the same accordingly.
ZP
C]q VD[VFYL V\$ZFZ S~ K]q SZLV[KLV[S]VF SBFS8ZGL XZTMGL IJUTMVG[8p0ZG], UTF N: TFJHMSF/05]JS VelF; SIMK[VG[T]DHA TGMVD, SZJF ; DT K]q KLVp
- We have to receive payments, if delay is due to late receipt of grant-in-aid from Government for oanchayat works.(Applicable to panchayat works only)

DECLARATION CERTIFICATE (G.R. date 4-2-89 as revised by GR. No.TNC – 1083/6681/4/C, dated 31-8-1994)

(iv) I/We hereby declare that my/our near relative are not working in this Division or in its sub-division as an Ex.Engineer, Deputy Executive Engineer, Assistant Engineer, Additional Assistant Engineer, overseer, Divisional Accountant , Store, Keeper, or as incumbunt in BHAVNAGAR MUNICIPAL CORPORATION at today.

\$P C]q VD[VVYL V\$ZfZ S- K]q SZLV[KLV[S]DFZfQ VDFZF GHLSGF ; UF VF IJEFULI SRZLDATPH T]C9/GL 58F IJEFULI SRZLVMDASFI 5F, S . HGZ4 GF1 A SFI 5F, S . HGZ4 DNNGLX . HGZ4 VIWS DNNGLX . HGZ4 . HGZ4 VIUZ; LI Z4 IJEFULI IC; FAGLX : 8MZSL5Z4 VgI 5NFIWSFZL TZLS[CF, 8gOZ EZJFGL TFZLB]SFD SZTF GYL4 S]C]M]M WZFJTF GYIP

General Rules and Directions for the Guidance of Contractors

SMg8FS8ZMGF DFUNXG DF8[; FDFgI IGI DM VGI;]RGFVM

1. All works proposed to be executed by the contractor shall be notified in a form of invitation to tender pasted on a board hung up in the office of the Managing Director and signed by the Managing Director.

! P SMg8FS8Z wJFZF SZJF IJRZF], TDFD SFDGL HFCZFT SFI 5F, S . HGZGL SRZLDA, 8SFI, AMO 5Z RIBFO, SFI 5F, S . HGZGL ; CLJF/F 8gOZ DUFJTF OMD wJFZF SZJFDFVFXP

This form will state work to be carried out as well as the date of submitting and opening tenders and the time allowed for carrying out the work, also the amount of earnest money to be deposited with the tender and the amount of the security deposit to be paid by the successful tenderer and percentage, if any, to be deducted from bill. It will also state whether a refund of quarry fees, royalties, octroi dues and ground rents will be granted. Copies of the specifications, designs and drawing and estimated rates, and any other documents, required in connection with work which shall be signed by the Engineer for the purpose of identification shall also be open for inspection by Contractor at the office of the Engineer during office hours.

CY WZJFGF SFDGL TPDH 8gOZ DMS, JFGL VG]BM, JFGL TFZLBM VG]SFDM 5Z]SZJF DF8[VF5JFDFVFXJTL DNTGL HF6 OFDDA SZFXP J/L 8gOZ ; FY]VGFDT D]JFDFAFGFL ZSD VG]HG] 8gOZ :JLSZF1 T]6]HFDLG VGFDT 58]D]JFGL ZSD VG] IA, MDPYL 55FT SZJFGL SM. 8SFJZL CMI TM T]56 NXF]JFDFVFXJP J/L 5yYZGL BF6 VU]GL OL4 ZMI <8L4 VMS8MI GL , 6L ZSD VG]HDLGvEFOFGL ZSD ZL00 D/X]S]SD T]56 T]DFAH6FJFDFVFXJP IJUTM IOhf. GM OM. U VG]VMNFHL NZ4 VG]JR NZ VG]SFD VU]H-Z CMI V]UF HG]F p5Z VM/B DF]SFI 5F, S . HGZ ; CL SZX[V]UF SM. N: TFJHML GS, M SRZLGF ; D1 NZIDI FG SFI 5F, S . HGZGL SRZLV]SMg8FS8ZMG]HM. HJF DF8[ZFB]JFDFVFXJP

Where the works are proposed to be executed according to the specifications recommended by a contractor and approved by a competent authority on behalf of the Governor of Gujarat, such specifications with designs and drawing shall form part of the accepted tender.

SMg8FS8Z[E, FD6 SIFDHA GF VG]U]HZFTGF VFJL ZFH1 5F, JTL ; tTF VIWSFZLV]DHZ SZ], IJUT D]HA SFD CFY WZJFG] IJRFI]CMI t]R10hf. GM VG]OM. U ; ICTGL VFJL IJUTM :JLST 8gOZGM EFU AGL ZCXp

2. In the event of tender being submitted by a firm. It must be signed separated by each partner thereof or in event of the absence of any partner it shall be signed on his behalf by person holding a power of attorney authorising him to do so. Details of partner will be furnished in Annexure-I along with the copy of partnership.

ZP SM. V\$ 5[-L TZOYL 8gOZ ZH[YI]CMI t]FZ]TGF EFULNFZ[V, U ZIT] ; CL SZJL VYJF EFULNFZ UZCFHZ CMI t]FZ]TGF JTL TGF 5Z ; CL SZJF VIWST SZT]D]B]t]FZGFD] WZFJTL SM. 56 j]ISTV]TGF 5Z ; CL SZJFGL ZCXp EFULNFZML IJUT 5IZIX08v! DAFULNFZL BTGL GS, ; FY]VF5JFGL ZCXp

3. Receipts for payment made on account of any work, when executed by a firm , shall also be signed by all the partners except where the Contractors are described in their tender as a firm in which case the receipts shall be signed in the name of the firm by one of the partners or by some other person having authority to give effectual receipts for the firm.

#P SM. 5[-LV]SFD SZL V%]CMI t]FZ]T]SFD SZFI, R]S]J6LGL 5CMRM 5Z 56 AWFH EFULNFZ[V] ; CL SZJFGL ZCXp 5ZT]H] 8gOZDAS]Mg8FS8ZMG]V\$ 5[-L TZLS[NXF]I]F CMI t]FZ]V]5[-L JTL VGF SM. EFULNFZ]S]5[-L JTL 5FSL 5CMR VF5JFG]VIWST V]JL ALH]0 SM. 56 j]ISTV]5CMRM 5Z ; CL SZJFGL ZCXp

4. The bidder should quote his bid premium or rebate at the end of Schedule B. If he do not wish to quote premium or rebate, he should Indicate "at par" in the blank space preceding "% above/below" in Schedule B. Thereafter he should work out and indicate the offered bid amount both in words and figures in Schedule B.

5P 8gOZ BM, TL JBT]OST 8gOZ EZGFZ . HFZNFZM VYJF TDPGF VIWST 5]TIGIWM]G]H CFHZ ZC]F N]JFDFVFXJP T]I ; JFI GF VgI SM. . HFZNFZMG]CFHZ ZC]F N]JFDFVFX]GICP

HM 8gOZ EZGFZ V\$ 56 . HFZNFZ S]TDPGF VIWST 5]TIGIWM]CFHZ G CMI TM 8gOZ BM, GFZ VIWSFZL p5ZAT VMKFDV]MKF V\$ JW]VIWSFZL S] ; A]WT ; ZSFZL SRZLGA ; LGL Z VIWSFZLGL CFHZLDA 8gOZ BM, JFDFVFXJP VFJF 5] ; U]8gOZ G E I]CMI T]JF VgI . HFZNFZ S]T]M]MG] 5]TIGIWM]G]CFHZ ZC]F N]JFDFVFX]GICP s5ZL5+ SDF8 8LVG; Lv!)#v\$; 4 TP &q *q) #FP

8j0Z BM, GFZ VVWSFZL HJNFHJNF 8j0ZMGL ZSD I MUI OMDGF TJ, GFtDS 5+SDRGMVXP 8j0Z : JLSFZTF Sltj8FS8ZT TGL VM/B ; FY|VF 8j0ZDFA H6FJ, L IJUTM VGI ALHF N:TFJHML GS, M p5Z : CL SZJFGL ZCXP 8j0Z : JLSFZJFDAG VFJ|t|fz|8j0Z EZGFZ Sltj8FS8Z GF6A5ZT D?I FGL 5CIR VF5|V|B, |VD6|EZ|, L AFGGL ZSD TDG|I Z00 SZJF JEFULI VVWSFZL ; AIWT ITHMZL VVWSFZL|V|WST SZXP

6. The officer competent to dispose off the tenders shall have the right of rejecting all or any of the tenders.
&P 8j0ZMGL GSF, SZJFGL ; tTF WZFJTF VVWSFZL GAWAVYJF SIM. 56 8j0ZGM V: JLSFZ SZJFGM VVWSFZ ZCXP

7. ~~No receipt for any payment alleged to have been made by a Contractor in regard to any matter relating to this tender or the contract shall be valid and binding on Government unless it is signed by the Executive Engineer.~~

*P ~~VF 8j0Z S| Sltj8FS8ZG|, UTL SIM. 56 AFAT Sltj8FS8Z SZ| L SCUFYL SIM. R5 J6 LGM 5CMR 5Z SF1 5F, S. HGZGL : CLG CIM TIT|5CMR SF1NF Z VGI: ZSFZ AWG ZCXP|GICP~~

8. ~~The memorandum of the work to be tendered for and the schedule of materials to be supplied by Public Works Department and there rates shall be filled in and completed by the office of the Executive Engineer before the tender form is issued. If a form issued to an intending tenderer has not been so filled in and completed, he shall request the said officer to have it done before he completes and delivers his tender.~~

(P ~~8j0ZG|OMD* VF5TA5C| F SF1 5F, S. HGZGL SRZL|G|H| SFDG 8j0Z DFUJFDA VFJ|T|SFDML I M L AWFSD IJEFU|5Z| 5F0JGF DF, ; FDFGGL~~

~~V|G|JR V|G|TGF NZ 8FS|G|T|OMD* 56*56|E ZL VF5JFG|ZCXP 8j0Z EZJF DRUT SIM. Sltj8FS8ZG|VF5H| |VFJ|OMD* 5DF6|; 56*56| E|G|CIM TIT|5M|T|G|8j0Z 5Z|5| E ZL|G|; M5| T|5C| F p5Z D|H A SZL VF5JFGL TD6|pST SRZL|G|JGTL SZJFGL ZCXP~~

9. Under no circumstances shall any Contractor be entitled to claim enhanced rate for any items in this contract.

)P SIM. 56 ; H|UMDA VF Sltj8FS8DFGL SIM. 56 AFAT|DF8|SIM. Sltj8FS8ZG|JW|EFJ DFUJFGM CSS ZCXP|GICP

10. All corrections and additions or pasted slips should be initialed.

!_P TDFD ; JWFZ|JWFZ|S|RMBFQ| L SF5, LVIM 5Z 85L ; CL SZJFGL ZCXP

11. The measurements of work will be taken according to the usual method in use in the Public Works Department or as specified in technical specification and no proposals to adopt alternative methods will be accepted. The Zonal Engineer's decision as to what is the usual method in use in the Public Works Department will be final.

!!P SFDGF DF5 AWFSD IJEFU|GL ZFA|TF D|HAGL 5WWT|L VYJF 85GLS, ; 5| LOLSXGDR NX|F|F V|G| FZ , |JFDA VFJX| V|G|J5|5S 5WWT|VM V5GFJF VU|SIM. 56 NZBF: T : JLSFZ|G|CL S. 5WWT| AWFSD IJEFU|GL ZFA|TF D|HATL K|T|VU|GF SF1 5F, S. HGZGM IG61 VFBZL U6FXP

12. The Insurance Company's bond will not be accepted against the security deposit.

! ZP J|DA|S5G|G|BT HFDLG VGFDT ; FD|: JLSFZJFDA VFJX|G|CLP

13. In the event of any other of discrepancy in write upto tender documents the contractor will not take any undue advantage of such error or discrepancy and Engineer In Charge shall have power to interpret and decide correct meaning of contradictory erraneous writting..

14. The Contractor will have to construct a shed for storing controlled and valuable materials issued to him under schedule 'A' of the agreement at work-site having double locking arrangement. The materials will then be taken for use in the presence of the Department person. No materials will be allowed to be removed from the site of work.

! \$P SZFZGL V|G|JR S CP/ Sltj8FS8ZG| VF5JFDA VFJ|, IGI 46 V|G| ISDTL DF, ; FDFG SFDGF : Y|/| ZFBJF DF8| TD6| AJUOF TF/FTL j|J: YFJF/L V5 KF5ZL ANWJFGL ZCXP T|5KL IJEFU|GL SIM. j|ISTGL CFHZLDR p5| MUDA, |J DF, ; FDFG TDFYL ACZ SF-JFGM ZCXP SFDGF : Y|Y| SIM. 56 DF, ; FDFG B; |JF N|JFX|G|CLP

15. No foreign exchange will be released by the Department for the purpose of plant and machinery required for the execution of the work contracted for.

! 5P H|G|DF8|Sltj8FS8 V5F|M|CIM T|SFD SZJF DF8|H-ZL %, F8 V|G|I 4 ; FDU| DF8|HFCZ AWFSD IJEFU SIM. H IJNXL C|O|FD6 K|B|SZX|G|CLP

16. Controlled materials (Essentiality Certificate)

! *P IGI 46 DF, ; FDFG sVFJx| S 5DF65+f

(i) As regard controlled materials, the Public Works Department will help to arrange for the permit as far as possible and help the Contractor in securing the same. All incidental charges met with in procuring these materials shall be borne by the Contractor himself. Though the Public Works Department will help to arrange for the permit as far as possible and help the Contractor in obtaining the materials, it shall not accept any responsibility for any loss on account of delay caused to the Contractor while obtaining the same.

! f IGI 4+T DF, ; FDFG 5ZT|AWFSD IJEFU XS| T8, L ZLT|5ZD|8 DF8GL j|J: YFDADNN SZX|V|G|T|; |GI| JT SZJFDA Sltj8FS8ZG|DNN SZXP VF DF, ; FDFG D|J|JFDA Y|I| TDFD V|G|JF|FUS BR* Sltj8FS8Z 5M|T|E M|U|J|X|P AWFSD IJEFU 5ZD|8 D|J|JF AG|T8, L DNN SZX|V|G|DF, ; FDFG D|J|JF Sltj8FS8ZG|DNN SZXP T|KTA Sltj8FS8ZG|T|D|J|JFDA SIM. IJ, A YJFG|, L|W| SIM. IJ, A S|G5XF|G DF8|HFCZ AWFSD IJEFU HJFANFZ, |BFX|G|CLP

(ii) The contractor shall submit to the concerned or Zonal Engineer on close of every calendar month the monthly returns in the prescribed forms as to the receipts and actual use of the controlled materials during the month.

Zf NZS VU|H| DCLG|G| V|S Sltj8FS8Z| DCLG| NZD|FG IGI 4+T DF, ; FDFGVL VFJS V|G|BZBZ J5Z|X VU|IGI T OMD* D|HAGF DF; IS IGI T5+SM SF1 5F, S. HGZG|DMS, JFGF ZCXP

(iii) The contractor shall permit concerned or Executivel Engineer or his representative to inspect the stock of the controlled materials stored by him at any time whenever the Executive Engineer or his representative so desire (s).

#f SF1 5F, S. HGZ VYJF TG|5|TIGI WVM|H|FZ|. rK|T|FZ|Sltj8FS8Z|TD6|; U|CL ZFB|, M IGI 4+T DF, ; FDFGGM: 8MS SIM. 56 JBT| T5F; JFDA N|JFGM ZCXP

17. The tender for the work shall remain open for period (120*) days from the actual date of down loading of the price bids for this work and that the tenderer shall not be allowed to withdraw or modify the offer on his own after downloading of price bid. If any tenderer withdraws or make any modifications or additions in the terms and conditions of his tender not acceptable to the Government (Public Works Department/BMC) then the Government shall without prejudice to any

right remedy. Be at liberty to forfeit in full the said earnest money absolutely, in this connection G.R. R & BD NO. TNC – IIB – 22 (10) – C , dated 24-5-90 should be referred to.

! *P

Vf SFD Df8G|8g0Z . v8g0ZLU YL ZJfGf SZJfDf VJf|tlfZ AfN 8g0Z Gf 5f. ; ALO BmI fGL TtZLBYL sf INJ ; Df8|Bk, |ZC|X|Vg|Vf DNT NZIDI fG Vf 8g0Z EZGfZg| Vf VMOZ : JfKfV|5fKL BRl , |Jf S|TDAfOZOFZ SZJf NjFDA VfJX|GfCP Vf ; Df 5C| f Hm 8g0Z EZGfZ T6|EZ| f 8g0ZGL XZTm Vg|Am, LGM 5fKL BRl, |VYfJ TDA; |WfZVfM; |WfZVfM pDZm| pDZfVfM SZ|H| ; ZSFZ SHfCZFT AfWfSD LJEfUF G|: JLSf1" G Cml 4 Tm CSS S|. , fhGf 5JUJC JUZ ; NZ C|AfGfGL 5ZL ZSD HmT SZJfGL ; ZSFZG|; 5j6*: JT+Tf ZC|Xp Vf Df8| \$v5v) _GM DfPDP LJEfUGm 9ZFJ Gr 8LPVGP; lPvf. vVf. vAlvZ_s! _fSP HJMfP

18.

This condition shall apply only when the work is awarded to labour cooperative society.(1)if the members of labour Co-operative Societies do not work themselves and obtain commission by subletting the work as a whole or by dividing work in group and give work in group and give work to piece workers,the very purpose of the scheme would be defected.Therefore the labour Co-operative society will not sublet the work and the work will be executed by the members labourers of the society.

(2)In case where the works required to be carried out by the labourers other than the members of the labours Co-operative societies with the man days more than25%,prior permission of the executive engineer will be necessary.

(3)The labourco-operative societies shall have to allow the officers of the c0-operation department to examine for audit purpose the muster rolls as and when required.

(4)The labour Co-operative societies shall have to submit a quarterly return staing the monthly attendance of man days on the muster rolls of member labourers on each work to the district registrar as well as executive engineer.

(5)If the labour co-operative society is found violating the terms and conditions mentioned above the labour co-operative society will be liable for the cancellation of work contact and or registration as decided by the executive engineer.(vide GM No. LCS-1081/(8)-H,dated 4-6-1986).

!)

Z: TtH 5|, |m DSfGmGf SFDGM JSV VMOZ . x|j|Yf f 5KL TjH SfdGf : Y/(SZJfGf SFDGf : 5| LOLSXG VUg| Am S|8fS8Z| 5mTFGf BR| D5JfG|ZC|Xp

~~! P SFDG|GfD ov s SFDGM 5fZ f &P ; 5ZJf. hZL : 8fGf GfD ov
ZP LJEfUG|GfD ov *P SFD X - SZJfGL TtZLB ov
#P 5fP LJEfUG|GfD ov (P SFD 5| - SZJfGL TtZLB ov
\$P 8g0ZGL ZSD ov)P SFDGf : 5XLOLSXG ov~~

5P - HfZNFZZL|GfD ov
Z: TtGf Sfdm

v _____ Df8L SfdG| HfOf. PpPpPpPpPpPpPpPp : PdLp _____ v DB, Gf 5YD : TZGL HfOf. PpPpPpPp ; PdLp
v _____ OFDZGL : 5f8L G|SfD PpPpPpPpPpPpPpPp ; PdLp _____ v DB, Gf ALHf : TZGL HfOf. PpPpPpPp ; PdLp

– s PpPpPpPpPpPpPpPpS5RL4 PpPpPpPpPpPpPpPpPp Uj8 Vg|(PpPpPpPpPpPpPpPpPpPp OfDZ Jf5ZJfGf f

v OFDZGL ; L, LU ; ZOf G|SfD PpPpPpPpPpPpPpPp : PdLp
– s PpPpPpPpPpPpPpPpPp S5RL4 PpPpPpPpPpPpPpPpPp Uj8 Vg|(PpPpPpPpPpPpPpPpPpPp OfDZ Jf5ZJfGf f

5|, Gf Sfdm
v 5|, Gf PpPpPpPpPpPpPpPpPp, Vf. Gf PpPpPpPpPpPpPpPpPp UF/f _____ v 5|, Gf 5fH Gf S|8G|5Df6 PpPpPpPpPp s; LDg84 S5RL4 ZTL f

v 5|, Gf VtE, hV(A8Dg8Gf S|8G|5Df6 PpPpPpPpPpPp s; LDg84 S5RL4 ZTL f v ; 5Z : 8SRZGf S|8G|5Df6 PpPpPp s; LDg84 S5RL4 ZTL f

v Vg| lX|f HmUJf.

– DSfGf Sfdm
v 5fH fGf S|8G|5Df6 PpPpPpPpPpPpPpPpPp s; LDg84 S5RL4 ZTL f _____ v . 8mGf R6 TZDA; LDg8qZTLG|5Df6 PpPpPpPpPp s; LDg8qZTL f

v E M T/L H fGf S|8G|5Df6 PpPpPpPpPpPpPpPpPp s; LDg84 S5RL4 ZTL f _____ v E M T/L H (PpPp ; PdLp HfOf. Gl PpPp ; PdLp ; f. hGL DmS 8f. ←
v AfZL AfZ6 f v : fUL, fSO fG f : 8L, QD q Vg|

v fZP : lP ; lP Sfdm
v fZP : lP ; lP SFD DAs|8G|5Df6 PpPpPpPpPpPpPpPp s; LDg84 S5RL4 ZTL f

_____ Vf SfdGf lJUT JfZ : 5XLOLSXG Gf lA Sfl 5f, S. HGZ zL PpPpPp 5fP LJEfUG| SRZLV VMOZ ; Gf ; Df NZd fG Sml 56 ; Df Hm XSXp Vf SfdGf Dh, Sl HfGz HGTGL Kp Vg|SfdDA Sml. 1Hf S| Vg| HD Tt H 6fH Tm T|AfATDA; AWT VmWfS . HGZ zL PpPpPpPpPpPpPpPp JTY S|H VmGL SRZL PpPpPpPpPpPpPpPpPpPpPp : Y/(Kp TmV mGL H fG NmZ Jf lJGTL Kp

SfI 5f, S. HGZ
DfPDP lJEfU4

Z_

SZfZGfDfDAHl FvHl Fcc AgS cc GM p<, |B K|T|T|cc AgS cc V|B, |S|ccXLOl, cc S|ccZf08Hl ST AgS cc H ; DHJLP
Slg8fS8Z C9/Gf AfWfSDGfDfSfGmGf|p5 lMU . HfZNFZ 5fTfGf DhZm : 8fO S|Vg| Sml. C|T|Df8|SZL XSX|GfCP Gm Vf XZTGM EU SZJfDA VfJX|Tm DfSfB Zg8 5Df6|T8, l Hul fG|EfOJ ; |, SZJfDA VfJXP

ZZ

8g0Z HMOGf Vg|lfZ 5 Tyf & DA S|8fS8Z| ; fRL DfCLTL Sf/HL5JS V f5JLP Vf DfCLTLGf VfwfZS|8fS8ZGf EfJm GLRf CmJf KTF T| lJRFZ6f C9/G|Sfd ; Df vDf fNfDfSzl XSJf ; 1fD K|S|Sd Vg|TGL VMOZ ; fYL GLRL Vg|H-Zl lFT Vg|-5 K|S|Sd T|AfAT GSSL SZJfDA VfJXP

24.

All statutory taxes deductable at source under various acts and notifications by government shall be deducted while making payment for which T.D.S. certificate shall be issued.

25.

Additional instruction regarding security deposit(clause-1)

25.1

the full amount of security deposit deducted in cash from running bills will be released proportionally as indicated in table below on production of bank guarantee of schedule bank provided the contactor produces bank guarantee for the period of six months beyond the stipulated period of completion of work. Further if the time limit of contract is extended the period of bank guarantee shall have to be extended for six months

beyond the proposed extension of time limit and the contractor shall have to furnish the undertaking for this alongwith the application for extension in time limit.

Sr	Monetary Progress	Portion of Security Deposit to be released	Against production of Bank guarantee of
1.	25% of tender cost	Equal to the amount retained from running Bills or 0.625% of the estimated cost of work, whichever is less	Equal to the amount to be released
2.	50% of tender cost	Equal to the amount retained from running Bills or 1.25% of the estimated cost of work, whichever is less	Equal to the amount to be released
3.	75% of tender cost	Equal to the amount retained from running Bills or 1.88% of the estimated cost of work, whichever is less	Equal to the amount to be released

25.2 It will have to be ensured that ten percent amount of security deposit in any form as permissible above is kept available with the employer till the actual date of completion of work. (Vide as per R & B circular No. TNC-10-2013-3-(Part-2)-C dated 20-11-2013)

TENDER FOR WORK - SFD DF8GL8qOZ

I/ We hereby tender for the execution for the Governor of Gujarat (hereinbefore and hereinafter referred to as Government) of the work specified in the underwritten memorandum within the time specified in such memorandum at the tendered rates specified in Schedule 'B' (memorandum showing item of works to be carried out) and in accordance in all respects with the specifications, designs, drawings and instructions in writing referred to in this tender and in Clause 13 of the annexed conditions of contract and agree that when materials for the work are provided by Government , such materials and the rates to be paid for them shall be as provided in schedule 'A' hereto.

VfYL Qq VDj; G; JR cBc CFY WZJFG SFDGL AFATMNXFJTL I FNLDVGIN08 8qOZGF NZYL VFJL I FNLDV9ZFEJ; DNtGL VmZ VgVf 8qOZGL ; FY[HMDj L Slt8FS8ZGL XZTMGF BD ! # DAH6fJj L , JBT IJUTIM IOhf. Gm OM. U Vg; JRGVMM Vg; FZ AWL ZFTq GLRj H6fJj L I FNLDVNXFJ; JSFD SZJF DF8[UH-ZFTGF ZFH I 5f, sHDGj VCLVUfp VgCj]5KL c; ZSfz; TZLS[H6fJj Kpf DF8[8qOZ ZH]SZ]K]q SZLV[KLV]VgT[SFD DF8; ZSfz TZOYL DF, ; FDFG 5ZM 5fOJFDAVfJ[tI FZ]T[DF, ; FDFG VgT]DF8[R]SJJFGF NZ ; FY[GL Vg; JR cS; DRAHMJF/VMSI F'D]HAGL ZC[X]T]DGj VDG[SA] Kp

* Strike out which ever is not applicable

*, FUJG 50T]CMI T[K]SL GFBj

+ In figures as well as words

* VFSOF TPDH XaNMDA

Time allowed for the completion of work form date of written order to commence 32 (Thirty Two) months (Including Monsoon Period).

Should this tender be accepted I/We hereby agree to abide by and fulfill the terms and provision of the condition of the contract annexed here to so far as applicable and in default thereof to forfeit and pay to The Executive engineer, BUILDING DEPARTMENT, Bhavnagar Municipal Corporation, Bhavnagar the sums of money mentioned in the said conditions. The Executive engineer, BUILDING DEPARTMENT, Bhavnagar Municipal Corporation, Bhavnagar (Receipt No. _____ dated _____ for The Executive engineer, BUILDING DEPARTMENT, Bhavnagar Municipal Corporation, Bhavnagar at _____ in respect of sum of **Rs11,99,40,841.00** is forwarded herewith representing the earnest money deposit in full the value of which is to be absolutely forfeited by The Executive engineer, BUILDING DEPARTMENT, Bhavnagar Municipal Corporation, Bhavnagar should I/We not deposit the full amount of Security Deposit as specified in the memorandum of works in brief in accordance with Clause I of the said conditions, the sum of which is otherwise Rs._____.

Name of the Contractor _____

Address _____

Dated the ____ day of _____ 2024

Name of Witness _____

Address _____

Occupation _____

The Tender is hereby accepted by me on behalf of The Governor of Gujarat on the ____ day of _____ 2024.

Signature of the Contractor

**Executive Engineer,
BUILDING DEPARTMENT,
BHAVNAGAR MUNICIPAL CORPORATION
BHAVNAGAR**

1. DATA SHEET FOR B-1 E-TENDERING
2. NOTICE INVITING TENDERS
3. ADDITIONAL INSTRUCTIONS TO PERSONS TENDERING
4. DECLARATION FORM
5. DECLARATION CERTIFICATE
6. GENERAL RULES AND DIRECTIONS FOR THE GUIDANCE OF CONTRACTORS
7. TENDER FOR WORK
8. MEMORANDUM
9. TERMS & CONDITIONS OF CONTRACT

LIST OF TERMS AND CONDITIONS CLAUSE

DETAILS		
Clause 1	Security deposit	
Clause 2	Liquidated damages for delay	
Clause 3	Default by contractor	
Clause 4	Action when the progress of any particulars portion of the work is unsatisfactory	
Clause 5	Non exercise of powers under clause 3 not a waiver	
Clause 6	Power to seize tools, plants, machinery's, materials and stores of the contractor on Invocation of clause 3.	
Clause 7	Extension of time limit	
Clause 8	Final Measurements and final bill on completion of work	
Clause 9	Intermediate and final Payment	
Clause 10	Payment at reduced rates	
Clause 11	Bills to be submitted monthly	
Clause 12	Bills and rates payable	
Clause 13	Material to be supplied by the Owner	
Clause 14	Consumption and return of materials supplied by the Owner	
Clause 15	Safe custody of materials supplied by the Owner	
Clause 16	Drawings / Designs, Instructions of the Architect/Owner and Specification, order of precedence in case of discrepancies	
Clause 17	Excess over Tender Quantities, Extra Items and Variations	
Clause 18	No claim to any payment or compensation for alterations or for Restrictions of work.	
Clause 19	No claim for delay in supply of materials by the Owner	
Clause 20	Claims under the contract	
Clause 21	Remedies for inferior or bad work, materials or workmanship and maintenance clause.	
Clause 22	Defect liability clause.	
Clause 23	Work to be open for inspection contractor's responsible agent to be Present	
Clause 24	Employment of qualified Site Engineer by Contractor	
Clause 25	Notice to be given before work is covered up	
Clause 26	Damage to contract work-in-progress and damages to surrounding Properties	
Clause 27	Damages due to acts of God and unprecedented floods	
Clause 28	Contractor to supply plant ladders, scaffolding etc and is libel for damage arising from non-provision of lights, fencing etc.	
Clause 29	Regulations for scaffolds, working platforms, gangways and stairways	
Clause 30	Regulations for hoisting appliances	
Clause 31	Measure for prevention of fire	
Clause 32	Liabilities to contractors for any damages done in or outside work	
Clause 33	Deleted	
Clause 34	Work not to be sublet; consequences for unauthorized subletting, bringing and becoming insolvent	
Clause 35	Sums payable by way of compensation to be considered as reasonable compensation without reference to actual loss	
Clause 36	Changes in the constitution of firm to be notified	
Clause 37	Works to be under directions of Architect/Owner/Consultant	
Clause 38	Settlement of Disputed and Arbitration	

Clause 39	Lump sums in estimates	
Clause 40	Action where no specifications	
Clause 41	Definition of work	
Clause 42	Contractors percentage-whether applied net or gross amount of the bill.	
Clause 43	Royalties	
Clause 44	Compensation under the Workman, Compensation Act	
Clause 45	Liability of the contractor in case of accidents	
Clause 46	Arrangements for personal safely requirements and First aid	
Clause 47	Variation in quantity of work	
Clause 48	Employment of famine or other labour	
Clause 49	Claim for compensation for delay in starting the work	
Clause 50	Claim for compensation for delay in the execution of work	
Clause 51	Entering upon or commencing any portion of work	
Clause 52	Minimum age of persons employed	
Clause 53	The payment of fair wages etc.	
Clause 54	Method of payment	
Clause 55	Employment of scarcity labour	
Clause 56	Rates inclusive of sales tax etc.	
Clause 57	Employment thought Employment Exchange and local labour	
Clause 58	Fair wages	
Clause 59	List of Machinery	
Clause 60	Liabilities of contractor for idleness of Road Rollers deployed by the Owner on contract work	
Clause 61	Local labour on normal rates	
Clause 62	Land on Hire and rental charges	
Clause 63	Vaccination to labourers	
Clause 64	Camp facilities to workers	
Clause 65	Gum boots, hand gloves, masks etc. to labourers	
Clause 66	No distinction between Harijans and other workers	
Clause 67	Price Escalation clause.	DELETED
Clause 68	Fencing and Lighting	
Clause 69	Liabilities for accident to persons	
Clause 70	Access to site and work on site	
Clause 71	Reports regarding labour	

Clause 72	Treasure trove	
Clause 73	Indemnity	
Clause 74	Insurance of labourers	
Clause 75	Setting out	
Clause 76	Cement Register	
Clause 77	Materials and Works Test Register	
Clause 78	Progress Schedule	
Clause 79	Secured Advance	DELETED
Clause 80	Advance Payment	DELETED
Clause 81	Advance against machinery's	DELETED
Clause 82	Mobilization Advance	DELETED
Clause 83	License for contract labour	
Clause 84	Recovery of testing charges	
Annexure-1	Declaration regarding Income Tax, Addresses etc.	
Annexure-2	Basic rates considered by the contractor	
Annexure-3	Performance Bond	
Annexure-4	List of works already completed by the tenderer	
Annexure-5	List of plant and Machinery	
Annexure-6	Declaration regarding works on hand	
Schedule- 'A'	Materials to be supplied from Store	
Schedule- 'B'	Memorandum showing items of works to be carried out	
Schedule- 'C'	Time Schedule of completion	

TERMS & CONDITIONS OF CONTRACT

Clause 1 Security Deposit: The person/persons whose tender is accepted (hereinafter called the “Contractor” which expression shall unless excluded by, or repugnant to the context include his Legal heirs, executors, administration and assignees) shall (a) Deposit with the Owner a sum sufficient to make up the full security deposit specified in the tender in cash or in form of demand draft to Owner within a period of 10 days from the date of receipt of the notification of acceptance of his tender, or (b) (i) Initial Security Deposit of the total security deposits as specified in the tender form with the Owner in cash or in form of D.D. on receipt of notification of acceptance of his tender. If the Initial security deposit is not paid within the above specified time, no work order will be issued till the issue about delay is finally decided by the competent authority (b) (ii) The Owner shall be deemed to have been authorized to deduct to the balance of the security deposit as specified in the tender form from the amounts that become payable to the contractor for the work done under the contract from time to time, such deduction shall not exceed ten percentage of the amount so payable and the works whose amount paid in cash or by way of deduction shall be estimated amount is more than rupees held by Owner by way of Security deposit. Than rupees fifteen lacks, the contractor shall have to give the performance bond of any schedule bank equivalent to five percentage of the estimated amount put to tender along with the initial security deposits. All compensation, Liquidated damages or other sums or money payable by the contractor to Owner under the terms of this contract shall be deducted from or recouped by the realization of a sufficient part of his security deposit, or from the interest arising there from or performance bond or from any sums which may due or may become due by Owner to the Contractor on any account what so ever and whether in respect of this contract, any other contract, or otherwise. In the event of his security deposit being reduced by reason of any such deduction or recoupment as aforesaid, the contractor shall within ten days thereafter, make good in cash or as aforesaid any sum or sums required to make good the shortfall in the amount of the security deposit. If the amount of the security deposit to above be paid as specified above in cash or by D.D within the period specified above is not paid the tender/contract already accepted should be considered as canceled and legal steps shall be taken against the contractor for recovery of the amounts.

Clause 2 Liquidated damages for delay: -

- (i) If the contractor fails to complete the work under contract by the stipulation date he shall pay liquidated damages of Rs. 0.1 percentage of the contract value per day from the date of delaying the said work up to the date of completion and handing over to the Owner.
- (ii) However also if the contractor fails to complete any part of the works as designed in Schedule (C) by the time indicated against such part, he shall pay Liquidated damages per day from the date of delaying the said part of the works up to the date of completion of the said designated part at the rates shown in the said Schedule of the contract value of part for such failure till the said designated part is completed.
- (iii) The aggregate maximum of liquidated damages payable under clause No. 2 shall not exceed Rs. 0.1 percentage of contract value per day and shall be subject to the maximum amount of ten percentage of the estimated amount put to tender.
- (iv) Delays requiring payment of ten percentage liquidated damages of the amount put to tender for performance shall be sufficient causes for termination of contract and for forfeiture of security deposit including amount of performance bond in respect of works estimated to cost more than Rs. 15 lacks, for performance and registration of the contractor shall also be kept in abeyance for three years from the date as fixed in all cases. (See Schedule (C) on page No. 48)

Clause 3 Default by contractor:- If the contractor shall neglect or fail to proceed with the work with due diligence or if he violates any of the provision of the Contract, the Architect/Owner shall give the Contractor a notices, identifying deficiencies in performance and demanding corrective action. Such notice shall clearly state that is shall not remove any plant; equipment and material from the site. The Owner shall have a lien on all such plant, equipment and material from the date of such notice till the said deficiencies have been corrected as mentioned in the said notice. If the contractor fails to take satisfactory corrective action within ten days after receipts of notice, the Owner shall terminate the contract in whole. In case the entire contract is terminated the amount of security deposit and performance band if any together with the value of the work done but not paid for, shall stand forfeited to the Owner. The plants, equipment and materials, held under this clause shall then be at the disposal of the Owner to recover the amount equivalent to liquidated damages and registration of the contractor shall be kept in abeyance for three years from the date as fixed in all such cases. The Architect/Owner if necessary shall direct that a part or the whole of such plant, equipment and materials be removed from the site within a stipulated period. If the contractor fails to do so, the Architect/Owner shall cause them or any part of them to be sold holding the net proceeds of such sale to the credit of the Contractor. After settlement of accounts the lien by the Owner of the contractor’s remaining plant equipment and balances of materials shall be released.

Termination of the contract in whole shall be an adequate authority for the Architect/Owner to demand discharge of the obligations from the guarantors of the security for the performance.

- Clause 4** If the progress of any particular portion of the work under Contract is unsatisfactory the Architect/Owner shall, notwithstanding that the general progress of the works is satisfactory, in accordance with clause 2 be entitled to take necessary action under clause 3, after giving the Contractor ten days' notice in writing and the contractor shall have no claim whatsoever for any compensation for any loss caused to him due to such action.
- Clause 5** In any case in which any of powers conferred upon the Architect/Owner by clause 3 hereof shall have become exercisable and the same shall not have been exercised, the non-exercise thereof shall not constitute a waiver of any of the conditions hereof and such powers shall notwithstanding be exercisable at any future date.
- Clause 6** In the event of the Architect/Owner taking action under clause 3, he may, if so desire, take possession of all or any tools, plants machinery, materials and stores in or upon the work or the site thereof or belonging to the contractors or procured him and intended to be used for the execution of the work or any part thereof by paying or allowing for the same in account at the contract rate or in case of contract rates not being applicable at such reasonable rates, as may be comparable to current market rates where ascertainable of similar articles and comparable condition, to be certified by the Architect/Owner. In the alternative the Architect/Owner may by notice in writing to the contractor or his clerk of the works foreman or other authorized agent require him to remove such tools, plants, machines materials or stores from the premises within a time to be specified in such notice and in the event of the contractor failing to comply with any such requisition, the Architect/Owner may remove them at the contractor's expenses or the Architect/Owner shall remove them by auction or private sale at the risk and cost of the contractor in all respects, and the certificate of the Architect/Owner as to the expenses of any such removal and the amount of the proceeds, and expenses of any such removal shall be final and conclusive against the contractor.
- Clause 7** **Extension of time:-** If the contractor shall desire an extension of the time for completion of the work on the ground of his having been unavoidably hindered in its execution or any other ground he shall apply in writing to the Architect/Owner before the expiration of the period stipulated in the tender or before the expiration of 30 days from the dates on which he was hindered whichever is earlier and the Architect/Owner may, if in his opinion believe that there are reasonable grounds for granting an extension, grant such extension as he thinks necessary or proper. The decision of the Architect/Owner in this matter shall be final.
- Clause 8** As soon as the work is completed, the contractor shall give a notice of such completion to the Architect/Owner and on receipt of such notice the Architect/Owner shall inspect the work and if he is satisfied that the work is complete in all respects then: -

- (i) For all works costing up to Rs. 50 Lacks (amount put to tender) the final measurements shall be recorded within 45 days from the date of physical completion of the work and the final bill shall be prepared within 45 days from the date of recording final measurement. The completion certificate shall be issued within one month from the date of final measurements subject to the contractor fulfilling his obligation as provided in the contract and subject to the work being complete in all respects.
- (ii) In respect of works costing more than Rs. 50 Lacks (amount put to tender) the final measurements shall be recorded within 75 days from the date of physical completion of the work and the final bill shall be prepared within 75 days from the date of recording final measurements subject to the contractor fulfilling his obligation as provided in the contract and subject to the work being complete in all respects.

When separate period of completion have been specified for item or groups of item, the Architect/Owner shall issue separate completion certificate for such item or group of item.

No certificate of completion shall be issued nor shall the work be considered to be complete till the contractor shall have removed from the premises, on which the work has been executed, all scaffolding, sheds and surplus materials, except such, as are required for rectification of defects; rubbish and all huts and sanitary arrangements required for his workmen on the site in connection with the execution of the work, as shall have been erected by the contractor for the workman and cleared all dirt from all parts of structure (s) in, upon or around which the work has been executed or of which he may have possession for the purpose of the execution thereof and cleared floors, gutters and drains, cased doors and sashes, oiled locks and fastening labelled keys clearly and handed then over to the Architect/Owner or his representative and made the whole premises fit for

immediate occupation or use to the satisfaction of the Architect/Owner. If the contractor shall fail to comply with any of the requirements of these conditions as aforesaid, on or before the date of completion of the works, the Architect/Owner may, at the expense of the contractor, fulfill such requirements and dispose of the scaffolding, or surplus materials and except for any sum actually released by the sale thereof less the Cost of fulfilling the requirements is more than the amount realized such disposal as aforesaid the contractor shall forthwith, on demand, pay such excess. The Architect/Owner shall also have the rights to adjust the amount of excess against any amounts that may be the contractor.

- Clause 9** No payment shall be made for any work, estimated to cost less than rupees one thousand till after the whole of the side work shall have been completed and a certificate of completion given. But in the case of work estimated to cost more than rupees one thousand, the contractor shall on submitting a monthly bill therefore, be entitled to receive payment proportionate to the part of the work then approved and passed by the Architect/Owner, whose certificate of such approval and passing of the sum so payable shall be final and conclusive against the contractor. All such intermediate payments shall be regarded as payments by way of advance against the final payments only and as payments of work actually done and completed and shall not preclude the Architect/Owner from requiring bad, unsound imperfect or unskilled work to be removed and taken away and reconstructed. or re-erected, nor shall any such payment be considered as an admission of the contractor or any part therefore in any respect or the accruing of any claims, nor shall it conclude, or affect any way the power of the Architect/Owner as to the final settlement and adjustment of the accounts or otherwise or in any other way vary or effect the contract. The contractor shall submit the final bill within one month of the completion of the work, otherwise the Architect/Owner's certificate of the measurements and of the total amount payable for the work shall be final and binding on all parties.
- Clause 10** The rates for item of work shall be valid only when the items concerned are accepted as having been completed fully in accordance with the sectional specifications. In cases where the item of work are accepted as not completed, the Architect/Owner may make payment on account of such item at such reduced rate as the may consider reasonable in preparation of final or on account bill.
- Clause 11** **Bills to be submitted monthly:** A bill shall be submitted by the contractor each month on or before the date fixed by the Architect/Owner for all works executed in the previous month and Architect/Owner shall take or cause to be taken the requisite measurement for purpose of having the same verified and the claim, so for it is admissible shall be adjusted if possible within tenders from the presentation of the bill. If the contractor does not submit the bill within the time fixed as aforesaid, the Architect/Owner may depute a subordinate to measure up the said work in the presence of the contractor or his duly authorized agent whose countersignature to the measurement list shall be sufficient warrant and the Architect/Owner may prepare a bill from such list which shall be binding on the contractor in all respects.
- Clause 12** The contractor shall submit all the bills on the printed forms to be had on application at the office of the Architect/Owner. The charges to be made in the bills shall always be entered at the rates specified in the agreement or at the partly reduced rates subject to the approval by the Architect/Owner in the case of Items not completed/executed as per agreements or in the case of any extra work ordered in pursuance of these conditions and not mentioned or provided for in the tender, at the rate here in after provided for such work.
- Clause 13** If the specification of the work provides for the use of any special description of materials to be supplied from the Owneral store or if it is required that the contractor shall use certain stores to be provided by the Architect/Owner (such materials and stores and the prices to be charged therefore as here in after mentioned being so far as practicable for the convenience of the contractor but not so as in any way to control the meaning or effect of this contract specified in the schedule of memorandum here to annexed) the contractor shall be supplied with materials and stores as may be required from time to time to be used by him for the purpose of the contract only, and the value of the full quantity of materials and stores so supplied shall be set off deducted any sum then deposit, or the proceeds of sale thereof, if the deposit is held in govt. securities, the same or a sufficient portion thereof shall, in that case be sold for the purpose. All materials supplied to the contractor shall remain the absolute property of Owner and shall on no account be removed from the site of the work, and shall at all time, be open to inspection by the Architect/Owner. Any such materials, unused and in perfectly good condition at the time of completion or termination of the contract, shall be returned to the Owner store if the Architect/Owner so requires by a notice in writing given under his hand. But the contractor shall not be entitled to return any such materials except with the consent in writing of the Architect/Owner and in shall have no claim for compensation on account of any such materials supplied to him as aforesaid but remaining unused by him or for any wastage in or damage thereto.

Clause 14 The contractor shall be entitled use the materials supplied by the Owner only to the extent of quantities of such materials required for execution of the work as per theoretical calculations. The Architect/Owner may however, on being satisfied that a large quantity o such materials is required for the execution of the work, permit the contractor to use such large quantity of the materials. Such permission shall be given in writing.

Clause 15 All stores and materials such as cement, if the consumption of which exceeds 25 tone and steel etc. supplied to the contractor by Owner shall be kept by the contractor in separate god own provided with a double lock. The key of the lock shall remain with the Architect/Owner or his agent. The godown shall be accessible to the Architect/Owner or his agent at all times. No materials shall be allowed to be removed from the site of the work and any materials required for the execution of the work shall be taken out from the godown only in the presence of a duly authorized agent of the Architect/Owner.

Clause 16 (1) The contractor shall execute the whole and every part of the work in the most substantial and workman- like manner and as regards materials and in other respect in strict accordance with specifications.

The contractor shall also conform exactly, fully and faithfully to the design, drawing and instruction in writing for the work signed by the Architect/Owner. The design and the drawings shall we lodged in the office of the site Architect/Owner to witch the contractor shall be entitled to have access for the purpose of inspection at such office during office hours. Where the instructions referred to above are not contained in separate letters addressed to the contractor the same shall be recorded in the work-order book, which shall be maintained and kept on the site of the work. The contractor shall be required to sing such entries in the work-order book for any reason whatsoever, the entry of the instruction in the work-order book shall be deemed to be the due notice to him of the said instructions. The work-order book shall be open for inspection to the contractor on the site of the work during office hours.

(1) The contractor will be entitled to receive one copy of the accepted tender along with the work order free of cost and will also be entitled to receive three sets of contract and working drawing according to the progress of work as and when need free of cost.

(2) The several documents forming the contract are essential part of the contract and requirements occurring in one are binding as through occurring in all. They are intended to be mutually explanatory and complimentary and to describe and provide for a complex work.

In the event of any discrepancy in the several documents forming the contractor or in any one document, the following order of precedence should apply:

(a) **Dimension and quantities:** (i) Drawings (ii) Schedule-B of the Tender form (iii) specifications. On drawing, figures dimensions, unless obviously incorrect, will be following in preference to scaled dimensions.

(b) **Description:** (i) Schedule – B of the tender form: - (ii) Drawings (iii) Specifications. In the case of defective description or ambiguity, the Architect/Owner is entitled to issue further instruction direction in what manner the work is to be carried out. The contractor cannot take any advantage of any apparent error or omission in drawing or specification and the Architect/Owner shall be entitled to make correction and interpretations as necessary to fulfill plans and specifications.

Clause 17.1 The Architect/Owner shall have power to make any alterations in or addition to the original specifications, drawings, designs, and instructions that may appear to him to be necessary or advisable during the progress of the work and the contractor shall be bound to carry out the work in accordance with any instructions in this connection which may be given to him in writing signed by the Architect/Owner and such alteration shall not invalidate the contract and additional work which the contractor may direct to do in the manner above specified as part of the work shall be carried out by the contractor on the same conditions in all respects on which he agreed to the work and at the same rate as are as specified in the tender for the main work.

Clause 17.2 *Except that when the quantity of any item exceeds the quantity as in the tender by more than 10% the contractor will be paid for the quantity in excess of 10% at the rate entered in the S.O.R. of the year during which the excess in quantity is first executed and for the materials consumed in excess quantity the rate materials to be charged would be the basic rate taken into account for fixing the rate for the S.O.R. above instead of the rate stipulated in schedule – A.*

Clause 17.3 If the additional or altered work includes any class of work for which no rate is specified in this contract, then such class of work shall be carried out.

(i) At the rate derived from the item within the contract which is comparable to the involving additional or altered class of work; where there are more than one comparable items, the items of the contract which is nearest in comparison with regard to or class or classes of the work involved shall be selected and the decision of the owner as to he nearest comparable item shall be final and binding on the contractor.

- (ii) If the rate cannot be derived in accordance with (i) above, such class of works shall be carried out at the rate entered in the Schedule of Rates in the year in which the tender was received. Increased or decreased by the percentage by which the tender amount is more or less as compared to the amount arrived at the rates in the Schedule of Rates for the year in which the tender was received. If the Schedule of rates does not contain all the items, the percentage increase of the tender shall be calculated considering such items which were included in the Schedule of Rates for the year and for materials consumed on such item the rate to be charged would be the basic rate taken into account for fixing the rate in S.O.R. referred to above, instead of the rate stipulated in Schedule (A).
- (iii) If it is not possible to arrive at rate from (i) and (ii) above, such class of work shall be carried out at the rate decided by the competent authorities on the basis of detailed rate analysis after hearing the contractor before a Committee of two Engineers stationed at the same place or the nearest place.

Clause 17.4 If the additional or altered work, for which no rate is entered in the "Schedule of Rates" is ordered to be carried out before the rate is agreed upon then the contractor shall within seven days of the date of receipt by him of the order to carry out the work, inform the Architect/Owner of the rates, which it is his intention to charge for such class of work and if the Architect/Owner does not agree to this rates, he shall by notice in writing be at liberty to cancel his order to carry out such class of work and arrange to carry it out in such manner as he may consider it advisable, provided always that if, the contractor shall commence work or incur any expenditure there of before the rate shall have been determined as lastly herein before mention, then in such cases he shall only be entitled to be paid in respect of the work carried out or expenditure incurred by him prior to the date of the determination of the rate as aforesaid according to such rate or rates as shall be fixed by the Architect/Owner. In the event of the dispute, the decision of owner shall be final.

Where, however the work is to be executed according to the designs, drawings and specifications recommend by the contractor and accepted by the competent authority; the alternation above referred to shall be within the scope of such designs, drawings and specifications appended to the tenders. The time limit of the work shall be extended in the proportion that the increase in the cost occasioned by alternations bears to the cost of the original contract work and the certificate of the Architect/Owner as to such be final and conclusive.

Clause 17.5 For excess in items of well sinking, the rates for sinking in depth beyond the designed depth shall be as per the rate quoted by the contract in the statement of variation. If no rates of variation in sinking are quoted the rate payable shall be the tender rate for sinking designed level increased by the difference of schedule of rate for sinking at designed depth and sinking at final depth.

Clause 18 No claim for any payment of compensation for change or restriction of work: - If at any time after the execution on the contract documents the Architect/Owner shall for any reason whatsoever, require the whole or part of the work, as specified in the tender, be stopped for any period or shall not required the whole of part of the work to be carried out at all or to be carried out by the contractor he shall given notice in writing, stating the fact to the Contractor who shall thereupon suspended or stop the work totally or partially, as the case may be. In any such case, except provided hereunder, the Contractor shall have no claim to any payment or compensation whatsoever except as provided hereunder on account of any profit or advantage which he might have derived from the execution of the work in full but which he did not so derive in consequence of the full amount of the work not having been carried out, or on account of any loss that he may be put to on account of materials purchased or agreed to be purchased or for unemployment of labour required by him. He shall not have also any claim for compensation by reason of any alterations having been made in the original specifications, drawings, designs and instructions, which may involve any curtailment of the work, as originally contemplated.

- (1) However, the contractor will entitled for compensation for loss, if any on date of notice, for the purchased materials or for the contract executed for the materials to be purchased for such work. Such compensation will be paid only for actual loss for materials, if such materials so purchased or agreed to purchase is of required quantity/quality and was purchased/contracted to be purchased only for the same work. But to compensation shall be granted to contractor on material for which advance has been give to contractor by owner. The amount of loss for such claim will be decided by Architect/Owner.
- (2) The contractor also will be entitled for compensation of unemployed labourers for 7 days from the date of notice provided that in that opinion of Architect/Owner such labours were working for 7 days prior to the notice and would not be in a position to get employment elsewhere within 7 days from the date of such notice. The contractor should try to employ such unemployed labourers at other places from the date of such notice. In case the Contractor does not agree with decision of Architect/Owner. Engineer regarding the amount of compensation or loss it will be open for the contractor to appeal to Owner. Within one month from the date of knowledge of such decision. In such case the decision of Owner will be final and binding to the Contractor.
The Contractor shall not be entitled for loss of any expected profit of such work.

- Clause 19** The contractor shall not be entitled to claim any compensation from Owner on account of delay by Owner in the supply of materials entered In Schedule 'A' where such delay is caused by (i) Non supply due to short allotment of quota in case materials available under quota regulations (ii) Difficulties relation to the supply of railway wagon (iii) Force majeure. (iv) Act of God. (v) Act of the county's enemies or any other reasonable cause beyond the control of Owner.
In the case of such delay In the supply of materials, Owner shall grant such extension of time for the completion of the work as shall appear to the to the Architect/Owner the reasonable in accordance with the circumstances of the case. The ceeision of Architect/Owner for the extension of time shall accepted as final by the contractor.
- Clause 20** **Time limit for unforeseen claims:** the contractor shall not be entitled to any compensation from Owner on nay account unless where allowed by the conditions of this contact. In such cases, the contractor shall have to submit a claim in writing to the Owner within one month of the cause of such claim occurring.
- Clause 21** **Action & Compensation in case of bad work:** If at any time before the expiry of defects liability period as detailed in clause 22. It shall appear to the Architect/Owner or his sub-ordinate in charge inferior quality or that any materials or articles provided by him for the execution of the work are unsound, or of a quality inferior to that contracted for or are otherwise not in accordance with the contract. It shall be law full for the Architect/Owner to intimate this fact in writing to the contractor and then not with standing the fact that the work, materials of articles of complained of may have been passed, certificate and paid for the contractor shall be require, or if so required, shall remove the materials or articles so specified in whole in part and the case may provide other proper and suitable materials or articles at his own charge and cost, and in the event his failing to do so within a period to be specified by the Architect/Owner in the written intimation aforesaid, the contractor shall be liable to pay compensation at the rate of one percent on the amount of the estimate of the rectification for every day not exceeding ten days during which the failure so continues, and in the event of any such failure as aforesaid continuing beyond ten days, the Architect/Owner may rectify or remove, and re-execute the work or remove and replace the materials complained of as the case may be at the risk and expense in all respects of the contractor. Should the Architect/Owner consider that any such inferior work or materials as described above may be accepted or made use of, it shall be within his discretion to accept the same at such reduced rates as he may fix therefore.
However, the contractor shall be responsible for normal maintenance of the work till the final bill for work is prepared by Architect/Owner.
- Clause 22** **Defect liability periods:** *The contractor shall be responsible to make good and remedy at his own expense any defect, which may develop or may to be noticed before period mentioned hereunder form the certified date completion. The Architect/Owner shall give the contractor a notice in writing about the defects and the contractor shall make good the same within 15 days of receipt of notice. In the case of failure on the part of the contractor, The Architect/Owner shall be entitled to appropriate the whole or any part of the amount of security deposit towards the expenses, if any, incurred by him in rectification, removal or re-execution. **The defects liability period shall be 36(THIRTY SIX) months from the certified date of completion.***
- Clause 23** Work to be open to inspection – contractor or responsible agent to be present: - All works under or in course of execution or executed in pursuance of the contract shall, at all times be open to the inspection and supervision of the Architect/Owner and his subordinates and the contractor shall, at all times during the usual working hours, and all other times for which reasonable notice of the intimation of the Architect/Owner or his subordinate to visit work shall have been given to the contractor, either himself be present to receive orders and instructions or have a responsible agent duly accredited in writing present for that purpose. Orders given to the contractor duly authorized agent shall be considered to have the same force and effect as of they had been given to the contractor himself.
- Clause 24** **Employment of a qualified site Engineer by the Contractor. The contractor shall employ full- time technically qualified staff during the execution of his work as under:**
- 1. Two graduate Civil Engineer and three diploma Civil Engineer when cost of the work to be executed is more than Rs. 50 lacks.**
 - 2. One graduate & two Diploma Civil engineer when the work to be executed is more than 15 Lacks but less than Rs. 50 Lacks.**
 - 3. Minimum One Diploma Civil Engineer when the cost of work is less than Rs. 15 Lack but more than Rs. 5 Lacks.**

4. Minimum two Diploma Civil Engineer for the work when the cost of work to be executed is less than Rs. 5 Lacks. The Engineer so employed for the work must have sufficient experience to handle the work independently. Such an Engineer shall have to stay at the site of the work and he shall not be entrusted with other duty except this work. In case the contractor or partner of the contractor firm is a civil Graduate Engineer, Employment of a separate Engineer will not necessary provided that the Engineer partner himself attends the execution of the work on the site.

Clause 25 **Notice to be Given before work is covered up:** The contractor shall give not less than five day's notice in writing to the Architect/Owner or his subordinate in charge of the work before covering up or otherwise placing beyond the reach of measurement any work in order that the same may be measured and correct dimensions there of taken before the same is so covered up or placed beyond the reach of measurement and if any work shall be covered up or placed beyond the reach of measurement without search notice having been given or consent obtained the same shall be uncovered at the contractor's expense and any default thereof, no payment or allowance shall be made for such work or for the materials with which the same was executed.

Clause 26 If the contractor or his workmen, or servant shall break, deface injure or destroy any part of the building or the work in question in/on which they may be working or any building, road, fence enclosure or grass land or cultivated ground contiguous to the premises on which the works or any part thereof is being executed or if any damage shall be done the work from any cause whatever before a damage occurred/caused due to normal flood or rain or if any imperfections become apparent in it within three months of the grant of a certificate of completion, final or otherwise by the Architect/Owner, the contractor shall make good the same at own expenses or in default, the Architect/Owner may cause the same to be made good by the contractor, and deduct the expenses (of which the certificate of the Architect/Owner shall be final) from any sums that may thereafter become due to the contractor or from his security deposit or the proceeds of sale thereof or a sufficient portion thereof.

Clause 27 Neither party shall be liable to the other for any loss or damage occasioned by or arising out of acts of God, such as Unprecedented flood, volcanic eruption, earthquake or other convulsion of nature and other acts such as not but restricted to general strike, invasion, the acts of foreign countries, hostilities, or war like operations before or after declaration of war, rebellion, military or Usurped power which prevent performance of the contract and which could not have been foreseen or avoided by a prudent person.

Note: - "Unprecedented Flood" means the flood crossing the High flood level of the past _____ year(s) which is on the available record.

Clause 28 Contractor to supply plant, ladders, scaffolding etc. and is liable for damage arising from non provision of light, fencing etc.: The contractor shall supply at his own cost all materials (except special materials if any, as may, in accordance with the contract to be supplied from the Owners Stores), plant, tools, appliances, implements, ladder, condrage, tack, scaffolding, and any temporary which may be required for the proper execution of the work whether in the original, altered or substituted form and whether included in the specifications, or other documents forming part of the contract or referred in these conditions or not and which may be necessary for the purpose of satisfying with requirements of the Architect/Owner as to any matter or which under these conditions he is entitled to be satisfied or which he is entitled to require together with carriage therefore to and from the work. The Contractor shall also supply without charge the requisite number of persons with the means and work and materials necessary for the purpose there of setting out works and counting, weighing and assisting in the measurement or examination at any time and from time to time, of the Contractor and the expenses may deducted from any money due to the contractor under the contract of from his security deposit, or proceeds of sale there of a sufficient portion there of. The contractor shall provide all necessary fencing and lights required to protect the public from accident and shall also be bound bear expenses of defense of every suit, action or other legal proceeding at law that may be brought by any person for injury sustained owing to neglect of the above precautions and to pay any damages costs which may be awarded in such suit, action or proceedings to any such person, or which may with the consent of the Contractor, be paid in compromising any claim by any such person.

Clause 29 The Contractor shall provide suitable scaffolds and working platforms, gangways and stairways, and shall comply with the following regulations in connections therewith.

- (a) Suitable scaffold shall be provided for workmen for all works that cannot be safely done from a ladder or by other means.
- (b) A scaffold shall not be constructed and taken down or substantially altered except.
 - (i) Under the supervision of a competent and responsible person.
 - (ii) Appointed by contractor and by competent workers possessing adequate experience in this kind of work.
- (c) All scaffolds and appliances connected therewith and all ladders shall
 - (i) Be of sound materials

- (ii) Be of adequate strength having regard to the loads and strains to which they will be subjected, and
- (iii) Be maintained in proper condition
- (d) Scaffolds shall be so constructed that no part thereof can be displaced in consequence of normal use.
- (e) Scaffolds shall not be overloaded so far as practicable the load shall be evenly distributed.
- (f) Before installing the lifting gear on scaffolds, special precaution shall be taken to ensure the strength and stability of the scaffolds.
- (g) A competent person shall periodically inspect scaffolds.
- (h) Before allowing a scaffold to be used by his workmen, the Contractor shall, whether the scaffolds. Has been erected by his workmen or not, take steps to ensure that it complies fully with the regulation herein specified.
- (i) Working platforms, gangways shall be so constructed that no part thereof can bind to contractor, dag unduly or unequally.
 - (i) Be so constructed and maintained having regard to the prevailing conditions as to reduce as far as practicable risks of persons tripling or slipping and-
 - (ii) Be kept free from any unnecessary obstruction.
- (j) In the case of working platforms, gangways working places and stairways at a height exceeding ... (to be specified)
 - (i) Every working platform and every gangway shall be closely boarded unless other adequate measures are taken to ensure safety.
 - (ii) Every working platform and every gangway shall have adequate width, and
 - (iii) Every Working platform, gangway working place and stairway shall be suitably fenced.
- (k) Every opening in the floor to building or in a working platform shall, except for the time and provided with suitable means to prevent the fall of persons or materials.
- (l) When persons are employed on a roof where there is danger of falling from a height exceeding ... (to be specified) meters suitable precaution shall be taken to prevent the fall of persons of materials.
- (m) Suitable precautions shall be taken to prevent persons being struck by articles witch might fall from scaffold or other working pleased.
- (n) Safe means of access shall be provided to all working platform and other working places.

Clause 30 The Contractor shall comply with the following regulations as regards the hoisting appliances to be used by him-

- (a) Hoisting machines and tackle including their attachments, anchorage and supports shall.
 - (i) Be of good mechanical construction, sound materials and adequate strength and free from patent defect, and
 - (ii) Be kept in good repair and in working order
- (b) Every rope used in hosting or lowering materials or as a means of suspension shall be of suitable quality and adequate strength and free from patent defect.
- (c) Hoisting machines and tackles shall be examined and adequately tested after erection on the site and before use and re-examined in position at intervals to be prescribed by Architect/Owner.
- (d) Every chain, ring, hook, shackle, swivel and pulley block used in hoisting or lowering materials or as a means of suspension shall be periodically examined.
- (e) Every crane driver or hoisting-appliance operator shall be properly qualified.
- (f) No person who is below age of 18 years shall be in control of any hoisting machine, including any scaffolds, not shall given signals to the operator.
- (g) In the case of every hoisting machine and of every chain, ring hook, shackle, swivel and pulley block used in hoisting or lowering or as a means of suspension the safe working load shall be ascertained by adequate means.
- (h) Every hoisting machine and all gears referred to in preceding regulation shall be plainly market with the safe working load.
- (i) In the case of hoisting machine having a variable safe working load, each safe working load and conditions under which it is applicable shall be clearly indicated.
- (j) No part of any hoisting machine or gear referred to in regulation 'g' above shall be loaded beyond the working load except for the purpose of testing.
- (k) Motors, gears, transmission, or gear wiring and other dangerous parts of hoisting appliances shall be provided with sufficient safeguards.
- (l) Hoisting appliance shall be provided with such means as will reduce to a minimum the risk of the accidental descent of the load.
- (m) Adequate precautions shall be provided with such means as will reduce to a minimum the risk of suspended load becoming accidentally displaced.

Clause 31 Measures for Prevention of fire: The contractor shall not set fire to any standing jungle, trees, bush wood or grass without a written permit from the Architect/Owner. When such permit is given and also in all cases when destroying cut or dug up trees. Bush wood, grass etc. by fire, the contractor shall take necessary measure to prevent such fire spreading to or otherwise damaging surrounded property.

Clause 32 Liability of contractors for any damages done in or outside work area: Compensation for all damage done intentionally or unintentionally by Contractor's labours whether in or beyond limits of Owner property including any damage caused by the spreading of fire mentioned in the clause 31, shall be estimated by the Architect/Owner, shall be final and the contractor shall be bound to pay the amount of assessed compensation on demand, failing which the same will be recovered from the contractor as damages in the manner prescribed in clause 1 or deducted by the Architect/Owner from any sums that may be due or become due from Owner to the contractor under the contract or otherwise.
The contractor shall bear the expenses of defending any action or other legal proceeding that may be brought by any person for injury sustained by him owing to neglect or of precautions to prevent the spread of the fire and he shall also pay the damages and cost that may be awarded by the court in consequence

Clause 33 Deleted

Clause 34 Work not to be sublet. Contract may be rescinded and security deposit forfeited for subletting it without approval or for bribing a public officer or if contractor become insolvent: The contract shall not assigned or sublet without the written approval of the Architect/Owner. And if the contractor shall assign or sublet his contract or attempt to do so or become insolvent or commence any proceeding to get himself adjudicated insolvent or make any compromise with his creditors, or attempt to do so the Architect/Owner may, by notice in writing rescind the contract, Also if any bribe, gratuity, gift, loan perquisite reward or advantage, pecuniary or otherwise, shall either directly or indirectly be given promised or offered by the contractor, or any of his servants or agents to any public officer or person in the employ of Owner in any way relating to his office or employment or if any such officer or person shall become in any way directly or indirectly interested in contract, the Architect/Owner may thereupon by notice in writing rescind the contract, in the event of contract being rescinded, the security deposit of the contractor shall thereupon stand forfeited and be absolutely at the disposal of Owner and the same consequence shall ensue as if the contract had been rescinded under clause 3 thereof and in addition the contractor shall not be entitled to recover or be paid for any work therefore actually performed under the contract.

Clause 35 Sums payable by way of compensation to be considered as reasonable compensation without reference to actual loss: All sums payable by a contractor by way of compensation under any of these conditions shall be considered as a reasonable compensation to be applied to the use of Owner without reference to the actual loss or damage sustained and whether any damage has or had not been sustained.

Clause 36 Change in the constitution of firm to be notified: In the case of a tender by partners, any change in the constitution of a firm shall be forthwith notified by the Contractor to Architect/Owner for his information.

Clause 37 Works to be under directions of Architect/Owner/Consultant: All works to be executed under the contract shall be executed under the direction and subject to the approval in all respect of Architect/Owner/Consultant appointed by the Owner for the time being, who shall be entitled to direct at what points or point and in what manner they are to be commenced and from time to time carried on.

Clause 38 (1) Disputes to be referred to arbitrator: The disputes relating to this contract, so far as they relate to any of the following matters, whether such disputes arise during the progress of the work or after the completion or abandonment thereof, shall be referred to the Arbitration Tribunal, Gujarat State, Gandhinagar.

Namely-

(i) The rates of payment under clause 5 for any tools, materials and stores, in or upon the works of the site thereof belonging to the contractor or procured by him and intended to be used for execution of the work or any part thereof possession of which may have been taken by the Architect/Owner under the said clause 5 as completed fully in accordance with the sanctioned specifications.

(ii) The reduction in rates made by the Architect/Owner under clause 10 from the items of work not accepted as completed fully in accordance with the sanctioned specifications.

(iii) The rate of payment for any class of work which is included in the additional or altered work carried out by the contractor in accordance with the instructions of the Architect/Owner under clause 17 and the rates for which is to be ascertained under the said clause 17.

- (iv) The rates of payment for materials already purchased or agreed to be purchased by the contractor before receipt of notice given by the Architect/Owner under clause 18, and / or the amount of compensation payable to the contractor under the said clause for loss in respect of such materials.
- (v) The amount of compensation which the contractor shall be liable to pay under clause 21 in the event of his failure to rectify, remove or reconstruct the work within the period specified in the written intimation of the amount of expenses incurred by the Engineer-in-removing and under the said clause 21 in rectifying removing or re-executing the work or in removing and replacing the materials or ratifying complained of.
- (vi) The reduction of rates as may be fixed by the Architect/Owner under clause 21 for, the inferior work or materials rates as accepted or made use of.
- (vii) The amount of compensation payable by the contract for damages as estimated and assessed under clause 32.
- (viii) The amount payable to the contractor the work carried out under clause 40 in accordance with the instructions and the requirements of the Architect/Owner in a case where there are no specifications.
- (2) The provision of section-21 of the GPWD disputes Arbi. Tribunal Act-92 & order issued by the Govt. in connection with this Act will now apply for Arbitration (As per government in N.& W.R.D. letter No. SUT/ 1090/ 2679/K2 Dtd. 9/2/94.
- (3) The provision of Arbitration Act. Shall in so far as they are inconsistent with the provision of this act. Cease of to apply to any dispute arising from a works contract and all arbitration proceedings in relation to such dispute before an arbitrator; court of authority shall stand transferred to the tribunal.
- (4) The awards declared by the arbitrator should be speaking award, giving reasons and calculations for every item of claims. The decision will have to be implemented by all the departments of the State Government and public sector enterprises of Gujarat. (Resolution F.D. No. PB/1088/735/KT/Sachivalaya/Gandhinagar 5th October 1988.)
- (5) Incase of dispute leading to the contractor of Government of Gujarat approaching to Court of Law, it shall be within the jurisdiction where the site of work situated.
- (6) The reference to arbitration proceeding under this clause shall not:
 - (i) Affect the right of the Architect/Owner under clause 5 to take possession of all or any tools, plants, materials and stores in or upon the works of site thereof belonging to the contractor or procured by him and intended to be used for execution of the work or any part thereof.
 - (ii) Preclude the Architect/Owner from unitizing the materials purchased by the contractor in any work or from removing such materials to other places, during the period the work is stopped or suspended in pursuance of notice given to the contractor under clause 18.
 - (iii) Entitle the contractor to stop the progress of the work or the carrying out the additional or altered work in accordance with the provisions of clause 17 or as the case may be, of clause 40.

Clause 39 Lump sum in estimates: When the estimate on which a tender is made includes lump sum in respect of part of work, the contractor shall be entitled to payment in respect of the items of work involved or the part of the work in question at the same rates as are payable under this contract for such items, or if the part of the work in question is not the opinion of the Architect/Owner capable of measurement, the Architect/Owner may, as his discretion pay the lump sum amount entered in the estimate and the certificate in writing of the Architect/Owner shall be final and conclusive against the contractor with regard to any sum payable to him, under the provision of this clause.

Clause 40 Action where no specifications: In the case of work for which there is not such specification, such work shall be carried out in accordance with the Standard Specification and in the event of there being no Standard Specification, then in such case the work shall be carried out in all respect in accordance with the instructions and requirements of the Architect/Owner.

Clause 41 Definition of work: The expression or “Work” or “Works” where used in these condition shall unless, there be something in the subject or context repugnant to such contraction be construed to mean the work, or the works, contracted to be executed under or in virtue of the contract, whether temporary or permit and whether original, altered, substituted or additional.

Clause 42 Contractor’s percentage whether applied to net or gross amount of the bill: Percentage referred to in the tender shall be deducted from/added to the gross amount of the bill before deducting the value of any stock issued.

Clause 43 Non-refund of quarry fees & royalties: The contractor shall pay the royalty to the competent authority/local body as per rules. The contractor shall furnish quarterly the statement showing quantity of quarried materials, from whom purchased (with full address of the seller) and copies of bills for purchase to the District Officer of the Mining and Geology Owner or authority competent to levy royalty in the area of wok. Copy of such statement shall be furnished to the Owner etc. Contractor shall also furnish such additional information as regards royalty payment to the Owner and the Royalty authority. The royalty charges paid shall be borne by the Contractor and shall not be reimbursed by the Owner.

Clause 44 Compensation under the workmen's compensation Act: The contractor shall be responsible for and shall pay compensation to his workman payable under the Workmen's Compensation Act 1923. (VIII of 1923) hereinafter called said Act for injuries caused to the workman. If Owner pays such compensation as principal under sub-section 12(1) of the said Act on behalf of the Contractor it shall be recoverable by Owner shall be recovered in the manner laid down in clause 1 above.

Clause 45 The contractor shall be responsible for and shall pay the expenses of providing medical aid to any workman who may suffer a bodily injury as a result of an accident. If Owner incurs such expenses, the same shall be recoverable from the contractor for with and be deducted, without prejudice to any other remedy of Owner from amount due or that may become due to the contractor.

Clause 46 The contractor shall provided all necessary personal safety equipment and first aid apparatus available for the use of the person employed on the site and shall maintain the same in suitable condition for immediate use at any time shall comply with the following regulations in connection therewith:

- (a) The workers shall be required to use the equipment so provided by the Contractor and Contractor shall take adequate steps to ensure proper use of the equipment by those concerned.
- (b) When work is carried on in approximate to any place where there is a risk of drowning all necessary equipment shall be provided and kept for use and all necessary steps shall be taken for the prompt rescue of any person, in danger.
- (c) Adequate provision shall be made for prompt first aid treatment of all injuries to be sustained during the course of the work.

Clause 47 The quantities shown in the tender are approximate and no claim shall Be entrained for quantities of work executed being less than being less than those entered in the tender. In the case of increase in the quantities by more than 10%. The new rate will be paid to the contractor for the quantities in excess of 10%. The rate for the increased quantities as aforesaid will be fixed in the manner specified in clause 17.

Clause 48 Employment of famine or other labour: The contractor shall employ any famine, convict or other labour or particular kind or class, if ordered in writing to do so by the Architect/Owner.

Clause 49 No compensation shall be allowed for any delay caused in the starting of the work on account of delay in making available the full site of land at a time.

Clause 50 Claim for compensation for delay in the execution of work: No claim for compensation shall be allowed for any delay in execution of the work on account of Water standing in borrows pits or compartment. The rates are inclusive of hard or cracked soil, excavation in mud, sub soil water or water standing in borrow-pits and no claim for an extra rate be entertained unless otherwise expressly specified.

Clause 51 Entering upon or commencing any portion or work: The contractor shall not enter upon or commence any portion or work except with the written authority and authority and instruction of the Architect/Owner or of his subordinate in charge of work. Failing such authoritys the Contractor shall have no claim to ask measurement of or payment for work.

Clause 52

Clause 53 The employment of donkeys and / or other animals and the payment of fair wages: For Asphalt work (s) as far as possible, only the contractors should employ the adult persons. If the adult person is not available then the children below the age of 15 (fifteen years) should not be employment under any circumstance.

- (ii) No contractor shall employ donkey or other animals with breaching of string or thin rope. The breaching must be at least three inches wide and should be of tape (Nawar)
- (iii) No animal suffering from sores, lameness or emaciation or which is immature shall be employed on the work.
- (iv) The Architect/Owner or his agent is authorized to remove from the work any person or animal found working which dose not satisfy theses conditions and Owner shall accept no responsibility for any delay caused in the completion work by such removal.
- (v) The Contractor shall pay fair and reasonable wages to the workman employed by him in the contract undertaken by him. In the event of dispute arising between contractor and his workmen on the ground that the wages paid are not fair and reasonable, the dispute shall be referred without delay to the Architect/Owner who shall decide the same. The decision be of the Architect/Owner shall be conclusive and binding on the Contractor, but such decision shall not in any way effect the conditions in the contract regarding the payment to be made by Owner at the sanctioned tender rates.
- (vi) The contractor shall provide drinking water facilities to the works / labourers employed on Owner works. Amenities relating to sanitation shall also be provided to the workers / labourers the Architect/Owner shall give notice writing and it the contractor does not provide this facility to the.

Workers / labourers within a period of ten days from the date of the notice writing, the Architect/Owner shall thereupon make the arrangement for drinking water at the cost of the contractor.

(vii) The contractor shall the amenity of proper shade and shelter to the work's/ labourers and their children on Owner work as soon as the work starts. It is contractor fail to provide shed and shelter; the Architect/Owner shall provide it at the cost of contractor.

Clause 54 Method of payment: Payment to contractor shall be made by cheque drawn on any treasury bank of the Owner provided the amount exceeds Rs.10 amount not exceeding Rs.10 will be paid in cash.

Clause 55 Employment of scarcity labour: If Owner declares a state of scarcity or famine to exist in any village situated within 16 kilometers of the work, the Contractor shall employ upon such parts of the works as are suitable for unskilled labour any person certified to him by the Architect/Owner or by any other person to whom the Architect/Owner may have delegated this duty in writing to be in need of relief and shall be bound to say such persons which may arise in connection, with the implementation of this clause shall be decided by the Architect/Owner whose decision shall be final and binding on the contractor.

Clause 56 The rates to be quoted by the Contractor must be inclusive of all taxes No Extra payment on this account will be made to the contractor.

Clause 57 The Contractor should, as far as possible, obtain his requirement of labourers skilled and unskilled, from the nearest Employment Exchange so as to utilize the local employment potential. If there are no local Employment Exchange or such Exchange are not able to provide the required labour locally, suitable labourers should be utilized to the maximum extent possible.

Clause 58 Fair Wages: If Contractor fails to pay within '7' (Seven) days to the labourer(s) /workers(s) the minimum wages prescribed by the Owner under the Minimum Wages Act, 1948 as in force from time to time, the Architect/Owner shall be at liberty to deduct the amount payable to the labourer/workers from his (Contractors) bill or deposit(s) payable by the Contractor after making due inquiries and establishing the claim(s) of the labourer(s) / worker(s).

The Contractor shall not be entitled to any payment of compensation on account of any loss that the contractor may have to incur on account of the action as aforesaid. Before the action as aforesaid, is enforced, a notice in writing to the contractor shall be issued by the Architect/Owner to pay the wages as per Minimum Wages Act in force at the relevant time, If Contractor dose not act as aforesaid within seven days, then the action contemplated as above shall be taken against him.

Clause 59 List of machinery: The contractor shall also give of machineries in his possession and which they propose to use on the work.

Clause 60 (i) In case, the roller deployed by Owner for the use on contract work is kept idle by the contractor for want of adequate labour and materials, the contractor will have to pay rental charges as per prevailing rules even though items of rolling and watering are to be carried out by the Owner.

(ii) If the contractor doses not plan his program so as to suit the requirement of the Owner, the proportionate rental charges on roller shall be recovered from the contractor.

Clause 61 Local labours on normal rates: The contractor shall have to engage local labour and person seeking employment where available on normal rate.

Clause 62 Rent will be recovered from the contractor for the land given to them for stacking materials well as for contractor of temporary hutments etc.

Land measuring Charges

1. One hectare of less	Rs.5 Per month
2. More than 1 hectare & up to 2 hectares	Rs.10 Per month
3. More than 2 hectare & up to 3 hectares	Rs.15 Per month
4. More than 1 hectare & up to 4 hectares	Rs.20 Per month

Clause 63 The contractor shall employ only such labour who shall produce a valid certificate of having been vaccinated against small-box within a period of last three years.

Clause 64 Huts: The contractor shall build sufficient number of huts on a suitable plot of land for use of the labourers according to the following specifications.

(1) Huts of bamboo's and grass may be constructed.

(2) A good site shall be selected. High ground removed from jungle but well provided with trees shall be chosen wherever it is available. The neighborhood of rank jungle, grass or weeds should particularly be avoided. Camps should not be established close to large cuttings of earthwork.

- (3) The lines of huts shall have open spaces of at least 10 m between rows. When a good natural site cannot be procured, particular attention should be given to the drainage.
 - (4) There should be no over-crowding. Floor spaces at the rate of 2.8 Sq. m. per head shall be provided. Care should be taken to see that the huts are kept clean and in good order.
 - (5) The contractor must find out his own land. If he wants Owner land, he should apply for it and pay assessment for it.
2. **Drinking Water:** The contractor shall as far as possible, provide an adequate supply of chlorinated pure potable drinking water for the use of labourers. This provision shall be at the rate of not less than 4.5 liters per head. No provision need-be made where there is a suitable nalla, river or well within 4.0 km of the camp. However arrangement should as possible, be made to chlorinate water by chlorinated tablets before it is allowed for drinking purpose.
 3. **The contractor shall contract semi permanent latrines for the use of Labourers on the following scale, namely:**
 - (a) Where females are employed, there shall be at least one latrine for every 25 females
 - (b) Where males are employed, there shall be at least one latrine for every 25 males.
Provided that where the number of males or female exceed 100, it shall be sufficient if there is one latrine for every 25 males or females, as the case may be up to the first 100 and one for every 50 thereafter.
 4. **Privacy in latrines:** Every latrine shall be under cover and so partitioned off as secure privacy, and shall have a proper door and fastenings.
 5. **Notice to be displayed outside latrines and urinals:** (1) where workers of both sexes are employed there shall be displayed outside each block of latrine and urinal a notice in the language understood by the majority of the workers For Men Only or For Women Only: as the case may be.
5(2) The notice shall also bear the figures of a man or a women, as the case may be.
 6. **Urinals:** There shall be at least one urinal for male/female workers up to 50 employed at a time provided that where the number of male or female workmen, as the case may, be exceeds 500, it shall be sufficient if there is one urinal for every 50 males or females up to the first 500 and one for every 100 males or females or part thereof.
 7. **Latrines and Urinal to be accessible:** (1) The latrines and urinals shall be a conveniently situated and accessible to workers at all times at the establishment (2) (i) The latrines and urinals shall be adequately lighted and shall be maintained in a clean and sanitary condition at all times (ii) Latrines and urinals other than those connected with a flush sewage system shall comply with, the requirements of the Public Health Authorities.
 8. **Water for latrines to be accessible:** Water shall be provided by means of pipes or tanks otherwise so also be conveniently accessible in or near the latrines and urinals.
 9. **Bathing and washing places:** (1) The contractor shall construct sufficient number of bathing places; every unit of 20 persons being provided with a separate bathing place. (2) Washing places should also be provided for the purposes of washing clothes. Every unit of 30 persons shall have at least one washing place. (3) Such bathing and washing places should be suitably screened and separate places provided for male and female workers. (4) Such facilities shall be conveniently accessible and shall be kept in clean and hygienic condition.
 10. **Drainage:** The contractor shall make sufficient arrangement for draining away the sewerage water as well as water from the bathing and washing places and shall dispose off this water in such a way as not to cause nuisance. The contractor should obtain permission from the Gujarat Water Pollution Control Board, Gandhinagar if water is so be drained in river or near the well. The contractor would put malarial oil once in week stagnant water round about in the residence.
 11. **Medical facilities:** The contractor shall engage a medical officer with a traveling dispensary for a camp having 500 or more persons if there is no Government's or other private dispensary situated within 6 km. from the camp.
 12. **Conservancy and cleanliness:** The contractor shall provide the necessary staff for effecting the satisfactory conservancy and cleanliness of the camp to the satisfaction of the Architect/Owner. At least one sweeper per 200 persons should be engaged Conservancy staff should dump refuse in compost pit, away from the labour camp.

- 13. Health Provisions:** The District Health Officer of the District or the Deputy of Health Services shall be consulted before opening a labour camp and his instructions, on matters, such as the water supply, sanitary convenience, the camp-site, accommodation and food supply shall be followed by the contractor.
- 14. Precautions against epidemic:** (a) The authorities in charge of the colonies should get the labourers inoculated against cholera and plague and vaccinated against smallpox at the time or recruitment, if they are not inoculated or vaccinated within 6 months or 3 years respectively prior to the date of recruitment.
- (b) When, in any labour camp there is an epidemic disease or threatened with such an outbreak, the authorities in charge of the labour camp should ensure that all the inmates of the labour colonies are inoculated or vaccinated as the case may be depending on the diseases, within 72 hours after the outbreak.
- (c) The authorities in charge of the labour colony should arrange to communicate by wire regarding the outbreak of the epidemic diseases on the very day of outbreak, to the Mamlatadar of the Taluka the District Health officer or to the Deputy Director Public Health in charge of that area and the Director of Public Health. Thereafter they should continue to send daily reports to the above officers in the prescribed form regarding the progress of the epidemic disease.
- (d) When the authorities in charge of the labour colony suspect or have reason to believe that any inmate of the labour colony suffering from the infections or contagious disease, they shall forthwith arrange for the segregation of such person to isolated huts to be specifically provided for the purpose and also for their treatment.
- (e) As regional malaria epidemic outbreaks are likely to occur in such project areas, the authorities in charge of the labour colony should report promptly the occurrence unusual incidence of cases of malaria and also inform the District Health Officers of the District Deputy Director of Public Health (Malaria) and the Director of Public Health and also arrange to institute all necessary ant malarial measures as may be advised by the officials of the Public Health Owner.
- (f) The authorities in charge of the colonies should also arrange to carry out other measures that may be recommended by the officials of the Public Health Owner necessary to prevent or control the spread of disease.
- 15. Rest rooms:** (1) In every place where in contract labour is required to halt at night in connection with the contract works and in which employment of contract labour is likely to continue for three months or more, the contractor shall provide and maintain rest rooms or other suitable alternative accommodation within fifteen days of the employment of contract labour.
- (2) If the amenity referred to in sub rules is not provided by the contractor within the period prescribed the employed shall provide the same within a period of fifteen days of the expiry of the period laid down in the sub-rule (1)
- (3) Separate rooms shall be provided for women employees.
- (4) Effective and suitable provision shall be made in every rooms for securing and maintaining adequate ventilation for the circulation of fresh air and there shall also be provided and maintained sufficient and suitable natural or artificial lighting.
- (5) The rest rooms or other suitable alternative accommodation shall be of such dimensions as to provide latest a floor area or 1 sq. mt. for each person making use of rest rooms.
- (6) The rest rooms or other suitable alternative accommodation shall be so contracted as to afford adequate protection against heat, wind, rain and shall have smooth, hard and impervious surface.
- (7) The rest rooms or other suitable alternative accommodation shall be at convenient distance from the establishment and shall have adequate supply of wholesome drinking water.
- 16. Canteen Facilities:** (1) In every establishment of contact work and wherein work regarding the employment of contract labour is likely to continue for six months and wherein contract labour numbering one hundred or more are ordinarily employed, the adequate canteen facilities shall be provided by the contractor for the use of such contract labour within sixty days of the commencement of contract labour.
- (2) If the contractor fails to provide the canteen facilities of within time laid down the same shall be provided the principal employer within sixty days of the time allowed to the contractor.
- (3) The canteen shall be made by the contractor or principal employees as the case may be in an efficient manner.
- 17. Accommodation in canteen:** (1) The canteen shall consist of at least dining hall, kitchen storeroom, pantry and washing places separately for workers and for utensils.
- (2) (i) The floor shall be made of smooth and impervious materials and inside walls shall lime-washed or color washed at least once in each year, provided that inside walls of the kitchen shall be lime-washed every four months.
- (3) (i) The premises of the canteen shall be maintained in clean and sanitary condition.
- (ii) Wastewater shall be carried away in suitable covered drains and shall not allowed to accumulate so as cause nuisance.

(iii) Suitable arrangements shall be made for collection and disposal of garbage.

18. Accommodation in dining hall: (1) The dining hall accommodates at a time, at least 30% of the contract labour working at a time.

(2) The floor area of the dining hall excluding the area occupied per dinner to a accommodated shall as prescribed in sub rule (1)

(3) (i) A portion of the dining hall and service counter hall be partitioned and reserved for women workers, in proportion to their numbers (ii) Washing places for women shall be separate and screened to secure privacy.

(4) Sufficient table, stools, or benches shall be available for number of diners of be accommodated as prescribed in sub rule (1)

19. Equipment in Canteen:

(1) (i) There shall be provided and maintained sufficient utensils, crockery cutlery, furniture and any other equipment necessary for the efficient running of the canteen.

(ii) The furniture utensils and other equipment shall be maintained in a clean and hygienic condition.

(2) (i) Suitable clean clothes for the employees serving in the canteen shall also be provided and maintained.

(ii) A service counter, if provided, shall have a top of smooth and impervious materials.

(iii) Suitable facilities including adequate supply of hot water shall be provided for the cleaning of utensils and equipment.

20. Foodstuff to be served: The foodstuff and other items to be served in the canteen shall be in conformity with the normal food habits of the contract labour.

21. Prices to be displayed: The charges for foodstuff, beverages and other items served in the canteen shall be based on "no profit, no loss" and shall be conspicuously displayed in the canteen.

22. Canteen to be run on "No profit no loss" basis: in deriving the prices of food stuffs and other articles served in the canteen, the following items shall not be taken into consideration as expenditure, namely.

(a) The rent for the land and building

(b) The depreciation and maintenance charges for the building and equipment provided for in the canteen.

(c) The cost of purchase, repairs and replacement of equipment including furniture, crockery, cutlery and utensils.

(d) The water charges and other charges incurred for lighting and ventilation.

(e) The interest on the amount spent on the provisions and maintenance of furniture and equipment provided for in the canteen.

The local officers should check up whether, facilities as offered and which are admissible under the existing rules and orders are made available to the workers and enforce upon the contractors the necessity of adhering to the instructions from promotion of welfare of the workers according to the terms of the contract.

23. Books of accounts and registers of the canteen: The books of accounts and registers and other documents used in connection with the running of the canteen hall are produced on demand to an inspector.

24. Audit of the Accounts of the canteen: The accounts pertaining to the canteen shall be audited once every 12 months by registered accountants and auditors, provided that Labour Commissioner may approve of any other person to audit the accounts. If he is satisfied that it is not feasible to appoint a registered accountant and auditor in view of the site or the location of the canteen.

Clause 65 Contractor shall have to arrange for supply of gumboots. Hand gloves, mask etc. Invariably to the labourers/ workers engaged the contractor on asphalt work.

Clause 66 The contractor shall not show any distinction between Harijan and other class of labourers/workers employed to the carry out the work.

Clause 67 Price variation Clause: Price variation: For (A) Labour (B) Materials and (C) P.O.L The amount payable to the Contractor for the work done shall be adjusted for increase or decrease in the rates of labour/materials excepting those materials supplied by Owner as per Schedule A and P.O.L. as under:

(A) Labour: Increase or decrease in the cost due to labour shall be calculated quarterly in accordance with the following formula.

$$VI = 0.75 \times \left\{ \frac{PI \times R \times i - io}{100 \quad io} \right\}$$

DELETED

VI = Increase or decrease in the cost of work during the during the quarter under consideration due to change in rates of labour.

R = The value of work done in rupees during the quarter under consideration, after excluding the value of extra item and after deducting the cost of.

- (i) Materials supplied from the Owner store to the Contractor at fixed rate as specified in schedule A and
- (ii) Value of cement and steel brought by the contractor valued at star rate plus the increases / decrease for which price adjustment is done under sub-clause (B-2) below:

io = The average consumer price index for industrial workers for the quarter in which tenders were opened (as published in * ...)

i = The average consumer price index for industrials for the quarter under consideration.

PI = Percentage of labour components (specified in Schedule...)

* This refers to average consumers price index (Wholesale) for industries workers as applicable to Ahmedabad / Bhavnagar as published by Owner of India. Ministry of Labour Bureau.

* **(B) Materials other than Cement and steel and asphalt:** The increase or decrease in cost of materials other than cement and steel shall be calculated quarterly in accordance with the following formula.

$$V_m = 0.75 \times \left\{ \frac{PI \times R \times i - i_o}{100 - i_o} \right\}$$

(ii) Value of cement and steel brought by the contractor valued at star plus the increase/decrease for which price adjustment is done under the clause below.

io = The average wholesale price index (all commodities) for the quarter in which tenders were opened. (as published in @...)

i = The average wholesale price Index (all commodities) for the quarter under consideration.

Pm = Percentage of materials components (specified in schedule) of items

@ = For materials wholesale price index as published by Reserve Bank of India should be referred to

(C) P.O.L.: The increase or decrease in the cost of petrol, diesel, oil and lubricants shall be calculated quarterly in accordance with the following formula.

$$V_d = 0.75 \times \left\{ \frac{P_d \times R \times (D - D_o)}{100 - D_o} \right\}$$

Vd = Increase or decrease in the cost of work during the quarter under consideration (ii) Value

of cement steel brought by the contractor valued at star plus the increase/decrease for which price adjustment is done under sub clause above: -

Do = The average price of high-speed diesel (HSD) fixed by I.O.C. for the district which the work is to be carried out for the quarter in which the tenders were opened.

D = The average price of HSD fixed by the I.O.C. for the district in which the work is to be carried out the quarter under consideration.

Pd = Percentage of P.O.L Component (specified in schedule) of the item.

Conditions except for B-2 Formula:

- (1) No adjustment shall be done for the work done in the first twelve months of the limit. Adjustment payable/ recoverable will be calculated for the remaining work done during the subsequent period.
- (2) The sum total price adjustment will be limited to ... % of the subsequent period. Less the cost at cement and steel valued at input rates mentioned as under on which the sanctioned estimated is based.

QUANTITY

Input rate per ton

Cement: _____ Mts. Rs. _____
 Mild Steel: _____ Mts. Rs. _____
 HYSB Bars: _____

- (3) The quarter referred to in the above formula shall mean the quarter of the calendar year January to March, April to June, to September and October to December, Even is the tenders are opened in the middle of a quarter, the average index for the calendar quarter will be considered. The same principle would apply for identifying the quarter when the work is completed in the middle of calendar quarter.
- (4) The value of extra items will be excluded for working out the value of 'R' in the above formula in all these cases.

- (5) Intermediate payment of escalation to be made under this clause on each occasion shall be limited in such a manner that the up-to-date payment of escalation will not exceed the proportionate percentage of the ceiling of escalation as related to the proportionate value of the contract cost.
- (6) Price adjustment shall be applicable only for work that is carried out within the stipulated time or extensions thereof as are not attributable of the contractor. No claims for price adjustment other than those provided herein shall be entertained.
- (7) This clause will be applicable in respect of which of the estimated cost put to tender is above Rs.25.00 lacs and the time limit involved in more than 12 months.

STAR RATES

QUANTITY

Cement Rs. _____ Mt.
 Mild Steel Rs. _____ Mt.
 HYSD Steel Rs. _____ Mt.

[The above star rates are linked with Reserve Bank of India price index for steel and cement for the month in which the DTPs are approved. The rate for asphalt will be based on the rate of Koyli Refinery prevailing in the month in which the estimate is prepared.

The month in which DTPs are approved will be specified in the tender document.

Star rates should be mentioned in the tender copy as under:

- I. For Cement, Price of cement from authorized dealer should be obtained for the month in which the D.T.P.s are approved and mentioned as star rate before issue of tender copy.
- II. For steel & H.Y.S.D. bars, rate of SAIL should be obtained for the month in which the DTPs are approved and mentioned as star rate before issue of tender copy.
- III. For basic index specific month in which the DTPs are approved should be mentioned before issue of tender copy]

The fluctuations in rates of cement and steel shall be adjusted in the bills payable to the constrictors as under:

$$A = B \times \left\{ \frac{CI - 1}{Co} \right\} \times D$$

A= Difference of Amount payable or recoverable
 B= Star rate of steel/cement

CI- The (Quarterly) average corresponding index for steel cement for the quarter under consideration (as published in monthly bulletin for Reserve Bank of India)

Co- Price index of cement/steel for the month in which the DTPs are approved published in monthly bulletin of Reserve Bank of India).

D- Qty. of cement/steel actually brought by the contra (for on site of work and consumed in the work during the quarter duly supported bill as recorded in cement consumption register or MB (for steel)

Conditions for variation in prices of cement and steel only: -

- 1 No Ceiling for escalation for difference in the cost of steel and cement will be applicable.
- 2 This clause shall be operative from the date of issue of work order and up to expire of original and extended time limit.
- 3 This formula shall be used individually for cement/mild steel and Tor steel for calculating adjustment.
- 4 The cement and steel brought by the contractor on site of work shall be used only after the Owner tests the same is tested by the owner.
- 5 If such materials are not found, as per the requirement of I.S. specification, the contractor for which no claim shall be entertained shall remove the same.
- 6 This clause will be applied to the work estimated to cost above Rs.15 lacs. And the time limit involved is more than 12. Months.

Conditions for variation in rates of asphalt only: -

1. The contractor shall purchase asphalt directly from the refinery or oil Company only.
2. The contractor will not be furnished "P" from for purchase of quantity of asphalt required for this work. The contractor will have to produce in original all the gate passes issued by the refinery and also the bill in original to the Architect/Owner.
3. The contractor shall furnish the GERI Laboratory or other Laboratory approved by R & B Department shall have to be produced.
4. The difference between two actual rates of purchase as per original bill of the refinery produced and the star rate as indicated below for the quantity of asphalt actually used in the work during original time limit only will be paid/ recovered after the asphalt is consumed in said part of work. No escalation for the works estimated to cost up to 15 Lacks and involving use of asphalt will be payable.
 Star rate per MT Rs. _____ Rupees _____
6. The difference will be payable/recoverable from the date of issue of work order and this price variation will not be subject to any ceiling.

7. No advance payment or secured Advance will be payable against asphalt.
8. This part of clause for price variation of asphalt will be applicable for works estimated to cost above Rs. 15 Lacks and involving use of asphalt.

Clause 68 FENCING AND LIGHTING:

- (a) The contractor shall unless otherwise specified, be responsible for the proper fencing lighting grading and taking of the necessary safety measures for all works comprised in the contract and for the proper provision of temporary road, way foot-way, guards, fences, caution notices etc. as far as the same may be tendered necessary by reasons of the work for the accommodation of foot passengers or other traffic and of Owners and occupiers of adjacent property and the public and shall remain responsible for any accidents that any occur on account of his failure to take proper & timely precautions.
- (b) All the arrangements made for fencing and lighting shall be maintained by the contractor through the currency of the contract till the physical taking over of the work by Owner.

Clause 69 LIABILITIES OF ACCIDENTS TO PERSONS:

Responsibilities and liabilities of the contractor under Worker's Compensation Act are given in clause No.44 in addition following shall also apply: (a) On the occurrence of an accident, which result in death of workmen employed by the contractor or which is so serious as likely to result in death of any such workmen the contractor, shall within 24 hours of happening of such accident (s) intimate, in writing to the Architect/Owner the fact of such accident(s). The contractor shall indemnify Owner against all loss or damage sustained by the Owner resulting directly or indirectly from his failures to give intimation in the manner aforesaid including the penalties or fines, if any, payable by the Owner as a consequence of Owners failure to give notice under the Workmen's Compensation Act or otherwise to conform to the provisions of the said act in regard to such accident(s).

(b) In the case of an accident, in respect of which compensation may become payable under Workmen's Compensation Act, whether by the contractor or by the Owner as principal Employer, it shall be lawful for the Architect/Owner to retain out of money due and payable to the Contractor, such sum or sum of money as may, in the opinion of the Architect/Owner, be sufficient to meet such a liability. The opinion of the Architect/Owner shall be final in regard to all matters arising under this clause.

Clause 70 ACCESS TO SITE AND WORK IN SITE: The Engineer may, if he considers fit from to time, enter upon any land (s) which may be in possession of the contractor this contract for the purpose of agent or by other contractors, at his opinion and the contractor shall in accordance with the requirements of the Architect/Owner afford all reasonable facilities for execution of the work including occupation of lands by structure of otherwise for any other contractor employed by the site of work Owner and his workmen or for the workman of the Owner who may be employed in the execution on or near the site of the work not included in the contract or of any contract in connection with or ancillary to the work and in default, the contractor shall be liable to the Owner for any delay or expenses incurred by reason of such default, Provided always that if damage arising make a statement of the same to the Architect/Owner who shall from time assess the value in his judgment of such damage and the Owner shall from time to time pay to the contractor the amount (if any) accepted as justified by the Architect/Owner.

Clause 71 REPORTS REGARDING LABOUR:

The contractor shall submit the following reports to the Architect/Owner:

- (a)(i) A daily report in the suitable form of the strength of labour, both skilled and unskilled employed by him on the work(s). The contractor shall increase or decrease the strength both skilled and unskilled. If directed by the Architect/Owner. The submission of such reports shall not, however, relieve the contractor of his responsibilities and duties regarding progress or any obligations under the contract.
- (ii) A classified weekly returns in suitable form of the number of person employed on the works during the proceeding week.
- (iii) A weekly medical report in the suitable form showing the health of the contractor's camp, the number of person's ill incapacitated and the nature of their illness.
- (iv) A report of any accident, which may have occurred to be sent within 24 hours of occurrence.
- (v) Such other report as may be prescribed.

Clause 72 Treasure Trove:

In the event of discovery by the contractor or his employees, during the progress of work of any gold, silver, oil or other minerals of any description and precious stones, treasures, coils, quantities, relic, fossils or other articles or value of interest whether geological archaeological or any other such treasure & other things shall be deemed to be the absolute property of the Owner and the contractor shall duly preserve the same to the satisfaction of the Architect/Owner from time and relieve the same such person as the Architect/Owner may appoint.

The contractor shall take all reasonable precautions to prevent his workmen or any other person from removing or damaging any such articles or things, immediately after the discovery thereof and before removed acquaint the Architect/Owner with such discovery and carry out his orders for the disposal of the same.

Clause 73 Indemnity:

The contractor shall indemnify the Owner against all actions, suits claims & demands through or made against the Owner in respect of work of this contractor against any loss damage to Owner in consequences of any action or suit being brought against the contractor anything done or omitted to be done in execution of the work of this contract.

Clause 74 Insurance of Labours:

The contractor shall be responsible to arrange for insurance of all labourers, skilled and unskilled workers, and supervisors' etc. employed by him as per labour regulation of the state.

Clause 75 Setting out:

The contractor shall be responsible for the true and proper setting out of the works and the correctness of positions, levels, dimensions and alignments of all parts of the work and for the provisions all necessary instruments, appliance and labour in connection therewith, if at any time during the progress of the work, any errors, appear or arise in the position, levels, dimensions or alignment of any part of the work, the contractor, on being required to rectify such errors by the Architect/Owner shall at his own expense do so to the satisfaction of the Architect/Owner. If however, such error is based on incorrect data supplied in writing by the Architect/Owner: the expenses of rectifying the same shall be borne by the Owner. The checking of and setting out of any line or level by the Architect/Owner or his representative shall not in any, way, relieve the contractor of his responsibilities for the correctness of the error. The contractor shall carefully protect and observe all benchmarks site nails, page and other things used in setting out of the work

Clause 76 Cement Register:

A register in the prescribed from showing day-to-day receipt, consumption and balance of cement on site of work will be maintained by the Owner, which shall invariable be signed daily by the contractor or his authorized representative in token of its correctness.

Clause 77 Materials and Works Test Register:

A register in the prescribed perform showing day to day receipt consumption and balance of cement on the site of work by the contractor and every entry there of shall invariable be checked by the Architect/Owner.

Clause 78 Progress Schedule:

(a) The contractor shall furnish within one month (unless extended by Architect/Owner) of the order to start the work, the progress schedule in quadruplicate indicting the date of starting, the monthly progress expected to be achieved and the anticipated Completion date of each major item of work to be done by him also indicting dates of procurement and setting up the materials plants and machinery. The schedule should include a statement of proposed general and detailed arrangements for carrying out works, and of item, order and manner in which it is proposed general and detailed arrangements for carrying out works, and of item order and manner in which it is proposed that these shall be executed. The schedule should be framed keeping requirement of the clause 2 of tender from in view and be such as in practice to the achievement towards completion of the work in the time limit and of the particular items on the dates specified in the contract and shall have the approval of Architect/Owner. Further, the dates for the progress, as in this schedule shall be adhered to.

In case it is found necessary, at any stage to alter the schedule, the contractor shall submit in good. Time a revised schedule incorporating necessary modification proposed and get same approved from the Architect/Owner. No revised schedule shall be operative without such acceptance in writing. The Architect/Owner is further empowered to ask for more detailed schedules. Any week-by-week for any item or items and the contractor shall, supply the same as and when asked for.

(b) The Architect/Owner shall have, at all times, the right without in any way vitiating this contract forming grounds for any claim, to alter the order of the work of any part there of and the contractor shall after receiving such direction, proceed in the order direct. The contractor shall also revise the progress, schedules accordingly and submit four copies of the revised schedule to the Architect/Owner within seven days of the said Engineer's direction to alter the order of works.

(c) The contractor shall furnish sufficient plant. Equipment and labour and shall work such hours and shifts as may be necessary to maintain the progress of the work as per approved progress schedule. The working and shift hour shall comply with all the Owner regulations in force shall be such as

may be approved by the Architect/Owner and the same not be varied without the prior approval of Architect/Owner.

- (d) The contractor shall from time to time, as may be required by the Architect/Owner. Furnish the Architect/Owner with a statement in writing of the arrangements he proposes to adopt for the execution of this contract and the Architect/Owner may, if he considers necessary at any time advise alternation in the same, which the contractor shall adopt on notice thereof.
- (e) The progress schedule(s) shall be in the form of progress chart, forms, statements and/or reports as may be approved by the Architect/Owner.
The contractor shall submit four copies showing the progress of the work in the form of a chart etc. at periodical intervals as may be specified by Architect/Owner.
- (f) The approval of the progress schedules by Architect/Owner shall not relieve the contractor of the Schedule required by the Architect/Owner shall not entitle the contractor to any extra payment.

Clause 79 Secured Advance to Contractor:

- (1) Before any secured advance for metal is paid to the contractor, the metal shall have to be tested for its quality in the laboratory. Contractor's request for such secured advance will be considered only after test results of metals are received and results are satisfactory.
- (2) Advance on security of materials brought to site will not exceed 75% of the value (as assessed by the Architect/Owner) of such materials provided that they are of imperishable nature.
- (3) Recovery of advances will not be postponed until the whole of the work entrusted is completed. Secured advance will be recovered within 3 months from the month in which secured advance is given.
- (4) Secured advance is permissible on materials, which are all actually brought on site and are required by the contractor for use on items of works for which rates for finished work have been agreed upon.
- (5) Secured advance will be given only on materials for which the contractor pays the full value to the seller.

Clause 80 Advance Payment: Advance Payment for the work done, but not Measured, may be made up to 80% of the approximate value work done as shown in the progress reports of approximate measurement Sheets with location furnished by Architect/Owner subject to the following conditions: -

- (1) That in the case of advance payment on the item of earthwork payment should be made on the basis of detailed measurements except during the monsoon period (June to September).
- (2) That the detailed measurement should be recorded within the month from the date of payment of the bill incorporating the advance payment. However in the case of sectional measurements of earthwork, detailed measurements should be recorded within their months instead of one month stipulated above.
- (3) If, on recording of the detailed measurements, it is found that advance payment shall be refunded forthwith by the contractor or demand, if it cannot be adjusted from the bill in which the item/s on which advance payment was given are recorded by measurements.

Clause 81 Advance Against Machineries:

- 1. Secured advance on plants and machinery's brought to the site of work is admissible for the contracts estimated to cost more than Rs. Ten Lacks.
- 2. Simple interest in such advances granted to contractor against plants and machinery's brought to work sites be charged at the rate of ...% per annum.
- 3. The recovery of the advance shall be effected from the second month in which advance is given and full recovery will be effected by the time seventy five percent of scheduled time is completed.
- 4. Such advance will be limited to 5 percent of the estimated amount put to tender.
- 5. The advance will be limited to 5 percent actually brought to the work.
- 6. The machinery and equipment on which the advance is granted shall be of full undisputed Ownership of the contractor, and they shall be hypothecated to Owner and also comprehensively insured till the advance granted is fully recovered. The hypothecation deed shall be executed separately before the advance is actually given.
- 7. The advance will be granted as 75 percent of the cost of new equipment for which the contractor is able to produce purchase-voucher and other documents. This will not be applicable in the case second-hand equipment purchased by the contractor.
- 8. In the case of used or second-hand equipment brought by the contractor, advance will be allowed at 50 percent of the value of the equipment arrived at in following manner:-
 - (a) For used equipment, for which the records of original purchase price and utilization are available, depreciated value, so worked out.
 - (b) For used equipment, for which proper records of purchase price and past utilization are not available, approved valuer will assess the value. The value assessed will be based on the probable age of the equipment, its present condition and its probable depreciated value, in working out depreciation age of the equipment, its present condition and probable Owner of spares, repair, reconditioning of the equipment's shall not be taken into account towards the capital cost. The value arrived at by the will approved valuer will be final.
- 9. No. Advance may be allowed for equipment which is more than 8 years old or which has already worked for more than 80 percent of its life.

10. No. Advance shall be given to transport-vehicles like jeeps, station-wagons, estate-car and such other vehicle ordinarily required for transport purposes.
11. The recovery will have to be completed within the stipulated period of completion of work i.e. _____ months

Clause 82 Mobilization Advance:

1. Mobilization advance to the extent of 5% of the estimated cost may be granted at the commencement of the work after the contractor has set up camp on site has brought machinery equipment and centering etc., for well-sinking and has completed the work of service road, water-supply and lighting arrangements on the site of works which are estimated to cost over Rs.40 lacks.
2. The advance will carry a simple interest at the rate of _____ % Per annum.
3. The recovery of advance shall commence from the sixth month from the month in which the advance is paid and full recovery of advance and interest shall be completed by the end of _____ month from the date of issue of the work order, in other words, ~~the recovery of advance~~ and interest will spread over a spell of ...months or less a above in equal installments.
4. A bank guarantee from a schedule commercial bank shall have to be produced for the amount of advance applied for; the back guarantee can be scaled down to the extent of recovery of advances.
5. Mobilization advance will be treated as interest bearing refundable loan for purpose. The responsibility of the Contractor for the refund of Mobilization Advance is absolute and not dependent upon the completion of the work. The contractor will have to refund the advance with accrued interest irrespective of the fact whether either party of abandoned or finalized prematurely breaches the contract.

Clause 83 Before starting the work, the contractor will have to obtain the license from the District Assistant Labour Commissioner under the Contract Labour (Regulation and Abolition) Act, 1970 and contract Labour (Regulation and Abolition) Gujarat rules 1972 after paying necessary fees and deposit on the basis of the number of labourers to be employed on the work and will have to supply two true copies of the said license to the Deputy Executive Engineer before the work is started.

Clause 84 One percent of estimated cost put to tender for this work after deducting the cost of materials as per Schedule 'A' valued at basic rate in the sanctioned estimate shall be deducted from the running account bills of the contractor for testing the quality of materials and workmanship, no additional testing charges in addition to the above shall be recovered from the contractor.

However in respect of work involving use of asphalt, the contractor will set up the site testing Laboratory and will provide testing instruments etc. as under:

Laboratory: The contractor will construct pucca structure of minimum 25 square meter area duly connected with water and electric supply to house site testing Laboratory.

Instruments: The contractor will provide and install the instruments as per following I.S. Standard to carry out the test prescribes therein.

1. Penetration test as per I.S. 1203.
2. Softening point test as per I.S. 1204.
3. Ductility test as per I.S. 1208
4. Viscosity test as per I.S. 1206.
5. Specification gravity test as per I.S. 1202.

The instruments provided should be as per I.S. Standard, so certified and be regularly and periodically calibrated.

Frequency of tests will be as indicated in specifications and as referred in R. & B. D. G. R. No. SSR – 1099 – IB/91 (9) – C dated 26-7-1999.

Annexures: - The information in the following annexures specimens should be furnished on separate letter pad if necessary

Annexure 1

To,
Executive Engineer
Building Department,
Bhavnagar Municipal Corporation
_____Bhavnagar

DATE:

PLACE:

Details regarding my/our partners our Company (in the case of limited Company) Names, address (es), telephone numbers(s) Income Tax No etc. are as under:

Sr. No.	Names(s) of Person/ Partner Director of the company	Full address of the Places of business (with pin code)	Telephone No. (s) (office)	Residential Address(es)	Telephone No. (s) Resi.	Full address of income tax Office ward where income tax return is filed
1	2	3	4	5	6	7

I/We hereby agree to intimate to you about change if any, in the above mentioned address (es) and telephone No. (s) within Fifteen days of its occurrence till my/our deposit, for the said work paid by me/us is not returned to me/us.

Dated Signature of Tenderer

Annexure 3

PERFORMANCE BOND

(SEE CLAUSE NO. 1)

(The date of this bond must not be prior to the date of the instrument in connection with which it is given).

.....Principal (Contractor)
.....Surety (Bank)

Sum of Bond (express in words and figures)

Contract No. and date of contract

KNOW ALL MEN BY THESE PRESENTS, THAT WE, THE PRINCIPALS AND SURETY above named are held and firmly bound up to the hereinafter called the Employer in the amount stated for payment of which sum, well and truly to be made, we bind ourselves, our heirs, executors, administrators and successors jointly and severally, firmly by these presents subject to the provisions of which the aforesaid Contractor on demand and without demand on a claim being made by the employer.

THE CONDITION OF THIS OBLIGATION IS SUCH that whereas the principals have entered in to a contract with the Employer numbered and dates as shown above and hereto attached for the execution of work

NOW THEREFORE, if the Principal shall well and truly perform and fulfill all the undertakings, covenants, terms, conditions and agreements of said contract during the original terms of the said contract and any extensions thereof that extensions thereof that may be granted by the Employer with or without notice to the surety and during the life or any guarantee required under the contract and shall also well and truly perform and fulfill all the undertakings, covenants, terms, conditions and agreements of any all duty and unduly authorized modifications of said contract may hereafter be made, notice of which modifications to the surety being hereby waived or shall pay over, make good and reimburse to the Employer all loss and damages which the employer may sustain by reason of failure or default on the part of said Principal so to do. We further agree that the guarantee herein Contained shall remain in full force and effect during the period that would be taken for the validity of the said Contract, and that it shall continue to be enforceable till all the dues of the employer under or by virtue of the Contract have been fully paid and its claims satisfied or discharged or till the Employer certifies that the terms and conditions of the Contract have been fully and properly carried out by the said Contractor and accordingly discharges the guarantee. Unless a demand or claim under this guarantee is made on us in writing on or before the we shall be discharged from all liability under this guarantee thereafter.

IN WITNESS WHERE OF, the above bounded parties have executed this instrument under their several seals on the date indicated above the name and corporate seal of each corporate party being hereto affixed and these presents duly signed by its undersigned by its undersigned representatives, pursuant to authority of its governing body.

In the presence of witness
Principal

1. as to(seal)
 2. as to(seal)
 3. as to(seal)
 4. as to(seal)
- by Affix Corporate Seal

Attested

Corporate surety

Business Address _____

Affix by corporate Seal

Title

For and on behalf of the Employer

Annexure 4

LIST OF WORKS ALREADY COMPLETED BY TENDERER

Sr. No.	Name of work	Place	Cost On completion	Time taken in months To complete the work	Remarks
1	2(a)	2(b)	3	4	5

* Necessary certificate from the officer concerned shall be attached with the tender.

Annexure 5

LIST OF PLANT AND MACHINERY IN GOOD WORKING ORDER AVAILABLE WITH THE TENDERER

Sr. No.	Plant or Machinery	Location	Age of Machinery	Make.	Capacity	Approximate Value	Remarks
1	2(a)	2(b)	3	4	5	6	7

* Necessary certificate from the officer concerned shall be attached with the tender.

Tender Sign of

Annexure 6

DECLARATION REGARDING WORKS ON HAND WITH TENDERER

Sr. No.	Name of work	Place	Estimated Cost	Date of issue of work order	Stipulated period of completion	Amount of work done on date of filling tender	Brief detail of delay if any	Remarks
1	2(a)	2(b)	3	4	5	6	7	8

* Size of Tender
Signature of Tenderer with Date

Note 1: Amount of work in column 6 should be given the month previous to the month in which tenders are invited.

* Necessary certificate from the officer concerned shall be attached with the tender.

SCHEDULE 'A'

Schedule showing (approximate) the materials to be supplied from the store for work contracted to be executed and the rates at which at which they are to be charged for

Particulars	Approximate Quantity	Rate of which the materials will be charged to the contractor		Place of delivery
1	2	Unit	Rate in Rupees	5
		3	4	

--	--	--	--	--

SCHEDULE – ‘B’

Memorandum showing items of works to be carried out

Items No.	Quantities estimated but may be more or less	Item of work	Estimated Rates		Unit	Total Amount according to estimated quantities
			In figure	Inwards		
1	2(a)	2(b)	3	4	5	6
	As per attached sheet					

I/We am/are willing to carry out the work at ...% above/below percent (should be written in figures and words) of the estimated rates mentioned above. Amount of my/our tender works out as under.

*Estimated amount Put to tender Rs. ... Add: ...% above Rs. ... Total Rs. ... In words	*Estimated amount Put to tender Rs.... Deduct ...% below Rs.... Net In words...	*Estimated amount Put to tender Rs.... Deduct ...% below Rs.... Net In words...
---	---	---

(Please strike out whichever is not applicable)

- Note: 1 All work shall be carried out as per Public Works Owner Handbook and other standard specification or as directed.
- Note: 2 All the column is Schedule be filled in ink and the total of the entries in the last column should be struck by the contractor under his signature.
- Note: 3 Rates quoted include clearance of site (prior commencement of work and at its close) in all respect and hold good for work under all condition, site, moisture, weather etc.
- Note: 4 to be continued on additional sheets, if found necessary.

SCHEDULE – ‘C’

Time Schedule, for completion of different designate parts of the work and rte of liquidated damage of be paid by the Contractor, if he fails to complete the part of work within stipulated the limit it as detailed above:

Percentage of time of the total time limit	Time schedule of completion percentage of work	Rate of liquidated damages per day
1	2	3

<u>Earth Work</u> 25% 50% 75% 100%	16% 50% 75% 100%	0.1% 0.1% 0.1% 0.1%
<u>Buildings Works</u> 25% 50% 75% 100%	10% 40% 80% 100%	0.1% 0.1% 0.1% 0.1%
<u>Road Work</u> 25% 50% 75% 100%	25% 50% 75% 100%	0.1% 0.1% 0.1% 0.1%
<u>Bridge work</u> 25% 50% 75% 100%	10% 40% 80% 100%	0.1% 0.1% 0.1% 0.1%

**EXECUTIVE ENGINEER
BUILDING DEPARTMENT
BHAVNAGAR MUNICIPAL CORPORATION
BHAVNAGAR**

PROPOSED DEVELOPMENT OF NIGHT SHELTER AT FULSAR, FOR B.M.C, BHAVANAGAR

SECTION- II

SPECIAL CONDITIONS OF CONTRACT

ARCHITECTS:-

CHINTAN SACHAPARA

ARCHITECTS

3, SHAHIBAUG, ABOVE HOME DÉCOR, WAGHA WADI ROAD,

BHAVNAGAR

PHONE : 9428401640

SPECIAL CONDITIONS OF CONTRACT

1. The work under this contract is for the proposed development of **PROPOSED DEVELOPMENT OF NIGHT SHELTER AT FULSAR, FOR B.M.C, BHAVANAGAR**

- 2 The contractor shall execute the work as per the terms, conditions,
 - (v) Specifications, drawings and details attached here with and issued from time to time during the course of work along with necessary instructions. The special terms and conditions contained here with shall over rule, the general Terms and conditions, if any, such General Condition and terms are in conflict with such Special terms & conditions.
1. All the works contained in the Schedule and any further work that may come up during the continuance of the contract shall be carried out with the same schedule of Rates, terms, conditions, specifications and according to the instructions of the Architect and the Owner.
- 4 The teak wood shall be best quality Teak wood as mentioned in the list of approved materials or equivalent and approved by the Architect / Owner.
- 5 In all the items of works where it is with plaster or finish, it shall mean cement plaster of neeru / sand faced finish or as specified and instructed.
- 6 All the materials shall be in accordance with the general specifications of materials and list of approved materials attached.
- 7 Bricks shall be first class table moulded, kiln burnt and shall be approved by the Architect and having a minimum crushing strength of 35 kg / sq cm.
- 8 The coarse aggregate of R.C.C. & other cement concrete work shall be trap stones approved by the Architect/ Employer. Cement concrete for all R.C.C. and other work shall be machine mixed, machine vibrated and using boxes only and it shall be strictly carried out as per codal provisions, instructions and details given from structural consultant / architect / employer for each and every structural members.
- 9 The Marble slab shall be hard, uniform and homogeneous in texture. They shall have even crystalline grain and free from defects and cracks. The surface shall be mirror polished to even and perfectly plain surface and edged machine cut true and square. The rear face shall be rough to provide key for the mortar. The Marble slab shall be white or of other colour as specified and of best quality.
- 10 The kota flooring shall be of approved and uniform colour and free from flaws and shall be hand cut and mirror polished and in perfect right angle corner.
- (11) After hearing the approval of the tender, the contractor shall place the order immediately for materials like bricks; stones, etc. required for the work in order to get them on site well in advance of the requirement. Sample of every material and item of work to be executed for this work shall be approved in advance.
- (12) The contractor shall not claim any compensation for any items of works that can be carried out by specialist contractor / other contractor and which may be deleted from the contract.

- (13) The quantities in the schedule are approximate and likely to vary. No compensation or extra charges will be allowed for variation in quantities of work or for omission or alteration of any item of works.
- (14) The contractor shall have to procure steel and cement from the open market for the work and shall make necessary arrangements for its proper storage.
- (15) The work shall be carried out according to plans, specifications and conditions of contract as prepared by the Architect.
- (16) The work is to be completed within **32 Months(including Monsoon Period)** from the date of order for commencement of work and in a case of delay beyond the specified time, the contractor is liable to penalty @ 1% per month on the contract amount. This penalty shall be levied to the extent of 10% of the contract amount. When the penalty amount exceeds 10% of the contract amount the contractor shall stop work and the contract would be terminated by the Employer. The balance work shall be executed by any other contractor at the cost / risk / expense of the first contractor. In case of slow progress of work retention money @ 5% of the immediate running bill / bills shall be deducted / continue to be deducted. The same shall only be released after satisfactory progress of work is achieved as per the approved bar chart and certificate of the same has been obtained from the Architect / Employer.
- (17) The progress of the work shall be maintained by the contractor as instructed by the Architect / Employer.
- (18) The contractor shall have to take water and electric connection at site at his own expense and he shall have to arrange for storing sufficient quantities of water for construction at his cost. The charges for consumption of water and electricity will be borne by the contractor.
- (19) The contractor shall get the rate of such an item fixed and confirmed in writing before starting any extra item.
- (20) These special specifications shall apply to all the material and general specifications shall apply to those items for which there are no special specifications. The decision of the Architect shall be final and binding to both the parties.
- (21) The decision of the Architect shall in the matters of dispute, interpretation of any item of work, specifications and conditions shall be final and binding on both the parties.
- (22) The contractor before proceeding with the work shall deposit insurance policy of an approved Nationalized Insurance company, covering the risk of workman's compensation and third party damages with the Consultant as per the conditions No. 67 B1 of the conditions and renewal from time to time and acknowledgement of the same shall be given to the Employer
- (23) Contractors are request to fill their rates in schedule enclosed, total-up at the end and should clearly write the estimated amount in figures and words arrived at.
- (24) The construction must be completed with in **32 months(including Monsoon period)** from the date of order for commencement of work

- (25) R.C.C. Slabs of all bathrooms and toilet floor shall be sunk except on terrace slab.
- (26) The finished floor levels of balcony, toilets, w.c. and Bath room will be sunk compared to the adjoining finished floor level.
- (27) **Each interim bill submitted by the contractor for payment shall not be less than 5% of the contract amount**
- (28) The contractor shall pay a penalty as per clause no. 2 of general conditions of tender or as per clause no.16 of this special condition of tender whichever is more in case of delay and not sticking to the time schedule.
- (29) Without the prior consent, knowledge and written instruction from the employer or the Architect, the contractor shall not remove any materials, machinery implements from the site.
- (30) The contractor shall be solely responsible and shall bear the costs of materials and labour for re-doing any defective work specially in case of bends, chhajas, cornices and corner. They must be constructed in alignment and plumb and level or else it shall not be certified by the Architect.
- (31) Full-time Bhisties shall be employed by the Contractor for curing and properly watering the works. Number of Bhisties to be employed shall be as per the satisfaction and the instruction of the Architect. Vertical surfaces of all R.C.C. work shall be cured by covering it with wet hessian (kantana) and horizontal surfaces cured by making ponds on it of cement mortar upstands which shall be filled with water.
- (32) The contractor shall not charge extra for brick masonry tank which shall be duly constructed by him for the construction work and shall be demolished after the completion of the work.
- (33) The contractor shall provide at his own cost hutments for a labourers at the site. When any workman are temporarily accommodated within the premises and the contractor shall see to it that no mis-use of the premises is carried out and the same are vacated and the hutments removed before the completed work is handed over to the employer.
- (34) The contractor shall not either through his labourers or through himself cause of allow to be caused any nuisance or annoyance to the neighboring premises, neighbours and occupants of the property itself.
- (35) The contractor shall be responsible for any disfigurement damages to the property when in his possession, after being handed-over to him by the employer, in stipulated time, as laid out in the contract.
- (36) This contract shall include all that is attached detailed drgs, details, specifications, Article of Agreement and all conditions of contract mentioned.
- (37) The necessary certificate from various authorities for work done or to be done in accordance with rules and regulations of local authorities shall be obtained by the contractor.
- (38) The contractor shall make the name-board of the building of size 180cm x 240cm and fix it at the site at appropriate place as directed by the Architect and the contractor shall not

- charge extra for it.
- (39) Sub-contractor for electrical and plumbing work shall be license holders and shall have prior approval of the Architect before being employed by the Contractor.
 - (40) The contractor shall submit in the office of the Architect the report of the work done every week.
 - (41) The contractor's rate shall include all the carting, royalty loading and unloading charges for all materials upto the site of proposed work.
 - (42) **Plaster grooves in doors, windows, frames and hold fast over moulds shall be provided by the contractor. The rates of the doors and windows ventilators, rolling shutters, collapsible gate are inclusive of all the necessary hardware, paint, grooves etc. as decided by the Architect.**
 - (43) **Drip mould 25mm wide (minimum) shall be provided on the projections of Chhajas concrete work and brick work from the building line and no extra charge shall be paid to the contractor for the same.**
 - (44) Two sets of plans and working drawing will be supplied by the Architect to the successful tenderer free of cost from which atleast one set shall be cloth bound / laminated by the contractor and kept at site
 - (45) The tender shall be accompanied with list of projects completed by the contractor with approximate value of each project.
 - (46) After the completion of works a final coat of colour wash, white wash, oil bound distemper, cement paint or any other paint shall be done as suggested by the Architect
 - (47) After completing the wash or colour, the main contractor shall hand-over the building of its part to the Electrical contractor. The Electrical contractor shall hand-over the building or its part after completing the electrical work to the main contractor, who shall execute repairing the damage of the plaster, if any and then carry out the final cost of colour-wash etc.
 - (48) After verifying the bills with the site Engineer, the contractor shall submit the bill to the Employer.
 - (49) Atleast one graduate civil engineer and an experienced clerk-of-works shall take the instructions from the site Engineer or the Architect from time to time, and they shall be employed by the contractor to remain continuously at site during the course of the entire work. All the work shall be carried out in daytime only from 8.30 am to 6 pm only and any time extension or work permission shall be given only after verifying the reasons.
 - (50) The contractor shall provide 100mm thick R.C.C. runners at every 900mm height in all masonry walls and he shall not charge any extra for the same
 - (51) The employer is not concerned in any rise or fall in the prices of any materials and charges for labour etc. and the contractor will not be entitled to claim any compensation arising from fluctuations.
 - (52) The contractor shall be registered with the local self government as work supervisor & shall fill in & submit the 2-c form to the same as decided by the

Architect.

- (53) Wood work to be treated with anti-termite treatment where it comes in contact with the walls and as specified by the Architect / Employer.
- (54) The contractor shall not object to the Employer who also reserves the right to carry out any items specified in the tender to any other agency as the employers may deem it to be fit and the contractor shall not be paid for any such item that has not been executed by him.
- (55) The contractor shall agree with the rates of any items not considered in the contract and as settled by the Architect with the consent of the employer.
- (56) The possession of the building shall at all times remain with the employer and the contractor is not liable to the possession of the structure.
- (57) The contractor shall be responsible for giving proper co- operation and co- ordination to all other agencies from time to time.
- (58) Teak wood cover moulds and architraves out of 38mm x 25mm Teak wood Dundi as per the design and fixed to all frames as directed by the Architect. The Contractor shall not charge extra for the same.
- | | | | |
|-------------------------|----------------------------|-------------|-------------|
| Doors (Fully Panalled): | Stile | - | 150 x 35mm |
| | Horizontal member top rail | - | 150 x 35mm. |
| | Bottom rail | - | 150 x 35mm |
| | Lock rail | - | 180 x 35mm |
| | Frize rail | - | 150 x 35mm |
| | In filled panel- | - | 25mm thick. |
| Windows | : | Stile | - 75 x 35mm |
| | | Top rail | - 75 x 35mm |
| | | Bottom rail | - 75 x 35mm |
| | | Frieze rail | - 75 x 35mm |
- (59) The building shall be insured against all natural and man made calamities by the contractor during the course of construction from time to time, the value of which shall vary according to the quantum of work done. The premium shall be paid by the contractor but the policy shall be assigned in the favour of the employer and the contractor shall not claim extra for it
- (60) Photographs of size 7"x9" shall be provided by the contractor during the progress of work. Photographs shall be provided at different stages as suggested by the Architect.
- (61) 75% Security Deposit to be paid at the time of agreement and remaining 25% S.D. shall be deducted from running bills at the rate of 2.5% of the contract cost.
- (62) In the event of the tender being submitted by a firm or company it must be signed by the partners as per company's or firm's agreement deed, it shall be signed on his/their behalf by a person/persons holding a power of attorney authorizing to do so. Certified copies of Registration Certificate, Partnership Deed and Power of Attorney will have to be furnished when the tender is to

be considered for acceptance.

- (63) Every tenderer must see the site conditions, scope of works in relation to materials and workmanship, access to site, local condition, local by laws availability of services such as water, electricity, drainage etc. and no demands for extra rates or time from the contractor shall be entertained in this matter.
- (64) The tenderer shall not make any alterations, additions or amendments in the conditions of contract, specifications and descriptions incorporated, Additions or amendments shall be liable to rejection.
- (65) All rate shall be filled in English clearly and legibly.
- (66) All products in the amount columns will be subject to arithmetical check.
- (67) All correction in the rate, unit & amount columns of bills of quantities must be properly initialed.
- (68) The various work will be measured as per standard method of measurements and as laid down by B.I.S.
- (69) The contractor shall check & verify all dimensions on the site before talking up the work on hand.
- (70) In the event of any discrepancy specification in consistency, incompleteness or ambiguity on the drawings and/or specifications the same shall be brought to the notice of the Architect whose decisions on such discrepancy inconsistency incompleteness or ambiguity shall be final and binding on the tender.
- (71) The erection & display of any sub-contractor or advertisement by the contractor or any sub-contractor or person supplying labour, materials or services to the work is prohibited. However, sign relating to fire danger and safety is exempted from this prohibition.
- (72) During the execution of the work it shall be incubement on the part of the contractor to extend all facilities to the Architect and/ or his representative, the consulting Engineer and the clerk of the works to inspect, check and measure the work.
- (73) The quantities against each items given in schedule of quantities may change or be omitted totally without giving any reason and the contractor is bound in execute the item at the same rate as quoted inspite of any variation in the quantity of any items.
- (74) "Employer" shall mean Owner i.e bhavnagar municipal corporation and shall include their legal representative(s), assignee(s) or successor(s).
- (75) " Contractor shall mean the persons or person, firm or company whose tender has been accepted by the employer and includes the contractor's personal representative, executor, administrator, assignee(s) or successor(s).
- (76) "Architect" shall mean

ARCHITECTS:-

CHINTAN SACHAPARA
ARCHITECTS

3, SHAHIBAUG, ABOVE HOME DÉCOR, WAGHA WADI ROAD,

BHAVNAGAR

PHONE : 9428401640

to act as

Architect for the purpose of this contract.

- (78) No material shall be supplied by the Employer and in the event of the Owner supplying any material, the cost of the same shall be deducted from the total amount of the executed item.
- (79) No advance facility towards material stacked on site shall be granted.
- (80) Wherever in the general specification I.S. are mentioned it shall mean the relevant one.
- (81) The contractor shall also be liable to bear all municipal taxes for storages of materials etc.
- (82) Contractor shall agree to do less or more work than scheduled herewith the same special condition of contract, general condition, specifications & schedule of rate without claiming any variation whatsoever shall apply.
- (83) All surface concrete works like TRIMIX, PCC should be vibrated by surface vibrators.
- (84) All types of tests shall be carried out by contractor on his own expense wherever necessary according to given test report charts and submitted to Architect duly signed by authorized person.
- (85) Checklist as attached in this tender shall be submitted by contractor before starting any work duly signed by authorised person or representative of the contractor to the Architect.
- (86) All materials and all items of work and their execution shall be strictly in accordance with relevant I.S. Code including latest revisions of the same.
- (87) All soil tests as advised by the consultant shall be carried out by contractor at his own expense.
- (88) For Non S.O.R. / non tendered item the rate for the same shall be arrived at on the basis of comments Offered by the Architect on the rate analysis prepared and submitted by the contractor. The rate arrived at by the Architect shall be binding to the contractor and owner.
- (89) If there is no technical specification is mentioned that item should be execute as per instructions by Architect / Employer.
- (90) The contractor will have to take water and electric connections at site for which necessary deposits if any will be borne by the Owners, but the actual water and electrical consumption charges shall be borne by the Contractor. The Contractor shall have to arrange for holding sufficient quantity of water at site at his own expenses.
- (91) Contractor shall have to purchase stamp paper to execute this agreement as per Govt at their own cost and the employer shall not give compensation for the same.
- (92) All concrete work shall be cube tested by the Contractor. He shall obtain relevant certificate of test from Authority as prescribed by the Architect. The Contractor shall not be paid extra for these certificates and testing.
- (93) Contractor shall have to maintain cement consumption register as per design

mixes prescribed by the Structural Engineer and this register shall be made available to the Structural Engineer/ Architect/ Employer as and when demanded by them.

- (94) The Contractor shall obtain approval in writing from the Structural Engineer for the entire centering and shuttering as soon as it is put in place prior to placement of steel and concreting.
- (95) The Contractor shall obtain approval in writing from the Structural Engineer for the entire size, length, laps, cutting, placing, binding and placement of steel prior to concreting
- (96) The Contractor shall obtain approval in writing from the Structural Engineer for the entire concreting done for this work.
- (97) The Contractor shall have to submit earnest money deposit and security deposit in form of Small Savings Certificate, Nationalised Bank Fixed Deposit Receipt or in cash only as the amount indicated in memorandum of works in brief.
- (98) All rain water pipe outlet at terrace level/ chhaja level shall be covered with c.i. jali of size 15cmX15cm and fixed to rainwater down take pipe
- (99) **Before casting of any R.C.C. work of any type, form work shall be truly in line level and plumb. The joints of form work shall be finished with cement and grease in proportion of 1:1(1 cement : 1grease) and joints of same shall be covered with 2" wide cellophane tapes.**
- (100) All form work material shall be approved by site engineer before putting it to use and any change or rejection of formwork made by site engineer shall be binding to the contractor.
- (101) All R.C.C. members must be provided with proper cover as per structural engineer's details and the same shall be maintained throughout the work.
- (102) The coarse aggregate and sand for R.C.C work shall be used only after washing it thoroughly in water.
- (103) Railing of balcony, stair case shall be fixed to walls / columns by means of a flange.
- (104) Proper sized saddle shall be provided on wall to fix exposed cast iron/ galvanized line/pvc line to wall in such a way that clear distance between the wall and pipes shall be minimum 50mm. Saddle shall be made M.S. as per details.
- (105) All collar joints of cast iron pipe line shall be jute caulked using jute in first layer and second coat of cement finished on jute to ensure proper joints and all joints and pipes shall be tested to prevent any leakages.
- (106) All bends in cast iron pipe/pvc pipe shall be fitted with proper plug to
(vi) maintain it.
- (107) All pipe line shall be tested before concealing it and any fault that may
(vii) come during testing shall be rectified/replaced.
- (108) Starters shall be used to fix and cast column in R.C.C work and starters
(viii) shall be of good finish of M.S. of adequate size and shape and 75mm in

(ix) height.

- (110) **Grooves shall be provided at junction of plastered surface and wall dedo.**
- (111) All glazed/ceramic tiles in dedo shall be fixed at right angle corner by chamfering their edges at 45 degrees.
- (112) All corner joints in skirting shall be finished with 90 degrees offset and all exposed faces shall be finished with the same level of polish as that of skirting / wall dedo.
- (113) Plaster of paris coating shall be applied on all polished horizontal surfaces on completion of polishing work of stone. The same shall be removed and the stone surfaces thoroughly cleaned prior to handing over the completed work to the Owner.
- (114) Rainwater outlet at ground level shall be extended 30cm from wall and out at 45deg.
- (115) All door / window frames shall be fixed with ties and the same shall be maintained throughout the work till the shutters are fixed. Finished floor level shall be marked on all door frames.
- (116) Grill bars shall be fixed through the window frames and holes in frames shall be finished with mixture of saw dust and adhesives.
- (117) Wire mesh shall be fixed prior to plastering at junction of R.C.C and brick masonry, and chaises cut in walls for plumbing and electrical items.
- (118) Bottom of all electrical boxes shall be truly in tube level.
- (119) **All PCC,RCC,BRICK MASONARY AND plaster work shall be carried out using 53 grade ordinary Portland cement ONLY.**
- (120) All steel reinforcement shall be coated with anti corrosive coating as suggested by the Architect except for TMT / CRS Reinforcement.
- (121) All the work shall be strictly carried out according to drawings, details and instructions given from time to time by Architect / Employer
- (122) Use water and aggregates as specified in I.S. 456-2000 and relevant I.S code
- (123) Form work shall be sufficiently rigid to take up the load and stripping time for form work and props as mention in I.S 456-2000, Clause No. 11.3 page no.25
- (124) Locate construction joint at L/5 span of slabs and beams
- (125) For all structural members use specified concrete mix. At junction of members with grade of concrete use of higher grade.
- (126) During placing of concrete care shall be taken to prevent the displacement or bending of reinforcement from its original position.
- (127) Provide chair of one no. higher diameter than extra top reinforcement diameter.
- (128) **Pin bars shall be provided of minimum 25 mm diameter for extra bars in beams at top at 100 cm c/c distance.**
- (129) Production of concrete shall be mentioned in I.S 456-2000, clause no. 10.2.
- (130) Quality assurance measure shall be as mentioned in I.S 456-2000 clause

10.1.

- (131) Laps in reinforcement bars should be as per length as specified below for slabs and secondary beams, beams supported by beams (except main framing beams) laps may preferably be located at L/ 5 span from support and shall be staggered. For beams and slabs, laps should not be located at mid span and support. There shall be no laps in top and at junction of continuous beams.
- (132) Lap length of reinforcement shall be minimum 50 D (D = diameter of bars)
- (133) Concentration of load such as stacking of building materials on floors during construction shall be avoided.
- (134) All required testing materials, concrete and steel should be followed as per I.S 456-2000, clause no. 15,16 and 17 for continuous assessment of quality of work and materials. Care shall be taken for quality, consistency and soundness of work.
- (135) Curing in masonry should be atleast up to seven days.
- (136) Use of round stone shall not be permitted in any type of construction work
- (137) ***Any vertical R.C.C members shall be cast after construction of adjoining brick masonry work.***
- (138) Safety procedures shall be adhered to during progress of all types of work. The contractor shall take all safety measure such as training the staff/work men for Standard & precaution to take during execution of work for safety. All the contractors workmen shall be equipped with Safety shoes, safety helmet, safety belt, phase tester etc, as required for carrying out the work.
- (139) Contactor shall be responsible for the true and proper location, levels, dimensions and alignment of all parts of the work and if any mistakes are observed in the same they shall be corrected by contractor at his own cost.
- (140) All types of test for all R.C.C. work shall be made by contractor wether material is supplied by owner or not and test result submitted to the consultant and arrangement for same shall be made by contractor.
- (141) All types of test for all materials as suggested by the architect shall be carried out by the contractor free of cost. For testing of basic materials following shall be followed.
- a. sand : every 7 trucks or minimum 3 test in months which ever is more.
 - b. bricks : every 3 trucks or minimum 3 test in months which ever is more.
 - c. cement : test result obtain from company for each and every truck load .
 - d. steel : for every truck load.(aprox-7.5 to 10 tonne)
 - e. stone aggregate of any size : every 4 trucks or minimum 3 test in month which ever is more.
 - f. Stone : every 4 trucks or minimum 3 test in month which ever is more.
- In addition to all the above other required materials during course of construction shall be tested by the contractor as instructed by site engineer and the same shall be submitted to the Architect duly signed by authorized person of the contractor and no extra charge shall be paid for the same.
- (142) Contractor shall have to do the necessary liasoning work and make necessary arrangement for electrical connection, meter, water

connection within a month from the assignment of the work, failing which he shall not be paid for liasoning work charges as quoted in tender.

- (143) All vertical, horizontal and inclined surface joints in all types of R.C.C. form work shall be sealed with "75mm wide packing tapes" of approved make prior to any casting work.
- (144) Contractor shall have to make arrangement for column form work(farma) of minimum side 30cm in width and at least minimum 5nos of such form work for each column size as per structural design. Plywood form work shall not be allowed for columns.
- (145) The contractor shall have to cast concrete of minimum 300 bags of cement per day for R.C.C. work for slabs, beams, pardi, and other R.C.C .member.
- (146) The contractor shall inspect the site of work prior to bidding. Once the bids are received no excuses/claims for the condition of site, its surrounding area etc, shall be entertained. The material used in them and the rates received shall be considered final irrespective of the quantities of work to be executed.
- (147) The contractor shall be asked to submit reports of tests as specified by the consultant for any materials of their end products prior to their use,during their use and after their use, the expenses of their tests shall be borne by the contractor and he shall not be reimbursed any such expenses. These tests shall be conducted at site/or laboratories as specified by the consultant/engineer in charge.
- (148) The contractor shall commence and stop work at site for each and every item of work mentioned in this tender at the time as specified by the owner/Architect No compensation or extra payment shall be made for this.
- (149) Contractor shall keep on site all necessary construction equipments like Vibrator, Mixer machine, Mortar mixing equipments, Pumps, and other equipments in running conditions and the same shall be tested and checked be fore starting of work and stand by equipments of above shall be kept ready in case of any faults that may arise during work.
- (150) Contractor shall clean the site and make proper storage of construction equipments, materials, chemicals, after completion of day time work and any debris, loose powdered material shall be removed from site during the work with out disturbing the premises, traffic and surroundings area and make proper arrangement for disposal of the same.
- (151) During the course of work, the contractor and the work men shall abide by all security regulations that may be prescribed by the owner.
- (152) As far as possible the contractor shall not execute any work after the working hours as prescribed by the owner. In the eventuality of such a need arising, the contractor shall inform the Architect, engineer in charge and the owner in writing well in advance.
- (153) For the execution of this work the contractor shall strictly abide by all the instruction/conditions of this tender and those which may be issued to him from time to time. The contractor shall not claim any extra rate for abiding by any of such instruction/conditions unless agreed upon in advance.
- (154) The special construction chemicals used for this works are expensive and hazardous hence appointing a skilled person to handle these materials and use and apply them in workmanship manner will help in elevating the desired results. Some of the material used have a

prescribed pot life within which the same should be used after mixing. Therefore and contractor shall plan out their use and mix only that quantity of material which can be consumed in the prescribed quantity within the time limit prescribed by the manufacturer. The contractor shall take due care for providing prescribed drying/curing time obtain desired results.

- (155)** The contractor shall have to make two standard pucca RCC bench marks established on each side before commencement of work and connected to the G.T.S. bench marks according to which whole work shall be carried out. The levels shown on the contract drawings accompanying the tender are with reference to G.T.M.B.M., are tentative and for the purpose of general guidance only. the contractor shall establish reference bench mark at intermediate suggested spots. The maintenance of all these B.M.s shall be responsibility of the contractor.
- (156)** The contractor shall provide proper water proofing treatment to building As per company's specifications and shall give written guarantee for above for ten years to the employer in writing and 25% of that amount shall be retained by the employer and release after the end of guarantee period.
- (157)** The Contractor shall have to locate, line out the building and mark out The grid lines and various components of the buildings during the course of work, as per the drawings of the Architect, and get same approved by the representative of the Architect/ Employer.
- (158)** The Contractor shall have to use mixer machine of sufficient capacity, Vibrator of required type, boxes, etc. as required for R.C.C. work.
- (159)** The contractor shall have to wash material like Sand, Coarse aggregate, and other material with the help of bucket or as required and instructed by Consultant and upto the satisfaction of the consultant before put in use.
- (160)** The Contractor shall have to take temporary electrical connection of Sufficient capacity from Pgvcl and all charges and expenses shall be born by the contractor as applicable.
- (161)** During the entire course of work if any damages done to any of the existing steps, stones, structures or environment and ecology of the site, the Contractor shall have to bear all the expenses for rectifying it as suggested by the Architect.
- (162)** During the course of this work the contractor shall use only those equipment and machineries which give minimum vibration on their operation. If the Owner / consultant is dissatisfied about the extent of vibration of equipment and machineries used by the contractor, they shall intimate the contractor about the same and the contractor shall discontinue the usage of the said equipment / machineries immediately. and make alternative arrangement. For the discontinuation and stoppage of the said equipment /machineries the contractor shall not be given any extension in prescribed time limit of the tender nor paid extra.
- (163)** The Contractor may use the existing infrastructure developed by the Owner, but contractor shall have to bear the operational expenses of the said infrastructure for the period of use, during the course of usage of the infrastructure developed by the Owner. If any component of the said infrastructure is damaged during their usage by the contractor he shall rectify the said damage at his own cost. The Owner shall not encourage any demand for extension of time limit or extra cost in the course of any failure in the infrastructure laid by the Owner.
- (164)** The entire work shall be executed in such a way that the existing site

and its surroundings are not disturbed and the environment of the premises is maintained as per guidelines given by the Owner on time to time.

- (165) It is likely that the Owner may issue instructions to stop the work for a certain duration of time in which case the time limit of the tender shall be extended for the same duration without giving any increase in rate agreed upon in the tender.
- (166) Explosives of any kind shall not be permitted for any items of work of this contract other means may be permitted on obtaining prior approval of the consultants.
- (167) The Contractor shall submit a bar chart of the project indicating the time period within which the Contractor shall finish the work and the rate of progress of work that he intends to maintain. The Contractor shall strictly adhere to the bar chart submitted by him and approved by the Architect / Employer.
- (168) The Contractor shall provide proper anti- termite treatment to building, its periphery as per company specifications and shall give guarantee for above for 10 years to the Employer in writing and 25% of the bill amount of anti termite treatment shall be retained by the employer upto the end of guarantee period.
- (169) **Any State / Central Government Tax, GST, Royalty, labour Cess etc. that may be applicable on the Contractor's, bill amount from time to time shall be deducted from the contractor's interim / running bills at rates applicable at that time.**
- (170) **Please note that Rebaring/Anchoring not permitted for any RCC members like Lintel/Sill/Beams/Columns/Copings etc and also if required on site take prior approval from Architects/Structural Consultant/Authority fo the same. Rebaring/Anchoring of any sizes of Reinforcement Steel charges for any R.C.C. Items likes Lintels, Copings, Beams, Columns, R.C.C.Walls, R.C.C. Slabs etc shall be borne by the Contractor. The Contractor shall have to arrange at site at his own expenses.**
- (171) **JOINT VENTURE NOT PERMITTED FOR CONTRACT OF THE PROPOSED WORK.**
- (172) **ALL LIGHTING FIXTURES MUST BE APPROVED BY ARCHITECT (MAKE, MODEL, TYPE, WALTAGE)**
- (173) **All the necessary licences shall obtain for elevator/lift, fire and electric work from the concerned authority/department including necessary noc and conducting liasioning work for the same charges for the same borne(at their own expense) by The Contractor**

***All the above conditions are read by me carefully and are binding to me.**

**Signature of
Agency/The Contractor**

**Signature of
EXECUTIVE ENGINEER
BUILDING DEPARTMENT
BHAVNAGAR MUNICIPAL CORPORATION
BHAVNAGAR**

-: SPECIAL CONDITIONS:-

1. The bidder to note the following qualifying criteria for bidding.

For Construction of Building Work

i) Average Annual financial turnover during the last 3 years, ending 31st March of the previous financial year, should be at least 30% of the estimated cost. Proof for the same from registered chartered accountant shall have to be produced.

ii) Experience of having successfully completed similar works during last 7 years ending last day of month previous to the one in which applications are invited should be either of the following: -

a. Three similar completed works costing not less than the amount equal to 40% of the estimated cost.

or

b. Two similar completed works costing not less than the amount equal to 50% of the estimated cost.

or

c. One similar completed work costing not less than the amount equal to 80% of the estimated cost.

iii) Definition of "similar work" means the work of Construction of Building Work

A certificate in Form no 3A of the Competent Officer rank not less than Executive Engineer regarding completing a similar nature of work shall have to be produced by the bidder and the same shall be scanned and uploaded along with the bid at the time of submitting bid and with submission of hard copy. **A tender without the certificate shall be considered non responsive and will not be opened.**

2. For this contract in form B-2 the Government means Bhavnagar Municipal Corporation, Bhavnagar AND Superintending Engineer means City Engineer.
3. The Bank guarantee for the Security deposit shall be submitted for the for the period of 71 month (32 month Time limit + 36 month Defect liability Period + three month extra).
4. 1% from every running bill shall be deducted towards labor cess.
5. **The time for completion of the project shall be 32 Thirty Two months (Including monsoon period) from the issue of LOI.**
6. **The Defect Liability period for the project shall be THREE years (Thirty Six Months) from the work completion certificate issued by Engineer in charge.**
7. **For the Electrical work the contractor shall have to prepare and submit complete electric wiring including installation of fixtures diagram** considering the lighting requirement of public building and submit the same for approval; on the approval the work shall be carried out accordingly. For this work all the details shall have to be derived as per the relevant provision of NBC for public building. This should also include water pump procurement and installation on the under ground tank with pump room, for protection from weather.
8. The cost of the permanent electric power connection shall be borne by the Corporation; however the contractor shall liaise for release of connection. The authority will extend every support for the application as well as to produce and submit the documents necessary for approval.
9. The specification for any item if not covered in the tender than it should be as decided by engineer in charge.
10. The contractor shall have to follow test schedule as per relevant IS standard even if not specified otherwise in the tender, at his own cost.

11. Site laboratory requirement shall be as follows

Sr.No.	Particular
1	Temporary room/shed 100 Sq-Ft
2	Slump cone
3	Sieves For Fine Aggregate
4	Sieves for Coarse Aggregate
5	Compressive Testing Machieny
6	Cube Moulds (15cm)-24 no.

12. The drawings attached with the tender are for the over view of the work, the detail drawings and structural design will be supplied by the BMC and the work shall have to carry out accordingly. The quantities may vary at the time of execution.

13. All the material shall be first got approved from the EIC before procurement or use.

14. **Having E.S.I.C/ valid Labor Licenses.**

Notes:-If the above mentioned all conditions are not met with the tender shall be rejected outright without any further processes or reasons.

16. The charges for consumption of water and electricity will be borne by the contractor.

17. The contractor shall get the rate of such an item fixed and confirmed in writing before starting any extra item.

18. The contractor shall not either through his labourers or through himself cause of allow to be caused any nuisance or annoyance to the neighboring premises, neighbours and occupants of the property itself.

19. The contractor shall be responsible for any disfigurement damages to the property when in his possession, after being handed-over to him by the employer, in stipulated time, as laid out in the contract.

20. Atleast one graduate civil engineer,one diploma civil engineer and an experienced clerk- of-works shall take the instructions from the site Engineer or the Architect from time to time, and they shall be employed by the contractor to remain continuously at site during the course of the entire work. All the work shall be carried out in daytime only from 8.30 am to 6 pm only and any time extention or work permission shall be given only after verifying the reasons

21. In the event of the tender being submitted by a firm or company it must be signed by the partners as per company's or firm's agreement deed, it shall be signed on his/their behalf by a person/persons holding a power of attorney authorizing to do so. Certified copies of Registration Certificate, Partnership Deed and Power of Attorney will have to be furnished when the tender is to be considered for acceptance.

22. All rate shall be filled in English clearly and legibly.

23. No advance facility towards material stacked on site shall be granted.

24. Wherever in the general specification I.S. are mentioned it shall mean the relevant one.

25. The contractor shall also be liable to bear all municipal taxes for storages of materials etc.

26. The

1	Cement	consistency	1-50 T 2- 50 to 100 T 3- 100 to 200 T
		Setting time Comp strength fineness	One per sample per lot or as required
2	Steel	Tensile, yield stress	1- 40 T
		Bend, re bend	1- 20 T
3	Aggregate	Gradation	1/150 m3 for concrete
		Sp. Gravity	2/ Season
		Flakiness	1/150 m3 for concrete
		Impact value	2/ Season
		Abrasion value	2/ Season
		soundness	2/ Season
		Alkali reactivity	2/ Season
		Petrographic examination	2/ Season
4	Water	Chemical analysis	1/ season
5	Sand	Gradation	1/150 m3 for concrete
		Sp. Gravity	2/ Season
		Silt content	2/season
		Alkali reactivity	2/ Season
		Petrographic examination	2/ Season
6	Brick	Compressive strength	One / 50000
		Water absorption	
		Size	
		Efflorescence	
7	Soil Compaction	Field density test	1/1000 Sq-Mt

General

frequency for testing shall be as follows

27. The charges for consumption of water and electricity will be borne by the contractor.

28. All required testing materials, concrete and steel should be followed as per I.S 456-2000, clause no. 15,16 and 17 for continuous assessment of quality of work and materials. Care shall be taken for quality, consistency and soundness of work.

29. Curing in masonry should be atleast up to seven days

30. Contractor shall keep on site all necessary construction equipments like Vibrator, Mixer machine, Mortar mixing equipments, Pumps, and other equipments in running conditions and the same shall be tested and checked before starting of work and stand by equipments of above shall be kept ready in case of any faults that may arise during work.

31. The Contractor shall have to locate, line out the building and mark out the grid lines and various components of the buildings during the course of work, as per the drawings of the Architect, and get same approved by the representative of the Architect/ Authority. (also done plot station survey if required charges will be borne by the contractor.)

32. The Contractor shall have to use mixer machine of sufficient capacity,

Vibrator of required type, boxes, etc. as required for R.C.C. work.

33. The entire work shall be executed in such a way that the existing site and its surroundings are not disturbed and the environment of the premises is maintained as per guidelines given by the Owner on time to time.

34. Any State / Central Government Tax, GST, Royalty, labour Cess etc. that may be applicable on the Contractor's, bill amount from time to time shall be deducted from the contractor's interim / running bills at rates applicable at that time

***All the above conditions are read by me carefully and are binding to me.**

Signature of Agency/contractor

**EXECUTIVE ENGINEER
BUILDING DEPARTMENT
BHAVNAGAR MUNICIPAL CORPORATION
BHAVNAGAR**

Special Conditions of Contract

Labour:

The Contractor shall, unless otherwise provided in the Contract, make his own arrangements for the engagement of all staff and labour, local or other, and for their payment, housing, feeding and transport.

The contractor shall, if required by the Engineer, deliver to the Engineer a return in detail, in such form and at such intervals as the Engineer may prescribe, showing the staff and the numbers of the several classes of labour from time to time employed by the contractor on the Site and such other information as the Engineer may require.

Compliance with Labour Regulations:

During continuance of the contract, the Contractor and his sub contractors shall abide at all times by all existing labour enactments and rules made there under, regulations, notifications and bye laws of the State or Central Government or local authority and any other labour law (including rules), regulations, bye laws that may be passed or notification that may be issued under any labour law in future either by the State or the Central Government or the local authority. Salient features of some of the major labour laws that are applicable to construction industry are given below: The Contractor shall keep the Employer indemnified in case any action is taken against the Employer by the competent authority on account of contravention of any of the provisions of any Act or rules made there under, regulations or notifications including amendments. If the Employer is caused to pay or reimburse, such amounts as may be necessary to cause or observe, or for non observance of the provisions stipulated in the notifications/bye laws/Acts/Rules/Regulations including amendments, if any, on the part of the Contractor, the Employer/Engineer shall have the right to deduct any money due to the Contractor including his amount of performance security. The employer/Engineer shall also have right to recover from the Contractor any sum required or estimated to be required for making good the loss or damage suffered by the Employer.

The employees of the contractor and the subcontractor in no case shall be treated as the employees of the Employer at any point of time.

SALIENT FEATURES OF SOME MAJOR LABOUR LAWS APPLICABLE TO ESTABLISHMENTS ENGAGED IN BUILDING AND OTHER CONSTRUCTION WORK:

- a) Workmen Compensation Act, 1923: The Act provides for compensation in case of injury by accident arising out of and during the course of employment.
- b) Payment of Gratuity Act, 1972: Gratuity is payable to an employee under the Act on satisfaction of certain conditions on separation if an employee has completed 5 years service or more or on death the rate of 15 days wages for every completed year of service. The Act is applicable to all establishments employing 10 or more employees.
- c) Employers P.F. and Miscellaneous Provision Act, 1952: The Act provides for monthly contributions by the employer plus workers @ 10% or 8.33%. The benefits payable under the Act are:
 - (i) Pension or family pension on retirement or death, as the case may be

- (ii) Deposit linked insurance on the death in harness of the worker.
- (iii) Payment of P F accumulation on retirement/death etc.
- d) Maternity benefit Act, 1951: The Act provides for leave and some other benefits to Women employees in case of confinement or miscarriage etc.
- e) Contract Labour (Regulation & Abolition) Act 1970: The Act provides for certain welfare measures to be provided by the contractor to contract labour and in case the Contractor fails to provide, the same are required to be provided, by the Principal Employer by Law. The Principal Employer is required to take Certificate of Registration and the Contractor is required to take license from the designated Officer. The Act is applicable to the establishments or Contractor of Principal Employer if they employ 20 or more contract labour.
- f) Minimum Wages Act 1948: The Employer is supposed to pay not less than the minimum wages fixed by appropriate Government as per provision of the Act if the employment is a scheduled employment. Construction of Buildings, Roads, Runways are scheduled employments.
- g) Payment of Wages Act 1936: It lays down a to by what date the wages are to be paid, when it will be paid and what deductions can be made from the wages of the workers.
- h) Equal Remuneration Act 1979: The Act provides for work of equal nature to male and female workers and for not making discrimination against female employees in the matters of transfers, training and promotions etc.
- i) Payment of Bonus Act 1965: The Act is applicable to all establishments employing 20 or more employees. The Act provides for payments of annual bonus subject to a minimum of 8.33% of wages and maximum of 20% of wages to employees drawing Rs. 3500/- per month or less. The bonus to be paid to employees getting Rs. 2500/- per month or above up to Rs. 3500/- per month shall be worked out by taking wages as Rs. 2500/- per month only. The act does not apply to certain establishments. The newly set up establishments are exempted for five years in certain circumstances. Some of the State Government has reduced the employment size from 20 to 10 for the purpose of applicability of the act.
- j) Industrial Disputes Act 1947: The act lays down the machinery and procedure for resolution of Industrial disputes, in what situations a strike or lock-out becomes illegal and what are the requirements for laying off or retrenching the employees or closing down the establishment.
- k) Industrial Employment (Stranding Orders) Act 1946: It is applicable to all establishments employing 100 or more workmen (employment size reduced by some of the States and Central Government to 50). The Act provides for laying down rules governing the conditions of employment by the Employer on matters provided in the Act and get the same certified by the designated Authority.

- l) Trade Unions Act, 1926: The Act lays down the procedure for registration of trade unions of workmen and employers. The trade unions registered under the Act have been given certain immunities from civil and criminal liabilities.
- m) Child Labour (Prohibition & Regulation) Act 1986: The Act prohibits employment of children below 14 years of age in certain occupations and process and provides for regulation of employment of children in all other occupations and process. Employment of Child Labour is prohibited in building and construction industry.
- n) Inter-State Migrant workmen's (Regulation of Employment & Conditions of service) Act 1979: The act is applicable to an establishment which employs 5 or more interstate migrant workmen through an intermediary (who has recruited workmen in one state for employment in the establishment situated in another state). The inter-state migrant workmen, in an establishment to which this Act becomes applicable, are required to be provided certain facilities such as housing, medical aid, traveling expenses from home up to the establishment and back, etc.
- o) The Building and other construction workers (Regulation of Employment and conditions of service) Act 1996 and the Cess Act of 1996 : All the establishments who carry on any building or other construction work and employs 10 or more workers are covered under this Act. All such establishments are required to pay cess at the one of the cost of construction . The Employer of the establishment is required to provide safety measures at the building or construction work and other welfare measures, such as Canteen, First Aid facilities, Ambulance, Housing accommodations for workers near the work place etc. The Employer to whom the Act applies has to obtain a registration certificate from the Registering Officer appointed by the Government. **The employer will deduct one percent of the bill amount as labour cess from each running bill paid to the contractor.**
- p) Factories Act 1948: The Act lays down the procedure for approval of plans before setting up a factory, health and safety provisions, welfare provisions, working hours, annual earned leave and rendering information regarding accidents or dangerous occurrences to designated authorities. It is applicable to premises employing 10 persons or more with aid of power or 20 or more persons without the aid of power engaged in manufacturing process.

3. Sub Contracting

Please add the following as the Contractor shall not be required to obtain any consent from the employer for:

- a) the sub-contracting of any part of the works for which the sub contractor is named in the contract;
- b) the provision of labour; and
- c) the purchase of materials which are in accordance with the standards specified in the Contract.

Beyond this if the contractor proposes sub contracting any part of the work during execution of works, because of some unforeseen circumstances to enable him to complete the work as per term of the contract, the Engineer will consider the following before according approval:

- a. The contractor shall not sub contract the whole of the works
 - b. The contractor shall not sub contract any part of the work without prior consent of the Engineer. Any such consent shall not relieve the contractor from any liability or obligations under the contract and he shall be responsible for the acts, defaults and neglects of any sub contractor, his agents or workmen as fully as if they were the acts, defaults or neglects of the contractor, his agents or workmen.
 - c. The Engineer should satisfy whether (a) the circumstances warrant such sub contracting, and (b) the sub contractors so proposed for the work possess the experience, qualifications and equipment necessary for the job proposed to be entrusted to them in proportion to the quantum of work to be sub contracted.
- If payments are proposed to be made directed to that sub –contractor, this should be subject to specific authorization by the prime contractor so that this arrangement does not alter the contractor’s liability or obligations under the contract.

4. PROTECTION OF ENVIRONMENT :

Add the following as GCC Clause 16.2:

The Contractor shall take all reasonable steps to protect the environment on and off the site and to avoid damage or nuisance to persons or to property of the public or others resulting from pollution, noise or other causes arising as a consequence of his methods of operation.

During continuance of the contract, the contractor and his sub contractors shall abide at all times by all existing enactments on environmental protection and rules made there under, regulations, notifications and bye laws of the State or Central Government, or local authorities and any other law, bye-law, regulations that may be passed or notification that may be issued in this respect in future by the State or Central Government or the local authority.

Salient features of some of the major laws that are applicable are given below:

The Water (Prevention and Control of Pollution) Act, 1974m, This provides for the prevention and control of water pollution and the maintaining and restoring of wholesomeness of water. “Pollution” means such contamination of water or such alteration of the physical chemical or biological properties of water or such discharge of any sewage or trade effluent or of any other liquid, gaseous or solid substance into water (whether directly or indirectly) as may, or is likely to, create a nuisance or render such water harmful or injurious to public health or safety, or to domestic, commercial industrial, agricultural or other legitimate uses, or to the life and health of animals or plants or of aquatic organisms

The Air (prevention and Control of Pollution) Act, 1981. This provides for prevention, control and abatement of air pollution , Air Pollution mean the presence in the atmosphere of any air

pollutant, which means any solid liquid or gaseous substance (including noise) present in the atmosphere in such concentration as may be or tend to be injurious to human beings or other living creatures or plants or property or environment.

The Environment (Protection) Act, 1986,. This provides for the protection and improvement of environment and for matters connected therewith, and the prevention of hazards to human beings, other living creatures, plants and property. Environment includes water, air and land and the inter relationship which exists among and between water, air and land and the inter relationship which exists among and between water, air and land, and human beings, other living creatures, plants, micro organism and property.

The public liability Insurance Act, 1991. This provides for public liability insurance for the purpose of providing immediate relief to the persons affected by accident occurring while handling hazardous substances and for matters connected herewith or incidental thereto, Hazardous substance means any substance or preparation which is defined as hazardous substance under the Environment (Protection) Act, 1986. and exceeding such quantity as may be specified by notification by the Central Government.

5. Testing of Materials and works.:

- 5.1 All materials before being incorporated in the work shall be inspected and if necessary tested before approval by the Engineer in charge / Consultant. The contractor shall prepare a mock-up of various construction elements (including finishes) involved in the job, thereby setting the performance standards, as per the directions of the Engineer. Any work, on which such materials are used without prior inspection (and when necessary testing) and without approval and written permission of the Engineer, is liable to be considered as defective and not acceptable.
- 5.2 An authorized representative of the Contractor shall remain present at the time when the samples are taken and shall authenticate the facts, if so required. Where the contractor's agent fail to be present as aforesaid, the samples or cores etc. collected by the Engineer or his representative shall be considered to be authentic. The Contractor will, however, be informed of the details of such samples having been collected.
- 5.3 The materials, mixes and cores shall be tested day to day and periodically at the laboratory and the results given thereby shall be considered correct and authentic by the Contractor. The Contractor shall be given opportunity to access all operations and tests that may be carried out as aforesaid so that he may satisfy himself regarding the procedure and methods adopted. It shall then be the Contractor's responsibility to produce on the works, materials and finished items to the standard based on the laboratory designs and tests.

6. Water Supply

The Contractor will have to make his own arrangements for supply of water to his labour camp and for works. All pumping installations, pipe networks and distribution system will have to be provided for and installed by the contractor at his own cost.

The price/rate tendered with this contract shall envisage all cost required for providing adequate potable water for labour and construction.

In the event of water being supplied by the owner, the cost towards distribution shall be borne by the contractor. The owner shall levy charges as per actual costs. The water shall be available only after the contractor provides for a calibrated water meter duly approved by the Engineer-in-charge / Consultant / Architect.

The non-availability of water for any reasons whatsoever shall not constitute any reason for delay or extension of time, extra claims or additional cost incurred for the performance of this contract. The owner bears no liability or responsibility for provision of the same and the arrangement of water is the responsibility of the contractor.

7. Power Supply

Contractor will have to make his own arrangements for supply of temporary power to his labor camp and for works. All installations and distribution system will have to be made and statutory approvals will have to be obtained by the contractor at his own cost.

The price / rate tendered with this contract shall envisage all cost required for providing adequate power for area lighting & construction works.

In the event of power being supplied by the Owner, at the discretion of the owner, charges as per actual cost shall be levied by the owner. The same shall be available only after the contractor provides for a calibrated meter duly approved by the Engineer-in-charge / Consultant/ Architect

The non-availability of power for any reason whatsoever shall not constitute any reason for delay, extension of time ,extra claims or additional cost incurred for the performance of this contract.

The owner bears no liability or responsibility for provision of power and the arrangement of power & generators if required, is the responsibility of the contractor and cost towards the same is deemed to be included in the rates /prices.

All distribution arrangements made by the contractor shall be removed on completion of the work.

The work to be carried out under the contract shall except as otherwise provided in these conditions include all labour, materials, tools, plants, equipments and transport which may be required in preparation of and for and in the full and entire execution and completion of the works. The descriptions given in the schedule of quantities shall unless otherwise stated be held to included waste on materials, carriage and cartage, carrying in, return of empties, hoisting, setting, fitting and fixing in position and all other labours necessary in and for the full and entire execution and completion as aforesaid in accordance with good practice and recognized principles.

The rates quoted by the Contractors should also include for providing all scaffolding, hoists, tackle and other plant, shuttering profiles and apparatus generally required for the proper execution of the work. The contractors shall be provided without extra charges all labour and apparatus required by EXECUTIVE ENGINEER, BUILDING DEPARTMENT, BHAVNAGAR MUNICIPAL CORPORATION for testing and measuring the works and for weighing measuring, providing or testing the efficiency of any portion of the works and shall also at his own cost provide all planking gang ways, etc. necessary for affording access to every part of the works.

The Contractor is expected to quote rate for each item after careful analysis of cost involved for the performance of the completed item considering all specifications and conditions of contract. This will avoid loss of profit or gain incase of curtailment or change of specification for any item. In case it is noticed that the rates quoted by the tenderer for any item are unusually low. Analysis for such rates will have to be furnished by the tenderer on demand, to satisfy EXECUTIVE ENGINEER, BUILDING DEPARTMENT, BHAVNAGAR MUNICIPAL CORPORATION about the reasonableness of the rates.

The Contractor shall provide at his cost all temporary lighting arrangement required for the works and to enable contractors to complete the works in the specified time.

The contractor shall provide and maintain at his own expense all lights, guards, fencing and watching when and wherever necessary or required by the Engineer – in – charge / Project Architect / PMC for the protection of the works or for the safety and convenience of those employed on the works or the public.

All scaffolding and ladders that may be necessary for taking measurement at site will be provided by the Contractor.

The whole of the works included in any contract shall be executed by the Contractor whom the work entrusted and the Contractor shall not directly or indirectly transfer assign or under let the contract or any part share thereof of any interest therein without the prior written consent of EXECUTIVE ENGINEER, BUILDING DEPARTMENT, BHAVNAGAR MUNICIPAL CORPORATION and no undertakings shall relieve the contractor from the full and entire responsibilities of the contractor or from active superintendence of the works during the progress.

The Contractor shall provide suitable stone with flat tops and build the same in concrete for temporary bench marks. All the pegs for setting out the work and fixing the necessary levels required for the execution thereof shall if desired by the Engineer – in – charge like wise be built in masonry at such places and in such manner as **The** EXECUTIVE ENGINEER, BUILDING DEPARTMENT, BHAVNAGAR MUNICIPAL CORPORATION, BHAVNAGAR may determine.

Particular care must be taken to see that the floors are not overloaded by stacks of materials during construction. It is important that no load comes on the reinforced concrete floors until they are at least 3 weeks old and at no time must the load placed upon them exceed the load for which they are designed.

The Contractor shall cover up and protect from injury from any cause all new work also for supplying all temporary doors, protection to windows and any other requisite protection for the whole of the works executed whether by himself or specified tradesmen and any damage caused must be made good by the contractors at his own expenses to the full satisfaction of Engineer In charge / Project Architect / PMC.

In order to exercise the required degree of constant control over the ingredients of concrete and their proportions the Contractor shall set up and maintain at his own expense a testing laboratory at site manned by a qualified and experienced technician. The Contractor shall provide all apparatus required for testing of concrete and its ingredients and in particular he must provide the following :

- i) Compression testing machine of minimum capacity of 200 tonnes.
- ii) A complete set of standard sieves.
- iii) Sieve vibrator.
- i) Slump cones. (2 Nos.)
- ii) Adequate number of standard moulds. (12 Nos. Min.)
- iii) Weighing balance. (2 Nos.)
- iv) Curing tanks for cubes.

Any other apparatus deemed necessary by EXECUTIVE ENGINEER, BUILDING DEPARTMENT, BHAVNAGAR MUNICIPAL CORPORATION or its Consultants for proper control shall be provided by the Contractor at his own cost.

In addition to previous stipulations, the Contractor shall be represented at site at all times during the tenure of the contract by responsible and qualified engineers approved by **The** EXECUTIVE ENGINEER, BUILDING DEPARTMENT, BHAVNAGAR MUNICIPAL CORPORATION, BHAVNAGAR Such engineer shall form the Contractor's Project Management & Site Supervisory Team. They shall be in constant attendance upon all activities of the work.

The successful tenderer is bound to carry out any item of work up to any deviation in quantities, for the completion of the job.

The rate quoted shall include the cost of supplying colour photographs and digital photograph of 8" x 10" size including negative to employer after completion of work from various angle one set each to Employer and the architect separately in respect of each floor as directed.

Mix design for various strength requirements shall be done through approved Engineering Research Lab, as approved by Engineer in charge / Project Architect / PMC only at Contractor's cost including all testing charges for the same with maintaining cement consumption as per requirement of IS 456.

For controlled concrete work agency is at liberty to carry out the concrete work by ready mix concrete without any extra / additional cost after approval of Engineer in charge.

The work of landscaping, water proofing & sprinkler irrigation system shall be got executed through specialized agency approved by Engineer in charge / Architect / PMC by the general civil contractor.

Page no. 19 clause no11 of General condition of contract of the tender document- Add other taxes such as VAT, Service tax, WCT etc. to this clause.

The contractor must have to submit details of the electrical, landscaping, water proofing work, anti-termite treatment, sprinkler irrigation work & restoration work agencies involved for approval of Engineer in charge / Project Architect / PMC.

**EXECUTIVE ENGINEER
BUILDING DEPARTMENT
BHAVNAGAR MUNICIPAL CORPORATION**

BHAVNAGAR

PROPOSED DEVELOPMENT OF NIGHT SHELTER AT FULSAR, FOR BHAVNAGAR MUNICIPAL CORPORATION(B.M.C), BHAVANAGAR

SECTION- III

GENERAL TECHNICAL SPECIFICATIONS FOR BUILDING WORKS.

ARCHITECTS:-

CHINTAN SACHAPARA

ARCHITECTS

***3, SHAHIBAUG, ABOVE HOME DÉCOR, WAGHA WADI ROAD,
BHAVNAGAR***

PHONE : 9428401640

GENERAL TECHNICAL SPECIFICATIONS

FOR

BUILDING WORKS

SPECIFICATIONS OF MATERIALS

INDEX

Particulars Page No.

General Technical Specifications-General 5

Standard Technical Specifications 7

M. 1. Water 9

M. 2. Lime 9

M. 3. Cement 9

M. 4. White Cement 9

M. 5. Coloured Cement 9

M. 6. Sand 9

M. 7. Stone Dust 10

M. 8. Stone Grit 10

M. 9. Cinder 11

M. 10. Lime Mortar 11

M. 11. Cement Mortar 11

M. 12. Stone coarse aggregates For Nominal Mix Concrete 11

M. 13. Black trap or equivalent Hard Stone Coarse aggregate For design Mix
Concrete

12

M. 14. Brick bats aggregates 12

- M. 15. Brick 13
- M. 16. Stone 13
- M. 17. Laterite stone 13
- M. 18. Mild Steel Bars 13
- M. 19. High yield strength steel deformed bars 13
- M. 20. High tensile steel wires 13
- M. 21. Mild Steel binding Wires 14
- M. 22. Structural Steels 14
- M. 23. Galvanised iron sheets 14
- M. 23. A G.I. Valleys gutters ridges 14
- M. 24. Asbestos cement sheets 14
- M. 25. Mangalore pattern roof tiles 14
- M. 26. Shuttering 14
- M. 27. Expansion Joints, premodulded Filler 15
- M. 28. Expansion Joints, copper strips & hold Fast 15
- M. 29. Teak wood 15
- M. 29. A Non Teak wood 16
- M. 30. Wooden Flush door shutters (Solid Core) 16
- M. 31. Aluminium Doors, Windows, Ventilators 17
- M. 32. Rolling steel gate 17
- M. 33. Collapsible steel gate 17
- M. 34. Welded steel Write Fabric 17
- M. 35. Expanded metal sheets 18
- M. 36. Mild Steel Wires (Wire gauze Jali) 18
- M. 37. Plywood 18
- M. 38. Glass 18
- M. 39. Acrylic sheets 19
- M. 40. Particle board 19
- M. 41. Expanded polystyrene or Framed sty roper slabs 19
- M. 42. Resign boded Fiber glass 19
- M. 43. Fixtures and Fastening 19
- M. 44. Paints 21
- M. 45. French Polish 21
- M. 46. Marble pipes For marble mosaic terrazzo 21
- M. 47. Flooring tiles 22
- M. 48. Rough Kota stone 23
- M. 49. Polished Kota stone 23

4

Particulars Page No.

- M. 50. Dholpur Stone slab 23
- M. 51. Marble slab 23
- M. 52. Granite stone slab 23
- M. 53. P.V.C. Flooring 24
- M. 54. Facing tiles 24
- M. 55. White glazed tiles 24
- M. 56. Galvanized iron pipes and fitting 25
- M. 57. Bib cooks and stop cock 25
- M. 58. Gun metal Wheel valve 25
- M. 59. while glazed porcelain wash basin 25
- M. 60. European type water closed 25
- M. 61. Orrissa type water closet 25
- M. 62. Indian type water closet 25
- M. 62. A Foot Rests 26
- M. 63. Glazed earthenware sink 26
- M. 64. Glazed earthenware lipped type flat back urinal/Corner type urinal 26
- M. 65. Low level enamel Hushing tank 26
- M. 66. Cast Iron flushing cistern 26
- M. 67. Flush cock 26
- M. 68. Cash iron pipes and fitting 26
- M. 69. Nahni Trap 27
- M. 70. Gulley Trap 27
- M. 71. Glazed stoneware pipes and filling 27
- M. 72. Wall peg rail 27
- M. 73. G. 1. Water spout 27
- M. 74. Asbestos cement pipe (A.C. pipe) 28
- M. 75. Crydon ball valve 28
- M. 76. Bitumen fell for water proofing and damp proofing 28

M. 77. Selected Earth 28
M. 78. barbed-Wire 28

DETAILED SPECIFICATIONS

Section – 4 Excavation 29
Section – 5 Plain & R.C.C. Work 37
Section – 6 Masonry work 50
Section – 7 Rubble masonry work 57
Section – 9 Centering and form work 63
Section – 10 Wood Work, Doors, windows 68
Section – 11 Steel shutters, Windows, Ventilators 78
Section – 12 Labour for fixing fixtures and fastenings 82
Section – 13 Glazing 85
Section – 14 Paving & Floor Finishes 88
Section – 15 Roof Covering 104
Section – 16 Ceiling & Lining 116
Section - 17 Plastering and Painting 119
Section – 18 White washing and Distempering 125
Section – 19 Painting and Polishing 138
Section – 20 Demolition and Disentangling 147
Section – 21 Repairs to Buildings 152
Section – 22 Miscellaneous Buildings items 153
Section – 23 Water Supply, Plumbing and Sanitary fittings 160
Section – 24 Drainage & Sewerage 175
Annexure Equivalent plain area for uneven surface for painting 186
Annexure Schedule of Fixtures & Fastenings for doors, windows, ventilators,
Wardrobes and cupboards 188
5

GENERAL TECHNICAL SPECIFICATIONS FOR BUILDING WORKS

GENERAL:

1. In the specifications "as directed" / "approved" shall be taken to mean "as directed" / "approved by the Engineer-in-Charge".
2. Wherever a reference to any Indian Standard appears in the specifications, it shall be taken to mean as a reference to the latest edition of the same in force on the date of agreement.
3. In "Mode of Measurement" in the specifications wherever a dispute arises in the absence of specific mention of a particular point of aspect the provisions on these particular points, or aspects in the relevant Indian Standards shall be referred to
4. All measurements and computations, unless otherwise specified, shall be carried out nearest to the following limits:
 - (i) Length, width and depth (height) 0.01 meter
 - (ii) Areas 0.01 Sq.Mt.
 - (iii) Cubic Contents 0.01 Cu.Mt.In recording dimensions of work the sequence of length, width and height (depth) or thickness shall be followed.
5. The distance which constitutes lead shall be determined along the shortest practical route and note necessarily

the route actually taken The decision of the Engineer-in-charge in this regard shall be taken as final.

6. Where no lead is specific, it shall mean "all leads"

7. Lift shall be measured from plinth level.

8. Up to "floor two level" means actual height of floor (Maxi 4 M) up to 3 Mt. above plinth level.

9. Definite particulars covered in the items of work, though not mentioned or elucidated in its specifications shall be deemed to be included therein.

10. Reference to specifications of materials as made in the detailed specification of the items of works is in the form of a designation containing them under the specification of the material and prefix 'M' e.g. 'M-5',

11. Approval to the samples of various materials given by the Engineer-in-charge shall not absolve the contractor from the responsibility of replacing defective material brought on site or materials used in the work found defective at a later date. The contractor shall have no claim to any payment or compensation whatsoever on account of any such materials being rejected by the Engineer-in-charge.

12. The contract rate of the item of work shall be for the work completed in all aspects.

13. No collection of materials shall be made before it is got approved from the Engineer-in-charge.

14. Collection of approved materials shall be done at site of work in a systematic manner. Materials shall be stored in such a manner as to prevent damage, deterioration or intrusion of foreign matter and to ensure the preservation of their quality and fitness for the work

15. Materials, if and when rejected by the Engineer-in-charge, shall be immediately removed from the site of work.

16. No materials shall be stored prior to, during and after execution of a structure in such a way as to cause or lead to damage or overloading of the various components of the structure.

17. All works shall be carried out in a workmanlike manner as per the best techniques for the particular item.

18. All tools, templates, machinery and equipment for correct execution of the work as well as for checking lines, levels, alignment of the works during execution shall be kept in sufficient numbers and in good working condition on the site of the work.

19. The mode, procedure and manner of execution shall be such that it does not cause damage or over-loading of the various components of the structure during execution or after completion of the structure.

20. Special modes of construction not adopted in general Engineering practice if proposed to be adopted by the Contractor, shall be considered only if the contractor provides satisfactory evidence that such special mode

6

Of construction is safe, sound and helps in speedy construction and Completion of work to the required strength and quality. Acceptance of the same by the Engineer-in-Charge shall not, however absolve the contractor of the responsibility of any adverse effects and consequences of adopting the same in the course of execution or completion of the work.

21. All installations pertaining to water supply and fixtures there of as well as drainage lines and sanitary fittings shall be deemed to be completed only after giving satisfactory tests by the contractor.

22. The contractor shall be responsible for observing the rules and regulations imposed under the "Minor Minerals Act", and such of the laws and rules prescribed by Government from time to time.

23. All necessary safety measures and precautions (including those laid down in the various relevant Indian Standards) shall be taken to ensure the safety of men. Materials and machinery on the works as also of the work itself.

24. The testing charges of all materials shall be borne by the Contractor.

25. Approval to any of the executed items for the work does not in any way relieve the contractor of his responsibility for the correctness, soundness and strength of the structure as per the drawings and specifications

7

GENERAL

STANDARD TECHNICAL SPECIFICATIONS

Sr. No. of the
item in the
Schedule 'B' of
tender

Sr. No. of
applicable
Specification

Sr. No. of the
item in the
Schedule 'B' of
tender

Sr. No. of
applicable
Specification

Sr. No. of the
item in the
Schedule 'B' of
tender

Sr. No. of
applicable

specification

1 25 49

2 26 50

3 27 51

4 28 52

5 29 53

6 30 54

7 31 55

8 32 56

9 33 57

10 34 58

11 35 59

12 36 60

13 37 61

14 38 62

15 39 63

16 40 64

17 41 65

18 42 66

19 43 67

20 44 68

21 45 69

22 46 70

23 47 71

24 48 72

8

Sr. No. of the
item in the
Schedule 'B' of
tender

Sr. No. of
applicable
Specification

Sr. No. of the
item in the
Schedule 'B' of
tender

Sr. No. of
applicable
Specification

Sr. No. of the
item in the
Schedule 'B' of
tender

Sr. No. of
applicable
specification

73 99 125

74 100 126

75 101 127

76 102 128

77 103 129

78 104 130

79 105 131

80 106 132

81 107 133

82 108 134

83 109 135

84 110 136

85 111 137

86 112 138

87 113 139

88 114 140

89 115 141

90 116 142

91 117 143

92 118 144

93 119 145
94 120 146
95 121 147
96 122 148
97 123 149
98 124 150
9

SPECIFICATIONS OF MATERIALS

M-1. Water

1.1. Water shall not be salty brackish and shall be clean, reasonably clear and free objectionable quantities of silt and traces of oil and injurious alkalis, salts, organic matter and other deleterious material which will either weaken the mortar of concrete or cause efflorescence or attack the steel in R.C.C. Container for transport, storage and handling of water shall be clean. Water shall conform to the standard specified in I.S. 456-1978.

1.2. If required by the Engineer-in-Charge it shall be tested by comparison with distilled water Comparison shall be made by means of standard cement tests for soundness time of setting and mortar strength as specified in I.S. 269-1976. Any indication of unsoundness change in time of setting by 30 minutes or more or decrease of more than 10 per cent in strength, of mortar prepared with water sample when compared with the results obtained with mortar prepared with distilled water shall be sufficient cause for rejection of water under test.

1.3. Water for curing mortar, concrete or masonry should not be too acidic or too alkaline .

It shall be free of elements which significantly affect the hydration reaction or otherwise interfere with the hardening of mortar or concrete during curing or those which produce objectionable stains or other unsightly deposits on concrete or mortar surfaces

1.4. Hard and bitter water shall not be used for curing

1.5. Potable water will generally found suitable for curing mortar or concrete.

M-2. Lime

2.1. Lime shall be hydraulic lime as per I.S. 712-1973 Necessary tests shall be carried out as per I.S. 6932 (Parts I to X) 1973

2.2. The following field tests for limes are to be earned out:

(1) A very rough idea can be formed about the type of lime by its visual examination i.e. fat lime bears pure white colour, lime in form of porous lumps of dirty white colour indicates quick lime, and solid lumps are the unburnt lime stone.

(2) Acid tests for determining the carbonate content in lime Excessive amount of impurities and rough determination of class of lime.

2.3. Storage shall comply with J.S. 712-1973 The slaked lime, if stored, shall be kept in a weather proof and dampproof shed with impervious floor and sides to protect it against rain, moisture, weather and extraneous materials mixing with it. All lime that has been damaged" in any way shall be rejected and all rejected materials shall be removed from site of work.

2.4. Field testing shall be done according to I.S 1624-1974 to show the acceptability of materials.

M-3. Cement

3.1. Cement shall be ordinary Portland slag cement as per I.S.269-1976 or Portland slag cement as per I.S. 455-1976

M-4. White Cement

4.1. The white cement shall conform to I S. 8042-E-1978.,

M-5. Coloured Cement

5.1. Coloured cement shall be with white of grey Portland cement as specified in the item of the work.

5.2. The pigments used for coloured cement shall be of approved quality and shall not exceed 10% of cement used in the mix. The mixture of pigment add cement shall be properly ground to have a uniform colour and shade. The pigments shall have such properties to provide for durability underexposure to sunlight and weather.

5.3. The pigment shall have the property such that it is neither affected by the cement nor detrimental to it

M-6 Sand

6.1. Sand shall be natural sand, clean, well graded hard strong, durable and gritty particles free from injurious amounts of dust, clay kankar nodules, soft or flaky particles shale, alkali salts organic matter, loam, mica or other deleterious substances and shall be got approved from the Engineer-in-Charge. The sand shall not contain more than 8 percent of silt as determined by field test, if necessary the sand shall

10

be washed to make it clean.

6.2. Coarse Sand :The fineness modulus of coarse sand shall not be less than 2.5 and shall not exceed

3 0. The sieve analysis of coarse shall be as under.

I.S. Designation Sieve passing sieve Percentage by weight

Designation

I.S. Sieve Percentage by weight passing Sieve

4.75 mm

2.36 mm

1.18 mm

100

90 to 100

70 to 100
600 micron
300 micron
150 micron
30 - 100
50 - 70
0 - 50

6.3. Fine Sand :

The fineness modulus shall not exceed 1.0 The sieve analysis of fine sand shall be as under.

I.S. Designation Percentage by weight

Sieve passing

I.S. Designation Percentage by weight

Sieve passing

4.75 mm

2.36 mm

1.18 mm

100

100

75 to 100

600 micron

300 micron

150 micron

40 - 85

5 - 50

0 - 10

M-7. Stone Dust

7.1. This shall be obtained from crushing hard black trap or equivalent. It shall not contain more than 8% of silt as determined by field test will measuring cylinder. The method of determining silt contents by fields test is given as under :

7.2. A sample of stone dust to be tested shall be placed without drying in 200 mm. measuring cylinder. The quantity of the sample shall be such that it fills the cylinder up to 100 mm. mark. The clean water shall be added up to 150 mm. mark. The mixture shall be stirred vigorously and the content allowed to settle for 3 hours.

7.3. The height of silt, visible as settled layer above the stone dust shall be expressed as percentage of the height of the stone dust below The stone dust containing more than 8% silt shall be washed so as to bring the content within the allowable limit.

7.4. The fineness modules of stone dust shall not be less than 1.80

M-8. Stone Grit

8.1. Grit shall consist of crushed or broken stone and be hard, strong, dense, durable, clean of proper gradation and free from skin or coating likely to prevent proper adhesion of mortar Grit shall generally be cubical in shape and as far as possible flakey elongated pieces shall be avoided. It shall generally comply with the provisions of I.S. 383-1970.

Unless special stone of particular quarries is mentioned grit shall be obtained from the best black trap or equivalent hard stone as approved by the Engineer-in-charge. The grit shall have no deleterious with cement.

8.2. The grit shall conform to the following gradation as per sieve analysis :

I.S. sieve designation Percentage by weight I.S. Sieve designation Percentage by weight

12,50 mm 100 % 4.75 mm 0-20%

1000 mm 85 - 100% 2.36 mm 0-25%

8.3. The crushing strength of grit will be such as to allow the concrete in which it used to build-up the specified strength of concrete

8.4. The necessary tests for grit shall be carried out as per the requirements of I.S.2386- (parts-I to VIII) 1963, as per instructions of the Engineer-in-charge. The necessity of test will be decided by the Engineer-in-charge.

11

M-9. Cinder

9.1. Cinder is will burnt furnace residue which has been fused or sintered into lumps of varying sizes

9.2. Cinder aggregates shall be well burnt furnace residue obtained from furnace using coal fuel only It shall be sound clean and free from clay dirt, ash or other deleterious matter

9.3. The average grading for cinder aggregates shall be as mentioned below .

I.S. Designation Percentage by weight Sieve

passing

I.S. Designation Percentage by weight

Sieve passing

20 mm

10 mm

100

86

4.75 mm

2.36 mm

70

52

M-10. Lime Mortar

10.1. Lime : Lime shall conform to specification M-2, Water : Water shall conform to specification M-1 and Sand: Sand shall conform to specification M-6

10.2. Proportion of Mix:

10.2.1. mortar shall consist of such proportions of slaked lime and sand as may be specified in item The slaked lime and sand shall be measured by volume

10.3. Preparation of mortar;

10.3.1. Lime mortar shall be prepared by wet process as per I S 1625-1971 .Power driven mill shall be used for preparation of lime mortar. The slaked lime shall be placed in the mill in an even layer and ground for 180 revolutions with a sufficient water. Water shall be added as required during grinding (care being taken not to add more water) that will bring the mixed material to a consistency of stiff paste. Thoroughly wetted sand shall then be added evenly and the mixture ground for another 180 revolutions.

10.4. Storage:

10.4.1. Mortar shall always be kept damp, protected from sun and ram till used up, covering it by tarpaulin or open sheds.

10.5. Use:

10.5.1. All mortar shall be used as soon as possible after grinding. It should be used on the day on which it prepared, But in no case mortar made earlier than 36 hours shall be permitted for use.

M-11. Cement Mortar

11.1. Water shall conform to specification M-1, Cement : Cement shall conform to specifications M-3 and Sand : Sand shall conform to M-6

11.2. Proportion of Mix

11.2.1. Cement and sand shall be mixed to specified proportion, sand being measured by measuring boxes, the proportion of cement will be by volume on the basis of 50 Kg/Bag of cement being equal to 0.0342 Cu.m. The mortar may be hand mixed or machine mixed as directed.

11.3. Proportion of Mortar :

11.3.1. In hand mixed mortar, cement and sand in the specified proportions shall be thoroughly mixed dry on a clean impervious platform by turning over at least 3 times or more till a homogeneous mixture of uniform colour is obtained. Mixing platform shall be so arranged that no deleterious extraneous material shall get mixed with mortar or mortar shall flow out. While mixing, the water shall be gradually added and thoroughly mixed to form a stiff plastic mass of uniform colour so that each particle of sand shall be completely covered with a film of wet cement. The water cement ratio shall be adopted as directed

11.3.2. The mortar so prepared shall be used within 30 minutes of adding water. Only such quantity of mortar shall be prepared as can be used within 30 minutes

M-12. Stone Coarse Aggregate For Nominal Mix Concrete

12.1. coarse aggregate shall be of machine crushed stone of black trap or equivalent and be hard strong, dense, durable, clean and free from skin and coating likely to prevent proper adhesion of mortar

12.2. The aggregate shall generally be cubical in shape Unless special stones of particular quarries are mentioned aggregates shall be machine crushed from the best black trap or equivalent hard stone as approved Aggregate shall have no deleterious reaction with cement. The size of the coarse aggregate for plain cement and ordinary reinforced cement concrete shall generally be as per the table given below.

12

However, in case of reinforced cement concrete the maximum limit may be restricted to 6 mm. less than the minimum lateral clear distance between bars or 6- mm. less than the cover whichever is smaller.

I S. Sieve

Designation

Percentage passing for single

Sized aggregates of Nominal size

I S. Sieve

Designation

Percentage passing for single

Sized aggregates of Nominal size

40 mm 20 mm 16 mm 40 mm 20 mm 16 mm

80 mm - - - 12.5 mm - - -

63 mm 100 - - 10 mm 05 0.20 0.30

40 mm 85-100 100 - 4.75 mm - 0.5 0.5

20 mm 0.20 85-100 100 ' 2.35 mm - - -

16 mm 85-100

Note : This percentage may be varied some what by the Engineer-in-charge when considered necessary for obtaining better density and strength of concrete.

12.3. The grading test shall be taken in the beginning and at the change of source of materials. The necessary tests, indicated in I.S. 383-1970 and 456-197f shall have to be carried out to ensure the acceptability. The aggregates shall be stored separately and handled in such a manner as to prevent the intermixing of different aggregates. If she aggregates are covered with dust, they shall be washed with water to make them clean. .

M-13. Black Trap or Equivalent Hard Stone Coarse

13.1. Aggregate For Design Mix Concrete . Coarse aggregate shall be of machine crushed stone of black trap or equivalent hard stone and be hard, strong, dense, durable, clean and free from skin and coating likely to prevent proper

adhesion of mortar.

13.2. The aggregates shall generally be cubical in shape. Unless special stones of particular quarries are mentioned, aggregates shall be machine crushed, from the best, black trap or equivalent hard stones as approved, Aggregate shall have no deleterious with cement

13.3. The necessary tests indicated in I.S. 383-1970 and I.S.456-1978 shall have to be carried out to ensure the acceptability of the material.

13.4. If aggregate is covered with dust it shall be washed with water to make it clean.

M-14. Brick Bats Aggregate

14.1. Brick bat aggregate shall be broken from well burnt or slightly over burnt and dense bricks. It shall be homogeneous in texture, roughly cubical in shape, clean and free from dirt of any other foreign material. The brick bats shall be of 40 mm - 50 mm. size unless otherwise specified in the item The under burnt or over burnt brick bats shall not be allowed.

14.2. The brick bats shall be measured by suitable boxes or as directed.

M-15. Bricks

15.1. The bricks shall be hand or machine molded and made from suitable soils and kiln burnt. They shall be free from cracks and flaws and nodules of free lime they shall have smooth rectangular faces with sharp corners and shall be of uniform colour.

The bricks shall be moulded with a frog of 100 mm. x 40 mm. and 10 mm. to 20 mm. deep on one of its flat sides. The bricks shall not break when thrown on the ground from a height of 600 mm.

15.2. The size of modular bricks shall be 190 mm.x 90 mm.x 90 mm.

15.3. The size of the conventional bricks shall be as under :

(9" x 4.3/8" x 2,3/4") 225 x 110 x 75 mm.

15.4. Only bricks of one standard size shall be used on one work. The following tolerances shall be permitted in the conventional size adopted in a particular work.

Length + 1/8" (3.0 mm.) Width \pm 1/16" (1.50 mm.) Height + 1/16" (1.50 mm.)

15.5. The crushing strength of the bricks shall not be less than 35 Kg/Sq. Cm. The average water absorption shall not be more the 20 percent by weight Necessary tests for crushing strength and water

13

absorption etc. shall be carried out as per I.S. 3495 (Part-I to IV) - 1976

M-16. Stone

16.1. The stone shall be of the specified variety such as Granite/Trap Stone/ Quartzite or any other type of good hard stones. The stones shall be only from the approved quarry and shall be hard sound, durable and free from defects like cavities, cracks, sand holes, flaws injurious veins, patches of loose or soft materials etc., and weathered portions and other structural defects Or imperfections tending to affect their soundness and strength. The stone with round surface shall not be used. The percentage of water absorption shall not be more than 5% of dry weight. When tested in accordance with I.S. 1124-1974. The minimum crushing strength of stone shall be 200 Kg/.Sq. Cm. unless otherwise, specified

16.2. The samples of the stone to be used shall be got approved before the work is started

16.3. The Khanki facing stone shall be dressed by chisel as specified in the item for khanki facing in required shape and size. The face of the stone shall be-so dressed that the bushing on the exposed face shall not project by more than 40 mm. from the general wall surface and on face to be plastered it shall not project by more than 19 mm. nor shall it have depressions more than 10 mm. from the average wall surface

M-17. Laterite Stone

17.1. Laterite stone shall be obtained from the approved quarry it shall be compacted in texture sound, durable and free from soft patch. It shall have minimum crushing strength of 100 Kg/Sq. Cm. in its dry condition. It shall not absorb water more than 20% of its own weight, when immersed for 24 hours in water. After quarrying, the stone shall be allowed to weather for some time before using in work.

17.2. The stone shall be dressed into regular rectangular blocks so that all faces are free from waviness and unevenness, and the edges true and square

17.3. Those types of stone in which white clay occurs should not be used

17.4. Special corner stones shall be provided where so directed.

M-18. Mild Steel Bars

18.1. Mild steel bars reinforcement for R.C.C. work shall conform to I.S. 432 (Part -II) 1966 and shall be of tested quality. It shall also comply with relevant part of I.S. 456-1978.

18.2. All the reinforcement shall be clean and free from dirt, paint, grease, mill scale or loose or thick rust at the time of placing

18.3. For the purpose of payment, the bar shall be measured correct up to 10 mm. length and weight payable worked out at the rate specified below :

1. 6 mm 0.22 Kg/Rmt. 8. 20 mm. 2.47 Kg/Rmt

2. 8 mm. 0.39 Kg/Rmt. 9. 22 mm. 2.98 Kg/Rmt.

3. 10 mm. 0.62 Kg/Rmt. 10. 25 mm. 3.85 Kg/Rmt.

4. 12 mm. 0.89 Kg/Rmt. 11. 28 mm. 4.83 Kg/Rmt.

5. 14 mm 1.21 Kg/Rmt. 12. 32 mm. 6.31 Kg/Rmt.

6. 16 mm 1.58 Kg/Rmt 13. 36 mm. 7.99 Kg/Rmt. *

7. 18 mm. 2.00 Kg/Rmt. 14. 40 mm. 9.86 Kg/Rmt.

M-19. High Yield Strength Steel Deformed Bars

19.1. High yield strength steel deformed bars shall be either cold twisted other rolled and shall conform to I.S. 1786-

1966 and I.S. 1139-1966 respectively.

19.2. Other provisions and requirements shall conform to specification No. M-18 for Mild Steel Bars.

M-20. High Tensile Steel Wires

20.1. The high tensile wires for use in pre stressed concrete work shall conform to I.S.2090-1962.

20.2. The tensile strength of the high tensile steel bars shall be as specified in the item. In absence of the given strength the minimum strength shall be taken as per Para 6-1 of the I.S. 1785-1962. Testing shall be done as per I.S. requirements.

20.3. The high tensile steel shall be free from loose mill scale, rust, oil, grease, or any other harmful matter. Cleaning of steel bars may be carried out by immersion in solvent solution, wire brushing or passing through
14

a pressure box containing Carborundum.

20.4. The high tensile wire shall be obtained from manufacturers. in coils having diameter not less than 350 times the diameter of wire itself so that wire springs back straight on being uncoiled .

M-21. Mild Steel Binding Wire

21.1. The mild steel wire shall be of 1.63 mm. or 1.22 mm. (16 to 18 gauge) diameter and shall conform to I.S. 280-1972.

21.2. The use of black wire will be permitted for binding reinforcement bars. It shall be free from rust oil paint, grease loose mill scale or any other undesirable coating which may prevent adhesion of cement mortar

M-22. Structural Steel

22.1. All structural Steel shall conform to I.S. 226-1985: The steel shall be free from the defects mentioned in I.S 226-1975 and shall have a smooth finish. The material shall be free from loose mill scale, rust pits or other defects affecting the strength and durability. River bars shall conform to I.S. 1148-1973.

22.2. When the steel is supplied by the Contractor test certificate of the manufacturers shall be obtained according to I.S. 226-1975 and other relevant Indian Standards.

M-23. Galvanised Iron Sheets

23.1. The galvanised iron sheets shall be plain or corrugated sheets of gauges as specified in item The G.I. Sheets shall conform to I.S.277-1977. The sheets shall be undamaged in carnage and handling either by rubbing off of zinc coating or otherwise. They shall have clean and bright surface and shall be free from dents, bends, holes, rust or white powdery deposit.

23.2. The length and width of G.I. sheets shall be as directed as per site condition.

M-23.A :G.I. Valleys gutter, ridges

23.A.1. The G.I. ridges and hips shall be of plain galvanised sheets Class - 3 of the thickness as specified in item. These shall be 600 mm. in width and properly bent up to shape without damage to the sheets in process of bending.

23.A.2. Valleys gutters and flashings shall also be of galvanised sheet of thickness as specified in item Valleys Shall be 900 mm. wide overall and flashing shall be 380 mm. wide overall They shall be bent to the required shape without damage to the sheet in the process of bending.

M-24. Asbestos Cement Sheets

24.1. Asbestos cement sheets plain, corrugated or semi-corrugated shall conform to I.S.459-1970 The thickness of the sheets shall be as specified in the item. The sheets shall be free from all defects such as cracks, holes, deformities chipped edges or otherwise damaged.

24.2. Ridges & Hips :

24.2.1. Ridges and hips shall be of same thickness as that of A.C. sheets. The types, of ridges shall be suitable for the type of sheets and location.

24.2.2. Other accessories to be used in roof such as flashing pieces eaves filler pieces, valley gutters, north light, and ventilator curves, barge boards etc, shall be of standard manufacture and shall be suitable for the type of sheets and location.

M-25. Mangalore Pattern Roof Tiles

25.1. The mangalore pattern tiles shall conform to I S 654-1972 for Class AA or Class A type as specified in item. Samples of the tiles to be provided shall be got approved from the Engineer-in-charge. Necessary tests shall be carried out as directed.

M-26. Shuttering

26.1. The shuttering shall be either of wooden planking of 30 mm. minimum thickness with or without steel lining or of steel plates stiffened by steel angles The shuttering shall be supported on battens and beams and props of vertical bullies properly cross braced together so as to make the centering rigid. In places of bullies props, brick pillar of adequate section built in mud mortar may be used

26.2. The form work shall be sufficiently strong and shall have camber so that it assumes correct shape after deposition of the concrete and shall be able to resist forces caused by vibration of live load of men working over it and other incidental loads associated with it. The shuttering shall have smooth and even
15

surface and its joints shall permit leakage of cement grout

26.3. If at any stage of work during or after placing concrete in the structure, the form work sags or bulges out beyond the required shape of the structure, the concrete shall be removed and work redone with fresh concrete and adequately rigid form work The complete form work shall be got inspected by and got approved from the Engineer-in-charge,

before the reinforcement bars are placed in position

26.4. The props shall consist to bullies having 100 mm .minimum diameter measured at mid length and 80 mm. at thin end shall be placed as per design requirement. These shall rest squarely on wooden sole plates 40 mm. thick and

minimum bearing area of 0-10 sq m laid on sufficiently hard base.

26.5. Double wedges shall further be provided between the sole plate and the wooden props so as to facilitate tightening and easing of shuttering without jerking the concrete

26.6. The timber used in shuttering shall not be so dry as to absorb water from concrete and swell or bulge nor so green or wet as to shrink after erection. The timber shall be properly sawn and planed on the sides and the surface coming in contact with concrete. Wooden form work with metal sheet lining or steel plates, stiffened by steel angles shall be permitted

26.7. As far as practicable, clamps shall be used to hold the forms together and use of nails and spikes avoided.

26.8. The surface of timber shuttering that would come in contact with concrete shall be well wetted and coated with soap solution before the concreting is done. Alternatively coat of raw linseed oil or oil of approved manufacture may be applied in place of soap solution. In case of steel shuttering either soap solution or raw linseed oil shall be applied after thoroughly cleaning the surface. Under no circumstances black or burnt oil shall be permitted.

26.9. The shuttering for beams and slabs shall have camber of 4 mm per meter (1 in 250) or as directed by the Engineer-in-charge so as to offset the subsequent deflection. For cantilevers, the camber at free end shall be 1/50 of the projected length or as directed by the Engineer-in-charge.

M- 27. Expansion Joints - Permoulded filler

27.1. The item provides for expansion joints in R.C.C. frame structures for internal joints, as well as exposed joints, with the use of premoulded bituminous joint filler.

27.2. Premoulded bituminous joints filler i.e. performed strip of expansion joints filler shall not get deformed, or broken by twisting bending or other handling when exposed to atmospheric condition. Pieces of joints filler that have been damaged shall be rejected

27.3. Thickness of the per-moulded joints filler shall be 25 mm. unless otherwise specified.

27.4. Premoulded bituminous joints filler shall conform to I S 1838-1961

M-28. Expansion joints-Copper strips & hold .fasts

28.1. The item provide for expansion joints in R.C.C. frame structure for internal joints, as well as exposed joints, with the use of premoulded bituminous joints filler.

28.2. Copper sheet shall be of 1.25 mm. width and or 1 25 mm. width and the " U " shape in the middle. Copper strip shall have holdfast of 3 m.m diameter copper rod fixed to the plate soldered on strip at intervals of about 30 cm or as shown in the drawing or as directed. The width of each flange (horizontal side) of the copper plate Jo be embedded in the concrete work shall be 25 mm depth of "U" to be provided in the expansion joint, in the copper plate shall be of 25 mm.

M-29. Teak wood

29.1. The teak wood shall be of good quality as required for the item to be executed. When the kind of wood is not specifically mentioned, good Indian teak wood as approved shall be used.

29.2. Teak wood shall generally be free from large, loose dead or cluster knots, flaws, shakes, warps, twists, bends or any other defects. It shall generally be uniform in substance and of straight fibers as far as possible. It shall be free from rot decay, harmful fungi and other defects of harmful nature which will affect the strength, durability or its usefulness for the purpose for which it is required. The colour shall be uniform as far as possible. Any effort like painting using any adhesive materials made to hide the defects shall render the pieces liable to rejection by the Engineer-in-charge.

29.3. All scantlings, planks etc., shall be sawn in straight lines and planes in the direction of grains and of uniform thickness.

16

29.4. The tolerances-in the dimensions shall be allowed at the rate of 1.5 mm. per face to be planed.

29.5. First class teak wood

29.5.1. First class teak wood shall have no individual hard and-sound knots, more than 6 sq. cm. in size and the aggregate area of such knots shall not be more than 1% of area of piece, The timber shall be closed grained.

29.6. Second Class Teak Wood:

29.6.1. No individual hard and sound knots shall be more than 15 sq. cms. in size and aggregates area of such knots shall be not exceed 2% of the area of piece.

M-29. A Non-teak wood:

The non-teak wood shall be chemically treated, seasoned as per I.S. Specifications and of good quality. The type of wood shall be got approved before collecting the same on site. Fabrication of wooden members shall be started only after approval.

For this purpose wood of Bio, Kalai, Sires, Saded, Behda, Jamun, Sisoo will be used for door where as only Kalai, Sires, Halda, Kalam etc. will be permitted for shutters after proper seasoning and chemical treatment.

The non-teak wood shall be free from large loose dead of cluster knots, flows, shakes, warps, bends or any other defects, It shall be uniform in substance and of straight fibers as far as possible It shall be free fro rots, decay, harmful fungi and other defects of nature which will effect the strength, durability or its usefulness for the purpose for which it is required. The colour of wood shall be uniform as far as possible. The scantlings planks etc. shall be saw in straight lines and planes in the direction of grain and of uniform thickness. The department will use the Agency to produce certificate from Forest Department in event of dispute and the decision of the Department shall be final and binding to the contractor. The tolerance in the dimension shall be allowed at 1.5 mm. per face to be planed.

M-30. Wooden flush door shutters (solid core)

30.1. The solid core type flush door shutters shall be of decorative or non-decorative type as specified in the drawing. The size and thickness of the shutter shall be as specified in drawings or as directed. The timber species for core shall be used as per I.S.2202 (part -I) 1980. The timber shall be free from decay and insect attack Knots and knot holes less than half the width of cross-section of the members in which they occur may be permitted. Pitch pockets, pitch streaks

and harmless pin holes shall be permissible except in the exposed edges of the core members. The commercial plywood, cross-bands shall conform to I.S. 303-1275

30.2. The face-panel of the shutters shall be formed by gluing by the hot press process on both faces of the core with either plywood or cross-bands and face veneers. The hopping, rebating, opening of glazing, venation etc., shall be provided if specified in the drawing.

30.3. All edges of the door shutters shall be square. The shutters shall be free from twist or warp in its plane. Both faces of the shutters shall be sand papered to smooth even texture.

30.4. The shutters shall be tested for-

(1) End immersion test: The test shall be carried out as per I.S.2202 (part-1) 1980 There shall be no delamination at the end of the test.

(2) Knife Test : The face panel when tested in accordance with I.S 1659-1979 shall pass the test.

(3) Glue adhesion test : The flush door shall be tested for glue adhesive test in accordance with I S 2202 (part -1) 1980. The shutters shall be considered to have passed the test, if no delamination occurs in the glue lines in the plywood and if no single determination more than 80 mm in length and more than 3 mm in depth has occurred in the assembly glue lines between the plywood face and the style and rail. Delamination at the corner shall be measured continuously around the corner Delamination at the knots, knot hole and other permissible wood defectects shall not be considered in assessing the sample.

30.5. The tolerance in size of scud core type flush door shall-be as under :

In Nominal thickness \pm 1.2 mm. In Nominal height \pm 3m

30.6. The thickness of the shutter shall be uniform throughout with a permissible variation of not more than 0.8 mm when measured at any points.

17

M-31. Aluminum doors, windows, ventilators

31.1. Aluminum alloy used in the manufacture of extruded window sections shall conform to I.S. designation HEAWP of I.S. 733-1975 and also to I.S. Designation WVG-WP of I.S 1285-1975 The section shall be as specified in the drawing and design. The fabrication shall be done as directed

31.2. The hinges shall be cast or extruded aluminum hinges of same type as in window but of larger size.

31.3. The hinges shall normally be of 50 mm. projecting type. Non-projecting type of hinges may also be used if directed. The handles of door shall be of specified design A suitable lock for the door Operable either from outside or inside shall be provided. In double shutter door, the first closing shutter shall have concealed aluminum alloy bolt at top and bottom.

M-32. Rolling Shutters

32.1. The rolling shutters shall conform to I.S.6248-1979 Rolling shutters shall be supplied of specified type with accessories. The size of the rolling shutters shall be specified in the drawings. The shutters shall be specified in the drawings. The shutters shall be constructed with interlocking lath sections formed from cold rolled steel strips not less than 0.9 mm. thick and 80 mm. wide for shutters up to 3.5 m. width not less than 1.25 mm. thick and 80 mm wide for shutters 3.5 m. in width and above unless otherwise specified.

32.2. Guide channels shall be of mild steel deep channel section and of rolled pressed or built up (fabricated) joint less construction The thickness of sheet used shall not be less than 3 15 mm.

32.3. Hood covers shall be made of M.S. Sheets not less than 0.90 mm. thick. For shutters having width 3.5 Meter and above, the thickness of M.S. sheet for the hood cover shall be not less than 1 25 mm.

32.4. The spring shall be of best quality and shall be manufactured from tested high tensile spring steel wire of strip of adequate strength to balance the shutters in all position. The spring pipe shaft etc . shall be supported on strong M S of malleable C I. brackets. The brackets shall be fixed on or under the lintel as specified with-raw! plugs and screws bolts etc.

32.5. The rolling shutters shall be of self rolling up to 8 Sq. m. clear area without ball bearing and up to 12 Sq.m. clear area with ball bearing. If the rolling shutters are of larger, then gear operated type shutters shall be used.

32.6. The locking arrangement shall be provided at the bottom of shutter at both ends The shutters shall be opened from outside.

32.7. The Shutters shall be completed with door suspension shafts, looking arrangements, pulling hooks, handles and other accessories.

M-33. Collapsible Steel Gate

33.1. The collapsible steel gate shall be in one or two leaves and size as per approved drawings or as specified. The gate shall be fabricated from best quality mild steel channels, flats etc. Either steel pulleys or ball-bearings shall be provided in every double channel Unless otherwise specified the particulars of collapsible gate shall be as under.

(a) Pickets : These shall be of 20 mm. M.S. channels of heavy sections unless otherwise shown on drawings. The distance centre to centre of pickets shall be 12 cms .with an opening of 10 Cms

(b) Pivoted M.S. flats shall be 20 mm x6 mm

(c) Top and bottom guides shall be from tee of flat iron of approved size.

(d) The fittings like stoppers fixing, locking cleats, brass handles and cast iron rollers shall be of approved design and size

M-34. Welded Steel Wire Fabric

34.1 Welded steel wire fabric for general purpose shall be manufactured form cold drawn steel wire "as drawn" or galvenised steel conforming to I.S. 226-1975 with longitudinal and transverse wire securely connected at every intersection by a process of electrical resistance welding and conforming to I.S.4948-1974. it shall be fabricated and finished in workmanlike manner and shall be free from injurious defects and shall be rust proof The type of mesh shall be oblong or square as directed The mesh sizes and sizes if wire for square 3b well as oblong welded steel wire fabric

shall be as directed The steel wire fabric in panels shall be in one whole piece in each panel as far as stock sizes permit.

18

M-35 Expanded Metal Sheets

35.1. The expanded metal sheets shall be free from flaws joints broken strands laminations and other harmful surface defects. Expanded metal steel sheet shall conform to IS-412-1975. except that blank sheets need not be with guaranteed mechanical properties The size of the diamond mesh of expanded metal and dimensions of strands (width and thickness) shall be as specified. The tolerance on nominal weight of expanded metal sheets shall be of + 10 percent.

35.2. Expanded metal in panels shall be in one whole piece in each panel as far as stock sizes permit. The expanded metal sheets shall be coated with suitable protective coating to prevent corrosion.

M-36. Mild Steel Wire (Wire Gauze Jali)

36.1. Mild steel wire may be galvanized as indicated. All finished steel wire shall be well cleanly drawn to the dimensions and size of wire as specified in item. The wire shall be sound free from splits surface flaws, rough jagged and imperfect edges and other harmful surface defects and shall conform to I.S. 280-1978.

M-37. Plywood

37.1. The plywood for general purpose shall conform I.S. 303-17-1975.

Plywood is made by cementing together thin boards or strips of wood into panels. There are always an odd number of layers, 3,5,7,9, ply etc. The plies are placed so that grain of each layer is at right angles to the grain in the adjacent level.

37.2. The chief advantages of plywood a single board of the same thickness is the more uniform strength of the plywood, along the length and width of the plywood and greater resistance to cracking and splitting with change in moisture content.

37.3. Usually synthetic resins are used to gluing, phenolic resins are usually cured in a hot press which compresses and simultaneously heats the plies between hot plates which maintain a temperature of 90 degree C to 140 degree C and a pressure of 11 to 14 Kg/ Sq. Cm on the wood. The time of heating may be anything from 2 to 60 minutes depending upon thickness

37.4. When water glue are used the wood absorbs so much water that the finished plywood must be dried carefully. When synthetic resins are used as adhesive the finished plywood must be exposed to an atmosphere of controlled humidity until the proper amount of moisture has been absorbed.

37.5. According to I.S. 303-1975 the plywood for general purpose shall be of the grades namely BWR, WWR and CWR depending up to the adhesives used for bonding the veneers and it will be further classified into six types namely AA, AB, AC, BB, BC and CC based on the quality of the two faces each face being of three kinds namely A, Band C After pressing, the finished plywood should be reconditioned to a moisture content not less than 8 percent and not more than 16 percent.

37.6. Thickness of plywood Boards.

TABLE

Board Thickness Board Thickness Board Thickness Board Thickness

3 ply. 3 mm. 5 ply. 5 mm. 7 ply. 9 mm. 9 ply. 16 mm

4 mm. 6 mm. 13 mm. 19 mm.

5 mm. 7 mm. 16 mm. 11 ply. 19 mm.

6 mm. 8 mm. 9 ply. 13 mm. 25 mm.

M-38. Glass

38.1. All glass shall be of the brief quality, free from specks, bubbles, smokes veins, air holes blisters and other defects. The kind of glass to be used shall be as mentioned in the item or specification or in the special provision or as shown in detailed drawings. Thickness of glass panes shall be uniform. The specifications for different kinds of glass shall be as under.

38.2. Sheet Glass

38.2.1. In absence of any specified thickness or weight in the item or detailed specifications of the item of work, sheet glass shall be weighing 7.5 Kg/Sq. m for panes up to 600 mm x 600 mm.

38.2.2. For panes larger than 600 mm x 600 mm and up to 800 mm x 800 mm the glass weighing not less than 8.75 Kg/Sq m shall be used For bigger panes up to 900 mm x 900 mm. glass weighing not less

19

than 8.75 Kg/Sq. m shall be used. For bigger panes up to 900 mm x 900 mm. glass weighting not less than 11.25 Kg/Sq. m. shall be used

38.2.3. Sheet glass shall be patent flattened glass of best quality and for glazing and framing purposes shall conform to I.S. 1761-1960. Sheet glass of the specified colours shall be used, if so shown, on detailed drawings or so specified For important buildings and for panes with any dimension over 900 mm plate glass of specified thickness shall be used

38.3. Plate Glass:

38.3.1. When plate glass is specified it shall be "polished patent plate glass" of best quality It shall have both the surface ground flat and parallel and polished to obtain clear undisturbed vision and reflection The plate glass shall be of the thickness mentioned in the item or as shown in the detailed drawing or as specified. In absence of any specified thickness, the thickness of plate glass to be supplied shall be 6 mm. and a tolerance of 0.20 mm shall be admissible

38.4. Obscured Glass:

38.4.1. This type of glass transmits light so that vision is partially or almost completely obscured. Glass shall be plain rolled, figured, ribbed or fluted, or frosted glass as may be specified as required. The thickness and type of glass shall be as per details on drawings or as specified or as directed

38.5. Wired Glass:

38.5.1. Glass shall be with wire netting embedded in a sheet of planet glass. Electrically welded 13 mm Georgian square mesh shall be used Thickness of glass shall not be less than 6 mm Wired glass shall be of type and thickness as specified

M-39. Acrylic Sheets

39.1. Acrylic sheets shall be of thickness as specified in the item and of an specified shape and size as the case may be panels may be flat or curved It should be light in weight it shall be colourless or coloured or opaque as specified in the item. Colourless sheet shall be as transparent as the finest optical glass. Its light transmission rate shall be about 95% Transparency shall not be affected for the sheets of larger thickens, it shall be extremely resistant to sunlight weather and low temperatures.

It shall not sow any significant yellowing or change in physical properties or loss of light transmission over a longer period of use. The sheet shall be impact resistant also Sheets should be of such quality that they can be cut, bent jointed as desired Solution for the joints shall be used as per the requirement of manufacturer.

M-40. Particle board

40.1. The particle boards used for face panels shall of best quality free from any defects. "I he particle boards shall be made with phenolmaldehyde adhesive The particle boards shall conform I S 3087-1905" Specification for wood particle board for general purpose" The size and the thickness shall be as indicated.

M-41. Expanded polystyrene or framed styroper slabs

41.1. The expanded polystyrene ceiling boards and tiles shall be of approved make and shall be of sizes, thickness, finish and colour as indicated. It shall be of high density and suitable for use as insulating material. The insulating material shall be like slabs of Thermocole etc.

M-42. Resin bonded fiber glass.

42.1. The resin bonded fiber glass tiles or roils shall be of approved make and shall be of sizes. thickness, and finish as indicated.

42.2. For test of Mineral wool thermal insulation [Blanket I S 3144-1965 shall be followed

42.3. Insulation wool blanks shall be with the following coverings on one or both sides as indicated

(1) Bituminous Hessian Kraft paper suitable for use in position where moisture has to be excluded.

(2) Hessian cloth or Kraft paper for keeping out dust

(3) G.I wire netting, suitable for surfaces to be plaster over

M-43. Fixtures and fastenings

43.1. General:

43.1.1. The fixtures and fastenings, that is butt hinges tee and strap hinges sliding door bolts, tower bolts, door latch, bath-room latch, handles door stoppers, casement window fasteners, casement

20 stays and ventilators catch shall be made of the metal as specified in the item or its specification.

43.1.2. They shall be of iron, brass, aluminum chromium plated iron, chromium plated brass, copper oxidised iron, copper oxidised brass or anodised aluminum as specified

43.1.3. The fixtures shall be heavy medium or light type. The fixtures and fastenings shall be smooth finished and shall be such as will ensue ease of operations.

43.1.4. The samples of fixtures and fastenings shall be got approved as regards, quality and shape before providing them in position

43.1.5. Brass and anodised aluminium fixtures and fastenings shall be bright finished

43.2. Holdfasts:

43.2.1. Holdfasts shall be made from mild steel flat 30 cm length and one of the holdfasts shall be bent at right angle and two nos of 6 mm. diameter holes, shall be made in it for fixing it to the frame with screws. At the other end, the holdfast shall be forked and bent at right angles in opposite directions

43.3. Butt hinges:

43.3.1. Railway standard heavy type butt hinges shall be used when so specified

43.3.2. Tee and strap hinges shall be manufactured from M S Sheet

43.4. Siding door bolts (Aldrops):

43.4.1. The aldrops as specified in the item shall be used and shall be got approved.

43.5. Tower bolts (Barrel Type):

43.5.1. Tower bolts as specified in the item shall be used and shall be got approved

43.6. Door Latch:

43.6.1. The size of door latch shall be taken as the length of latch.

43.7. Bathroom Latch:

43.7.1. Bathroom latch shall be similar to tower bolt.

43.8. Handle:

The size of the handles shall be determined by the inside grip length of the handles. Handles shall have a base plate of length 50 mm. more than the size" of the handle.

43.9. Door Catch:

43.9.1. Door stoppers shall be either floor door stopper type or door catch type Floor stopper shall be of overall size as specified and-shall have a rubber cushion.

43.10. Door Stoppers:

43.10.1. Door catch shall be fixed at a height to about 900 mm from the floor level such that one part of the catch is fitted on the inside of the shutter and the other part is fixed in the wall with necessary wooden plug arrangements for appropriate fixity The catch shall be fixed 20 mm inside the face of the door for easy operation of catch.

43.11. Wooden Door Stop with hinges:

43.11.1. Wooden door stop of size 100 mm x 90 mm x 40 mm shall be fixed on the door frame with a hinges of 75 mm. size and at a height of 900 mm. from the floor level The wooden door stop shall be provided with 3 coats of approved oil paint

43.12. Casement Window Fastener:

43.12.1. Casement window fastener for single leaf window shutter shall be left or right handed as directed

43.13. Casement stays (Straight Red Stay):

43.13.1. The stays shall be made from a channel section having three holes at appropriate position so that the window can be opened either fully or partially as directed. Size of the stay shall be 250 mm to 300 mm. as directed.

43.14. Ventilator Catch:

43.14.1. The pattern and shape of the catch shall be as approved

43.15. Pivot:

43.15.1. The base and socket plate shall be made from minimum 3 mm. thick plate: and projected pivot shall not be less than 12 mm 'diameter and 12 mm. length and shall be firmly riveted to the base plate in

21
case of iron pivot and in single piece plate in the case of brass pivot.

M-44. Paints:

44.1. (A) Oil paints :

44.1.1. Oil paints shall be of the specified colour and as approved The ready mixed paints shall only be used. However, if ready mixed paint of specified shade or tint is not available white ready mixed paint with approved stainer will be allowed In such a case the contractor shall ensure that the shade of the paint so allowed shall be uniform.

44.1.2. All the paints shall meet with the following general requirements

(i) Paint shall not show excessive setting in a freshly opened full can and shall easily be ready spread with a paddle to a smooth homogeneous state. The paint shall show no curdling, levering caking or colour separation and shall be free from lumps and skins

(ii) The paint as received shall brush easily, possess good leveling properties and show no running or sagging tendencies

(iii) The paint shall not skin within 48 hours in a three quarters filled closed container

(iv) The paint shall dry to a smooth uniform finish free from roughness, grit unevenness and other imperfections

44.1.3. Ready mixed paint shall be mixed exactly as received from the manufacturers and generally according to their instructions and without any admixtures whatsoever

44.2. (B) Enamel paints:

44.2.1. The enamel paint shall satisfy in general requirements in specification of oil paints, Enamel paint shall conform to I.S. 2933-1975.

M-45. French Polish

45.1. The French polish of required tint and shade shall be prepared with the below mentioned ingredients and other necessary materials:

(i) Denatured spirit of approved quality (ii) Chandras (iii) Pigment.

45.2. The French polish so prepared shall conform to I S : 348-1 9C8.

M-46. Marble chips for marble mosaic terrazzo

46.1. The marble chips shall be of approved quality and shades. It shall be hard, sound, dense and homogeneous in texture with crystalline and coarse grains It shall be uniform in colour and free from stains cracks, decay and weathering.

46.2. The size of various colours of marble chips ranging from the smallest up to 20 mm shall be used where the thickness of top wearing layer is 6 mm size The marble chips of approved quality and colours only as per grading as decided by the Engineer-in-charge shall be used for marble mosaic tiles or works

46.3. The marble chips shall be machine crushed. They shall be free from foreign matter, dust etc. Except as above, the chips shall conform to I S 2114-1962

M-47. Flooring Tiles

47.1. (A) Plain Cement tiles;

47.1.1. The plain cement tiles shall be of general purpose type. These are the tiles in the manufacture of which no pigments are used. Cement used in the manufacture of tiles shall be as per Indian Standards.

47.1.2. The tiles shall be manufactured from a mixture of cement and natural aggregates by pressure process. During manufacture the tiles shall be subjected to pressure of not less than 140 Kg/Sq. Cm. The proportion of cement to aggregate in the backing of the tiles shall be not less than 1 .3 by weight The wearing face, through the tiles are of plain cement, shall be provided with stone chips of 1 to 2 mm. size. The proportions of cement to aggregate in the wearing layer of the tiles shall be three parts of cement to one parts chips by weight. The minimum thickness of wearing layer shall be 3 mm. The colour and texture of wearing layer shall be uniform throughout its face and thickness. On removal from mould, the tiles shall be kept in moist condition continuously at least for seven days and subsequently, if necessary, for such long period as would ensure their conformity to requirements of I.S.1237-1980 regarding strength resistance to wear and water absorption.

47.1.3 The wearing face of the tiles shall be plane, free from projections, depressions and cracks and shall be reasonably parallel to the back face of the tile. All angles shall be right angle and all edges shall be sharp and true.

22

47.1.4. The size of tiles generally be square shapes 24.85 Cm x24.85 Cm. or 25 Cm x 25 Cm The thickness of tiles shall be 20 mm.

47.1.5. Tolerance of length and breadth shall be plus or minus one millimeter Tolerance on thickness shall be plus

5mm.

47.1.6. The tiles shall satisfy the tests as regards transverse strength, resistance to wear and water absorption as per I.S 1237-1980.

47.2. (B) Plain Coloured Tiles:

47.2.1. The tiles shall have the same specification as for plain cement tiles as per (A) above expect that they shall have a plain wearing surface wherein pigments are used. They shall conform it I.S. 1237-1980.

47.2.2. The pigments used for colouring cement shall not exceed 10 percent by weight of cement used in the mix. The pigments, synthetic or otherwise, used for colouring tiles shall have permanent colour and shall not contain materials detrimental to concrete

47.2.3 The colour of the tiles shall be specified in the item or as directed

47.3. (C) Marble mosaic tiles:

47.3.1. These tiles have same specification as per plain cement tiles except the requirements as stated below

47.3.2. The marble mosaic tiles shall conform to I.S 1237-1980. The wearing face of the tiles shall be mechanically ground and filled. The wearing face of tiles shall be free from projections depressions and cracks and shall be reasonably parallel to the back face of the tiles. All angles shall be right angles and all edges shall be sharp and true.

47.3.3. Chips used in the tiles be from smallest up to 20 mm. size. The minimum thickness of wearing layer of tiles shall be 6 mm. For pattern of chips to be had on the wearing face a few samples with or without their full size photographs as directed shall be approved by the Engineer-in-charge, for approval.

47.3.4. Any particular samples if found suitable shall be approved by the Engineer-in-charge, or he may ask for a few more samples to be presented The samples shall have to be made by the contractor till a suitable sample is finally approved for use in the work. The Contractor shall ensure that the tiles supplied for, the work shall be in conformity with the approved sample only, in terms of its dimensions, thickness of backing layer and wearing surface, materials, ingredients, colour, shade, chips, distribution etc. required.

47.3.5. The tiles shall be prepared from cement conforming to Indian Standards or coloured port land cement generally depending upon the colour of tiles to be used or as directed.

47.4. (D) Chequered Tiles :

47.4.1. Chequered tiles shall be plain cement tiles or marble mosaic tiles. The former shall have the same specification as per (A) above and the latter as per marble mosaic tiles as per (C) except as mentioned below

47.4.2. The tiles shall be of nominal size of 250 mm. x 250 mm. or as specified. The centre to centre distance of chequer shall not be less than 25 mm. and not more than 50 mm. The overall thickness of the tile shall be 22 mm

47.4.3. The grooves in the chequers shall be uniform and straight. The depth of the grooves shall not be less than 3 mm. The chequered tiles shall be plain coloured or mosaic as specified The thickness of the upper layer measured from the top of the chequers shall not be less than 6 mm. The tiles shall be given the first grinding with machine before delivery to site

47.4.4. Tiles shall conform or relevant I.S 1237-1980. 47.5.

(E) Chequered Tiles For Stair Cases :

47.5.1. The requirements of these tiles shall be the same as chequered tiles as per (D) above except in following respects :

(1) The length of a tile including nosing shall be 300 mm (2) The minimum thickness shall be 28 mm (3) The nosing shall have also the same wearing layer as at the top. (4) The nosing edge shall be rounded (5) The front portion of the tile for a minimum length of 75 mm. from and including the nosing shall have grooves running parallel to nosing and at centers not exceeding 25 mm Beyond that the tiles shall have normal chequer pattern.

23

M-48. Rough Kotah Stone

48.1. The Kotah stones shall be hard even, sound, and regular in shape and generally uniform in colour. The colour of the stone shall generally be green Brown coloured shall not be allowed for use They shall be without any soft veins, cracks or flaws.

48.2. The size of the stones to be used for flooring shall be of size 600 mm x 600 mm and/or size 600 mm. x 450 mm as directed However smaller sizes will be allowed to be used to the extent of maintaining required pattern. Thickness shall be as specified

48.3. The edges of stones 30 mm on accounts of chisel dressing of edges shall be permitted for length as well as breadth. Tolerance in thickness shall be + 3 mm

48.4. The edges of stones shall be truly chiseled and table rubbed with coarse sand before paving. All angles and edges of the stones shall be true, square and free from chipping and surface shall be true and plain

48.5. When machine cut edges are specified, the exposed and the edges at joints shall be machine cut The thickness of the exposed machine cut edges shall be uniform

M-49. Polished Kotah Stone

49.1. Polished kotah stone shall have the same specification as per rough kotah stone except as mentioned below

49.2. The stones shall have machine polished surface. When brought on site, the stones shall be single polished or double polished depending upon its use. The stones for paving shall generally be single polished The stones to be used for dado, skirting, sink, veneering, sills steps etc. where machine polishing after the stones are fixed in situ is not possible shall be double polished

M-50. Dholpur Stone Slab

50.1. Dholpur stone slab shall be of best quality as approved by the Engineer-in-charge The stone slab shall be without any veins, cracks, and flaws The stone slab shall be even sound and durable regular in shape and of uniform colour

50.2. The size of the stone shall be as specified in the item or detailed drawing or as approved by the Engineer-in-charge

The thickness of the stone shall be as specified in the item of work with the permissible tolerance of plus or minus 2 mm. The provision in respect of polishing as for polished kotah stone shall apply to polished Dholpur stone also. All angles and edges of the face of the stone slab shall be fine chiseled or polished as specified in the item of work and all the four edges shall be machine cut. All angles and edges of the stone slab shall be true and plane.

50.3. The sample of stone shall be got approved by the Engineer-in-charge for a particular work. It shall be ensured that the stones to be used in a particular work shall not differ much in shade or tint from the approved sample.

M-51. Marble Slab

51.1. Marble slab shall be white or of other and of best quality as approved by the Engineer-in-charge.

51.2. Slabs shall be hard, close, uniform and homogeneous in texture. They shall have even crystalline grain and free from defects and cracks. The surface shall be machine polished to an even and perfect plane surface and edges machine cut true and square. The rear face shall be rough to provide key for the mortar.

51.3. Marble slabs with natural veins, if selected shall have to be laid as per the pattern given by the Engineer-in-charge. Size of the slab shall be minimum 460 mm x 450 mm and preferably 600 mm 'x' 600 mm. However, smaller sizes will be allowed to be used of the extent of maintaining required pattern.

51.4. The slab shall not be thinner than the specified thickness at its thinnest part. A few specimen of finished slab to be used shall be deposited by the Contractor in the office for reference.

51.5. Except as above the marble slabs shall conform to I.S. 1130-1969.

M-52. Granite Stone slab

52.1. Granite shall be of approved colour and quality. The stone shall be hard, even sound and regular in shape and generally uniform in colour. It shall be without any soft veins, cracks or flaws.

52.2. The thickness of the stone shall be specified in items.

52.3. All exposed faces shall be double polished to tender truly smooth and even reflecting surface. The

24 exposed edges and corners shall be rounded off as directed. The exposed edges shall be machine cut and shall have uniform thickness.

M-53. P.V.C. Flooring

53.1. P.V.C. sheets for P.V.C., floor covering shall be of homogenous flexible type conforming to I S 3462-1966. The P.V.C. covering shall neither develop any toxic effect while put to use nor shall give off any disagreeable odour.

53.2. Thickness of flexible type covering tiles shall be as specified in the description of the item.

53.3. The flexible type shall be backed with Hessian or other woven fabric. The following tolerances shall be applicable on the nominal dimensions of the rolls or tiles :

(a) Thickness + 0.15 mm.

(b) Length or Width

(1) 300 mm. Square tiles + 0.20 mm. (3) 900 mm Square tiles + 0.60 mm.

(2) 600 mm. Square tiles + 0.40 mm. (4) Sheets and roll + 0.10 percent.

53.4. Adhesive:

53.4.1. The adhesive for PVC flooring shall be of the type and make recommended by the manufactures of PVC sheets/tiles.

M-54. Facing Tiles

54.1. The facing tiles (burnt clay facing bricks) shall be free from cracks, and nodules of free lime. They shall be thoroughly burnt and shall have plane rectangular faces with parallel sides and sharp straight right angled faces. The texture of the finished surface that will be exposed when in place shall conform to an approved sample consisting not less than for stretcher bricks each representing the texture desired. The facing tiles shall have a pleasing appearance, sufficient resistance to penetration by ram and greater durability than common bricks. The tiles shall conform to I.S. 2691-1972.

54.2. The standard size of facing brick tiles shall be 19 x 9 x 4 cms. The facing brick tiles shall be provided with frog which shall conform to I.S. 11077-1976.

54.3. The permissible tolerance in dimensions specified above shall be as follows:

Size Tolerance for

1st Class Brick 2nd Class Brick

19 cm. + 6 mm. + 10 mm.

9 cm. + 3 mm. + 7 mm.

4 cm. + 1.5 mm. + 3 mm.

The tolerance for distortion or warpage of face or edges of individual brick from a plane surface and from a straight line respectively shall be as follows:

Facing dimensions Permissible tolerance

Max. below 19 cms. Max. 2.5 mm.

-do- above 19 cms. Max. 3.0 mm.

54.5. The average compressive strength obtained as a sample of five tiles when tested in accordance with the procedure laid as per I S 1077-1976 shall be not less than 175 Kg/Sq Cm. The average compressive strength of any individual bricks shall be not less than 160 Kg / Sq.Cm.

54.6. The average water absorption for five bricks tiles shall not exceed 12 percent of average weight of brick before testing. The absorption for each individual bricks shall not exceed 25 percent.

54.7. The brick tiles when tested in accordance with I.S. 1077-1976, the rate of efflorescence shall not be more than "Slightly effloresced"

M-55. White glazed tiles

55.1. The tiles shall be of best quality as approved by the Engineer-in-charge. They shall be flat and true to shape

They shall be free from cracks, crazing sports chipper) edges and corners. The glazing shall be of uniform shade.

55.2. The tiles shall be nominal size of 150 mm x 150 mm unless otherwise, specified. The maximum

25

variation the stated sizes other than the thickness of tile shall be plus or minus 1.5 mm. The thickness of tile shall be 6 mm. Except as above the tiles shall conform to I.S. 1977-19/0

M-56. Galvanised iron pipes and fittings

56.1. Galvanised iron pipes shall be of the medium type and of required diameter and shall comply with I.S. 1239-1979. The specified diameter of the pipes shall refer to the inside diameter of the bore. Clamps, screw and all galvanised iron fittings shall be of the standard 'R' or equivalent make

M-57. Bib cock and stop cock

57.1. A bib cock is a draw off tap with a horizontal inlet and free outlet A stop cock is a valve with suitable means of connection for insertion in a pipe line for controlling or stopping the flow

57.2. They shall be of screw down type and of brass chromium plated and of diameter as specified in the description of the item. They shall conform to I.S. 781-1977 and they shall be of best Indian make. They shall be polished bright.

57.3. The minimum finished weight of bib cock and stop cock shall be as given below

Diameter Bib cock Stop cock Diameter Bib cock Stop cock

8 mm 0.25 kg. 0.25 kg. 15 mm 0.40 kg. 0.40 kg.

10 mm 0.30 kg. 0.35 kg. 20 mm 0.75 kg. 0.75 kg.

M-58. Gun metal wheel valve

58.1. The gun metal wheel valve shall be of approved quality. These shall be of gun metal fitted with wheel and shall be of gate valve opening full way and of the size specified. These shall conform to I.S. 778-1971.

M-59. White glazed porcelain wash basin

59.1. Wash basin shall be of white porcelain first quality best Indian make and it shall conform to I.S. 2556 (Part -IV) -1972 and I.S. 771-1979. The size of the wash basin shall be as specified in item. Wash basin shall be of one piece construction with continued over flow arrangements All internal angles shall be designed so as to facilitate cleaning. Wash basin shall have single tap hole as specified. Each basin shall have a circular waste hole which is either riveted or beveled internally with 65 mm. diameter at top and 10 mm. depth to suit the waste fitting. The necessary stud slot to receive the bracket on the under side of the basin shall be provided Basin shall have an internal soap holder which shall fully drain into the bowl.

59.2. White glazed pedestal of the quality and colour as that the basin shall be provided where specified in the item. It shall be completely recessed at the back for reception of supply and wash pipe. It shall be capable of supporting the basin rigidly and adequately and shall be so designed as to make the height from the floor the floor to top of the rim of basin 750 mm. to 800 mm. as directed.

M-60. European type water closet/with low flushing

60.1. The European type water closet shall be white glazed porcelain first quality and shall be of wash down type conforming to I.S. 2556-1973 and I.S. 771-1979

60.2. 'S' trap shall be provided as required with water seal not than 50 mm. The solid plastic seat and cover shall be of best Indian make conforming to I.S. 2548-1980. They shall be made of moulded synthetic materials which shall be tough and hard with high resistance to solvents and shall be free from blisters and surface defects and shall have chromium plated brass hinges and rubber buffer of suitable size.

M-61. Orrissa type water closet

61.1. The Specification of Orrissa type white glazed water closet of first quality shall conform to I.S. 2256 (Part-III) -1981 and relevant specification of Indian type water closet except that pan will be with the integral squatting pan of size 580 mm x 400 mm with raised footrest.

M-62. Indian type water closet

62.1. The Indian type white glazed water closet of first quality shall be of size as specified in the item and conforming to I.S. 771-1979 and I.S. 2556 – (Part-II) 1981. Each pan shall have integral flushing. It shall

26

also have an inlet at back an or front for connecting flush pipes as directed. The inside of the bottom of the pan shall have sufficient slope from the front towards the outlet and surface shall be uniform and smooth. Pan shall be provided with 100 mm. diameter 'P' or 's' trap with approximately 50 mm. Water seal and 50 mm. diameter vent horn.

M-62. A. Foot Rests

62.A.1. A pair of whit glazed earthen ware rectangular foot to minimum size 250 mm.x 130 mm. x 20 mm shall be provided with the water closet.

M-63. Glazed Earthen Ware Sink

63.1. The glazed earthen-ware sink shall be of specified size, colour and quality. They sink shall conform, to I.S. 771 part – II – 1979. The brackets for sinks shall conform to I.S 775-1970

63.2. The pipes shall conform to I.S. 1239-part-I 1973 and I.S. 404-1962. for steel and lead pipes respectively. 32 mm. brass waste coupling of standard pattern with brass chain and rubble plug shall be provided with sink.

M-64. Glazed earthen-ware Lipped type flat back urinal/corner type urinal

64.1. The lipped type urinal shall be fiat back or corner type as specified in the item and shall conform to I.S 771-1979. It shall be of best Indian make and size as specified and approved by the Engineer-in-charge. The flat back of corner type urinal must be of 1st quality free from any defects, cracks etc.

M-65. Low level Enamel flushing tank

65.1. The low level enamel flushing tank shall be of 15 liters capacity. It shall conform of I S 774-1971. The flushing cistern shall be of best quality and free from any defects. The flushing tank shall have outlet 32 mm. diameter. The outlet shall be connected with W.C. pan by lead pipe or P.V.C. pipe as specified. The flushing tank shall be provided

with inlet and outlet for fixing G.I. inlet pipes and over-flow pipes. The flushing cistern shall be provided with chromium plated handle for flushing. The flushing tank shall be provided with bracket of cast iron so that it can be fixed on wall at specified height. The brackets shall conform to I.S. 775-1970.

M-66. Cast iron flushing cistern.

66.1. The cast iron flushing cistern shall be of 15 liters capacity. It shall conform to I.S. 774-1971. The flushing cistern shall be of best quality free from any defects. The flushing cistern shall have outlet of 32 mm diameter. The lead pipe shall conform to I.S. 404 (Part-I) - 1962; For fixing G.I. inlet pipes and overflow pipe 20 mm. dia. inlet and outlet shall be provided. The flushing cistern shall be provided with galvanised iron chain and pull of sufficient length and shall be got approved from the Engineer-in-charge. The cast iron flushing cistern shall be painted with one coat of anticorrosive paint and two coats of paints. The flushing cistern shall be fixed on two C I brackets. The C I brackets shall conform to I.S. 775-1970.

M-67. Flush cock.

67.1. Half turn flush cock (Heavy weight) shall be of gun metal chromium plated of diameter as specified in the description of the item. The flush cock shall conform to relevant Indian Standard.

M-68. Cast iron pipes and fittings.

68.1. All soil water, vent and anti syphonage pipes and fitting shall conform to I.S. 1729-1964. The pipes shall have spigot and socket ends with head on spigot end. The pipes and fitting shall be true to shape smooth, cylindrical, their inner and outer surfaces being as nearly as practicable concentric. They shall be sound and nicely cast and shall be free from cracks, laps, pinholes or there imperfection and shall be neatly dressed and carefully fettled.

68.2. The end of pipes and fittings shall be reasonable square to their axis.

68.3. The sand of cast iron pipes shall be of the diameter as specified in the description and shall be in lengths of 1.5 M., 1.8 M. including socket ends of the pipe unless shorter lengths are either specified or required at junctions etc. The pipes and fittings shall be supplied without ears unless specified or directed otherwise.

27

68.4. Tolerances :

68.4.1. The Standard weights and thickness of pipes shall be as shown in the following table
A tolerance up to minus 10 per cent may however be -allowed against these standard weights

Sr. No.	Nominal dia. of bore	Thickness Overall
1.	1.5 m. long	Weight of pipe
2.	1.8 m long	excluding ears
3.	2.m long	
4.	1.	
5.	2	
6.	75 mm.	
7.	100. mm.	
8.	5.0 mm.	
9.	5.0 mm.	
10.	12.38 Kg.	
11.	18.14 Kg.	
12.	16.52 Kg.	
13.	21.67 Kg.	
14.	18.37 Kg.	
15.	24.15 Kg.	

68.4.2. A tolerance up to minus 15 percent in thickness and 20 mm. length will be allowed. For fittings tolerance in lengths shall be plus 25 mm. and minus 10 mm.

68.4.3. The thickness of fittings and their socket and spigot dimensions shall conform to the thickness and dimensions specified for the corresponding sizes of straight pipes. The tolerance in weights and thickness shall be the same as for straight pipes.

M-69. Nahni Trap

69.1. Nahni trap shall be of cast iron and shall be sound and free from porosity or other defects which affect serviceability. The thickness of the base metal shall not be less than 6.5 mm. The surface shall be smooth and free from craze, chips and other flaws or any other kind of defects which affect serviceability. The size of nahni trap shall be specified and shall be of self cleaning design.

69.2. The Nahni trap shall be of-quality approved by the Engineer-in-charge and shall generally conform to the relevant Indian Standards.

69.3. The Nahni trap provide shall be with deep seal, minimum 50 mm. except at places where trap with deep seal cannot be accommodated. The cover shall be cast iron perforated cover shall be provided on the trap of appropriate size.

M-70. Gully Trap

70.1. Gully trap shall conform to I.S. 651-1980. It shall be free from defects such as fire-cracks or hair cracks. The glaze of the traps shall be free from crazing. They shall give a sharp clear note when struck with light hammer. There shall be no broken blisters.

70.2. The size of the gully trap shall be as specified in the item.

70.3. Each gully trap shall have one C.I. grating of square size corresponding to the dimensions, of inlet of gully trap. It will also have a water tight C.I. cover with frame inside dimensions 300 mm. x 300 mm. the cover with frame inside dimensions 300 mm. x 300 mm. the cover and weighing not less than 4.53 Kg. and the frame not less than 2.72 Kg. The grating cover and frame shall be of sound and good casting and shall have truly square machined seating faces.

M 71. Glazed Stone Ware pipe And Fittings

71.1. The pipes and fittings shall be of best quality as approved, by the Engineer-in-charge. The pipe shall be of best quality manufactured from stone- ware of fire clay, salt glazed thoroughly burnt through the whole thickness, of a close, even texture, free from air blows, fire blisters, cracks and other imperfections, which affect the serviceability. The inner and outer surfaces shall be smooth and perfectly glazed. The pipe shall be capable to withstand pressures or 1.5 M lead without showing sign of leakage. The thickness of the wall shall not be less than 1/12th of the internal dia. The depth of socket shall not be less than 38 mm. The socket shall be sufficiently large to allow a joint of 6 mm. around the pipe.

71.2. The pipes shall generally conform to relevant I S 651-1980.

M-72. Wall Peg Rail

72.1. The aluminum wall peg rail shall have three aluminum pegs approved quality and size. It shall be fixed on teakwood plank of size 450 mm x 75 mm x 20 mm. The teakwood shall be French polished or oil painted as specified.

M-73. G.I. Water Spot

73.1. The G.I. pipes of 40 mm dia shall be of medium quality and specials shall be of 'R' brand or equivalent brand of best approved quality

28

73.2. The pipe shall have length as required for the thickness of wall in which it is fixed and at outside end tee bend cut at half the length shall be provided and at other end coupling shall be provided to have better fixing. The water spout shall be provided as per detailed drawing or as directed

M-74. Asbestos Cement pipe (A.C. pipe)

74.1. The asbestos cement pipe of diameter as specified in the description of the item shall conform to I.S. 1626-1980. Special like bends, shoes, cowls, etc. shall conform to relevant Indian Standards The intent of pipe shall have is smooth finish, regular surface and regular internal diameter. The tolerance in all dimensions shall be as I.S. 1626-part-I-1980.

M-75. Crydon Ball valve

75.1. Ball valve of screwed type including polythene float and necessary level etc shall be of the size as mentioned in the description of item and shall conform to I.S 1703-1977

M-76. Bitumen Felt For Water proofing And Damp Proofing

76.1. Bitumen felt shall be on the fiber bases and shall be of type 2, self finished felt grade-2 and shall conform to I.S. 1322-1970

M-77. Selected Earth

77.1. The selected earth shall be that obtained from excavated material or shall have to be brought from outside as indicated in the items If item does not indicate anything the selected earth shall have to be brought from outside.

77.2. The selected earth shall be good yellow soil and shall be got approved from the Engineer-in-charge. In no case black cotton soil or similar expansive and shrinkable soil shall be used. It shall be clean and free from all rubbish and perishable materials, stones or brick bats. The clods shall be broken to a size of 50 mm or less. Contractor shall make his own arrangement at his own cost for land for borrowing selected earth. The stacking of material shall be done as directed by the Engineer-in-charge in such a way not to interfere with any construction all activities and in proper stacks.

77.3. When excavated material is to be used only selected stuff got approved from the Engineer-in-charge shall be used. It shall be stacked separately and shall, comply with all the requirements of selected earth mentioned above

M-78. Barbed Wire

78.1. The barbed wire shall be of galvanised steel and it shall generally conform to I.S. 278-1978. The barbed wire shall be of types-I whose nominal diameter for line wire shall be 2.5 mm. and point wire 2.24 mm. The nominal distance between two barbs shall be 75 mm unless otherwise specified in the item. The barbed wire shall be formed by twisting together two fine wires. One containing the barbs. The size of the line and point wires and barb spacing shall be as specified above. The permissible deviation from the nominal diameter of the line wire and point wire shall not exceed + 0.08 mm

78.2. The barbs shall carry four points and shall be formed by twisting two point wires, each two turns tightly round one line wire making altogether four complete turns. The barbs shall have a length of not less than 13 mm and not more than 18 mm. The point shall be sharp and cut at an angle not greater than 35 degree of the axis of the wire forming the barbs.

78.3. The line and point wires shall be circular in section, free from scale and other defects and shall be uniformly galvanized. The line wire shall be in continuous length and shall not contain any welds other than those in the rod before it is drawn. The distance between two successive splices shall not be less than 15 meters.

78.4. The lengths per 100 Kg. of barbed wire I.S. type I shall be as under:
Nominal 1000 meter Minimum 934 meter Maximum 1066 Meter.

29

SECTION -4

Excavation

4.0.0. (A) Excavation for foundation up to 1.5 M. depth including sorting out and stacking of useful materials and disposing of the excavated stuff up to 50 meter lead in loose or soft soil.

1.0. General

1.1. Any soil which generally yields to the application of pickaxes and shovels, phawaras rakes or any such ordinary excavating implement or organic soil, gravel silt, sand turf loam, clay, peat etc., fall under this category

2.0. Clearing the site

2.1. The site on which the structure is to be built shall be cleared, and all obstructions loose stone, materials and rubbish of all kind bush wood and trees shall be remove! as directed The materials so obtained shall be property of the Government and shall be conveyed und stacked as directed within 50 m lead. The roots of the trees coming in the sides shall be cut and coated with a hot asphalt

2.2. The rate of side clearance is deemed to be included in the rate of earth work for which no extra will be paid.

3.0. Setting out

After clearing the site the centre lines will be given, by the Engineer-in-charge. The contractor shall assume full responsibility for alignment, elevation and dimension of each and all 'parts of the work. Contractor shall supply labours materials, etc. required for setting out the reference marks and bench 'marks and shall maintain them as long as required and directed.

4.0. Excavation

The excavation in foundation shall be carried out in true line and level and shall have the width and depth as shown in the drawings or as directed. The contractor shall do the necessary shoring and shutting or providing necessary slopes to a safe angle, at his own cost. The payment for such precautionary measures shall be paid separately it not specified. The bottom of the excavated area shall be leveled both longitudinally and transversely as directed by removing and watering as required No. earth filling will be allowed for brining it to level If by mistake or any excavation is made deeper or wider than, that shown on the plan or directed. The extra depth or width shall be made up with concrete of same proportion as specified for the foundation concrete at the cost of the contractor. The excavation up to 1.5 m depth shall be measured under this item.

5.0. Disposal of the excavated stuff

5.1. The excavated stuff of the selected type shall be used in filling the trenches and plinth or leveling the ground in layers including ramming and watering etc.

5.2. The balance of the excavated quantity shall be removed by the contractor from the site of work to a place as directed with lead up to 50 M. and all lift.

6.0. Mode of measurements & payment

6.1. The measurement of excavation in trenches for foundation shall be made according to the sections of trenches shown on the drawing or as per sections given by the Engineer-m-charge. No payment shall be made for surplus excavation made in excess of above requirements or due to stopping and sloping back as found necessary on account of conditions of soil and requirements of safety.

6.2. The rate shall be for a unit of one cubic meter

4.0.0. (B): Excavation for foundation up to 1.5 M. depth including sorting out and stacking of useful materials and disposing of the excavated stuff up to 50 meter lead in dense or hard soil.

1.0. Dense or Hard Soil

Any soil which generally require close application of picks or jumpers or scarifies to. loosen it stiff clay, gravel and stone etc. fall under this category.

2.0. Workmanship

The relevant specifications of item No. 4.0.0.(A) shall be followed except that the excavation work shall be carried out in dense or hard soil,

3.0. Mode of measurements & payment

3.1. The relevant specifications of item No. 4.0.0. (A) shall be followed

3.2. The rate shall be for unit of one cubic meter.

4.0.0.(C): Excavation for foundation up to 1.5 M. depth including sorting out and stacking of useful

30

materials and disposing of the excavated stuff up to 50 meter lead in hard murrum.

1.0. Hard murrum.

The hard murrum shall be clean of good binding quality and of approved quality obtained from approved quarries of disintegrated rocks which contain sons materials and natural mixture of clay of clarions origin The size of hard murrum shall not be more than 20 mm.

2.0. Workmanship

The relevant specification of item No. 4.0..0.(A) shall be followed except that the excavation work shall be carried in hard murrum.

3.0. Mode of measurements & Payments

3.1. The relevant specifications of item No. 4 0.0. (A) shall be followed.

3.2. The rate shall be for a unit of one cubic meter.

4.0.0.(D): Excavation for foundation up to 1.50 M. depth including sorting out and stacking of useful materials and disposing of the excavated stuff up to 50 meter lead-soft rock not requiring blasting.

1.0. Workmanship

1.1. The relevant specifications of item No. 4.0.0.(A) shall be followed except that the excavation shall be earned out for foundation upon 1.5 M lift in soft rock not requiring blasting

1.2. The excavation in soft or disintegrated rock shall be carried out by crow bars, pickaxes or pneumatic drills or any other suitable means

1.3. If contractor desires to resort to blasting, he can do so with permission of the Engineer-in-charge but nothing extra shall be paid to him.

1.4. The materials available from soft excavation shall be properly stacked within 50 M. lead and 1 5 m. lift and shall be the property of department.

1.5. The classification of strata of the foundation soil shall be done by the Engineer-in-charge and shall be acceptable to the contractor

1.6. However this shall include the type of rock and boulder which may quarried or split with crow bars. Laterite and conglomerate also come under this category.

2.0. Mode of measurements & Payment

2.1. The relevant specifications of item No. 4.0 0 (A) shall be followed.

2.2. The rate shall be for a unit of one cubic metre.

4.0.0.(E): Excavation for foundation up to 1.5 M. depth including sorting out and stacking of useful material and disposing of the excavated stuff up to 50 meter lead in hard rocks.

1.0. Workmanship

1.1. The relevant specification of item No. 4.0.0.(A) shall be followed except that the excavation for foundation work shall be carried out in hard rock.

1.2. Excavation shall be done by blasting to the dimensions shown in the drawings or as directed. The blasting shall be carried out only with written permission of the Engineer-in-charge. All the laws, regulations etc.,- pertaining to the precautions, acquisition, transport, landing and use of explosive shall be rigidly followed. The Magazine for the storage of the explosive shall be built to the design and specifications of explosive authority and located at the approved site No unauthorised persons shall be admitted into the magazine and when not in use it shall be kept securely locked No matches or inflammable materials shall be allowed in Magazine. The Magazine shall have an effective lightning conductor. The rules of explosive 1940 revised from time to time shall be followed strictly for obtaining starting, handling, undertaking blasting work.

1.3. The contractor shall be responsible for damage to property, workmen public due to any accident due to use of explosives and operations

1.4. Precautions

1.4.1. The blasting operation shall remain in charge of competent and experienced supervisor and workmen who are thoroughly acquainted with the detail of handling explosive and blasting operations. The blasting shall be carried out during fixed hours of the day, preferably during the mid-day lunch hours or at the close of the work as ordered in writing by the Engineer-in-charge. The hours of blasting shall be notified in advance to the people in the vicinity. All the charges shall be prepared by the man in charge only.

1.4.2. Red danger flags shall be displayed prominently in all directions during the blasting operations.

1.4.3. People except those who actually light the fuse shall be prohibited from entering into this area. The flags shall be stationed at 200 m. from the firing-site in all directions and all persons including workmen shall be excluded from the flagged area at least 1.0 minutes before the firing warning whistle being sounded for this purpose

1.4.4. During excavation in rock by blasting, the lowest 15 cm. of strata shall be blasted with light charge so

31

as not to shatter or weaken the underlying rock on which the foundation will be actually laid If excavation in rock is done to large widths and length than those shown on the drawings or as directed, no payment shall be made for such over break. If excavation is done to depths greater than shown on the drawings or directed, excess depth shall be made up with foundation grade concrete as directed at the contractor's cost.

1.4.5. The charged hole shall be drilled to the required depth and in suitable places when blasting is done with powder, the fuse cut to the required length shall be inserted in the holes and the powder dropped in. The powder shall be gently tamped with copper rod with rounded ends. The explosive powder shall then be covered with trapping materials which shall be tamped lightly out firmly. When blasting is done with dynamite and other high explosive, dynamite cartridges shall be prepared by inserting the square cut ends of fuse into the detonator, and finished with dippers at the open ends The detonator should be gently pushed into the detonator and finished with dippers at the opened ends. The detonator should be gently pushed explosive. Bore holes shall be of such size that the cartridges can be easily passed down. The holes shall be cleared of all debris and explosive inserted The space for about 20 cms, above the charge shall then be gently filled with dry clay pressed home and rest of tamping is with firm any convenient materials gently packed with a wooden cover.

1.4.6. At a time not more than 10 such charge shall be prepared and fired. The man in charge shall blow a whistle in a recognised manner for cautioning the people. All the people shall then be required to move to number of explosions. He shall satisfy himself that all the charges have been exploded before allowing the workmen to go to the work site.

1.4.7. The contractor shall be fully responsible to strictly follow the prevailing rules and procedures regarding blasting procedures

1.5. Misfire

1.5.1. In case of a misfire the following procedure shall be observed :

1.5.2. Sufficient time shall be allowed to account for the delayed blast. The man in charge shall inspect all the charges and determine the missed charge.

1.5.3. If it is the blasting powder charge it shall be completely flooded with water. A new hole shall be drilled at, about 45 cm. from the old and fired. This should blast the old charge Should it not blast the old charge, the procedure shall be repeated till the old charge is blasted.

1.5.4. In case of charge of gelatins, dynamite etc, the man in charge shall gently remove the tamping and the primer with detonator and primer shall then be used to blast the charge. Alternatively the hole may be cleared of one foot of tamping and the direction then ascertained by placing a stick in the hole Another hole may then be drilled 15 cm away and parallel to it. The man in charge shall report to the office all cases of misfire and cause of the same and what steps were taken in connection therewith.

1.5.6. If a misfire has been found to be due to defective or dynamite, the whole quantity in the box from which defective article was taken must be sent to authority as directed for inspection to ascertain whether all the remaining materials in the box are also defective or not.

1.6. Accidents:

1.6.1. The contractor shall be solely responsible for any accident during the entire procedure of handling explosive and blasting and shall pay necessary compensation to persons affected or damage to lands or property etc, due to the blasting, without extra claims on the department.

1.7. Account:

1.7.1. A careful and day to day account of explosives shall be maintained by the contractor in an approved manner and shall be open to inspection of the Engineer-in charge. Surprise visits may also be paid by the Engineer-in-charge to the storage and in case of any unaccountable shortage or unsatisfactory accounting, the contractor shall be liable to be penalised by forfeiture of part or whole of his Security Deposit or by cancellation of tender in which case he shall not be entitled for any compensation .-

1.8. Disposal of Excavated Materials:

1.8.1 No materials excavated from foundation trenches of whatever kind they may be, are to be placed even temporarily nearer than 1.5 m. or distance prescribed by the Engineer from the outer edge of excavation. All materials excavated shall remain the property of Government. Rate for excavation includes sorting out of useful materials and stacking them separately as directed within the specific lead. Materials suitable and useful for backfilling or other use shall be stacked in convenient places but not in such a way as to obstruct free movement of men, animals and vehicles or encroach upon the area required for constructional purpose. The site shall be left clean of all debris on completion.

1.8.2. Disposal of excavated materials is subject to the following :

32

Unsuitable materials obtained from clearing site and excavation shall be disposed off within a lead of 50 meters as directed. Useful materials obtained from clearing site and excavation shall be stacked within a lead of 50 M beyond the building areas as directed. Materials suitable for back-filling shall be stacked at convenient places within a lead of 50 M. from the structure for reuse. Useful stones from rock excavation shall be stacked neatly. within a lead of 50 M. and will be allowed to be used by the contractor on payment at rates laid down in the contract or if not so laid down, at scheduled rates of the Division or at a mutually agreed rates if there are no such rates in the schedule of rates.

1.8.3. If surplus materials are required to be conveyed beyond 50 M, conveyance will be paid for under a separate item

2.0. Mode of measurements & Payment

2.1. The work shall be measured for the work limited to the dimensions shown on drawings or directed. Excavation to dimension in excess of the above will not be measured or paid for and if so ordered by the Engineer the contractor shall have to fill up the excess depth with cement concrete specified for foundation without extra payment.

2.2. Driving of sounding bars, drill holes to explore the nature of substratum up to a total length of meter distributed in 2 or 3 places in each foundation if necessary, will be considered incidental work and will not be paid for separately.

2.3. Removal of slips and blows in the foundation trenches will not be measured or paid for.

2.4. If it is necessary in the opinion of the Engineer-in-charge to carry foundation below the levels shown on the plans, the excavations for the 1.5 M of addition depth will be included in the quantity for the particular classification and will be paid for as extra at rate to be decided under the general conditions of contract unless, the contractor is willing to accept payment as tendered rates.

2.5. The rate shall be for a unit of one cubic meter

4.0.0.1.(A): Excavation for foundation for depth from 1.5 M. to 3.0 M. including sorting out and stacking of useful materials and disposing of the excavated stuff up to 50 M. lead-loose or soft soil.

1.0. Workmanship

1.1. The relevant specifications or item No. 4.0.0. (A) shall be followed except that the excavation work shall be carried out to loose or soft soil with lift 1.5 M. to 3.0 M.

2.0. Mode of Measurement & Payment

2.1. The relevant specifications of item No. 4.0.0.(A) shall be followed.

2.2. The excavation work of from 1.5 M. to 3.0 M. shall be measured under this item

2.3. The rate shall be for a unit of one cubic meter

4.0.0.1.(B): Excavation for foundation for depth from 1.5 M. to 3.0 M. including sorting out and stacking of useful materials and disposing of excavated stuff up to 50 M. lead in Dense or Hard soil.

1.0. Workmanship

The relevant specifications of item No. 4.0.0.(B) shall be followed except that the excavation work shall be carried out with 1.5 M. to 3.0 M. lift in dense or hard soil.

2.0 Mode of Measurement & Payment

2.1 The relevant specifications of item No.4.0.0.(A) shall be followed.

2.2. The excavation work from 1.5 to 30M shall be measured under this item

2.3. The rate shall be for a unit of one cubic meter.

4.0.0.1.(C): Excavation for foundation for depth from 1.5 M. to 3.0 M. including sorting out and stacking of useful materials and disposing of excavated stuff up to 50 M. lead in Hard murrum.

1.0. Workmanship

1.1. the relevant specifications of item No. 4.0.0. (A) shall be followed except that the excavation work shall be carried out from 1.5 M. to 3.0 M lift in hard murrum.

2.0. Mode of Measurement & Payment

2.1. The relevant specifications of item No. 4.0.0. (A) shall be followed.

2.2. The excavation work from 1.5 M to 3.0 M shall be measured under

2.3. The rate shall be for unit of one cubic meter

4.0.0.1.(D): Excavation for foundation for depth 1.5 M. to 3.0 M. including sorting our and stacking

33

of useful materials and disposing of excavated stuff up to 50 M. lead in soft rock not required blasting.

1.0. Workmanship

The relevant specifications item No. 4.0.0.(D) shall be followed except that the excavation work shall be earned out from 1.5 M. to 3.0 M. lift in soft rock not required blasting.

2.0. Mode of Measurement & Payment

2.1. The relevant specifications of item No 4.0.0.(A) shall be followed.

2.2. The excavation work from 1 5 M, to 3 0 M lift shall be measured under this item.

2.3. The rate shall be for a unit of one cubic meter

4.0.0.1.(E): Excavation for foundation for depth 1.5 M. to 3.0 M. including sorting out and stacking of useful materials and disposing of excavated stuff up to 50 M. lead in hard rock

1.0. Workmanship

1.1. The relevant specifications of item No. 4.0.0.(E) shall be followed except that the excavation work shall be carried out from 1.5 M. to 3.0 M. lift in hard rock.

2.0. Mode of Measurement & Payment

2.1. The relevant specifications of item No. 4.0.0. (A) shall be followed.

2.2. The excavation-work from 1.5 M, to 3.0 lift shall be measured under this item

2.3. The rate shall be for a unit of cubic meter

4.0.0.2. (A): Excavation for foundation for depth from 3.0 M. to 5.0 M. including sorting out and stacking of useful materials and disposing of the excavated stuff Upton 50 M. lead in loose or soft soil.

1.0. Workmanship

1.1. The relevant specifications of item No. 4.0.0.(A) shall be followed except that the excavation work shall be carried out from 3.0 M. to 5.0. M. lift in loose or soft soil.

2.0. Mode of Measurement & Payment

2.1. Relevant specifications of item No. 4.0.0.(A) shall be followed.

2.2. The excavation work from 3.0 M. to 5.0 M. lift shall be measured under this item.

2.3. The rate shall be for a unit of one cubic meter.

4.0.0.2.(B): Excavation for foundation for depth from 3.0 M. to 5.0 M. including sorting our and stacking of useful materials and disposing of the excavated stuff up to 50 M. lead in Dense or Hard soil.

1.0. Workmanship

1.1. The relevant specifications of item No. 4 0.0.(B) shall be followed except that the excavation work shall be carried out from 3.0.m. to 5.0.m. lift in Dense or Hard soil.

2.0. Mode of Measurement & Payment

2.1. The relevant specifications of item No. 4.0.0.(A) shall be followed:

2.2. The excavation work from 3.0. M. to 5,0 M. lift shall be measured under this item.

2.3. The rate shall be for a unit of one cubic metre.

4.0.0.2.(C): Excavation for foundation for depth from 3.0 M. to 5.0 M. including sorting out and stacking of useful material and disposing of the excavated stuff up to 50 M. lead in Hard murrum.

1.0. Workmanship

1.1. The relevant specifications items No. 4 0.0. (C) shall be followed except that the excavation work shall be carried out from 3.0 m to 5 0 M in Hard murrum.

2.0. Mode of Measurement & Payment

2.1. The relevant specifications of item No. 4.0.0.(A) be followed.

2.2. The excavation work from 3.0 M. to 5.0. lift shall be measured under this item.

2.3. The rate shall be for a unit of one cubic metre.

4.0.0.2.(D) Excavation for foundation for depth from 3.0 M. to 5.0 M. including sorting out and stacking of useful materials and disposing of the excavated stuff up to 50 M. in soft rock not required

blasting.

1.0. Workmanship

1.1. The relevant specification-of item NO 4 0.0.(D) shall be followed except that the excavation work shall be carried out from 3.0. M to 5.0. M soft rock not requiring blasting

2.0. Mode of Measurement & Payment

34

2.1. The relevant specification of item No. 4.0 O.(A) shall be followed.

2.2. The excavation work from 30 M. to 5 0 M. lift shall be measured under this item.

2.3. The rate shad be for a unit of one cubic meter

4.0.0.2.(E): Excavation for foundation depth from 3.0 M. to 5.0 M. including sorting out and stacking of useful material land .disposing of the excavated stuff up to 50 M. lead in Hard rock.

1.0. Workmanship

1.1. The relevant specifications of item No 4.0.0.(E) shall be followed except that the excavation work shall be earned out from 3.0. M. to 5.0 M in hard rock

2.0. Mode of Measurement & Payment

2.1. The relevant specification of item No. 4.0.0.(A) shall be followed.

2.2. The excavation work from 3.0 M to 5.0 M. lift shall be measured under this item.

2.3. The rate shall be for a unit of one cubic meter.

4.0.0.3.(A): Extra for additional depth more than 5.0 M. for excavation for foundation including sorting out and stacking of useful material disposing of the excavated stuff up to 50 M. lead in loose or soft soil.

1.0. Workmanship

1.1. The relevant specification of item No 4 0 0 (A) shall be followed except that the excavation work shall be earned out from more than 5 0 M. lift in loose or soft soil

2.0. Mode of Measurement & Payment

2.1. The relevant specifications of item No. 4.0.0.(A) shall be followed

2.2. The rate shall be paid extra over and above the rate of item No. 4 0 0 2.(A) for carrying' out excavation work for additional depth from 5.0 M. and above.

2.3. The rate shall be for a unit of cubic per meter

4.0.0.3.(B): Extra for additional depth more than 5.0 M. for excavation for foundation including sorting and stacking of useful materials disposing of excavated stuff up to 50 M. lead in Dense or Hard soil.

1.0 Workmanship

1.1. The relevant specifications of item No. 4.0.0.(B) shall be followed except that the excavation work shall be carried out from more than 5.0. M. lift in dense or hard soil.

2.0. Mode of Measurement & Payment

2.1. The relevant specifications of item No. 4 0 0 (A) shall be followed.

2.2. The rate shall be paid extra over and above the rate of item No 4 0 0 2.(B) for carrying out excavation work for additional depth from 5 0 M. and above.

2.3. The rate shall be for a unit of one cubic meter.

4.0.0.3.(C): Extra for additional depth more than 5.0 M. for excavation for foundation including sorting out and stacking of useful materials disposing of excavated stuff up to 50 M. lead in Hard murrum.

1.0. Workmanship

1.1. The relevant specification of item No. 4.0.0 (C) shall be followed except that the excavation work shall be carried out from more than 5 0 M. lift in hard rnurrum.

2.0. Mode of Measurements & Payment

2.1. The relevant specification of item No. 4.0.0.(A) shall be followed.

2.2. The rate shall be paid extra over and above the rate item No 4.0.0 2.(C)for carrying out excavation work for additional depth from 5 0 M. and above.

2.3. The rate shall be for a unit of one cubic meter.

4.0.0.3.(D): Extra for additional depth more than 5.0 M. for excavation for foundation including sorting out and stacking of useful materials disposing of excavated stuff up to 50 M. lead in soft rock not requiring blasting.

1.0. Workmanship

1.1. The relevant specifications of Item No. 4.0.0.(D) shall be followed except that the excavation work shall be carried out from more than 5.0 M. lift in soft rock not requiring blasting.

2.0. Mode of Measurement & Payment

2.1. The relevant specifications of item No. 4.0.0.(A) shall be followed.

35

2.2. The rate shall be paid extra over and above the rate of item No. 4.0.0.2.(D) for carrying out excavation work for additional depth from 5 0.(M) and above.

2.3. The rates shall be for a unit of one cubic meter per meter

4.0.0.3.(E): Extra for additional depth more than 5.0 M. for excavation for foundation including sorting out and stacking of useful material disposing of excavated stuff up to 50 M. lead in hard rock.

1.0. Workmanship

1.1. The relevant specification of item No 4.0.0(E) shall be followed except that the excavation work shall be carried out from more than 50 m. lift in hard rock

2.0. Mode of Measurement & Payment

2.1. The relevant specifications of item No.4.0 0.(A) shall be followed.

2.2. The rates shall be paid extra over and above the rate of item No. 4.0.0 2.(E) for carrying out excavation work for additional depth from 5.0. M. and above.

2.3. The rate shall be unit of one cubic meter per meter

4.12. Filling available excavated earth (excluding rock) in trenches, plinth sides of foundations, etc., in layers not exceeding 20 CM. depth, consolidating each deposited layer by ramming and watering.

1.0. Workmanship

1.1. The earth to be used for filling shall be free from salts, organic or other foreign matter. All clods of earth shall be broken.

1.2. As soon as the work in foundation has been completed and measured the site of foundation shall be cleared of all debris, brick bats: mortar dropping etc., and filled with earth in layers not exceeding 20 cms. Each layer shall be adequately watered, rammed and consolidated before the succeeding layer is laid The earth shall be rammed with iron rammers where feasible and with the but ends of crow-bars, where rammer cannot be used.

1.3. The plinth shall be similarly filled with earth in layers not exceeding 20 cms. adequately watered and consolidated by ramming with iron or wooden rammers. When filling reaches finished level the surface shall be flooded with water for at least 24 hours and allowed to dry and then rammed and consolidated.

1.4. The finished level of filling shall be kept to shape intended to be given to floor.

1.5. In case off large heavy duty flooring like factory flooring, the consolidation may be done by power rollers, where so specified. The extent of consolidation required, shall also be as specified.

1.6. The excavated stuff of the selected type shall be allowed to be used in filling the trenches and plinth. Under no circumstances black cotton soil be used for filling the plinth.

2.0. Mode of Measurements & Payment

2.1. The payment shall be made for filling in plinth and trenches. No deduction shall be made for shrinkage or voids, if consolidated as instructed above.

2.2. The rate shall be for a unit of one cubic meter.

4.24. Filling in plinth with sand under floors including watering, ramming consolidating and dressing etc. complete.

1.0. Materials

1.1. Sand shall conform to M 6

2.0. Workmanship

The relevant specifications of item No. 4.12 shall be followed except that sand shall be filled in under floors, including watering, ramming, consolidating and dressing etc , complete.

3.0. Mode of Measurements & Payment

3.1. The relevant specifications of item No. 4.12 shall be followed.

3.2. The rate includes cost of collecting, carting sand with all lead and labour for filling the same in plinth under floors.

3.3. The rate shall be for a unit of one cubic meter.

4.0.0.4. Filling in foundation arid plinth with murrum or selected soil in layers of 20 cm. thickness including watering, ramming and consolidating etc., complete.

1.0. Materials

1.1. Murrum shall be clean, of good binding quality and of approved quality obtained from approved pots/ quarries of disintegrated rocks which contain silicon material and natural mixture of clay of clarions origin. The size of murrum shall not be more than 20 mm

36

2.0. Workmanship

2.1. The relevant specifications of item No. 4.12 shall be followed except that the murrum or selected soil shall be filled in foundations and plinth in 20 cms layer including consolidating, ramming, watering, dressing etc. complete

3.0. Mode of Measurements & Payment

3.1. The relevant specifications of item No. 4.12 shall be followed.

3.2. The rate includes cost of collecting and carting murrum / or selected earth of approved quality with all lead and labour required for filling in trenches and plinth.

3.3. Rate shall be for a unit of one cubic meter.

4.0.0.5. Filling in foundation and plinth with brick-bats / chhara in layers of 20 cms. thickness including watering, ramming and consolidating etc. complete.

1.0. Materials

Brick bats shall conform to M.14

2.0. Workmanship

The relevant specification of item No. 4.12 shall be followed except that brick bats of-burnt bricks shall be filled in foundation and plinth in 20 cms layer including watering, ramming, consolidating etc.,*complete.

3.0. Mode of Measurements & Payment

3.1. The relevant specification item No. 4 12 shall be followed.

3.2. The rate includes cost of collecting and carting brick bats/chhara with all lead and labour required filling in trenches and plinth.

3.3. The rate shall be for a unit of one cubic meter

4.27. Boring holes 3.5 M. deep in ordinary soil (for cast in situ piles) and getting out the soil disposal of the surplus excavated soil as directed within a lead of 50 M. for following diameter for piles, (i) 200 mm. (ii) 250 mm, (ii) 300 mm.

1.0. Workmanship

1.0. The ground shall be roughly leveled and after making the position of piles, the holes shall be bored with a spiral angle to the 3.5 M. depth and specified diameter using boring guide.

2.0. The bore holes shall be truly vertical and uniform bore through out of specified diameter, After boring to the required depth, the bore shall be cleared off the loose soil and disposal of surplus excavated stuff as directed within a lead of 50 M. . 2.0? Mode of Measurement & Payment

2.1. The rate for boring holes shall include :

(a) roughly leveling the ground in positions where piles are to be provided (b) Making the position of piles by pegs and boring guide and also for shifting of boring guide. (c) Bailing out water , if any met with during boring, (d) Disposal or surplus excavated soil within a lead of 50 M and'(e) All tools, plants, equipments and labour required for satisfactory completion or. work.

2.2. The rate shall be for a unit of one Number.

4.28. Extra for under ramming inside the bore holes for under rammed piles of following

nominal diameter : (i) 200 mm. (ii) 250, (iii) 300 mm.

1.0. Workmanship

The relevant specifications of item No. 4.27 shall be followed except that after boring to the required depth, the bore shall be enlarged at the bottom by an under rammer 2 to 2 1/2 times the diameter of the bore as directed It shall be ensured that the bore for the pile shall be enlarged to the correct diameter.

2.0. Mode of Measurement & Payment

2.1. The relevant specification of item No. 4.27 for under reaming the piles.

2.2. The rate shall be paid extra over and above the rate of item No. 4.27 for under ramming the piles.

2.3. The rate shall be for a unit of one number.

37

SECTION 5

Plain & RCC Work

5.1.6. Providing and laying in foundation and plinth/under floors lime concrete with hard broken aggregate 40 mm. nominal size and 40% mortar comprising of 1 Lime putty : 2 fine sand and curing complete excluding cost of form work.

1.0. Materials

Water shall conform to M-1. Sand shall conform to M-6 Lime shall conform to M-2. Graded aggregate 40 mm. nominal size shall conform to M-12

2.1. General

2.1.1. Before starting the concrete the bed of the foundation trenches shall be cleared of all loose materials and watered and rammed as directed.

2.2. Proportion of Mix

2.2.1. The proportion of lime, sand and aggregate shall be specified in the item of the work and shall be measured by volume.

2.2.2. The lime mortar shall consist of proportion of 1 lime putty : 2 sand by volume. The lime mortar shall be prepared by wet process. Power driven mill shall be used for preparation of lime mortar. The slaked lime shall be placed in the mill in even layer and ground for 180 revolutions with sufficient water. The water shall be added as required during grinding and care shall be taken not to add more water so that it will bring the mixed materials to a consistency of stiff paste, thoroughly wetted sand shall then be added evenly and the mixture ground for another 180 revolutions.

2.2.3. Lime mortar shall be kept, protected from sun and rain till used-up, covering it by tarpaulin or open sheds.

2.2.4. All the lime mortar shall be used as soon as possible after grinding. It should be used on the day on which it is prepared but in no case mortar- made earlier than 36 hours shall be permitted for use.

2.3. Mixing:

2.3.1. The concrete shall be mixed in mechanical mixer. Mixing shall be continued until there is uniform distribution of the materials and the mass is uniform in colour and consistency but in no case mixing shall be done for less than 2 to 3 minutes.

2.4. Laying & Compacting:

2.4.1. The concrete shall always be used while quite fresh It shall be laid (not thrown) in layers not exceeding 150 mm. in thickness and shall be well and quickly rammed with wooden or iron rammers, till the required compaction is achieved. The concrete laid shall not be of too fluid consistency. After it has been mixed no more water shall be added, but the surface during and after compaction shall be kept damp. In laying consecutive layers, the layer cast shall be well watered and made rough before the upper layer is laid. The concrete shall be kept continuously wet for period of 7 days from the date of placing of until it- is built over whichever is more.

2.5. Mode of Measurement & Payment :

2.5.1. The concrete work shall be measured in length, breadth and depth as specified on drawing or as directed, correct up to nearest centimeter and cubical content shall be worked out nearest up to two places of decimals.

2.5.2. The rate shall be for unit of one cubic meter.

5.1.8. Providing and laying in foundation and plinth/under floors lime concrete with graded bricks aggregate 40 mm. nominal size and 40% mortar comprising of 1 lime putty : 2 fine sand and curing complete, excluding cost of form work.

1.0. Materials

1.1. Water shall conform to M-1. Lime mortar shall conform to M-10. Brick bats aggregate 40 mm. nominal sizes shall conform to M-14.

2.0. Workmanship

2.1. The relevant specification of item No. 5.1.6. shall be followed except that brick aggregate shall be used instead of graded stone aggregate.

3.0. Mode of Measurements & Payment

3.1. The concrete work shall be measured in length, breadth and depth as specified in drawing or as directed. Correct up to nearest centimeter and cubical content shall be worked out up to two places of decimals.

3.2. The rate shall be for a unit of cubic meter.

38

5.3.2.(A) Providing and laying cement concrete 1.3.6. (1 cement : 3 coarse sand : 6 graded stone aggregate 40 mm. nominal size) and curing complete excluding the cost of form work in foundations and plinth.

1.0. Materials

1.1. Water shall conform to M-1. Cement shall conform to M-3 Sand shall conform to M-6. Stones aggregate 40

mm. nominal size shall conform to M-12.

2.0. Workmanship

2.1. General

2.1.1. Before stating concrete the bed of foundation trenches shall be cleared of all loose materials, leveled, watered and rammed as directed

2.2. Proportion of Mix:

2.2.1. The proportion of cement, sand and coarse aggregate shall be one part of cement. 3 parts of sand and 6 parts of stone aggregates and shall be measured by volume.

2.3. Mixing:

2.3.1. The concrete shall be mixed in a mechanical mixer at the site of work. Hand mixing may however be allowed for smaller quantity of work if approved by the Engineer-in-charge. When hand mixing is permitted by the Engineer-incharge

in case "of break-down of machineries and in the interest of the work, it shall be carried out on a water tight platform and care shall be taken to ensure that mixing is continued until the mass is uniform in colour and consistency, However in such case 10% more cement than otherwise period 1 1/2 to 2 minutes. The quantity of water shall be just sufficient to produce a dense concrete of required workability for the purpose.

2.4. Transporting & Placing the Concrete:

2.4.1. The concrete shall be handed from the place, of mixing to the final position in not more than 15 minutes by the method as directed and shall be placed into its final-position, compacted and finished within 30 minutes of mixing with water i.e. before the setting commences.

2.4.2. The concrete shall be laid in layers of 15 cms. to 20 cms.

2.5.1. The concrete shall be rammed with heavy iron rammers and rapidly to get the required compaction and to allow ail the interstices to be filled with mortar.

2.6. Curing:

2.6.1. After the final set, the concrete-shall be kept continuously wet if required by pounding for a period of not less than 7 days form the date of placement.

2.7. Mode of Measurement & Payment:

2.7.1. The concrete shall be measured for its length, breadth and depth, limiting dimensions to those specified on plan or as directed.

2.7.2. The rate shall be for a unit of one cubic meter.

5.3.3.(A) Providing and laying cement concrete 1:4:8 (1 cement: 4 coarse sand : 8 graded stone aggregate 40 mm. nominal size) and curing complete, excluding cost of form work in foundations and plinth.

1.0. Materials

1.1. Water shall conform to M-1. Cement shall conform to M-3. Sand shall conform to M-6 stone aggregate 40 mm. nominal size shall conform to M-12.

2.0. Workmanship

2.1. Relevant Specifications of item No. 5.3.? shall be followed except that cement concrete shall be mixed in the preparation of 1:4:8 instead of 1:3.6 by volume.

3.0. Mode of measurement and payment

3.1. The concrete shall be measured for its length, breadth and depth, limiting dimensions to those specified on plans or as directed

3.2. The rate shall be for a unit of one cubic meter

5.3.14.(A) Providing and laying cement concrete 1.3.6 (1 cement : 3 coarse sand : 6 crushed stone aggregate 20 mm. nominal size) and curing complete including cost of form work in wall caps/coping.

1.0. Material & Workmanship

1.1. The relevant specification of item No. 5.3.2. (A) shall be followed except that the work shall be carried our for coping and wall caps, except the stone aggregate 20 mm. nominal size shall be used. The concrete work of wall caps/coping.

2.0. Mode of measurements and payment

2.1. The relevant specification of item No. 5.3.2. (A) shall be followed except that the rate includes cost of necessary form work.

39

2.2. The rate shall be for a unit of one cubic meter.

5.3.3. Providing and laying brick bats cement 1:4:8 (1 cement : 4 coarse sand : 8 graded bricks bats), and curing complete excluding the cost of form work in foundation and plinth.

1.0. Materials

1.1. Water shall be conform to M-1 Cement shall conform to M-3. Sand shall conform to M-6 Brick bat shall conform to M-14

2.0. Workmanship

2.1. The specification of this item shall be followed as per item No 5.3.14 (A) except that the proportion of brick bat cement concrete shall be 1 4:8 i e 1 part of cements 4 part of coarse sand and 8 parts of graded brick bat by volume, using graded brick bat as coarse aggregate instead of stone aggregates

3.0. Mode of Measurements & Payment

3.1. The concrete work shall be measured in length, breadth and depth as specified on drawing limiting dimensions to those specified on drawings or as directed.

3.2. The rate shall be for a unit of one cubic meter.

5.3.4.(A) Providing and laying cement concrete 1:5:10 (1 cement : 5 coarse sand : 10 graded stone aggregate 40 mm. nominal size) and curing complete, excluding the cost of form work, for foundation and plinth.

1.0. Materials

1.1. Water shall conform to M-1. Cement shall conform to M-3 Sand shall conform to M-6 Stone aggregate 40 mm nominal size shall conform to M-12.

2.0. Workmanship

2.1. The relevant specification of item No. 5.3.2. (A) shall be followed for the work except that the work is to be carried out in cement concrete 1:5:10

3.0. Mode of Measurement & Payment

3.1. The concrete shall be measured for its length, breadth and depth, limiting dimensions to those specified on plans or as directed.

3.2. The rate shall be for a unit of one cubic meter.

5.3.8.(A) Providing and laying cement concrete 1:5:10 (1 cement : 5 coarse sand : 10 graded brick bats 10 mm. nominal size) and curing complete excluding, cost of form work in foundation and plinth.

1.0. Materials

1.1. Water shall conform to M-1 Sand shall conform to M-6 Cement shall conform to M-3. Brick bats shall conform to M-14.

2.0. Workmanship

2.1. The relevant specification of item No 5.3.4 shall followed except that brick bats aggregate shall be used instead of stone aggregate.

3.0. Mode of Measurement & Payment

3.1. The relevant specification of item No 5.3.4 shall be followed

3.2. The rate shall be for a unit of one cubic meter

5.3.2.(B) Providing and laying brick bat cement concrete 1:3:6 (1 cement : 3 coarse sand : 6 graded brick bats) and curing complete excluding cost of form work in foundation and plinth.

1.0. The specification of item No 5.3.2 (A) shall be followed except that the brick bats shall be used as coarse aggregate instead of stone aggregates.

2.0. Mode of Measurement & Payment

2.1. The relevant specification of item No 5.3.5 (A) shall be followed for mode of measurements and payment except that it excludes the cost of form work.

2.2. The rate shall be for a unit or one cubic meter.

5.4.18. Providing throating or plaster drip and molding to R.C.C. Chhajjas.

1.0. Materials

Water shall conform to M-1. Cement shall conform to M-3. Sand shall conform to M-6 Cement mortar shall conform to M-11

2.0. Workmanship

2.1. The work shall be carried out as directed. The proportion of mix for finishing shall be in C.M. 1:2 by volume. Curing shall be done for not less than 7 days. The work shall be carried out in best workman like manner. The throating or plaster drip and mounding shall be one centimeter in thickness.

40

5.7.5. Extra for providing and mixing Water Proofing material in cement concrete in mix proportions recommended by the manufacturers.

2.0. Workmanship

2.1. The proportions of materials for the cement concrete shall be mentioned with the specifications of that item. The quantity of water proofing materials to be added and the method of addition shall be as specified by manufacturers.

2.2. Mixing:

2.2.1. The mixing of the water proofing materials in cement, water or concrete shall be done according to the specifications of the manufacture.

3.0. Mode of Measurements and Payment

3.1. The payment is extra over and above the rate of concrete for mixing water proofing proper.

3.2. The rate shall be for a unit of one lithe or kg. per quintal of cement in which water proofing material is added.

5.7.1. Providing and laying damp proof course 25 mm. thick cement concrete 1:2:4 (1 cement : coarse sand :4 stone aggregate 10 mm. nominal size) and curing complete.

1.0. The specifications of item No. 5.3.13. (A) of ordinary concrete with or without reinforcement shall be followed except that the size of the stone aggregate shall be 10 mm nominal size and the concrete work shall be carried out in 25 mm. thick damp proof course

2.0. Mode of measurements & payment

2.1. The rate includes cost of all materials and labour required to complete the item

2.2. The rate shall be for a unit one sq. meter.

5.3.13. Providing and laying cement concrete 1:2:4 (1 cement : 2 coarse sand : 4 graded stone aggregate 20 mm. nominal size) and curing complete excluding cost of form work in (A) foundation and plinth, (B) Independent piers, columns and pillars up to floor two level.

1.0. Materials

Water shall conform to M-1. Cement shall conform to M-3. Sand shall conform to M-6. Grit shall conform to M-8. Graded stone aggregate 20 mm nominal size shall conform to M-12.

2.0. General

2.1. The concrete mix is not required to be designed by preliminary testes. The proportion of the concrete mix shall be 1:2:4 (1 cement : 2 coarse sand : 4 graded stone aggregate 20 mm. nominal size) by volume concrete work shall have exposed concrete surface or as specified in the item

2.2. The designation ordinary M-100, M-150, M-200, M-250 specified as per I.S. correspond approximately to 1:3:6, 1:2:4, 1:1:1/2:3 and 1:1:2 nominal mix of ordinary concrete by volume respectively

2.3. The ingredients required for ordinary concrete containing one bag of cement of 50 kg. by weight (0.0342 Cu M.) for different proportions of mix shall be as under:

Grade of concrete Total quantity of dry aggregate
by volume per 50 kgs. of cement
to be taken as the sum of

individual volume of fine and
coarse aggregates, maximum

Proportion of fine aggregate to
coarse aggregate

Quantity of water per
50 Kgs. of cement

maximum
1 2 3 4

M-100 (1:3:6)

M-150 (1:2:4)

M-200 (1:1.1/2:3)

M-250 (1:1:2)

300 Liters

220 Liters

100 Liters

Generally 1:2 for line aggregate
to coarse aggregate by volume

160 but subject to an upper limit
of 1:1.1/2 and lower limit

34 Liters

32 Liters

30 Liters

1:3 27 Liters

2.4. The water cement ratios shall not be more than specified in the above table. The cement content of the mix specified in the table shall be increased if the quantity of water in mix has to be met eased to overcome the difficulties of placements and compaction so that the water-cement ratio specified in the table is not exceeded.

2.5. Workability of the concrete shall be controlled by maintaining a water -cement-ratio that is found to give a concrete mix which is just sufficient wet to be placed and compacted without difficulty with the means available.

2.6. The maximum size of course aggregate shall be as large as possible within the limits specified but in no case greater than one fourth of the minimum thickness of the member provided that the concrete can be placed without difficulty so as to surround all reinforcement thoroughly and to fill the corners of the form.

41

2.7. For reinforced concrete work; coarse aggregates having a nominal size of 20 mm. are generally considered satisfactory.

2.8. For heavily reinforced concrete members as in the case of ribs of main beams, the nominal maximum size of coarse aggregate should usually be restricted to 5 mm. less than the minimum clear distance between the main bar or 5 mm. less than the minimum cover to the reinforcement whichever is smaller.

2.9. Where the reinforcement is widely spaced as in solid slabs, limitations of size of the aggregate may not be so important, and the nominal maximum size may some times be as great as or greater than the minimum cover.

2.10. Admixture maybe used in concrete only with approval of Engineer-in-charge based upon the evidence that with the passage of time neither the compressive strength of concrete is reduced nor are other requisite qualities of concrete and steel impaired by the use of such admixtures.

3.0. Workmanship

3.1. Proportioning : Proportioning shall be done by volume, except which shall be measured in terms of bags of 50 kg. weight, the volume of one such bag being taken as 0.0342 cu. meter Boxes of suitable size shall be used for measuring sand aggregate. The size of boxes (internal) shall be 35 x 25 cms. and 40 cms deep while measuring the aggregate and sand the boxes shall be filled without shaking ramming or hammering. The proportioning of sand shall be on the basis of its dry volume and in case of damp saner, allowances for bulk age shall be made.

3.2. Mixing :

3.2.1. For all work, concrete shall be mixed in a mechanical mixed which along with other accessories shall be kept in first class working condition and so maintained throughout the construction Measured quantity of aggregate, sand and cement required for each batch shall be poured into the claim of the mechanical mixer while it is continuously running. After half a minute of dry mixing measured quantity of water required for each batch of concrete mix shall be added gradually and mixing continued for another one and a half minute Mixing shall be continued till materials are

uniformly distributed and uniform colour of the entire mass is obtained and each individual particle of the coarse aggregate shows complete coating of mortar containing its proportionate amount of cement. In no case shall the mixing be done for less than 2 minutes after oil ingredients have been put into the mixer.

3.2.2. When hand mixing is permitted by the Engineer-in-charge for small jobs or for certain other reasons, it shall be done on the smooth watertight platform large enough to allow efficient turning over the ingredients of concrete before and after adding water. Mixing platform shall be so arranged that no foreign material gets mixed with concrete nor does the mixing water flow out. Cement in required number of bags shall be spread in a layer of uniform thickness on the mixing platform. Dry coarse and fine aggregate and cement shall then be mixed thoroughly by turning over to get a mixture of uniform colour. Specified quantity of water shall then be added gradually through a rose can and the mass turned over till a mix of required consistency is obtained. In hand mixing quantity of cement shall be increased by 10 percent above that specified.

3.2.3. Mixers which have been out of use for more than 30 minutes shall be thoroughly cleaned before putting in a new batch. Unless otherwise agreed to by the Engineer-in-charge the first batch of concrete from the mixture shall contain only two thirds of normal quantity of coarse aggregate. Mixing plant shall be thoroughly cleaned before changing from one type of cement to another.

3.3. Consistency:

3.3.1. The degree of consistency which shall depend upon the nature of the work and methods of vibration of concrete, shall be determined by regular slump tests in accordance with I.S. 1199-193. The slump of 10 mm. to 25 mm shall be adopted when vibrators are used and 80 mm. when vibrators are not used.

3.4. Inspection:

3.4.1. Contractor shall give the Engineer-in-charge due notice before placing any concrete in the forms to permit him to inspect and accept the work and forms as to their strength, alignment and general fitness but such inspection shall not relieve the contractor of his responsibility for the safety of men, machinery, materials and for results obtained immediately before concreting. All forms shall be thoroughly cleaned.

3.4.2. Centering design and its erection shall be got approved from the engineer-in-charge. One carpenter with helper shall invariably be kept present throughout the period of concreting. Movement of labour and other persons shall be totally prohibited for reinforcement laid in position. For access to different parts suitable mobile platforms shall be provided so that steel reinforcement in position is not disturbed. For ensuring proper cover, mortar blocks of suitable size shall be cast and tied to the reinforcement. Timber, kapachi or metal pieces shall not be used for this purpose.

3.5. Transporting and laying:

3.5.1. The method of transporting and placing concrete shall be as approved. Concrete shall be so transported and placed that no contamination, segregation or loss of its constituent material takes place. All work shall be cleaned and made free from standing water, dust, snow or ice immediately before placing of concrete. No concrete

42

shall be placed in any part of the structure until the approval of the engineer-in-charge has been obtained.

3.5.2. Concreting shall proceed continuously over the area between construction joints. Fresh concrete proper contraction joint is formed. Concrete shall be compacted in its final position within 30 minutes of its discharge from the mixer. Except where otherwise agreed to by the engineer-in-charge, concrete shall be deposited in horizontal layers to a compacted depth of not more than 0.45 meter when internal vibrators are used and not exceeding 0.30 meter in all other cases.

3.5.3. Unless otherwise agreed to by the Engineer-in-charge concrete shall be dropped in to place from a height exceeding 2 meters. When trucking or chutes are used they shall be kept close and used in such a way as to avoid segregation. When concreting has to be resumed on a surface which has hardened, it shall be roughened, swept clean, thoroughly wetted and covered with a 13 mm. thick layer of mortar composed of cement and sand in the same ratio as in the concrete mix itself. This 13 mm. layer of mortar shall be freshly mixed and placed immediately before placing of new concrete. Where concrete has not fully hardened, all laitance shall be removed by scrubbing the wet surface with wire or bristle brushes, care being taken to avoid dislodgement of any particles of coarse aggregate. The surface shall then be thoroughly wetted, all free water removed and then coated with neat cement grout. The first layer of concrete to be placed on this surface shall not exceed 150 mm. in thickness and shall be well rammed against old work, particular attention being given to corners and close spots.

3.5.4. All concrete shall be compacted to produce a dense homogeneous mass with the assistance of vibrators, unless otherwise permitted by the Engineer-in-charge for exceptional cases, such as concreting under water, where vibrators cannot be used. Sufficient vibrators in serviceable condition shall be kept at site so that spare equipment is always available in the event of breakdowns. Concrete shall be judged to be compacted when the mortar fills the spaces between the coarse aggregate and begins to cream up to form an even surface. Compaction shall be completed before the initial setting starts i.e. within 30 minutes of addition of water to dry mixture. During compaction, it shall be observed that needle vibrators are not applied on reinforcement which is likely to destroy the bond between concrete and reinforcement.

3.6. Curing:

Immediately after compaction, concrete weather including rain, running water, shocks, vibration, traffic, rapid temperature changes, frost and drying out process. It shall be covered with wet sacking or other similar absorbent material approved, soon after the initial set, and shall be kept continuously wet for a period of not less than 14 days from the date of placement. Masonry work over foundation concrete may be started after 48 hours of its laying but curing of concrete shall be continued for a minimum period of 14 days.

3.7. Sampling and testing of concrete:

3.7.1. Samples from fresh concrete shall be taken as per I.S. 1199-1959 and cubes shall be made, cured and

tested at 7 days or 28 days as per requirements in accordance with I.S. 526-1959. A random sampling procedure shall be adopted to ensure that each concrete batch shall have a reasonable chance of being tested i.e. the sampling should be spread over the entire period of concreting and cover all mixing units. The minimum frequency of sampling of concrete of each grade shall be in accordance with following:

Quantity of concrete in the work. No of samples Quantity of concrete in the works No of samples

1-5 cmt. 1 16-30 cmt. 3

6.15 cmt. 2 31-50 cmt. 4

51 and above 4+ one additional for each additional 50 mm. or part thereof.

Note : At least one sample shall be taken from each shift, Ten test specimens shall be made from each sample, five for testing at 7 days and the remaining five at 28 days. The samples of concrete shall be taken on each day of concreting as per above frequency. The number of specimens may be suitably increased as deemed necessary by the Engineer-in-charge when procedure of tests given above reveals a poor quality of concrete and in other special cases.

3.7.2. The average of the group of cubes cast for each day shall not be less than the specified cube strength of 150 K/g Cm² at 28 days. 20% of the cubes cast for each day may have value less than the specified strength provided the lowest value is not less than 85% of the specified strength. If the concrete made in accordance with the proportions given for a particular grade does not yield the specified strength, such concrete shall be classified as belonging to the appropriate lower grade. Concrete made in accordance with the Proportions given for a particular grade shall not, however be placed in a higher grade on the ground that the test strength are higher than the minimum specified.

3.8. Stripping:

3.8.1. The Engineer-in-charge shall be informed in advance by the contractor of his intention to strike the form work. While fixing the time of removal of form work, due consideration shall be given to local conditions, 43

character of the structure, the weather and other conditions that influence the setting of concrete and of the materials used in the mix. In normal circumstances (generally where temperatures are above 20.C) and where ordinary concrete is used, forms may be struck after periods specified in item No.9.1 (A) for respective item of form work.

3.8.2. All form work shall be removed without causing any shock or vibration as would damage the concrete. Before the soft and struts are removed, the concrete surface shall be gradually exposed, where necessary in order to ascertain that concrete has sufficiently hardened. Centering shall be gradually and uniformly lowered in such a manner as to permit the concrete to take stresses due to its own weight uniformly and gradually. Where internal metal tiles are permitted, they or their removable parts shall be extracted without causing any damage to the concrete and remaining holes filled with mortar. No permanently embedded metal part shall have less than 25 mm. cover to the finished concrete surface. Where it is intended to re-use the form work, it shall be cleaned and made good to the satisfaction of the Engineer-in-charge. After removal of form work and shutting, the Executive Engineer shall inspect the work and satisfy by random checks that concrete produced is of good quality.

3.8.3. Immediately after the removal of forms, all exposed bolts etc. passing through the cement concrete member and used for shuttering or any other purpose shall be cut inside the cement concrete member to a depth of at least 25 mm. below the surface of the concrete and the resulting holes be filled by cement mortar, all fins, caused by form joints, all cavities produced by the removal of form tiles and all other holes and depressions, honeycomb spots, broken edges or corners and other defects, shall be thoroughly cleaned", saturated with water and carefully pointed and rendered true with mortar of cement and fine aggregate mixed in proportions used in the grade of concrete that is being furnished and of as dry consistency as is possible to use. Considerable pressure shall be applied in filling and pointing to ensure thorough filling in all voids. Surface which are pointed shall be kept moist for a period of 24 hours. If rock pockets/honeycombs in the opinion of the Engineer-in-charge are of such an extent or character as to effect the strength of the structure materially or to endanger the life of the steel reinforcement, he may declare the concrete defective and require the removal and replacement of the portions of structure affected.

4.0. Mode of Measurement & Payment

4.1. The consolidated cubical contents of concrete work as specified in item shall be measured. No deduction shall be made for

(a) Ends of dissimilar materials such as joints, beams, posts, girders, girders, purling trusses, corbels and steps etc., up to 500 Sq. Cm. in section.

4.2. The rate includes cost of all materials labour, tools and plant required for mixing, placing in position, vibrating and compacting, finishing, as directed, curing and all other incidental expenses for producing concrete of specified strength. The rate excludes the cost of form work.

4.3. The rate shall be for a unit of one cubic meter.

5.4.1. Providing and laying cement concrete 1:2:4 (1 cement : 2 coarse sand :4 graded stone aggregate 20 mm. nominal size) and curing complete excluding cost of form work and reinforcement for reinforced work in : (A) Foundations, footing base of columns and mass concrete. (C) Slabs, landings, shelves, balconies, lintels, beams, girders and cantilever up to floor two level. (D) Columns, pillars, pots, and struts up to floor up to floor two level (E) Staircase up to floor two level (K) Vertical and horizontal fins up to floor two level.

1.0. Materials & Workmanship

1.1. The relevant specifications of item No. 5.3.13 shall be followed except that the work shall be carried out for reinforced concrete work for work as specified in item 1.2. In addition, the following stipulations shall be followed for:

(a) The bars shall be kept in position by the following methods :

(i) In case of beam and slab construction, sufficient number of precast cover blocks in cement mortar 1:2 (1 cement : 2 coarse sand) about 4 cms. x 4 cms. section and of thickness equal to the specified cover shall be placed between the bars and shattering as to secure and maintain the requisite cover of concrete over the reinforcement. In case of cantilevered or doubly reinforce beams or slabs, the main reinforcing bars shall be held in position by introducing chain spacers or supports bars at 1.0 to 1.2 meter centers.

(ii) In case of columns and walls, the vertical bars shall be kept in position by means of timber templates with slots accurately cut in them, the templates shall be removed after concreting has been done below it. The bars may be also be suitably tied by means of annealed steel wires to the shuttering to maintain their position during concreting.

1.2. AH bars projecting from pillars, columns, beams, slabs etc, to which other bars and concrete are to be attached or bounded to later on, shall be protected with a coat of thin neat cement grout, if the bars are not likely to be incorporated with succeeding mass of concrete within the following 10 days. This coat of thin neat cement shall be removed before concreting.

2.0. Mode of Measurement & Payment

2.1. The relevant specifications of item No. 5.3.13 shall be followed.

44

2.2. The volume occupied by reinforcement shall not be deducted from R.C.C. work.

2.3. The rate shall be for a unit of one cubic meter.

5.4.4. Providing and laying cement concrete 1:2:4 (1 cement : 2 coarse sand : 4 graded stone aggregate 20 mm. nominal size) for reinforced concrete chhajjas not exceeding 10cms. thickness up to floor two level including finishing the exposed surface with cement mortar 1:3 (1 cement : 3 fine sand) to give a smooth and even surface, centering and form work and curing complete excluding cost of reinforcement.

1.0. Materials & Workmanship

1.1. The cement mortar shall conform to m-11.

1.2. The relevant specification of item No. 5.3.13 and 5.4.1 shall be followed except that the work shall be carried out for reinforced concrete chhajjas not exceeding 10 cms. in thickness.

1.3. The specifications for form work and centering shall be as per item No. 9.1.

1.4. The finishing work in cement mortar 1:3 (1 cement : 3 fine sand) shall be carried out as per specifications of item No. 17.49 (I), Before the plastering is done, the surface of the concrete shall be raked for proper bond.

2.0. Mode of measurements & payment

2.1. The relevant specification of item No. 5.3.13 and 5.4.1 shall be followed except that the work of chhajjas up to 10 cms. shall be earned out including centering form work and finishing the surface with cement mortar 1:3 (1 cement : 3 fine sand).

2.2. The rate shall be for a unit of one cubic meter,

5.4.10. Providing an Mild Steel reinforcement for R.C.C. work including bending binding and placing in position etc. complete up to floor two level.

1.0. Materials

1.1. Mild Steel bars shall conform to M-18. Mild steel binding wires shall conform to M-21.

2.0. Workmanship

2.1. The work shall consist of furnishing and placing reinforcement to the shape and dimensions shown as on the drawings or as directed

2.2. Steel shall be clean and free from rust and loose mill scale at the time of fixing in position and subsequent concreting.

2.3. Reinforcing steel shall conform accurate to the dimensions given in the bar bending schedules shown on relevant drawings. Bars shall be bent cold to specified shape and dimensions or as directed, using a proper bar bender, operated by hand or power to attain proper radius of bends. Bars shall not be bent or straightened in a manner that will injure the material. Bars bent during transport or handling shall be straightened before being used on the work. They shall not be heated to facilitate bending Unless otherwise specified a "U" type hook at the end of each bar shall invariably be provided to main reinforcement. The radius of the bend shall not be less than twice the diameter of the round bar and the length of the straight part of the bar beyond the end of the curve shall be at least four times the diameter of the round bar. In case of bars which are not round and in case of deformed bars, the diameter shall be taken as the diameter of circle having an equivalent effective area. The hooks shall be suitably encased to prevent any splitting of the concrete.

2.4. All the reinforcement bars shall lie accurately placed in exact position shown on the drawings, and shall be securely held in position during placing of concrete by annealed binding wire not less than 1 mm in size, and by using stay blocks or metal chair spacers, metal hangers supporting wires or other approved devices at sufficiently close intervals, Bars shall not be allowed to sag between supports nor displaced during concreting or any other operations of the work. All devices used for positioning shall be of non-corrodible material. Wooden and metal supports shall not extend to the surface of concrete, except where shown on drawings. Placing bars on layers of freshly laid concrete as the work progresses for adjusting bar spacing shall not be allowed Pieces of broken stone or brick and wooden blocks shall not be used Layers of bars shall be separated by spacer bars, precast mortar blocks or other approved devices Reinforcement after being placed in position shall be maintained in a clean condition until completely embedded in concrete. Special care shall be exercised to prevent any displacement of reinforcement in concrete already placed. To prevent reinforcement from corrosion, concrete cover shall be provided as indicated on drawings. All the bars protruding from concrete and to which other bars are to be laced and which are likely to be exposed for a period exceeding 10 days shall be protected by a thick coat of neat cement grout.

2.5. Bars crossing each other where required shall be secured by binding wire (annealed) of size not less than 1

mm. in such a manner that they do not slip over each other at the time of fixing and concreting.

2.6. As far possible, bars of full length shall be used. In case this is not possible. Over lapping of bars shall be done as directed When practicable, overlapping bars shall not touch each other, but be kept apart by 25 mm. Where not feasible, overlapping bars shall be bound with annealed wires not less than 1 mm. thick

45

twisted tight. The overlaps shall be staggered for different bars and located at points, along the span where neither shear nor bending moment is maximum.

2.7. Whenever indicated on the drawings or desired by the Engineer-in-charge, bars shall be jointed by couplings which shall have a cross-section sufficient to transmit the full stresses of bars. The ends of the bars that are jointed by coupling shall be upset for sufficient length so that the effective cross section at the base of threads is not less than the normal cross-section of the bar. Threads shall be standard threads Steel for coupling shall conform to I.S. 226.

2.8. When permitted or specified on the drawings, joints of reinforcement bars shall bull-welded so as to transmit their full stresses. Welded joints shall preferably be located at points when steel will not be subject to more than 75 percent of the maximum permissible stresses and welds so staggered that at any one section not more than 20 percent of the rods are welded. Only electric arc welding using a process which excludes air from the molten metal and conforms to any or all other special provisions for the work shall be accepted. Suitable means shall be provided for holding bars securely in position during welding. It shall be ensured that no voids are left in welding and when welding is done in two or three stages, previous surface shall be cleaned properly. Ends of the bars shall be cleaned of all loose scale, rust, stains, paint and other foreign matter before welding. Only competent welders shall be employed on the work. The M.S. electrodes used for welding shall conform to I.S. 814. Welded pieces of reinforcement shall be tested. Specimen shall be taken from the actual site and their number and frequency of test shall be as directed.

3.0. Mode of Measurements & Payment

3.1. For the purpose of calculating consumption, wastage shall not be permitted beyond 5 percent Excess consumption over 5% will be charged at penal rate.

3.2. Reinforcement shall be measured in length including overlaps, separately for different diameters as actually used in the work. Where welding or coupling is resorted to in place lap joints, such joints shall be measured for payment as equivalent length of overlap as per design requirement. From the length so measured, the weight of reinforcement shall be calculated in tones on the same basis of as per M-18 even though steel is supplied to the contractor by the department on actual weight. Length shall include hooks at the ends Wastage and annealed steel wire for binding shall not be measured and the cost of these items shall be deemed to be included in the rate for reinforcement.

3.3. The rate for reinforcement includes cost of steel binding wires. its carting from Department store to work site, cutting, bending, placing, binding and fixing in position as shown on the drawings and as directed It shall also include all devices for keeping reinforcement in approved position, cost of joining as per approved method and all wastage and spacer bars.

3.4. The rate shall be for a unit of One Kg.

5.4.11. High yield deform bars steel reinforcement for R.C.C. work including bending, binding and placing in position complete up to floor two level.

1.0. Materials

1.1. Cold twisted steel bars (high yield strength deformed bars) shall conform to M.19 Mild steel binding wires shall conform to M-21.

2.0. Workmanship

2.1. The specifications of item No. 5.4.10 shall be followed except that the cold twisted steel bars shall be used with or without hooks at the ends. Deformed bars without hooks shall, however, comply with relevant anchorage requirements

3.0. Mode of Measurement & Payment

3.1. The relevant specifications of item No. 5.4.10 shall be followed

3.2. The rate shall be for a unit of One kg

5.4.13. Extra for additional lift of concrete for all R.C.C. work above floor two level excluding cost of reinforcement.

1.0. Materials & Workmanship

The relevant specifications for item No. 5.4.1 shall be followed for the work except that the R.C.C. work shall be done for ground floor i.e. above plinth level to first floor level.

2.0. Mode of Measurement & Payment

2.1. The relevant specifications of item No. 5.4.1 shall be followed except that rate shall be for extra lift above plinth to floor two level over and above the rate of concrete at floor two level.

2.2. The rate shall be for a unit of one cubic meter per floor.

5.4.13.(A) Extra for additional lift of reinforcement steel for all R.C.C. work above floor two level.

1.0. Materials & Workmanship

1.1. The relevant specifications of item No. 5.4.10 as may be applicable, shall be followed except that the work shall be carried out above floor two level for each floor

2.0. Mode of measurement & payment

2.1. The relevant specifications of item No. 5.4.10 or 5.4.11 as may be applicable shall be followed except

46

that the work shall be carried out above floor two level.

2.2. The rate shall be for a unit of one kg. per floor.

5.6.2. Providing up to floor two level precast cement concrete or grill 1:2:4 (1 cement : 2 coarse

sand : 4 graded stone aggregate 6 mm: nominal size) reinforced with 1.6 mm. dia mild steel size wire including roughening, cleaning fixing and finishing in cement mortar 1:3 and curing complete.

(A) 50 mm. thick (B) 40. mm. thick (C) 25. mm. thick (E) 100 mm. thick.

1.0. Materials

1.1. Water shall conform to M-1. Cement shall conform to M-3. Sand shall conform to M-6. Mortar shall conform to M-11. Aggregates shall conform to M-12. Mild steel wire shall conform to M-21. Shattering shall conform to M-26.

2.0. Workmanship

It shall be cement concrete 1:2:4 (1 cement : 2 coarse sand : 4 graded stone aggregate 6 mm. nominal size), reinforced with 1.6. mm. dia mild steel wire unless otherwise specified. The thickness of the jali shall be as specified in the item. The jali shall be set in position true to line and level before the jambs sills and soffits to the opening are plastered. It shall then be properly cemented with cement mortar 1:3 (1 cement : 3 sand) and rechecked for levels. Finally the jambs, sills and soffits shall be plastered gripping the jali uniformly on all sides.

3.0. Mode of measurement of payment

3.1. The item shall be measured in square meter.

3.2. The rate shall be for a unit of one square meter,

5.8.1. Providing and laying controlled concrete M-150 and curing complete excluding the cost of form work and reinforcement for reinforced concrete work in:

(A) Foundation, footings, base of columns, and mass concrete, (B) Walls from top of foundation/level up to floor two level. (C) Slabs, pillars, posts and struts, up to floor two level (E) Staircase up to floor two level. (F) Vertical and horizontal fins up to floor two level.

1.0. Materials

1.1. Water shall conform to M-1. Cement shall conform to M-3. Sand shall conform to M-6. Grit shall conform to M-8 Course aggregate shall conform M-12.

2.0. General

2.1. The relevant specification of item No. 5.4.1. of ordinary concrete shall be followed except that the concrete mix shall be designed from preliminary tests. The proportioning of cement and aggregates shall be done by weight and necessary precautions shall be taken in the production to ensure that the required work cube strength is attained and maintained. The controlled concrete shall be in grades of M-100, M-150, M-200, M-250, M-300, M-350 & M-400 with prefix controlled added to it. The letter M refers to mix and the numbers specify 28 days works cube compressive strength of 150 mm. cubes of the mix expressed in Kg./Crnt.

2.2. The proportion of cement, sand and coarse aggregate shall be determined of weight. The weight batch machine shall be used for maintaining proper control over the proportion of aggregates as per mix design. The strength requirements of different grades of concrete shall be as under:

Grade

Concrete

Compressive strength of 15 cms. cubes in Kg./Cmt. at 28 days, conducted in accordance with I.S. 516-1959.

Preliminary test Min.

Work test Min.

M-1 50 200 150

M-200 260 200

M-250 320 250

M-300 380 300

M-350 440 350

M-400 500 400

In all cases, the 28 days compressive strength specified in above be the criteria for acceptance or rejection of the concrete. Where the strength of a concrete mix as indicated by tests, lies in between the strength of any two grades specified in the above table, such concrete shall be classified in for purpose as concrete belonging to the lower of the grades between which its strength lies.

3.0. Workmanship

3.1. The proportions for ingredients chosen shall be such that concrete has adequate workability for conditions prevailing on the work question and can be properly compacted with means available except where it can be shown to the satisfaction of the Engineer-in-charge, that supply of properly graded aggregate of uniform quality can be maintained till the completion of work, grading of aggregate shall be controlled by obtaining the coarse aggregates in different sizes and bending them in the right proportions as required. Aggregates of different sizes shall be

47

stocked in separate stock piles. The required quantity of material shall be stock piled several hours, preferably a day before use. The grading of coarse and fine aggregate shall be checked as frequently as possible, the frequency for a given job being determined by Engineer-in-charge to ensure that the suppliers are maintaining the uniform grading as approved for samples used in the preliminary tests..

3.2. In proportioning concrete, the quantity of both cement and aggregate shall be determined by weight. Where the weight of cement is determined by accepting the maker's weight per bag, a reasonable number of bags shall be weighted separately to check the net weight. Where cement is weighted from bulk stocks at site and not by bags, it shall be weighed separately from the aggregate. Water, shall either be measured by volume in calibrated tanks or weighed. All measuring equipment shall be maintained in clean, and serviceable condition. Their accuracy shall be periodically checked.

3.3. It is most important to keep the specified water cement ratio constant and at its correct value. To this end, moisture content in both fine and coarse aggregates shall be determined by the Engineer-in-charge according to the weather conditions. The amount of mixing water shall then be adjusted to compensate for variations in the moisture content. For the determination of moisture content in the aggregates. I.S. 2386 (Part-III) shall be referred to. Suitable adjustments shall also be made in the weights of aggregates due to variation in their moisture content. Minimum quantity of cement to be used in controlled concrete shall not be less than 220 kg./M-3 in plain concrete and not less than 250 kg/M-3 in reinforced concrete.

4.0. Mode of measurement & payment

4.1. The relevant specifications of item No.5.4.1 shall be followed, except that the controlled concrete R.C.C. work as specified in item shall be measured under this item. The rate excludes cost of form work.

5.8.2. Providing and laying controlled cement concrete M-200 and curing complete, excluding the cost of form work and reinforcement for reinforced concrete work in :

(A) Foundations, footings base of columns, and mass concrete. (B) walls from top of foundation up to floor two level (C) Slabs, landings, shelves, balconies lintels, beams, girders and cantilever up to floor two level, (D) Columns, pillars, posts and struts upto floor two level (E) Stair cases up to floor two level (K) Vertical and horizontal fins upto floor two level.

1.0. Materials & Workmanship

The relevant specifications of item No. 5.8.1 shall be followed except that the grading of concrete shall be controlled concrete M-200 grades for works 35 specified in item.

2.0. Mode of measurement and payment

2.1. The relevant specifications of item No, 5.8.1. shall be followed.

2.2. The rate shall be for one cubic meter.

5.8.3. Providing and laying controlled cement concrete M-250 and curing complete excluding the cost of reinforcement of reinforced concrete work in:

(A) Foundations, footings, bases of columns, and the like and mass concrete (B) Walls from, top of foundation level up to floor two level (C) Slabs, landing, shelves, balconies, beams, girders and cantilever up to floor two level (D) Columns, pillars, struts up to floor two level.

1.0. Materials & Workmanship

1.1. The relevant specifications of item No. 5.8.1. shall be followed except the grading of concrete shall be controlled concrete M-250 grades for the works as specified in the item.

2.0. Mode of measurements & payment

2.1. The relevant specifications of item No. 5.8.1. shall be followed.

2.2. The rate shall be for a unit of one cubic meter.

5.00.1. Providing and laying ordinary concrete 1:2:4 (1 cement : 2 coarse sand :4 graded stone aggregates 20 mm. nominal size) and finishing smooth with curing etc., complete including the cost of form work but excluding the cost of reinforcement for R.C.C. work in: (I) Slabs up to 8 cms. thickness (II) Slabs having more than 8 cms. and up to (III) Slabs having more than 10 cms. and up to 13 cms. thickness (IV) Slabs having more than 13 cms. and up to 15 cms. thickness.

48

1.0. Materials & Workmanship

1.1. The relevant specifications for item No. 5.4.1. shall be followed for concrete work and relevant specifications of item No. 9.1. shall be followed for form work and centering. The concrete surface shall be smooth finished with cement mortar 1:3 (1 cement: 3 fine sand) as per item No. 17.59 (I) The thickness shall be as specified in the item.

2.0. Mode of measurement & payment

2.1. The relevant specification for item No. 5.4.1 shall be followed except that item shall include the item providing from work and centering work as directed.

2.2. The rate shall be for a unit of one cubic meter.

5.00.2. Providing and laying controlled cement M-150 and finishing smooth with curing etc. complete including the cost of form work but excluding the cost of reinforcement for R.C.C. work in :

(I) slabs up to 8 cms. thickness (II) Slabs more than 8 cms. 10 cms. (III) Slabs more the 10 cms. and up to 13 cms. (IV) Slabs more than 13 cms. and up to 15 cms.

1.0. Materials & Workmanship

1.1. The relevant specifications of item No. 5.8.1. shall be followed for concrete work and item No. 9.1. shall be followed for form work and centering. The concrete surface shall be smooth finished with cement mortar 1:3 (1 cement : 3 fine sand) as per No. 17.59 (I) The thickness shall be as specified in the item.

2.0. Mode of Measurement & Payment

2.1. The relevant of item No. 5.8.1. shall be followed except that the item shall include the cost and from work and centering.

2.2. The rate shall be for a unit of one cubic meter.

5.00.3. Providing and laying ordinary cement concrete 1:2:4 (1 cement: 2 coarse sand : 4 graded stone aggregates 20 mm. nominal size) exposed work with curing etc. complete. including the cost of work but excluding the cost of reinforcement for R.C.C. work in : (I) Slabs up to 8 cms. thickness (II) Slabs having more than 8 cms.-and up to 10 cms. thickness (III) Slabs having more than 10 cms. and up to 13 cms. thickness. (IV) Slabs having more than 13 cms. and up to 15 cms. thickness.

1.0. Materials & Workmanship

1.1. There relevant specifications of item No. 5.4.1. shall be followed for concrete work and that of form work and centering work shall be followed as per item No. 9.1. and 9.7. the thickness of the slab shall be as specified in the item.

2.0. Mode of Measurement & Payment

2.1. The relevant specifications of item No. 5.4.1. shall be followed except that form work and centering work shall be included in the item.

2.2. The rate shall be for a unit of one cubic meter.

5.00.4. Providing any laying controlled cement concrete M-150 exposed work with curing ere., complete including the cost of form work but excluding the cost of reinforcement for R.C.C. work in : (I) Slabs up to 8 cms. thickness (II) Slabs having more than 8 cms. and up to 10 cms. thickness (III) Slabs having more than 10 cms. and up to 13 cms. thickness. (IV) Slabs having more than 13cms. and up to 15 cms. thickness.

1.0. Materials & Workmanship

1.1. The relevant specification of item No 5.4.1. shall be followed for controlled concrete and the relevant specifications of item No. 9.7. and 9.1. shall be followed for exposed concrete form work and centering work. The thickness of the slab shall be as specified in the item.

2.0. Mode of Measurement & Payment

2.1. The relevant specifications of item No. 5.8.1. shall be followed except that the form work and centering work shall be included in the item.

2.2. The rate shall be for a unit of one cubic meter.

5.00.5. Providing and laying ordinary cement concrete 1:2:4 (1 cement : 2 coarse sand : 4 grades stone aggregate 20 mm. nominal size) for R.C.C. lintel including finishing smooth with curing etc. complete including the cost of form work but excluding the cost of reinforcement.

1.0. Materials & Workmanship

1.1. The relevant specifications of item No. 5.81. shall be followed for concrete work, relevant specifications of item No. 17.59.(I) for finishing work and relevant specifications of item No. 9.1. shall be followed form work and centering work The concrete work shall be followed for the form work and centering work for exposed concrete work.

2.0. Mode of measurement & payment

2.1. The relevant specification of item No. 5.3.1. shall be followed except that the item includes the cost form work for exposed concrete work

49

2.2. The rate shall be for a unit of one cubic meter.

5.00.6. Providing and laying cement concrete 1:2:4 (1 cement : 2 coarse sand : 4 graded stone aggregate 20 mm. nominal size) and finishing smooth with curing etc., complete, including the cost of form work but excluding reinforcement for R.C.C. work in : (A) Beams : (I) Having cross sectional areas 0.05 to 0.08 Sq. meter. (II) Having cross sectional area more than 0.08 Sq. up to 0.12 Sq. mt (III) Having cross sectional area more than 0.12 Sq. Mt. and up to 0.18 Sq. Mt (B) Column; (I) Having cross sectional area 0.05. to 0.08 Sq. mt. (III) Having cross sectional area more than 0.12 Sq.Mt. and up to 0.18 Sq.mt.

1.0. Materials & Workmanship

1.1. The relevant specifications of item No. 5.4.1. shall be followed for concrete work and item No. 9.1. shall be followed for form work and centering work. The finishing shall be done in cement mortar 1:3 (1 cement: 3 fine sand) as per item No. 17.59(1). The cross sectional area of beam shall be specified in item.

2.0. Mode of measurement & payment

2.1. The relevant specification of item No. 5.4.1. shall be followed but the form work and centering work shall be included in the item.

2.2. The rate shall be for a unit of one cubic meter.

5.00.7. Providing and laying controlled cement concrete M-150 exposed work with curing etc. complete, including the cost of form work but excluding the cost of reinforcement for R.C.C. work in : (A) Beams : (I) Having cross sectional area 0.05 to 0.08 Sq. mt. (II) Having cross sectional area more than 0.08 Sq. mt. up to 0.12 Sq.mt (III) Having cross sectional area more than 0.12 Sq. mt. and up to 0.18 Sq.mt.: (B) Columns; (I) Having cross sectional area of 0.05 to 0.08 Sq.mt (II) Having cross sectional area more than 0.08 sq.mt. and up to 0.12 sq.mt. (III) Having cross sectional area more than 0.12 Sq.Mt and up to 0.18 Sq.mt.

1.0. Materials & Workmanship

1.1. The relevant specifications of item No. 5.8.1. shall be followed for controlled concrete work as specified in item for M-150 and relevant specifications of item 9.1 shall be followed for the form work centering work for exposed cement work.

2.0. Mode of measurement & payment

2.1. The relevant specifications of item No. 5.8.1 shall be followed except that the form work and centering work shall be included in the item.

2.2. The rate shall be for a unit of one cubic meter.

5.00.8. Providing and laying controlled cement concrete M-200 exposed work with curing etc. complete, including the cost of form work but excluding the cost of reinforcement for R.C.C. work in (A) Beams : (I) Having cross section area 0.05 to 0.08 Sq. mt (II) Having cross sectional area 0.08 Sq.mt and up to 0.12 Sq. mt. (III) Having cross sectional area 0.12 Sq. and up to 0.18 Sq. Mt. (B) Columns : (I) Having cross sectional area 0.05 to 0.08 Sq.Mt. (II) Having

cross sectional area more than 0.08 Sq.Mt and up to 0.12 Sq.Mt. (III) Having cross sectional area more than 0.12 Sq. mt. and up to 0.18 Sq.Mt.

1.0. Materials & Workmanship

1.1. The relevant specifications of item No. 5.8.1. shall be followed for controlled concrete work for work as specified in item for M-200 and relevant specifications of item 9.7 and 9.1 shall be followed for the form work and centering work for exposed cement work.

2.0. Mode of measurements & payment

2.1. The relevant specification of item No. 5.8.1. shall be followed except that the item includes the cost of form work and centering work for exposed work.

2.2. The rate shall be for a unit one cubic meter.

5.00.9. Providing and laying controlled cement concrete M-250 exposed work with curing etc. complete including the cost of form work but excluding the cost of reinforcement for R.C.C. work in : (A) Beams : (I) Having cross sectional area 0.05 to 0.08 Sq.mt.(II) Having cross sectional areas more than 0.08 Sq.mt. and up to 0.12 Sq. mt (III) Having cross sectional area more than 0.12 Sq.mt. and up to 0.18 Sq. Mt. (5) Columns : (I) Having cross sectional area 0.05 to 0.08. Sq.Mt (II) Having cross sectional area more than 0.08 Sq. mt. and up to 0.12 Sq. mt. (III) Having cross sectional area more than 0.12 Sq.mt. and up to 0.18 Sq.mt.

1.0. Materials & Workmanship

1.1. The relevant specifications of item No. 5.8.1. shall be followed for controlled concrete work for the work as specified in the item for M-250 and the relevant R.C.C. lintels shall be carried out.

2.0. Mode of measurement & payment

2.1. The relevant specifications of item No. 5.4.1 shall be followed except that the cost of form work finishing and centering shall be included in the item.

2.2. The rate shall be for a unit of one cubic meter.

50

SECTION – 6

Masonry Work

6.12 (A) Brick work using common burnt clay building bricks having crushing strength not less than 35 Kg/Sq. Cm. in foundations and plinth in cement mortar 1:5 (1 cement :5 fine sand) modular bricks.

1.0. Materials

Water shall conform to M-1. Cement shall conform to M-3. Sand shall conform to M-6. Brick shall conform to M-15. Cement mortar shall conform to M-11.

2.0. Workmanship

2.1. Proportion:

2.1.1. The proportion of the cement mortar shall be 1:5 (1 cement: 5 fine sand) by volume.

2.2. Wetting of bricks:

2.2.1. The bricks required for masonry shall be thoroughly wetted with clean water for about two hours before use or as directed. The cessation of bubbles, when the bricks are wetted with water is as indication of through wetting of bricks.

2.3. Laying:

2.3.1. Bricks shall be laid in English bond unless directed otherwise. Half or cut bricks shall not be used except when necessary to complete to bond; closures in such case shall be cut to required size and used near the ends of walls.

2.3.2. A layer of mortar shall be spread on full width for suitable length of the lower course. Each brick shall first be properly bedded and set home by gently tapping with handle of trowel or wooden mallet. Its inside face shall be flushed with mortar before the next brick is laid and pressed against it. On completion of course, the vertical joints shall be fully filled from the top with mortar.

2.3.3. The walls shall be taken up truly in plumb. All courses shall be laid truly horizontal and all vertical joint shall be truly vertical. Vertical joints in alternate course shall generally be directly one over the other. The thickness of brick course shall be kept uniform.

2.3.4. The brick shall be laid with frog up wards. A set of tools comprising of wooden straight edges, man son's spirit level, square half meter rub, and pins, string and plumb shall be kept on the site of work for frequent checking during the progress of work.

2.3.5. Both the faces of walls of thickness greater than 23 cms. shall be kept in proper place. All the connected brick work shall be kept not more than one meter over the rest of the work. Where this is not possible, the work shall be raked back according to bond (and not left toothed) at an angle not steeper than 45 degrees.

2.3.6. All futures, pipes, outlets of water, hold fasts of doors and windows etc. which are required to be built in wall shall be embedded in cement mortar

2.4. Joints:

2.4.1. Bricks shall be so laid that all joints are quite flush with mortar. Thickness of joints shall not exposed 12 mm.

The face joints shall be raked out as directed by raking tools daily during the progress of work, when the mortar is still green so as to provide key for plaster or pointing to done.

2.4.2. The face of brick shall be cleaned the very day on which the work is laid and all mortar dropping removed.

2.5. Curing:

2.5.1. Green work shall be protected from rain suitably. Masonry work shall be kept moist on all the faces for a

period of seven days. The top of masonry work shall be kept well wetted at the close of the day.

2.6. Preparation of foundation bed:

2.6.1. If the foundation is to be laid directly on the excavated bed, the shall be leveled, cleared of all loose materials, cleaned and wetted before stating masonry, If masonry is to be laid on concrete footing, the top of concrete shall be cleaned and moistened. The contractor shall obtain the engineer's approval for the foundation bed before foundation masonry is started. When pucca flooring is to be provided flush with the top to plinth, the inside plinth offset shall be kept lower than the outside plinth top by the thickness of the flooring.

3.0. Mode measurements & payment

3.1. The measurements of this item shall be taken for the brick masonry fully completed in foundation up to plinth. The limiting dimensions not exceeding those shown on the plinths or as directed shall be final. Battered tapered and curved portions shall be measured net.

51

3.2. No deduction shall be made from the quantity of brick work, for any extra payment made for embedding in masonry or making holes in respect of following items:

- (1) Ends of joists, beams, posts, girders, purlins, trusses, corbel, steps etc. where cross sectional area does not exceed 500 Sq.Cm.
- (2) Openings not exceeding 1000 Sq.Cm.
- (3) Wall plates and bed plates, bearing of slabs, chajjas and the like whose thickness does not exceed 10 Cms. and the bearing does not extend to the full thickness of wall.
- (4) Drainage holes, and recesses for cement concrete blocks to embed hold fasts for doors, windows etc.
- (5) Iron fixtures, pipes up to 300 mm. dia hold fasts, and doors and windows built into masonry and pipes etc. for concealed wiring.
- (6) Forming chases of section not exceeding 350 -Sq. Cm. in masonry.

3.3. Apertures for fire places shall not be deducted nor shall be paid for separately.

3.4. The rate shall be for a unit of one cubic meter.

6.12. (B) Brick work using common burnt clay building bricks having crushing strength not less than 35 Kg/Sq. Cm. in foundations and plinth in cement mortar 1:5 (1 cement : 5 fine sand) conventional bricks.

1.0. Materials

Cement mortar of proportion 1:5 shall conform to M-11. Conventional bricks shall conform to M-15.

2.0. Workmanship

The relevant specification of item No. 6.12 (A) shall be followed except that the bricks to be used shall be modular bricks and the proportion of cement mortar is 1:6.

3.0. Mode of measurements & payment

3.1. The relevant specifications of item No. 6.12(A) shall be followed.

3.2. The rate shall be a unit of one cubic meter.

6.13.(A) Bricks work using common burnt clay building bricks having crushing strength not less than 35 Kg/Sq. Cm in foundation and plinth in cement mortar 1:6 (1 cement : 6 find sand) with conventional bricks.

1.0. Materials

Water shall conform to M-1. Cement mortar shall conform to M-11. Bricks shall conform to M-15.

2.0. Workmanship

2.1. The relevant specification of item No. 6.12 (A) shall be followed except that the bricks to be used shall be conventional bricks and proportion of cement mortar shall in C.M. 1:6.

3.0. Mode of measurements & payment

3.1. The relevant specification of item No. 6.12(A) shall be followed.

3.2. The rate shall be for a unit of one cubic meter.

6.0.0.1(A) Brick work using common burnt clay building bricks having crushing strength not less than 35 Kg/Sq. Cm. in foundation and plinth in cement mortar 1:8 (1 cement :8 find sand), with Modular bricks.

1.0. Materials

Water shall conform to M-1. Brick shall conform to M-15. Cement mortar shall be conform to M-11.

2.0. Workmanship

2.1. The relevant specification of item No. 6.12(A) shall be followed except that the proportion of cement mortar shall be cement mortar 1:8 and bricks used shall be conventional bricks.

3.0. Mode of measurements & payment

3.1. The relevant specification of item No. 6.12(A) shall be followed.

3.2. The rate shall be for a unit of one cubic meter.

6.00.1.(B) Brick work using common burnt clay building bricks having crushing strength not less than 35 Kg/Sq. Cm. in foundation and plinth in cement mortar 1:8 (1 cement : 8 fine sand), with conventional bricks.

1.0. Materials

Water shall conform to M-1. Brick shall conform to M-15, cement mortar shall be conform to M-11.

2.0. Workmanship

2.1. There relevant specifications of item No. 6.12(A) shall be followed except that the proportion of cement mortar shall be cement mortar 1:8.

3.0. Mode of measurement & payment

3.1. The relevant specifications of item No. 6.12(A) shall be followed.

3.2. The rate shall be for a unit of one cubic meter.

6.0.0.1.(A) Brick work using common burnt clay building bricks having crushing strength not less than 35 Kg./Sq. Cm. in foundation and plinth in lime mortar 1:1.5 (1 Lime putty : 1.5 find sand) modular bricks.

1.0. Materials

Lime mortar of proportion (1:1.5) shall conform to M-10. Bricks shall conform to M-15.

52

2.0. Workmanship

2.1. The relevant specification of item No. 6.12(A) shall be followed except that the proportion of cement mortar shall be cement mortar 1:8 and bricks used shall be conventional bricks.

3.0. Mode of measurements & payment

3.1. The relevant specification of item No. 6.12(A) shall be followed.

3.2. The rate shall be for a unit of one cubic meter.

6.001.(B) Brick work using common burnt clay building having crushing strength not less than 35 Kg/Sq. Cm. in foundation and plinth in cement mortar 1:8 (1 cement: 8 fine sand), with conventional bricks.

1.0. Materials

Water shall conform to M-1. Brick shall conform to M-15, Cement mortar shall be conform to M-11.

2.0. Workmanship

2.1. The relevant specifications of item No. 6.12. (A) shall be followed except that the proportion of cement mortar shall be cement mortar 1:8.

3.0. Mode of measurements & payment

3.1. The relevant specifications of item No. 6.12. (A) shall be followed.

3.2. The rate shall be for a unit of one cubic meter.

6.0.0.2.(A) Brick work using common burnt clay building bricks having crushing strength not less than 35 Kg./Sq. Cm. in foundation and plinth in lime mortar 1:1.5 (1 Lime putty: 1.5 find sand) modular bricks.

1.0. Materials

Lime mortar of proportion (1:1.5) shall conform to M-10. Bricks shall conform to M-15.

2.0. Workmanship

The relevant specification of item No. 6.12. (A) shall be followed except the masonry work shall be carried out in lime mortar 1:1.5 (1 lime putty 1.5 fine sand) in foundation and plinth.

3.0. Mode of measurements & payment

3.1. The relevant specification of item No. 6.12. (A) shall be followed.

3.2. The rate shall be for a unit of one cubic meter.

6.0.0.2.(B) Brick work using common burnt clay building bricks having crushing strength not less than 35 Kg/Sq. Cm. in foundation and plinth in lime mortar 1:1.5 (1 Lime putty : 1.5 find sand) conventional bricks.

1.0. Materials & Workmanship

The relevant specification of item No. 6.12(A) and 6.0.02(A) shall be followed except that the masonry work shall be carried out by using conventional bricks in lime mortar 1:1.5 (1 Lime putty: 1.5 fine sand) in foundation and plinth.

2.0. Mode of measurements & payment

2.1. The relevant specification of item No. 6.12(A) shall be followed.

2.2. The rate shall be for a unit of one cubic meter.

6.0.0.3.(A) Brick work using common burnt clay building brick having crushing strength not less than 35 Kg. Sq. Cm. in foundation and plinth in lime mortar 1:2 (1 lime putty :2 find sand) modular bricks.

1.0. Materials & workmanship

The relevant specification of item No. 6.12(A) and 6.0.0.(A) shall be followed except that the masonry work shall be carried out in lime mortar 1:2 (1 Lime putty : fine sand) in foundation and plinth,

2.0. Mode of measurements & payment

2.1. The relevant specification of item No. 6.12 (A) shall be followed.

2.2. The rate shall be for a one cubic meter.

6.0.0.3(3) Brick work using burnt clay building bricks having crushing strength not less than 35 Kg/Sq. Cm. in foundation and plinth in lime mortar 1:2 (1 Lime Putty : 2 find sand) modular bricks.

53

1.0. Materials & Workmanship

The relevant specifications of item No. 6.12 A and 6.0.03 shall be followed except that the masonry work shall be carried out in lime mortar 1:2 (1 lime : 2 find sand) using conventional bricks in foundation and plinth.

6.19.(A) Brick work using common burnt clay building brick having crushing strength not less than 35 kg/sq.cm. for super structure above plinth level up to floor two level in cement mortar 1:5 (1 cement: 5 find sand) modular bricks.

1.0. Materials

Bricks shall conform to M-15. Cement mortar shall conform to M-11.

2.0. Workmanship

2.1. The relevant specification of item No. 6.12 (A) shall be followed except that the masonry work shall be carried out above plinth level to floor two level i.e. for ground floor.

2.2. The frames of doors, windows, cupboards etc. shall be housed into the brick work at the correct location and level as directed. The heavy steel doors, window frames etc. shall be built in with work, but for ordinary steel doors and windows required opening for frames, hold-fasts, etc., shall be in the wall and frame embedded later on in order to avoid damage to the frames.

2.3. Necessary scaffolding shall be provided. The supports of the scaffolding shall be sound and strong tied, together with horizontal pieces over which the scaffolding plunks shall be fixed. Simple scaffolding shall be allowed normally. In this case scaffolding hole shall rest in hole header horizontal coarse only. Minimum number of holes be left in brick work for supporting horizontal scaffolding poles. The contractor is responsible for providing and maintaining sufficiently strong scaffolding so as to withstand all loads likely to come upon it.

2.4. For the face of brick work, where plastering is to be done, joints shall be racked out to a depth not less than thickness of joints. The face of brick work shall be cleaned and mortar dropping removed on very same day that brick work is laid.

3.0. Mode of measurements & payment

3.1. The masonry work of G.F. i.e. above plinth level to floor two level shall be measured and paid under this item.

3.2. Brick work in parapet shall be included in the corresponding masonry item of store immediately below the floor above which the parapet is built.

3.3. No deduction shall be made from quantity of brick work nor nay extra payment made for embedding in masonry of marking holes in respect of following item.

(1) Ends of joints, beams, posts, girders, rafters, purlins trusses corbel, steps, etc. where cross sectional area does not exceed 500 sq.cm.

(2) Opening not exceed in 1000 sq.cm.

(3) Wall plate sand bed plates bearing of slab, chhajjas, and like whose thickness does not exceed 10 cms. and the bearing does not extend the full thickness of wall.

(4) Drainage holes and recesses for cement concrete blocks to embed hold fasts for doors, window etc.

(5) Iron fixtures, pipes up to 300 mm. dia. hold fasts of doors, and window built into masonry and pipes etc. for concealed wiring.

(6) Forming charges of section not exceeding 350 sq.cm. in masonry.

(7) Apparatuses for fire places, shall not be deducted nor shall extra labour required to make splaying of jumps, throating and making trenches over the aperture be paid for separately.

3.4. The rate shall be for a unit of one cubic meter.

6.19.(B) Brick work using common burnt clay building bricks having crushing strength not less than 35 kg/sq. cm. for super structure above plinth up to floor two level in cement mortar 1:5 (1 cement: 5 fine sand) conventional bricks.

1.0. Materials & Workmanship

The relevant specification of item No. 6.19(A) shall be followed except that brick masonry work shall be carried out with conventional bricks.

2.0. Mode measurement and payment

2.1. The relevant specification of item No. 6.19 (A) Shall be followed.

2.2. The rate shall be for a unit of one cubic meter per meter.

54

6.20 Extra for brick in super structure above floor two level.

1.0. Materials and workmanship

The relevant specifications of item masonry work to be earned out shall be followed except that this work is for additional lift of one floor above two level.

2.0. Mode of measurements and payment

2.1. The relevant specification of item No. 6.19 (A) masonry work shall be followed.

2.2. The extra payment shall be made for additional lift above floor two level to each additional floor over and above the rate of masonry work.

2.3. The rate shall be for a unit of cubic meter per floor.

6.30.I(A) Half brick masonry in common burnt clay building having crushing strength not less than 35 kg/sq.cm. in cement mortar 1:4 {1 cement : 4 coarse sand) for super-structure above plinth level up to floor two level with conventional bricks.

1.0. Materials

Bricks shall conform to M-15. Water shall conform to M-1. Cement shall conform to M-3. Sand shall conform to M-6. Cement mortar shall conform to M-11.

2.0. Workmanship

2.1. Relevant specifications of bricks, wetting and laying of bricks, joints, curing etc shall conform to item no. 6.19.(A) except that the brick work of half shall be carried out.

2.2. Cement mortar used in masonry work shall be in proportion of 1 part of cement and 4 parts of sand by volume.

2.3. AH bricks shall be laid stretcher wise, breaking joints with those in the upper and lower courses. The wall shall be taken truly plumb. All courses shall be said truly horizontal and all vertical joints shall be truly vertical. The bricks shall be laid with frogs upwards. A set of masons tools shall be maintained on work as required for frequent checking.

3.0. Mode of measurement and payment

3.1. The half brick masonry work in foundation and plinth shall be measured under this item the limiting dimensions shall not exceed those shown in the plan or as directed. Any work done extra over the specified

dimensions shall be ignored.

3.2. The relevant specifications of item no. 6.12. shall be followed. The length shall be measured nearest to one cm.

3.3. The rate shall be for a unit of one sq. meter.

6.30.I.(B) Half brick masonry in common burnt clay building bricks crushing strength not less than 35 kg/sq. cm. in cement mortar 1:4 (1 cement :4 coarse sand) for super-structure above plinth level up to floor two level with conventional bricks.

1.0. Materials and Workmanship

1.1. The relevant specifications of Item No. 6.30.1 (A) shall be followed for bricks, wetting, laying of bricks, joints, curing, curing, except that the bricks to be used shall be conventional bricks instead of modular bricks.

2.0. Mode of measurement and payment

2.1. The limiting dimensions shall not exceed those shown in the plan or as directed. Any work done extra over specified dimensions shall be ignored.

6.30.II.(A) Half brick masonry in common burnt clay building bricks having crushing strength not less than 35 kg/sq.cm. in cement mortar 1:5 (1 cement : 5 coarse sand) with modular bricks in foundations and plinth.

1.0. Materials & workmanship

The relevant specifications of item No. 6.30.I (A) shall be followed except the half brick masonry work shall be carried out in cement mortar 1:5 (1 cement : 5 coarse sand) with modular bricks in foundation and plinth.

2.0. Mode of measurement and payment

2.1. The relevant specifications of item no. f, 30. I (A) shall be followed.

2.2. The rate shall be for a unit of one cubic meter.

6.30.II.(B) Half brick masonry on common clay building bricks having crushing strength not less than 35 kg/sq. cm. in cement mortar 1:5 (1 cement : 5 coarse sand) in foundation and plinth using conventional bricks.

1.0. Materials & workmanship

1.1. The relevant specifications of item No. 6.30.I (A) shall be followed for bricks, wetting, laying of bricks, joints, curing, except that the bricks to be used shall be conventional bricks instead of modular bricks.

2.0. Mode of measurement and payment

2.1. The relevant specifications of item No. 6.30.I (A) shall be followed.

2.2. The rate shall be for a unit of one sq. meter.

6.30 III.(A) Half brick masonry in common burnt clay building having crushing strength not less than 35 kg/sq. cm. in lime mortar 1:1.5 (1 lime putty : 1.5 coarse sand) in foundation and plinth with modular bricks.

55

1.0. Materials & workmanship

The relevant specifications of item No. 6.30 (I)-A shall be followed except that the half bricks work shall be carried out in cement 1:5 (1 cement: 5 coarse sand) in foundation and plinth using conventional bricks.

2.0. Mode of measurements & payment

2.1. The relevant specifications of item no. 6.30 (I)-A shall be followed.

2.2. The rate shall for a unit of one sq. meter.

6.30.III(A) Half brick masonry in common burnt clay building having crushing strength not less than 35 kg/sq. cm. in lime mortar 1 :1.5 (1 lime putty : 1.5 coarse sand) in foundation and plinth with modular bricks.

1.0. Materials

Modular bricks shall conform to M-15 water shall conform to M-1. Lime mortar or proportion L.M. 1:1.5 (1 Lime putty : 1.5 coarse sand) shall conform to M-10.

2.0. Workmanship

The relevant specifications of item No. 6.30 (I) (A) shall be followed except that the half brick masonry work shall be carried out in lime mortar 1:1.5 (1 Lime putty : 1:1.5 coarse sand) in foundation and plinth using modular bricks.

3.0. Mode of measurements & payment

3.1. The relevant specification of item No. 6.30 (I) A shall be followed.

3.2. The rate shall be for a unit of one sq. meter.

6.30.111(8) Half brick masonry in common burnt clay building bricks having crushing strength not less than 35 kg/sq. cm. in mortar 1: 1.5 (1 Lime putty : 1.5 coarse sand) in foundation and plinth with conventional bricks.

1.0. Materials

Conventional bricks shall conform to M-15, water shall conform to M.1. Lime mortar or proportion L.M. 1:1.5 (1 Lime putty : 1.5 coarse sand) shall conform to M-10.

2.0. Workmanship

The relevant specifications of item No. 6.30 (I)-A shall be followed except that half brick masonry work shall be carried out in Lime Mortar 1:1.5 (1 Lime putty : 1.5 coarse sand) in foundation and plinth using conventional bricks.

3.0. Mode of measurements and payment

3.1. The relevant specifications of item No. 6.30 (I)-A shall be followed.

3.2. The rate shall be for a unit of one sq. meter.

6.30 II(A) Half brick masonry in common burnt clay building bricks having crushing strength not less than 35 kg/sq. cm. in cement 1:5 (1 cement : coarse sand) with hoop iron 25 mm. x 1.6 mm. or

equivalent reinforcement at every third course embedded in cement mortar in foundation and plinth with modular bricks.

1.0. Materials

Bricks shall conform to M-15. Water shall conform to M-1. Cement shall conform to M-3. Sand shall conform to M-6. Cement mortar shall conform to M-11. M.S. reinforcement shall conform to M-18.

2.0. Workmanship

2.1. Relevant specifications of bricks, wetting and laying of bricks, joints, curing, scaffolding etc. shall conform to item No. 6.30 (I)-A except the following :

2.2. Cement mortar used in masonry work shall be in proportion to 1 part of cement and 5 parts of sand by volume and shall conform to M-11, and this work is for half brick thickness for partitions walls.

2.3. The hoop iron 25 mm x 1.6 or equivalent reinforcement shall be provided at every third course. The ends of reinforcement shall be fully embedded in main walls on both sides as directed. Reinforcement shall be placed on the top of the bottom most course. Laps shall be of 15 cms. of mild steel bars or hoop iron.

2.4. The joints in the course where reinforcement is placed shall admit of mortar cover to the reinforcement.

56

3.0. Mode of measurements and payment

3.1. The rate shall be for half brick masonry work providing specified reinforcement, the limiting dimensions not exceeding those in the plan or as directed. The length shall be measured nearest to one cm.

3.2. Any work done extra over specified dimensions shall be ignored.

3.3. The rate shall be for a unit one sq. meter.

6.30.II(B) Half brick masonry in common burnt clay building having crushing strength not less than 35 kg/sq.cm. in cement mortar 1:5 (1 cement : 5 coarse sand) with hoop iron 25 mm. x 1.6 mm. or equivalent reinforcement at every third course embedded in cement mortar in foundation and pith, with conventional bricks.

1.0. Materials & Workmanship

1.1. The relevant specifications of item No. 6.30 I (A) shall be followed except that the work is to be carried out with conventional bricks instead of Modular bricks.

2.0. Mode of measurements and payment

2.1. The rate shall be for half brick work, including providing specified reinforcement, the limiting dimensions out with conventional bricks instead of Modular bricks.

2.2. The work done extra over specified dimensions shall be ignored.

2.3. The rate shall be for a unit of one sq. meter.

6.33.(A) Extra for half brick masonry in superstructure above floor two level. Modular bricks.

1.0. Materials & Workmanship

1.1. The relevant specifications for item No. 6.30 A & 6.30. B shall be followed except that this work is for additional lift over and above the payment of work up to floor two level.

1.2. The rate shall be for a unit of one sq. meter per floor.

6.33.(B) Extra for half brick masonry work in superstructure above floor two level. Conventional bricks.

1.0. Materials & Workmanship

1.1. The relevant specifications for item No. 6.30 A & 6.30. B shall be followed except that this work is for additional lift of each floor two level using conventional bricks.

2.0. Mode of measurements and payment

2.1. The relevant specification of item No. 6.33 (A) shall be followed.

2.2. The rate shall be for a unit of one sq. meter per floor

6.55 (1) Half brick thick Honey-comb brick work with burnt work with burnt clay building bricks having crushing strengths not less than 35 kg/sq.cm. in C.M. 1:4 (1 cement : 4 coarse sand)

1.0. Materials

Bricks shall conform to M-15 Cement mortar of proportion shall conform to M-11.

2.0. Workmanship

The relevant specifications of item No. 6.32(A) shall be followed except that the masonry work shall be carried out Honey-comb in thickness of half bricks in cement mortar 1:4 (1 cement: 4 coarse sand) and as and where directed with all lifts.

3.0. Mode of measurements and payment

3.1. The honey-comb work shall be measured in sq. meters. The full area of honey comb work shall be measured without with all lifts.

3.2. The rate shall be for a unit of one square meter of wall surface.

57

SECTION-7

Rubble Masonry Work

7.6(1) Uncoarsed rubble masonry with hard stone approved quality in foundations and plinth in cement mortar 1:6 (1 cement : 6 coarse sand) including leveling etc. complete.

1.0. Materials:

The cement mortar shall conform to M-11. Stone shall conform to M-16.

2.0. Workmanship

2.1. Dressing of stones:

Stone used for un coursed rubble masonry work shall be hammer dressed on the sides, and beds in which such a way as to close with the adjacent stone in the masonry work as strongly as possible. The face stones shall be dressed in such a manner as to give a specified pattern such as polygonal facing etc. The face of the stones shall be so dressed that bushing on the exposed face shall not project by more than 40 mm. from the general wall surface and on the face to be plastered, it shall not project by more than 19 mm., not shall have depressions more than 10 mm. from the average wall surface.

2.2. Laying:

All the stone shall be sufficiently wetted before laying to prevent absorption of water from mortar. The wall shall be built true to plumb (or true to required batter when so specified). All connected walls in a structure shall be raised up informally and regularly. However if for any specific reason, one part of masonry is required to be left behind the wall shall be racked back at an angle not steeper than 45. Vertical toothed joints in masonry shall not be allowed. The work shall be carried out regularly and masonry of any day wall not be raised by more than 1 meter in height.

2.3. The stone shall be laid in an uncoarsed fashion, or random facing etc. However the masonry is required to be brought to level at various stages viz. plinth level window sill level, roof level and any other level specifically shown in the drawings. This may be done first by adjusting the laying of stone to one level and then by providing leveling course of cement concrete 1:6:12 (1 cement: sand : 12 graded stone aggregate 20 mm. nominal size) or as otherwise specified.

2.4. Proper bonding shall be achieved by closely filling in adjacent stones as well as by using bond stones or through stones as described herein below. Face stones shall extend back sufficiently, and bond well with the masonry. The stone shall be carefully set so as to break joints and avoid formation of vertical joints. The depth of stone from the face of wall inwards shall not be less than weight or breadth at the face. The hearing or interior filling of the wall shall consist of rubble stones which may be of any shape. Neither the face stone nor the hearing stone shall be so small to pass through circular ring of 150 mm. internal diameter in any direction nor shall any of them shall have minimum thickness 100 mm.

2.5. All stone shall be carefully laid, hammered down by a wooden mallet into position and solidly embedded in mortar, chips and spawns of stone may be used wherever necessary to avoid thick mortar beds or joints at the same time ensuring that no hollow space is left anywhere in the masonry. The chips used shall not be more than 20% by volume of masonry. The hearting shall be laid nearly level with face stones except that at about one meter intervals vertical bond stone or plumes projecting about 150 to 200 mm. shall be firmly embedded to from vertical bounding in masonry.

2.6. Bond stone:

Bond stones or through stones running right across the thickness of the wall shall be provided in wall up to 600 mm. thick. In thicker walls two stones overlapping each other by at least 150 mm. shall be provided across the thickness of the wall to form bond stones. There shall be at least one bond stone for every 0.5 sq. mt of wall surface. The bond stone shall be marked by a distinguishing letter during construction for subsequent verification and shall be laid staggered in subsequent layers.

2.7. Quoins:

The quoins or corners stones shall be selected stone neatly dressed with hammer and/or chisel to form the required corner angle and laid header and stretcher alternatively, The bed top surface of quoins shall be chiseled dressed to give horizontal joints. The quoins shall have a uniform chisel draft of at least 25 mm. width at four edges of each exposed face, all the edges of the same face being in one plane. No quoins stone shall be smaller than 0.025 cum. in volume.

2.8. Jamb Stones:

The jamb stone shall be made with stone specified for quoins, that the stone provided on the jambs shall have their length equal to thickness of wall up to 600 mm. and a line of headers shall be provided for walls thicker than 600 mm. as specified for bond.

58

2.9. Joints:

All the joints shall be completely filled with mortar and width shall not exceed 25 mm. when plastering or pointing is not required to be done, the joints shall be struck flush and finished simultaneously while laying the stone. Otherwise the joints shall be racked to a minimum depth of 20 mm. by a racking tools, during progress of laying while the mortar is still green.

2.10. Scaffolding:

Single or double scaffolding shall be used. The scaffolding shall be strong and sound. The holes left in masonry for supporting scaffolding shall be filled and made good before plastering.

2.11. Curing:

Green work shall be protected from rains by covering the same. Masonry shall be kept constantly moist on all the faces for a period of at least 7 days. The top of masonry shall be flooded at close of the day.

3.0. Mode of measurements and payment

3.1. All work shall be measured on the basis of finished dimensions and measured net except where otherwise specified. Only specified dimensions shall be allowed. Anything extra shall be ignored. The masonry work in foundation and plinth shall be measured under this item. No deduction shall be made, not extra payment made for the following:

- (a) Ends of joints, beams, spots, girders, rafters, purlins, trusses, corbels, etc. each up to 500 sq. cm. in section.
- (b) Opening each up to 0.1 sq.m.
- (c) Wall plates and bed plates, bearing of chhaja and like up to 10 cm. depth (bearing of floor and roof slabs shall be deducted from masonry).

- (d) Drain holes and recesses for cement concrete blocks to embed hold fasts for doors windows.
- (e) Building in the masonry iron fixtures pipes up to 300 mm. dia. hole fasts of doors and windows.
- (f) Forming theses in masonry up to section of 350 sq.cm.

3.2. The rate shall be for a unit of one cubic meter.

7.6.(II) Uncoursed rubble masonry with hard stone of approved quality in foundation and plinth in cement mortar 1:5 (1 cement : 5 coarse sand) including leveling up etc. complete.

1.0. Materials and workmanship

The relevant specification of item No. 7.6(1) shall be followed except that the proportion of cement mortar shall 'be in C.M. 1:5 (1 cement : 5 coarse sand)

2.0. Mode of measurements and payments

2.1. The relevant specifications of item No. 7.6(1) shall followed.

2.2. The rate shall be a unit of one cubic meter.

7.6.(III) Uncoursed rubble masonry with hard stone of approved quality in foundation and plinth in lime mortar 1:1.5 (1 lime putty : 1.5 coarse sand) including leveling etc. complete.

1.0. Materials:

Lime mortar shall conform to M-10. The rubble shall conform to M-16.

2.0. Workmanship

The relevant specifications of item No. 7.6 (I) shall be followed.

3.0. Mode of measurement and payment

3.1. The relevant specifications of item No. 7.6 (I) shall be followed.

3.2. The rate shall be for a unit of one cubic meter.

7.17(A) Coursed rubble masonry with hard stone of approved quality in foundation and plinth in cement mortar 1:6 (1 cement : 6 coarse sang) etc. complete.

1.0. Materials

Cement mortar shall conform to M-11. The stone shall conform to M-16.

2.0. Workmanship

2.1. Dressing of stones:

The face stone shall be hammer dressed so as to give approximately rectangular blocks. They shall be squared on bed and side joints. The bed joints shall be rough chisel dressed for a depth of at least 50 mm. back from the faces and the side joints shall be so dressed to a depth of at least 40 mm. back from the face, such that no portion of the dressed surface is more than 10 mm. from a straight edge held against the surface. The remaining portions of surface shall not project above the chisel dressed bed and side joints. The bushing on the face shall not project by more than 40 mm. on an exposed face and 10 mm. on a face to be plastered. The hammer dressed stone shall also have a rough tooling for a minimum with of 25 mm. along the four edges of the face of the stone.

59

2.2. Laying:

2.2.1. All stones shall be wetted before laying. The watt shall be built up truly plumb (or to required better where so specified.)

All connected masonry in a structure shall normally be raised up uniformly and regularly. However, if for any specific reasons one part of wall is required to be left behind, such wall shall be raked back at an angle not steeper than 45°. vertical toothed joints in masonry shall not be allowed. The work shall be carried up regularly and masonry on any day shall not be raised by more than 1 meter in height.

2.2.2. All the courses shall be laid truly horizontal. The height of course shall not be less than 150 mm. nor more than 300 mm. Face stone shall be laid in alternate header and stretcher fashion. They shall be so arranged as to break joints by at least 75 mm. Stones shall be laid with grains horizontal so that the load is transmitted along the direction of their maximum crushing strength. The depth of stone shall not be less than the height or breadth. The breadth of a face stone shall also be not less then the breadth. The breadth of a face stone shall also be not less the 150 mm. Each face stone shall be of the same height in any give course. The courses shall be not less the 150 mm. Each face stone shall be of the same height in any give course. The courses shall be built in perpendicular to the pressure which the masonry will bear. In case of battered walls (such as retaining walls) the beds of the stone and the plate of courses shall be laid with their bed perpendicular to the battered face.

2.2.3. The hearting or the interior filling of the wall shall consist of flat bedded stones carefully laid on their proper beds in mortar, chips and spawns of stone being used where necessary to avoid excessive use of mortar, care being taken to see that no hollow space is left anywhere in the masonry. Chips shall not be used below the hearting stone to bring these up to the level of stones. The use of chips shall be restricted to be filling of interstices between the hear tiling stone but the volume of chips shall be limited to 15% of the total volume of the masonry.

2.3. Bond Stones:

The relevant specification of item No. 7.6 (I) Para 2.6 shall be followed except that the bond stone shall be provided for at least 1.8. m. length of every courses.

2.2.4. Quoins:

The quoins, which shall be of the same height as the course to .which it belongs shall be formed from selected stone of at least 400 mm. length. They shall be laid square or beds on stretchers and headers alternatively. The beds shall be rough, chisel dressed to a depth of at least 100 mm. These stones shall have a minimum uniform chisel draft of 25 mm. width at four edges being in the same plane, quoin stone shall not be smaller than 0.025 cum. in volume and it shall also be not less than 300 mm. in length, 25 % of them being not less 500 mm. in length.

2.5. Joints:

All the bed joints shall be horizontal and all shall be vertical. Face joints shall not be more than 10 mm. thick. All joints

shall be properly and completely filled with mortar. On faces where no plastering or pointing is required to be done the joint shall be flush and finished simultaneously while laying stones. In other cases the joints shall be raked to a minimum depth of 20 mm. by raking tools during the progress of work while the mortar is still green.

2.6. Curing:

The relevant specification of item No. 7.6 (l) area Para 2.9 shall be followed

3.0. Mode of measurements & payment

3.1. The relevant specification of item No. 7.6 (l) shall be followed.

3.2. The rate shall be for a unit of one cubic meter.

7.17.(B) Coursed rubble masonry with stone of approved quality in foundation and plinth in cement mortar 1:5 (1 cement : 5 coarse sand) etc. complete.

1.0. Materials & Workmanship

The relevant specifications of item No. 1.17 (A) shall be followed except that the proportion of cement mortar shall be C.M. 1:4 (1 cement : 5 coarse sand)

2.0. Mode of measurement & payment

2.1. The relevant specification of item No. 7.17 (A) shall be followed.

2.2. The rate shall be for a unit of one cubic meter. t

7.17 (C) Coursed rubble masonry with stone of approved quality in foundation and plinth in C.M. 1:4 (1 cement : 4 coarse sand) etc. complete)

1.0. Materials & workmanship

The relevant specifications of item No. 7.17 (A) shall be followed except that the proportion of mortar shall be C.M. 1:4 (1 cement : 4 coarse sand)

2.0. Mode of measurements & payment

2.1. The relevant specifications of item No. 7.17 (A) shall be followed.

60

2.2. The rate shall be for a unit of one cubic meter.

7.17(D) Coarsed rubble masonry with stone of approved quality in foundation and plinth in c.m. 1:3 (1 cement : 3 coarse sand) etc. complete.

1.0. Materials and Workmanship

1.1. The relevant specification of item No. 7.17 (A) shall be followed except that the proportion of mortar shall be C.M. 1:3 (1 cement : 3 coarse sand)

2.0. Mode of measurement & payment

2.1. The relevant specification of item No. 7.17 (A) shall be followed.

2.2. The rate shall be for a unit of one cubic meter.

7.19(A) Coarsed rubble masonry with stone of approved quality for structure above plinth level up to floor two level in C.M. 1:6 (1 cement : 6 coarse sand) etc. complete.

1.0. Materials & Workmanship

1.1. The relevant specification of item No. 7.17 (A) shall be followed except that the coursed rubble masonry work shall be carried out for superstructure above plinth level up to floor two level.

1.2. Single or double scaffolding may be used. The scaffolding shall be strong and sound. In case single scaffolding is used, the holes shall be carefully made good as directed.

2.0 Mode of measurement & payment

2.1. The relevant specifications of item No. 7.17 (A) shall be followed.

2.2. The rate shall be for a unit of one cubic meter.

7.75. Precast concrete block masonry (including quoin block, jamb blocks, closer etc.) with solid concrete blocks of approved size made of cement concrete 1:3:6 Mix. (1 cement : 3 coarse sand : 6 graded stone aggregate of 20 mm. and down gauge) in foundation and plinth in cement mortar 1:6.

1.0. Materials

(a) Aggregate shall conform to M-12. (b) Sand shall conform to M-6. (c) Cement shall conform to M-3.

1.1. The solid cement concrete blocks shall be precast with concrete of 1:3:6 mix (1 cement: 3 coarse sand : 6 graded stone aggregate)

1.2. A block shall be deemed to be solid if the solid materials is not less than 75% of the total volume of the blocks calculated from overall dimensions.

1.3. The concrete mix used for block shall be one of the following:

1.4. The actual size of the block shall be one of the following:

Size : A. 39 x 30 x 19 cms. Size-B 39 x 20 x 19 cms. Size C 39 x 10 2 19 cms.

The size other than those specified above may be used with the approval of Engineer-in-charge.

1.5. The blocks may be either machine made or hand made. The concrete mix, the mixing of concrete the manufacture of blocks, curing and drying shall be in accordance with para-6 to 10 under I.S. : 2185-1967.

1.6. Faces of blocks shall be flat and rectangular Surface finish shall be rendered smooth or plastered with cement mortar 1:3 coarse sand)

1.7. The average compressive strength of eight blocks when determined in the manner described-in I.S. 2185 - 1967 shall not be less than 50 Kg/Sq. Cm. of gross area. The strength of lowest individual block shall not be less than 75 percent of average compressive strength of eight blocks.

1.8. Concrete blocks shall be stored and stacked properly in such a way as to avoid any contact with moisture at site. They shall be stock plied on planks or other supports free from contact with ground and covered to protect against wetting. Cement mortar of proportion 1:6 shall conform to M-11.

2.0. Workmanship

2.1. The blocks need not wetted before of during laying in the walls. In case climatic conditions so required, the top and the sides of block may only be slightly moistures so as to prevent absorption of water from the mortar and ensure the development of required bond with mortar.

2.2. Operations of laying precast cement concrete block masonry shall be carried out in accordance with instructions detailed in I.S. : 6042 -1952. The mortar shall not be spread so much ahead of the actual laying of the units that it tends to stiffen and loose, its plasticity, thereby resulting in poor bond. For most of the work, the joints, both horizontal and vertical shall be 10 mm. thick except in the case of extended joint, construction, the mortar joints shall be struck off flush with wall surface and when the mortar has stated stiffening, it shall be compressed with rounded or U-shaped tool. The mortar shall be pressed against the units with a jointing tool after the mortar has stiffened in effect intimate contract between the mortar and the masonry unit arid obtained a weather tight joint.

61

2.3. Quoins and closures:

Special quoins blocks (with a return face equal to half the length of normal face) shall be cast for ail building blocks and slabs for external work. Proper half closures shall be cast and not cut form full size blocks. The returned ends of blocks for door windows revels and quoins shall be finished with a fair face in the mould.

2.4. Only double scaffolding shall be used. The scaffolding be strong and sound. No holes in the masonry for supporting shall be allowed.

2.5. **Curing** : The curing of concrete block masonry shall be carried our for 7 days.

3.0. Mode of measurements & payment

3.1. The relevant specifications of item No. 7.6 (I) shall be followed.

3.2. The work of concrete block masonry in foundation and plinth shall be measured under this item.

3.3. The rate shall be for a unit of one cubic meter.

7.82 (A) Precast concrete block masonry in partition walls 10 cms. thick with solid block of approved size (including quoins, blocks, jamb blocks closer etc) made of C.C. 1:3:6 (1 cement : 3 coarse sand : 6 graded stone aggregates 20 mm. and down gauge) in C.M. 1:4.

1.0. Materials:

1.1. The relevant specification of item No. 7.75 shall be followed except that the precast concrete blocks shall be of size suitable for 10 cms. size partition wall i.e. size c and the proportions of cement mortar shall be in cement mortar 1:4 (1 cement : 4 coarse sand).

2.0. Workmanship

The relevant specifications of item No. 7.75 shall be followed except that the work shall be for precast concrete block partition walls of 10 cms. thickness.

3.0. Mode of measurement & payment

3.1. The relevant specifications of item No. 7.75 shall be followed.

3.2. The rate shall be for a unit of one cubic meter.

7.0.0.1. White stone .masonry block in coarse in superstructure with stone of approved quality in lime mortar 1:1.5 (1 Lime putty 1:5 find sand) including raking out joints etc. complete.

1.0. Materials:

1.1. The stone or bela shall be white hard sand stone or block. The stone shall be sound hard rough and durable.

It shall be free form skin. The thickness of bela or block shall not be less than 15 cms. or as directed. The mortar used shall consist. One part of lime putty and 1.50 parts of fine sand. Lime mortar shall conform to M-10.

2.0. Workmanship

2.1. Dressing of stone:

Stone shall be chiseled on all the sides so that all six sides shall be in a rectangular shape and all the stones shall be so dressed that the bushing of the exposed face shall not project nor depressions for the general wall surfaces. The size of bela or block shall be as per thickness of the wall to be constructed or as directed.

2.3. Laying:

All the stone shall be sufficiently wetted before laying to prevent absorption of water from mortar. All connected Walls in a structure shall normally be raised up uniformly and regularly. The vertical joint shall not be allowed and also it shall not be more than 12 mm. in thickness.

2.3. Proper bonding shall be made by laying bela or block side by side each other with lime mortar on bed as well as in between two bela or block vertically.

2.4. Bond stones:

Bond stones or through stones running right across the thickness of the wall shall be provided in walls up to 450 mm. thick. In thicker walls two bela or blocks or laying each other by at least 150 mm. each other shall be provided across the thickness of the wall to bond stone. Such bond stone shall be at least one for every 1.0 sq. mt. area of the wall surface.

2.5. Joints:

All the joints shall be completely filled up with mortar and their thickness shall not exceed by 12 mm. When plastering or pointing is not required to be done, the joints shall be struck flush and finished, simultaneously while laying the stone. Otherwise the joints shall be raked to a minimum depth of 20 mm. during process of laying while mortar is still green.

2.6. Scaffolding:

Single or double scaffolding shall be used. It shall be strong and sound. The holes left in masonry for supporting shall be made good before plastering.

2.7. Curing:

Green work shall be cured for a period of 7 days continuously.

62

3.0. Mode of measurements & payment

3.1. The work shall be measured on the basis of finished dimensions. No deduction shall be made nor extra payment shall be made for the following:

- (a) Ends of joint, beams, posts, girders, rafters, purlins, corbels etc., each up to 500 sq.cms. in section (b) Opening each up to 0.10 Sq.m.(c) Small plates and bed plates, bearing of chhajjas and like up to 10 cms. depth (bearing or floor and roof shall be deducted from masonry), (d) Drain holes and recesses for cement concrete blocks to embedded hold fasts of one cubic meter.

7.0.0.2. White stone bela masonry work in partition walls up to 15 cms. thickness in C.M. 1:4 (1 cement : 4 coarse sand.)

1.0. Materials and workmanship

The relevant specifications of item No. 7.0.0.1 as above shall be followed except that the proportion of mortar shall be in C.M. 1:4 (1 cement : 4 coarse sand.)

2.0. Mode of measurement & payment

2.1. The relevant specifications of item No. 7.6 (I) shall be followed.

2.2. The rate shall be for a unit of one cubic meter.

7.0.0.3. White stone bela masonry block in coarse in superstructure with stone of approved quality in C.M. 1:5 (1 cement: 5 coarse sand) including raking the joints etc. complete.

1.0. Materials and Workmanship

The relevant specifications of item No. 7.0.0 1. as above, except that the proportion of cement mortar shall be in C.M. 1:5 (1 cement : 5 coarse sand)

2.0. Mode of measurement & payment

2.1. The relevant specifications of item No. 7:6 (I) shall be followed

2.2. The rate shall be for a unit of one cubic meter.

7.0.0.4. White stone bela masonry block in coarse in superstructure with stone of approved quality in C.M. 1:6 (1 cement : 6 coarse sand) including raking the joints etc. complete.

1.0. Materials and Workmanship

The relevant specifications of item No. 7.0.0.1 shall be followed except that the proportion of cement mortar shall be 1:6 (1 cement : 6 coarse sand)

2.0. Mode of measurement & payment

2.1. The relevant specifications of item No. 7.6. (I) shall be followed.

2.2. The rate shall be for a unit of one cubic meter.

63

SECTION -9

Centering & Form Work

9.1.(A) Providing form work of ordinary timber planking so as to give a rough finish including centering strutting and propping etc. height of propping and centering below supporting floor to ceiling not exceeding 4 m. and removal of the same for in situ reinforced concrete and plain concrete work in foundation, footings, bases of columns, and mass concrete.

1.0. Materials

1.1. The shuttering to be provided shall be of ordinary timber plank and shall conform to M-26.

1.2. The dimensions of scantlings and battens shall conform to the design. The strength of the wood shall not be less than that assumed in the design.

2.0. Workmanship

2.1. The form work shall conform to the shape lines and dimensions as shown on the plans and be constructed as to remain sufficiently rigid during the placing and compacting of the concrete. Adequate arrangements shall be made by the contractor to safe-guard against any settlement of the form-work during the course of concreting and after concreting. The form work of shuttering, centering, scaffolding, bracing etc. shall be as per design.

2.2. Clearing and Treatment of forms:

2.2.1. All rubbish, particularly chipping shaving and saw dust shall be removed from the interior of the form before the concrete work is placed and the-form in contact with concrete shall be cleaned and thoroughly wetted or treated. The surface shall be then coated with soap solution applied before concreting is done. Soap solution for the purpose shall be prepared by dissolving yellow soap in water to get consistency of paint. Alternatively a coat of raw linseed oil shall be applied after thoroughly cleaning the surface. Care shall be taken that the coating does not get on construction joint surface and reinforced bars.

2.3. Stripping time:

2.3.1. In normal circumstances and where ordinary cement is used forms may be struck after expiry of following periods.

- (a) Sides of walls columns and vertical faces of beams.....24 to 48 hours.
- (b) Beam soffits, (props, left under).....7 days.
- (c) Removal of props slabs:
 - (i) Slabs spanning up to 4.5. m.....7 days.
 - (ii) Spanning over 4.5 mm..... 14 days.
- (d) Removal of props t beams and Arches:
 - (i) Spanning up to 6 mm..... 14 days.

(ii) Spanning over 6 m.....21 days.

2.4. Procedure when removing the form work:

2.4.1. All form work shall be removed without such shock or vibrations as would damage the reinforced concrete surface. Before the soffits form work and struts are removed, the soffits and the concrete surface shall be exposed where necessary in order to ascertain that the concrete has sufficiently hardened

2.5. Centering:

2.5.1. The centering to be provided shall be got approved. It shall be sufficiently strong to ensure absolute safety of the form work and concrete work before, during and after pouring concrete. Watch should be kept to see that behavior of centering and form work is satisfactory during concreting. Erection should also be such that it would allow removal of forms in proper sequence without damaging either the concrete or the forms to be removed.

2.5.2. The props of centering shall be provided on firm foundation or base of sufficient strength to carry the loads without any settlement.

2.5.3. The centering and form work shall, be inspected and approved by the Engineer-in-charge before concreting. But this will not relieve the contractor of his responsibility for strength, adequacy and safety of form work and centering. If there is a failure of form work or centering, contractor shall be responsible for the damages to property.

2.6. Scaffolding:

2.6.1. All scaffolding, hoisting arrangements and ladders etc., required for the facilitating of concreting shall be provided and removed on completion of work by contractor at his own expense. The scaffolding, hoisting

64

arrangements and ladders etc. shall be strong enough to with stand all live, dead and impact loads expected to act and shall be subject to the approval of the Engineer-in-charge. However contractor shall be solely responsible for the safety of the scaffolding, hoisting arrangement, ladders, work and workman etc. **2.6.2.** The scaffolding, hoisting arrangements and ladder shall allow easy approach to the work spot and afford easy inspection.

2.6.3. The rate is applicable to all condition of working and height up to 4 mts. The rate shall include the cost of materials and labour for various operations involved such as:

(a) Splayed edges, notching, allowance for overlaps and passing at angles, battens centering, shuttering propping, bolting, wedging easing, striking and removal.

(b) Filletting to form stop chamfered edges or splayed external angles not exceeding 20 mm: width to beams, columns and the like.

(c) Temporary openings in the forms for pouring concrete, if required removing rubbish etc.

(d) Dressing with oil to prevent adhesion of concrete with shuttering and.

(e) Raking or circular cutting.

2.7. Re-Use:

2.7.1. Before re-use, all form shall be inspected by Engineer-in-charge and their suitability ascertained. The forms shall be scarred, cleaned and joints are gone over, repaired where required. Inside surface shall be retreated to prevent adhesion of concrete.

3.0. Mode of Measurements & Payment

3.1. Form work shall be measured as the area in square meters to shuttering in contact with concrete except in the case of inclined member and portion of curved profile and upper side in which case on area of underside shall be measured for payment.

3.4. Form work to secondary beams shall be measured up to the sides of main beams but no deduction shall be made from the form work of the main beam at the inter section point. No deduction shall be made from the form work of a column at inter section of beams.

3.5. The rate is for the completed item

3.6. The rate shall be for a unit of one sq. meter.

9.1.(A) (i) Extra for providing form work of ordinary timber planking so as to give a rough finish including centering, shuttering and propping etc., height of propping and centering below supporting floor to ceiling is between 4 to 5 m. and removal of the same for in situ reinforce or plain concrete work in foundations, footings, bases of columns etc. and mass concrete.

1.0. Materials workmanship

1.1. The relevant specification of item No. 9.1. (A) shall be followed except they the height of propping and centering below supporting floor to ceiling exceeding 4 m. but not exceeding 5 m.

2.0. Mode of measurements and payment

2.1. The payment shall be made extra over and above the payment made up to 4 m. height. The relevant specifications of item No. 9.1.(A) shall be followed. The rate shall be for a unit of one sq. meter.

9.1.(B)(i) Providing form work of ordinary timber planking so as to give a rough finish including centering, below supporting floor to ceiling not exceeding 4 m. and removal of the same for in situ reinforced and plain concrete work in flat surface such as soffits of slabs, landing and the like floors etc. up to 200 mm. in thickness.

1.0. Materials & Workmanship

1.1. Relevant specifications of item 9.1. (A) shall be followed except that work is to be carried out for flat surfaces such as soffits of slabs, landings, and the like top floors etc. up to 200 mm, in thickness.

2.0. Mode of measurement and payment

2.1. The relevant specifications of item No. 9.1 (A) shall be followed.

2.2. The rate shall be for a unit of one sq. meter.

9.1.(B)(ii) Providing form work of ordinary timber planking so as give a rough finish including centering shuttering, strutting and propping etc. height of propping and centering below supporting

floor to ceiling not exceeding 4 m. and removal of the same for in situ reinforced and plain concrete work in flat surface such as soffits of slabs, landings, and the like floors etc. above 200 mm. in thickness.

1.0. Materials and Workmanship

1.1. Relevant specifications of item No. 9.1 (A) shall be followed except that the work is to be carried out for flat surfaces such as soffits of slabs, landings, and the like for floors etc. up to 200 mm. in thickness.

65

2.0. Mode of measurement and payment

2.1. The relevant specifications of item No. 9.1 (A) shall be followed.

2.2. The rate shall be for a unit of sq. meter.

9.1.(C) Providing form work of ordinary timber planking so as to give a rough finish including centering shuttering, strutting and propping etc. height of propping and centering below supporting floor to ceiling not exceeding 4 m. and removal of the same for in situ reinforced concrete and plain concrete work in vertical surface such as walls (any thickness) partitions.

1.0. Materials and Workmanship

The relevant specifications of item 9.1 (A) shall be followed except that the form work shall be carried out for vertical surfaces such as walls of any thickness, partitions etc.

2.0. Mode of measurement and payment

2.1. The relevant specifications of item No. 9.1 (A) shall be followed"

2.2. The rate shall be for a unit of sq. meter.

1.0. Materials and Workmanship

1.1. The relevant specifications of item No.9.1 .(A) shall be followed.

1.2. The rate shall be for a unit on one sq. meter.

9.1.(G)(i) Providing form work of ordinary timber planking so as to-give a rough finish including centering, shuttering and propping etc. height of propping and centering below supporting floor to ceiling not exceeding 4 m. and removal of the same for in situ reinforced and plain concrete work columns, pillars, ports, and struts, square rectangular, polygonal in plan.

1.0. Materials and Workmanship

1.1. The relevant specification of item No. 9.1. (A) shall be followed except that the work is for columns, pillars, posts and struts, square, rectangular, polygonal in plan.

2.0. Mode of measurement and payment

2.1. The relevant specification of item No. 9.1. (A) shall be followed.

2.2. The rate shall be for a unit of one sq. meter.

9.1.(H)(I) Providing form work of ordinary planking so as to give a rough finish including centering, shuttering, strutting and propping etc. height of propping and centering below supporting floor to ceiling not exceeding 4 m. and removal of the same for in situ reinforced and plain concrete work in side and soffits of beam haunchings, cantilevers, girders, bressumers, and lintels not exceeding 1 m. depth.

1.0. Materials and Workmanship

1.1. The relevant specification of item No. 9.1 (A) shall be followed except that the .work is for sides and soffits of beams, haunting cantilevers girders, bressumers and lintels not exceeding 1 M. in depth.

2.0. Mode of measurement and payment

2.1. The relevant specifications of item No. 9.1 (A) shall be followed.

2.2. The rate shall be for a unit of one sq. meter.

9.1.(H)(2) Providing form work of ordinary timber Planking so as to give a rough finish including centering, shuttering, strutting and propping etc. height of propping and centering below supporting floor to ceiling not exceeding 4 m. and removal of the same for in situ reinforced and plain concrete work in sides and soffits of beams, haunchings, cantilevers, girders, bressumers and lintels exceeding 1 m. in depth.

1.0. Materials and Workmanship

1.1. The relevant specifications of item No. 9.1.(A) shall be followed except that the work is for side and soffits of beam hunchings, girders, bressumers and lintels, exceeding 1 m. in depth.

2.0. Mode of measurement and payment

2.1. The relevant specifications of item No 9.1.(A) shall be followed except that the work is for side and soffits of beams haunting cantilevers, girder bressumers and lintels, exceeding 1 m. in depth.

2.2. The rate shall for a unit of one sq. meter.

9.1.(i) Providing from work of ordinary timber planking so as to give a rough finish including centering, shuttering and propping etc. height of propping and centering below supporting floor toe ceiling not exceeding 4 m. and removal of the same for situ reinforced and plain concrete work in edges of slabs and breaks in floor and walls.

66

1.0. Materials and Workmanship

1.1. The relevant specifications of item No. 9.1. (A) shall be followed except that the work is for edges of breaks in floors and walls.

2.0. Mode of measurements and payment

2.1. The length and breadth shall be measured nearest to one Cm.

2.2. The. rate shall be for a unit of one Sq. meter.

9.1.(K) Providing form work of ordinary timber planking so as to give a rough finish including centering shuttering, strutting and propping etc. height of propping and centering below supporting floor to ceiling not exceeding 4 m. and removal of the same in situ reinforced and plain concrete in small surface such as cantilevers ends, brackets and ends of the steps., caps and bases to pilasters and columns and the like.

1.0. Materials and Workmanship

1.1. The relevant specifications of item No. 9.1.(A) shall be followed except that work is for small as cantilever ends, brackets and ends of steps, caps and bases to pilasters and columns and the like.

2.0. Mode of measurement and payment

2.1. The relevant specification of item No. 9.1.(A) shall be followed.

2.2. The rate shall be unit of one sq. meter.

9.1.(I) Providing form work of ordinary timber planking so as to give a rough finish including centering, shuttering, strutting and propping .etc. height of propping and centering below supporting floor to ceiling not exceeding 4 m. and removal of the same for in situ reinforced and plain concrete in chullah hoods, weather sheds, chhajjas, corbels etc. including edges.

1.0. Materials and Workmanship

1.1. The relevant specifications of item No. 9.1 (A) shall be followed except that the work is for chullah hoods, weather-sheds, chhajjas, corbels, etc. including edges of the same.

2.0. Mode of measurements and payment

2.1. The relevant specification of item No. 9.1. (A) shall be followed.

2.2. The rate shall be for a unit of one square meter.

9.1.(M) Providing form work of ordinary timber planking so as to give a rough finish including centering, shuttering and propping etc. height of propping and centering below supporting floor to ceiling not exceeding 4 m. and removal of the same for in situ reinforced and plain concrete work in staircase with slopping or stepped soffits including risers and stringers excluding landing.

1.0. Materials and Workmanship

1.1. The relevant specifications of item No. 9.1.(A) shall be followed except that the work is for staircases, with slopping or stepped including risers and stringers excluding landing.

2.0. Mode of measurements and payment

2.1. The relevant specifications of item No. 9.1. (A) shall be followed.

2.2. The rate shall be for a unit of one sq. meter.

9.1.(Q) Providing form work of ordinary timber planking so as to give a rough finish including centering shuttering, strutting and propping etc. height of propping and centering below supporting floor to ceiling not exceeding 4 m. and removal of the same for In situ reinforced and plain concrete work in vertical fins and vertical sun-breakers.

1.0. Materials and Workmanship

1.1. The relevant specifications of item No. 9.1. (A) shall be followed except that the work is for vertical fins and vertical sun breakers.

1.2. The rate shall be for a unit of one sq. meter.

9.7. Extra for providing form work with sweating of steel sheets so as to give a fair finish in :

(A) Foundation, footings, base of columns etc. mass concrete.

(B) Flat surfaces such as soffits, of slab landing and the like.

(i) Floors etc. up to 200 mm. in thickness.

(ii) Floors etc. above 200 mm. in thickness.

(C) Vertical surfaces such as walls (Any thickness) partitions.

(D) Columns, pillars posts and struts.

67

1. Square, rectangular, bressumers, and lintels not exceeding 1 mm. depth.

2. Sides and soffits and beams, beam haunchings, cantilevers, girders, breassumers and lintels exceeding 1 mm. in depth.

(I) Edges of slabs, and breaks in floors and walls.

(K) Small surfaces such as cantilever ends, brackets, and ends of steps, caps and bases to pillars and columns including edges.

(L) Chollar woods, weather sheds, chhajjas, corrodes etc. and the like.

(M) Stair cases sloping or stepped soffits, including risers, skidders excluding landing.

(Q) Vertical fine and vertical sun breakers.

1.0. Materials and Workmanship

1.1. The relevant specification of item No. 9.1 .(A) to (Q) shall be followed except that the extra rate shall be paid for using sheathing of steel sheets, and plates of steel or plywood instead of ordinary timber plank, to obtain a desired smooth exposed finish of surface. The surface shall be presentable without further treatment.

2.0. Mode of measurements and payment

2.1. The measurement of form work shall be taken for the work done with steel sheathing, extra over and above the rate of form work of respective item ' from work done. The relevant specification of respective item No. 9.1. (A) to (Q) shall be followed.

2.2. The rate shall be for a unit of one sq. meter.

68

SECTION 10

Wood Work, Doors & Windows

10.1.(A) Providing wood work in frames of doors, windows, clerestory windows and other similar work, Wright, framed and fixed in position, Indian Teak wood.

1.0. Materials

Wooded in frames shall conform to M-29.

2.0. Workmanship

2.1. The item covers the requirement of frames for doors, windows, clerestory windows, their supply and fixing.

2.2. Frames:

2.2.1. All members of frames shall be exactly at right angles. The right angle shall be checked from inside surfaces of the-frames of the respective members.

2.2.2. All members of frames shall be straight without any warp of bow and shall have smooth surfaces well planed on the three sides exposed at right angles to each other. The surfaces touching the wall may not be planed unless it is required in order to straighten up the member or to obtain the overall sizes within the tolerances as specified.

2.2.3. Frame shall have dovetail joints. When clerestory windows included, it shall be provided by having full length one piece post for door or windows and clerestory window extending the frame on top at the head to the required extent. Horns shall not be provided in the head of the frame. When no sills are provided, the vertical posts of the frame in the ground floor shall be embedded in the sill masonry for 10 cm. on upper floors, the vertical posts shall be fixed in the floor or masonry by forming notches 10 mm. deep. Slight adjustment of spacing as necessary shall be done to have the hold fasts in the joints of masonry; course. The frame shall be erected in position and held plumb with strong support form north sides and built in masonry as it is being built. The transom shall be through tenoned into the mortises of the jamb post to the full width of the jamb post and the thickness of the tenon shall be not less than 15 mm.

2.3. Tolerance:

Unless specially mentioned otherwise tolerance of + 1.5. mm shall be allowed for each wrought face.

2.4. The tenons shall be closely fitting into the mortises and suitably pinned with wood dowels not less than 10 mm. dia. meter. The depth of rebates for housing the shutter shall be as shown in the detailed drawing or as directed.

2.5. The concrete surface of tenon and mortise shall be treated before putting together with an adhesive of approved make.

2.6. Minimum number of three hold-fasts shall be fixed on each side of door and windows frames, one at the center point and the other two at 30 mm. from the top and bottom of the frames. In case of windows and ventilators frames. The size c. each hold-fast shall be 300 x 25 x 6 mm. and of mild-steel with split end. The hold fasts shall be fixed with screws to frames.

2.7. Mild steel hold fasts shall be protected with a coating of coal asphalt tar. The surface of frame abutting the masonry or concrete faces shall be properly treated by applying a coat of approved coating.

3.0. Mode of Measurements and payment

3.1. The linear dimensions shall be measured correct up to 1 cm. The quantity shall be worked out correct to places of decimals of cu. m.

3.2. The rate shall be for a unit of 10 cu. diameter.

10.4.(A) Providing work in trusses, purloins, falters, posts, post plates, wall plates, and like wrought, framed, hoisted and fixed in position, Indian teak wood.

1.0. Materials

The teak wood shall conform M-29.

2.0. Workmanship

2.1. The relevant specifications of item No. 10.1.(A) shall be followed except that wood work shall be carried mi* in trusses, purloins, falters, posts, plates, wall plates and like wrought framed.

2.2. The work shall be carried out as per detailed drawings supplied by the Department as directed;

2.3. The length of the each member shall be in one piece or as directed.

3.0. Mode of measurement and payment

The length, breadth and depth shall be measured nearest to 1 cm. of unfinished member. The rate shall be for a unit of 10 cubic Decimeter.

69

10.5. (A) Providing wood work in frames of false ceiling partition etc. swan and put up in position, Indian teak wood.

1.0. Materials

The teak wood shall conform to M-29.

2.0. Workmanship

The relevant specification of item No. 10.1.(A) shall be followed except that the wood work shall be for false, ceiling, partitions, etc. swan and put in position.

3.0. Mode of measurement and payment

3.1. The relevant specifications of item No. 10.1.(A) shall be followed.

3.2. The rate shall be for a unit of Ten cubic Decimeter.

10.12.(A)(i) Providing and fixing 35 mm. thick fully paneled shutters for doors, windows and clerestory windows including anodised aluminum butt hinges with necessary screws. Indian Teak Wood.

1.0. Materials.

1.1. Wood for shutter shall conform to M-29. 2. Glass shall conform to M-38. 3. Anodised aluminum butt hinges

shall conform to M-43.

2.0. Workmanship

2.1. The item covers the requirement of preparation of shutters for doors, windows, clerestory windows, their supply and fixing.

2.2. Shutters:

2.2.1. Paneled shutters shall be constructed in the form of timber frame work of styles and rails with panel inserted of type as specified in the detailed drawings. Panel shall be fixed by providing grooves in the style and rails. The styles and rails shall be joined to each other by mortise and tenon joints at right angles.

2.2.2. All members of the shutters shall be straight without any warp or bow and shall have smooth, well planed faces at right angles to each other.

2.2.3. The size of styles and rails shall be as per drawings or as directed. Styles and rails of shutters shall be made of one piece only.

2.3. Timber paneling:

2.3.1. Thickness of the panel shall be as specified in the item as shown in the drawing or as directed. If the panel is made from more than one piece the pieces shall be finished as shown in the detailed drawings and shall be joined with continuous groove with specified size. The end pieces of the panel and the top and bottom of the panel shall be provided with continuous tongue to frame into groove of the frame shutter. An air space of 1.5 mm. shall be left in the groove of frame of shutter while framing the panels in it.

2.3.2. The faces of the panel as well as various pieces of the panel shall be- closely fitted to the sizes of the grooves.

2.3.3. Finishing of the corners of raised panel edges shall be done as shown in drawings or as directed.

2.3.4. The thickness specified shall be finished thickness and no tolerance will be permitted.

2.5. Fixtures and Fastenings:

2.5.1. The rate shall include anodised butt hinges including fixing with iron screws. The size and number of hinges shall be as per table given in annexure-1.

3.0. Mode of measurement and payment

3.1. The rate for shutter includes cost of providing block and cleat for keeping the shutter in open position if directed.

3.2. The dimension of the shutter shall be measured clear size of the shutter in close position between the grooves of the frame.

3.3. The rate shall be for a unit of one sq. meter.

19.12.(A)(II) Providing and fixing 35 mm. thick fully shutters for doors, windows and clear story windows including anodised aluminum butt hinges with necessary screws, Indian teak wood.

1.0. Materials

Teak wood shall conform to M-29 Glass shall conform to M-38. Anodised aluminum butt hinges shall conform to M-43.

2.0. Workmanship

2.1. The relevant specifications of item No. 10.12 (A) I shall be followed except that the 35 mm. thick shutters full glazed for doors, windows and clear story windows including anodised aluminum butt hinges with necessary screws.
70

2.2. Glazing:

2.2.1. The glass panels shall be embedded in putty and secured to the rebate by wooden beads, or moulding shape and size as approved with counter sunk screws of suitable size.

2.2.2. The glass panels shall be properly cut to fit the rebates of the frames and sashes fully with a slight minus margin of about 1.5. mm. on all sides. Before blazing, the frame shall be primed and prepared for painting so that wood may not draw oil out of putty. The rebate shall be putted to an extent to provide bedding all round the glass.

2.2.3. The glass shall then be bedded in putty and fitted to frames with wooden heads or moulding as directed and secured with counter sunk screws. The screws shall be spaced not more than 100 mm. from each corner and not more than 200 mm. apart.

2.2.4. The size of the rebate in the frame and size and shape of beads of moulding shall be as per detailed drawings or as directed. The beads or mouldings shall have mitered corners.

3.0. Mode of measurement and payment

3.1. The relevant specifications of item No. 10.12 (A) (I) shall be followed.

3.2. The rate shall be for a unit of one sq. meter.

10.12(A)(II) Providing and fixing 35 mm. thick partly paneled and partly glazed shutters, or doors, windows, including anodized aluminum butt hinges with necessary screws, Indian teak wood.

1.0. Materials

Teak wood shall conform to M-29. Glass shall conform to M-38. Anodised aluminum butt hinges shall conform to M-43.

2.0. Workmanship

The relevant specifications of item No. 10.12.(A) (II) shall be followed except that the 35 mm. thick shutter shall be partly paneled and partly glazed for doors, windows, clear story windows etc. as per drawings.

3.0. Mode of measurement and payment

3.1. The relevant specifications of item No. 10.12 (A) (I) shall be followed.

3.2. The rate shall be for a unit of one sq, meter,

10.13.(A)(I) Providing and fixing 35 mm. thick full paneled, shutters for doors, windows and clear story windows including black enameled M.S. Butt, hinges with necessary screws, Indian Teak Wood.

1.0. Materials & Workmanship

1.1. The relevant specifications of item No. 10.12 (A) (II) shall be followed except that the hinges shall be of black enameled M.S. Butt hinges. The hinges, bolts and other items of iron mongery with moving parts shall be properly oiled by the contractor before handing over the building.

2.0. Mode of measurement and payment

2.1. The relevant specifications of item No. 10.12 (A) (I) shall be followed.

2.2. The rate shall be for a unit of one sq. meter.

10.13.(A)(II) Providing and fixing 35 mm. thick full glazed shutters for doors, windows and clear story windows including black enameled M.S. Butt, hinges with necessary screws, Indian Teak Wood.

1.0. Materials & Workmanship

1.1. The relevant specifications of item No. 10.12 (A) (II) shall be followed except that the hinges shall be of black enameled M.S. Butt hinges. The hinges bolts and other items of iron mongery with moving parts shall be properly oiled by the contractor before handing over the building.

2.0. Mode of measurement and payment

2.1. The relevant specifications of item No. 10.12 (A) (I) shall be followed:

2.2. The rate shall be for a unit of one sq. meter.

10.13(A)(III) Providing and fixing 35 mm. thick partly paneled and partly glassed shutters for doors, windows, and clearstory windows including black enameled M.S. Butt hinges with necessary screws, Indian Teak Wood.

1.0. Materials & Workmanship

The relevant specification of item No. 10.12 (A) (III) shall be followed except that the hinges shall be of black enameled M.S. butt hinges, bolts and other items of ironmongery with moving parts shall be properly oiled by the contractor before handing over the building.

2.0. Mode of measurements & payment

2.1. The relevant specifications of item No. 10.12. (A) (I) shall be followed.

2.2. The rate shall be for a unit of one sq. meter.

71

10.15.(A)(I) Providing and fixing 25 mm. thick paneled, shutters for cup-boards etc. including anodised aluminum butt hinges with necessary screws, Indian Teak Wood.

1.0. Materials

First class Indian teak wood for shutters shall conform to M-29. Glass shall conform to M-38. Anodised aluminum butt hinges shall conform to M.43.

2.0. Workmanship

2.1. The relevant specification of item No. 10.12. (A) (I) shall apply except that the thickness of shutter shall be 25 mm. for cup-boards.

3.0. Mode of measurement & payment

3.1. The relevant specifications of item No. 10.12 (A) (I) shall be followed.

3.2. The rate shall be for a unit of one sq. meter.

10.15.(A)(H) Providing and fixing 25 mm. thick fully glazed shutters for cup-boards etc. including anodised aluminum butt hinges with necessary screws, Indian teak wood.

1.0. Materials & Workmanship

The relevant specifications of item No. 10.12.(A) (I) and 10.12 (A) (II) shall be followed except that the thickness of shutters shall be 25 mm. thick and partly paneled and partly glazed shutters as per drawings for cup-boards.

2.0. Mode of measurements and payment

2.1. The relevant specifications of item No. 10.12 (A)(I) shall be followed.

2.2. The rate shall be for a unit of one sq. meter.

10.15.(A)(IH) Providing and fixing 25 mm. thick partly paneled and partly shutters for cub-boards etc. including anodised aluminum butt hinges with necessary screws, Indian teak wood.

1.0. Materials & Workmanship

The relevant specifications of item No. 10.12.(A) (I) and 10.12 (A) (II) shall be followed except that the thickness of shutters shall be 25 mm. thick and partly paneled and partly glazed shutters as per drawings for cupboards.

2.0. Mode of measurements and payment

2.1. The relevant specifications of item No. 10.12 (A)(I) shall be followed.

2.2. The rate shall be for a unit of one sq. meter.

10.16.(A)(I) Providing and fixing 25 mm. thick fully paneled, shutters for cup-boards etc., including black enameled M.S. butt hinges with necessary screws, Indian Teak Wood.

1.0. Materials & workmanship

1.1. The relevant specifications of item No. 10.12 (A) (I) shall apply except that the wood for shutters shall be Indian teak wood and black enameled M.S. Butt hinges are to be used instead of anodised aluminum butt hinges and thickness of shutter shall be 25 mm.

2.0. Mode of measurements & payment

2.1. The relevant specifications of item No. 10.12. (A) (I) shall be followed.

2.2. The rate shall be for a unit of one sq. meter.

10.16.(A)(H) Providing and fixing 25 mm. thick fully glazed shutters for a cup-boards etc., including black enameled M.S. Butt hinges with necessary screws, Indian Teak Wood.

1.0. Materials & Workmanship

The relevant specifications of item No. 10.15.(A) (I) shall be followed except that the fully glazed shutters of 25 mm.

thickness shall be of India Teak Wood fixed in position with black enameled butt hinges for cup-boards.

2.0. Mode of measurements & payment

2.1. The relevant specifications of item No. 10.12 (A) (I) shall followed.

2.2. The rate shall be for a unit of one sq. meter.

10.16.(A)(III) Providing and fixing 25 mm. thick partly paneled and partly glazed shutters for cupboards etc., including black enameled M.S. butt hangs with -necessary screws. Indian Teak Wood.

1.0. Materials

The relevant specifications of item No. 10.15 (A) (I) & 10.15 (A) (II) shall be followed except that the shutters shall partly paneled and partly glazed of 25 mm. thickness of Indian Teak Wood fixed with black enameled butt hinges for cup-boards.

2.0. Mode of measurement & payment

2.1. The relevant specifications of item No. 10.12 (A)-shall be followed. 12. The rate shall be for a unit of one sq. meter.

72

10.23. Providing and fixing 35 mm. thick paneled glazed or paneled and glazed shutters for doors, windows, and clearstory windows including anodised aluminum butt hinges with necessary screws. Indian Teak Wood shutters with (A) Plywood,(B) Particle, (C) Hard Board, (D) Asbestos Sheet panels.

1.0. Materials

Indian teak wood for shutters shall conform to M-29. Glass shall conform to M-38.

(A) Plywood shall conform to M-37.

(B) Particle board shall conform to M-40. Anodised aluminum butt hinges shall conform to M-43.

(C) Hard board shall of best quality and shall be as approved by Engineer-in charge.

(D) A.C. sheet shall conform to M-24.

2.0. Workmanship

2.1. The relevant specifications of item No. 10.12 (A) (I) shall apply to this item except that the work is shuttered with (A) plywood (B) particle board (C) hard board panels (D) A.C. sheets panels as specified in item.

2.2. The shutter shall be prepared by fittings styles and rails (top, bottom, lock and frieze) as for paneled leaves with simple chamfer on edge only. The styles and rails shall be grooved with just sufficient width for receiving panels and plain panels of specified type panels shall be fitted into the grooves.

3.0. Mode of measurements & payment

3.1. The relevant specifications of item No. 10.12 (A) (I) shall be followed.

3.2. The rate shall be for a unit of one sq. meter.

10.24. Providing and fixing 35 mm. thick paneled, glazed or paneled and glazed shutters for doors, windows and clearstory windows including black enameled M.S., butt hinges with necessary screws. Indian Teak Wood shutters with (A) Plywood (B) Particle board (C) Hard Board (D) Asbestos panels.

1.0. Materials & Workmanship

1.1. The relevant specifications of item No. 10.23 shall be followed except that the hinges shall be of back enameled M.S. Butt hinges instead of anodised aluminum butt hinges and shutter with (A) Plywood (B) Particle board (D) Hard Board (D) Asbestos sheet panels as specified in item.

2.0. Mode of measurement & payment

2.1. The relevant specifications of item No. 10.12 (A) (I) shall-be followed.

2.2. The rate shall be for a unit of one sq. meter.

10.30. Providing & fixing flush door shutters, solid core construction with frame of 1st class hard wood with cross band and face veneer or plywood face panels including anodised aluminum butt hinges with necessary screws (B) Non-decorative type and block board core. (2) 35 mm. thick.

1.0. Materials

Flush door shall conform to M-30. Plywood shall conform to M-37. Anodised aluminum butt hinges shall conform to M-43.

2.0. Workmanship

2.1. The relevant specifications of item No. 10.23 shall be followed except that the shutters be non decorative type and block board core with face veneer or plywood with 35 mm. thickness.

2.2. Ready made shutters shall be of correct size and shall fit into the door or other openings without excessive scraping of edges. Adding of battens etc., to make up to the size shall not be allowed.

3.0. Mode of measurement & payment

3.1. The relevant specification of item No. 10.12 A (I) shall be followed.

3.2. The rate shall be for a unit of one sq. meter.

10.37. Extra for using bright finished M.S. Piano hinges instead of anodised aluminum butt hinges in flush door shutter (A) Nickel Plated Piano hinges.

1.0. Materials and workmanship

1.1. The relevant specification of item No. 10.30 shall be followed except that the nickel plated piano hinges shall be provided and fixed. It shall conform to the latest Indian Standards and shall be got approved by the Engineer-incharge.

2.0. Mode of measurement & payment

2.1. The extra payment shall be made on sq. M. basis of door over and above item No. 10.30 for providing finish M.S. planed hinges instead of anodised aluminum butt hangs.

2.2. The rate shall be for a unit of one sq. meter.

73

10.39. Extra for providing vision panel not exceeding 0.1 sq. m. in all types of flush doors. (A)

Rectangular square.

1.0. Materials and workmanship

1.1. The relevant specification of item No. 10.30 shall be followed except that the vision panel not exceeding 0.1 sq. m. shall be provided.

1.2. The glass panels shall conform to M-38 and this item is extra work of providing vision panel rectangular or square not exceeding 0.1 sq. in all types of flush doors.

2.0. Mode of measurements & payment

2.1. The payment shall be made over of item No. 10.30 for this extra work on shutter in which visions panels are provided.

2.2. The rate shall be for a unit of one sq. meter of door area.

10.51. Providing and fixing 30 mm. thick wire gauze shutters using galvanised M.S. Wire of I.S. gauze designation 85-G with wire of 0.56 mm. dia butt hinges with necessary screws : Indian

Teak Wood.

1.0. Materials

Wire gauze ail shall conform to M-36. The teak shall conform to M-29. Anodised aluminum butt hinges shall conform to M-43.

2.0. Workmanship

2.1. Specification for item No. 10.12 A(l) shall be adopted for shutter and fixtures and fastenings except thru 30. mm. thick wire gauze shutter shall be provided.

2.2. Wire gauze shuttering:

2.2.1. The finished sizes of the wooden components like styles, rails, mountings, shall be as per the paneled doors.

Each leaf shall have 2 panels of wire gauze as per drawings or as directed.

2.2.2. The styles, rails etc. shall be rebated 12 mm. along the side where they receive the gauze The galvanised iron webbing of 0.56 mm. dia mesh shall be used unless otherwise specified. The webbing shall be at 90 to 12 mm. along both sides of the rebate and fixed securely to the styles and rails and fillets of the size 10 mm x 10 mm, shall be securely and neatly fixed with small screws, spaced about 7.5. cm. centers round the rebate for each panel of webbing.- After the fillets are pressed well into the angle io hole the gauze hi two faces, the exposed edge of fillets shall be neatly rounded. The gauze shall be tightly stretched during fixing The space between the fillet and the rebate where the webbing is bent shall be neatly finished with putty, so that cut end of webbing may not be visible. Each shutter shall be fitted with a pair of anodised aluminum but! hinges with necessary iron screws.

3.0. Mode of measurement & payment

3.1. The relevant specifications of item No. 10.12 shall be followed.

3.2. The rate shall be for a unit of one sq. meter.

10.53. Providing and fixing 30 mm. thick wire gauze shutters using galvanised M.S. wire of wire gauze designation 85 G with wire of 0.56 mm. dia. for doors, windows, and clerestory windows including bright finished or/and black enameled M.S. butt hinges with necessary screws. Mango wood or equivalent quality.

1.0. Materials & workmanship

The relevant specification of item No. 10.51 shall be followed except that the hinges to be used shall be bright finish or/and black enameled M.S. butt hinges with screws and the wood shall be used of Mango wood or equivalent quality of non teak wood.

2.0. Mode of measurement and payment

2.1. The relevant specification of item No. 10.12 shall be followed.

2.2. The rate shall be for a unit of one sq. meter.

10.54. Extra for providing and fixing galvanised M.S. gauze of I.S. gauge designation 140 G. to doors windows and clerestory windows with wire of dia 0.71 mm. instead of I.S. gauge designation 85 G. with wire of dia. 0.56 mm.

1.0. Materials & workmanship

1.1. The relevant specification for item no. 10,51 & 10.53 shall be followed for this item except that the diameter of wire shall be 0.71 mm. of I.S. gauge designation 140 G. instead of 596 G. diameter I.S. gauge designation 85 G.

2.0. Mode of measurements and payment

2.1. The payment shall be made extra over and above the payment for galvanised M S wire gauge.

2.2. The rate I.S. gauge designation 85 G. shall of one sq. mt of size of doors and windows shuttles

74

10.74. Providing and fixing 12 mm. thick and 100 mm. wide pellet of flat pressed 3 layer veneered particle board solid core with 25 mm. diameter aluminum curtain rod brackets including fixing with 25 mm. x 3 m. M.S. flat 10 long and plug etc. comp.

1.0. Materials

(1) 3 layers veneered particle board solid core snail-conform to M-40 25. mm. diameter aluminum curtain rod and 25 mm. x 3 mm. x 10 cms. long M.S. flat and plugs shall of best approved quality as directed.

2.0. Workmanship

The work shall be done as per drawing and description given in the item of work. The wooden planks shall be planed smooth and oven on the exposed surface.

The pellet shall be fixed Jo level by means of 10 cms. long x 25 mm. x 3 mm. M.S. flat brackets lent in the form of

angle and wooden plug fixed in the walls using wood screws. For pelmet up to 1.5 meter long two such brackets shall be used and additional bracket provided for longer pelmet at the rate of one per meter length extra. The curtain rods be fixed by suitable brackets at the ends to the pelmet as directed.

3.0. Mode of measurement and payment

3.1. Pelmets shall be measured in running meters along the sides and face.

3.2. The rate shall be for a unit of one running meter.

10.84. Providing and fixing 40 mm. paneled, glazed or paneled and glazed partitions fixed to frames with iron screws etc., complete with India teak wood (Frames to be paid separately)

1.0. Materials

Indian Teak wood shall conform to M-29. Glass shall conform to M-38. Iron screws shall be of best approved quality. Plywood shall conform to relevant specification of materials.

2.0. Workmanship

The work shall be done as per detailed drawing or as directed. The wooden frames shall be of sizes as indicated in the drawing and description of item. They shall be planed and finished smooth and even. The vertical styles and rails shall be framed by tenon and mortise joints.

The panels which may be of planks, asbestos, plywood, glass or any other materials specified shall be fixed in the grooves made in styles and rails or by means of rebate and beading fixed by suitable screws. When glazing is used as panels the glass shall be fixed by using putty in addition to beading, (the putty shall be used before applying material.

3.0. Mode of measurement and payment

Partitions shall be measured in square meters of the net area of the tiller materials provided. The rate shall be for a unit of one sq. meter.

10.85. Providing and fixing decorative plywood 4 mm. thick in portions including fixing to frames with screws etc., complete with 50 mm. x 12 mm. teak wood beading (Frames to be paid separately)

1.0. Materials

4 mm. thick decorative plywood shall be of best approved quality. Teakwood beading and screws shall be of best approved quality as directed.

2.0. Workmanship

The relevant specifications shall be same, as per that of item No. 10.84 except that partitions shall be with 4 mm. thick decorative plywood and with teakwood beading.

3.0. Mode of measurements and payment

The specifications shall be same as that of item No. 10.84. The rate shall be for a unit of one square meter.

10.86. Providing and fixing plain Asbestos cement sheet 6 mm. thick in partition including fixing to frames with screws etc., complete with 50 mm. x 12 mm. deodar wood beading (Frames to be paid separately)

1.0. Materials

Plain A.C. Sheets shall conform to M-24. Deodar wood beading shall conform to M-29. A.

2.0. Workmanship

The relevant specification of item No. 10.84 shall be followed same except that plain asbestos cement sheet 6 mm. thick shall be used in partition and Deodar wood beading of size 50 x 12 mm. size shall be used.

3.0. Mode of measurement and payment

3.1. The relevant specifications of item No. 10.84 shall be followed except that the rate excludes cost of frame work.

3.2. The rate shall be for a unit of one square meter.

75

10.88. Providing and fixing in partition 4 mm. thick medium hard board approved quality including fixing to frames with screws etc., complete with 50 x 12 mm. Teak wood beading (Frame to be paid separately)

1.0. Materials

The hard board shall be 4 mm. thick and of best quality and made as approved. Teak wood beading shall conform to M-29.

2.0. Workmanship

The relevant specifications of item No. 10.84 shall be followed except that the hard board of 4 mm. thickness shall be used in partition and teak wood beading 50 x 12 mm. size shall be used.

3.0. Mode of measurements and payment

3.1. The relevant specifications of item No. 10.84 shall be followed except that the rate excludes cost of frame work.

3.2. The rate shall be for a unit of one square meter.

10.96. 26 mm. thick wooden shelves supported on 40 x 40 x 6 mm. T or Iron brackets fixed at suitable distances not exceeding 75 cms. apart with Mango wood or equivalent quality.

1.0. Materials

The mango wood shall conform to M-29-A. Structural steel shall conform to M-22

2.0. Workmanship

The mango wood (or equivalent quality not) teak wood shelves shall be prepared from 25 mm. thick planks. The planks shall be planed smooth. The planks shall be used in single piece up to 30 cms. width. The shelves shall be fitted in position by fixing 40 x 40 x 6 mm. T or L Iron brackets. The spacing of brackets shall not be more than 75 cms. The 40 x 40 x 6 mm. T or L from brackets shall be fixed firmly in position by imbedding the same in concrete. The shelves shall

be fixed as directed. The season teak wood buttons of size 35 x 12 mm. shall be fixed on open side as directed.

3.0. Mode of measurements and payment

3.1. The shelves shall be measured in Sq. meter. The length and breadth of shelves shall be measured net.

3.2. The rate is inclusive of button provided:

3.3. The rate shall be for a unit of one sq. meter.

10.97. 40 mm. thick wood shelves supported on 40 x 40 x 6 mm. T or L Iron brackets fixed at suitable distance but not exceeding 75 cms. apart with mango wood or equivalent quality.

1.0. Materials & Workmanship

The relevant specifications of item No. 10.96 shall be followed except that the thickness of shelves shall be 40 mm Thick teak wood buttons shall be provided of 50 x 12 mm. on all open sides.

2.0. Mode of measurements & payment

2.1. The relevant specifications of item NO. 10.96 shall be followed.

2.2. The rate shall be for a unit of one square meter.

10.99. Providing and fixing M.S. round or square bars with M.S. flats at required spacing in wooden frames of windows and clerestory windows.

1.0. Materials

M.S. bars and flats shall conform m. 18 and M-22 respectively.

2.0. Workmanship

2.1. The M.S. bars shall be fabricated as shown in the drawing or as directed. It shall conform to I.S. 226-1975 and I.S. 96 and I.S. 1977-1975. The M.S. bars shall be fixed at the required spacing in mild steel flats, after drilling holes in the latter. The diameter and spacing of these bars shall be as mentioned in the drawing or as directed. The bars shall be passed through drill holes drilled into the mild steels flats, fixed in the recess in frames. The flats shall be fixed with iron screws.

3.0. Mode of measurements & payment

3.1. The rate shall be for the M.S. round or square bars with M.S. flats provided and fixed in position as per the specifications for the completed item.

3.2. The rate shall be for a unit of one Kg

10.100.(A) Providing and fixing M.S. Grills of required pattern to wooden frames of windows etc., with M.S. flats at required spacing and frame around, square, or round bars with round headed bolts and nuts or by screws : plain Grill.

1.0. Materials

The structural steel shall conform to M-22

76

2.0. Workmanship

2.1. The M.S. Grill shall be prepared as per the drawing or as directed for fixing to wooden frames of windows etc.

2.2. The grill shall be fabricated to the designs and patterns shown in the drawings and the weight shall be as directed, and the joints shall be reverted or welded as shown in the plan or as directed. The grill so formed shall be fixed into the frames of the windows etc. before they are erected in position. The outside strip frame of the grill shall be housed to its full thickness into the recess cut into the frame of the windows etc. The grill shall be fixed to the frame with number of bolts and nuts or screws viz. bolt nut/screw per 30 cm. of the length of outer strip subject to minimum of 2 Nos. on each side of the frame or as indicated in the drawing or as directed.

2.3. The bolts and nuts or screws shall be counter sunk and shall be fixed with the top of their heads flush with the face of the frame strips.

3.0. Mode of measurements & payment

3.1. No payment shall be made for weight of screws, bolts nuts etc. only weight of grill shall be paid.

3.2. The rate shall be for a unit of one kg.

10.100.(B) Providing and fixing M.S. Grill of required pattern to wooden frames of windows etc. with" M.S. plates, at required spacing and frame around, square or round bars with round headed bolts and nuts or by screws and with ornamental grill.

1.0. Materials & Workmanship

1.1. The relevant specification of item no. 10.100 (A) shall be followed except that the work is for of ornamental grill.

2.0. Mode of measurements & payment

2.1. The relevant specifications of item No. 10.100 (A) shall be followed.

2.2. The rate shall be for a unit of one Kg.

10.102. Providing and fixing hard drawn steel wire fabric 75 x 25 mm. mesh of weight not less than 7.75 kg. per sq.M to window frames etc, including 60 x 20 mm. beading of teak wood.

1.0. Materials

Hard drawn steel wire of 75 x 25 mm. mesh shall conform to M-34. Teak wood beading shall conform to M-29.

2.0. The steel wire fabric 75 x 25 mm. mesh of weight of not less than 7.75 kg per Sq.M. to windows frames etc. shall be fabricated as per detail drawings. The wire fabric shall be fixed to windows frame by teak wood beading of 60 x 20 mm. size be by means of screws.

3.0. Mode of measurements & payment

3.1. The wire mesh (Hard drawn) shall be measured net clear opening of frame of windows in which mesh is fitted. Nothing shall be paid extra for fixing mesh in groove below teak woods-beading.

3.2. The rate shall be for a unit of one sq. meter.

10.103. Providing and fixing fly proof galvanised M.S. Wire gauge of I.S, Gauge designation 85 G. with

wire of dia. 0.56 mm. to windows and clerestory windows including 60 x 20 mm. beading of Indian Teak Wood.

1.0. Materials

The fly proof galvanised M.S. wire gauge shall conform to M-36. Teak wood .beading shall conform to M-29. 2.0. Workmanship

The relevant specifications of item No. 10.102 Shall be followed except that fly proof galvanised M.S. wire gauge of I.S. gauge designation 85-G with wire of 0.56 mm. shall be provided.

3.0. Mode of measurement & payment

3.1. The relevant specifications of item No. 10.102 shall be followed.

3.2. The rate shall be for a unit of one square meter.

10.120. Providing and fixing first class Indian teak wood, 75 x 60 mm. moulded hand rails in , straight lengths completed.

1.0. Materials

First class Indian teak wood shall conform to M-29.

77

2.0. Workmanship

The teak wood hand rail shall be of size 75 x 60 mm. The hand rail shall be prepared from first class Indian teak wood. The hand rail shall be moulded as per detail drawings. The hand rail shall be fixed in straight length as per detail drawings with screws. The relevant specifications of item No. 10.4 shall be followed except that the teak wood work shall be for a railing of specified size.

3.0. Mode of measurements & payment

3.1. The hand rail shall be measured in running meter.

3.2. The rate shall be for a unit of one running meter.

10.0.0.(I) Providing and fixing glazed louvered Glass windows and ventilators with teak wood frame

10 x 75 mm. size including 3 coats of oil painting to wood work etc. complete,

1.0. Materials

Indian teak wood shall conform to M-29. Glass shall conform to M-38.

2.0. Workmanship

The relevant specifications of item No. 10.1 (A) shall be followed for frame work except that the frame work of 10 x7 cms. size of required size ventilators shall be provided with glazed glass louvers. The glass louvers shall be provided as directed. In the groove of 1.25 cms. depth made in frames, the thickness of glass shall be 5 mm. and glass shall be glass of best quality. The ventilation blades shall slope done towards the outside at an angle of 450.

3.0. Mode of measurements and payment

3.1. The area of opening within the frame in which louvers are fixed shall be measured in sq. meters.

3.2. The rate included painting 3 coats to wood work with ready mix paint.

3.3. The rate shall be far a unit of one square meter.

10.0.0.(II) Providing & fixing with wooden louvers plank 12 mm. thick windows and ventilators with teak wood frame 10x7 cms. size including 3 coats of oil painting to wood etc complete.

1.0. Materials & Workmanship

The relevant specifications of item No. 10.00 (I) shall be followed except that the teak wood planks 12.00 thick louvers shall be provided.

2.0. Mode of measurements & payment

2.1. The relevant specifications of item No. 10.00 (I) shall be followed.

2.2. The rate shall be for a unit of one square meter

78

SECTION-11

Steel Shutters, Windows, Ventilators

11.2. (A) Steel work riveted, in built up sections, framed work including cutting, hosting fixing in position and applying a priming coat of red lead paint. In beam and joints, channels, angles tees, flats, with connecting plates or Angle cleats as in main & cross beams, Hop and jack falters, pralines connected to common rafters and the like.

1.0. Materials

The structured steel work shall conform to M-22. Red lead paint shall conform to I.S : 102-1962.

2.0. Workmanship

2.1. The steel sections as specified or required, shall be cut, square and to correct lengths, as per drawings and design. The .cut ends exposed to view shall be finished smooth. No two pieces shall be welded or otherwise jointed to make up the required length of member, except as indicated in the drawing or as directed. All straightening and shaping to form shall be done by application of pressure and not by hammering. Any bending or cutting shall be carried out in suet] a manner as not to impair the strength of the metal. All operations shall be done in cold state unless otherwise directed/permited.

2.2. Steel riveted or bolted in built up sections, frame work.

2.2.1. The steel structure as shown in the drawings or as per direction of the Engineer-in-charge shall be laid out on a level platform to full scale and to full size in parts. A steel tape shall be used for measurements to ensure maximum accuracy.

2.2.2. Wooden templates 12 mm. to 19 mm. thick or metal sheet template shall be made to correspond to each connecting gussets plate and rivet holes shall be accurately marked on them and drilled. The templates shall be laid on the steel members and holes of the steel members shall also be marked for curing. The base of steel

column and the position of Anchor bolts shall be carefully set out

2.2.3. Ail stiffeners shall be formed by pressure and where practicable the metal shall not to be cut and welded in making these. In major work, or where so specified, shop drawings giving complete details and information for the fabrication of the component parts of the structure including location, type, size, (origin and details or rivets, bolts or weld shall be prepared in advance of the actual fabrication and as distinctly marked or stenciled with paint with the identification mark as given in the shop drawings. The bars shall be thickened at the ends, so as to provide for screwed threads and gradually tapered off to meet their normal section.

Great accuracy shall be observed in fabrication of various member, so that these can be assembled without being unduly packed, stained, or forced into position and when build up, shall be true and free from twists, wrinkles, buckles, or open joints.

Before making holes in individual members for fabrication the steel work intended to be riveted or bolted together shall be as aligned or clamped properly and tightly so as to ensure close abutting or lapping of the surfaces of the different members. All stiffeners shall bear tightly both at top and bottom without being drawn or caulked. The abutting joints shall be cut or crossed true and straight and fitted close together. Web splice plates and fillers under stiffeners shall be cut to fit within 3 mm. or flange Angles Web plates of Girders shall have no cover. Plates, shall have their ends flush with the top of angles forming the flanges unless otherwise required. The web plates when spaced shall have clearance of not more than 6 mm. The erection, clearance for created ends of members connecting steel shall preferably be not greater than 1.5 mm. The erection clearance at the ends of beams without web cleats shall not be more than 3 mm. at each end but where for a practical reason greater clearance is necessary, suitably designed seating shall be provided.

Rollers shall be accurately tuned to gauge. These shall be straight and smooth and free from flaws. The roller bearing shall be provided with adequate arrangements for holding the girders or truss resting on it. In columns caps and bases, the ends of shifts together with the attached gussets Angles, channels etc after riveting together shall be accurately mechanized so that the parts connected butt against each other over the entire surfaces of contact connecting angles or channels shall be fabricated and placed in position with greater accuracy so that they are not unduly reduced in thickness by machining. The ends of bearing stiffeners shall be mechanized or ground to fit tightly both at the top and bottom. All holes shall generally be drilled to the required size and at required position. Sub punching shall be permitted provided it is done 3 mm. or less in diameter and reamer thereafter to the required size. The holes for rivets and bolts shall be larger by 0.4 to 6 mm. than the nominal diameter of rivets or bolts depending upon the diameter of rivets.

Holes shall have their axis perpendicular to the surface bored through. The drilling or reaming shall be free from burrs, and the holes should be clean and accurate holes for counter sunk bolts shall be made in such a manner that their heads fit flush with the surface after fixing.

79

The fabrication work shall be completed in workshop as far as it is practicable to do so. Site joints shall be done with rivets and fitted bolts or black bolts, as shown in the drawings or as directed. Generally the following principles shall govern the use of rivets turned and fitted bolts, and black bolts.

(i) Rivets and turned and fitted bolts shall be used where the connections is such that slip under load has to be avoided.

(ii) Black bolts may be used very sparingly where a force is carried through a connection without impact, vibration or reversal or stresses.

2.2.4. Riveting:

The parts assembled for riveting shall be in close contact with each other and the bearing stiffeners shall bear tightly both at top and bottom without being drawn or caulked. Members to be riveted shall be properly pinned or bolted and rigidly held to gather while riveting. Drifting of holes shall not be permitted Except to draw the parts together and the drifting tools so used shall have maximum diameter not exceeding, the nominal diameter of rivets or bolts. Drifting done during assembling shall not distort the metal or enlarge the holes.

The shanks of rivets shall project beyond the plate-surface sufficiently so as to fill hole thoroughly and form the required head after riveting.

The riveting shall be done by hydraulic or pneumatic process. However, where such facilities are not available, hand riveting may be permitted. The rivet shall be heated red hot, care being taken to control the temperature of heating so as not to burn the steel. Rivets of diameter less than 10 mm. may be fitted cold. Rivets shall be of heat finish with heads full and of equal size. All loose, burnt or badly formed rivets with concentric or deficient heads shall be cut out and replaced. The heads of rivets shall be central to shanks and shall grip the assembled member firmly. In cutting out rivets, care shall be taken so as not to injure assembled members, caulking or re-equipping shall not be permitted.

For testing rivets, a hammer weighing approximately 0.25 kg shall be used. Both heads of the rivets shall be tapped, slack rivets will give a hollow sound and a jar.

All rivet heads shall be painted with red lead paint within a week of their fixing.

2.2.5. All bolt heads and nuts shall be hexagonal and of equal size unless specified otherwise. The screwed heads shall conform to I.S. 1363-1960 and the threaded surface shall not be tapered. The bolts shall be of such length so as to project two clear threads beyond the nuts when fixed in position and these shall fit in the holes without any shakes. The nut shall fit in the threaded ends of bolts properly.

Where turned and fitted bolts are required to be used in place of rivets shall be provided with washers not less than 6 mm. thick so that the nut when tightened shall not bear on the unthreaded body of the bolt Tapered washers shall be provided for all heads and nuts bearing on leveled surfaces. The threaded portion of the bolt shall not be within the thickness of the parts bolted together, the faces of the bolt heads and nuts abutting against steel members shall

be machine finished. Where there is a risk of the nut being removed or becoming loose due to vibrations or reversal of stresses, these shall be secured from slackening by the use of locknuts, spring washers, cross-cutting or hammering down of threads as directed.

Bolts, nuts, and washers shall be thoroughly cleaned and dipped in double boiled linseed oil before use. The whole steel work shall be painted with a coat of priming coat of red lead, as per relevant specification of painting.

3.0 Mode of measurements & payment

3.1. The steel work shall be measured in general as under:

- (a) All work shall be measured on the basis of finished dimensions as fixed at site and measured net unless specified otherwise.
- (b) The weight of steel sections, steel rods, and steel strips in finished work shall be calculated on the same basis on which steel is supplied to Contractor by department or those given in relevant I.S. : if steel is arranged by the contractor.
- (c) The weight of steel plates and strips shall be taken from relevant I.S. based on 7.35 kg./sq. meter for every millimeter sheet thickness if steel is supplied to the contractor by department.
- (d) Unless otherwise specified, weight of cleats, brackets, packing pieces, bolts, nuts, washer, distance pieces, separators, diaphragm gusset (taking overall square dimensions) fish plates etc. shall be added to the weight of respective items.
- (e) In riveted work allowance is to be made for weight of rivet heads. No deductions shall be made for rivet or bolt holes excluding holes for anchor or holding down bolts.
- (f) For forged steel and steel castings, weight shall be calculated on the basis of 7850 kg./cum.
- (g) Unless otherwise specified, no allowance shall be made for the weld metal in case of welded steel structure.

80

(i) Dimensions other than cross sections and thickness of plates shall be measured to nearest 0.001m

(j) Mill tolerance shall be ignored when weight is determined by calculation.

3.2. The rate includes cost of all material, labour, erection, hoisting scaffolding, protective measure, required for proper completion of the item of work. This shall also include conveyance and delivery handling, loading, unloading and storing etc. required for completing the item described above including necessary wastage involved.

3.3. The rate shall be for a unit of one quintal.

11.2.(D) Steel work riveted in built up section, framed work including cutting, hoisting, fixing in position and applying a priming coat of red lead paint in trusses, and trussed, purlins, upto 25 m. span and 15 m. overall height.

1.0. Materials & Workmanship

The relevant specifications of item No. 11.2 (A) shall be followed except that the work shall be for trusses and trussed purlins up to 25 m. span and 15 m. overall height.

2.0. Mode of measurement & payment

2.1. The relevant specifications of item No. 11.2. (A) shall be followed.

2.2. The rate shall be for a unit of one quintal.

11.2.(A) Steel work welded, in built up sections frame work including, cutting, hoisting, fixing in position and applying a priming coat of red lead paint. In beams and joints, channels, angles, tees, flats, with connecting plates or angle cleats as in main and cross beams. Hip and jack rafters, purlins, connected to common rafters and the like.

1.0 Materials & Workmanship

1.1. The relevant specification of item No. 11.2 (A) shall be followed except that the steel work shall be done by welding.

1.2. Welding shall generally be done by electric process. Gas welding shall be resorted to, using oxyacetylene flame with specific prior approval. Gas welding shall not be permitted for structural steel work.

1.3. The work shall be done as shown in the shop drawings which should clearly indicate various details of the joints to be welded, shop and site welded as well as type of electrodes to be used, symbol for welding on plans and shop drawings shall be according to I.S. 813-1961. As far as possible every effort shall be made to limit the welding that must be done after improper welding that is likely to be done due to heights and difficult positions on scaffoldings etc. The welding work shall conform to I.S. 816-1969.

1.4. Preparation of surfaces : Surfaces which are to be welded together shall be free from loose mill scale, rust, paint, grease or other foreign matter. A coating of boiled linseed oil shall be permitted.

1.5. Assembly for welding : Before welding is commenced, the plates shall first be brought together and firmly clamped or spot welded at specified distance. This temporary connection has to be strong enough to hold the plates accurately in place without displacement.

1.6. Precautions : All operations connected with welding and cutting equipment shall conform to safety requirement given in I.S. 818-1968.

The following points shall be borne in mind during the process of welding:

(b) Arc length, voltage and amperage shall be suited to the thickness of material type of groove and other circumstances of the work.

(c) The segments of welding shall be such that where possible the members which offer the greatest resistance to compression are welded first.

1.7. The defective welds which shall be considered harmful to the structural strength shall be cut out and reworked.

1.8. Finished welds and adjacent parts shall be protected with clean boiled linseed oil and after all slag has been removed. Welds and adjacent parts shall be painted after the same are approved.

1.9. All the members shall be thoroughly cleaned of rust-scales, dust etc. and given a priming coat of red lead paint before fixing them in position.

Testing of welding to be added in the specification I.N. 12.2.2.12-(i) to (viii)

2.0. Mode of measurements & payment

2.1. The relevant, specification of item No. 11.2 (I) shall be followed.

2.2. The rate shall be for unit of one quintal.

11.4.(D) Steel work welded in built up section framed work, cutting, hoisting, fixing in position and applying a priming coat a red lead paint in trusses and trusses purlins up to 25 m. span and 15 m. overall height.

1.0. Materials & Workmanship

The relevant specification of item No. 11.4.(A) shall be followed except that the work shall be for trusses and trussed purlins up to 25 m. span and 15 m. overall height.

81

2.0. Mode of measurement & payment

2.1. The relevant specifications of item No. 11.4 (A) shall be followed.

2.2. The rate shall be for unit for one quintal.

11.6. Providing and fixing in position collapsible steel shutters with vertical channels 20 x 10x2 mm. braced with flat iron diagonals 20 x 5 mm. size with top and bottom rails of T Iron 40 x 40 x 6 mm. with 38 mm. dia steel pulleys complete with bolts, locking arrangements, stoppers, handles, including applying a priming coat red lead paint.

1.0. Materials

The collapsible steel gate shall conform to M-33.

2.0. Workmanship

J-rails shall be fixed to the floor and to the lintel at top by means of Anchor bolts, embedded in cement concrete-of floor and lintel. The anchor bolts shall be placed approximately at 45 mm. centers alternatively in groove shall be formed along the runner for the purpose. The collapsible gate shall fixed at the sites by fixing the double channels in the T-iron rail and also by hold fasts bolted to the end double channel and fixed in the masonry of the side walls or the otherwise.

In case where the collapsible gate is not required to the lintel beams or slop above, a toe iron suitably designed may be fixed at the top embedded in masonry and provided with necessary clamps and roller arrangement at the top.

All the adjoining work damaged while fixing of gate shall be made good to match the existing work without any extra payment.

All the members of the collapsible gate including. T-iron shall be thoroughly cleaned of rust, scales dust etc., and given a priming coat of red lead, before fixing them in position.

3.0. Mode of measurement and payment

3.1. The collapsible gate shall be measured in sq. meter. The height of the gate shall be measured as the length of double channels and breadth from outside to outside of the end fixed double channels in open position of the gate. The rate includes providing handles, arrangements stoppers etc.

3.2. The rate -shall be for a unit of one sq. meter.

11.7. Providing and fixing 1 mm. thick M.S. sheet sliding shutters both frame and diagonal braces of 40 x 40 x 6 mm. Angle iron 3.15. M.S.S. gusset plates at junctions and comers, 25 mm. dia. pulley 40 x 40 x 6 mm. angle and T-iron guide rail at top and bottom respectively with handles, stoppers and locking arraignments etc. including applying priming coat of red lead paint.

1.0. Materials

M.S. sliding shutters shall be fabricated of M.S. component as given in the description of item M.S. sheets 1 mm. thick shall be fixed to the frame with rivets of weld as approved. The shutters shall he provided with top and bottom guide rails of Angles or T-iron as specified and 25 mm. dia. steel pulleys at the-bottom guide black with steel pulleys at the top. The frame shall be riveted and /or welded and wherever riveting shall be done 3.15 mm. gussets plates shall be provided at the junctions.

2.0. Workmanship

2.1. The shutters shall be single or double leaf shutters as specified. The guide rails shall be sufficiently long and continued along the wall on the both ends so that the sliding shutters can rest against walls, living full opening when so required.

2.2. The guide rails shall be fixed to the floor by means of anchor bolts embed in the cement concrete floor. The steel section at the top shall be suitably supported from the walls. Two channel section shall suitably fixed vertically below the extreme clamps in the wall and floor to avoid the shutters from going out of the supports at the top and bottom. A suitable clamping arrangement will be provided at either end of the opening to avoid the shutters from rolling back into opening.

2.3. All the adjoining work damaged while fixing shall be made good to match the existing work.

2.4. All members of the sliding shutter including T-iron shall be thoroughly cleaned of nisi scales dust etc. and given a priming coat of red lead before fixing them in position

3.0. Mode of measurements & payment

3.1. The sliding doors shall be measured on sq. meter. The height of the shutters shall be measured form outside to outside of the guide, rail and width outside of shutters including vertical channels in sides. The rate includes providing handles stopped and locking arrangement etc. complete.

3.2. The rate shall be for a unit of one sq. meter.

82

SECTION-12

Labour for fixing fixtures & fastening

12.4. Fixing metallic tower bolts of sizes with necessary screws etc. complete (tower bolts and screws to be paid under separate items):

1.0. Workmanship

1.1. This item provides for labour for fixing metallic tower bolts of any size with screws, mitts etc,

1.2. The tower bolts shall be fixed in proper position as shown in the drawings or as directed. There shall be fixed truly vertical or horizontal as the case may be.

1.3. The screws shall be driven home with screw driver. In no case the screws shall be hammered in.

1.4. All recesses and seats shall be cut to the exact size for counter sinking etc. where so required.

1.5. Care shall be taken to see that no gaps are left between the fitting and the surface meant to receive the fittings.

1.6. The fittings shall be properly cleaned and left in original finish after fixing.

2.1. Mode of measurements & payment

(1) Cutting of holes, recesses, and seats involved in process of fixing.

(2) Cost of filling and cushioning materials where so required for proper seating of new fittings.

(3) Cost of nails etc. for temporary positioning of fitting.

(4) Cost of cleaning materials like old washed dhoti stain remover etc.

(5) Cost of making good the over cut recesses or holes if any.

(6) Cost of making hole of required size on the wooden frame for housing the bolt for locking.

2.2. The rate includes cost of labour involved in all operations required for proper completion of the items including carriage, handling, fixing etc. complete.

2.3. The rate shall be of unit of one number.

12.5. Fixing metallic flush bolts of size with .necessary screws etc., complete (flush bolts and screws shall be paid under separate items):

1.0. Workmanship

1.1. The relevant specifications shall be followed as per item No. 12.4. except for fixing metallic flush bolts instead of tower bolts.

2.0. Mode of measurements and payment

2.1. The relevant specifications of item No. 12.4. shall be followed.

2.2. The rate shall be for a unit of one number.

12.8. Fixing metallic or plastic door handles of sizes with necessary screws etc. complete (door handles and screws to be paid under separate items)

1.0. Workmanship

1.1. The relevant specifications of item No. 12.4. shall be followed except fixing door handles instead of tower bolts.

2.0. Mode of measurements and payment

2.1. The relevant specifications of item No. 12.4. shall be followed.

2.2. The rate shall be for a unit of one number

12.10. Fixing metallic gate and shutter hooks and eyes of sizes (hooks and eyes to be paid under separate items)

1.0. Workmanship

1.1. The relevant specifications shall be followed as per item No. 12.4 except that fixing of eye and hooks instead of tower bolts.

2.0. Mode of measurements and payment

2.1. The relevant specifications of item No. 12.4 shall be followed.

2.2. The rate shall be for a unit of one number (Hook & Eye)

83

12.11. Fixing metallic door latches of size with necessary screws (door latches and screws to be paid under separate items) :

1.0. Workmanship

1.1. The relevant specifications of item No. 12.4 shall be followed except that fixing metallic door latches instead of tower bolts.

2.0. Mode of measurements & payment

2.1. The relevant specifications of item No. 12.4 shall be followed.

2.2. The rate shall be for a unit of one Number.

12.12. Fixing metallic mortise night latches with necessary screws including making necessary crews holes in wooden door shutters etc., complete (mortise night latches and screws to be paid under separate items):

1.0. Workmanship

1.1. The relevant specifications of item No. 12.4 above shall be followed except that the fixing of mortise night latches instead of tower bolts.

2.0. Mode of measurements & payment

2.1. The relevant specifications of item No. 12.4 shall be followed.

2.2. The rate shall be for a unit of one number.

12.18. Fixing metallic ball catchers 100 mm. dia. (Ball catches to be paid under separate item):

1.0. Workmanship

1.1. The relevant specifications of item No. 12.4 shall be followed same except fixing of ball catchers 100 mm dia.

2.0. Mode of measurements and payment

2.1. The relevant specification of item No. 12.4 shall be followed.

2.2. The rate shall be for a unit of one number.

12.20. Fixing metallic casement window fasteners with necessary etc. complete. (Casement window fasteners and screws to be paid under separate items):

1.0. Workmanship

1.1. The relevant specifications of item No. 12.4. shall be followed except fixing metallic casement windows fasteners.

2.0. Mode of measurements & payment

2.1. The relevant specifications of item No. 12.4 shall be followed.

2.2: The rate shall be for a unit of one number.

12.21. Fixing metallic casement stays of sizes with necessary screws etc., complete. (Casement stays and screws to be paid under separate items)

1.0. Workmanship

1.1. The relevant specifications of item No. 12.4 shall be followed except fixing of metallic casement stays.

2.0. Mode of measurements & payment

2.1. The relevant specifications of item No. 12.4 shall be followed.

2.2. The shall be for unit of one number.

12.24. Fixing metallic cupboard of ward robe locks of sizes with necessary screws etc. complete (Locks and screws to be paid separately) :

1.0. Workmanship

1.1. The relevant specifications of item No. 12.4 shall be followed except that fixing metallic cupboard or ward robe locks of size with necessary screws etc. complete.

2.0. Mode of measurements & payment

2.1 The relevant specifications of item No. 12.4 shall be followed.

2.2. The shall be for a unit of one number

12.25. Fixing metallic or plastic cupboard or ward robe knobs of size with necessary screws/ bolts etc., (knobs and screws/bolts to be paid separately) :

84

1.0. Workmanship

1.1. The relevant specifications of item No. 12.4 shall be followed except that fixing metallic or plastic cupboard or ward robe knobs of sizes with necessary screws/bolts etc. complete.

2.0. Mode of measurements & payment

2.1. The relevant specifications of item No. 12.4 shall be followed.

2.2. The shall be for a unit of one number.

12.26. Fixing metallic floor stoppers of sizes with rubber cushion, screws etc., to suit shutter thickness complete, (floor door stopper with rubber cushion and screws to be paid under separate items) :

1.0. Workmanship

1.1. The relevant specifications of item No. 12.4 shall be followed except that fixing metallic floor stoppers.

2.0. Mode of measurements & payment

2.1. The relevant specifications of item No. 12.4 shall be followed.

2.2. The shall be for a unit of one number.

12.28. Fixing metallic door handles or knobs for mortise jocks with necessary screws etc. complete (doors, handles/knobs and screws to be paid separately) :

1.0. Workmanship

The relevant specifications of item No. 12.4 shall be followed except that fixing metallic door handles or knobs for mortise with necessary screws etc. complete.

2.0. Mode of measurements & payment

2.1. The relevant specifications of item No. 12.4 shall be followed.

2.2. The rate shall be for a unit of one number.

85

SECTION-13

Glazing

13.1.(I) Providing and fixing sheet glass, selected quality (type-C) bedded in putty and fixed with wooden beading including cost of wooden beading of first class teak wood and necessary cutting of glass 5 mm. thick.

1.0. Materials

The glass shall conform to M-38. The wood beading shall conform to M-29, Putty shall conform to I.S. 419-1967.

2.0. Workmanship

The glass shall be sheet glass of selected quality of 5 mm. thick.

2.1. The size of glass for glazing shall allow a clearance of 2.5 mm. between the edges of glass and the wood

or metal surrounds. The clearance may be increased, provided the depth of the rebate or groove is sufficient to provide not less than 1.5 m. cover to the glass. The detailed process of glazing shall be as specified in I.S. 3548-1966.

2.2. All stains from the surface of glass shall be removed and cleaned with thinner or spirit without any extra payment.

2.3. Wooden beading :

2.3.1. The size of the wood beads for glass panes shall be 1.5 cms. x 3 cms unless otherwise specified. Beads shall be secured to wooden frames with either panels pins or screws and to metal frames in the way provided for in the frame.

2.3.2. Sufficient putty compound shall be applied to the rebate so that when the glass has been pressed into the rebate, a bed of compound not less than 1.5 mm. thick will remain between the glass and the rebate. There should also be surplus of compound squeezed out above the rebate which should be stripped at an angle not under cut to prevent water accumulating. Beads should be bedded with compound against the glass and wood beads should also be bedded against the rebate. Care should be taken to see that no voids are left between the glass and the bead.

3.0. Mode of measurement & payment

3.1. All measurements of cutting shall, unless otherwise stated, be held to include the consequent waste.

3.2. Each pane' of glass shall be measured to the nearest 0.5 cms. both in width and height/length.

3.3. Irregular shaped or circular panes shall be measured as the smallest rectangular area from which the irregular or circular pane can be cut.

3.4. The rate includes cost of materials, labour required for completion of the item including hoisting, carriage, temporary erections like scaffolding etc.

3.5. The rate also includes :

(i) The wastages and breakage involved in the process.

(ii) Straight cutting on glass and glazing sheets.

(iii) Cost of subsidiary materials required for proper fixing and functioning of glass i.e. nails, spirit, putty, teak wood beading glass, pins, etc. complete.

3.6. The rate shall be for a unit of sq. meter.

13.1.(M) Providing and fixing sheet glass selected quality (Type-C) bedded in putty and fixed with wooden beading including cost of wooden beddings of first class teak wood, and necessary cutting of glass 6 mm. thick.

1.0. Materials and workmanship

1.1. The relevant specifications of item No. 13.1 (I) shall be followed except that the sheet glass of selected quality shall be 6 mm. thick.

86

2.0. Mode of measurements and payment

2.1. The relevant specifications of item No. 13.1.(I) shall be followed.

2.2. The rate shall be for a unit of one sq. meter.

13.3.(C) Providing and fixing rough cast wired glass 6 mm. thick bedded in putty and fixed with wooden beading including the cost of wooden beadings of Indian teak wood and necessary cutting of glass wired figures glass.

1.0. Materials :

Wire figure glass shall conform to M-38. Wooden beading shall conform to M-29, Putty shall conform to I.S. 419-1967.

2:0. Workmanship

The relevant specification of item No. 13.1(1) shall be followed except that the wired figured glass of 6 mm. thick shall be used.

3.0. Mode of measurements and payment

3.1. The relevant specifications of item No. 13.1(1) shall be followed.

3.2. The rate shall be for a unit of one sq. mt.

13.5.(3) Providing and fixing sheet glass ordinary quality bedded in putty and fixed with wooden beading including the cost of wooden beadings of first class teak wood and necessary cutting of glass 3 mm. thick.

1.0. Materials

Glass shall conform to M-38. Wooden beading shall conform to M-29. Putty shall conform to I.S. 419-1967. **2.0**

Workmanship

The relevant specification of item No. 13.1 (I) shall be followed except that the wired figured glass of 6 mm. thick shall be used.

3.0. Mode of measurements and payment

3.1. The relevant specifications of item No. 13.1 (I) shall be followed.

3.2. The rate shall be for a unit of one sq. mt.

13.5.(3) Providing and fixing sheet glass ordinary quality bedded in putty and fixed with wooden beading including the cost of wooden beadings of first class teak wood and necessary cutting of glass 3 mm. thick.

1.0. Materials

Glass shall conform to M-38. Wooden beading shall conform to M-29. Putty shall conform to I.S. 419-1967.

2.0. Workmanship

2.1. The specification of this item shall be followed as per item No. 13.1(1) except that the sheet glass of ordinary quality shall be used and thickness of sheet glass shall be 3 mm. thick.

3.0. Mode of measurements and payment

3.1. The relevant specifications of item No. 13.1(1) shall be followed.

3.2. The rate shall be for a unit of one sq. meter.

13.5.(4) Providing and fixing sheet glass ordinary quality, bedded in putty and fixed with wooden beadings including the cost of wooden beadings of first class teak wood and necessary cutting of glass 4 mm. thick.

1.0. Materials and Workmanship

The relevant specifications of item No. 135 (3) shall be followed, except that the thickness of ordinary sheet glass shall be 4 mm.

2.0. Mode of measurements and payment

2.1. The relevant specification of item No. 13.1(1) shall be followed.

2.2. The rate shall be for a unit of one sq. meter,

13.7. Extra for using ground glass (Frosted or obscured on one side) instead of plain glass.

1.0. Materials

Glass shall conform to M-38. Wooden beading shall conform to M-29. Putty shall conform to I.S. 419-1967.

2.0. Workmanship

The specifications of this item shall be followed as per item No. 13.1 except that ground glass (Frosted or obscured on one side) shall be used.

3.0. Mode of measurements and payment

3.1. The payment shall be made on sq. mt. basis extra over and above the payment for plain glass for using ground glass [Routed or obscured].

87

3.2. The relevant specifications of item No. 13.5 (III) shall be followed.

3.3. The rate shall be for a unit of one sq. meter.

13.11.(A) Difference in cost of material and labour involved in method of glazings if changed in item No. 13.1 to front and back puttied and sprigged or fixed with glazing pins :

1.0. Materials and Workmanship

1.1. The relevant specification of item No. 13.1 shall be followed except that the glazing is to be done by front and back puttied and sprigged or fixed with glazing pins.

2.0. Mode of measurements and payment

2.1. The relevant specifications of item No. 13.1 (I) and 13.1 (II) shall be followed.

2.2. The extra rate for extra cost involved shall be paid over and above item No. 13.1(1) & 13.1 (II).

2.3. The rate shall be for a unit of one sq. meter.

13.12. Grinding, polishing and round of edges or glazing sheets.

1.0. Materials

The glass shall conform to M-38.

2.0. Workmanship

The edges of glass or glazing sheets shall be grained, polished and rounded off such that it renders uniform look throughout the length and shall be neatly finished. The work shall be carried out in best workman's like manner.

3.0. Mode of measurements & payment

3.1. The edges of glass round, polished and rounded off shall be measured in meter.

3.2. The rate shall be for a unit of one running meter.

88

SECTION-14

Paving & Floor Finishing

14.2.(A) 40 mm. thick marble chips flooring rubbed and polished (i.e. Terrazzo) to granolithic-finish with under layer 30 mm. thick cement concrete (1:2:4) (1 cement :2 coarse sand : 4 graded stone aggregate 10 mm. and down gauge) and top layer, 10 mm. thick with white, black or white and black marble chips of required sizes from 1 mm. to 4 mm. nominal size laid in cement marble powder mix 3 : 1 (3 cement : 1 marble powder by weight, in proportion of 4: 7 (4 cement marble powder mix : 7 marble chips by volume): Dark shade pigment with ordinary cement (in top layer only).

1.0. Materials

Water shall conform to M-1. Cement shall conform to M-3. Sand shall conform to M-G. Stone grit shall conform to M-8.

The pigment incorporated in terrazzo shall be of permanent colour and shall conform to requirement mentioned in Appendix-A in IS: 2114-1962. Marble chips shall conform to M-46. The marble powder shall pass through I.S. Sieve Terrazzo-30.

2.0. Workmanship

2.1. Terrazzo finish shall be laid over a layer of base concrete in case of ground floor. When the terrazzo floor is laid over R.C.C. slabs a cushioning layer consisting of 75 mm. thick lime concrete shall be provided below the terrazzo floor. The terrazzo flooring shall consist of an under layer of cement concrete and layer of terrazzo which shall be paid monolithically.

2.2. Under Layer :

2.2.1. The under layer shall be of cement concrete mix 1:2:4. The maximum size of aggregate used shall not

exceed 10 mm. Specification for cement concrete shall be followed as per item No. 5.4.1.

2.3. Terrazzo Topping :

2.3.1. The topping shall have mix of ordinary cement, and marble powder in proportion 3:1 (3 cement : 1 marble powder by weight) and marble aggregate shall be mixed in proportion 4:7 (4 cement marble powder : 7 marble chips by volume). The thickness of concrete and cushioning layer shall not be less than 10 cms. and 7.5 cms. respectively. The minimum thickness of under layer and topping shall be 40 mm.

2.4. Panels :

2.4.1. The floor both while laying the under layer and topping shall be divided into panels not exceeding 2 sq. m. in area so as to reduce the risk of cracking due to differential shrinkage or expansion of terrazzo and sub-floor. The joints be so located that the layer dimensions of any panel do not exceed 2 M. The panels shall preferably be separately. However where the butt joint are provided, the bays shall be laid alternatively allowing for an interval of at least 24 hours between the laying of adjacent bays.

2.5. Mixing of materials :

2.5.1. With a view to avoid variation in colour, mixing shall be done in trough or tub, and the complete quantities of cement and pigment required for one unit shall be mixed at the beginning of the work. Colour cement or cement and pigment mix shall be dry mixed with marble powder. The mix thus obtained shall be mixed with aggregate. Cart> shall be taken not to get the materials into a heap as this would result in coarser aggregates moving on the sides and cement to the centre. To the dry mix thus prepared, water shall be added in small quantities while materials are being worked to get a mix of proper consistency. The mixture shall be plastic but not so wet as to flow. The wet mix shall be used within half an hour mix of addition of wafer during preparation laying.

2.6. Laying :

2.6.1. The base shall be divided into panels with the help of dividing strips including the strips required for decorative design up to the finished surface level of the floor. Screeds strips shall be used where the dividing strips are not used. The base shall be cleaned of all dust, dirt laitance and any loose materials. It shall be then wetted with water mopped and smeared with cement slurry at 2.75 kg./sq.mt. Under layer shall be then be spread and leveled with a screening board. The top surface shall be left rough to provide a good bond to die terrazzo.

89

2.6.2. The terrazzo topping shall be laid while the under layer is still plastic but has hardened enough to prevent cement from rising to the surface. This is normally achieved between 18 to 24 hours after laying of under layer. A cement slurry preferably of the same colour as the topping shall be brushed on the surface immediately before laying the topping. The terrazzo mix shall be laid to a uniform thickness on the screed bed and be completed thoroughly by taping or rolling and trowel led smooth. Excessive troweling or rolling in early stages shall be avoided as it results in working up cement to the surface which will produce a surface liable to cracking and will require more grinding to expose marble chips. The terrazzo surface shall be tamped, trowel led, and brought true to required level by straight edge and steel floats in such a manner that the maximum amount of marble chips come up and are spread uniform over the surface and no part of the surface is left without chips.

2.7. Curing :

2.7.1. The surface shall be left dry for air curing for a period of 12 to 18 hours. Thereafter water shall be allowed to stand overnight in pools for period of minimum of four days. The floor shall be prevented from being subjected to extreme temperature.

2.8. Grinding and finishing :

2.8.1. Grinding and finishing shall be done either by hand or by machine. In case of manual grinding, the process of grinding shall begin after two days, while in case of machine grinding, the process shall be started after seven days, after completion of laying.

2.8.2 First grinding shall be done by carborundum stones of 60-grit size. The surface shall then be washed clean and grouted with a grout of cement or /and coloring matter in the same mix and proportion as the topping in order to fill any pin holes that appear. It shall be allowed to dry for 24 hours and wet cured for four days in the same manner as mentioned in Para 2.7 above.

2.8.3. The second grinding shall be done with carborundum stone of 80 grit size. The surface shall then be prepared as after first grinding. The third grinding shall be done with carborundum stone of 120 to 150 grit size. The surface shall then be washed again and allowed to dry for 12 hours, and wet cured for four days as before. The fourth grinding shall be done with carborundum stone of 320 to 400 grit size. The surface shall again be washed clean and rubbed hard with felt and slightly moistened Oxalic acid powder @ 5 gms. per sq. meter of floor surface. After the finishing work is over, the surface shall be washed with dilute oxalic acid solution and dried for floor polishing, machine fitted with felt or Hessian bobs shall then be run over it until floor shines. In case wax-polished surface is required, wax-polished shall be applied on the surface with the help of soft linen over a clean and dry surface. The polishing machine fitted with bobs shall be run over it, clean saw dust shall be spread over the floor surface and polishing machine again operated which will remove excess wax and leave glossy surface. Floor shall not be left slippery.

3.0. Mode of measurements and payment

3.1. Terrazzo flooring shall be measured as laid in sq. meters. Length and breadth shall be measured for visible area of work done. No deduction shall be made for nor extra for any opening in floor or area up to 0.10 sq. meter. The rate shall cover laying the floor at different levels in the same room or court-yard and nothing extra shall be paid on that account.

3.2. The rate includes the cost of all materials and labour involved in all operations described above. The rate shall also not include diving strip.

3.3. The rate shall be for a unit of one sq. meter.

14.2.(B) 40 mm. thick marble chips, flooring rubbed and polished (i.e. Terrazzo) to granolithic finish with under layer 30 mm. thick cement concrete 1:2:4 (1 cement : 2 coarse sand : 4 graded stone aggregate 10 mm. and down gauge) and top layer 10 mm. thick with white, black or white and black marble chips of required sizes from 1 mm. 4 mm. nominal size laid in cement marble powder mix 3 : 1 (3 cement : 1 marble powder by weight) in proportion of 4: 7 (4 cement : marble powder mix : 7 marble chips by volume) light shade pigment with white cement (in top layer only).

1.0. Materials & Workmanship

1.1. The relevant specifications of item No. 14.2 (A) shall be followed except that light shade pigment with white cement shall be used in top layer

2.0. Mode of measurements & payment

2.1. The relevant specifications of item No. 14.2 (A) shall be followed.

2.2. The rate shall be for a unit of one sq. meter.

90

14.2.(C) 40 mm. thick marble chips, flooring rubbed and polished (i.e. Terrazzo) to granolithic finish with under layer 30 mm. thick cement concrete 1:2:4 (1 cement : 2 coarse sand : 4 graded stone aggregate 10 mm. and down gauge) and top layer 10 mm. thick with white, black or white and black marble chips of required sizes from 1 mm. to 4 mm. nominal size laid in cement marble powder mix 3:1 (3 cement : 1 marble powder by weight) in proportion of 4:7 (4 cement : marble powder mix : 7 marble chips by volume). Medium shade pigment with approx, 50% white cement and 50% ordinary cement (In top layer only).

1.0. Materials & Workmanship

1.1. The relevant specifications of item No. 14.2. (A) shall be followed except that medium shade pigment with approximately 50% white cement and 50% ordinary cement in top layer only shall be used.

2.0. Mode of measurements & payment

2.1. The relevant specifications of item No. 14.2. (A) shall be followed.

2.2. The rate shall be for a unit of one sq. meter.

14.2.(D) 40 mm. thick marble chips, flooring rubbed and polished (i.e. Terrazzo) to granolithic finish with under layer 30 mm. thick cement concrete 1:2:4 (1 cement : 2 coarse sand : 4 graded stone aggregate 10 mm. and down gauge) and top layer 10 mm. thick with white, black or white and black marble chips of required sizes from 1 mm. to 4 mm. nominal size laid in cement marble powder mix 3:1 (3 cement : 1 marble powder by weight) in proportion of 4:7 (4 cement : marble powder mix : 7 marble chips by volume). White cement without any pigment (in top layer only).

1.0. Materials & Workmanship

1.1. The relevant specifications of item No. 14.2.(A) shall be followed except that white cement without any pigment in top layer only shall be used.

2.0. Mode of measurements & payment

2.1. The relevant specifications of item No. 14.2.(A) shall be followed.

2.2. The rate shall be for a unit of one sq. meter.

14.2.(E) 40 mm. thick marble chips, flooring rubbed and polished (i.e. Terrazzo) to granolithic finish with under layer 30 mm. thick cement concrete 1:2:4 (1 cement : 2 coarse sand : 4 graded stone aggregate 10 mm. and down gauge) and top layer 10 mm. thick with white, black or white and black marble chips of required sizes from 1 mm. to 4 mm. nominal size laid in cement marble powder mix 3:1 (3 cement : 1 marble powder by weight) in proportion of 4:7 (4 cement : marble powder mix : 7 marble chips by volume), light shade pigment with ordinary cement (in top layer only).

1.0. Materials & Workmanship

1.1. The relevant specifications of item No. 14.2(A) shall be followed except that the light shade pigment with ordinary cement (in top layer only) shall be used.

2.0. Mode of measurements & payment

2.1. The relevant specifications of item No. 14.2 (A) shall be followed.

2.2. The rate shall be for a unit of one sq. meter.

14.4.(A) Marble chips skirting (Terrazzo) or dodo rubbed and polished to granolithic finish top layer 6 mm. thick with white black or white and black marble chips of sizes from smallest to 4 mm. nominal size laid in cement marble powder mix 3:1 (3 cement : 1 marble by weight) in proportion of 4:7 (4 cement : 7 marble chips by volume) 20 mm. thick with under layer 14 mm. thick in cement plaster 1:3 (1 cement : 3 coarse sand) : Dark shade pigment with ordinary cement (in top layer only).

1.0. Materials

1.1. The relevant specifications of item No. 14.2 (A) shall be followed.

2.0. Workmanship

2.1. Under layer: The under layer for terrazzo on vertical surfaces like skirting and dedos shall be of stiff cement mortar 1:3 (1 cement : 3 coarse sand) finished rough so as to give a good bond to the topping.

2.2. Terrazzo topping shall not be less than 6 mm. thick and the combined thickness of under layer and topping shall be less than 20 mm. The other details shall be followed same as per specifications of item No. C 24 except that the light shade pigment with white cement in top layers shall be used.

91

3.0. Mode of measurements & payment

3.1. The skirting and dedo shall be measured in square meters correct to two places of decimals. The height shall be measured from the finished level of floor.

3.2. The rate shall be for a unit of one sq. meter.

14.4.(B) Marble chips skirting (Terrazzo) or dedo rubbed and polished to granolithic finish top layer 6 mm. thick with white black or white and black marble chips of sizes from smallest to 4 mm. nominal size laid in cement marble powder mix 3:1 (3 cement : 1 marble by weight) in proportion of 4:7 (4 cement : 7 marble chips by volume) 20 mm. thick with under layer 14 mm. thick in cement plaster 1:3 (1 cement : 3 coarse sand) : light shade pigment with white cement (In top layer only).

1.0. Materials & Workmanship

1.1. The relevant specifications of item No. 14.4 (A) shall be followed except that the light shade pigment with white cement in top layers only shall be used.

2.0. Mode of measurements & payment

2.1. The relevant specifications of item No. 14.4(A) shall be followed.

2.2. The rate shall be for a unit of one sq. meter.

14.4.(C) Marble chips skirting (Terrazzo) or dedo rubbed and polished to granolithic finish top layer 6 mm. thick with white black or white and black marble chips of sizes from smallest to 4 mm. nominal size laid in cement marble powder mix 3:1 (3 cement : 1 marble by weight) in proportion of 4:7 (4 cement : marble powder mix 7 marble chips by volume) 20 mm. thick with under layer 14 mm. thick in cement plaster 1:3 (1 cement : 3 coarse sand) : medium shade pigment with approximate 50% white cement and 50% ordinary cement (In top layer only).

1.0. Materials and workmanship

1.1. The relevant specifications of item No. 14.4(A) shall be followed except that the medium shade pigment with approximate 50% white cement and 50% ordinary cement in top layers only shall be used.

2.0. Mode of measurement & payment

2.1. The relevant specifications of item No. 14.4 (A) shall be followed.

2.2. The rate shall be for a unit for one sq. meter.

14.4.(D) Marble chips skirting (Terrazzo) or dodo rubbed and polished to granolithic finish top layer 6 mm. thick with white black or white and black marble chips of sizes from smallest to 4 mm. nominal size laid in cement marble powder mix 3:1 (3 cement : 1 marble by weight) in proportion of 4:7 (4 cement : marble powder mix 7 marble chips by volume) 20 mm. thick with under layer 14 mm. thick in cement plaster 1:3 (1 cement : 3 coarse sand) : White cement without any pigment (In top layer only).

1.0. Materials & Workmanship

1.1. The relevant specifications of item No. 14.4 (A) shall be followed except that the white cement without any pigment in top layers shall be used.

2.0. Mode of measurements & payment

2.1. The relevant specifications of item No. 14.4 (A) shall be followed.

2.2. The rate shall be for a unit of one sq. meter.

14.4.(E) Marble chips skirting (Terrazzo) or dedo rubbed and polished to granolithic finish top layer 6 mm. thick with white black or white and black marble chips of sizes from smallest to 4 mm. nominal size laid in cement marble powder mix 3:1 (3 cement : 1 marble by weight) in proportion of 4:7 (4 cement : marble powder mix 7 marble chips by volume) 20 mm. thick with under layer 14 mm. thick in cement plaster 1:3 (1 cement : 3 coarse sand) : light shade pigment with ordinary cement (In top layer only).

1.0. Materials & workmanship

1.1. The relevant specifications of item No. 14.4 (A) shall be followed and except that the light shade pigment with ordinary cement in top layers only shall be used.

2.0. Mode of measurements & payment

2.1. The relevant specifications of item No. 14.4 (A) shall be followed and except that the light shade pigment with ordinary cement in top layers only shall be used.

2.2. The rate shall be for a unit of one sq. meter.

92

4.16 Providing and laying cushioning layer on R.C.C. slab consisting of 75 mm. thick lime concrete using brick aggregate of 20 mm. nominal size 50% mortar comprising of 1 lime : 2 fine sand.

1.0. Materials

1.1. Water shall conform to M-1. Lime mortar or proportion 1:2 shall conform to M-10. Brick aggregate 20 mm. nominal size shall conform to M-14.

2.0. Workmanship

2.1. The relevant specifications of item No. 1.8 shall be followed except that the proportion of mix shall be 50% mortar comprising of 1 lime : 2 coarse sand and the size of brick aggregate shall be 20 mm. nominal size. The lime concrete work shall be carried out in 7.5 Cms. average thickness as a cushioning layer on R.C.C. slab.

3.0. Mode of measurements and payment

3.1. The lime concrete work shall be measured for visible area of work done.

3.2. The rate shall be for a unit of one sq. meter.

14.19.(A) Precast terrazzo (Mosaic) tiles 20 mm. thick with white, black or white and black marble chips of sizes up to 6 mm. laid in floors, treads of steps and landings on a bed of 25 mm. average thickness of lime mortar 1:1.5 (1 lime putty : 1.5 fine sand) or C.M. 1:6 jointed with neat cement slurry mixed with pigment to match the shade of the tiles including rubbing and polishing complete with precast files of light shades, using white cement.

1.0. Materials

1.1. Water shall conform to M-1. Cement shall conform to M-3. Lime Mortar shall conform to M-10 cement mortar shall conform to M-1. The precast terrazzo tiles of 20 mm. thick shall be light shade using white cement and conform to M-47.

2.0. Workmanship

2.1. The work shall be carried out as per I.S. 1443-1972.

2.2. Bedding :

2.2.1. Before spreading the mortar, the sub-base of the floor shall be cleaned of all dirt, scum and loose materials and then well wetted without forming any pools of water on the surface.

2.2.2. In case; of R.C.C. floors, the top shall be left a little rough, all points of level for the finished surface shall be marked out. The lime mortar of proportion 1:1.5 (1 lime putty : 1.5 fine sand) or cement mortar of proportion C.M. 1 : 1 shall be then evenly and smoothly spread over the base. Bedding layer of mortar shall be not less than 10 mm. and average thickness of bedding shall be 25 mm.

2.3. Laying :

2.3.1 Before laying the terrazzo (Marble/Mosaic) tiles, the tiles shall be thoroughly wetted with water. Neat cement grout of required-consistency at 4.4. Kg. cement/sq. mt. shall be spread on the mortar bed. The tiles shall be laid on the neat cement float and shall be evenly and firmly bedded to the required level and slope, There shall be no hollows left. The joints shall be uniform thickness and in straight line as per the pattern.

2.3.2 The surface of flooring shall be checked frequently with a straight edge at least two meters long so as to obtain a true surface with required slope.

2.3.3. The tiles which are fixed in the floor adjoining the wall shall go about 10 mm. under plaster. Skirting or dedo shall be left unfinished for about 50 mm. above finished floor level and unfinished strip then left earlier shall be finished.

2.3.4. In places where full tiles cannot be fixed, the tiles shall be cut to the size and smoothed at edges to give straight and true joints.

2.3.5. After the tiles have been laid, the surplus cement slurry and the joints shall be cleaned and washed fairly deep before cement hardens.

2.3.6. The day after tiles have been laid, the joints shall be cleaned or gray cement grout with a wire brush to a depth of about 5 mm. and then grouted with white cement with or without pigment to match the shade of the topping of tiles. The same cement slurry shall then be spread over the whole surface in a thin coat to protect the surface from abrasive damage and to fill pin holes that may exist on the surface.

2.4. Curing :

2.4.1. The flooring shall be kept wet with damp sand or water for seven days. It shall be kept undisturbed at least for 14 days. The grinding shall normally be commenced after 14 days.

93

2.5. Polishing :

2.5.1. After the tiles are properly cured, first grinding shall be done with carborundum stone of 48.to 60 grade grit fitted in machine. Water shall be properly used during grinding. When the chips show up and the floor has been uniformly rubbed, it shall be cleaned with water, baring all pin holes. It shall then be covered with a thin coat of white cement mixed with or without pigments to match the colour of the topping of the tiles. Pin holes if any shall thus be filled. This grout shall be kept .moist for a week. Thereafter second grinding shall be done when other works are finished The machine shall be fitted with carborundum of grit 220 to 350 using water in abundance. The floor shall then be washed clean with water. Oxalic acid powder shall then be dusted at 33 grams per square meter on the surface and the surface rubbed with machine fitted with Hessian bobs or rubbed hard with pad of woolen rags. The floor shall then be washed clean and dried with a soft cloth or linen. The finished floor shall not sound hollow when tapped with mallet.

2.5.2. If any tile is disturbed or damaged it shall be refitted or replaced properly jointed and polished.

2.5.3. Testing of the tiles shall be carried out by the contractor at his own cost as per I.S. requirement for required test.

3.0. Mode of measurements & payment

3.1. The terrazzo tiles flooring shall be measured in sq. meters for visible area of work done.

3.2. No deductions shall be made nor extra paid for any opening in the floor area up to 0.1 sq. mt. Nothing extra shall be paid for use of cut tiles or for laying the floors at different levels in the same room or court yard. Mosaic tiles laid in floor boarders and bands etc.-shall be measured in the same item and nothing extra shall be payable on account of these or similar bonds formed of half or multiples of half size, standard tiles or other uncut tiles.

3.3. The treads of stairs and steps paved with tiles without nosing shall also be measured under this item.

3.4. Extra rate shall however be paid for such area where width of treads does not exceed 30 cms.

3.5. The rate shall be include the cost of all materials, labour involved in all the operations as described above.

3.6. The rate shall be for a unit of one sq. meter.

14.19.(B) Precast Terrazzo (Marble/Mosaic) tiles 20 mm. thick with white, black or white and black

marble chips of size up to 6 mm. laid in floors treads of steps and landing on a bed of 25 mm. average thickness of lime mortar 1:1.5 (1 lime putty :1.5 fine sand) or C.M. 1:6 jointed with neat cement slurry mixed with pigment to match the shade of the tiles, including rubbing and polishing complete with precast tiles of medium shades using approximately 50% white cement and 50% ordinary cement.

1.0. Materials & Workmanship

1.1. The relevant specifications of item No. 14.19(A) shall be followed except that the precast terrazzo (marble mosaic) tiles shall be of medium shades using approximately 50% white cement and 50% ordinary cement.

2.0. Mode of measurement and payment

2.1. The rate shall be for a unit of one sq. meter.

14.19.(B) Precast Terrazzo (Marble/Mosaic) tiles 20 mm. thick with white, black or white and black marble chips of size up to 6 mm. laid in floors treads of steps and landing on a bed of 25 mm. average thickness of lime mortar 1:1.5 (1 lime putty :1.5 fine sand) or C.M. 1:6 jointed with neat cement slurry mixed with neat cement slurry mixed with pigment to match the shade of tiles including rubbing and polishing complete with precast tiles of dark shade using ordinary cement.

1.0. Materials and Workmanship

1.1. The relevant specifications of item No. 14,19 (A) shall be followed except that the precast tiles shall be of Dark shade using ordinary Portland cement.

2.0. Mode of measurements & payment

2.1. The mode of measurement and payment shall be same as item No. 14.19 (A)

2.2. The rate shall be for a unit of one sq, meter,

14.21.(A) Precast terrazzo (Marble Mosaic) tiles 20 mm. thick with marble chips of sizes up to 6 mm. in skirting and risers of steps not exceeding 30 cms. in height on 10 mm. thick cement plaster 1:3 C1 cement :3 coarse sand) jointed with neat cement slurry rubbing and polishing complete with tiles of light shades using white cement.

94

1.0. Materials

Water shall conform to M-1. Cement Mortar shall conform to M-11. The precast terrazzo (Marble/Mosaic) tiles of light shades using white cement tiles 20 mm. thick shall conform to M-47.

2.0. Workmanship

2.1. Laying :

The work shall be carried out for skirting or dedo. Before fixing precast Terrazzo (Mosaic marble) tiles of shade and size as specified, the surface shall be prepared by heavy scraping, making joints etc, to the required line, level and plumb. The surface shall be thoroughly wetted before commencing the laying work. Thereafter about 10 mm. thick backing of cement mortar in specified proportion shall be applied on the surface in true line and level generally as per specifications of plaster item.

2.2. Fixing :

The back of each tile to be fixed shall be smeared with cement paste of matching colour and the mosaic tiles shall then be gently tapped against the surface, with a wooden mallet. The skirting shall be done only after the flooring is completed. Any pipes coming out of the wall through the dedo or skirting shall only be at the intersection of the horizontal and vertical joints. The tiles shall not have staggered joints. The joints shall be true to entire line both ways and vertical joints shall be in line with joints or flooring. Tiles shall be fixed as close as possible to the adjoining tiles and any difference in the thickness of the mosaic tiles shall be evened out in the cement paste so that all the tiles faces are set in conformity with one another. The skirting shall project uniformly and not more than 6 mm, thickness beyond the finished surface above. Top of skirting or dedo shall be truly horizontal. The risers of steps, skirting or dedo shall rest on top of treads of flooring. Wherever required the tiles shall be cut (sawn) and thin edges smoothed before use.

2.3. Curing :

Curing shall be done for 7 days continuously.

2.4. Finishing:

Skirting and dedo shall be hand polished to have an even smooth and shining surface. In case of skirting only 10 mm. x 10 mm. groove shall be provided at the junction of cement plaster and cement tiles.

3.0. Mode of measurements & payment

3.1. The terrazzo tiles with light shade using white cement base shall be paid under this item. The length shall be measured along finished surface of the riser, skirting or dedo, correct to a centimeter height measured from finished level of treads, or floor to the top (under side of treads in case of steps).

3.2. The rate shall include all materials and labour required for all the operations involved and described above.

3.3. The rate shall be for a unit of one sq. meter.

14.21.(B) Precast terrazzo tiles 20 mm. thick with marble chips of sizes up to 6 mm. in skirting and risers of strips not exceeding 30 cms. in height on 10 mm. thick cement plaster C.M. 1:3 (1 cement :3 coarse sand) jointing with neat cement slurry including rubbing and polishing complete with tiles of : medium shades using approximately 50% white cement and 50% ordinary cement.

1.0. Materials and workmanship

1.1. The relevant specifications of item No, 1*1 21 (A) shall be followed except that the work is for using tiles of medium shades using approximately 50% white cement and 50% ordinary cement.

2.0. Mode of measurements & payment

2.1. The mode of measurements and payment shall be followed same as item No. 14.21 (A).

2.2. The rate shall be for a unit of one sq. meter.

14.21.(C) Precast terrazzo tiles 20 mm. thick with marble chips of sizes up to 6 mm. in skirting and risers of steps not exceeding 30 cms. in height on 10 mm. thick cement plaster in C.M. 1:3 (1 cement :3 coarse sand) jointing with neat cement slurry including and polishing complete, with tiles of Dark shade using ordinary cement.

1.0. Materials & Workmanship

1.1. The relevant specifications of item No. 14.21 (A) shall be followed except that the tiles of dark shade using Portland cement shall be used.

2.0. Mode of measurements and payment

2.1. The mode of measurements and payment shall be followed as per item No. 14.21 (A).

2.2. The rate shall be for a unit of one sq. meter.

95

14.25.(A) Chequered terrazzo tiles 22 mm. thick with marble chips of size up to 6 mm. in floor on 25 mm. thick bed of lime mortar 1:1.5 (1 lime putty : 1.5 coarse sand) or C.M. 1:6 jointed with neat cement slurry mixed with pigment to match the shade of the tiles including rubbing and polishing etc. complete, light shade using white cement.

1.0. Materials

Water shall conform to M-1. White cement shall conform to M-4. Lime mortar of proportion 1:1.5 shall conform to M-10. Cement mortar shall conform to M-11. Chequered tiles shall conform to M-47 D.

2.0. Workmanship

2.1. The relevant specifications of Item No. 14.21 (A) shall be followed except that chequered tiles of light shade using white cement shall be used.

3.0. Mode of measurement & payment

3.1. The relevant specifications of item No. 14.21 (A) shall be followed.

3.2. The rate shall be for a unit of one sq. meter.

14.25.(B) Chequered terrazzo tiles 22 mm. thick with marble chips of size up to 6 mm. in floor on 25 mm. thick bed of lime mortar 1:1.5 (1 lime putty : 1.5 coarse sand) or C.M. 1:6 painted with neat cement slurry mixed with pigment to match the shade of the tiles including rubbing and polishing etc. complete, medium shade using approximate 50% the cement and 50% ordinary cement.

1.0. Materials and workmanship

1.1. The relevant specification of item No. 14.25 (A) shall be followed except that chequered tiles of medium shade approximate 50% white cement and 50% ordinary cement shall be used.

2.0. Mode of measurements & payment

2.1. The relevant specifications of item No. 14.25 (A) shall be followed.

2.2. The rate shall be for a unit of one sq. meter.

14.25.(C) Chequered terrazzo tiles 25 mm. thick with marble chips of size up to 6 mm. in floor on 25 mm. thick bed of lime mortar 1:1.5 (1 lime putty : 1.5 coarse sand) or C.M. 1:6 jointed with neat cement slurry mixed with pigment to match the shade of the tiles including rubbing and polishing etc, complete, : Dark shade using ordinary cement.

1.0. Materials and workmanship

1.1. The relevant specification of item No. 14.25 (A) shall be followed except that chequered tiles of dark shade using ordinary cement shall be used.

2.0. Mode of measurements & payment

2.1. The relevant specifications of item No. 14.25 (A) shall be followed.

2.2. The rate shall be for a unit of one sq. meter.

14.27.(A) Chequered terrazzo tiles 28 mm. thick with marble chips of size up to 6 mm. in treads of stairs and staircases in 12 mm. thick bed of lime mortar 1:5 coarse sand) to C.M. 1:6 jointed with neat cement slurry mixed with pigment to match the shade of the tiles including rubbing and polishing etc. complete, Dark shade using ordinary cement.

1.0. Materials and workmanship

1.1. The relevant specification of item No. 14.25 (A) shall be followed except that chequered tiles 28 mm. thick of light shade using white cement shall be used in trades, stair cases etc.

2.0. Mode of measurements & payment

2.1. The relevant specifications of item No. 14.25 (A) shall be followed.

2.2. The rate shall be for a unit of one sq. meter.

14.27 (B) Chequered terrazzo tiles 22 mm. thick with marble chips of size up to 6 mm. in floor in on 25 mm. thick bed of lime mortar 1:1.5 (1 lime putty : 1.5 coarse sand) or C.M. 1:6 jointed with neat cement slurry mixed with pigment to match the shade of the tiles including rubbing and polishing etc. complete : Medium shade of using approximately 50% white cement and 50% ordinary cement.

1.0. Materials and Workmanship

1.1. The relevant specifications of item No. 14.25(A) shall be followed except that the chequered tiles 28 mm. thick of medium shade using approximately 50% white cement and 50% ordinary cement shall be used in treads of stair, staircases etc.

96

2.0. Mode of measurement and payment

2.1. The relevant specifications of item No. 14.25 (A) shall be followed.

2.2. The rate shall be for a unit of one sq. meter.

14.27.(C) Chequered terrazzo tiles 28 mm. thick with marble chips of sizes up to 6 mm. in treads of stairs and staircases in 12 mm. thick bed of lime mortar 1:1.5 (1 Lime putty: 1.5 coarse sand) or c.m. 1:6 jointed with neat cement slurry mixed with pigment to match the shade of tiles including rubbing and polishing complete : Dark shade using ordinary cement.

1.0. Materials and Workmanship

1.1. The relevant specifications of item No. 14.25 (A) shall be followed except that chequered tiles 28 mm. thick of dark shade using ordinary cement shall be used in treads of stair, staircase etc.

2.0. Mode of measurements and payment

2.1. The relevant specifications of item No. 14.25 (A) shall be followed.

2.2. The rate shall be for a unit of one sq. meter,

14.29 White glazed tiles 6 mm. thick in flooring, treads of steps and landings laid on a bed of 12 mm. thick cement mortar 1:3 (1 cement : 3 coarse sand) finished with flush pointing in white cement.

1.0. Materials

Water shall conform to M-1 Cement mortar shall conform to M-11 White glazed tiles shall conform to M-55

2.0. Workmanship

2.1. Bedding :

2.1.1. The sub grade shall be cleaned, wetted and mopped. The bedding shall then be laid evenly over the surface tamped and corrected to desired level and allowed to harden enough to offer a rigid cushion to tiles and to enable the monsoon to place wooden planks across and squat on it.

2.1.2. The white glazed tiles shall be laid on cement mortar bedding of 12 mm. thick in C.M. 1:3. The mortar shall have sufficient plasticity for laying and there shall be no hard lumps that would interfere with the evenness of bedding. The base shall be cleared and well wetted. The mortar shall then be spread in thickness not less than 10 mm. at any place and average 12 mm. thickness. The proportion of the cement mortar shall be as specified in the item.

2.2. Fixing tiles :

2.2.1. The tiles before laying shall be soaked in water for at least two hours. Neat gray cement grout at 33 kg/Cement/Sq. mt. of honey like consistency shall be spread over the mortar bedding as directed. The edges of the tiles shall be smeared with neat cement slurry. The tiles shall be well pressed and gently tapped with a wooden mallet till they are properly bedded and in level with the adjoining tiles. There shall be. no hollows in bed or joints. The joints between the tiles shall be as thin as possible in straight line or as per pattern.

2.2.2. The tiles shall not have staggered joints. The joints shall be true to centre line both ways. The Nahni trap coming in the flooring shall be so positioned that its grating shall replace only one tile as far as possible. Where full size tiles cannot be fixed they shall be cut (Swan) to the required size and the edges rubbed smooth to ensure straight and true joints. The joints shall be filled with grey cement grout with wire brush or trowel to a depth of 5 mm. and loose material removed. White cement shall be used for pointing the joints. After fixing the tiles finally in an even plane the flooring shall be kept wet and allowed to nature undisturbed for 7 days.

2.3. Cleaning :

2.3.1. The surplus cement grout that may have come out of the joints shall be cleaned off before it sets. Once the floor has set, it shall be carefully washed, cleared by dilute acid and dried. Proper precautions and measures shall be taken to ensure that the tiles are not damaged in any way till the completion of the .construction.

3.0. Mode of measurements & payment

3.1. The work done shall be measured in sq. mt. for visible area of work done. The length and width of the flooring shall be measured not between the faces of skirting or dedos or plastered face of wall as the case may be. The paving under dedo or skirting shall not be measured. No deduction shall be made not extra paid for any opening in the floor of area-up to 0.1 sq.mt. Nothing extra shall be paid for laying the floors at different levels in the same rooms.

97

3.2. The rate shall be for a unit of one sq. meter.

14.32. White glazed tiles 6 mm. thick in skirting, risers of steps and dedo on 10 mm. thick cement plaster 1:3 (1 cement :3 coarse sand) and jointed with white cement slurry.

1.0. Materials

Water shall conform to M-1 Cement mortar shall conform to M-11 White glazed tiles shall conform to M-55

2.0. Workmanship

2.1. Preparation of Surface:

In case of brick masonry wall, the joints shall be raked out to a depth of least 15 mm. while the masonry is being laid. In case of concrete wall the surface shall be chiseled and roughed with wire brushes. The surface shall be cleaned and wetted thoroughly before commencing the laying work.

2.2. Laying ;

2.2.1. The wall surface shall be covered with 10 mm. thick plaster of cement mortar 1:3 mix and allowed to harden. The plaster shall be roughened with wire brushes both way. The back of tiles shall be floated with grey cement slurry set and edges with white cement slurry in bedding mortar. The tiles shall be gently tapped in position on after the other keeping the joints as thin as possible. Top of skirting or dedo shall be truly horizontal and the joints

vertical or as per required pattern.

2.2.2. Risers of steps, skirting and dedo shall rest on top of treads or flooring. Where full size tiles cannot be fixed, They shall be cut to the required size and the edges be smoothed.

2.2.3. The joints shall be cleaned and flush pointed with white cement. The surface shall be kept wet for seven days. After curing the surface shall be washed clean.

3.0. Mode of measurements and payment

3.1. The rate shall include the cost of all materials and labour required for various operations described above.

Risers of steps, skirting and dedo shall be measured in square meters, length and height shall be measured along the finished face of the skirting or dedo including curves, where special such as covers, internal and external angles, etc., used. The length and height shall be measured correct to the centimeter except in case of risers and skirting where height shall be measured correct to 3 mm

3.2. The rate shall be for a unit of one sq. meter.

14.34. Providing and fixing 50 mm. internal or external -angles of white glazed tiles.

1.0. Materials

Water shall conform to M-1. Cement mortar shall conform M-11. Glazed tiles shall conform to M-55.

2.0. Workmanship

2.1. The relevant specifications of item No. 14.32 shall be followed except that the internal or external angles of glazed tiles shall be of thickness not less than the tiles with which they are used. The fixing shall be done as per directions.

3.0. Mode of measurements and payment

3.1. Rate shall be including the cost of materials and labour involved in all the operation described above.

Internal or external angles of glazed tiles shall be measured in running meters correct tip to a centimeter. length being measured on the exposed face of the special at its centre line. No extra payment shall be made for corner places at angles junctions of cover beads and cornices for using cut length of special.

3.2. The rate shall be for a unit on one running meter.

14.36. (A) Providing and laying marble stone slab flooring over 20 mm. (Average) base of cement mortar 1:6 (1 cement : 6 coarse sand) or L. M. 1:1.5 laid and jointed with gray cement slurry including rubbing and polishing compete : Marbles slab 25 mm. thick.

1.0. Materials

Water shall conform to M-1. Lime mortar shall conform to M-10. Cement mortar shall conform to M-1). Marble stone slab 25 mm. thick shall conform to M-51.

2.0. Workmanship

2.1. Dressing of slabs :

Every stone shall be cut to required size and fine chisel dressed to give a smooth and even surface on all sides to full depth. A straight edge laid along the sides of the stone shall be fully in contact with it Chisel dressing shall also be done on top surface to remove any waviness. The sides and top surface of marble

98

slabs shall be machine rubbed or table rubbed with coarse sand before using. All angles and edges or slabs shall be true, square and free from chipping.

2.2 The thickness of stone shall be 25 mm. The allowable tolerance shall be 2 mm. allowable. The 'tolerance shall + 5 mm. in length and breadth.

2.3. Bedding:

Bedding of marble slabs shall either be lime mortar 1:1.5 (1 lime putty : 1.5 coarse sand) or cement mortar 1:6 (1 cement : 6 coarse sand) of average thickness 20 mm. thick as given in description of item. Minimum thickness at any place shall not be less than 10 mm.

2.4. Laying

The surface of sub-grade shall be cleared, wetted and mopped. Mortar of specified mix and thickness shall then be spread on an area sufficient to receive one marble slab. The slab be washed clean before laying. It tie laid on top pressed and tapped gently to bring it in level with other slabs. It shall then be lifted and a side. The top surface of the mortar shall then be corrected by adding fresh mortar at hollows, or depressions. The mortar shall then be allowed to harden it over this surface cement slurry or honey like consistency at 4.4 Kg. of cement per sq. meter. The edges of slabs already paved shall be buttered with gray cement. The slab shall then be gently placed in position and tapped with wooden mallet till it is properly bedded in level with and close to the adjoining slab. The joints shall be as fine as possible. Surplus cement on the surface of the slab shall be removed. The slab fixed in the floor adjoining the walls shall enter not less than 10 mm. under the plaster skirting or dedo. The junction between the walls and floors shall be finished neatly. The finished surface shall be true to level and slopes as directed.

2.5. Curing : The floor shall be cured for a minimum period of seven days.

2.6. Polishing and finishing:

Unevenness at the meting edges of slab shall be removed by fine chiseling. Finishing etc. shall be done as per relevant specifications of item No. 14.21 (A) or terrazzo tiles flooring except that cement slurry with/or without pigments shall not be applied on the surface before each polishing.

3.0. Mode of measurements and payment

3.1. Marbles stone flooring with various kinds of marble shall be measured in sq. meter. The length and breadth shall be measured between-the finished face of skirting or dedo or wall plaster No deduction shall fie made nor extra shall be paid for nay opening in the floor or area up to 0.05 sq. mt. Nothing extra shall be paid for laying stone at different levels in the same room. Treads and steps of stairs paved with marble stone slabs shall be also be measured under flooring.

3.2. The rate shall be for a unit of one sq. meter.

14 43.(A) Kota stone slab (Polished, Green colour) flooring over 20 mm. (average) thick base of cement mortar 1:6 (1 cement : 6 coarse sand, or lime mortar 1:1.5 laid over and jointed with gray cement slurry including rubbing and polishing complete 25 mm. thick.

1.0. Materials

1.1. Water shall conform to M-1. Lime mortar shall conform to M-10. Cement mortar shall conform to M-11 Polished kota stone shall conform to M-49,

2.0. Workmanship

2.1. Each slab shall be cut to the required size and shape and fine chisel dressed at all the edges. The sides trust dressed shall have a full contract if a straight edge is laid along. The sides shall be table rubbed with coarse sand before paving. All angles and edges of the slabs shall be true square and free from chippings and giving a plane surface. The thickness shall be 25 mm. (Average) as specified in the item but not less than 20 mm. at any place of the slab.

2.2. Bedding for the Kota stone slabs shall be of cement mortar 1:6 (1 cement : 6 coarse sand) or L.M. 1:1.5 of average thickness 20 mm given in the description of the item. Sub grade shall be cleaned, wetted and mopped Mortar of the specified mix and thickness shall then be spread on an area sufficient to receive one kota stone slab. The slab shall be washed clean before laying. It shall be laid on top, pressed, tapped gently to bring it in level with the other slabs. If shall then be lifted and laid aside. Top surface of the mortar shall then be corrected by adding fresh mortar at hollows or depressions. The mortar shall then be allowed to harden bit. Over this surface, cement slurry of honey-like consistency shall be applied. The slab shall then be gently placed in position and tapped with wooden mallet till it is properly padded in level with and close to the adjoining slab. The joint shall be as fine as possible. The slabs fixed in the floor adjoining, the
99

walls shall enter not less than 10 mm. under the plaster, skirting or dedo. The junction between the wan and floor shall be finished neatly. The finished surface shall be true to levels and slopes as directed

2.3. The floor shall be kept wet for a minimum period of 7 days so that bedding and joints set properly

2.4. Polishing shall be normally commenced after 14 days of laying the stone slab. First polishing shall be done with carborundum stones of 120 grade grit fitted in the heavy machine and then second polishing shall be done with carborundum stone of 220 to 350 grade grit fitted in heavy machine. Water shall be properly used during polishing. The stone shall then be washed clean with water When directed by the Engineer-in-charge, wax polish of approved quality shall be applied on the surface with the help of soft cloth over a clean and dry surface. Then the polishing machine fitted with bobs shall be run over it.

2.5. The holes required for Nahni traps, pipes and any other fittings shall be made, without any extra cost.

3.0. Measurement & payment

3.1. The rate shall include the cost of all materials and labour involved in all the operations described above. The kota stone flooring shall be measured in square meters correct to two places decimal, length and breadth shall be measured correct to a centimeter and between the finished face of skirting dedo plaster and no deduction shall be made nor extra paid for any opening in floor of areas up to 0 1 sq

3.2. The rate shall be for a unit of one sq. meter

14.43.(B) Kota stone slab flooring over 20 mm. (average) thick base of cement mortar 1:6 (1 cement :6 coarse sand) or L.M. 1:1.5 laid over and jointed with gray cement slurry including and polishing complete : 30 mm. thick.

1.0. Materials and workmanship

1.1. The relevant specifications of item No 14 43 (A) shall be followed except that the thickness of stone shall be 30 mm.

2.0. Mode of measurements & payment

2.1. The relevant specifications of item No 14.43 (A) shall be followed.

2.2. The rate shall be for a unit of one sq. meter.

14.44. Kota stone slab 25 mm. thick in riser of steps dedo and pillars laid on 10 mm. thick cement mortar 1:3 (1 cement : 3 coarse sand) and jointed with gray cement slurry including rubbing and polishing etc. complete.

1.0. Materials

Water shall conform to M-1. Cement mortar shall conform to M-11. Kota stone slab 25 mm thick shall conform to M-49.

2.0. Workmanship

2.1. The relevant specifications of item No. 14.43(A) shall be followed except that the kota stout-fixed for risers of steps, dedo or skirting in C.M. 1:3 and the polishing shall be done manually instead of machine polishing.

3.0. Mode of measurements and payment

3.1. The risers of steps, skirting or dedo shall be measured in sq. meter Length shall be measured along the finished faces of risers, skirting or dedo. Height shall be measured from finished level of treads of floor to top. Lining of pillars shall be measured under this item.

3.2. The rate shall be for a unit of one sq. meter.

14.46.(A) Rough chiseled dressed (Kota stone green) stone flooring over 20 mm. thick base of cement mortar 1:5 (1 cement :5 coarse sand), or L.M. 1:1.5 including pointing wit cement mortar 1:2 (1 cement : 2 stone dust) etc. complete 25 mm. thick.

1.0. Materials

Water shall conform to M-1. Lime mortar shall conform to M-10. Cement mortar shall conform to M-11 Rough chisel dressed stone shall conform to M-48.

2.0. Workmanship

2.1. The relevant specifications of item No. 14.43 (A) shall be followed except that the rough chisel dressed stone of 25 mm. thickness of approved quality are to be fixed on cement mortar bedding in CM 1:5 or L.M. 1:1.5 of 25 mm. average thickness.

2.2. Dressing of stone slab :

Every stone slab shall be cut to the required size and shape and rough chisel- dressed on top, if required, so that the dressed surface shall not be more than 6 mm, from straight edge placed on it. The sides shall

100
also be chisel-dressed to a minimum depth of 20 mm. so that the dressed edge shall at no place be more than 30 mm. from straight edge butted against it. Beyond this depth, the sides may be dressed slightly splayed so as to form an inverted V shaped joint with adjoining also. The surface shall be reasonable true and plane and all the angles and edges shall be square and free from chippings. Where the stone slabs are to be used for nosing, exposed edges shall be rough chisel-dressed to full depth and cut to the uniform thickness.

2.3. Thickness of the stone slab shall be 25 mm. with permissible tolerance of + 2 mm.

2.4. Laying :

The surface of the sub-grade concrete shall be cleaned, wetted and mopped. The bedding of specified mortar mix shall be spread under each slab to the specified thickness. The slab shall be washed clean before laying. It shall be laid on top, pressed and so that all hollows underneath filled surplus mortar works up through the joints. The top shall be tapped and brought level to the adjoining slab. The thickness of the joints shall not exceed 5 mm. Subsequent slabs shall be laid in the same manner

2.5. Curing & Finishing :

Any surplus mortar on the surface of the slab shall be cleaned off and joints-finished flush. The joints shall be raked out uniformly to a minimum depth of 12 mm. under the plaster, skirting or dado. The junctions between wall plasters and floor shall be finished neatly and without waviness. The pointing shall be done with C.M. 1:2. The pointing shall be cured for a minimum period of seven days. The finished floor shall not sound hollow when tapped with wooden mallet and the finished surface shall be true to level and slopes as directed.

3.0. Mode of measurements & payment

3.1. The relevant specifications of item No. 14.43 (A) shall be followed.

3.2. The rate shall be for a unit of one sq. meter.

14.46.(B) Rough chisel dressed (Kota stone green) stone flooring over 20 mm. thick base of cement mortar 1:5 (1 cement : 5 coarse sand) or Lime Mortar 1:1.5 including pointing with cement 1:2 (1 cement : 2 stone dust) etc., complete-40 mm. thick.

1.0. Materials and Workmanship

1.1. The relevant specifications of item No. 14.46 (A) shall be followed except that the thickness of stone slabs shall be 40 mm. thick.

2.0. Mode of measurements & payment

2.1. The relevant specifications of item No 14.46(A) shall be followed.

2.2. The rates shall be for a unit of one sq. meter.

14.71.(A) Cement concrete flooring for I.P.S, 1:2:4 (for Indian Patent Stones) (1 cement : 2 coarse sand : 4 graded stone aggregate 20 mm. nominal size) laid in one layer finished with a floating coat of neat cement 40 mm. thick.

1.0. Materials

Water shall conform to M-1. Cement shall conform to M-3. Sand shall conform to M-6. Stone aggregate 20 mm. nominal size shall conform to M-12. Cement concrete of 1:2:4 proportion measured by volume shall conform to relevant specifications of ordinary grade 1:2:4 concrete.

2.0. Workmanship

2.1. The cement concrete flooring of 40 mm thick (Average) is to be laid as per the site condition. The concrete shall be mixed in a mechanical mixer at the work. Hand mixing may however be allowed for smaller quantities of work and in case of failure of machineries or as permitted by the Engineer-in-charge. It shall be carried out on a water tight platform and care shall be taken to ensure that mixing is continued until the mass is uniform in colour and consistency. However in such cases 10% more cement than otherwise required shall have to be used without any extra cost. The mechanical mixing shall be done for period of 1.1/2 to 2 minutes. The quantity of water shall be just sufficient to produce a dense concrete of required workability for the purpose, Flooring or specified thickness shall be laid in accordance with approved pattern or as directed. Finishing operation shall depending upon the temperature

and atmospheric conditions. The surface shall be left for some time till moisture disappears from it.

Fresh quantity of cement shall be mixed with water to form a thick slurry and spread over the surface while the concrete is still green. Use of dry cement or cement and sand mixture sprinkled on this surface to stiffen the concrete or absorb excessive moisture shall not be permitted.

The cement slurry shall then be properly pressed twice by means of iron floats, once when the slurry is applied and the second time when cement setting and finished floated smooth The

surface shall be marked with string or B.R.C. fabric jali to make the surface non-slippery as and when directed. The junction of floors with wall plaster, dado or skirting shall be rounded off where so

101

required up to 25 mm. radius. Flooring in lavatories and bath rooms shall be laid after fixing of water closet and

squatting pans and floor traps which shall be plugged while laying the floors and opened after the floors are completed. Any damage done to water supply or sanitary fittings during execution of work shall be made good.

2.2. After the final set, the concrete shall be kept continuously wet. if required by ponding for a period of not less than 7 days from the date of placement.

2.3. The form work shall be provided if necessary as directed by Engineer-in-charge. Concreting shall be done as per alternate bay method with necessary centering either by mastic or cement mortar as directed

3.0. Mode of measurements & payment

3.1. The rate shall include the cost of all materials and labour involved in all the operations described above. No deduction shall be made or extra paid for any opening up to 0.1 sq. mt. In area in the floor, nothing extra shall be paid for laying the floor at different levels in the same room or the counter yard.

3.2. The rate shall be for a unit of one sq. meter.

14.71.(B) Cement concrete flooring (Indian patent stone) 1:2:4 coarse sand 4: graded stone aggregate 20 mm. nominal size) laid in one layer finished with floating coat of neat cement : 50 mm. thick.

1.0. Materials & Workmanship

1.1. The relevant specifications of item No. 14.71 (A) shall be followed except that the thickness of concrete flooring shall be 50 mm.

2.0. Mode of measurements & payment

2.1. The relevant specifications of item No. 14.71. (A) shall be followed.

2.2. The rate shall be for a unit of one sq. meter.

14.74. Cement concrete payment (25 mm. to 50 mm. thick) with 1:2:4 (1 cement : 2 coarse sand : 4 stone aggregate 20 mm. nominal size) including finishing with a floating coat of neat cement complete.

1.0. Materials and workmanship

1.1. The relevant specifications of item No. 14.71 (A) shall be followed except that the thickness of concrete flooring vary from 25 mm. to 50 mm.

2.0. Mode of measurements & payment

2.1. The relevant specifications of item No. 14.71 (A) shall be followed except that thickness shall be measured correct up to 1 mm. flooring laid in borders, margins and treads of steps, shall be measured under item of flooring in respective of width.

2.2. The rate shall be for a unit of one cubic meter.

14.81.(C) 20 mm. thick precast concrete tile with aggregate of sizes up to 6 mm. laid in floors, treads of steps and landings on 20 mm. thick bed of cement mortar 1:6 (1 cement : 6 coarse sand) or L.M. 1:1.5 jointed with neat cement slurry with pigment to match the shade of the tiles complete with precast tiles of Dark Shades ordinary cement.

1.0. Materials

Water shall conform to M-1. Cement shall conform to M-2. Sand shall conform to M-6. Lime mortar 1:1.5 shall conform to M-10. Cement shall conform to M-11. Tiles shall conform to M-47 (A) cement concrete tiles shall conform to I.S. 1237-1959 and pigments to be admixed with mortar or for grouting shall conform to I.S. 2114-1962

2.0. Workmanship

2.1. The tiles shall be laid on the sub-grade of concrete of the R.C.C. slab. Bedding shall be in the mortar 1:1.5 or cement mortar (1:6). The amount of water added shall be minimum required for sufficient plasticity and workability C.M. or lime mortar where the ingredients shall be thoroughly mixed dry hard lumps removed and water added to give a good workability.

102

2.2. The base shall be cleaned of all dust, dirt and scum and properly wetted without allowing water pools. For a bedding of cement mortar shall be then spread evenly over the base of two rows of tiles and three to five meters in length. The top shall be kept rough so that cement slurry can be absorbed. The thickness of the bedding shall be not less than 10 mm. at any place. The laying of tiles shall be commenced with neat cement slurry of honey-like consistency and shall be spread over the mortar bed over an area sufficient to receive about 20 tiles. The tiles shall then be fixed in this grout one after the other, each tile being gently tapped and properly bedded in line and level with the adjoining tiles. The joints shall be as narrow as possible and normally shall not exceed 1.5 mm. After the day's work the excess cement slurry on top shall be cleaned as also the joints with a broom struck and washed before the slurry sets hard. Next day the joints shall be filled with the cement grout of the same shade as the matrix of the tiles. Tiles which are fixed in the floor adjoining the wall shall go a minimum of 10 mm. under the wall plaster, skirting or dado. For the purpose, plaster etc. may be left unfinished by about 50 mm. above the proposed finished level of the floor. The unfinished strip shall be plastered after laying the floor tiles. Where full tile cannot be used, tile shall be cut to the size to be used.

2.3. The flooring shall be cured for 7 days.

3.0. Mode of measurements and payment

3.1. The rate shall include the cost of all materials and labour involved in all the operations described above.

3.2. The rate shall be for unit of one sq. meter.

14.86. Chequered precast cement concrete tiles 22 mm. thick with aggregate of sizes up to 6 mm. in floors, treads of steps and landings on 20 mm. thick bed of C.M. of 1:6 (1 cement : 6 sand) or lime mortar 1:1.5 (1 Lime putty : 1.5 coarse sand) jointed with cement slurry with pigment to match the shade of tiles.

1.0. Materials

1.1. The relevant specifications of item No. 14.25 (A) shall be followed.

2.0. Workmanship

2.1. The relevant specifications of item No 14.21 (A) shall be followed except that chequered precast cement concrete tiles 22 mm. thick shall be used in floors, treads of steps and landings on average 20 mm. thick bed of C.M. 1:6 or L.M. 1:1.5.

3.0. Mode of measurements and payment

3.1. The relevant specifications of item No. 14.21 (A) shall be followed.

3.2. The rate shall be for unit of one sq. meter.

14.87. Extra for polishing and polishing the precast cement concrete tiles in flooring, skirting or dedo.

1.0. Workmanship

1.1. Grinding and rubbing shall normally be commenced after 14 days of laying the tiles, except for skirting or small areas, machine shall be used for the purpose.

1.2. First grinding shall be done with carborundum stones of 48 to 60 grade grit fitted in machine. Water shall be properly used during grinding. When the chips show up and the floor has been uniformly rubbed, it shall be cleaned with water baring all pin holes It shall then be covered with a thin coat of gray or white cement mixed with or without pigments to match the colour of the topping of the tiles Pin holes if any shall thus be filled. This grout shall be kept moist for sufficient period as directed. Thereafter, second grinding shall be started with carborundum of 120 grit. Grouting and curing shall be followed again. Final grinding shall be done when other works are finished. The machine shall be fitted with carborundum of grit 220 to 350 using water in abundance. The floor shall then be washed clean with water Oxalic acid powder shall then be dusters as needed on the surface and the surface rubbed with machine fitted with Hessian bobs 01 rubbed hard with pad of woolen rags. The floor shall then be washed, cleaned and dried with a soft cloth of linen. The finished floor shall not sound hollow when tapped with a mallet.

1.3. If any tile is disturbed or damaged it shall be refitted or replaced properly jointed and polished. 1.4. For skirting, dedo or small areas where it is not possible to do machine polishing all the above operations are to be done manually.

2.0. Mode of measurements and payment

2.1. The rate shall include the cost of all materials and labour involved to all the operations as described above.

2.2. The rate shall be for a unit of one sq, meter.

103

14.90. Providing and laying brick on edge flooring laid dry, grouted with C.M. 1:6 (1 cement : 6 coarse sand) including finishing the joints flush, curing etc. complete.

1.0. Materials

Water shall conform to M-1. Cement mortar shall conform to M-11. Burnt bricks shall conform to M-15.

2.0. Workmanship

2.1. The flooring shall be laid on concrete sub grade where so provided. The slope in the floor shall be provided in the sub-grade. Where sub-grade is not provided, the earth below shall be properly sloped, watered, rammed and consolidated. Before laying the flooring it shall be moisture. Plinth masonry off-eta shall be depressed so as to allow the sub grade concrete to rest on it.

2.2. Laying :

The brick shall be laid in plain, diagonal herring bond, or other pattern as directed. The bricks shall be dry laid properly and set home by gently tapping. On completion of the portion of flooring the vertical joints shall be grouted with C.M. 1:6 and all joints shall be finished flush. The joints shall be as fine as possible and not exceeding 5 mm. These points shall be filled with cement mortar 1:6.

2.3. Curing :

The brick paving shall be cured for 7 days.

3.0. Mode of measurements and payment

3.1. The length and breadth shall be measured correct to a centimeter between skirting dedo or wall plaster. No deductions shall be made nor extra paid for any opening up to 0.1 sq.mt. in area in the floor Nothing extra shall be paid for laying the floors at different levels in the same room or courtyard.

3.2. The rate shall be for unit of one sq. meter.

104

SECTION-15

Roof Covering

15.1. Providing corrugated G.I. sheets roofing fixed with galvanized iron 1J' or 1L' hook bolts and nuts 8 mm. dia. with bitumen and G.I. limpet washers filled with white lead complete excluding the cost of purline, rafters and trusses (1) 0.8 mm. thick sheet.

1.0. Materials :

Corrugated G.I. sheets shall conform to M-23.

2.0. Workmanship

2.1. Spacing of purlines : One purline shall be provided at the ridge and one at the eaves. The spacing of other purlines for 0.8 mm. thick G.I. sheets shall not exceed 1.80 meters. The purline shall coincide with the centre line of the end lap. The ridge purlines shall be placed in such a way that the ridges can be fixed properly. The portion overhanging the wall support shall not be more than one fourth of the 'spacing of purlins.

2.2. The top surfaces of the purlines shall be painted before the sheets are fixed over them. Embedded portions

of purlins shall be finished with tow coats of coal-tar.

2.3. Laying of sheets :

2.3.1. The sheets shall be laid in purlins to a true plane with the line of corrugations truly parallel or normal to the sides of area to be covered. The sheets shall not generally be built into gables and parapets. They shall be bent up along their side edges close to the wall, and the junction shall be protected by suitable flashing or by projecting drip course.

2.3.2 The laps at end shall be provided 150 mm. minimum for roof slopes 1 in 2 (1 vertical : two horizontal) and steeper but 200 mm. shall be provided for flatter slopes than those above. The side lap shall be provided two ridges of corrugations at each side.

2.3.3. The sheets shall be cut to the dimensions or the shape of the roof either along their lengths or their width or in slant across the line of corrugations at hips and valleys. The sheets shall be cut carefully with a straight edge and chisel to give straight finish. The sheets shall be laid such that the laps are turned away from the usual direction of local heavy rain.

2.3.4. Fixing of sheets :

2.3.4.1. Sheets shall be fixed to the purlins or other roof members such as hips or valley rafter etc. with 1J' or 1L' galvanized hook bolts, and galvanized nuts 8 mm. dia. with bitumen limpet washers and G.I. washers. Limpet washers with white lead shall be used. Length of hook bolt shall be varied to suit the site requirement. Bolts shall be sufficiently long so that after fixing the project above the top of their nuts by not less than 12 mm the grip of 1J' or 1L' hook bolts on the sides of purlins shall not be less than 25 mm. There shall be minimum of three hooks bolts placed at the ridge of corrugations in each sheet in every purlin and their spacing shall not exceed 300 mm. Coach screw shall not be used for fixing the sheets to purlin, where the slopes of roof are not less than 2.1/2 degree (1 vertical and 2.1/2 horizontal). Sheets shall be jointed together at the side laps by galvanized iron bolts and nuts 25 mm. x 6 mm. size each bolt with a bitumen and G.I. limpet washer filled with white lead. Where the overlaps at the sides extend to two corrugations, these bolts shall be placed zigzag over lapping corrugations, so that the ends of the overlapping sheets are drawn tightly towards each other. The spacing of same bolts shall not exceed 600 mm. along each of the staggered rows.

2.3.5. Holes for all bolts shall be drilled and not punched in the ridges of the corrugations from the under side, while the sheets are on the ground. The holes in the sheets shall be at least 50 mm. from the edge. ' Sheets drilled wrongly shall be rejected. The holes in the washers shall be of the exact diameter of the hook bolts or the beam bolts. The nuts shall be tightened from above to give a leak-proof roof

3.0. Mode of measurements and payment

3.1. The measurements of the C.G.I sheet roof shall be taken for finished work in superficial area in general plane (not girthed on the roof). The laps between the C.G.I. Sheets both at their ends and along the side edges shall not be measured. The overlaps of C.G.I, sheets over the valley piece and their under lap under the ridge, hip and flashing piece shall be included in the measurements.

105

3.2. No deductions in measurements shall be made for openings for chimney stacks, sky light etc., of area up to 0.40 sq. mt. nor extra be paid for labour in cutting and for wastage etc. in forming such openings.

3.3. The rate of roof shall include the cost of all materials and labour involved in all operations described above. The rate also includes the cost of provision, erection and removal of the .scaffolding, benching, ladders, templates and tools required for the proper execution and erection of the work. The rate includes the cost of purlins, rafters and trusses.

3.4. The rate shall be for a unit of one sq. meter.

15.7. Providing ridges of hips 600 mm. overall in plain G.I. sheets fixed with G.I. 'J' or 'L' hooks bolts and nuts 8 mm. dia. G.I. limpet and bitumen washer etc. complete. 0.80 mm. thick sheet.

1.0. Material

The G.I. valley gutters and ridges shall conform M-23 A.

2.0. Workmanship

2.1. The relevant specification of item No. 15.1 shall be followed except that the work shall be carried out for ridges or hips. The overlaps for ridges and hips or either side over the C.G.I, sheets and end legs shall be minimum 225 width of the ridges and hips shall be as described in the item.

2.2. Ridges shall be fixed to the purlins with same 8 mm. dia. G.I. hook bolts and nuts and bitumen and G.I. limpet washers, which fix the sheets for the pureline. Hips shall be fixed to the roof members with the same 8 mm. dia G.I. hook bolts and nuts and bitumen and G.I. limpet washers which fixed the sheets. At least one of the fixing bolts shall pass through the end laps of the ridges and hips on other sides. If this is not possible, extra hook bolt shall be provided. End laps of ridges and lips shall be jointed together by galvanized iron seam bolts and G.I. Washers. There shall be at least two such bolts in each end lap.

2.3. Ridges and hips shall fit in squarely on the sheets.

3.0. Mode of measurements and payment

3.1. The measurements of ridges or hips shall be taken for finished work in length along their centre lines.

3.2. No laps shall be measured.

3.3. The payment for ridges and hips shall be made in a similar way as in case of C.G.I, sheet roofing.

3.4. The rate shall be for a unit of one running meter.

15.8. Providing valleys 900 mm. overall in plain 1.6 mm. thick G.I. Class-3 fixed with 'J' or 'L' hook bolts and nuts galvanized from 'J' or 'L' hook bolts and 8 mm. dia. G.I. limpet and bitumen washers complete.

1.0. Materials

1.1. The G.I. valleys 900 mm. overall in galvanized plain sheet of 1.6 mm. thickness shall be of class-3. The valleys shall be 900 mm. wide overall and flashing shall be 380 mm. wide overall. There shall be bent to the required shape without damage to the sheets in the process of bending.

2.0. Workmanship

2.1. The relevant specifications of item NO. 15.1. shall be followed except that the work shall be carried out for G.I. valleys 900 mm. overall with G.I. sheets 1.6 mm. thickness.

2.2. Wherever the edge of a roof sheeting or valley gutter is turned up against a wall, the edge shall be weather proofed with a flashing. Flashing shall be bent to shape and fixed. Lap over the sheet shall be not less than 150 mm. over the roofing sheets. The end between the flashing sheets shall not less than 225 mm.

2.3. The flashing shall be inserted into brick work or masonry joints to a depth of 50 mm. These joints shall be filled with cement mortar (1:3). The flashing shall be well secured to the masonry. Whenever flashing has to be laid at a slope, it shall be stepped at each course of masonry, the step being out back at angle or not less than 30 degrees to the vertical.

2.4. Valleys shall be bent to shape and shall have end lap projection on either side under C.G.I., sheet not less than 225 mm. Valleys shall be fixed to the roof member below, with same 8 mm. dia. G.I. hook, bolts and nuts and bitumen and G.I. limpet washer which fix the sheets to these members. At least one of the fixing bolts shall pass through the end laps of the valley piece. If necessary extra bolts shall be provided for this purpose.

3.0. Mode of measurements and payment

3.1. The measurements for valley shall be taken for finished work in length along their centre lines.
106

3.2. No laps shall be measured.

3.3. The rate excludes the cost of boarding underneath which shall be paid separately.

3.4. The rate of flashing includes the cost of mortar for fixing in wall and other labour and materials required for it.

3.5. The rate shall be for a unit of one running meter.

15.10.(I) Providing and fixing 150 mm. wide 450 mm. overall semicircular plain, G.I. sheets class-3 Gutter with iron brakes 40 mm. x 3 mm. size bolts nuts, washers etc. including making necessary connections with rain water pipes : 0.80 mm. thick.

1.0. Materials

1.1. These shall be of plain galvanized sheets Class-3 of 0.80 mm. thickness. The gutter shall be designed to carry the maximum discharge from the roof without flowing over and shall be constructed wherever possible with sunk channel or gutter.

2.0. Workmanship

2.1. The longitudinal edges shall be turned back to the extent of 12 mm. and beaten to form a rounded edge.

The ends of the sheets at junctions of pieces shall be hooked into each other and beaten flush to avoid leakages.

2.2. The size of gutters shall be as specified in the item.

2.3. The gutter shall be laid with a minimum fall in 120. Gutter shall be true to line and slope and shall be supported on fixed M.S. Flat iron brackets bent to shape or any other suitable bracket.

3.0. Mode of measurements and payment

3.1. The measurements of gutters shall be taken for finished work in length along their centre lines. No. laps shall be measured.

3.2. The rate gutter shall include the cost of all labour and materials specified above including all specials such as angles, junctions, drop ends or funnel shaped connecting pieces, stop ends etc. flat iron brackets and bolts and nuts required for fixing the latter to the roof members.

3.3. The rate shall be for a unit of one running meter.

15.20.(A)(I) Providing asbestos cement sheets, roofing fixed with G.I. plain and bitumen washers complete excluding cost of purlins, fakers and trusses : 7 mm. thick, corrugated sheet.

1.0. Materials :

1.1. Asbestos cement sheets shall conform to M-24.

2.0. Workmanship

2.1. The maximum spacing of purlins shall be 1.6 meters in case of 7 mm. thick A.C. sheets and 1.4 meters for 6 mm. thick A.C. sheets.

2.2. Laying & fixing of Sheets

The sheets shall be laid on the purlins and other roof members as per cods practice. The top bearing surfaces of all purlins and other roof members shall be in one plane so that the sheets when being fixed shall not be required to be forced down to rest on the purlins. The finished roof shall present uniform slope and the line of corrugation shall be straight and true. The sheets shall be laid with smooth side upwards. Corrugated sheets shall be valid starting at the eaves either from left to right or right to left depending upon the direction of wind. Before actual laying of the sheets is started, the purlins spacing and the size of sheets shall be checked to ensure that the arrangements shall provide the laps required and the specified overhang at the eaves. In case the sheets are laid from right to left, the first sheet shall be laid uncut but the remaining sheets in the bottom row shall have the top left hand corners cut or mitered. The sheets in the second and other immediate rows shall have bottom right and corner of the first sheet cut. All other sheets except the last sheets shall have both bottom right hand corner of the first sheet cut. All other last sheet shall have only top left hand corner cut. The last of the top row sheets shall have the bottom right hand corner cut with exception of the last sheet which shall be left uncut. If the sheets are laid from left to right, the first sheet shall be laid and cut and the remaining procedure shall be reversed.

2.3. The free overhang of the sheets at the eaves shall not exceed 400 mm. in case of 7 mm. thick sheets and 300 mm. in case of 6 mm. thick sheets.

2.4. The meter described above is necessary to provide snug fit. Where 4 sheets meet at a lap the length of meter shall be 150 mm. and the width of miter shall be equal the width of the side lap. The cutting may be done with ordinary wood-saw at site.

107

2.5. Laps :

The sheets shall be laid with an end lap of 150mm. minimum. In case of roof with a' pitch flatter than 1 vertical to 2.1/2 horizontal (Approx. 22) or in the case of very exposed situations appropriate larger Taps may be provided. The sheets shall be laid with side lap of half a corrugation.

2.6. Fixing Accessories : The sheets shall be secured to the purlins and other roof members by means of 8 mm. dia galvanized iron bolts (J) type hook bolts in case of angle iron purlins and 'L' type bolts in case of R.S. joints, precast concrete, or timber purlin, and nuts bearing on galvanized iron washers and bitumen washers. The grip of 'J' or 'L' bolts on the side of purlins shall not be less than 25 mm. Each galvanised iron 'J' or 'L' hook bolts shall have bitumen washer and galvanised iron washer placed over the sheets before the nuts is screwed down from above. On each purlin there shall be one hook bolt on the crown adjacent to the side lap on either side bitumen washer shall be of approved quality. The G.I. flat washer shall be 25 mm. in diameter and 1.60 mm. thick and bitumen water shall be 35 mm. in dia. and 1.5 mm. thick with hole to suit the required size of fixing accessory. Each nut shall be screwed lightly at first. After a dozen or more sheets are laid, the nuts shall be tightened to ensure a leak proof joint and also nuts tightened only to extent so as to prevent damage to the sheets. The length of the 'J' bolts or crank bolts shall be 75 mm. more than the depth of purlins for single sheet fixing and 90 mm. more where two sheets overlap or where ridges or other accessories are to be fixed. The minimum length of coach screw for timber purlins shall be 110 mm.

2.7. Holes :

The holes for fixing the sheet shall be drilled in the centre of end lap to sheets to suit the purlins i.e. on the centre line of the purline, if these are of timber and square head coach screws are used, or as close as possible to the back of purlins if 'J' or 'L' bolts are used as with steel angles or precast concrete or timber purlins. Holes for hook bolts etc. shall be 2 mm. more than diameter of the fixing bolts. No holes shall be nearer than 40 mm. to any edge of sheet or accessory.

3.0. Mode of measurement & payment

3.1. The relevant specifications of item 15.1 shall be followed, except that the over lap of the corrugated sheets over valley gutters, roof lights, caves, filler piece sand underlay of the corrugated sheets below ridges, hips north light curves, flashing pieces, roof light sheets and large board shall be included in the measurement. No deduction shall be made for holes cut for extractor or cowl type ventilators. Deductions shall be made for roof light sheets.

3.2. The rate shall be for a unit of one sq. meter.

15.20.(A)(II) Providing asbestos cement sheets roofing fixed with G.I. plain and bitumen washers complete excluding the cost of purlins, rafters and trusses: 6 mm. thick corrugated sheets.

1.0. Materials and Workmanship

The relevant specifications of item No. 15.20 (A)(I) shall be followed except that the thickness of A.C. sheets shall be 6 mm.

2.0. Mode of measurements and payment

2.1. The relevant specifications of item No. 15.20 (A)(I) shall be followed.

2.2. The rate shall be for a unit of one sq. meter.

15.25.(D) Providing and fixing ridges and hips in asbestos cement sheets roofing with G.I. 'J' or 'L' hook, bolts and nuts 8 mm. dia. G.I. plain and bitumen washers complete. North tight adjustable ridges.

1.0. Materials

1.1. The ridges and hips of Asbestos cement sheets roofing shall conform to M-24.

2.0. Workmanship

2.1. The relevant specifications of item 15.20 (A) (I) shall be followed except that the work is to be carried out for ridges and hips in A.C. sheet roofing.

2.2. The ridges shall be laid as per manufacturer's instructions with rolls of the two wings in case of adjustable ridges, fitting closely and with a separation of serrated ridges registering correctly with the sheet underneath. The staggered lapping of two wings of adjustable ridge section and the lap between the adjustment pieces on the same wing of ridges shall be as per manufacturer's instructions. The end portion of the wing of the adjustable ridges which project beyond the verges of the roof shall be cut and trimmed off neatly.

108

2.3. Hips :

In laying hip pieces, serrations to suit the corrugations in the sheets below should be cut in them so that they shall be snug fit over the sheets. The wings of ridges shall be fixed to the sheet below with seam bolts and nuts 8 mm. dia. G.I. 'J' or 'L' hook bolts and bitumen and G.I. washers which fix the sheets to the purlins. In addition, in north light adjustable ridges, the roll of the two wings shall be jointed together at their crown, with 8 mm. dia G.I. seam bolts and nuts at the rate of two numbers per pair wings. Each seam bolt shall be provided with one bitumen and a pair of G.I. washers. Where the plain wing angular or plain C.C. (1.2:4) up to a full length of the overlaps. The exposed face shall be finished perpendicular to the sheeting. Wings of hips shall be fixed to the roof members below with the same 8 mm. dia. G.I. 'J' or 'L' bolts end nuts which fix the sheets to the member. In addition, they shall be secured to the sheet below with 8 mm. dia G.I. seam bolts, nuts and washers so that taken together with hook bolts, there shall be

bolt on each wing at least at every fifth Corrugation of the sheets below in case of corrugated and at least every second corrugation of the sheet below in case of semi corrugated sheets. Each seam bolt shall be provided with one bitumen and pair of G.I. washers.

3.0. Mode of measurements & payment

3.1. Measurements of ridges, hips and other accessories shall be for finished work and the length shall be taken along the centre line. The lap shall not be measured. The under lap of ridges under expansion joint pieces shall be measured.

3.2. The rate of ridges and hips shall not include the cost of expansion joint pieces, closing of gap, between plain ridge and the sheet corrugation with concrete.

3.3. The rate shall be for a unit of one running meter.

15.26. Filling cement concrete 1:2:4 (1 cement : 2 coarse sand : 4 graded stone aggregate 12.5 mm. nominal size) in gaps of A.C. sheet corrugation and wing of ridges.

1.0. Materials

Water shall conform to M-1. Cement shall conform to M-3. Coarse sand shall conform to M-6. Stone grit shall conform to M-8.

2.0. Workmanship

2.1. The relevant specifications of item No. 5.4.1 of C.C. shall be followed except that the work shall be for filling gaps of A.C. sheet corrugation and wings of ridges.

3.0. Mode of measurements & payment

3.1. The measurements of filling gaps in ridges, hips of A.C. sheet corrugation and wings of ridges shall be for finished work. The length shall be measured along the centre line.

3.2. The rate shall be for a unit of one running meter.

15.27 (III) Providing and fixing asbestos cement roofing accessories with galvanised iron 'J' or 'L' hook bolts and nuts, G.I. plain and bitumen washer etc. complete : North light and ventilator curves.

1.0. Materials and Workmanship

1.1. The relevant specifications of item No. 15.10 (I) shall be followed except that the work is carried out for accessories for asbestos cement roofing north light and ventilator curves.

1.2. The accessories such as north light and ventilator curves shall be laid and secured with same G.I. hook bolt to secure the sheets to the roof, or with separate G.I. hook bolts to the roof members below and/ or with 8 mm. dia. G.I. bolts nuts and washers to the sheeting, generally as per manufacturer's written instructions.

2.0. Mode of measurements & payment

2.1. The relevant specifications of item No. 15.25 (D) shall be followed.

2.2. The rate shall be for a unit of one running meter.

15.29.(I) Providing and fixing asbestos cement socketed half eaves gutter with bolts, nuts, bitumen washer etc. and flat iron brackets 40' mm. x 3 mm. size including asbestos rope and plastic roofing compound in joints complete : 150 mm. nominal size.

1.0. Materials & Workmanship

1.1. The relevant specifications of item No. 15.10(f) shall be followed except that the asbestos cement socketed half round eaves gutter shall be provided. The size of gutter shall be 150 mm. nominal.

109

1.2. Gutters shall be laid with a minimum fall of 1 in 120 which should be increased where possible. Gutters shall be true to line and slope and shall be laid with requisite accessories such as drop ends, stop ends, nozzles, m angles and union slips, as directed. The size of outlet of drop ends and nozzles shall be the same as the size of rain water pipe into which they discharge water. Gutters and their accessories shall be supported by m.s. flat/ iron bracket. Where these are required to be fixed to the side of rafter they shall be fixed with 40 mm. by 3 mm. section bent to shape and fixed rigidly to the sides of the rafter with 3 Nos. of 10 mm. dia. bolts, nuts and washers. The brackets shall overlap the rafter not less than 300 mm. and connecting bolts be 115 mm. centers.

1.3. Where the brackets are to be fixed with purlins, these shall consist of 40 x 3 mm. M.S. flat iron bent to shape with one/and turned at a right angle and fixed to the purlins face with a 10 mm. dia bolt, nut and washer. The perpendicular overhang portion of 40 mm. x 3 mm. bracket shall be stiffened by another 40 x 3 mm. flat bent to right angle shape with its longer leg connected to the bracket with two numbers of 6 mm. dia. M.S. Bolts nuts and washers and its shorter legs fixed to the face of purlins with one number 10 mm. dia bolt nuts and washers. The overhang of the vertical portion of the flat iron bracket from the face of the purlin shall not exceed 225 mm.

1.4. Requisite slope in the gutter shall be given in the line of bracket. The brackets shall be placed at not more than 900 mm. centers.

1.5. The gutters shall be fixed to the brackets with 2 Nos. 8 mm. G.I. seam bolts and nuts, each bolt and nut being equipped with a pair of bitumen and G.I. washers. These connection bolts shall normally be above the water line of the gutter..

1.6. Spigot and socket end of gutters of socketed half round gutter and their accessories shall be connected together at their laps with one row of 8 mm. dia. G.I. bolts and nuts. Each of the bolts and nuts shall be provided with a pair of bitumen and a pair of G.I. washers. The gap between socket and spigot shall be packed with approved plastic roofing compound and flanked on the both sides with 6.35 mm. dia asbestos rope. The connecting G.I. Bolt shall be then tightened so that the lapped joint becomes leak-proof. The outer face of packed asbestos rope shall not be further than 6 mm. from the edges of the spigot and socketed ends. Where both ends of gutters and / or their accessories to be connected together are spigot ends, they shall be laid as butt jointed with 1.5 mm. gap in between over union clips. The union clips connected to the two butt ends of the gutter or other sections with

two rows. The gap between union clips and ends of gutter sections or accessories shall be packed with plastic roofing compound flanked with edges of 6.35 mm. dia asbestos ropes as before. The whole joint shall be made leak-proof by tightening the bolts.

2.0. Mode of measurements & payment

2.1. The asbestos socketed half round eaves gutter shall be measured for finished work and the length shall be measured along the centre line. -

2.2. The rate of gutters shall include the cost of providing and fixing accessories such as drops ends, stop ends, nozzles, and fixing union clips together with bolts, nuts and washers.

2.3. The rate shall be for a unit of one running meter.

15.29.(II) Providing and fixing Asbestos cement socketed half round eaves gutters with bolts, nuts, bitumen washers etc. and flat iron brackets 40 mm x 3 mm. size including Asbestos rope and plastic roofing compound in joint etc. complete. 300 mm. nominal size.

1.0. Materials & Workmanship

1.1. The relevant specifications of item No. 15.29 (I) shall be followed except that the size of the Asbestos socketed eaves half round gutter shall be 300 mm. nominal size.

2.0. Mode of measurements & payment

2.1. The relevant specifications of item No. 15.29(1) shall be followed.

2.2. The rate shall be for a unit of one running meter.

15.51. Tiled roofing with Mangalore pattern roof tiles including teak reefers of size 50 mm. x 25 mm.

1.0. Materials

(1) Mangalore pattern roof tiles shall conform to M-25, (2) Teak wood batten shall conform to M-29.

2.0. Workmanship

2.1. Laying

The maximum distance between centre to centre of rafters shall be not more than 500 mm. Teak wood reefers 50 mm. x 25 mm. be nailed to each rafter at central distances suited to the size of the tiles by 110

means of nails 50 mm. long. The reefers shall be of well seasoned teak wood and shall be straight pieces of uniform size and colour and not shorter than the length necessary to cover at least four rafter. The under face and sides of the reefers shall be planned before fitting up. Joints shall come over the rafter. The joints of two adjacent rows of reefers shall not come over the same rafter. At the eaves, there shall be two reefers of such thickness and shape that the uniformity of the top slope of the roof shall be preserved.

2.2. The work of valleys shall be executed as under :

Galvanized iron sheet 1200 mm. wide and 1.25 mm. thick shall be used for valleys. The sheet shall be extended by about 450 mm. under the tiles on either side in a depth of 100 mm. at centre. The sheet shall be carried 75 mm. into the wall and set with cement mortar unless flushing is specified. The laps, if any, on the slope shall be 300 mm. The sheets shall be laid over the reefers and nailed. Two reefers 50 mm x 25 mm. each shall be fixed over the galvanized iron sheet 150 mm. away from the centre line of the valley, on either side to keep the tiles and mortar from falling into the gutter of the valley.

2.3. Laying :

The tiles shall be laid from the eaves towards the fidges after fitting of the reefers, the rebate of the tiles resting fully against the reefers. The joints of the hips and ridges tiles and also those between them and the plain tiles shall be set in and well grouted with lime mortar and the mortar surface painted and finished off with a mixture of red paint and port land cement or preserve informality of colour. The finished slope of roof shall be uniform from ridges to eaves. The eaves line shall be perfectly straight, horizontal and parallel to each other. The end over gables shall be protected by lime borders and neatly finished.

2.4. At the side of valleys and for 230 mm. on either side of the roof at valleys cement plastering 12 mm. thick shall be done to prevent the rain water from the gutter leaking by the sides of valleys.

2.5. At the eaves, wide tie shall be placed over the ends of the last tiles and secured by means of galvanized iron washers and screws 25 mm. into the rafter to prevent tiles from being blow up. Care shall be taken to put the screws in the, ridges and not in the gutter or the tiles, Where full tiles are not necessary, half tiles manufactured for the purpose shall be used.

3.0. Mode of measurements and payment

3.1. The measurement of the roof shall be taken for finished work for superficial area flat in the plane, of the roof and not girthed. Laps shall not be measured.

3.2. No deduction in measurements of roofed shall be made for openings of area up to 0.40 sq. mt. nor shall any extra be paid for labour and wastage in forming such openings.

3.3. The rate includes the cost of all materials and labour including ridges, hips, eaves and bottoms.

3.4. The rate shall be for a unit of one square meter.

15.75 Providing and fixing five courses water proofing treatment with bitumen felt consisting/ of second and fourth course of blown bitumen or/and residual bitumen applied hot 1.20 kg./sq. mt. of area for each course and first course with fiber base bitumen saturated underlay type and third course with fiber base self finished felt type 2 Grade-I, fifth and final course of stone grit 6 mm. and down size or pea sized gravel spreaded at 0.008 cum/sq.mt. including preparation of surface, excluding grading complete.

1.0. Materials

The tar felt shall conform to M-76. The bitumen primer shall conform to I.S. 3388-1965. The bitumen shall

conform to I.S. 702-1961. The grit or gravel shall conform to M-8.

2.0. Workmanship

2.1. Preparation of surface :

2.1.1. Well defined cracks other than hair cracks in the roof structure shall be cut to V section cleaned and filled up flush with cement sand slurry or with bitumen conforming to I.S. 702-1961. The surface to be treated shall have minimum slope of 1 in 120. The grading shall be carried out prior to the application of water proofing treatment by cement mortar or line surkhi mortar or as specified in description of item.

2.1.2. The surface or room, part of parapet and gutters, drain mouths etc. over which the water proofing treatment is to be applied shall be cleaned or all foreign matter such as funguses, moss and dust by wire brushing and dusting.

2.1.3. Drain outlet shall suitably placed with respect to the roof gradient to ensure rapid drainage and prevent local accumulation of water on the roof, surface, masonry drain mouth shall be widen sufficiently and rounded with cement mortar.

2.1.4. For cast iron drain outlets, a groove shall be cut all round to touch the treatment.

111

2.1.5. When a pipe passes through a roof on which water proofing treatment is to be laid a cement concrete angle fillet shall be built round it and the water proofing treatment taken over the fillet.

2.1.6. In case of parapet wall over 450 mm. in height for trucking in the water proofing treatment a horizontal groove 75 mm. wide and 65 mm. deep at minimum height of 150 mm. above roof level shall be left in the vertical face at the time of construction. The horizontal face of the groove shall be shaped with cement mortar 1:4.

2.1.7. In case of low parapet where the height does not exceed 450 mm. no groove shall be provided and the water proofing treatment shall be carried right over the top.

2.1.8. In case of existing R.C.C. and stone and vertical face of the parapet wall, a fillet 75 mm. in radius shall be constructed.

2.1.10. At the drain mouths the fillet shall be suitably cut back and rounded off for easy application of water proofing treatment and easy flow of water.

2.1.11. Outlet at every low dividing wall about less than 300 mm. in height cut open to full depth and the bottom and the sides shall be rounded smooth and corners rounded off for easy application of water proofing treatment.

2.2. Priming coat:

2.2.1. Bitumen primer shall conform to I.S. 3335-1965. A priming coat consisting of bituminous solution of low viscosity shall be applied with brush on the roof and wall surface at specified weight per unit area to assist adhesion to bonding materials as specified in the description of the item.,.

2.2.2. Where a floating treatment to water proofing with self finished bitumen felt is required i.e. where water proofing treatment is required to be isolated from the roof structure, a layer of bitumen saturated felt (under lay) shall be spread over the roof surface and tucked into the flashing grooves. To keep the underlay free from the structure nonbonding materials shall be used below underlay. Overlapping to the adjoining strip of underlay shall be minimum of 75 mm. as sides and 10 mm. at ends, and shall be sealed with the same bonding materials, as used for self finished felt treatment. The underlay shall be of type I saturated felt conforming to I.S. 1322-1970.

2.3. Laying of Felt :

2.3.1. The self finished tar felt shall be cut to the required lengths, brushed clean to dusting materials, laid out flat on the roof to eliminate curls and subsequent sketching. The felt shall be laid in lengths running at right angles to the direction of run off gradient commencing at the lowest level and working up to crest, so that the lower laps of the adjacent felt layer offer minimum obstruction to the flow of water. The felt shall not be laid in a single piece of very long lengths as it is likely to shrink. 6 to 8 meters are suitable length. The roof shall be cleaned and dried before the felt treatment is begun. Each length shall be laid in position and rolled up for a distance of half its lengths. The hot bonding materials heated to correct working temperature as specified by manufacturer shall be poured on the roof across the full width of the felt as the latter is steadily unfolded and pressed down. The excess of bonding materials which squeezes out at the ends shall be removed as the laying proceeds. The pouring shall be so regulated that the correct weight of the bonding materials as per unit area is spread uniformly over the surface. When the first half of the tar felt has been bonded to the roof, the other half shall be rolled up and then unrolled on the hot bonding materials in the same way. Subsequent strips shall also be laid in the same manner. Each strip shall overlap the preceding one by at least 75 mm. at the longitudinal edges and 100 mm. at the ends. All overlaps shall be firmly bonded with hot bitumen. Streaks and trailing of bitumen near edges or laps shall be leveled by heating the overlaps with blow lamp and leveling down unevenness.

2.3.2. Third layer of bonding materials in four course treatment shall be carried out in similar out in manner after the flashing has been complete.

2.3.3. Water proofing treatment shall be carried out in the drain pipe or out-lets by at least 100 mm. The Water proofing treatment laid on the surface shall over-lap the upper edge of water proofing treatment in the drain outlets by latest 100 mm. Flashing felts shall be laid as flashing. Wherever junction of vertical horizontal surfaces occurs longitudinal laps shall be 100 mm. The lower layer of flashing felt shall overlap the roofing felt by 100 mm on vertical and sloping faces. Last course of flashing should not be of stone grit or pea sized gravel but it shall be replaced by providing two coats of bitumen solution of approved quality.

112

2.3.4. The lower edge of flashing shall overlap the flat portion for the roof and the upper edge of the flashing shall be trucked into the horizontal groove 75 mm. thick wide, 65 mm. deep provided at minimum height of 150 mm. from top of the roof surface. The flashing treatment shall be firmly held in place in the grooves with wooden wedges at intervals and the grooves shall be filled with cement mortar 1:4 (1 cement : 4 coarse sand) or cement concrete

(1:2:4) (1 cement : 2 coarse sand : 4 graded stone aggregate 6 mm. nominal size) and surface finished smooth with the rest of wall. The cement work shall be cured of bituminous solution shall be applied on the vertical and sloping surface of flashing.

2.3.5. After the top flashing felt layer has been laid, the penultimate layer of bonding material shall be applied over the roofing felt and horizontal overlap, and vertical and sloping surfaces of flashing shall be spread uniformly over the hot bonding materials on the horizontal roof surface and pressed into it with wooden roller.

2.3.6. The material for surface finish shall be spread as described in the item over top layer.

2.3.7. If ballooning occurs the defects may be rectified as under.

2.3.8. Remove the gravel on the ballooned surface. The cut open and squeeze out the trap vapor by firm pressure applied by hand, seal the bitumen felt so lifted back on the surface by applying additional bitumen, finally seal the cut with piece of bitumen felt with bitumen application.

3.0. Mode of measurements & payment

3.1. The measurements for this item shall be taken as under:

(a) Water proofing of roof with bitumen shall be measured in sq. mt. length and breadth shall be measured correct to centimeter.

(b) Measurement shall be taken for the superficial area of roofing and flashing treatment including flashing over the parapet wall, low dividing walls and expansion joints and at the pipe projection etc. Overlapping and tucking into flashing grooves shall not be measured.

(c) Slopping and vertical surface of water proofing treatment shall be measured under the four or five course treatment as the case may be irrespective of the fact that the final course of grit or gravel is replaced by bitumen primer.

(d) In measurements, no deductions shall be made for either openings or recesses for chimney stacks, roof lights etc. for areas up to 0.40 sq. mt. not anything extra shall be paid for extra labour and materials in forming such openings. For similar area exceeding 0.04 sq. mt. deduction shall be made in measurements for full opening but nothing extra shall be paid for extra labour and materials in forming such openings.

(e) The grading (coba bedding) shall be paid separately but cleaning of surface and treatment shall not be measured or paid separately.

3.2. The rate includes cost of all materials and labour.

3.3. The rate shall be for a unit of one sq. meter.

15.87(A) Providing and fixing on wall face C.I rain water pipe including filling the joints with spun yarn soaked in neat cement slurry and cement mortar 1:2 (1 cement : 2 fine sand) 75 mm. dia.

1.0. Materials

Water shall conform to M-1. The C.I. rain water pipes and fittings shall conform to M-68. Cement mortar shall conform to M-11.

2.0. Workmanship

2.1. C.I. rain water pipes shall be of the specified diameter and shall be in full lengths of 1.8 meters including socket ends of the pipes unless shorter lengths are required at junction with fittings.

2.2. Fixing :

The pipe and fittings shall be fixed in vertical alignment unless otherwise specified and shall be secured to the walls at joints with M.S. clamps. The clamps shall be M.S. sheet 30 mm. bent to required shape and size so as to fit tightly on the socket of pipe when tightened with screw bolts. It shall be formed out of two semi-circular pieces, hinged with 6 mm. dia M.S. pin on one side and provided flanged ends on the other side with holes to fit in the screw bolt and nut 40 mm. long. The clamps shall be provided with hook made out of 275 mm. long, 10 mm. dia M.S. bar invested to the ring at the centre of one semicircular piece. The clamps shall be fixed to the walls. The clamps shall be kept above 25 mm. clear of finished face of wall so as to facilitate cleaning and painting the pipes.

113

2.3. The pipe shall be fixed vertically. The spigot of the upper pipe shall be properly fitted in the socket of the lower pipe such that there is uniform annular space filling with the jointing material. The annular space between the spigot and socket shall be filled with, a few turns of spun yarn soaked in cement slurry or with stiff cement mortar 2:1 (1 cement : 2 fine sand) well pressed with caulking tools and finished smooth at top at an angle of 45°, shopping up. The joint shall be kept wet at least for 7 days by tying four fold of gunny bag to pipe and keeping it moist constantly.

3.0. Mode of measurements & payment

3.1. The relevant specifications of item No. 15.93(B) of A.C. rain water pipes shall be followed except that the C.I. rain water pipe shall be fixed.

3.2. The rate shall be for a unit of one running meter.

15.88. (A) Providing and fixing M.S. Holder bat clamps of approved design to C.I. or S.C.I. pipes embedded and including cement concrete blocks (108 mm. x 100 mm. size) in 1:2:4 (1 cement : 2 coarse sand : 4 graded stone aggregate 20 mm. nominal size) and cost of cutting holes and making good the wall etc. complete : 75 mm. dia.

1.0. Materials of Workmanship

1.1. The relevant specifications of item no. 15.94(6) shall be followed except that the M.S. holder bat clamps of approved design shall be C.I. rain water pipe-75 dia.

1.2. The bat clamps shall be fixed as directed with C.C. blocks of 100 mm. x 100 mm. The relevant specification of item No. 5.4.1 shall be followed for concrete work.

2.0. Mode of measurements and payment

- 2.1. The bat clamps of M.S. bolder suitable for 75 mm. dia shall be measured for finished item.
- 2.2. The rate includes cost of all materials and labour etc. required for satisfactory completion of this item.
- 2.3. The rate shall be for a unit of one number.

15.90(A) Providing arid fixing and embedding sand C.I. rain water pipe in the mason surrounded with 12 mm. thick cement mortar of the same mix as that of masonry : 75 mm. dia. pipe.

1.0. Materials

Water shall conform to M-1. Cement mortar shall conform to M-11. The C.I. pipe and fittings shall conform to M-68.

2.0. Workmanship

- 2.1. The relevant specifications of item No. 15.87 (A) shall be followed except that C.I. pipe 75 mm. dia shall be embedded in masonry surrounded with 12 mm. thick cement mortar.
- 2.2. The pipes shall be fixed in the masonry work as it proceeds. The pipe shall be kept vertical or to the line as directed. The pipe shall have minimum surroundings of 12 mm. thick cement mortar at every portion of external surface. The length shall be caulked with spun yarn and cement mortar as soon as the next length of pipe is placed in position. The socket end of the pipe of shall be kept closed till the next length of pipe is fitted and jointed to prevent any brick-bats or concrete or pieces of wood falling in and cocking the pipes.

3.0. Mode of measurements and payment

- 3.1. The relevant specifications of item No. 15.87 (A) shall be followed.
- 3.2. The rate shall be for a unit of one running meter.

15.93(6) Providing and fixing on wall face asbestos cement rain water pipe including jointing with spun yarn soaked in bitumen and cement mortar 1:2 (1 cement : 2 coarse sand) complete : 80 mm. dia.

1.0. Materials

1.1. Asbestos cement pipes of 80 mm. dia shall conform to I.S. 1626-1960 for pipes fixed on wall face. AC. pipe shall conform to M-74.

2.0. Workmanship

2.1. Asbestos cement rain water pipes and fittings shall be of the diameter, size and type specified in the item. The pipe shall be full lengths of 2 meter as far as possible. All the pipes shall be fixed on wall face at locations indicated on drawings or as ordered by the Engineer-in-charge. Pipe shall be secured to face of wall below all joints by M.S. clamps with wooden gut ties.

2.2. The spigot of the upper pipe shall be properly fitted into the socket of the lower pipe such that there is uniform annular space for fitting with the jointing materials. One third depth of annular space between the

114
item. The pipe shall be full lengths of 2 meter as far as possible. All the pipes shall be fixed on wall face at locations indicated on drawings or as ordered by the Engineer-in-charge. Pipe shall be secured to face of wall below all joints by M.S. clamps with wooden gut ties.

2.2. The spigot of the upper pipe shall be properly fitted into the socket of the lower pipe such that there is uniform annular space for fitting with the jointing materials. One third depth of annular space between the socket and the spigot shall be filled with spun-yarn soaked in bitumatic jointing compound and shall be pressed home by means of caulking tool. The remaining 2/3 depth of the joints shall be filled in with stiff cement mortar 1:2 and shall be pressed with caulking tool and finished smooth at top at an angle of 45 sloping up.

3.0. Mode of measurements and payment

- 3.1. The pipe shall be measured including all fittings along its length in running meter. No allowance shall be made for the portion of pipe length entering the sockets of the adjacent pipe or fittings.
- 3.2. The rate includes the cost of all materials and labour involved in all the operations including jointing.
- 3.3. The rate shall be for a unit of one running meter.

15.93.(C) Providing and fixing on wall face asbestos cement rain water pipe including jointing with spun yarn soaked in bitumen and cement mortar 1:2 (1 cement : 2 coarse sand) complete : 100 mm. dia.

1.0. Materials and Workmanship

1.1. The relevant specifications of item No. 15.93 (B) shall be followed except that the diameter of pipes shall be 100 mm.

2.0. Mode of measurements & payment

- 2.1. The pipe shall be measured including all fittings along its length in running meter. No allowance shall be made for the portion of pipe length entered into the sockets of the adjacent pipe or fittings.
- 2.2. The rate includes the cost of all materials and labour involved in all the operations including jointing.
- 2.3. The rate shall be for a unit of one running meter.

15.94.(B) Providing and fixing for A.C. pipe on wall plugs and standard holder bat clamps comprising of two semi circular halves of flat iron and cast iron base screwed on wooden plugs : 80 mm. dia.

1.0. Materials and workmanship

1.1. The bat clamps shall consist of a iron base with a projecting 1 shaped lay, teeth web of which the semicircular halves of the flat iron clamps are bolted. The base on the holder bat clamp shall be screwed on a pair of wooden plugs fixed in the wall with screw slotted driven through the holes in the base. The ' screws shall be not less than 75 mm. long-for 80 mm. diameter pipes and 100 mm. diameter pipes. The plugs shall be fixed in the wall to a depth of 150 mm. in cement mortar, 1:2 centrally to the holes in the base of the bat clamps and with their front face projecting to such a length' from the brick face that when the bat clamps is fixed, the outer base of its base

shall be flush with the plaster face of the wall. The plugs shall be 110 mm. x 50 mm. wide at face increasing to 160 mm. x 70 mm. width at rear and shall be 70 mm. deep through out.

2.0. Mode of measurement & payment

2.1. The work shall be measured on number basis of clamps prescribed with accessories including cost of all materials and labour involved in all the operation including jointing etc. complete fixing in position etc. complete.

2.2. The rate shall be for a unit of one number.

15.94 (C) Providing and fixing for A.C. pipe on wall plugs and standard holder bat clamps comprising of two semi circular halves of flat iron and cast iron base screwed on wooden plugs : 100 mm. dia.

1.0. Materials and workmanship

1.1. The relevant specifications of item No. 15.94 (B) shall be followed except that the standard holder bat clamps shall be for A.C. pipe of 100 mm. dia.

2.0. Mode of measurements and payment

2.1. The work shall be measured on number basis of clamps including cost of all materials and labour involved in all the operation including jointing, fixing in position etc. complete.

2.2. The rate shall be for a unit of One Number.

15.95.(A) Providing and fixing on wall face asbestos cement fittings for rain water pipe including jointing with spun yarn socked in bitumen and cement mortar 1:2 {1 cement : 2 coarse sand}. Bend of required degree. 80 mm. dia without door. 100 mm. dia. without door.

115

1.0. Materials

1.1. The bend of required degree and size as specified in item shall be of best quality and made as approved by the Engineer-in-charge. The fittings shall conform to I.S, 1626-1960.

2.0. Workmanship

2.1. The fitting (bend of required degree) shall be fixed as per relevant specifications of item No. 15.93 (B), except that the A.C. bends of required degree shall be provided instead of pipe.

3.0. Mode of measurements and payment.

3.1. The rate shall be for a unit of One Number.

15.95.(B) Providing and fixing on wall face asbestos cement fittings for rain water pipe including jointing with spun yarn soaked in bitumen and cement mortar 1:2 (1 cement: 2 coarse sand) off set 50 mm. (2) 80 mm. dia. (3) 100 mm. dia.

1.0. Materials & Workmanship

1.1. The relevant specification of item No. 15.95 (A) shall be followed except the off set 50 mm. of specified size of A.C. pipe shall be used instead of bends.

2.0. Mode of measurements & payment

2.1. The rate shall be for a unit of One Number

15.95.(C) Providing and fixing on wall face asbestos cement fittings for rain water pipe including jointing with spun yarn soaked in bitumen and cement mortar 1:2 (1 cement : 2 coarse sand) off set 75 mm. (2) 80 mm. dia (3) 100 mm. dia.

1.0. Materials & Workmanship

1.1. The relevant specifications of item No. 15.95 (A) shall be followed except that off-set 75 mm. of specified size of A.C. Pipe shall be provided instead of bends.

2.0. Mode of measurements & payment

2.1. The rate shall be for a unit of One Number.

15.95.(J) Providing and fixing on wall face Asbestos cement fittings for rain water pipe including jointing with spun yarn soaked in bitumen and cement mortar 1:2 (1 cement : 2 coarse sand) junction equal angle. (3) 80 mm. dia without door (5) 100 mm. dia. without-door.

1.0. Materials and workmanship

The relevant specifications of item 15.95 (A) shall be followed that junction of equal of angle of specified size of A.C. pipe shall be provided instead of bends.

2.0. Mode of measurements & payment

2.1. The rate shall be for a unit of One Number.

15.95.(K) Providing and fixing on wall face Asbestos cement fittings for rain water pipe including jointing with spun yarn soaked in bitumen and cement mortar 1:2 (1 cement : 2 coarse sand) : junction of equal double angle. (3) 80 mm. dia. without door (5) 100 mm. dia. without door.

1.0. Materials and workmanship

1.1. The relevant specification of item 15.95 (A) shall be followed except that junction of equal double angles of A.C. rain water pipe of specified size shall be provided instead of A.C, Bend.

2.0. Mode of measurement & payment

2.1. The rate shall be for a unit of One Number.

15.95.(L) Providing and fixing on wall face Asbestos cement fittings for rain water pipe including jointing with spun yarn soaked in bitumen and cement mortar 1:2 (1 cement : 2 coarse sand) : Standard shoe. (2) 80 mm. dia. (3) 100 mm. dia.

1.0. Materials and workmanship

1.1. The relevant specification of item No. 15.95 (A) shall be followed except that the standard shoe of A.C. pipe of specified size shall be provided instead of bend.

2.0. Mode of measurement & payment

2.1. The rate shall be for a unit of One number.

116

SECTION-16

Ceiling Lining

16.3.(A) Providing and fixing wooden planks ceiling with long Lied and grooved jointing and Wood screws (Frame work and cover fillets to be measured and paid separately) : Indian Teak

Wood (i) 12 mm. thick (ii) 20 mm. thick (iii) 25 mm. thick.

1.0. Materials

1.1. The Indian Teak wood shall conform to M-29.

2.0. Workmanship

2.1. General

The planks shall be clean sawn in the direction of the grain, cut square and straight. Each plank shall have tongued and grooved jointing. On exposed faces, it shall be planed for full face.

2.2. The frame for supporting the ceiling may be wooden or metal and the size and the other details of frame work shall be as directed, Suspenders of M.S. angles or other sections may be used for suspending the frame. Use of wooden suspenders shall be permitted. The bottom surface of the frame shall be checked and corrected to true surface and slope.

2.3. Fixing :

Planks of a specified timber and thickness shall be used. The width of the planks shall not be more than 100 mm. up to 20 mm. thick planks and 150 mm. for planks above 20 mm. thick and length shall not exceed 3 meters. The planks shall be of uniform width except in the first and last lines of planks adjacent to the two walls where remaining additional odd width shall be adjusted equally on both sides. The minimum, length of planks in finished work shall be such that it will span at least two spacing of the supporting frame work except where shorten lengths are unavoidable. The planks shall be planed true on the exposed sides.

2.4. The longitudinal edges of the planks shall be jointed with tongued and grooved type joints as described in the item.

2.5. The outer lines of planks shall be accurately fixed parallel and close to be wall. Each subsequent plank shall be carefully jointed up. The plank shall be fixed to the frame above with two screws at each and joints of frame and one at every intermediate joint. (The screws shall not be thinner than designations 8 and of a length not less than twice the thickness of the boards). The screws shall be counter sunk and the screw holes filled with putty or sloping out way. The unexposed face of planks shall be treated with wood preservative before the board is fixed.

3.0. Mode of measurement & payment

3.1. The supporting frame, cover fillets, and suspenders shall not be included in rate of ceiling.

3.2. No deductions in measurements shall be made for opening not exceeding 0.46 sq. m. and no extra payment shall be made for forming such openings.

3.3. Each type of work in ceiling shall be measured separately.

3.4. The rate shall be for a unit of One sq. meter.

16.4. Providing and fixing Fiber insulation board lining with butt jointing and nails (Frame work and cover fillets to be measured and paid separately) (i) 12 mm. thick (ii) 18 mm. thick (iii)

25 mm. thick.

1.0. Materials

1.1. The fiber insulation board of specified thickness shall conform to I.S. 3348-1965.

2.1. Fixing :

The work shall be carried out as per detailed drawings for panel arrangements.

2.2. All boards are subject to slight movements due to moisture and temperature changes, and this shall be allowed for in fixing. Preferably the board shall be stored up for at least 24 hours before use in the same environment as the one in which they are to be fixed.

117

2.3. Frame work :

The studs and grounds for fixing the boards shall be spaced at 300 mm. to 450 mm. centers both ways the actual spacing selected depending on the width of the cut board in the panel arrangements. All edges of the boards shall be supported. Intermediate supports shall be provided at dado heights for picture rails and cornices etc.

2.4. Planked battens 40 mm. x 20 mm. shall be used for grounds on solid walls. The batten shall be plugged to wall as described-under. The batten shall be fixed on tapering plugs with 50 mm. long wood screws. The tapering plug shall be trapezoidal in shape having base 50 x 50 mm. at bottom 38 x 38 mm. at top with depth of 50 mm. Plugs shall be embedded in C.M. 1 : 3 and shall be placed at 450 x 500 mm. centers. The plugs shall be treated with coal tar and battens shall be treated with wood preservative before use. On uneven wall faces the battens shall be plugged and fitted with packing pieces at the back where necessary. The frame shall be treated with wood preservative before boards are nailed on.

Nailing shall be done by nails having a shank diameter of 2.5 mm. and head diameter of about 8 mm. Nails shall have length as per requirements. The nails shall be placed at supports at 100 mm. to 150 mm centre to centre and at edges 75 mm. centers. Minimum clearance for nails from edges shall be 10 mm. The nails shall be rustles where the nail heads are exposed. Where the joints are to be covered with beading, felt headed (clout) nails shall be used instead of lost head nails.

3.0. Mode of measurements and payment

3.1. The relevant specifications of item No. 16.3.(A) shall be followed.

3.2. The rate shall be for a unit of One sq. meter.

16.13(1) Providing and fixing plywood lining with butt jointing and nails (frame work and cover fillets to be measured and paid for separately) 6 mm. thick play.

1.0. Materials :

6 mm. thick plywood shall conform to M-37.

2.0. Workmanship

The relevant specifications of item 16.4 shall be followed except that 6 mm. thick plywood shall be fixed in lining.

3.0. Mode of measurements and payment

3.1. The relevant specifications of item 16.4 shall be followed.

3.2. The rate shall be for a unit of One sq. meter,

16.13(11) Providing and fixing plywood lining with but jointing and nails (frame work and cover fillets to be measured and paid for separately) 9 mm. thick ply.

1.0. Materials & Workmanship

1.1. The relevant specifications of item No. 16 13 (I) shall be followed except that the thickness of plywood to be fixed shall be 9 mm.

2.0. Mode of measurements & payment

2.1. The relevant specifications of item No. 16.4 (I) shall be followed.

2.2. The rate shall be for a unit of One sq. meter.

16.21(1) Providing and fixing plain asbestos sheet lining with butt jointing and wood screws (frame work and cover fillets to be paid for separately), Class-A-6.5 mm. thick.

1.0. Materials

1.1. Plain A.C. Sheets 6.5. mm. thick shall be conform to M-24.

2.0. Workmanship

2.1. The relevant specifications of item No. 16.4. shall be. followed except that the plain A.C. sheets class A of 6.5 mm. thickness shall be fixed in lining.

2.2. In fixing asbestos cement sheets, care shall be taken to avoid rigid fixing as this may cause cracking if the supporting structure expands or shrinks. The sheet shall be fixed with wood screws to wooden ground
118

and the screw holes shall be drilled slightly longer than the screws. Asbestos sheet may also be advantageously fixed on to walls with cement plaster backing. The screws shall be fixed at 150 mm. to 200 mm. at supports. The boards shall be fitted either with wooden cover fillets or asbestos strips as described in item.

3.0. Mode of measurement and payment

3.1. The relevant specifications of item No. 16.4 shall be followed.

3.2. The rate shall be for a unit One sq. meter.

18.21 (II) Providing and fixing plain asbestos sheet lining with butt jointing to wood screws (frame work and cover fillets to be paid for separately), Class-B-5 mm. thick.

1.0. Materials & Workmanship

1.1. The relevant specifications of item No. 16.21 (I) shall be followed except that the plain A.C. sheet of Class-B 5 mm. thick shall be fixing in lining.

2.0. Mode of measurements & payment

2.1. The relevant specifications of item No. 16.21 (I) shall be followed.

2.2. The rate shall be for a unit of One sq. meter.

119

SECTION-17

Plastering and Paints

17.58 (I) 10 mm. thick cement plaster in single coat on fair side of brick concrete walls for interior plastering up to floor two level and finished even and smooth in (i) C. M. 1:3.

1.0. Materials

1.1. Water shall conform to M-1. The cement mortar of proportion 1:3 shall conform to M-13.

2.0. Workmanship

2.1. Scaffolding:

Wooden bullies, bamboos, planks, trestles and other scaffolding shall be sound. These shall be properly examined before erection and use. Stage scaffolding shall be provided for ceiling plaster which shall be independent of the walls.

2.2. Preparation of back-ground :

2.2.1. The surface shall be cleaned of all dust, loose mortar droppings, traces of algae, efflorescence and other foreign matter by water or by brushing. Smooth surface shall be toughened by wire brushing if it is not hard and by hacking if it is hard. In case of concrete surface, if a chemical retarded has been applied to the form work, the surface shall be roughened by wire brushing and all the resulting dust and loose particles cleaned off and care shall be taken that none of the readers if left on the surface. Trimming of projections on brick/concrete surfaces where necessary shall be carried out to get an even surface.

2.2.2. Raking of joints in case of masonry where necessary shall be allowed to dry out for sufficient period before carrying out the plaster work.

2.2.3. The work shall not be soaked but only damped evenly before applying the plaster. If the surface becomes dry, such area shall be moistened again.

2.2.4. For external plaster, the peasting operation shall be started from top floor and carried downwards. For

internal plaster, the plastering operations may be started wherever the building frame and cladding work are ready and the temporary supports of the ceiling resting on the wall of the floor have been removed. Ceiling plaster shall be completed before starting plaster to walls.

2.3. Application of plaster:

2.3.1. The plaster about 15x15 cms. shall be first applied horizontally and vertically at not more than 2 meters intervals over the entire surface to serve as gauge. The surfaces of these gauges shall be truly in plane of the finished plastered surface. The mortar shall then be applied in uniform surface slightly more than the specified thickness, then brought to a true surface by working a wooden straight edge reaching across the gauges with small upward and sideways movements at a time. Finally, the surface shall be finished off true with a trowel or wooden float according as a smooth or a smooth or a sandy granular texture is required Excessive troweling or overworking the float shall be avoided. All corners, arises, angles and junctions shall be truly vertical or horizontal as the case may be and shall be carefully finished. Hounding or chamfering, corners, arises junctions etc. shall be carried out with proper templates to be size required.

2.3.2. Cement plaster shall be used within half an hour after addition of water. And mortar or plaster which is partially set shall be rejected and removed forthwith from the site.

2.3.3. In suspending the work at the end of the day, the plaster shall be left out clean to the line both horizontally and vertically, when recommencing the plaster, the edges of the old work shall be scraped clean and wetted with cement putty before plaster is applied to the adjacent areas to enable the two to properly join together. Plastering work shall be closed at the end of the day on the body of the wall and nearer than 15 cm. to any corners or arises. It shall not be closed on the body of features such as plaster bands and cornices not at the corners or arises. Horizontal joints in plaster work shall not also occur on parapet tops and copings as these invariably lead to leakage. No portion of the surface shall be left out initially to be packed up later on.

2.3.4. Each coat shall be kept damp continuously till the next coat is applied or for a minimum period of 7 days. Moistening shall commence as soon as plaster is hardened sufficiently. Soaking of walls shall be avoided and only as much water as can be readily absorbed shall be used, excessive evaporation on the sunny or windward side of building in hot air or dry weather shall be prevented by hanging matting or gunny bags on the outside of the plaster and keeping them wet.

3.0. Mode of measurements & payment

3.1. The rate shall include the cost of all materials, labour and scaffolding etc. involved in the operations described under workmanship.

3.2. All plastering shall be measured in square meters unless otherwise specified. Length breadth or height shall be measured correct to a centimeter.

120

3.3. Thickness of the plaster shall be exclusive of the thickness of the key i.e. grooves or open joints in brick work, stone work etc. or space between laths. Thickness of plaster shall be average thickness with minimum 10 mm. at any point on this surface.

3.4. This item includes plastering up to floor two level.

3.5. The measurement of wall plastering shall be taken between the walls or partition (dimensions before plastering being taken) for length and from the top of floor or skirting to ceiling for height. Depth of cover of cornices if any shall be deducted.

3.6. Soffits of stairs shall be measured as plastering on ceilings, following soffits shall be measured separately.

3.7. For jambs, soffits, sills etc. for openings not exceeding 0.5 sq. met each in area for ends of joints beams, posts, girders, steps etc. not exceeding 0.5 sq. mt each in area and for openings exceeding 0.5. sq. mt and not exceeding 3.00 sq. mt. in each area deductions and additions shall be made in the following manners.

(a) No deductions shall be made for ends of joints, beams, posts etc. and openings not exceeding 0.5 sq. mt each and no addition shall be made for reveals, jambs, soffits, sills etc. of these openings, for finish to plaster around ends of joints, beams posts etc.

(b) Deduction for openings exceeding 0.5 sq. mt but not exceeding 3 sq.mt. each shall be made as follows and no addition shall be made for ravel, jambs, soffits, sills etc. of these openings, (i) When both faces of all wall are plastered with same plaster, deduction shall be made for one face only, (ii) When two faces of wall are plastered with different types of plasters or if one face is plastered and the other pointed, deductions shall be made from the plaster or pointing on the side of frame for door, window etc. on which width of reveals is less than that on the other side but no deductions shall be made on the other side. Where width of reveals on both faces of all are equal, deductions of 50% of area of opening on each face shall be made from areas of plaster and / or pointing as the case may be.

3.8. For openings having door frames equal to or projecting beyond the thickness of wall, full deduction for opening shall be made from each plastered face of the wall.

3.9. In case of openings of area above 3 sq. mt. each, deduction shall be made for openings but jambs, soffits sand sills shall be measured.

3.10. The rate shall be for a unit of One sq. meter.

17.58 (II) 10 mm. cement plaster in single coat on fair side of brick/concrete walls for interior plastering up to floor two level and finished even and smooth in C.M. 1:4.

1.0. Materials & workmanship

1.1. The relevant specifications of item No. 17.58 (I) shall be followed except that the proportion of mortar is C.M. 1 :4 instead of C.M. 1:3.

2.0. Mode of measurements & payment

2.1. The mode of measurements and payment shall be the same as for item No. 17.58 (I)

2.2. The rate shall be for a unit of One sq. meter.

17.58 (III) 10 mm. cement plaster in single coat on fair side of brick/concrete walls for interior plastering up to floor two level and finished even and smooth in C.M. 1:6.

1.0. Materials & Workmanship

1.1. The relevant specifications of item No. 17.58 (I) shall be followed except that the proportion of mortar is cement mortar 1:6.

2.0. Mode of measurements & payment

2.1. The mode of measurement and payment shall be followed same as item No. 17.58(1)

2.2. The rate shall be for a unit of one square meter.

17.61.(I) 20 mm. thick cement plaster in single coat on rough side of single or half brick wall for interior plastering up to floor two level, finished even and smooth in cement mortar 1:3 (1 cement : 3 sand).

1.0. Materials & workmanship

1.1. The relevant specifications of item No. 17.59 (I) shall be followed except that the thickness of cement plaster shall be 20 mm. The plastering work shall be in single coat on rough side of half brick wall for interior plastering up to floor two level, finished even and smooth in C.M. 1:3.

2.0. Mode of measurements & payment

2.1. The relevant specifications of item No. 17.59(1) shall be followed.

2.2. The rate shall be for a unit of One sq. meter.

121

17.61.(II) 20 mm. thick cement plaster in single coat on rough side of single or half brick wall for interior plastering up to floor two level, finished even and smooth in cement mortar 1:4 (1 cement : 4 sand).

1.0. Materials & Workmanship

1.1. The relevant specifications of item No. 17.59. (II) shall be followed except that the thickness of plastering shall be 20 mm. in C.M 1:4.

2.0. Mode of measurements & payment

2.1. The relevant specifications of item No. 17.59 (I) shall be followed.

2.2. The rate shall be for a unit of one sq. meter

17.61 (III) 20 mm. thick cement plaster in single coat on rough side of single or half brick wall for interior plastering up to floor two level, finished even and smooth in C.M. 1:6 (1 cement : 6 sand).

1.0. Materials & Workmanship

1.1. The relevant specifications of item No. 17.59 (III) shall be followed except that thickness of plaster shall be 20 mm. C.M 1:6.

2.0. Mode of measurements & payment

2.1. The relevant specifications of item No. 17.59 (I) shall be followed.

2.2. The rate shall be for a unit of One sq. meter.

17.69 Extra over items 51 to 65 for finishing with a floating coat of neat cement slurry.

1.0. Materials & workmanship

1.1. The relevant specification of item No. 17.58 and 1761 shall be followed for materials and workmanship except that this work is only providing smooth cement finish with floating coat of neat cement slurry

1.2. The coat of cement and fine sand mortar of proportion V1 (1 5 mm thick about) shall be applied to the plastered surface with a trowel to provide uniform texture while the base coat is still plastic.

1.3. In any continuous face of wall the finishing treatment should be carried out continuously and day lo day breaks made to coincide with architectural breaks in order to avoid unsightly Junctions

1.4. Curing : All the plaster work shall be kept damp continuously for a period 7 days

2.0. Mode of measurements and payment

2.1. The payment shall be made for a unit of 1.0 sq. mt of work done over an above the finishing of work of base coat.

2.2. The relevant specifications of item of base coat shall be followed for measurements and payment.

2.3. The rate shall be for a unit of One sq. meter.

17.70. Extra over item 17.58 to 17.61 for providing and mixing water proofing materials m cement mortar in proportion recommended by the manufacturers.

1.0. Materials and Workmanship

The relevant specification of item No 17.58 to 1761 shall be followed except that the water proofing materials of approved made shall be added to the cement at the rate specified or as directed by The Engineer-in-charge. The proportion proofing materials of water to be mixed with 50 kg bags shall be as recommended by the manufacturers of the water proofing material

2.0. Mode of measurements & payment

2.1. The payment shall he made extra for this work over and above the plaster work

2.2. The rate shall he for a unit or 1 Kg of water proofing materials used in 1 bag of weighing 50 Kg cement used extra over the rate of plastering work

17.91. Extra over item No. 17.59 to 17.61 for plastering on ceiling and soffits of stair up to floor two level instead of plastering on walls.

1.0. Materials and Workmanship

1.1. The relevant specifications of item No 17.59 (1) shall no followed except that this work is for ceiling, soffits

of stairs up to two floor

1.2. The smooth concrete surface shall be suitable roughened to provide bond before plastering.

2.0. Mode of measurement and payment

2.1. The payment shall be made for a unit of One sq meter of work done extra over and above the payment of plaster work on wall surfaces.

2.2. The rate shall be for a unit of one sq. meter.

17.94(I) Extra over item No. 1 to 69, 71 to 87 and 90 for interior plastering above floor two level for every additional storey height (I) Single coat plaster.

1.0 Materials and Workmanship

1.1 The relevant specification of Item No. 17.59 (1) shall be followed except that the whole work is to be carried out above floor two level.

122

2.0. Mode of measurements and payment

1.2. The mode of measurement and payment shall be same as item No. 17.59(1).

2.2. The extra payment shall be made over and above the floor two level rate for every additional floor height.

17.94 (II) Extra over item 1 to 69, 71 to 87 and 90 for interior plastering above floor two level for every additional storey height. Tow coat plaster.

1.0. Materials & workmanship

1.1. The relevant specifications of item No. 17.94 (I) shall be followed except that extra payment for work shall be for a two coat plaster.

2.0. Mode of measurements & payment

2.1. The relevant specifications of item No. 17.94(1) shall be followed.

2.2. The rate shall be for a unit of one sq. meter.

17.94(111) Extra over item 1 to 69, 71 to 87 and 90 for interior plastering above floor two level for every additional storey height. Floating coat of neat cement.

1.0. Materials & Workmanship

1.1. The relevant specifications of item No. 17.94 (I) shall be followed except that the extra payment shall be made for work of floating coat of neat cement slurry.

2.0. Mode of measurements & payment

2.1. The relevant specifications of item No. 17.59 (I) shall be followed.

2.2. The rate shall be for a unit of One sq. meter.

17.95. 20 mm. thick sand face cement plaster on walls up to height of 10 mm. and above ground level consisting of 12 mm. thick backing coating of C.M. 1:3 (1 cement : 3 sand) and 8 mm. thick finishing coat in C.M. 1:1 (1 cement : 1 sand) etc. complete.

1.0. Materials

1.1. Water shall conform to M-1. Cement mortar shall conform to M-11.

2.0. Workmanship

2.1. The work shall be carried out in the coats. The backing coat (base coat) shall be 12 mm. thick in C.M. 1:3. The relevant specifications of item No. 17.58(I) shall be followed except that the thickness of back coat shall be 12 mm. average. Before the first coat hardens its surface shall be beaten up by edges of wooden tapers and close dents shall be made on the surface. The subsequent coat shall be applied after this coat has been allowed to set for 3 to 5 days, depending upon the weather conditions. The surface shall not be allowed to dry during this period.

2.2. The second coat shall be completed to 8 mm. thickness in C.M. 1:1 as described above, including raising sand facing by bushing. The sample of sand face shall be got approved before the work is started. The whole work shall be carried out uniformly as per sample approved.

2.3. Curing :

The curing shall be started overnight after finishing of plaster. The plaster shall be kept wet for a period of 7 days. During this period, it shall be protected from all damages.

3.0. Mode of measurement & payment

3.1. The relevant specifications of item No. 17.58 shall be followed except that the sand face plaster on outside up to 10 m. above ground level shall be measured under this item.

3.2. The rate shall be for a unit of One sq. meter.

17.116(A) Pointing on brick work with cement mortar 1:3 (1 cement : 3 coarse sand) flush pointing.

1.0. Materials

1.1. Water shall conform to M-1. Cement mortar shall conform to M-11.

2.0. Workmanship

2.1. The flush pointing work shall be carried out with cement mortar of proportion 1:3(1 part of cement and 3 part of coarse sand) by volume.

2.2. Preparation of surface.

2.2.1. The joints shall be raked to such a depth that the average of new mortar measured from either the sunk surface to finished pointing or from the -edge of the brick shall be average 10 mm.

2.3. Application of Mortar and Finishing :

2.3.1. The mortar shall, be pressed in to the raked out joints with a pointing trowel according to the types of pointing specified in item. The mortar shall not spread over the corner edges or surface of the masonry. The pointing shall then be finished with the pointed tools.

123

2.4. Curing :

2.4.1. The pointing shall be kept wet for 7 days. During this period, it shall be suitably protected from all damages.

3.0. Mode of measurements & payment

3.1. No deductions shall be made end of joints, beams and posts etc. and openings not exceeding 0.5 s. mt. each and no addition shall be made for reveals, jambs, soffits, sills etc. of these openings.

3.2. Deductions for openings exceeding 0.5 sq. mt. but not exceeding 3 sq. mt. each shall be paid as follows and no addition shall be made for reveals, jambs, soffits, sills etc. of these openings : (i) When both faces of walls are pointed with same type of pointing, deduction shall be made for one face only, (ii) When two faces of walls are pointed with different type of pointing or if one face is plastered and the other is pointed, deduction shall be made in the plaster or pointing on the side of frame for door, windows etc. on which the width of reveals is less than that on the other side but no deduction shall be made from plaster or pointing on the other side.

(iii) When only one face is treated and the other face is not rested, full deduction shall be made, if the width of the reveals on the treated side is less than on the untreated side, but if the width of the reveal is more than no deduction shall be made nor any addition shall be made for reveals/jambs, soffits, sills etc. **3.3.** In case of openings of area above 3 sq. mt each deduction shall be made for opening but jambs, sills, and soffits, shall be measured.

3.4. The rate shall be for a unit of One sq. meter.

17.116(8) Pointing on brick work with cement mortar 1:3 (1 cement : coarse sand) Ruled pointing.

1.0. Materials & Workmanship

1.1. The relevant specifications of item No. 17.116 (A) shall be followed except that the pointing to be done ruled pointing as under:

1.2. The joints shall be initially formed as for flush pointing and then while the mortar is still green, a groove of specified shape shall be formed by running forming tool straight along the centre line of joints till a smooth and hard surface is obtained. The vertical joints shall also be finished in a similar way. The pointing lines shall be uniform in width and truly horizontal and parallel in case of floor and ceiling.

2.0. Mode of measurements & payment

2.1. The mode of measurements and payment shall be the same as per item No. 17.116(A).

2.2. The rate shall be for a unit of One sq. meter.

17.117(A) Pointing on brick work with cement mortar 1:4 (1 cement : 4 sand) Flush pointing.

1.0. Materials & Workmanship

1.1. The relevant specifications of item No. 17.116 (A) shall be followed.

2.0. Mode of measurements & payment

2.1. The relevant specifications of item-No. 17.116 (A) shall be followed.

2.2. The rate shall be for a unit of One sq. meter.

17.117(6) Pointing on brick work with cement mortar 1:4 (1 cement : 4 sand) Ruled pointing.

1.0. Materials & Workmanship

1.1. The relevant specifications of item No. 17.116(6) shall be followed except that the proportion of C.M. 1:4 shall used for ruled pointing.

2.0. Mode of measurements and payment

2.1. The relevant specifications of item No. 17.115 (A) shall be followed.

2.2. The rate shall be for a unit of One sq. meter.

17.140.(A) Pointing on coursed stone masonry with cement mortar 1:3 (1 cement : 3 sand) flush pointing.

1.0. Materials and workmanship

1.1. The relevant specifications of item No. 17.116 (A) shall be followed except that the pointing shall be done on coursed stone masonry with C.M. 1:3 and the mortar shall be simply struck off with a trowel and the work left showing the natural irregularities in line and the surface of the stones themselves.

2.0. Mode of measurement and payment

2.1. The relevant specifications of item No.17.116 (A) shall be followed.

2.2. The rate shall be favor a unit of One sq. meter.

17.140(B) Pointing on course stone masonry with cement mortar 1:3 (1 cement ; 3 sand) Ruled pointing.

1.0. Materials and Workmanship

1.1. The relevant specifications of item No. 17.140 (A) and 17.116 (B) shall be followed.

124

2.0. Mode of measurements & payment

2.1. The relevant specifications of item No. 17.116(A) shall be followed.

2.2. The rate shall be for a unit of One sq. meter.

17.44.(A) Pointing on uncoarsed stone masonry with cement mortar 1:3 (1 cement : 3 sand) Flushing pointing.

1.0. Materials & Workmanship

1.1. The relevant specifications of item No 17 116(A) shall be followed except that the flush pointing shall fie done on uncoarsed rubble masonry work if C.M 1 3 and the mortar shall De simply Struck off with a trowel and the work left showing the natural irregularities in line and the surface of the stone themselves.

2.0. Mode of measurements and payment

2.1. The relevant specifications of item No. 17.116(A) shall be followed.

2.2. The rate shall be for a unit of One sq. meter.

17.144.(B) Pointing on uncoarsed stone masonry with cement mortar 1:3 (1 cement : sand) Ruled pointing.

1.0. Materials & Workmanship

1.1. The relevant specification of item No 17 116 (Aj) and 17 144 (A) shall be followed except that the ruled pointing work -shall be carried out on uncoarsed rubble masonry work in CM 1.3.

2.0. Mode of measurements and payment

2.1. The relevant specifications of item No. 17.116(A) shall be followed.

2.2. The rate .shall be for a unit of One sq. meter

17.0.0.1 Providing cement vata (10 cms x 10 cms) size quarter round in cement mortar 1:1 including neat cement finishing, watering, etc. complete.

1.0. Materials

1.1. Water shall conform to M-1 .Cement mortar shall conform to M-11.

2.0. Workmanship

2.1. The work of cement vata of 10 cms x 10 cms. size shall be earned out at Functions of parapets and terraces as directed. The vata shall he finished in quarter round shape. The work shall be earned out in the nest workman like manner. The inter portion of rain water pipe shall be rounded off properly during constructing the vata. The work shall be cured for 7 days.

3.0. Mode of measurements and payment

3.1. The work shall be measured for finished item in running meter.

3.2. The rate shall be for a One running meter.

125

SECTION-18

White Washing & Distempering

18.11. White washing with lime on undecorated wall surfaces (two coats) to give an even shade including thoroughly brooming the surface to remove alt dirt, dust, mortar drops and other foreign matter.

1.1. Materials

1.1. The clear Cole shall be made from glue and boiling water by mixing 1 Kg. mixture shall be suitably tinted where required for use under coloured distemper it directed. Glue shall conform to I.S. 352-1959 (Specifications for animal give)

1.2. Lime used shall be Freshly burnt class 'C' Lime (fat lime) and white in colour conforming to I.S. 712-1973. Water shall conform to M-1. Best quality of gum shall be used in (he preparations of white wash. Ultramarine blue or Indigo : This shall conform to I.S. 55-1970 for points, and shall be used for preparation of white was, Pigments. Mineral colours, not affected by lime shall be used in preparing colour wash.

2.0. Workmanship

2.1. Preparation of white wash solution Surface already white or colour. The fat lime shall be slaked as site and shall be mixed and stirred with about five liters of water for 1 kg. of unslaked lime to made a trim cream This shall be allowed to stand for d period of 24 hours and then shall be screened through a clean coarse cloth, 4 Kg. of gum dissolves in hot water shall be added to each cubic meter of lime cream Small quantity of ultramarine blue (Up to 3 gins, per kg. of lime) shall also-be added to the last two coats of white wash solution and the whole solution shall be stirred thoroughly before use.

2.2. Preparation of surface:

2.2.1. The surface shall be thoroughly cleaned of all dust, dirt, mortar cropping and other foreign matter before white wash is to be applied.

2.2.2. The surface spoiled by smoke soot shall be scrapped with steel wire brushes or steel scrapers 01 shall be rubbed with over-burnt surkhi or brick bats. The surface shall be then broomed to remove all dust dirt and shall he washed with clean water.

2.2.3. Oil or grease spots shall be removed by suitable chemical and smooth surface shall be rubber with wire Crushes.

2.2.4. All unsound portion of the surface plaster shall be removed to full depth of plaster in rectangular patches and plastered again after raking the masonry joints properly. Such portion shall he wetted and allowed to dry. They shall then be given one coat of white wash

2.2.5. All unnecessary nails shall be removed the holes, cracks, patches etc. shall be made good with material similar in composition to the surface to be prepared

2.3. Scaffolding :

Wherever scaffolding is necessary it shall be erected in such a way that as far as possible on part of scaffolding shall rest against the surface to be white or colour washed A properly secured strong and well tied suspended platform (Zoola) may be used for white washing. Where ladders are used pieces of old gunny bags shall be tied at top and bottom to prevent scratches to the floors and walls. For white washing of ceilings, proper stage scaffolding shall be erected where necessary.

2.4. Application of white wash :

2.4.1. On the surface so prepared the white wash shall be applied with 'Moon' brush. The first stroke of the brush shall be from top downwards, another from bottom upwards over the first stroke and similarly one stoke from the right another from the left, over the first stroke brush before it dries. This will form one coat each coat shall be allowed to dry before and uniform finish free from brush marks and it should not come oft easily when rubbed with finger

2.4.2. Splashing and dropping if any on the doors and windows, ventilators etc shall be removed and the surface

cleaned.

2.4.3. Priming and Alkali resistant treatments, scraping of surface washing etc. surface spoiled by smoke soot removed of oil and grease spots, treatment for infection with efflorescence moulds moos, fungi, algae and lichen and patch repairs to plaster wherever done shall not be paid extra.

126

3.0. Mode of measurement & payment

3.1. All the work shall be measured in the decimal system as under:

- (a) Dimensions shall be measured to the nearest 0.01 m.
- (b) Area in individual item shall be worked out to the nearest 0.01 sq.m.

All the work shall be measured in sq. mt. Deductions for jambs, soffits, sills etc. for openings not exceeding 0.5 sq. mt. each in area, for ends of joists, posts, beams, girders, steps etc. not exceeding 0.5 sq mt. each in area and for openings exceeding 0.5 sq. mt. and not exceeding 3.0. sq. mt. each in area, deductions and additions shall be made as under.

3.2. No deductions shall be made for ends of joists, beams, posts, etc. and openings not exceeding 0.5 sq mt. each. No addition shall be made for reveals, jambs, soffits, sills etc. of these openings not for finish around ends of joints, beams, posts etc.

3.3. No deductions for openings exceeding 0.5 sq.mt. but not exceeding 3 sq. mt. each shall be made as follows and no addition will be made for reveals, jambs, soffits etc. of these openings :

- (a) When both the faces of walls are provided with finish, deduction shall be made for one face only.
- (b) When each face of wall is provided with different finish, deduction shall be made for that side of frame for door, windows, etc. on which width of reveals is less than that of the other side. Where width of reveals on both faces of wall are equal, deduction of .50% of area of opening on each face shall be made from total area of finish.
- (c) When only one face of wall is treated and the other face is not treated, full deduction shall be made if the width of reveal on the treated side is less than that on the untreated side, but if the width of the reveal is equal or more than on the untreated side neither deductions nor additions to be made for reveals, jambs, soffits, sills etc.

3..4 In case of area of openings exceeding 3 sq. mt. each, deductions shall be made for openings but jambs, soffits, sills shall be measured.

3.5. No deductions shall be made for attachment such as casing, conducts, pipe, electric wiring and the like.

3.6. Corrugated surfaces shall be measured flat as fixed and not girth. The quantities so measured shall be increased by the following percentage and the resultant shall be included with the general areas:

- (a) Corrugated steel sheets..... 14%
- (b) Corrugated A.C. sheets..... 20%
- (c) Semi corrugated A.C. Sheets..... 10%
- (d) Nainital pattern roof (Plain sheeting sheets)..... 10%
- (e) Naintial pattern roof (with corrugated sheets)..... 25%

3.7. Cornices and other wall features, when they are not picked out in a different finish/colour shall be girthed and included in the general area.

3.8. The rate shall include the cost of ail materials, labour, scaffolding, protective measures etc. involved in all the operations described above.

3.9. The rate shall be for a unit of One sq. meter.

18.12. White washing with lime on decorated wall surface (One coat) to give an even shade including thoroughly brooming in the surface to remove dust, mortar, drops and loose scales of lime wash and other foreign matter.

1.0. Materials and Workmanship

1.1. The relevant specifications of item No. 18.11 shall be followed except that the white washing work shall be carried out on decorated wall surface single coat.

2.0. Mode of measurements & payment

2.1. The relevant specifications of item No. 18.11 shall be followed.

2.2. The rate shall be for a unit of One sq. meter

18.13 Extra over items 18.11 and 18.12 for every subsequent coat of white washing with lime on wall surfaces.

1.0. Materials and Workmanship

1.1. The relevant specifications of item No. 18.11 shall be followed except that this work is for extra coat over and above two coats on wall surface.

127

2.0. Mode of measurements and payment

2.1. The relevant specifications of item No. 18.11 shall be followed except that the payment of subsequent coat shall be made extra over and above the item No, 18.11 for every subsequent coat applied.

2.2. The rate shall be for a unit of One sq. meter.

18.14. Extra over item 18.11 for white washing with the lime on ceiling and / or sloping roof.

1.0. Materials and Workmanship

1.1. The relevant specifications of item No. 18.11 above shall be followed except that this work is for ceiling and / or sloping roof.

2.0. Mode of measurements and payment

2.1. The relevant specifications of item No. 18.11 shall be followed except that extra payment for white washing on ceiling and/or slopping roof shall be made over and above the payment of item No. 18.11

2.2. The rate shall be for a unit of One sq. meter.

18.15 Extra over 18.12 for white washing with lime on decorated dealings and sloping roofs.

1.0. Materials and Workmanship

1.1. The relevant specifications of item No. 18.12 shall be followed except that the white washing work shall be carried out on decorated ceilings and/or sloping roofs.

2.0. Mode of measurements and payment

2.1. The relevant specifications of item No. 18.52 shall be followed except that extra payment for white washing on ceiling and/or sloping roof shall be made over and above the payment of item No. 18.12.

2.2. The rate shall be for a unit of one sq. meter.

18.16. Extra over the item No. 18.13 for every subsequent coat of white washing with lime on ceiling and /or sloping roofs.

1.0. Materials and Workmanship

1.1. The relevant specifications of item No. 18.11 and 18.13 shall be followed except that this work is for extra coat over and above two coats of ceiling and / or sloping roofs.

2.0. Mode of measurements and payment

2.1. The relevant specifications of item No. 18.11 and 18.13 shall be followed except that the extra payment for white washing shall be made for sloping roof or/and ceiling for every subsequent coat applied over and above item 18.11 and 18.13.

2.2. The rate shall be for a unit of one sq. meter.

18.17. Colour washing with lime on undecorated wall surfaces (Two coats) over and including priming coat of white washing to give even shade including thoroughly brooming the surface to remove all dirt, dust, mortar drops and other foreign matter. The relevant specifications for the materials and workmanship 18.11 shall be followed except that it shall be for colour wash.

1.0. Materials

1.1. Clear-Cole : This shall be made from glue and boiling water by mixing 1 kg. of glue to every 15 liters of water. The mixing shall be suitably tinted to match with colour of colour washing as directed. Glue shall conform to I.S. 852-1969.

1.2. Lime : Lime used shall be freshly burnt class 'C' lime (Fat lime) and white in colour conforming to I.S. 712-1973.

1.3. Water : Water shall conform to M-1.

1.4. Gum ; Best quality of gum shall be used in the preparation of white or colour wash. The colour pigment of required tint and shade shall be mixed in lime cream. The mineral colour not affected by lime shall be used in preparing the colour wash.

2.0. Workmanship

2.1. Sufficient quantity of colour wash enough for the complete job shall be prepared in one operation to avoid any difference in shade. The basic white wash solution shall be prepared in accordance with item 18.11 Mineral colours not affected by lime shall be added to the white wash solution. No colour wash shall be done until a sample of the colour has been approved. It shall be noted that small samples of colour appears lighter in shade than when the same shades are applied precisely to large surface. The colour shall

128

be of event, tint, over the colour shall be of event tint, over the whole surface. If it is patchy or otherwise badly applied, it shall be rejected. Preparation of the colour wash with pigment shall be as under:

(a) With Yellow and Red Ocher :

Solid lumps if any in the powder shall be crushed to powder and solution in water prepared and then added to white wash sieving it through a coarse cloth, mixed evenly and thoroughly to white wash in-small quantities till required shade is obtained.

(b) With Blue Vitriol :

Fresh crystals of hydrous copper sulfate (i.e. vitriol) shall be ground to fine power and dissolved in small quantity of water. Sufficient quantity of solution enough to produce the colour wash of required shade shall be strained through a clean cloth, the filtrate being mixed evenly and thoroughly to the white wash.

(c) Colour wash from other colouring pigment shall be prepared in accordance with the instructions of the manufacturer.

2.2. Preparation of Surface :

The surface shall be prepared by removing mortar dropping and foreign matter and thoroughly cleaned with wire of fiber brush or any other suitable means as directed by the Engineer-in-charge. All loose pieces and scales shall be scrapped off and holes filled with mortar.

2.2.1. For scaffoldings and application of colour wash, relevant specification of item No. 18.11. above shall be followed. The colour wash shall be applied as under:

The colour wash shall be applied in accordance with the procedure given in item No. 18.11. "Application of white wash for colour washing on undercoated surface after the surface has been prepared. The first primary coat shall be of white wash and subsequent coats (minimum two) shall be colour wash and the entire surface shall represent a smooth and uniform finish. To start with, patch of 0.1 sq. mt. on prepared surface shall be colour washed with first coat of white wash and subsequent coats of colour wash solution entire work of colour washing is taken up in hand, it shall be noted that small areas of colour wash will appear lighter than when the same shade is applied to the large surface.

2.2.2. For colour washing on decorated surfaces, after (he surface has been prepared, a coat of white wash shall

be applied for the patches and repairs. Then one coat or more of colour wash shall be applied over the entire surface, such that the colour washed surface shall present a uniform colour shade. No primary coat is needed for a decorated surface bearing colour of same shade on surface required change of colour after the surface has been prepared as described above. Two coats of white wash shall be applied before application of specified number (minimum two) of coats of colour wash of the new shade.

2.3. Protective measure :

The surface of doors, windows, floors, articles, of furniture etc. and such other parts of the building not to be white washed shall be protected from being splashed upon. Such surfaces shall be cleaned of white wash splashed if any.

3.0. Mode of measurements and payment

3.1. The relevant specifications of item No. 18.11 shall be followed.

3.2. The rate shall be for a unit of One sq. meter.

18.18. Colour washing with lime on decorated wall surfaces (one coat) to give even shade including thoroughly brooming the surface to remove all dirt, dust, mortar drops and loose scales of lime wash and other foreign matter.

1.0. materials and Workmanship

The relevant specifications item No 18.17 shall be followed except that the colour washing shall be carried out on decorated wall surface in one coat

2.0. Mode of measurements and payment

2.1. The relevant specifications of item No 18.7 shall be followed.

2.2. The rate shall be for a unit of One sq. meter.

18.19. Extra over item No 13.17 and 18.18 for every subsequent coat of colour wash with lime on wall surfaces.

1.0 Materials and Workmanship

1.1 The relevant specifications item No. 18.17 shall be followed except that this work is for extra coat of colour wash over and above two coats on wall surface.

129

2.0. Mode of measurement and payment

2.1. The relevant specifications of item No. 18.17 shall be followed except that the extra payment for every subsequent coat of white wash shall be made over and above the rate of item. 18.17 and 18.18.

2.2. The rate shall be for a unit of one sq. meter.

18.20. Extra over item 18.17 for colour washing on ceilings and /or sloping roofs.

1.0. Materials and workmanship

1.1. The relevant specifications of item No. 18.17 shall be followed except that this work is for colour washing on ceiling and/or sloping roofs.

2.0. Mode of measurements and payment

2.1. The relevant specifications of item No. 18.17 shall be followed except that the rate shall be paid extra over and above the rate of item No. 18.17 for providing colour washing on ceiling and /or sloping roof.

2.2. The rate shall be for a unit of One sq. meter.

18.29. Cement washing with port land cement slurry on undecorated wall surfaces, (one coat) to give a smooth finish including thoroughly brooming the surface to remove all dirt, dust, mortar drops and other foreign matter.

1.0. Materials

1.1. Water shall conform to M-1. Part land cement shall conform to M-3.

2.0. Workmanship

2.1. The relevant specification of item No. 18.11 for preparation of surface, scaffolding, application of wash etc. shall be followed except that the cement wash shall be applied, instead of white wash. Cement applied with brushes to form a smooth bodied opaque surface.

3.0. Mode of measurements and payment

3.1. The relevant specifications of item No. 18.11 shall be followed.

3.2. The rate shall be for a unit of one sq. meter.

18.30. Extra over item No. 18.29 for every subsequent coat of cement washing with port land cement slurry.

1.0. Materials Workmanship

1.1. The relevant specifications of item No. 18.29 shall be followed except that the work of cement slurry wash shall be provided for every subsequent coat above item No. 18.29 to be applied.

2.0. Mode of measurements and payment

2.1. The relevant specification of item No. 18.29 shall be followed except that the extra rate shall be paid for every subsequent coat and above the rate of item No. 18.29.

2.2. The rate shall for a unit of One sq. meter.

18.33. Removing dry or oil bound distemper by washing scraping and sand papering the wall surface smooth including necessary repairs to scratches complete.

1.0. Materials and Workmanship

1.1. All loose places and scaled shall be removed by sand papering and surface shall be cleared of all greasycay, dust, dirt, etc. on decorated wall surfaces. Where heavy scaling has taken place, the entire surface shall be scrapped by means of steel scrappers so as to remove all accumulated distemper, leaving clean surfaces. Necessary repairs to the scratches shall be made as directed.

2.0. Mode of measurements and payment

2.1. The relevant specifications of item No. 18.11. shall be followed.

2.2. The rate shall be for a unit of One sq. meter,

13.34. Extra over item No. 18.33. for removing dry oil bound distemper on ceiling and sloping and roofs.

1.0. Workmanship

1.1. The relevant specifications of item No. 18.33 shall be followed except that removing dry/oil bound distemper from sloping roof/ceiling is to be carried out.

130

2.0. Mode of measurements and payment

2.1. The relevant specifications of item No. 18.33 shall be followed except that the payment shall be made for removing dry/oil bound distemper from ceiling/sloping roof over and above the rate of item No. 18.33.

2.2. The rate shall be for unit of one Sq. meter.

18.38. Distempering with dry (water bound) Distemper of approved brand and manufacture (two coats) and of required shade on undecorated wall surfaces to give an even shade, over and including a priming coat of white washing after thoroughly brooming the surface free from mortar droppings and other foreign matters.

1.0. Materials

1.1. The dry distemper and primer shall be of approved brand and manufacture. The dry distemper shall be of required colour and shade and the same shall conform to I.S. 427-1965. Writing shall conform to I.S. 63-1964.

2.0. Workmanship

2.1. Scaffolding : Where scaffolding is required it shall be erected in such a way that as far as possible no part of scaffolding shall rest against the surface to be distempered. A properly secured strong and well tied suspended platform (Joolas) may be used for distempering. Where ladders are used- pieces of old gunny bags shall be tied at top and bottom to prevent scratches to the walls and floors. \For distempering to ceiling, proper stage scaffolding shall be erected where necessary.

2.2. Preparation of Surface.

2.2.1. The undecorated surface to be distempered shall be thoroughly brushed free from dust, dirt, grease, mortar, droppings and other foreign matter and sand papered smooth. New plaster surface shall be allowed to dry at least 2 months before application of distemper.

2.2.2. All unnecessary nails shall be removed. Pitting in plaster shall be made good with plaster of Paris mixed with dry distemper of the colour to be used. The surface shall then be rubbed down again with a fine grades and paper and made smooth. The surface affected by moulds, moss, fang, algae lichens, efflorescence etc. shall be treated in accordance with I.S. 2395 (Part-I) 1966 before applying distemper. Any unevenness shall be made good by applying putty made of plaster of Paris mixed with water on entire surface including filling up the undulations and then sand papering the same after it is dry.

2.3. Priming coat :

2.3.1. A priming coat of whiting shall be applied as per item No. 18.11 over the prepared surface in case of new work on undecorated surface. No coat of white washing with lime shall be used as a priming coat for distemper.

2.3.2. Application of plaster shall be done as under:

The primer shall be applied with a brush on the clean dry and smooth surface. Horizontal strokes shall be given first and vertical stokes shall be applied immediately afterwards. This entire operation will constitute one coat. The surface shall be finished as uniformly as possible leaving no brush marks. It shall be allowed to one coat. The surface shall be finished as uniformly as possible leaving no brush marks. It shall be allowed to dry for at least 48 hours before oil bound distemper or paint is applied.

2.3.3. Distemper is not recommended to be applied within six months of the completion of wall plaster.

2.4. **Proportion of Distemper :** The distemper shall be diluted with water or any other prescribed thinner in a manner recommended by the manufacturers only. Sufficient quantity of distemper required for one day's work shall be prepared.

2.5. Application of Distemper coat :

2.5.1. For undecorated surfaces after the primer coat is dried for at least 48 hours, the surfaces shall be lightly sand papered to make them smooth for receiving the distemper, taking care not to rub out the priming coat. All loose particles shall be dusted off after rubbing. Minimum two coats of distemper shall be applied with brushes in horizontal strokes followed immediately by vertical strokes which together shall constitute one coat. The subsequent coats shall be applied after a time interval strokes which together shall constitute one coat. The subsequent coats shall be applied after a time interval of at least 24 hours between consecutive coats to permit proper drying of the proceeding coat. The finished surface shall be even and uniform without patches, brush marks, distemper drops etc.

2.5.2. Sufficient quantity of distemper shall be mixed to finish on room at a time. The application of a coat in each room snail be finished in one operation and no work shall be started in any room which cannot be completed, on the same day.

131

2.5.3. 15 cm. double bristle distemper brush shall be used. After the day's work, brushes shall be thoroughly washed in hot water with soap solution and hang down to dry. Old brushes which are dirty and caked with distemper shall not be used on the work.

2.6. **Protective Measures :** The surfaces of doors, windows, floors, articles of furniture etc. and such other parts of the building as are not to be distempered shall be a plashed form being splashed upon. Such surfaces shall be cleaned of distemper a plashes if any.

3.0. Mode of measurements and payment

3.1. Pruning coal of distemper primer, scraping of surface spoiled by smoke soot, removal of oil and grease spots, treatment for infraction of effloresces, mould moss, fungi, algae and lichens and patch repairs to plaster shall be included in this item for which nothing extra shall be paid.

3.2. AH the work shall be measured net in the decimal system as in places subject to the following limits unless otherwise stated hereinafter:

(a) Dimensions shall be measured to the nearest 0.01 m.

(b) Area in individual items shall be worked out to the nearest 0.01 sq. m. All work shall be measured in sq. meter. No deductions shall be made for ends of joints, beams, posts, etc. of these openings nor for finish around the ends of joints, beams, posts etc.

3.3. Deductions of openings exceeding 0.5 sq.m. but not exceeding 3 sq. m. each shall be made as follows and no addition shall be made for reveal, jambs, soffits etc. of these openings:

(a) When both the faces of walls are provided with the same finish deductions shall be made for one face only.

(b) When each face of wall is provided with different finish, deduction shall be made for that of frame for door, windows etc. on which width of reveal is less than that of the other side but no deductions shall be made on the other side. Where the width of reveals on the both the faces of wall are equal, deduction of 50% of area of opening on each face shall be made from area of finish.

(c) When only one face of wall is treated and the other face is not treated, full deductions shall be made if the width of the reveal on treated side is less than that on untreated side but if the width of the reveals is equal or more than that of untreated side neither deductions nor additions to be made for reveals, jambs, sills and soffits shall be measured

3.4. In case of openings of area exceeding 3 sq.m. each, deduction shall be made for openings, but jambs, sills and soffits shall be measured.

3.5. No deductions shall be made for attachments such as casing, conduits, pipes, electric wiring and the like.

3.6. Item includes removing nails, making good holes, cracks, patches with materials similar in composition to the distemper.

3.7. The rate includes cost of all materials, labour, scaffolding, protective measures etc. involved in all the operations described above This shall also include conveyance, delivery, bundling, unloading storing etc.

3.8. The rate shall be for a unit of One sq. meter.

18.39. Distemping with dry (wafer bound) distemper of approved brand and manufacture (one coat) and of required shade, on decorative wall surface to give an even shade after thoroughly brushing the surface clean of all grease dirt, loose pieces of scales including preparing the surfaces and even sand papered smooth.

1.0. Materials and workmanship

The relevant specifications of Kern No. 18,38 shall be followed except that the dry distemper shall applied on decorative wall surface in on coat.

2.0. Mode of measurements and payment

2.2. The rate shall be for a unit of One sq. meter.

18.40. Extra over item 38 and 39 for every subsequent coat of distemper with dry distemper of approved brand and manufacture.

1.0. Materials and Workmanship

1.1. The relevant specifications of item No. 18.38 shall be followed except that the extra work for applying subsequent coat of dry distemper is to be carried out over and above the work of item No. 18.38 and 18.39.

132

2.0. Mode of measurements and payment

2.1. The relevant specifications of item No. 18.38 shall be followed except that extra rate shall be paid for every subsequent coat applied over and above the rate of item No. 18.38 and 18.39.

2.2. The rate shall be for a unit of One sq. meter.

18.41. Extra over item 38 for distemping with dry distemper on ceiling and sloping roofs.

1.0. Materials and workmanship

1.1. The relevant specifications of item No. 18.38 shall be followed except that the dry distemping shall carried out on ceiling and sloping roofs of undercoats surface.

2.0. Mode of measurements & payment

2.1. The relevant specifications of item No. 18.38 shall be followed except that extra rate shall be paid for carrying outwork on ceiling/sloping roof on undecorated surface over and above the rate of item 18.38.

2.2. The rate shall be for a unit of One sq. meter.

18.42. Extra over item 39 and 40 for distemping with dry distemper on ceiling/sloping roofs.

1.0. Materials and Workmanship

1.1. The relevant specifications of item No. 18.39 shall be followed except that the work shall be carried out on ceiling/sloping roofs on decorated surfaces.

2.0. Mode of measurements and payment

2.1. The relevant specifications of item No. 18.39 shall be followed except that the extra rate shall be paid for the distemping work carried out by dry distemping on ceiling/sloping roofs with decorated surfaces over and above the raw of item N. 18.39.

2.2. The rate shall be for a unit of One sq. meter.

18.44. Distemping (two coats) with oil bound distemper of approved brand and manufacture and of required shade on undecorated wall surfaces to give an even

shade, over and including a priming coat with distemper primer of approved brand and manufacture after thoroughly brushing the surface free from mortar droppings and other foreign matter and also including preparing the surface even and sand papered smooth.

1.0. Materials

1.1. Oil bound washable distemper and primer shall be of approved brand and manufacture. The distemper shall be of required colour and shade and the same shall conform to I.S. : 428-1969.

2.0. Workmanship

2.1. Scaffolding

Where scaffolding is required, it shall be erected in such a way that as far as possible no part of scaffolding shall rest against the surface to be distempered. A properly secured and well tied suspended platform (Joola) may be used for distempering. Where ladders are used, pieces of old gunny bags shall be tied at top and bottom to prevent scratches to the walls and floors. For distempering to ceiling, proper stage scaffolding shall be erected where necessary.

2.2. Preparation of surface :

2.2.1. The undecorated surface to be distempered shall be thoroughly brushed from dust, dirt, grease, mortar dropping and other foreign matter and sand papered smooth. New plaster surface shall be allowed to dry for at least 2 months before applications of distemper.

2.2.2. All unnecessary nails shall be removed. Pitting in plaster shall be made good with plaster again with a fine grade sand paper and made smooth. A coat of distemper shall be applied over the patches. The surface shall be allowed to dry thoroughly before the regular coat of distemper is allowed. The surface affected by moulds, moss, fungi, algae lichens, efflorescence etc. shall be treated in accordance with I.S: 2395 (Part 01) 1966. Before applying distempering, any unevenness shall be made good by applying putty made of plaster of paris mixed with water on entire surface including filling up the undulation and then sand papering the same after it is dry.

2.3. Priming coat :

2.3.1. A priming coat of distemper primer of approved manufacture and shade shall be applied over the papered surface in case of new work on undecorated surface. If the distemper priming is done after the wall surface dries completely, the distemper primer shall be applied.

133

2.3.2. Application of primer shall be done as under: The primer shall be applied with a brush on the clean dry and smooth surface. Horizontal strokes shall be given first and vertical strokes shall be applied immediately afterwards. This entire operation will constitute one coat. The surface shall be finished as uniformly as possible leaving no brush marks. It shall be allowed to dry for at least 48 hours before oil bound distemper or paint is applied.

2.3.3. Oil bound distemper is not recommended to be applied within six months of the completion of wall plaster.

2.4. Preparation of oil bound distemper :

2.4.1. The distemper shall be diluted with water or any other prescribed thinner in a manner recommended by the manufacturer only. Sufficient quantity of distemper required for a days work shall be prepared.

2.5. Application of Distemper coat:

2.5.1. For undecorated surfaces, after the primer coat is dried for at least 48 hours, the surface shall be lightly sand papered to make it smooth for receiving the distemper, taking care not to rub out priming coat. All loose particles shall be dusted off after rubbing. Minimum two coats of distemper shall be applied with brushes in horizontal strokes followed immediately by vertical strokes which together shall constitute one coat. The subsequent coats shall be applied after a time interval of at least 24 hours between consecutive coats to permit proper drying of the preceding coat. The finished surface shall be even and free from patches, brush marks, distemper drops etc.

2.5.2. Sufficient quantity of distemper shall be mixed to finish one room at a time. The application of a coat in each room shall be finished in one operation and no work shall be started in any room which cannot be completed on the same day.

2.5.3. 15 cm. double bristled distemper brush shall be used. After day's work brushes shall be thoroughly washed in hot water with soap solution and hung down to dry. Old brushes which are dirty and caked with distemper shall not be used on the work.

2.6. Protective measurements : The surfaces of doors, windows, floors, articles of furniture etc. and such other parts of the buildings as are not to be distempered shall be protected from being splashed upon. Such surfaces shall be cleaned of distemper splashes if any.

3.0. Mode of measurements and payment

3.1. Priming coat of distemper primer, scraping of surface spoiled by struck roots, removal of oil and grease spots, treatment for infraction of effloresces., mould moss, fungi, algae and lichen and patch repairs to plaster shall be included in this item for which nothing extra shall be paid.

3.2. All the work shall be measured net in the decimal system as in place subject to the following limits unless otherwise stated hereinafter:

(a) Dimensions shall be measured to the nearest 0.01 m.

(b) Area in individual items shall be worked out to the nearest 0.01 sq. m. All work shall be made for ends of joints, beams, posts etc., and openings, not exceeding 0.5 sq.mt. each and no addition shall be made for reveals, jambs, soffits, sills etc. of these openings not for finish around ends of joints, beams, posts etc.

3.3. Deductions of opening exceeding 0.5 sq.m. but not exceeding 3 sq. m. each shall be made as follows and net addition shall be made for reveals, jambs, soffits etc. of these openings :

(a) When both the faces of wall are provided with same finish, deductions shall be made for one face only.

(b) When each face of wall is provided with different finish, deduction shall be made for that side of frame for doors, windows etc. on which width of reveals is less than that of the other side but no deduction shall be made on the other side. Where the width of reveals on the both the faces of wall are equal, deduction of 50% of area of opening on each face shall be made from area of finish.

(c) When only one face of wall is treated and the other face is not treated, full deductions shall be made if the width of the reveal on treated side is less than that on untreated side but if the width of the reveal is equal or more than that on untreated side neither deductions nor additions to be made for reveals, jambs, soffits, sills etc.

3.4. In case of opening of area exceeding 3 sq. m. each deduction shall be made for openings but jambs, sills and soffits shall be measured.

134

3.5. No deductions shall be made for attachments such as casings, conduits, pipes, electric wiring and the like.

3.6. Item includes removing nails, making good holes, patches with materials similar in composition of distemper.

3.7. The rate includes cost of all materials, labours, scaffolding, protective measures etc. involved in all the operations described above. This shall also include conveyance, delivery, handling, unloading, storing work etc

2.8. The rate shall be for a unit of one sq. meter

18.45. Distemping (two coats) with oil bound washable distemper of approved brand and manufacture and of shade required on undecorated wall surfaces to give an even shade, over and including a priming coat with alkali resistance primer of approved brand and manufacture after thoroughly brushing the surface free from mortar droppings and other foreign matter and also including preparing the surface even and sand papered smooth.

1.0. Materials and Workmanship

1.1. The relevant specifications of item No. 13.44 shall be followed except that the primer of alkali resistance primer of approved brand and manufacture shall be used instead of distemper primer.

2.0. Mode of measurements and payment

2.1. The mode of measurements and payment shall be the same as for item No. 18.44 above.

2.2. The rate shall be for a unit of One sq. meter.

18.46. Distemping (one coat) with oil bound washable distemper of approved brand of required shade on decorated wall surfaces to give an even shade after thoroughly brushing the surfaces clean of all grease, dirt, loose pieces of scales and also including distemping with oil bound washable distemper of preparing the surface even and smooth.

1.0. Materials and Workmanship

The relevant specifications of item No. 18.44 shall be followed except that the distemping with oil bound washable distemper shall be carried out on decorated wall surfaces in one coat.

2.0. Mode of measurement and payment

2.1. The relevant specification of item No. 18.44 shall be followed.

2.2. The rate shall be for a unit of one sq meter.

18.47. Extra over item 18.44 to 18.46 for every subsequent coat of distemping with oil bound washable distemper of approved brand and manufacture.

1.0. Materials and Workmanship

1.1. The relevant specifications of item No. 18.44 shall be followed except that this work is for providing extra coat of oil bound distemping over and above two coats of distemping.

2.0. Mode of measurements and payment

2.1. The relevant specification of item No. IS K shall be followed except that the extra rate shall be paid over and above the rate for every subsequent coats over two coats of item 18.44 and 18.46.

2.2. The rate shall be for a unit of one sq. meter.

18.48. Extra over item 18.44. and 18.45 for distemping with oil bound washable distemper on ceiling and sloping roofs.

1.0. Materials and Workmanship

The relevant specifications of item No. 18.44 shall be followed except that the distemping shall be carried out on ceiling/sloping roofs.

2.0. Mode of measurements and payment

2.1.1. The relevant specifications of item No. 18.44 shall be followed except that the extra rate shall be paid for carrying out distemping work on ceiling/sloping roofs over and above the rate of item No. 18.44 and 18.45.

2.2. The rate shall be for a unit of one sq. meter.

18.49. Extra over item 18.46 and 18.47 for every subsequent coat of distemping on ceiling and sloping roofs.

135

1.0. Materials and Workmanship

1.1. The relevant specifications of item No. 18.44 shall be followed except that the distemping work shall be carried out for subsequent coats over item No. 18.46 and 18.47.

2.0. Mode of measurements and payments

2.1. The relevant specifications of item No. 18.46 shall be followed except that the extra rate shall be paid for every subsequent coat of distemper applied over and above the rate of item No. 18.46 and 18.47.

18.51. Finishing wall with water proofing cement paint of an undecorated wall surfaces (two coats) to give an approved brand and manufacture and of required shade, even shade after thoroughly brushing the surface to remove.

1.0. Materials

1.1. The water shall conform to M-1. Cement water proofing paint shall conform to I.S. 5410-1969.

2.0. Workmanship

2.1. Scaffolding : The relevant, specifications of item No. 18.11 shall be followed.

2.2. Preparation of surface :

The relevant specifications of item No. 18.11 shall be followed except that the word white wash colour wash shall be substituted with water proofing cement paint. The surface shall be thoroughly wetted with clean water before cement water proofing paint is applied.

2.3. Preparation of paint: Portland cement paint shall be prepared by adding paint powder to water and stirring to obtain a thick paste, which shall then be diluted to a brush able consistency. Generally, equal volumes of paint powder and water make a satisfactory paint. In all cases, The manufacture's instructions shall Site followed. The paint shall be mixed in such quantities as can used up within an hour of mixing as otherwise the mixture will set and thickness, affecting flowing and finish. The lids of cement paint drums shall be kept tightly when not in use.

2.4. Application of Paint:

2.4.1. No painting shall be done when the paint is-likely to be exposed to a temperature of below 7^oc within 48 hours after application.

2.4.2. When weather conditions are such as to cause be carried out in the shadow as far as possible. This helps the proper hardening of the paint film by keeping the surface moist for a longer period.

2.4.3. To maintain the uniform mixture and to prevent segregation, the paint shall be stirred frequently in the bucket.

2.4.4. For undecorated surfaces, the surface shall be treated with minimum two coats of water proof cement paint. Not less than 24 hours shall be allowed between two coats. Next coat shall not be started until the proceeding coat has become sufficiently hard to resist marking by the brush being used. In hot dry weather, the proceeding coat shall be slightly moistened before applying the subsequent coat.

2.4.5. The finished surface shall be even and uniform in shade, without patches, brush masks, paint drops etc.

2.4.6. The cement paint shall be applied with a brush with relatively short stiff hog or fiber bristles. The paint shall be brushed in uniform thickness and shall be free from excessively heavy brush marks. The lamps shall be brushed out.

2.4.7. Water proof cement paint shall not be applied on surface already treated with white wash, colour wash, distemper dry or oil bound varnishes, paint etc. It shall not be applied on gypsum, wood and metal surfaces.

2.5. Curing : Painted surfaces shall be sprinkled with water two or three times a day. This shall be done between coats and for at least two days following the final coat. The curing shall be started as soon as the point has hardened so as not be damaged by the sprinkling of water say about 12 hours after the application.

2.6. Protection measures shall be taken as per item No. 18.11 Para 2.6.

3.0. Mode of measurements and payment

3.1. The relevant specifications of item No. 18.11. shall be followed.

3.2. The rate shall be for a unit of One sq. meter.

136

18.53. Extra over item 18.51 for every subsequent coat of water proofing cement paint of approved brand and manufacture.

1.0. Materials and Workmanship

1.1. The relevant specifications of item No. 18.51 shall be followed except that the work is for applying subsequent coat of cement water proofing paint.

2.0. Mode of measurements and payment

2.1. The relevant specifications of item No. 18.51 shall be followed except that the extra rate shall be paid for applying every subsequent coat of cement water proofing paint over and above the rate of item No. 18.51.

2.2. The rate shall be for a unit of One Sq. meter.

18.54. Extra over item 18.51 for finishing with cement paint on ceiling/sloping roofs.

1.0. Materials and Workmanship

1.1. The relevant specifications of item No. 18.51 shall be followed except that the cement water proofing paint shall applied on ceiling and sloping roofs.

2.0. Mode of measurements and payment

2.1. The relevant specifications of item No. 18.51 shall be followed except the extra shall be paid for applying cement water proofing paint on ceiling and sloping roofs, over and above the rate of item No. 18.51.

2.2. The rate shall be for a unit of One sq. Meter.

18.56. Extra over 18.53 for every subsequent coat of finishing with cement paint on ceiling and sloping roofs.

1.0. Materials and Workmanship

1.1. The relevant specification of item No. 18.51 shall be followed except that the work shall be carried out for subsequent coat on ceiling and sloping roofs.

2.0. Mode of measurements and payment

2.1. The relevant specifications of item No. 18.53. shall be followed except that extra rate shall be paid for every subsequent coat applied with cement water proofing paint over and above the rate of item No. 18.53.

18.57. Wall painting (two coats) with plastic emulsion paint of approved brand of manufacture on undecorated wall surfaces to give an even shade including thoroughly brushing the surface free from mortar droppings and other foreign matter and sand paper smooth.

1.0. Materials

Water shall be conform M-1. The plastic emulsion shall conform to I.S.: 5411-1969 (part-I).

2.0. Workmanship

2.1. Scaffolding : The relevant specifications of item-No. 18.11 Para 2.1 shall be followed.

2.2. Preparation of surface : The relevant specification of item No. 18.44 Para 2.2 shall be followed.

2.3. Preparation of Mix :

This shall be done as per manufacture's instructions. The thinning of emulsion is to be done with water and not with turpentine. The quantity of thinner to be added shall be as per manufacturer instructions.

2.4. Application :

2.4.1. Before pouring into small containers for use, the paint shall be stirred thoroughly in item container. When applying also, the paint shall be continuously stirred in the smaller container, so that its consistency is kept uniform.

2.4.2. The paint shall be laid on evenly and smoothly by means of crossing and laying off the crossing and consist of covering the area over with paint, brushing the surface hard for the first time over and then, brushing alternately in opposite direction two or three times and then finally brushing lightly in direction at right angles to the same. In this process, no brush Marks shall be left after the laying off is finished. No hair marks from the brush or clogging of paint puddles in the corners of panels, angles of moldings, etc. shall be left on the work. The full process of crossing and laying off will constitute one coat.

2.4.3. The paint shall be applied with brush or rollers. For undecorated surfaces, the surface shall be treated with minimum two coats of cement water proofing paint. The second or subsequent coat shall not

137

be started until the proceeding coat as become sufficiently hard to resist marking by brushing being used.

2.4.4. The surface on finishing shall present a flat velvety smooth finish. It shall be even and uniform in shade without patches, brush marks, paint drops etc.

2.5. Precautions :

(a) Old brushes if they are to be used with emulsion paints, shall be completely dried of turpentine or oil paint by washing in warm soap water. Brushes shall be quickly washed in water immediately after use and kept immersed in water fusing break periods to prevent the paint from hardening on the brush.

(b) In the preparation of wall for plastic emulsion painting, no oil base petals shall be sued in filling cracks, holes etc.

(c) Splashes on floors etc. shall be cleaned out without delay as they will be difficult to remove after hardening.

(d) Washing or surfaces treated with emulsion paint shall not be done within 3 to 4 weeks of application

2.6. Protective payment : The relevant specifications of item No. 18.11 shall be followed.

3.0. Mode of measurements and payment

3.1. The relevant specifications of item No. 18.11 shall be followed.

3.2. The rate shall be for a unit of One sq. meter.

18.59. Extra over item No. 18.57 for every subsequent coat of wall painting with plastic emulsion paint of approved brand.

1.0. Materials and Workmanship

1.1. The relevant specifications of item No. 18.57 shall be followed except that the painting work shall be for subsequent coat of plastic emulsion paint.

2.0. Mode of measurements and payment

2.1. The relevant specifications of item No. 18.57 shall be followed except that the extra payment shall be done on ceiling and sloping roofs.

2.2. The rate shall be for a unit of One sq. meter.

18.60. Extra over item 18.57 for painting with plastic emulsion paint of approved brand on ceiling and sloping roofs.

1.0. Materials and Workmanship

1.1. The relevant specifications of item No. 18.57 shall be followed except that the painting shall be done on ceiling and sloping roofs.

2.0. Mode of measurements and payment

2.1. The relevant specifications of item No. 18.57 shall be followed except that the extra payment shall be made for applying plastic emulsion paint on ceiling and sloping roofs over and the rate of item No. 18.57.

2.2. The rate shall be for a unit of One sq. meter.

18.62. Extra over item 18.59 for paint ceiling and sloping roofs.

1.0. Materials and Workmanship

1.1. The relevant specifications of item No. 18.57 shall be followed except that the work for subsequent coat of plastic emulsion paint shall be carried out on ceiling and sloping roofs.

2.0. Mode of measurements and payment

2.1. The relevant specifications of item No. 18.57 shall be followed except that the extra rate shall be paid for carrying out painting on sloping roofs and ceiling with plastic emulsion paint over and above the rate of item No. 18

59

2.2. The rate shall be a unit of One sq. meter.

138

SECTION-19

Paintings & Polishing

19.7. Painting two coats (excluding priming coat) on new steel and other metal surfaces with

enamel paint, brushing, interior to give an even shade including cleaning the surface of all dirt, dust and other foreign matter.

1.0. Materials

The enamel paint shall conform to M-44 B.

2.0. Workmanship

2.1. General : The materials required for work of painting work shall be obtained directly from approved manufactures or approved dealer and brought to the site in maker's drums; kegs. etc. with seal unbroken.

2.1.2. All materials not in actual use shall be kept properly protected, lids of containers shall be kept closed and surface of paint in open or partially open containers covered with a thin layer of turpentine to prevent formation of skin. The materials which have become state or flat due to improper and long storage shall not be used. The paint shall be stirred thoroughly in its container before pouring into small containers. While applying also, the paint shall be continuously stirred in smaller container. No left over paint shall be put back into stock tins. When not in use the containers shall be kept properly closed.

2.1.3. If for any reasons, things is necessary, the brand of thinner recommended by the manufacturer shall be used.

2.1.4. The surface to be painted shall be thoroughly cleaned and dusted. All rust, dirt and grease shall be thoroughly removed before painting is started. No painting on exterior or other exposed part o the work shall be carried out in wet, damp or otherwise unfavorable weather and all the surfaces shall be thoroughly dry before painting work is started.

2.2. Application of paint:

2.2.1. Brushing operations are to be adjusted to the spreading capacity advised by the manufacture of particular paint. The paint shall be applied evenly and smoothly by means of crossing and laying off. The crossing and laying off consists of covering the area over with paint, brushing the surface hard for the first time over and then brushing alternately in opposite directions two or three times and then finally brushing lightly in a direction at right angles to the same. In this process, no brush marks shall be left after the -laying off is finished. The full process of crossing and laying off will constitute one coat.

2.2.2. Each coat shall be allowed to dry completely and lightly rubbed with very fine grade of sand-paper and loose particles brushed off before next coat is applied. Each coat shall vary slightly in shade and shall be got approved from Engineer-in-charge before next coat is started.

2.2.3. Each coat the last shall be lightly rubbed down with sand paper of fine pumice stone and cleaned of dust before the next coat is applied. No hair marks from the brush of clogging of paint puddles in the corners of panels, angles of moldings etc. shall be left on the work.

2.2.4. Special care shall be taken while painting over bolts, nuts, rivets, overlaps etc. Approved best quality brushes shall be used.

3.0. Mode of measurements and payment

3.1. The relevant specifications of item No. 19.12 shall be followed for mode of measurements and payment. The rate is excluding priming coat.

3.4. The rate shall be for a unit of One sq. meter.

19.15. Extra over item No. 19.7 and 19.11 for every subsequent coat of paint.

1.0. Materials and Workmanship

1.1. The relevant specifications of item No. 19.7 shall be followed except that the work of painting shall be carried out for subsequent coat.

2.0. Mode of measurements and payment

2.1. The relevant specifications of item No. 19.7 shall be followed except that the extra rate shall be paid for every subsequent coat of paints applied over and above the rate of item No. 19.7 and 19.11.

2.2. The rate shall be for a unit of One sq. meter.

139

19.11. Painting one coats Excluding priming coat) on previously painted steel and other metal surface with enamel paint, brushing to give an even shade including cleaning the surface of all dirt, dust and other foreign matter.

1.0. Materials and Workmanship'

1.1. The relevant specification of item No 19.7 shall be followed except that painting shall be carried out in one coat with enamel paint on previously painted steel and metal surface.

2.0. Mode of measurements and payment

2.1. The relevant specifications of item No, 19.7 shall be followed.

2.2. The rate shall be for a unit of one sq. meter.

19.12. Applying priming coat over new steel and other metal surfaces after and including preparing the surface by thoroughly cleaning oil, grease, dirt and other foreign matter and secured with brushes, fine steel, wool scrapers and sand paper, with ready mixed priming paint, brushing red lead.

1.0. Materials

1.1. The ready mixed primer, brushing red shall conform to I.S. 102-1962.

1.2. The thinner (linseed oil) shall conform to I.S. 75-1973. If for any reason, thinning is necessary *m* case of ready mix paint the brand of thinner recommended by manufacture shall be used.

2.0. Workmanship

2.1. Preparation of surfaces : The surfaces painting shall be cleaned of all rust, scale, dirt and other foreign matter sticking to it with wire brushes, steel wool, scrapers, sand paper etc. This surface shall then be wiped finally

with mineral turpentine which shall also remove grease and perspiration of hand marks. The surface shall then be allowed to dry.

2.2. Application of primer :

2.2.1. After the preparation of the surface, the priming coat shall be applied immediately. The brushing operations are to be adjusted to the spreading capacity advised by the manufacturer of the particular primer. The paint shall be applied evenly and smoothly by means of crossing and laying off. The crossing and laying off consists of covering the area over with paint, brushing alternately in opposite directions, two or three times and then finally brushing lightly in a direction at right angles to the same. In this process, no brush marks shall be left after the laying off is finished. The full process of crossing and laying off shall constitute one coat.

2.2.2. During painting, every time, after the priming coat has been worked out of the brush bristles or after the brush has been unloaded, the bristles of the brush shall be opened up by striking the brush against portion of the unpainted surface with the end of the bristles, held at right angles to the surface, so that bristles thereafter will collect the correct amount of paint when dipped again in to a paint container. The prima/y coat shall be allowed to dry completely before painting is started.

2.2.3. No hair marks from the brush or clogging at paint puddles in the corner of panels angles of molding etc. shall be left on the work

2.2.4. Special care shall be taken while painting over bolts, nuts, rivets, overlaps etc.

2.2.5. The container when not in use shall be kept close and free from air so that paint does not thicken and also shall be kept guarded from dust.

3.0. Mode of measurements & payment

3.1. The new steel and other metal surface shall be measured under this item.

3.2. All the work shall be measured net in the decimal system, as executed subject to the following limits unless otherwise stated hereinafter.

(a) Dimensions shall be measured to the nearest 0.01 meter.

(b) Areas shall be worked out to the nearest 0.01 sq. meter.

3.3. No deductions shall be made for openings not exceeding 0.5 sq. mt. each and no addition shall be made for painting to beddings, moldings, edges, jambs, soffits, sills etc. of such opening.

3.4. In case of fabricated structural steel and iron work, priming coat of paint shall be included with
140

frabation. In case of trusses if measured in sq. m. compound girders, stanchions, lattices, grader and similar work, actual area shall be measured in sq. m. and no extra shall be paid for painting on bolts heads, nuts, washers etc. No addition shall be made to the weight calculated for the purpose of measurements of steel and iron works for paint applied on shop or at site.

3.5. The different surfaces shall be grouped into one general item, areas of uneven surfaces being converted into equivalent plain areas in accordance with the table given as per Annexure-II for payment.

3.6. The rate shall be for a unit of One sq. meter.

19.19. Painting two coats (excluding priming coat) on new steel and other metal surfaces with synthetic enamel paints, brushing to give an even shade including cleaning the surface of all dirt, dust and other foreign matter.

1.0. Materials

Synthetic enamel paint shall conform to I.S. 1932-1964.

2.0. Workmanship

2.1. The relevant specifications of item No. 19.7 shall be followed except that the painting shall be carried out with synthetic enamel paint.

3.0. Mode of measurements & payment

3.1. The relevant specifications of item No. 19.7 shall be followed.

3.2. The rate shall be for a unit of One sq. meter.

19.21. Painting one coat (excluding priming coat) on previously painted steel and other metal surfaces with synthetic enamel paint brushing to give an even shade including cleaning the surface of all dirt, dust and other foreign matter.

1.0. Materials and Workmanship

2.1. The relevant specifications of item No. 19.19 shall be followed except that the painting shall be carried out on previously painted steel and other metal surfaces using synthetic enamel paint in one coat.

2.0. Mode of measurements and payment

2.1. The relevant specifications of item No. 19.19 shall be followed.

2.2. The rate shall be for a unit of One sq. meter.

19.13. Extra over item No. 19.19 and 19.21 for every subsequent coat of paint.

1.0. Materials and Workmanship

1.1. The relevant specifications of item No. 19.19 shall be followed except that the extra rate shall be paid for out for subsequent coat of paint.

2.0. Mode of measurements & payment

2.1. The relevant specifications of item No. 19.19 shall be followed except-that the work shall be paid for applying subsequent coat of oil paint over and above the item No. 19.19 and 19.21.

19.50.(B) Painting two coat (excluding priming coat) on external of new rain water, soil, waste and vent pipe and fittings with ready mixed bituminous paint, brushing, black anticorrosive to give an even shade including cleaning of all dirt, dust and other foreign matter (75 mm. dia.)

1.0. Materials

1.1. Ready mixed bituminous pain shall conform to I.S. 158 : 1968.

2.0. Workmanship

2.1. The relevant specifications of item No. 19.7 shall be followed except that the paining work of external surfaces of 75 mm. dia rain water pipe, soil, waste, and vent pipe and fittings with ready mixed bituminous paint snail be earned out.

3.0. Mode of measurements and payment

3.1. The rate is excluding the cost o priming coat but including painting of all fittings coming in line.

3.2. The rate shall be for a unit of one running meter,

19.50.(C) Painting two coats (excluding priming coat) on external of rain water, soil, waste and vent pipe and fittings with ready mixed bituminous paint brushing black anticorrosive to give an even shade including cleaning off all dirt, dust and other foreign matter : 100 mm. dia.

141

1.0. Materials & Workmanship

1.1. The relevant specifications of item No. 19.50 (B) shall be followed except that the pipes to be painted on is 100 mm. dia. meter.

2.0. Mode of measurements & payment

2.1. The relevant specifications of item No. 19.50(B) shall be followed. The rate is excluding the cost of priming coat but including cost of painting all fittings coming in line.

2.2. The rate shall be for a unit of one running meter.

19.59.(B) Applying priming coat over wood and wood based surfaces after and including preparing the surface by thoroughly oil, grease, dirt and other foreign matter, sand papering and knotting : Ready mixed paint, brushing wood primer pink.

1.0. Materials

1.1. The ready mixed paint, brushing, wood primer pink shall conform to I.S. 3536-1966

2.0. Workmanship

2.1. Preparation of Surfaces :

2.2.1. AH wood work shall be dry and free from any foreign matter incidental to building operations. Nails shall be punched well below the surface to provide a film key for stopping. Moldings shall be carefully smoothed with abrasive paper and projecting fibers shall be removed. Flat portions shall be smoothed off with abrasive paper used across the grain prior to painting prior to painting and with the grain prior to staining or if the wood is to be left in its natural colour, wood work which is to be stained may be smoothed by scraping instead of by glass papering if so required.

2.2.2. Any knots, resinous, streaks or bluefish sap wood that are not large enough to justify cutting out shall be treated with two coats of pure shellac knotting applied thinly and extended about 25 mm. beyond the actual area requiring treatment.

2.2. Application of primer :

2.2.1. The relevant specifications of item No. 19.12(A) shall be followed for application of primer.

3.0. Mode of measurements & payment

3.1. The relevant specifications of item No. 19.12 shall be followed except that work done on wood and wood based surfaces shall be paid under this item.

3.2. The rate shall be for a unit of One sq. meter.

19.59.(D) Applying priming coat over new wood and wood based surface after and including preparing the surface by thoroughly cleaning oil, grease, dirt and other forging matter sand papering and knotting : Ready mixed paint brushing priming, for enamel.

1.0. Materials

1.1. The ready mixed paint for brushing priming for enamels wood shall conform to I.S. 106-1962.

2.0. Workmanship

2.1. The relevant specifications of item No. 19.59 (B) shall be followed except that ready mixed paint brushing priming for enamel shall be used instead of ready mixed paint brushing wood primer pink.

3.0. Mode of measurements and payment

3.1. The relevant specifications of item No. 19.12 shall be followed.

3.2. The rate shall be for a unit of One sq. meter.

19.62.(B) Extra over item 59.59 (B) for every subsequent coat of priming coat. Ready mix paint, brushing wood primer work.

1.0. Materials and workmanship

1..1. The relevant specifications of item No. 19.59 (B) shall be followed except that the painting work shall be carried out with ready mix paint instead of wood primer pink for subsequent coat.

2.0. Mode of measurements and payment

2.1. The relevant specifications of item No. 19.59 (B) shall be followed except that the extra rate shall be paid for every subsequent coat applied with Ready mix paint, brushing wood primer pink over and above the rate of item No. 19.59 (B).

142

19.62.(D) Extra over item No. 19.59 for every subsequent coat of priming coat ready mix paint brushing priming for enamel.

1.0. Materials & Workmanship

1.1. The relevant specifications of item No. 19.59(D) shad be followed except that the painting work shall be

carried out with ready mix paint brushing priming for enamel.

2.0. Mode of measurements and payment

2.1. The relevant specifications of item No. 19.59(D) shall be followed except that the extra rate shall be paid for every subsequent coats of priming coat with ready mixed paint, brushing priming for enamel.

2.2. The rate shall be for a unit of One sq. meter.

19.71. Painting two coats (excluding priming coat) on new wood and wood based surfaces with enamel paint interior to give an even shade including the surface off all dist, dust and other foreign matter and papering and stopping.

1.0. Materials

1.1. The enamel paint shall conform to I.S. 133-1975.

2.0. Workmanship

2.1. The relevant specifications of 19.7 shall be followed for general and application of paint, except that the enamel paint shall be used for painting on new wood/wood based surfaces.

2.2. In painting doors and windows, the putty, round the glass panes also be painted but care shall be taken to see that no paint, stain etc. are left on the glass. Top of shutters and surfaces in similar hidden locations shall not be left out in painting.

3.0. Mode of measurements and payment

3.1. The relevant specifications of item No. 19.12 shall be followed, for mode of measurements and payments. The rate excludes cost of priming coat.

3.2. The rate shall be for a unit One sq. meter.

19.73. Painting one coat (excluding priming coat) on previously painted wood and wood based surfaces with enamel paint to give even shade including cleaning of all dirt, dust and other foreign matter.

1.0. Materials and Workmanship

1.1. The relevant specifications of item No. 19.71 shall be followed except that the painting work shall be carried out on previously painted wood and wood based surfaces with enamel paint to give even shade in one coat.

2.0. Mode of measurements and payment

2.1. The relevant specifications of item No. 19.7t shall be followed

2.2. The rate shall be for a unit of One sq meter.

19.75. Extra over item 19.71 arid 19.73 for every subsequent coat of paint.

1.0. Materials and Workmanship

1.1. The relevant specifications of item 19.71 shall be followed except that painting work shall be for subsequent coat with paint.

2.0. Mode of measurements and payment

2.1. The relevant specifications of item No. 13.71 shall be followed except that the extra rate shall be paid.

2.2. The rate shall be for a unit of One sq. meter.

19.77. Painting two coats (excluding priming coat) on new wood and wood based surfaces with ready mixed paint brushing, oil gloss, semi-gloss, to give an even shade including cleaning of all dust, dirt and other foreign matter sand papering and stopping.

1.0. Materials

The ready mixed paint shall conform to M-44. The ready mixed paint brushing gloss, semi-gloss shall conform to KS. 129-1962 and I.S. 117-1364.

2.0. Workmanship

2.1. The relevant specification of item 19.71 shall be followed for general and application of paint, except that ready mixed paint brushing, oil gloss and semi-gloss shall be used of approved colour and shade instead of enamel paint.

143

3.0. Mode of measurements and payment

3.1. The relevant specifications of item 19.12 shall be followed for measurements and payment. The rate excludes cost of priming coat.

3.2. The rate shall be for a unit of One sq. meter.

19.84. Varnishing two coats (excluding priming coat) on new wood and wood based surfaces undercoating with flatting varnish and finishing coat with varnish to give an even surface cleared of all dirt, dust and sand papering so as to produce a smooth dry surface.

1.0. Materials

The varnish shall conform to I.S. 338-1962.

2.0. Mode of measurements & payment

2.1.1. The surface to be varnished shall be prepared to produce a smooth, dry neat surface. The previous coat of paint, if any shall be allowed to dry and rubbed down slightly whipped off and allowed to dry.

2.1.2. "The operation of varnishing calls for careful attention to cleanliness. A? dust and dirt shall be removed from the surface to be varnished and also from the neighborhood. If surfaces are dampened to avoid razing of dust, they shall be allowed to dry thoroughly before varnishing is commenced. Damp Exposure to extreme of heat or cold, or to a damp atmosphere will spoil the work.

2.1.3. In handling and applying varnish care should be taken to avoid forming forth or air bubbles. Brushes and containers shall be kept scrupulously clean.

2.2. Application

2.2.1. The varnish shall be applied liberally with a brush an spread evenly over a portion of the surface with a

short light strokes to avoid froth in. It shall be allowed to flow out while the next section is being laid in. Excess varnish then be scrapped out of the brush and the first section be crossed, re crossed and the laid of lightly. Two much or too little varnish left on the surface will mar the appearance of the finish. The varnish, once it has begun to set, shall not be retouched. If a mistake is made, the varnish shall be removed and the work started afresh.

2.2.2. In case of two coats of varnish work, the first shall be hard drying, under coating or flattening varnish, this shall be allowed to dry hard and then be flattened down before applying the finishing coat. If two coats are applied, sufficient time shall be allowed between two coats.

2.2.3. When flat varnish is used for finishing a preparatory coat of hard drying under coating or flattening varnish shall be first applied and shall be allowed to harden thoroughly, it shall then be lightly rubbed down before the flat varnish is applied. Section of the work such as panels, shall be cut in clearly, so as to avoid any overlapping during applications, as this is likely to impart some measure, of gloss to partially dried area, worked up in lapping. On larger area the flat varnish shall be applied rapidly and the edges of each patch applied shall not be allowed to set but shall be followed up whilst in free working conditions-

3.0. Mode of measurements & payment

3.1. The relevant specifications of item 19.71 shall be followed.

3.2. The rate shall be for a unit of One sq. meter.

13.86. Extra over item No. 19.84 for every subsequent coat of varnish.

1.0. Materials and Workmanship

1.1. The relevant specifications of item No. 19.84 shall be followed except that the work shall be for subsequent coat of varnishing.

2.0. Mode of measurements & payment

2.1. The relevant specifications of item 19.84 shall be followed except that the extra rate shall be paid for every subsequent coat of varnishing done over and above the rate of item No. 19.84.

2.2. The rate shall be for a unit of One sq. meter.

19.87. Polishing with polish on new wood and wood based surface to give an even surface including cleaning the surface of all dirt, dust and sand papered smooth and including a coat of wood filler

1.0. Materials

1.1. The French polish required tint and shade shall be prepared with the below mentioned ingredients and other necessary materials : (i) Chandra (ii) Shellac (ic) Pigment. The French polish so prepared shall conform to I.S. 348-1968.

144

2.0. Workmanship

2.1. Preparation of surface :

2.1.1. All unevenness shall be rubbed down to smoothness with sand paper and the surface shall be well dusted. The proper in the wood shall be filled up with a filler made of a paste of whiting in water or methylated spirit (with a suitable pigment like burnt sienna or umber if required) : otherwise the French polish will get absorbed and a good gloss will be difficult to obtain.

2.2. Application

2.2.1. A pad of wooden cloth covered by a fine cloth shall be used to apply the polish. The pad shall be moistened with polish and rubbed hard on the surface in a series of overlapping circles applying the polish sparingly but uniformly over the entire area to give an even surface. A trace of linseed oil on the face of the pad may be added which shall facilitate this operation. The surface shall be allowed to dry and the remaining coats applied in the same way. To finish off, the pad shall be covered with a fresh piece of clean fine cloth, slightly dampened with methylated spirit and rubbed lightly and quickly with circular motions. The finished surface shall present a uniform texture and high gloss.

3.0. Mode of measurements and payment

3.1. The relevant specification of item 19.12 shall be followed for mode of measurements and payment.

3.2. The rate includes cost of wood filler etc. complete.

3.3. The rate shall be for a unit of One sq. meter.

19.88. Polishing with French polish on previously polished wood and wood based surface to give an even surface including cleaning the surface of all dirt, dust and sand papered smooth including a coat of wood filler.

1.0. Materials & Workmanship

1.1. The relevant specifications of item No. 19.87 shall be followed that the French polish shall be applied on previously polished wood and wood based surface.

2.0. Mode of measurements and payment

2.1. The relevant specifications of item No. 19.87 shall be followed.

2.2. The rate shall be for a unit of One sq. meter.

19.91. Applying wax polish on new Wood work and wood based surfaces with bees wax polish in proportion 2 : 1.5 : 1 : 0.5 (2 Bees Wax : 1.5 linseed oil: 1 Turpentine oil : 0.5 Varnish by weight) by give an surface including cleaning the surface of all dirt, dust and sand papered smooth.

1.0. Materials

Bee's Wax shall conform to I.S. : 1504-1968. Linseed oil shall conform to I.S. : 75-1967. Turpentine shall conform to I.S. 83-1950. Varnish shall conform in I.S. 337-1952.

2.0. Workmanship

2.1. Preparation of bees wax :

2.1.1. In case of, bees wax it shall be prepared locally with following specification.

2.1.2. Pure bees wax free from paraffin or strain adulterants shall be used. The polish shall be prepared from mixture of bees wax, linseed oil, turpentine, and varnish in proportion 2:1:5:1:0.5 by weight. The bees wax and boiled linseed oil shall be heated on a slow fire, when the wax is completely dissolved the mixture shall be cooled till it is just warm and turpentine and varnish added to it in the required proportions and entire mixture shall be well stirred.

2.2. Preparation of surfaces .

2.2.1. The surface to be waxed shall be prepared to produce a smooth, dry, matt surface. Previous coat of paint or stain if any shall be allowed to dry and be rubbed down lightly wiped off and allowed to dry all dust and dirt shall be removed from the surface to waxed and also from the neighborhood. Damp atmosphere and draughts shall be avoided, for waxing, normal dry day shall be chosen.

2.3. Application :

2.3.1. The polish shall be applied evenly with clean soft pad of cotton cloth in such a way that the surface is completely and fully covered. The surface shall then be rubbed continuously for half an hour. After well rubbing in one coat of wax polish, the work shall be covered with dust proof sheet. (Cloth for preventing dust falling on the work). Subsequent coat shall be applied after the surface is quite dry and shall be rubbed off with soft flannel until the surface has assumed a uniform gloss and in dry showing no sign of stickiness.

145

2.3.2. The final polish depends on the amount of rubbing which shall be continuous and with uniform pressure with frequent changes in the direction.

3.0. Mode of measurements & payment

3.1. The relevant specifications of item No. 19.12 shall be followed.

3.2. The rate shall be for a unit of One sq. meter.

19.92. Applying wax polish on previous wax polished wood and wood based surfaces with bees wax polish in proportion of 2:1.5:1:0.5 (2 Bees wax 1.5 linseed oil : 1 Turpentine : 0.5 Varnish by weight) to give an even surface including cleaning the surface of all dirt, dust and sand papered smooth.

1.0. Materials and workmanship

1.1. The relevant specifications of item No. 19.91 shall be followed except that the wax polishing shall be carried out on previously wax polished wood and wood based surfaces with bees wax polish.

2.0. Mode of measurements and payment

2.1. The relevant specifications of item No. 19.91 shall be followed.

2.2. The rate shall be for a unit of One sq. meter.

19.98. Coat tarring two coats on new wood and wood based surfaces using 0.15 and 0.12 liters of coal tar per sq. m. in the first and second coat respectively to give an even shade including cleaning of all dirt, dust and other foreign matter ;

1.0. Material : The coal tar shall conform to I.S. 290-1961.

2.0. Workmanship

2.1. 200 cms. of unslaked lime shall be added to every liter of coal tar and heated till it begins to boil. It shall then be taken off the fire and kerosene oil added to it slowly the rate of 1 part kerosene oil and 6 parts or more parts of coal tar by volume and stirred thoroughly. The addition of lime is for preventing the tar from running.

2.2. Preparation of Surface :

2.2.1. The surface to be painted shall be allowed to dry sufficiently. Any existing fungus or mould growth shall be completely removed. All major cracks or defects in the plaster shall be cut out and made good. Before primer is applied holes and undulations shall be filled up with plaster of paris and rubbed smooth.

2.3. Application of paint:

2.3.1. The coat tar shall be applied as per relevant specifications of applying mixed paint item No. 19.7 except coat tarring is used instead of enamel paint.

3.0. Mode of measurements & payment

3.1. The relevant specifications of item No. 19.12 shall be followed.

3.2. The rate shall be for a unit of One sq. meter.

19.119.(I) Writing letter of figures on any surface with black Japan paint (stops, commas, hyphens and the like not to be measured and paid for separately) : block (Letters/figures).

1.0. Materials

1.1. Ready mixed the black Japan paint shall conform to I.S. 341-1952.

2.0. Workmanship

2.1. The letters and figures shall be to the heights and widths as per approved drawings or as directed. These shall be stenciled or drawn in pencil and got approved before painting. They shall be of uniform size and finished neatly. The edges shall be straight or in pleasant smooth curves,

3.0. Mode of measurements and payment

3.1. Letters, figures and similar items etc. stops, commas, hyphens and the like shall be deemed to be included in the item. 9

3.2. The rate per cm. height of letter shall hold good irrespective of width of the letters of figures or the thickness of the lettering.

3.3. The rate shall be for a unit of per letter cm. height.

19.119(II) Writing letter of figure? on any surface with black Japan paint (stops, commas, hyphens and

the like not to be measured and paid for separately ; Indian (Letters/figures).

146

1.0. Materials and Workmanship

The relevant specifications of item No. 19.119 (I) shall be followed except the writing of letter shall be Indian letters/figures.

2.0. Mode of measurements and payment

2.1. The relevant specifications of item No. 19.119 (I) shall be followed.

2.2. The rate shall be for a unit of per letter per cm. height.

19.126(1) Painting lines, dashes, arrows, letters etc. on roads, airfields and like in two coats with road marking paint, brushing including cleaning the surface of all dirt, dust and other foreign matter : Over 10 cms. in width.

1.0. Materials

1.1. The road marking paint shall conform to. I.S. 164-1951.

2.0. Workmanship

2.1. The relevant specifications item No. 19.119(1) shall be followed except that the painting lines, dashes, arrows and letters on roads, air fields and like shall be carried out with road marking paint in two coats : over 10 cms. in width.

3.0. Mode of measurements and payment

3.1. The relevant specifications of item No. 19.119 (I) shall be followed.

3.2. The rate shall be for a unit of One sq. meter.

19.126.(II) Painting lines, dashes, arrows, letters etc. on roads, fields and like in two coats with road marking paint brushing including cleaning the surface of all dirt, dust and other foreign matter: Up to 10 cms. in width.

1.0. Materials and Workmanship

1.1. The relevant specifications of item No. 19.126 (I) shall be followed except that painting work shall be up to 10 cms. width.

2.0. Mode of measurements and payment

2.1. The relevant specifications of item No. 19.119 (I) shall be followed.

2.2. The rate shall be for a unit of one running meter.

19.127.(A) Painting lines, dashes, arrows letters etc. on roads, airfields, and like in one coat with road marking paint, brushing including cleaning the surface of all dirt, dust and other foreign matter : over 10 cms. in width.

1.0. Materials and workmanship

The relevant specifications of item No. 19.126(1) shall be followed except that the painting shall be done in one coat over 10 cms. in width.

2.0. Mode of measurement and payment

2.1. The relevant specifications of item No. 19.126 (I) shall be followed.

2.2. The rate shall be for a unit of One Sq. meter.

19.127. (B) Painting lines, dashes, arrows, letters etc. on roads, air fields and like in one coat with road marking paint, brushing including cleaning the surface of all dirt, dust and other foreign matter : Up to 10 cms. in width.

1.0. Materials and Workmanship

1.1. The relevant specifications of item No. 19.126 (I) shall be followed except that the painting shall be done in one coat upon 10 cms. in width.

2.0. Mode of measurements and payment

2.1. The relevant specifications of item No. 19.126 (I) shall be followed.

2.2. The rate shall be for a unit of one running meter.

SECTION-20

Demolition & Dismantling

20.1.(i) Demolition and disposal of unserviceable materials with all leads and lifts : Lime Concrete.

1.0. Workmanship

1.1. The demolition shall consist of demolition of one or more parts of the building as specified or shown in the drawings. Demolition implies taking up or down or breaking up. This shall consist of demolishing whole or part of work including all relevant items as specified or shown in the drawings.

1.2. The demolition shall always be planned before hand shall be done in reverse order to the one in which the structure was constructed. This scheme shall be got approved form the Engineer-in-charge before starting the work. This however will not absolve the contractor from the responsibility of proper and safe demolition.

1.3. Necessary propping, shoring and under pinning shall be provided for the safety of the adjoining work or property, which is to be left intact, before dismantling and demolishing is taken up and the work shall be carried out in such a way that no damage is caused to the adjoining property.

1.4. Wherever required, temporary enclosures or partitions shall also be provided. Necessary precautions shall be taken to keep the dust nuisance down as and where necessary.

1.5. Dismantling shall be commenced in a systematic manner. All materials which are likely to be damaged by dropping from a height or demolishing roof, masonry etc. shall be carefully dismantled first. The dismantled articles shall be properly stacked as directed.

1.6. All materials obtained from demolition shall be the property of Government unless otherwise specified and shall be kept in safe custody until handed over to the Engineer-in-charge.

1.7. Any serviceable materials, obtained during dismantling or demolition shall be separated out and stacked

properly as directed with all lead and lift. All unserviceable materials, rubbish etc., shall be stacked as directed' by the Engineer-in-charge.

1.8. On completion of work, the site shall be cleared of all debris rubbish and cleaned as directed.

2.0. Mode of measurements and payment

2.1. Measurements of all work except hidden work shall be taken before demolition or dismantling and no allowance for increase in bulk shall be allowed. The demolition of lime concrete shall be measured under this item. Specification for deduction for voids, openings etc. shall be on same basis as that employed for construction of work,

2.2. All work shall be measured in decimal system as fixed in its place subject to the following limits; unless otherwise stated hereinafter : (a) Dimensions shall be measured to the nearest 0.01 mt. (b) Area shall be worked out to the nearest 0.01 sq. mt.(c) Cubical contents shall be worked out to the nearest 0.01 Cu.m.

2.3. The rate shall include cost of all labour involved and tools used in demolishing and dismantling including scaffolding. The rate shall also include the charges for separating out and stacking the serviceable materials properly and disposing the unserviceable materials with all lead and lift. The rate also includes for temporary shoring for the safety of the portion not required to be pulled down or of adjoining property and providing temporary enclosures or portions where considered necessary.

2.4. The rate shall be for a unit of one cubic meter.

20.1.(ii) Demolition and disposal of unserviceable materials with all leads and lifts : Un reinforced cement concrete.

1.0. Workmanship

The relevant specifications of item 20.1.(i) shall be followed except that the un reinforced cement concrete work is to be demolished instead of lime concrete.

2.0. Mode of measurements and payment

2.1. The relevant specifications of item 20.1(i) shall be followed.

2.2. The rate shall be for a unit of one cubic meter.

20.3. Demolition including of serviceable materials and disposal of unserviceable materials with all leads and lifts : R.C.C. work.

1.0. Workmanship

1.1. The relevant specifications of item 20.1 (i) shall be followed except that demolition of R.C.C. work is to be done.

148

2.0. Mode of measurements and payment

2.1. The relevant specifications of item 20.(i) shall be followed except that the demolition of reinforced concrete structure is to be done. The unserviceable materials shall be disposed of at all leads and lifts. The rate excludes scraping straightening of reinforcement but includes cutting of reinforcement.

2.2. The rate shall be for a unit of one cubic meter.

20.11 (ii) Demolition of brick work and stone masonry including stacking of serviceable materials and disposal of unserviceable materials with all leads and lift : in lime mortar.

1.0. Workmanship

1.1. The relevant specifications of item No. 20.1.(i) shall be followed except that demolition of brick or stone masonry in lime mortar is to be done.

2.0. Mode of measurements and payment

2.1. The relevant specifications of item No. 20.1(i) shall be followed except that the wall and independent piers or columns of brick or stone masonry shall be measured in cubic meters. All copings, corbels, combs and other projections shall be included with the wall measurements.

2.2. In measuring thickness of plastered walls, the thickness of plaster shall be included. The unserviceable materials shall be disposed off with all lead and lift. Ashlars face stones dressed stone etc., if required to be taken down intact shall be dismantled and measured separately in cubic meters.

2.3. The rate is exclusive of cleaning of bricks or stones. Honey comb works or hollow block walling shall be measured as solid.

2.4. The rate shall be for a unit of one cubic meter.

20.11. (iii) Demolition of brick work and stone masonry including stacking of serviceable materials and disposal of unserviceable materials with all leads and lift : in cement mortar.

1.0. Workmanship

1.1. The relevant specifications of item 20.1.(i) shall be followed except demolition of brick or stone masonry in cement mortar is to be done.

2.0. Mode measurements and payment

2.1. The relevant specifications of item 20.11 (ii) shall be followed. The unserviceable materials shall be stacked as directed by Engineer-in-charge with all leads and lifts.

20.22. Demolition in terrace including stacking or serviceable materials and disposal of unserviceable materials with all lead and lift : Brick tiles covering.

1.0. Materials

1.1. The relevant specifications of item No. 20.1 (i) shall be followed except that the demolition of terrace brick tiles is to be done.

2.0. Mode of measurements and payment

2.1. The relevant specifications of item No'. 20.1(i) shall be followed except that the brick tiles covering of terrace shall be measured in sq. mt. The unserviceable materials shall be stacked as directed at all leads and lifts.

2.2. The rate shall be for a unit of one sq. meter.

20.23. Dismantling tiled or stone floors laid in mortar including stacking of serviceable materials and disposal of unserviceable materials with all lead and lifts.

1.0. Workmanship

1.1. The relevant specification of item 20.1 (i) shall be followed except the dismantling of tiled or stone floors laid on mortar shall be done. Dismantling implies carefully taking up or down or removing without ^damage. The articles shall be passed by hand where necessary and lowered and where these are fixed by nail, screws, bolts etc., these shall be taken out with proper tools.

2.0. Mode of measurements and payment

2.1. The supporting materials such as joints, beams if any etc. shall be measured separately. The relevant specifications of item No. 20.1 (i) shall be followed, The rate shall include staking the unserviceable materials as directed with all lead and lift.

2.2. The rate shall be for a unit of one sq. meter.

20.25. Dismantling of wooden floors, including, stacking of serviceable materials and disposal of unserviceable materials with all lead and lifts.

149

1.0. Materials

1.1. The specifications of item 20.1(i) shall be followed except that wooden floors shall be dismantled.

2.0. Mode of measurements and payment

2.1. The relevant specifications of item 20.1 (i) same shall be followed. The supporting members such as joints, beams etc. shall be measured separately. The rate shall include disposal of unserviceable materials as directed for and with all lead and lift.

2.2. The rate shall be for a unit of one sq. meter.

20.27.(i) Dismantling of sheet including ridges, hips, valleys gutters etc. stacking of serviceable materials and disposal of unserviceable materials with leads with lifts : G.I. sheet roofing.

1.0. Materials

1.1. The relevant specifications of item 20.1.(i) shall be followed except that G.I. sheet roofing shall be dismantled instead of concrete work.

2.0. Mode of measurements and payment

2.1. The area of G.I. sheets roofing shall be measured in sq. meter. Ridges, hips and valleys shall be girded and included with roof area. Corrugated and semi-corrugated surfaces shall be measured flat and not girthed.

2.2. Supporting members such as rafters, purlins, beams, joints, trusses etc. shall be measured separately.

2.3. The rate shall include disposal of unserviceable materials with all leads and lifts and stacking the serviceable materials as directed.

2.4. The rate shall be for a unit of one sq. meter.

20.27 (ii) Dismantling of sheet roofing including ridges, hips, valleys gutters etc. stacking of serviceable materials and disposal of unserviceable materials with all leads and lifts : A.C. Sheet roofing.

1.0. Workmanship

1.1. The relevant specifications of item 20.27 (i) shall be followed except that dismantling work of A.C. sheet roofing is to be done.

2.0. Mode of measurements & payment

2.1. The relevant specifications of item 20.27 (i) shall be followed except that the A.C. sheets .roofing shall be measured in this item.

2.2. The rate shall be for a unit of one sq. meter.

20.28. Dismantling Mangalore or country tile roofing with battens, boarding etc. including stacking of serviceable materials and disposal of unserviceable materials with all lead and lifts.

1.0. Workmanship

1.1. The relevant specifications of item 20.1 (i) shall be followed except that the country tile roof or Mangalore roof shall be dismantled.

2.0. Mode of measurements and payment

2.1. The relevant specifications of item 20.1 (1) shall be followed.

2.2. The supporting members shall be measured separate item.

2.3. The rate includes labour required for disposal of unserviceable item with all leads and lifts.

2.4. The rate shall be for a unit of one sq. meter.

20.30. Dismantling cement asbestos/hard board in ceiling or partition walls, wooden trellis work including frames, stacking of to serviceable material and disposal of unserviceable materials with all leads and lifts.

1.0. Workmanship

1.1. The relevant specifications of item 20.1 (i) shall be followed except that the cement asbestos hard board in ceiling or partition walls, wooden trellis, work etc. shall be dismantled.

2.0. Mode of measurements and payment

2.1. The relevant specifications of item 20.1 (i) shall be followed. The serviceable materials shall be stacked as and where directed and the unserviceable materials shall be disposed off with leads and lifts.

2.2. The rate shall be for a unit of one sq. meter.

20.35 Dismantling wood wrought, framed and fixed in frames, trusses including stacking the materials with all lead and lift.

150

1.0. Workmanship

1.1. The relevant specifications of item No. 20.1 (i) shall be followed except that the wood work, wrought framed and fixed in frames, trusses etc. shall be dismantled.

2.0. Mode of measurements and payment

2.1. The relevant specifications of item No. 20.1 (i) shall be followed.

2.2. The materials shall be stacked as and where directed with all leads and lifts.

2.3. The rate shall be for a unit of one cubic meter.

20.39. Dismantling expanded metal or I.R.C. fabric with necessary battens and beading including frame work and stacking the serviceable materials with all lead and lift.

1.0. Workmanship

The relevant specifications of item No. 20.1 (i) shall be followed except that the dismantling of expanded metal or I.R.C. fabric shall be done

2.0. Mode of measurements & payment

2.1. The relevant specifications of in item No. 20.1 (i) shall be followed.

2.2. The rate shall be for a unit of one sq. meter.

20.43. Dismantling steel work including dismembering and stacking the materials with air leads and lifts.

1.0. Materials

1.1. The relevant specifications of item No. 20.1 (i) shall be followed except that the dismantling of steel work shall be carried out.

2.0. Mode of measurements and payment

2.1. The relevant specifications of item No. 20.1 (i) shall be followed.

2.2. The weight of the member shall be computed from standard table unless the actual weight can be readily determined.

2.3. Riveted works where rivets are required to be cut. the same shall be carried out under this item and nothing extra shall be paid.

2.4. In framed still gate, the weight of any covering material or filling such as iron sheets and expanded metal shall be added to the weight of the main articles if such covering is not ordered to be taken out separately.

2.5. The rate includes stacking the materials as and where directed with all leads and lifts.

2.6. The rate shall be for a unit of one Kg.

20.49.(i) Dismantling doors, windows, ventilators etc. (wood or steel) shutters including chowkhats, Architraves, hold fasts and other attachments etc. complete and stacking them within all leads & lift. No exceeding 3 sq. meters in area.

1.0. Workmanship

The relevant specifications of item No. 20.1 (i) shall be followed except that the door, windows, ventilators etc. (wood or steel) shutters including chowkhats, architraves, hold fasts and other attachments etc. are to be dismantled.

2.0. Mode of measurements & payment

2.1. The relevant specifications of item No. 20.1 (i) shall be followed.

2.2. The doors, windows, ventilator etc. not exceeding 3 sq. mt. in area (each) including shutters and chowkhats. Architraves, hold fasts and other attachments to frames etc. will be dismantled and measured under this item.

2.3. The rate includes stacking the serviceable materials as and where directed with all leads and lifts.

2.4. The rate shall be for a unit of One number.

20.49.(II) Dismantling doors, windows, ventilators etc. (wood or steel) shutters including chowkhats. Architraves, hold fasts and other attachments etc. complete and stacking them within all leads and lift : Exceeding 3 sq. meters in area.

1.0. Workmanship

The relevant specifications of item No. 20.49(I) shall be followed except that the area of doors, windows, ventilators, exceeding 3 sq. meters are to be dismantled under this item.

151

2.0. Mode of measurements of payment

2.1. The relevant specifications of item No. 20.49 (I) above shall be followed.

2.2. The rate shall be for a unit of One number.

20.51. Dismantling barber wire fencing including making rolls and also including dismantling facing posts including all earth work, concrete in the base and making good the disturbed ground stacking useful materials as directed and disposing all the unserviceable materials with all leads and lifts.

1.0. Workmanship

The relevant specifications of item No. 20.1 (i) shall be followed, except that the dismantling of barbed wire fencing shall be carried out.

2.0. Mode of measurements & payment

2.1. The relevant specifications of item No. 20.1. (i) shall be followed.

2.2. The rate includes making rolls of dismantled wires and including dismantling fencing posts, concrete work, in base and making good the disturbed ground etc. complete.

2.3. The serviceable materials shall be stacked as and where directed and end unserviceable materials shall be disposed with all leads and lifts.

2.4. The rate shall be for a unit of One running meter.

20.56. Dismantling (C.I. Pipes, G.S.W. Pipes and A.C. rain water pipes with fittings and clamps,

including stacking the materials with all lead and lift, (for any dia. of pipe).

1.0. Workmanship

The relevant specifications of item No. 20.23 shall be followed except that the dismantling work of pipes lines of C.I., G.S.W. & A.C. Pipes with fitting shall be carried out.

2.0. Mode of measurements and payment

2.1. The relevant specifications of No. 20.1 (i) shall be followed.

2.2. Water pipe lines, including rain water pipes, with clamps and specials, swear pipe lines, (Salt glazed ware or concrete) etc. shall be measured in running meter inclusive of joints. (The measurements shall be taken along the centre line of pipe and fittings).

2.3. The rate shall be for a unit of One running meter.

20.00.1. Dismantling sanitary fittings like wash basin, W.C. Pan, Indian & European Type flushing tank, etc. including stacking the materials with all lead lift.

1.0. Workmanship

The relevant specifications of item No. 23.23 shall be followed except that the dismantling work of sanitary fittings such as wash basin, W.C. Pan (all type of pans), Flushing tanks etc. shall be carried out.

2.0. Mode of measurements & payment

2.1. The relevant specifications of item No. 20.1 (i) shall be followed.

2.2. The rate shall be for a unit of one number.

20.00.2. Scraping oil paint steel and other metal surfaces and making the surface even (with hand scraping).

1.0. Workmanship

The old paint from steel and other surface shall be scraped thoroughly with hand scraper followed by wire brushing (first with coarse and then with fine brushes) and finally sand papering with coarse and paper (No.3) steel wood (No.2) or emery paper (No.3) or with emery clothes. This shall then be wiped finally with mineral turpentine to remove grease and perspiration of hand marks etc. and allowed to dry. The surface shall be made even and smooth.

2.0. Mode of measurements and payment

2.1. The work shall be measured in actual area of work done.

2.2. The rate shall be for a unit of one sq. meter.

152

SECTION-21

Repairs to Buildings

21.8. Providing and fixing M.S. fan clamps of shape and size as specified in existing R.C.C. slab including cutting chase and making good.

1.0. Materials

1.1. M.S. Bar shall conform to M-18.

2.0. Workmanship

2.1. The shape and size of fan clamp shall be directed!

2.2. The fixing M.S. fan clamp in existing R.C.C. slab a chase of size 150 mm. x 75 mm. shall be cut from the ceiling so as to expose the reinforcement and up to 25 mm. clear round the reinforcement bar. This shall be done without any damage to adjoining portion of ceiling. The two arms of the ends of the clamp shall be passed through the space over reinforcement bar from the bottom of the slab. Then the two arms shall be bent down about 15 mm. by means of crow bar. The clamp shall be held in position and the chase in ceiling filled with cement concrete 1:2:4 (1 cement : 2 coarse sand : 4 graded stone aggregate 20 mm. nominal size). The ceiling shall be then finished to match the existing surface and properly cured.

3.0. Mode of measurements and payment

3.1. The rate includes cost of all materials and labour required for satisfactory completion of this item as described above.

3.2. The rate shall be for a unit of One number.

21.23. Cutting our cracks, of roof terrace to V. section, Cleaning out, wetting, grouting with cement and sand slurry 1:3 (1 cement : 3 sand)

1.0. Materials

(1) Water shall conform to M-1. (2) Cement shall conform to M-3. (3) Sand shall conform to M-6.

2.0. Workmanship

2.1. The cracks shall be cleaned out and trimmed to V shaped cuts at least 6 mm wide on top. The cracks shall be cleaned off and then cracks shall be thoroughly flooded with water, water allowed to a soak in cracks, and then grouted with cement and sand slurry in proportion 1:3. The required cracks shall be cured at least 7 days.

3.0. Mode of measurements and payment

3.1. The rate shall includes cost of all materials and labour required for satisfactory completion of item as described above.

3.2. The rate shall be for a unit of One running meter.

21.24. Cutting out cracks of roof terrace to V-Section out, and filling solidly with a hot mixtures of bitumen and clean dry sand (1:1 weight).

1.0. Materials

(1) Bitumen shall be 85/25 penetration (2) Sand shall conform to M-6.

2.0. Workmanship

2.1. The relevant specifications of item No. 21.23 shall be followed for opening cracks and cleaning.

2.2. The cracks shall be absolutely dried and cleaned and filled solidly with a hot mixture of 85/25 penetration and sand in ratio of 1; 1 by weight. The filler shall be well filled into cracks with the edges of a trowel and left flush with surface of roof. Repaired cracks shall cause no ridges the direction of the slope of roof.

3.0. Mode of measurements & payment

3.1. The relevant specifications of item No. 21.23 shall be followed.

3.2. The rate shall be for a unit of One running meter.

153

SECTION-22

Misc. Building Items

22.20. Providing and fixing 1.20 meter fencing with 2 meter long M.S. angle posts 40 mm. x 40 mm. x 6 mm. and oil painting 3 coats fixed at 2.5 M C/C with five horizontal lines, and two diagonals of galvanised steel barbed wire weighing 9.38 Kg. per 100 meter. (Min.) stained and fixed to posts with G.I. staples including fixing the posts in ground with 0.5 x 0.5 x 0.5 M block in C.C. 1:5:10 (cement : 5 sand : 10 graded brick aggregate 40 mm. nominal size) etc. complete.

1.0. Materials

(1) Water shall conform to M-1. (2) Cement shall conform to M-3. (3) Sand shall conform to M-6. (4) Brick bats aggregate shall conform to M-14. (5) Oil paint shall conform to M-44. (6) Barbed wire shall conform to M-78.

2.0. Workmanship

2.1. The pits of the size 0.5 x 0.5 m. x 0.5 shall first be excavated, true to line and level to receive the post at 2.5 C/ C. The relevant specifications of item 4.00.1 shall be followed for excavation work.

2.2. The pits shall be filled with a layer 0.15 m. thick with lean concrete 1:5:10 (1 cement: 5 sand : 10 graded brick bat aggregate 40 mm. nominal size). The M.S. angles 40 mm. x 40 mm. x 6 mm shall be filled in with lean concrete 1:5:10 and rammed properly so as to form total 0.5 m. x 0.5 m. x 0.5 m, concrete block. The concrete shall be cured for 7 days to allow it to set.

2.3. The barbed wire shall be stretched and fixed in 5 horizontal rows and two diagonals. The bottom row shall be 140 mm. above ground and the rest at 125 mm. centre to centre. The diagonal shall be stretched between adjacent post from top wire of one post to the bottom wire of 2nd post. The wires shall be fixed to posts by means of staples. The M.S. Angle posts shall be painted with 3 coats of old paint of approved tint and shade.

3.0. Mode of measurements and payment

3.1. The work shall be measured for the finished work from centre to centre of the posts.

3.2. The rate shall include the cost of labour and materials involved in the operations described above.

3.3. The rate shall be for a unit of One running meter.

22.00.1. Construction of B.B. masonry paniara 23 cm x 75 mm wall including fixing pre cast R.C.C. marble Mosaic (Terrazzo) slab of 75 mm. thickness on top and smooth finishing to walls in cement plaster in C.M. 1:3 curing etc. complete including drainage out, waste water arrangements.

1.0. Materials

(1) Water shall conform to M-1. (2) Cement shall conform to M-3. (3) Sand shall conform to M-6. (4) Burnt bricks shall conform to M-15. (5) Pre cast marble mosaic terrazzo paniara of 75 mm thickness shall be of best quality. The width of paniara shall be directed. .

2.0. Workmanship

2.1. The brick masonry shall be constructed for paniara for the size as directed in C.M. 1 :6. The thickness of wall shall be 23 cms. thick and height shall be 75 cms. The relevant specifications of B.B. masonry at item 6.13 (b) shall be followed for B.B. masonry work.

2.2. The B.B. masonry shall be covered with pre cast marble terrazzo paniara at top, of width and length as specified or as directed. The terrazzo mosaic paniara shall be T'S mm, thickness.

2.3. The whole masonry work shall be finished smooth with C.M. 1:3 on both sides the relevant specifications of item No. 1.7.59 (I) shall be followed.

2.4. The drainage outlet and water arrangement shall be made as directed.

3.0. Mod& of measurements and payment

3.1. The work shall be measured for the finished work.

3.2. The rate shall be include the cost of labour and materials involved in the operations described above.

3.3. The rate shall be for a unit of One Running meter.

22.00.2. Constructing a chowkadi with C.Q. over 12 cm. thick B.B. masonry in front and dwarf wall 1 M high and 23 cms. thick cement plaster to masonry in C.M. (1:3) and cement concrete flooring in 1:2:4 with 5 cm. dia. A.C. Drain pipe etc. complete

1.0. Materials

1.1. Water shall conform to M-1. Cement shall conform to M-3. Sand shall conform to M-6. Burnt bricks shall conform to M-15. Stone aggregate 20 mm. nominal size shall conform to M-2. (a) A.C. Drain pipe of 5 cms. dia shall conform to M-74.

154

2.0. Workmanship

2.1. The chowkadi shall be constructed of specified size and as directed. The slab shall be cast on B.B. masonry wall 12 cms. thick and dwarf wall 1 M high and 23 cms, thick shall be constructed in proportion of C.M. 1:6. The relevant specifications of item 6.3. (I) shall be followed for masonry partition work and 5.4.1. (c) shall be followed for reinforced concrete work.

2.2. The whole masonry work shall be finished with cement mortar 1:3 and finished smooth. The relevant specifications of item No. 17.59 (I) shall be followed for plastering work,.

2.3. The A.C. pipe of 5 cms. dia shall be fixed as drainage pipe. The bottom shall be finished with C.C. 1:2:4 finished with cement slurry.

3.0. Mode of measurements and payment

3.1. The work shall be measured for finished work.

3.2. The rate includes cost of all materials, labour etc. required for carrying out satisfactory completion of work.

3.3. The rate shall be for a unit of one square meter.

22.00.3.(I) Constructing cooking platform 60 cm. width and 70 cm. height resting on B.B. Masonry wall

23 cms. thick in C.M. 1:6 with fixing of pre cast 1:2:4. R.C.C. 0.0 M. thick slab with marble mosaic chips set in GM. (Terrazzo) with plastering on exposed faces to wall in C.M. 1:4 etc. complete.

1.0. Materials

Water shall conform to M-1. Cement shall conform to M-3. Sand shall conform to M-6. Burnt brick shall conform to M-15. Marble Mosaic chips shall conform to M-46. Stone aggregate 20 mm. nominal size shall conform to M-12. (a) M.S. Bars shall conform to M-18.

2.0. Workmanship

2.1. The cooking platform of size as directed shall be constructed in 60 cms. width and 70 cms. height. The brick masonry wall, in C.M. 1:6 shall be constructed in 23 cms. thickness up to full depth. The relevant specifications of item 6.13 (B) shall be followed for masonry work.

2.2. The R.C.C. slab of 8 cms. thickness and of adequate design and size shall be precast and the same shall be put up on the B.B. masonry work.

2.3. The top and exposed sides of the R.C.C. slab shall be finished with marble mosaic terrazzo 8 mm. thick with required colour pigment. The work of terrazzo shall be carried out as per relevant specifications of item 14.4 (E).

2.4. The whole masonry work shall be finished with cement mortar in C.M. 1:4. The relevant specification of item 17.59 (II) shall be followed.

3.0. Mode of measurements and payments

3.1. The work of cooking platform shall be measured for finished work.

3.2. The rate includes cost of all labour and materials, etc. required for satisfactory completion of this item as described above.

3.3. The rate shall be for a unit of One running meter.

22.00.3.(II) Constructing cooking platform of 60 cm. width and 70 cms. height resting on B.B. masonry

walls 23 cm thick in C.M. 1:1 with fixing black kadapa stone surface laid on pre cast R.C.C. slab 1:2:4 with plastering on exposed faces to wall in C.M. 1:4 etc. complete.

1.0. Materials and Workmanship

1.1. The relevant specification of item No. 22.00.3 (I) shall be followed except that the cooking platform shall be constructed by providing black kadapa stone of 25 mm. to 30 mm. thickness on pre cast R.C.C. 1:2:4 slab 8 cms. thick. The black stone shall be provided in single piece up to 1.8 M in length and specified width. All the exposed edges of stone shall be machine cut.

2.0. Mode of measurement and payment

2.1. The relevant specifications of item 22.00.3.(I) shall be followed.

2.2. The rate includes providing machine cut edges on exposed face of kadapa stone.

2.3. The rate shall be for a unit of One running meter.

22.00.4. Providing and fixing Rajula stone 75 mm. thick 60 cm x 45 cms. size including fixing in cement mortar as directed.

1.0. Materials

Water shall conform to M-1. Cement mortar shall conform to M-11. Rajula stone of specified, size shall be of best quality and free from any defects. The stone shall not be less than 75 mm in thickness.

155

2.0. Workmanship

2.1. The Rajula stone of size 60 x 45 cms. size shall be fixed as and where directed in cement mortar in 1:3. All the edges of the stone shall be fixed with cement mortar in C.M. 1:3 and sloped at 45° and finished smooth. The work shall be cured for 7 days after fixing.

3.0. Mode of measurements and payment

3.1. The work shall be measured for finished work.

3.2. The rate includes cost of all labour and materials required for satisfactory completion of this item.

3.3. The rate shall be for a unit of one number.

22.00.5. Providing and laying Bilimora type brick facing in C.M. 1:1 laid over bedding of cement mortar

1:3 (13 mm. thickness) including cleaning, watering, scaffolding etc. complete.

1.0. Materials

1.1. Water shall conform to M-1. Cement mortar of specified proportion shall conform to M-11. Bilimora type bricks shall be approved before collection the same on site.

2.0. Workmanship

2.1. The surface on which the Bilimora type bricks is to be provided shall be cleaned of all dust, dirt, etc. and finished with CM 1:3 in 13 mm, thickness. The relevant specifications of item 17.59 (I) shall be followed except that the thickness of finishing shall be 13 mm. The top surface shall be roughened by wire brushes to give proper grip to the tiles to be fixed.

2.2. The Bilimora type bricks shall be fixed with CM 1:1. The tiles shall be properly wetted before fixing. The horizontal and vertical joints shall be maintained in true line and level by providing 12 mm or 20 mm. sq. bars as directed. The tiles shall be tamped by trowel so that there shall not be any hollows left behind the tiles.

2.3. The tiles shall be cut to the required size on ends of at top bottom of beams in best workman like manner.

2.4. The whole work shall be cured for 7 days.

3.0. Mode of measurements and payment

3.1. The work shall be measured as per relevant specification of item No. 17.58(1)

3.2. The rate includes cost of all materials, wastage etc. occurring due to cutting of tiles and ends as top and bottom of beams etc. including base coat.

3.3. The rate shall be for unit of One sq. meter.

22.00.6. Providing and fixing teakwood rail of 60 mm. x 20 mm. size and 50 cms. length incl. 3 coats of oil paint to wood work with set of 3 pegs.

1.0. **Materials** : Teak wood battens of specified size shall conform to M-29. Oil paint shall conform to M-44. Wall pegs of aluminum 3 Nos. of approved quality and make shall be provided.

2.0. Workmanship

2.1. The teakwood battens of size 60 mm. x 20 mm. and 50 cms. long be planed on all sides. The anodized aluminum wall pegs of approved make shall be fixed on wooden batten prepared with screws as directed. The wall pegs unit shall be fixed on wall with wooden gut ties and screws as directed. The wooden battens shall be painted with 3 coats of ready mix paint of approved colour and shade.

3.0. Mode of measurements and payment

3.1. The work shall be measured for finished work.

3.2. The rate shall be for a unit of one number.

22.00.7. Treating the bottom and sides (up to a height of 300 mm.) of the excavations made for the masonry foundations and basement with chemical emulsion at the rate of 5 liters per Sq. meter of the surface area.

1.0. Materials : The chemicals used for the soil treatment shall be only one of the following with concentration shown against each in aqueous emulsion.

Chemicals Concentration

1. Aldrin 0.50% (by weight)
2. Heptachlor 0.50% (by weight)
3. Chlordane 1.00% (by weight)

156

2.0. Workmanship

2.1. The chemicals barrier shall be complete and continuous under whole of the structure to be protected.

2.2. The bottom and the sides of foundations up to a height of 30 cms. from the bottom of excavation made for masonry foundation and for basement column pits shall be treated with the chemical emulsion at the rate 5 liters/ sq. meter of the surface area. .

2.3. The chemical treatment shall be carried out when the surfaces is quite dry. Chemical treatment shall not be carried out when it is raining or when the soil wet with rain or sub soil water.

2.4. Once formed, treated soil barriers shall be not disturbed. If by chance, treated soil barriers are disturbed, immediate steps shall be taken to restore the continuing and compactness of the barrier system

2.5. The treatment against termite infection shall remain fully effective for a period not less than 10 years from date of issue of the final certificate to completion of work. If at any time during this period, any defects in treatment are revealed or any evidence of infection in any part of the building or structure is noticed, the contractor shall be rectify the concerned defects within 14 days on receipt of notice from Engineer-in-charge. On contractor's failure to do so, the Engineer-in-charge may get the same rectified through any other agency at contractor's risk and cost, and decision of Engineer-in-charge as to the cost payable by contractor for the same shall be final and binding to the contractor.

2.6. A guarantee bond on appropriately stamped paper shall be given by the contractor to the department in the manner and form prescribed below:

FORM OF GUARANTEE BOND

I/We..... (Contractor) hereby guarantee that work will remain unaffected and will not be any way damaged by termite or any other germs of similar types, for a period for 10 years after completion of the work of anti-termite as per the terms and conditions of the contract and or damage that might be caused on account of termite and or other similar type of germs and hereby Guarantees to make good any loss of damages suffered by the Government of Gujarat and further guarantee to redo effective work without claiming any extra cost.

2.7. This guarantee shall remain in force for the period of 10 years from the completion of the work under the contract and it shall remain binding to the contractor for period of 10 years.

2.8. The deposit at the rate of 50% of the cost of this item from the running and final bills shall be recovered and retained for the first one year after completion of the work and 10% shall be retained for the balance of guarantee period and shall be refunded only after the completion of the guarantee period.

3.0. Mode of measurements & payment

3.1. The length and breadth shall be measured correct to a cm. as per the dimensions of sanctioned plans. No deduction shall be made nor extra paid for any opening for pipes etc. up to 0.1.sq. mt. The rate shall include the cost of all labour and materials required for the operation involved for satisfactory completion of this item. The sides of the trenches 30 cms, each side and bottom shall be measured under this item.

3.2. The rate shall be for a unit of One sq. meter.

22.00.8. Treating the backfill immediately in contact with foundation structure with chemical emulsion at the rate 7.5 liters per sq. mt. of vertical surface of the sub structure of each side (In case of R.C.C. columns, beams and R.C.C. basement walls, treating the sides of 50 cms. from ground level with chemical emulsion at the rate of 7.5 Liters/sq. meter).

1.0. Materials

1.1. The specifications of the item 22.00.7. shall be followed.

2.0. Workmanship

2.1. After masonry foundations and retaining walls of basement come up , the backfill immediate in contact with foundation shall be treated with the chemical emulsion at the rate of 7.5 liters per sq. m. of the vertical surface of the sub structure for each side. The filling of earth is usually carried out in layers and the treatment shall be directed towards the concrete or masonry surfaces of the columns and walls so that the earth contact with these surfaces is well treated with chemical.

2.2. In case of R.C.C. framed structure with columns and plinth beams and R.C.C. basements the treatments shall start at the depth of 50 cms. below ground level from this depth backfill around the columns, beams, and R.C.C. basement walls shall be treated at 7.5 lit/sq. m. of vertical surface. The relevant specifications shall be followed same as item 22.00.7.

3.0. Mode of measurements and payment

3.1. The area of substructure in contact with backfill to be measured. The length and breadth shall be measured correct to a cm. dimension of sanctioned plans for the surfaces in contact with backfill.

157

3.2. No deduction shall be made nor extra paid for any opening for pipes, etc. up to 0.1 sq. m.

3.3. The rate includes cost of all labour, materials required for satisfactory completion of this item.

3.4. The rate shall be for a unit of One sq. meter.,

22.00.9. Treating the top surface of the plinth filling with chemical emulsion at rate of 5 liters sq. meter, before the sand bed or sub grade is laid.

1.0. Materials : The relevant specifications of item 22.00.7. shall be followed.

2.0. Workmanship

2.1. The relevant specifications of item 22.00.7 shall be followed that the top surface of the consolidated earth within the walls, shall be treated with the chemical emulsion at the rate of 5 liters/sq. metre of the surface before the sand bed or sub-grade is laid. If the filled earth has been well rammed and the surface does not allow the emulsion to seep through, holes up to 50 to 75 mm. deep at 150 mm. centers both ways may be made with 12 mm. dia. M.S. rod on the surface to facilitate absorption of the emulsion.

3.0. Mode of measurements & payment

3.1. The length and breadth shall be measured clean for the area actually treated.

3.2. No deduction shall be made nor extra paid for any opening for pipes, etc. up to 0.1 sq. m.

3.2. The rate shall be for a unit of One sq. meter.

22.00.10. Treating the junctions of wall and floor area with chemical emulsion at the rate of 7.5 liter/sq. mt. by making holes at junction of walls, and columns, with the floor before laying sub grade to a depth to 15 cms. by making holes.

1.0. Materials : The relevant specifications of item 22.00.7 shall be followed,

2.0. Workmanship

2.1. The relevant specifications of item 22.00.7 shall be followed except that the junction of walls columns with floor shall be treated with the chemical emulsion at the rate 7.5 liters/sq. meter. Special care shall be taken to establish continuity of the vertical chemical barrier on inner wall surface from the ground level be taken to establish continuity[^] of the vertical chemical berries on inner wall surfaces from the ground level up to the level of filled earth surface. To achieve this, a small channel 3x3 cm. shall be made at the junctions of the wall and columns with floor (before laying the sub 2 grade) and road holes made in the channels up to the ground level 15 cms. apart and the rod moved backward and forward to breakup the earth an chemical emulsion poured along the channel at the rate of 7.5 liters per sq. m, of the vertical wall or column surfaces of sub-structures so as to soak the soil right to the bottom. The soil should be tamped back into place after this operation.

3.0. Mode of measurements and payment

3.1. The relevant specifications of the item 22,00.7. shall be followed.

3.2. The vertical area of sub-structure in contact with filled up earth above ground level to top filled up earth shall be measured for payment.

3.3. The rate shall be for a unit of One sq. meter.

22.00.11. Treating the earth along the external perimeter of the building by making holes 15 cms., apart up to a depth of 30 cms. with chemical emulsion at the rate of 7.5 liters per sq. meter along the wall.

1.0. Materials : The relevant specification of item 22.00.7 shall be followed.

2.0. Workmanship

2.1. The relevant specifications of the item 22.00.7. shall be followed except that the external perimeter of the building shall be treated with chemical emulsions. After building is complete, the earth along the . external perimeter of the building should be treated at intervals of 15 cms. and to a depth of 30 cms. The rods shall be moved backward and forward parallel to the wall to breakup the earth and chemical emulsion poured along the wall at the rate of 7.5 liters per sq. meter of vertical surfaces. After the treatment the earth shall be tamped back into place the earth out side of the building should be graded on compaction of building, this treatment shall be carried out on the completion of

such grading. In event of filling being more than 30 cms. the external perimeter and treatment shall be extended to the full depth of filling up to ground level so as to ensure continuity of the chemical barrier.

3.0. Mode of measurements and payment

3.1. The relevant specifications of item No. 22.00.7 shall be followed.

3.2. The vertical surfaces area so sub-structure 30 cms. in depth from finished ground level in external periphery only shall be measured and paid under this item. The depth of wall treated under back filled shall not be included in this item.

158

3.3. The rate shall be for a unit of One sq. meter.

22.0.12. Providing treatment along outside of foundation using chemical emulsion at 7.5 liters per sq. m. of vertical surface (for each side) of sub-structure.

1.0. **Materials** : The chemical used for the soil treatment shall be any one of the following with concentration shown against each in aqueous emulsion :

Chemicals Concentration

1. Aldrin 0.50% (by weight)
2. Heptachlor 0.50% (by weight)
3. Chlordane 1.00% (by weight)

2.0. Workmanship

2.1. The surface of consolidated earth around the existing building shall be treated with chemical emulsion at the rate 7.5 liters/sq. m. of vertical surface of sub-structure. The minimum height to substructure shall be considered 60 cms. for treatment. If the earth along the perimeter does not allow emulsion to seep through, holes up to 300 mm. deep at 150 mm. centers both ways be made by 12 mm. dia. mild steel rod on the surface to facilitate saturation of the soil with chemical emulsion.

2.2. The chemical barrier shall be complete and continuous under whole on the structure to be protected.

2.3. The chemical treatment shall be carried out when the surface quite dry. Chemical treatment shall not be carried out when it is raining or when the soil is wet with rain or sub soil water.

3.0. Mode of measurements and payment

3.1. The length shall be measured along the periphery of the sub-structure. The depth shall be taken 0.60 m.

3.2. No deduction shall be made not extra paid for any opening for pipes etc. up to 0.1 sq. m.

3.3. The rate includes cost of all labour and material required for the operations involved for satisfactory completion of this item.

3.4. The rate shall be for a unit of One sq. meter.

22.0.13. Providing treatment along external wall perimeter below concrete or masonry apron using chemical at 5. lit/linear including drilling and plugging etc.

1.0. **Materials** : The relevant specifications of item No. 22.0.12 shall be followed.

2.0. Workmanship

2.1. The relevant specification of item No. 22.0.12 shall be followed except that the treatment shall be carried out along external wall perimeter below concrete or masonry apron, using chemical at rate of 5 lit/ running meter.

3.0. Mode of measurements and payment

3.1. The relevant specifications of item No. 22.0,12 shall be followed.

3.2. The rate including drilling and plugging holes in apron etc. complete.

3.3. The rate shall be for a unit of One running meter.

22.0.14. Treatment of soil below existing floor using chemical at 1 liter per hole at 300 mm. a part including drilling plugging holes etc.

1.0. **Materials** : The relevant specifications of item No. 22.0.12. shall be followed.

2.0. Workmanship

2.1. The relevant specifications of item No. 22.00.9. shall be followed except that the termite control treatment shall be carried out in soil below existing floors.

2.2. The holes of 12 mm. dia rod shall be drilled in floor up to 150 mm. depth at 300 mm. part both ways. The chemical shall be then injected with pressure at the rate of 1 liters/hole of the surface area.

3.0. Mode of measurements & payment

3.1. The relevant specifications of item 22.0.9 shall be followed.

3.2. The rate shall includes cost of drilling holes and plugging.

3.3. The rate shall be for a unit of One sq. meter.

22.0.15. Treatment of voids in masonry using chemical at 1 Lit/hole at 300 mm. apart including drilling holes and plugging.

1.0. **Materials** : The relevant specifications of item 22.0.12 shall be followed.

159

2.0. Workmanship

2.1. The walls affected by termite shall be cleaned off all live forms binding inside and the holes of voids in masonry wall surface shall be treated by chemical emulsion at rat 1 Lit. hole. The holes in cracks in surface of wall shall be drilled at 300 mm. apart.

3.0. Mode of measurement & payment

3.1. The rate shall be for a unit of One number of voids treated.

22.0.16. Treatment to wood work by chemical emulsion in oil or kerosene based including 6 mm. dia downward slanted holes 150 mm. C/C. and plugging the same with cement mortar.

1.0. **Materials** : The relevant specifications of item No. 22. 00.7 shall be followed.

2.0. Workmanship

2.1. The wood work effected by Ants shall be cleaned of lives form hiding inside. The whole wood surface shall be then treated with oil or kerosene based chemical emulsion. The holes in 6 mm. dia. shall be drilled slanted downwards at 150 mm. centers to centers and chemical emulsion shall be poured into holes by means of funnels specifically prepared for the same and allowed to seep. After finales become emptily, another dose of chemicals shall be poured in them. This process shall be done repeatedly till the whole wood work is fully saturated with chemical.

2.2. The holes drilled in wood work shall be filled in with putty and other similar materials as directed and the whole wooden surface shall be made good as before.

3.0. Mode of measurements & payment

3.1. The work shall be measured for the finished work in sq. meter, including frame.

3.2. The out of frame shall be measured as width ad form top of flooring to top of frame shall be as height. This area includes for treating frame and shutters both.

3.3. The rate includes cost of all labours and materials, required for satisfactory completion of this item.

3.4. The rate includes drilling holes plugging the same after treatment completed and making good as before.

3.5. The rate shall be for a unit One sq. meter.

160

SECTION-23

Water Supply, Plumbing and Sanitary Fittings

23.2. Providing and fixing to wall, ceiling ad floor galvanised mild steel tube (Medium grade) of the following nominal bore, tube fittings and clamps including making good the wall ceiling and floor (A) 15 mm. dia (B) 20 mm. dia (C) 25 mm. (D) 32 mm. (E) 40mm. (F) 50 mm.

1.0. Materials

1.1. Galvanised mild steel tubes of specified dia nominal bore shall conform to I.S. 1239-1968.

1.2. The galvanised fittings, clamps, etc. required for specified dia. bore pipes shall be of best quality and makes as approved by the Engineer-in-charge.

2.0. Workmanship

2.1. Cutting, Laying & Jointing

2.1.1. When the tubes are to be cut or rethreaded, the ends shall be carefully filed out so that no obstruction to bore in offered. The ends of the tubes shall then be threaded conforming to the requirements of I.S. 554-1955 with pipe dies and taps carefully in such a manner that it will not result in slackness of joints when the two pieces are screwed together.

2.1.2. The taps and dies shall be used only for straightening screw threads which have becoming bent or damaged and shall not be used for turning of the threads so as to make them slack as the latter procedure may not result in the watertight joint. The screw threads for tube and fitting shall be protected form edge until they are fitted.

2.1.3. In jointing the tubes, the inside of the socket and the screwed end of the tubes shall be oiled and smeared with white or red lead and wrapping around with a few turns of fine spun yarn round the screwed end of the tube. The end shall then be tightly screwed in the socket, tees, etc. with a pipe wrench. Care shall be taken that all times free from dust, and dirt during fixing. Burr from the joints shall be removed after screwing. After laying the open ends of the pipes shall be temperately plugged to prevent access of water, soil, or any other foreign matter.

2.1.4. Any threads exposed after jointing shall be painted or in the case of underground piping thickly coated with approved anti-corrosive paint to prevent corrosion.

2.2. Fixing of tube fittings to wall ceiling & floors.

2.2.1. In case of fixing of tubes and fittings to the walls or ceilings, these shall run on the surface of the wall, or ceiling (not in chase) unless otherwise specified. The fixing shall be done by means of standard pattern, holder clamps keeping the pipes about 15 mm. clear of the wall. When it is found necessary to pattern, holder clamps keeping the pipes about 15 mm. clear of the .wall. When it is found necessary to conceal the pipes and when specified so, chasing may be adopted or pipe fixed inducts or recesses etc. provided that there is sufficient space to work on the pipe with usual tools. The pipe shall not ordinarily be buried in walls or solid floors, where unavoidable, pipe may be buried for short distances provided that adequate protection is given against damage and where so required joints are not buried. Where required M.S. tube sleeve shall be fixed at a place a pipe is peasant through a wall or floor for expansion and contraction and other movements. In case the pipe is embedded in walls or floors, it should be painted with anti-corrosive bitumastic paint of approved quality. The pipe should not come in contact with lime mortar or lime concrete as the pipe is affected by lime. Under the floors, the pipe shall be laid in layer of sand filling.

2.2.2. All pipes and fittings shall be fixed truly vertical and horizontal unless unavoidable. The pipes shall be fixed to walls with standard pattern clamps of required size and shape, one end of which shall be properly plugged or cemented into walls with cement mortar 1:3 (1 cement : 3 coarse sand) and the other tightened round the pipes to hold it securely. These clamps shall be spaced at regular intervals in straight lengths at 2 MC/C interval in horizontal run and 2.5 m. interval in vertical run. For pipe of 15 mm. dia. up to 25 mm. dia the holes in the walls and floors shall be made by drilling with chisel or jumper and not by dismantling the brick work or concrete. However for bigger diameter pipes the holes shall be carefully made cement : 3 coarse sand), and properly finished to match the adjacent surface.

2.3. Testing of joints :

2.3.1. After laying and jointing, the pipes and fillings shall be inspected under working conditions of pressure and flow. Any joints found liken shall be redone, and ail leaking pipes removed and replaced without extra cost.

161

2.3.2. The pipes and fittings after they are laid shall be tested to hydraulic pressure of 6 Kg./Sq cm. The pipe shall

be slowly and carefully charged with water allowing all air to escape and avoiding all shocks and water hammer. The draw off takes and stop cock shall then be closed and specified hydraulic pressure shall be applied gradually. The pressure gauge must be accurate. The pipes and fittings shall be tested in sections as the work laying proceeds, keeping the joints exposed for inspection during the testing.

3.0. Mode of measurements and payment

3.1. The description of e, item shall, unless otherwise stated be held to include where necessary. conveyance, and delivery, handling, unloading, storing fabrication, hoisting, all labour for finishing to required shape and size, setting, fitting in position straight, cutting and waste return of packing etc.

3.2. The length shall be measured on running meter basis of finished work. The length shall be taken along the centre line of the pipe and fittings. The pipes fixed to wall, ceiling, floors etc shall be measured and paid under this item.

3.3. All the work shall be measured in decimal system as fixed in its place, subject to tolerance given below unless otherwise stated.

(i) Dimension shall be measured to the nearest 0.01 meter. (ii) Area shall be worked out to the nearest 0.01 sq. meter.

3.4. All measurements of cutting shall unless otherwise stated by held to include the consequent waste

3.5. In case of fitting of unequal bore, the targets bore shall be measured for the test.

3.6. Testing of pipe lines fittings, and joints include for providing all plant appliances necessary for obtaining access to the work to be tested an carrying out the tests

3.7. The rate includes galvanised steel tubing with .screwed socket joints. to gather with all fittings (such as bends, sockets springs, elbows, test, crosses, short pieces, clamps and plugs, unions etc.) and fixing complete with clamping wall hooks, wooden plug etc. and also curing, screwing and waste and for making forged (or hand made) bends on piping as required. Connector shall be inserted where required or directed. The rate also includes cutting through walls, floors etc. and their making good and painting exposed threads with anti-corrosive paint as above and testing where tubes are to be fixed to wall ceiling and flooring, the rates shall not include painting of pipes, providing sleeves and sand filling under floor for which separate payment shall be made.

3.8. The rate shall be for a unit of one running meter.

23.4. Providing and laying in trenches galvanised mild steel tubes (Medium grade) of the following nominal bore and tube fittings-earth work in trenches to be measured and paid for separately ; (A) 15 mm. dia. (B) 20 mm. (C) 25 mm. (D) 40 mm. (E) 60 mm. (F) 80 mm.

1.0. Materials

1.1. Galvanised mild steel tube of specified dia. nominal bore and fittings shall conform to I.S. 1239-1968

2.0. Workmanship

2.1. The relevant specifications of Hem 23.2 (A) shall be followed for cutting laying an j jointing testing of joints except that the fixing of tube shall be done in trenches,

2.2. The width and depth of the trenches for different diameters of tht, tubes shall he is under, For 15 to 80 mm. dia tube width of trenches shall be 30 cms. and depth of trenches 60 cms,

2.3. All joints, the trench width, shall be widened where necessary. The work of excavation and refilling shall be done true to line, and gradient in accordance with general specifications of earth work in trenches

2.4. The pipes shall be painted with two coats of anti-corrosive bitumastic paint of approved quality. The pipe shall be laid on a layer of 75 mm. sand filled upto 150 mm. above the pipe of so specified. The remaining portion of trench shall be then filled with excavated earth. The surplus shall be disposed off as directed.

2.5. When the excavation is done in rock the bottom shall be cut deep enough to permit the pipe to be laid and cushion of sand 75 mm. in case of bigger diameter of tube where the pressure is very high thrust block of cement concrete 1:2:4 (1 cement : 2 coarse sand : 4 grade stone aggregates of 20 mm nominal size) shall be constructed on all bends to transmit the hydraulic thrust without impairing the ground and spreading it over a sufficient area if so specified.

3.0. Mode of measurement

3.1. The relevant specifications of item No. 23.2 (A) shall be followed. The authorised quantities shall be 162

3.2. For purpose of calculating cubic content cross section shall normally be taken at suitable intervals i.e. at manhole of wall chamber intervals except in abnormal cases like sudden change in strata or undulating ground etc., when they may be taken at closer intervals as approved by the Engineer-in charge whose decision shall be final, conclusive and binding.

3.3. Authorised width :

(a) Up to the meter depth, the width of the trenches for the purpose of measurements of excavation shall be arrived at by adding 40 cms. to the external diameter of the tube (not the socket) where a pipe is laid on concrete bed/ Cushing layer, the authorised width shall be the external diameter of tube plus 40 cms. or the width of the concrete bed cushioning layer whichever is more.

(b) For depths exceeding one meter an allowance of 5 cms. per meter of depth for each side of the trench shall be added to the authorised width (i.e. external diameter of pipe of plus 40 cms) This allowance shall apply to the entire depth of the trench. The authorised width in such cases shall therefore be, equal to the depth of trench, plus external diameter or tube plus 40 cms.

(c) Where more then one tube is laid, the diameter shall be reckoned as the horizontal distance of outside to outside of the outermost pipes.

(d) Where sheeting etc. has been provided the authorised width of the trenches at bottom shall be increased to accommodate for sheeting etc. so that the clear width available between faces of sheeting is as per previous ness of (a), (b) & (c) above.

(e) If the sides of the trench are not vertical, the tones of side slopes shall end at the top of the pipe and vertical sided trench of authorised width as per (a), (b), (c) and (d) above shall be excavated from these down to the bed of trenches.

3.4. Where the tubes are laid in trenches, the work of excavation and refilling and round tubes for which separate payment shall be made, the length shall be measured on running meter, basis.

3.5. The rate shall be-for a unit of One running meter.

23.6. Marking connection of galvanised M/S. distribution branch with galvanised mild steel main 80 mm. nominal bore by providing and fixing tee including, cutting and threading the pipes etc. complete.

1.0. Materials The fittings required of specified dia. of pipe shall conform to I.S. 1237-1986.

2.0. Workmanship

2.1. A pit of suitable dimensions shall be dug at the point where the connection is to be made with the main and earth removed up to 150 mm. below the main. The flow of water in water main shall also be disconnected by closing the sluice or wheel valves on the main. The main shall first be cut. Water if any, collected in the pit shall be bailed out and ends of the pipe threaded.

2.2. The connections of distribution pipe shall be made by fixing malleable galvanised mild steel tee of the required size and fitting such as jam nut, socket, connecting piece etc,

2.3. The testing of the joints shall be done as per relevant specifications of item No. 23.2 (A).

3.0. Mode of measurements and payment

3.1. The rate includes cost of all labour, materials, tool and plant required for satisfactory completion of 'this item.

3.2. The rate shall be for a unit of One number.

23.8. Providing and fixing to wall ceiling and floor 6 Kgs/Sq. Cm. working pressure polythene pipes of the following outside diameter, low density complete with special flag compression type fittings wall clips etc. including making good the wall/ceiling and floor. (A) 20 mm. dia. (B) 25 mm. dia (C) 32 mm. dia. (D) 40 mm. dia. (E) 50 mm. dia.

1.0. Materials

1.1. The low density polythene pipe of specified diameter with 6 Kg/Sq. Cm, working pressure shall conform to I.S. 3076-1968. The specials and fittings required shall be of best quality.

2.0. Workmanship

2.1. The P.V.C. pipes of specified diameter shall be fixed as directed. Due to thermal expansion of rigid ' P.V.D. pipes, due allowance shall be made particularly in over ground pipe lines for any change in length of pipe line which may occur during installation or when pipe line which may occur during installation or when pipe line is in service.

2.2. Above ground installation of rigid P.V.C. pipe should be under taken after preparations are observed for their protection against direct sun rays and mechanical damage.

2.3. The rigid P.V.C. pipe lines should not be kept exposed above ground when it passes through public places, railway lines, road side and foot paths.

163

2.4. P.V.C. pipes shall be supported at the following intervals :

-20 mm. dia 500 mm. -25 mm. dia 750.mm. -32 mm. dia.900 mm.

2.5. Closer support spacing shall be provided if recommended by the manufacture.

2.6. The guide lines indicated by the manufacturer regarding handling, transportation, storing, laying and jointing pf pipes shall be kept in view during execution.

2.7. P.V.C. pipes shall be fixed on wall with wooden plugs and suitable plastic clamps.

2.8. Jointing the pipes :

2.8.1. The pipes and sockets shall be accurately cut. The ends of the pipes and fittings should be absolutely free from dirt and dust. The outside surface of the pipes and the inside of the fittings shall then be roughened with emery paper, and then solvent cement joint. Since solvent cement is aggressive to P.V.C. care must be taken to avoid applying excessive cement to the inside of pipe sockets as any surplus cement cannot be wiped of after jointing. Empty solvent cement tins, brushes, rags, or paper impregnated with cement should not be buried in the trenches. They should be gathered not left scattered about, as-they can prove to be a hazard to animals, which may chew them.

2.8.2. If any manufacturer recommends its own methods of jointing the same shall be adopted after necessary approval from the Engineer-in-charge.

2.9. Laying pipes in Trenches :

2.9.1. The pipes shall be laid over uniform relatively soft fine trained soil found to be free of presence of hard object such as large flints, rocky projections, large tree roots etc. The width of the trenches shall be minimum width required for working.

2.9.2. The pipes laid underground shall not be less than one meter from the ground level. The pipe shall be positioned in the trenches so as to avoid any induced stressed due to deflection. Any deviation required shall be obtained by using proper type of rubber ring joints.

3.0. Mode of measurements & payment

3.1. The relevant specifications of item 23.2. (A) shall be followed except that the P.V.C. pipes of specified dia. shall be paid under this item.

3.2. The unit rate shall be for a unit of One running meter.

23.111.(A)(I) Providing and fixing water closet squatting pan (Indian type W.C. Pan) size 580 mm. (Earth work, bed concrete, foot-rests and trap to be measured and paid for separately). Vitreous china. Long pattern white colour.

1.0. Materials

1.1. Water closet squatting pan (Indian type W.C. Pan) shall conform to M-62. Cement mortar shall conform to M-11

2.0. Workmanship

2.1. The pan shall be sunk into the floor and embedded in a cushion of average 15 cm. cement concrete 1:5:10 (1 cement : 10 graded stone aggregate or brick aggregate 40 mm. nominal size) or and its bed concrete, the floor should be left 115 mm. below the top level of the pan so as to allow for flooring and its bed concrete. The floor should be suitably stopped so that the waste water is drained into the pan. The shall be provided with 100 mm. 'P' or 'S' trap as specified in the item No. 23.113 with approximately 50 mm seal-The joints between the pan and the trap shall be made leak-proof with cement mortar 1:1 (1 cement : 1 fine sand).

3.0. Mode of measurements and payment

3.1. The rate shall include the cost of all materials and labours involved in the operations described under workmanship.

3.2. The rate shall be for a unit of One number.

3.3. The 'P' or 'S' trap unit of One number.

23.79. Providing and fixing cast spigot and sockets soil, waste, and ventilating pipes of the following normal size (B) 75 mm. dia. (C) 100 mm. dia.

1.0. Materials

1.1. The specified dia. C.I. Spigot and socket soil or waste pipe shall conform M-68.

164

2.0. Workmanship

2.1. The fixing of C.f. spigot and sockets soil, waste and ventilating pipe shall be carried out as per relevant specifications of item 15.93 (B) except the C.I. spigot and socket shall be fixed. The joints shall be filled with cement mortar 1:2 (1 cement : 2 sand) span spun yarn. The joints shall be filled with cement mortar 1.2 (1 cement : 2 sand) and spurn yarn. The pipes without care shall be fixed to wall with M.S. clamps The pipes will earns shall be secured with 40 mm before steel or iron barrel distance pieces or bolts and stout galvanised iron nails 10 cms long into hand wool plug fixed in walls. Access doors to fittings shall be provided with 3 mm. rubber insertion packing and secured without screws to made air and water tight

2.2. All soil pipes shall be earned up above the roof and shall have a wire ball on guarded or a cowl.

2.3. The ventilating pipe or shaft shall be carried out to a height of at least one meter above the outer covering of the roof of the building or in the case of windows in a gable wall or a dormer windows, it shall t carried up to a ridge of the roof or at least tow meters above the top of the windows. In case of flat roof to which access for use is provided, it shall be carried out up to a height of at least on meter above the parapet or two meters measured vertically from the top of any windows or opening which any exist up to a horizontal distance of five meters from the vent pipe into such building and in no case shall be carried out to a height less then three meters.

2.4. Where ventilating pipes are carried in pipe shafts, the shaft shall be of a minimum size of one meter. If !he shells are also used to give fight and air to rooms, the ventilating pipes must be carried out to a horizontal distance at root level not loss than five meter from the site of the shaft.

2.5. The sand cast iron pipes above parapet shall be fixed with M.S. clamps and stays. The clamps shall be made from 1.5 mm. thick MS flat or 3 mm. width band to the required shape and size to fit tightly one the sockets when tightened with screw bolts. It shall be formed of two semi circular pieces with flanged ends on both sides, with holes to fit in the screw bolts and nuts 40 mm. dia. M.S. Bars, One end of the stay shall be bent to form a hook to be fixed with clamps by means of bolts and the other end shall be bent for embedding in wall in cement concrete block of size 200 mm. x 100 mm. x 100 mm. in 1:2:4 mix. The concrete shall be finished to match the surrounding surfaces.

2.6. The connection between the main pipe and branch pipes shall be made by using branches and bends with access doors for cleaning

2.7. The waste from lavatories, kitchens basins, sinks, baths and other floor traps shall be separately connected to respective stacks of upper floor. The waste stack of lavatories shall be connected directly to main hole while the waste stack of other shall be separately discharged over gulley trap.

3.0. Mode of measurements and payment

3.1. The length of pipe shall be measured including all fittings along its length in running meters correct to a centimeter. No allowance shall be made for the portion of pipe length entered in the sockets of the adjacent pipe of fittings.

3.2. The rate includes all labour, and materials, tools and plant etc. required for satisfactory completion of this item.

3.3. The rate shall be for a unit of One running meter.

23.87. Providing and fixing cast iron (spun) Nahni trap of the following nominal diameter of self cleaning design with C.I. Screwed down or hinged grating including cost of cutting and making good the waifs and floors : 100 mm. Inlet and 50 mm. outlet.

1.0. Materials

1.1. The cast iron (spun) Nahni trap shall conform to M-69. The C.I. hinged or screwed down cover shall be of best quality

2.0. Workmanship

2.1. The Nahni trap with 100 mm. dia inlet and 50 mm. dia. outlet shall be fixed as per drawing or as directed.

2.2. The Nahni trap shall be jointed with C.I. Pipe, 75 mm. dia. with lead joints. The lead joints shall be done in conformation with I.S. 782.-1976.

3.0. Mode of measurements and payment

3.1. The rate includes cost of all labour, materials, tools and plants etc. required for satisfactory completion of this

item including lead, jointing and testing.

3.2. The rate shall be for a unit of one number.

165

23.112.(A)(I) Providing and fixing wash down water closet (European type W.C. Pan) with integral 'P' or 'S' trap including jointing the trap with soil pipe in C.M. 1:1 (1 cement : < fine sand) (seat and cover to be measured and paid for separately) ; Vitreous china pattern : In white colour,.

1.0. Materials

Wash down water closet (European type W.C. Pan) shall conform to M-60. Cement mortar shall conform to M-11.

2.0. Workmanship

2.1. The closet shall be fixed to the floor by means of 75 mm. long 6.5 mm. diameter counter sunk bolts and nuts embedded in the floor concrete using rubber or before washers so as not to allow any lateral displacement The joint between the trap of W.C. and soil pipe shall be made with C.M. 1:1 (1 cement : 1 fine sand).

3.0. Mode of measurements and payment

3.1. The rate shall include the cost of all materials and labour involved in all the operations described under workmanship.

3.2. The rate includes cost of all labour for fixing pans and seat and cover, inlet, connections etc. complete including testing the same. The payment of seat and cover shall be made separately.

3.3. The rate shall be for a unit of One number.

23.113.(A) Providing and fixing 100 mm. size 'P' or 'S' trap for water closet squatting pan including jointing the trap with the pan and soil pipe in cement mortar 1:1 (1 cement : 1 fine sand) Vitreous China.

1.0. Materials : The 100 mm. size 'P' or 'S' trap for water closet shall conform to M-62. Cement mortar shall conform to M-11.

2.0. Workmanship

2.1. The 'P' or 'S' trap shall be fixed with pan cast iron pipe with C.M. 1:1. The pan shall be provided with a 100 mm. 'P' or 'S' trap as specified in the item with an approximately 50 mm. seal The joint between the pan and the trap shall be made leak-proof with cement mortar 1:1(1 cement : 1 fine sand).

3.0. Mode of measurements and payment

3.1. The rate shall include the cost of all materials and labour involved in the operations described under workmanship including testing.

3.2. The rate shall be for a unit of one number.

23.114. Providing and fixing in C.M. 1:3 (1 cement : coarse sand) a pair of white vitreous china 250 mm. x 130 mm. 30 mm. foot rest for long pattern squatting pan water closet.

1.0. Materials

1.1. The pair of white vitreous china foot-rests shall conform to M-62 Cement mortar shall conform to M-11.

2.0. Workmanship

2.1. After laying the floor, the floor shall be suitably sloped so that the waste water is drained into the pan A pair of foot-rests of size 250 mm. x 130 mm. x 30 mm. of white vitreous china shall be set in cement mortar 1:3 (1 cement ; 3 coarse sand). The foot-rests shall be fixed at a distance of 175 mm. from the inner edge of the back side of the pan and shall be fixed at convenient angle.

3.0. Mode of measurements & payment

3.1. The rate shall include the cost of all materials and labours involved in all the operations described under workmanship.

3.2. The rate shall be for a unit of One pair.

23.115.(A)(I) Providing and fixing 12.5 liters low level flushing cistern with a pair of C.I. or mild steel brackets complete with fittings such as lead valve less syphon, 15 mm. nominal size brass ball valve with polythene float, C.P. brass ball handle, unions and couplings for connections with inlet, outlet and overflow pipes, 40 mm. dia. porcelain enameled flush bend including cutting holes in walls and making good the same and connecting the flush bend with cistern and closet (overflow pipe to be measured and paid for separately) : Vitreous China. In white colour.

1.0. Materials

1.1. The low level vitreous china (Enamel) flushing tank shall conform to M-65 except that the flushing cistern shall be 12.5 liters low level type as mentioned in the item.

166

2.0. Workmanship

2.1. The low level cistern shall be firmly fixed on two C.I. or mild steel, brackets which shall be firmly embedded in the wall in C.M. 1:4 (1 cement : 4 fine sand).

2.2. The height of the bottom of the cistern from the top of the pan shall be 30 cms of low level flushing cistern shall be connected to the closet by means of 40 mm. dia, white porcelain enameled flush bend using Indian rubber adapts joints. The flush pipe shall be securely connected to the cistern outlet by means of coupling nut made of any non-corrosive materials, non-ferrous metal or galvanised steel. The flush pipe from the cistern shall be connected to the closet by means of cement of red-lead.

3.0. Mode of measurements & payment

3.1. The rate shall include the cost of all materials fitting and labour involved in all the operations described under workmanship including testing.

3.2. The rate shall be for a unit of One number.

23.116. Providing and fixing 12.5 liters level C.I. flushing with a pair C.I. or mild steel brackets, complete with fittings such as syphonic arrangement, 15 mm. nominal size brass ball valve with polythene flat, lever. G.I. China (60 cms.) and pull unions and couplings for connections with inlet, outlet and overflow pipes etc. including cutting holes in walls and making good the same (overflow pipe to be measured and paid for separately).

1.0. Materials

1.1. The high level C.I. flushing cistern shall conform to M-66, except that the flushing cistern shall be of 12.5 liters high level C.I. cistern as mentioned in the item.

2.0. Workmanship

2.1. The cistern shall be fixed on two C.I. or mild steel brackets which shall be firmly embedded in the wall in cement mortar 1:4 (1 cement : 4 fine sand).

2.2. The height of the bottom of the cistern from the top of the pan shall be two meters.

2.3. The W.C. Pan shall be connected to the cistern by galvanised steel flush pipes of 32 mm. nominal internal diameter. The flush pipe shall be fixed to wall by using clamps. The flush pipe from the cistern shall be connected to the closet by means of cement or red-lead. The flush pipe shall be securely connected to the cistern outlet by means of coupling nut made of any non-corrosive materials non-ferrous metal or galvanised steel.

2.4. The chain and the pull union shall be fixed to the protruding level arm of the flushing cistern.

2.5. The whole installation shall be tested for leak-proof joints and satisfactory functioning.

3.0. Mode of measurements & payment

3.1. The rate shall include the cost of all materials, fittings, and labour involved in all the operations described under workmanship including testing.

3.2. The rate shall be for a unit of One number.

23.117. Providing and fixing in position with clamps etc. 32 mm. nominal internal dia. galvanised steel tube flush pipe for high level flushing cistern including connecting the flush pipe with cistern and closet and making good the walls and floors.

1.0. Materials

1.1. The 32 mm. nominal internal dia, galvanised steel tube flush pipe shall conform to M-56.

2.0. Workmanship

2.1. The W.C. pan shall be connected to the cistern by galvanised steel flush pipe of 32 mm nominal internal diameter. The flush pipe shall be fixed to wall by using clamps.

2.2. The flush pipe from the cistern shall be connected to the closet by means of cement or red-lead.

2.3. The flush pipe shall be securely connected to the cistern outlet by means of coupling nut made of any noncorrosive materials, non-ferrous metal or galvanised steel.

3.0. Mode of measurements and payment

3.1. The rate shall include the cost of all materials, fittings and labour involved in all the operations described under workmanship including testing.

3.2. The rate shall be for a unit of One running meter.

23.120. Providing and fixing G.I. inlet connection for flush pipe with W.C. Pan.

167

1.0. Materials

1.1. The G.I. inlet connection for flush pipe shall conform to M-56.

2.0. Workmanship

2.1. The flush pipe from the cistern shall be connected to the closet by means of cement or red-lead.

3.0. Mode of measurements & payment

3.1. The rate shall include the cost of all materials, fittings and labour involved in all the operations described under workmanship including testing.

3.2. The rate shall be for a unit of One number.

23.127. Providing and fixing wash basin with single hole for pillar top white C.I. or M.S, brackets painted white including cutting holes, and making good the same but excluding fittings, vitreous china flat back wash basin 550 mm. x 400 mm. in white colour.

1.0. Materials

1.1. The white glazed earthenware wash basin shall be 550 mm. x 400mm. of 1st quality and make as approved by the Engineer-in-charge. The wash basin shall-conform to M-59.

2.0. Workmanship

2.1. The washbasin shall be fixed on the wall as and where directed. The wash basin shall be supported on a pair of M.S. or C.I. brackets fixed in C.M. 1:3 (1 cement : 3 sand). The bracket shall conform to I.S. : 775-1962. The wall plaster on the rear shall be cut to rest the top edge of the washbasin. After fixing the basing, plaster shall be made good and surface finished to match the existing one.

2.2. The brackets shall be painted white with ready-mixed paint.

2.3. The C.I. brass trap and union shall be connected to 32 mm. dia. waste pipe which shall be suitably bent towards the wall and which shall discharge into an open drain leading to a gully trap or direct in to gully-trap on the ground floor and shall be connected to a waste pipe through a floor trap on the upper floors. C.P. brass trap and union may not be provided where the surface drain or a floor trap is placed directly under the basin and the waste is discharged in to vertically.

2.4. The height of the front edge to the wash basin from the floor level shall be 80 cms.

2.5. The necessary inlet, outlet connections and fittings such as pillar cocks, CP dress waste trap waste pipe, stop cock, chain wish rubber plug etc. shall be fixed.

2.6. The payment of fittings shall be made separately under separate items.

3.0. Mode of measurements & payment

3.1. The rate includes cost of all labour, materials, tool³ and plant etc. required for satisfactory completion of this item as specified in workmanship.

3.2. The rate shall be for a unit of One number.

23.130. (C) Providing and fixing kitchen sink with C.I. or M.S. brackets painted white including cutting holes in walls and making good the same of but excluding fittings. Vitreous china sink 600 mm. x 450 mm. x 150 mm. size.

1.0. Materials

1.1. White glazed vitreous china sink 600 mm. x 450 mm. x 150 mm. size shall conform to M-63.

2.0. Workmanship

2.1. The kitchen sink shall be supported on a pair of M.S. or C.I. brackets fixed in cement mortar 1:3 (1 cement : 3 coarse sand). The M.S. or C.I. brackets shall conform to I.S. 775-1962. The wall plaster on the rear shall be cut to rest over the top edge of the sink. After fixing the sink, plaster shall be made good and the surface finished to match with the existing one.

2.2. The C.P. brass trap and union shall be connected to 40 mm. nominal bore galvanised mild steel waste pipe which shall be suitably bent towards the wall and which shall discharge into an open drain leading to gully-trap or direct into the gully-trap on the ground on floor and shall be connected to a waste pipe through a floor trap on the upper floors. C.P. brass trap and union may not be provided where surface drain or a floor trap is placed directly under the sink and the waste is discharged to it vertically.

2.3. The height of front edge of the wash basin from the floor, level shall be 80 cms.

3.0. Mode of measurements & payment

3.1. The rate includes cost of all labour, materials, tools and plant and other equipment required for satisfactory completion of this item as described in workmanship.

168

3.2. The rate shall be for a unit of One number.

23.135 (A) Providing and fixing 32 mm, dia. C.P. brass waste for wash basin or sink.

1.0. Materials

1.1. The C.P. brass trap and unions shall be of 32 mm. dia. and of best quality and make as approved by the Engineer-in-charge

2.0. Workmanship

2.1. C.P. brass waste trap and union shall be connected to 32 mm dia waste pipe which shall be suitably bent towards the wall which shall discharge into drain through a floor trap The C.P brass waste trap shall be provided for wash basin or sink as the case may be.

3.0. Mode of measurement & payment

3.1. The rate includes all labours and providing C.P. brass waste trap and union including waste couplings of 32 nun fin. The rate excludes the cost of waste pipe of 32 mm. dia.

3.2. The idle shall be for a unit of One number.

23.135. (B) Providing and fixing 40 mm dia. C.P. Brass waste for wash basin or sink.

1.0. Materials & Workmanship

1.1. The relevant specifications of item 23.135 (A) shall be followed except that the diameter of C.P. brass waste is 40 mm dia.

2.0. Mode of measurements & payment

2.1. Thu rate shall be for a unit of One number.

23.136. (A) Providing and fixing 32 mm. dia. M.I. union for wash basin or sink.

1.0. Materials

1.1. Tho 32 mm dia M.1. Fisher union shall be of best quality and made as approved by the Engineer-in-charge.

2.0. Workmanship 2.1. The 32mm dia M I. Fisher union shall be fixed to wash basin or sink in best workman like manner.

3.0. Mode of measurements and payment

3.1. The rate includes all labours .and materials, tools and plants etc. required for satisfactory completion of the item.

23.136. (B) Providing and fixing 40 mm, dia. M.I. fisher union for wash basin or sink.

1.0. Materials and Workmanship

1.1. The relevant specifications of item No. 23, 136 (A) shall be followed except that the diameter of M I fisher union shall be 40 mm. dia.

2.0. Mode of measurements of payment

2.1. The rate shall be for a unit of One number

23.139. Providing and fixing 100 mm. dia, sand cast iron grating for gulley floor or Nahni tarp.

1.0. Materials

1.1. The- 100 mm. dia. sand cast iron gratings for gulley, floor or Nahni trap shall be of best quality and make as approved.

2.0. Workmanship

2.1. The CAST IRON grating shall he provided to gulley trap floor or Nahni trap as the case may be in best workmen like manner.

3.0. Mode of measurements and payment

3.1. The rate shall includes cost of all labour, materials, tools and plants, etc. required for satisfactory completion

of this item.

3.2. The rate shall be for a unit of One number.

23 :141.(A) Providing and fixing 100 mm. dia, C.P, brass shower rose with 15 mm or 20 mm. inlet.

1.0. Materials

1.1. 100 mm. dia C.P. brass shower lose shall confirm to I S. 2556-1972 part - XI and of best quality and makes as approved by engineer-in-charge. The inlet of shower rose shall be 15 mm dia. or 20 mm dia. as directed.
169

2.0. Workmanship

2.1. The C.P. brass shower rose shall be fixed as directed with 15 mm. dia. or 20 mm. dia. G.I. inlet pipe as the case may be.

3.0. Mode of measurements and payment

3.1. The rate includes all labours and materials, tools and plant etc. required for satisfactory completion of this item

3.2. The rate shall be for a one number.

23.143. Providing and fixing 600 mm. x 450 mm. beveled edge minor of superior glass mounted on 6 mm. thick A.C. Sheet or plywood sheet and fixed to wooden plugs with C.P brass screws and washers,

1.0. Materials

1.1. The 600 mm. x 450 mm. size mirror snail be of superior glass with edge rounded offer beveled as specified. It shall be free from flaws specks, or bubbles and its thickness shall riot be less than 6 mm. The glass for the mirror shall be uniformly silver plated at the back and shall be free from silvering defects Silvering shall have a protective uniform covering of red lead paint. The 6 mm thick ply wood shall conform to M-37. The 6 mm. thick A.C. sheets shall conform to M-24.

2.0. Workmanship

2.1. The mirror of 600 mm. x 450 mm. size mounted on A.C. Sheet or plywood 6 mm thick with C.P. brass clips shall be fixed as directed, by fixing wooden plugs in wall and C.P brass screws and washers. The work shall be carried out in best workman like manner.

3.0. Mode of measurements & payment

3.1. The rate includes cost of all labour and materials, tools and plant etc. required for satisfactory completion of this item. The rate shall be for a .unit of One number.

23.144.(B) Providing and fixing 600 x 20 mm. C.P. brass towel rail complete with C.P. brass brackets fixed to wooden plugs with and C.P. brass screws.

1.0. Materials

1.1. The C.P. brass towel rail shall be 600 x 20 mm. of best quality as approved by the Engineer-in-charge The brackets shall be of C.P. brass. The rail shall conform to I.S. 1068-1958.

2.0. Workmanship

2.1. The brackets of the towel rail shall be fixed by means of C.P. brass screws to wooden firmly embedded in the wall with C.M. 1:3 (1 cement : 3 coarse sand). The **towel** rail shall be fixed as and where directed.

3.0. Mode of measurements and payment

3.1. The rate includes cost of all labour and materials, tools and plant etc. required for satisfactory completion of this item.

3.2. The rate shall be for a unit of One number.

23.145. Providing and fixing 600 mm. x 120 mm. glass shelf with C.P. brass brackets and guard rail complete, fixed to wooden plugs with C.P. brass screws.

1.0. Materials : The glass shelf of 600 mm. x 120 mm. size-shall be of 5 mm. thick plate glass. The edge of the glass shall be grounded. The C.P. over brass guard rail shall be best quality and make.

2.0. Workmanship

2.1. The C.P. brass brackets of the glass shelf shall be fixed with C.P. screws to wooden plug firmly embedded in the wall C.M. 1:3 (1 cement : 3 coarse sand). The C.P. guard rail shall be fixed to glass shelf as directed.

3.0. Mode of measurement and payment

3.1. The rate includes all labour and materials tools and plant etc. required for satisfactory completion of this item,

3.2. The rate shall be for a unit of One number.

23.146.(A) Providing and fixing C.P. brass toilet paper holder.

1.0. Materials : The toilet paper holder shall be of best quality and make, chromium plating shall be of grade 'B' type conforming to I.S. 1068-2958.

2.0. Workmanship

2.1. The toilet paper holder shall be fixed in position be means of screws and wooden plugs embedded in wall with cement 1:3 (1 cement : 3 coarse sand).
170

3.0. Mode of measurements and payment

3.1. The rate includes cost of all labour and material, tools and plant etc. required for satisfactory completion of this item.

3.2. The rate shall be for a unit of One number.

23.92.(A)(I) Providing and fixing brass screw down bib taps of following size. Polished bright : 14 mm. dia.

1.0. Materials : 15 mm. dia. brass screw down with bright polished finished shall conform to I.S. 781-1977. The bib cock shall be best Indian make and quality.

2.0. Workmanship

2.1. The screw down bib cock 15 mm. as specified above shall be fixed as directed. The threaded portion shall be smeared with white or red lead and around with a few turns of fine spun yarn round the screwed end of the pipe. The bib cock shall be then screwed and fixed to water tight position.

3.0. Mode of measurements and payment

3.1. The rate includes cost of all labour, materials, tools and plant etc. required for satisfactory completion of this item.

3.2. The rate shall be for a unit of One Number.

23.92.(A)(I) Providing and fixing brass screw down bib taps of following size : Polished bright: 20 mm. dia.

1.0. Materials and Workmanship

The relevant specifications of item 23.92 (A) (i) shall be followed except that the bib taps of 20 mm. dia shall be fixed.

2.0. Mode of measurements & payment

2.1. The relevant specifications of item 23.92 A(i) shall be followed.

2.2. The rate shall be for a unit of One number.

23.92.(B)(I) Providing and fixing chromium plated brass screw down bib taps of the following size : 15 mm. dia.

1.0. Materials and workmanship

The relevant specification of item No. 23.92 (A) (I) shall be followed except that the brass chromium plated screw down tap of 20 mm. dia. shall be fixed.

2.0. Mode of measurements & payment

2.1. The rate shall be for a unit of One number.

23.92.(B)(II) Providing and laying chromium plated brass screw down bib taps of following size : 20 mm. dia.

1.0. Materials and workmanship

The relevant specifications of item No. 23.92 (A) shall be followed except that the brass chromium plated screw down tap of 20 mm. dia. shall be fixed.

2.0. Mode of measurements & payment

2.1. The rate shall be for a unit of One number

23.92.(C)(I) Providing and fixing gun metal screw down bib taps of the following size : 15 mm. dia.

1.0. Materials and workmanship

1.1. The relevant specification of item No. 23.9*3 (A) (I) shall be followed except that the 15 mm. dia. gun metal screw down bib tap shall be fixed.

2.0. Mode of measurements & payment

2.1. The rate shall be for a unit of One number,

23.92.(C)(II) Providing and fixing gun metal screw down bib taps of following size : 20 mm. dia.

1.0. Materials & Workmanship

1.1. The relevant specifications of item 23.92 (A) (i) shall be followed except that the 20 mm. dia. gun screw down bib tap shall be fixed.

2.0. Mode of measurements & payment

2.1. The rate shall be for a unit of One number.

23.95(A) Providing and fixing pillar tap capstan head screw down high pressure with screw shank and back nuts : (A) 14 mm. dia. (B) 20 mm. dia.

1.0. Materials : The capstan head pillar tap of specified dia. of C.R over brass shall be best quality and shall conform to I.S. : 1975 - 1961. The pillar taps shall be tested quality.

171

2.0. Workmanship

2.1. The capstan head pillar tap of specified dia. shall be fixed as directed with required washers of selected leather or rubber asbestos composition or of plastic as directed. The cock shall fixed with pipe line white Zink end spun yarn, to make joint water tight. The work shall be carried out in best workman like manner.

3.0. Mode of measurements and payment

3.1. The rate shall be for a unit of one number.

23.96(A) Providing and fixing brass screw down stop cock (A) 15 mm. dia. (B) 20 mm. dia. (C) 25 mm. dia.

1.0. Materials : The brass screw down stop cock of specified dia shall conform to IS. : 781 -1977 The stop cock shall be of tested quality.

2.0 Workmanship

The stop cock shall be fixed in position by means of Jam nut and socket. The stop cock shall be fixed near the inlet of the water meter or as directed. The joints shall be done with white zinc and spun yarn. The joint shall be tested for leak proofing.

3.0. Mode of measurements and payment

3.1. The rate includes cost of all labours, materials, tools and plant etc. required for satisfactory completion of this item.

23.99. Providing and fixing gunmetal check or non-return valve. (A) 15 mm. dia. (B) 20 mm. dia. (C) 25 mm. dia. (D) 32 mm. dia. (E) 40 mm. dia.

1.0. Materials : The gun metal check or not return full way wheel valve or specified dial, shall conform to I.S. : 778-1964. The non-return valve shall be of tested quality.

2.0. Workmanship

2.1. The gun metal check or non return valve shall be fully cleared of all foreign matter before fixing. The fixing of shall be done by means of bolts nuts and 3 mm. rubber insertions with flags of spigot and socketed tail pieces, drilled to the same specifications as in case of socket and spigot flanges in case of flanged pipes. The joining shall be done leak proof.

3.0. Mode of measurements and payment

3.1. The rate includes all labours, **materials, tools and plant etc. required for** satisfactory completion of this item.

3.2. The rate shall be for a unit of **One number.**

23.00. Providing and fixing chromium plated brass half turn flush cock of approved quality including fixing in pipe line etc. complete (I) 20 mm. dia. (II) 25 mm. dia. (III) 32 mm. dia.

1.0. Materials : Chromium plated brass half turn flush cock shall conform to M-67.

2.0. Workmanship

The half turn flush cock of specified diameter shall be fixed as directed. The flush cock shall be fixed in G.I. pipe line with necessary fittings. The joints shall be made leak proof by using spun yarn and white Zink. The fixing work shall be carried out as per relevant specifications of item No. 23.2(4).

3.0. Mode of measurements and payment

3.1. The rate includes cost of all materials and labour required for satisfactory completion of this item including fittings.

3.2. The rate shall be for a unit of One number.

23.00.4. Providing and fixing chromium plated bottle trap with necessary coupling of approved quality for wash basin.

1.0. Materials : The chromium plated bottle trap shall be approved make and of best quality. The bottle trap shall be provided with coupling.

2.0. Workmanship

The bottle trap shall be fixed on wash hand basin with wooden gullies and screws as directed. The work shall be carried out in best workman like manner.

172

3.0. Mode of measurements and payment

3.1. The rate includes cost of all materials and labour involved for satisfactory completion of this item.

3.2. The rate shall be for a unit of One number.

23.122. (A) Providing and fixing urinal of approved quality including connecting the urinal with waste pipe trap etc. complete : white earthenware flat back or corner type size 430 mm. x 260 mm. x 350 mm.

1.0. Materials: The white earthenware flat back or corner type urinal of size 430 mm. x 260 mm. x 350 mm. shall conform to M-64.

2.0. Workmanship

2.1. The urinals shall be fixed in position by using wooden plugs and screws and shall be at a height 65 cms. from the Moor level to the top of the lip of urinal, unless otherwise directed. The wooden plugs shall be of 50 mm. x 50 mm. at base tapering to 38 mm. x 38 mm. at top 50 mm. in length shall be fixed in wall in steel waste pipe which shall discharge in the channel or floor a tap. The connection between the urinal and flush or waste pipe shall be made by means of putty or white lead mixed with chopped hemp.

3.0. Mode of measurements and payment

3.1. The rate shall include cost all labours, materials, tools and plants etc. required for satisfactory completion of this item.

3.2. The rate shall be for a unit of One number.

23.124. (A) Providing and fixing urinal of approved quality including connection with trap and with integral longitudinal flush pipe squatting plate pattern white earthenware 550 mm. x 300 mm.

1.0. Materials : The squatting plate pattern, white glazed earthenware urinal of 550 mm x 300 mm shall conform to I.S. 771-1063. It shall be test India make.

2.0. Workmanship

2.1. The squatting plate urinal shall be fixed as directed.

2.2. The top edge of the squatting plate shall be flush with the finished floor level adjacent to it. It shall be embedded on a layer of 25 mm. thick cement mortar 1:8 (1 cement: 8 fine sand) laid over a bed of burnt brickbat cement 1:5 :10(1 cement: 5 fine sand, 10 graded brick aggregate 20 mm. nominal size). There shall be 100 mm. dia. glazed earthenware or vitreous china channel as specified with stop and outlet pieces suitably fixed in floor in cement mortar 1:3 (1 cement: 3 coarse sand) and joint finished with white cement. The earthenware vitreous china shall discharge into 65 mm. C.P. brass outlet grating. The trap and fitting shall be fixed as directed.

3.0. Mode or measurements and payment

3.1. The rate includes .cost of all materials, tools and plants and labour required for satisfactory completion of this item.

3.2. The rate shall be for a unit of One number

23.134 Providing and fixing rubber plug for sink or wash basin.

1.0. Material: The rubber plug for sink or wash hand, basin shall be best quality and make as approved by the Engineer-in-charge.

2.0. Workmanship -

2.1. The rubber plug with plain shall be fixed in wash basin or sink as directed.

3.0. Mode of measurements and payment

3.1. The rate shall be for a unit of One number.

23.00.5.(A) Providing and fixing ball cock of approved quality as directed (Copper metal) : (I) 25 'mm. dia.

(II) 50 mm. dia;

1.0. Materials :

The ball cock of specified diameter shall conform to M-75

2.0. Workmanship

The ball cock of specified diameter shall be fixed as directed. The fixing of ball cock shall be carried out as per relevant specification of item No. 23 (A) for joints etc.

173

3.0. Mode of measurement & payment

3.1. The rate includes-cost of all materials and labour involved for carrying out satisfactory work.

3.2. The rate shall be for a unit of One number.

23.00.5.(B) Providing and fixing ball cock of approved quality as directed : Ebonite. (I) 25 mm. dia. (II) 50 mm. dia.)

1.0. Materials & Workmanship : The relevant specifications of item No. 23.00.5 (A) shall be followed except that the ball cock of specified dia of Ebonite shall be fixed.

2.0. Mode of measurements & payment

2.1. The relevant specifications of item NO. 23.00.5 (A) shall be followed.

2.2. The rate shall be for a unit of One number.

23.00.6. Providing and fixing C.I. Manhole cover 0.60 C.M. x 0.45 C.M. size having weight not less than 35 kg.

1.0. Materials

C. I. Manhole cover of 0.60 x 0.45 Cms. size shall be of best quality. The weight of C.I. cover and frame shall not be less than 35 Kg. The C.I. manhole cover shall be of light duty and conform relevant I.S.

2.0. Workmanship

2.1. The C.I. Manhole cover shall be fixed as per relevant specifications of item No. 24.44 except that the C.I. cover shall be fixed as and where directed.

3.0. Mode of measurements and payment

3.1. The rate includes cost of all labour and materials required for satisfactory completion of this item.

3.2. The rate shall be for a unit of One number.

23.00.7. Providing and fixing G.I. water spout of 50 mm. dia. and 30 cms length.

1.0. Materials : G.I.M.S. type of 50 mm. dia. shall conform to M-56.

2.0. Workmanship

2.1. The G.I. pipe of 30 cms. fixed as rain water pipe as directed. The pipe shall be fixed about 1/4 dia. below the floor level so as to make approach of water easy. The inlet of pipe shall be rounded off for easy entry of rain water pipe. The pipe shall be fixed in C.M. 1:3.

3.0. Mode of measurements & payment

3.1. The rate includes of all labour and materials required for satisfactory completion of this item.

3.2. The rate shall be for a unit of One number.

23.8. Providing and fixing to wall ceiling and floor 6 Kg/ Sq. cm, working pressure outside diameter, low density completion with special flange compression type fittings wall clips etc. including making good the wall, ceiling and floor. (A) 20 mm. dia. (B) 25 mm. dia. (C) 32 mm. dia. (D) 40 mm. dia. (E) 50 mm. dia.

1.0. Materials : The low density polythene pipe of specified diameter with 56 Kg/f. Sq. Cm. working pressure shall conform to I.S. 3076-1968. The specials and fittings required shall be of best quality.

2.0. Workmanship

2.1. The P.V.C Pipes of specified diameter shall be fixed as directed. Due to thermal expansion of rigid P.V.C. Pipes, due allowances shall be made particularly in over-ground pipe line for any change in length of pipe line which may occur during installation or when pipe line is in service.

2.2. Above ground installation of rigid P.V.C. pipe should be undertaken after precautions are observed for their protection against dirt, sun rays and mechanical damage.

2.3. The rigid P.V.C. pipes should not be kept exposed above ground when it passes through public places, railway lines, roads, road side and foot paths.

2.4. P.V.C. pipe shall be supported at the following intervals ;
-20 mm dia 500 mm. -25 mm. dia. 750 mm. -32 mm. dia. 900 mm.

2.5. Close support spacing shall be provided if recommended by the manufacturer.

2.6. The guide lines indicated by the manufacturer regarding handling, transportation, storing, laying and jointing of pipes shall be kept in view during execution.

174

2.7. P.V.C. pipes shall be fixed on wall with wooden plugs suitable plastic clamps.

2.8. Jointing the pipes :

2.8.1. The pipes and socket s shall be accurately cut. The ends of the pipes and fittings should be absolutely free from dirt and dust. The outside surface of the pipes and the inside of the fittings shall then be roughened with emery paper, and then solvent cement shall be applied to the matching surface and pushed home and joint. Since solvent cement is aggressive to P.V.C. care must be taken to avoid applying excessive cement to the inside of pipe sockets as any surplus cement cannot be wiped off after jointing. Empty solvent cement tins, brushes, rags of paper impregnated

with cement should not be buried in the trenches. They should be gathered, not left scattered about, as they can prove to be a hazard to animals, which may chew them.

2.8.2. If any manufacturer recommends its own methods of jointing the same shall be adopted after necessary approval from the Engineer-in-charge.

2.9. Laying pipes in trenches:

2.9.1. The pipes shall be laid over uniform relatively soft fine grained solid found to be free of presence of hard object such as large feints, rocky projections, large tree roots etc. The width of the trenches shall be minimum width required for working.

2.9.2. The pipes laid underground shall not be less than one meter from the ground level. The pipe shall be positioned in the trenches so as to avoid any induced stresses due to retraction. Any deviation required shall be obtained by using proper type of rubber ring joints.

3.0. Mode of measurements & payment

3.1. The relevant specifications of item No. 23.2. (A) shall be followed except that the P.V.C. pipes of specified dia. shall be paid under this item.

3.2. The unit rate shall be for a unit of One running meter.

175

SECTION-24

24.1.(A) Providing any laying (two level or slopes) and jointing with stiff mixture of cement mortar in proportion 1:1 salt glazed stone-ware pipes, following nominal internal diameters including testing of pipes and joints complete : 100 mm. dia.

1.0. Materials

(I) Water shall conform to M-1(2) Cement mortar of proportion 1:1 shall conform to M-11. (3) 100 mm. dia. glazed stoneware pipe shall conform to M-71.

2.0. Workmanship

2.1. The trenches for stoneware pipe drains shall be carried out as per relevant specifications of item No. 23.4 (A) except that the work is for stoneware pipes of 100 mm. dia.

2.2. Laying:

2.2.1. The pipes shall be laid accurately and perfectly true to line, levels and gradients, Great care shall be taken to prevent sand etc. from entering the pipes. The pipes between two manholes shall be laid truly in a straight line without vertical or horizontal undulation. All junctions and changes in direction and diameter shall be made inside manholes by means of curved tapered channels formed in Cement concrete finished smooth and benched on both sides. The body of the pipe shall rest for its entire length, on a even level bed grips being made or left on the bed to receive the sockets of the pipes.

2.3. Jointing:

2.3.1. Tared gask in or yarn soaked in neat cement slurry shall first be placed around the spigot to each pipe and the spigot shall then be placed well home into the socket of the pipe previously laid. The pipe shall then be adjusted and fixed in the correct position and gaskin caulked home so as to fill not more than 1/4th of the total depth or (13 mm. in depth) of the socket.

2.3.2. The remainder of the sockets shall be filled with stiff mixture of cement mortar in proportion of one part of cement and one part of sharp sand. When the socket is fillet, a filled shall be formed round the joints with a trowel, forming an angle of 45° with the barrel of the pipe.

2.3.3. The mortar shall be mixed as necessary for immediate use.

2.3.4. After the joint is made, any extraneous materials shall be removed from the inside of the joints with a suitable scraper or "badger". The newly made joints shall be protected, until set, from the sun, dry winds, rain or frost, sacking or other suitable materials which shall be used for the purpose.

2.3.5. The mortar shall be cured for 10 days.

2.4. Testing of Joints:

2.4.1. If any leakage is visible the defective part of the work shall be made good at no extra cost. The pipe line shall be tested as directed.

2.4.2. A slight amount of sweating which is uniform may be overlooked, but excessive sweating from a particular pipe or joints shall be watched for and taken as indicating a defect to be made good.

3.0. Mode of measurements and payment

3.1. Pounding or buttering of the fit trenches bed to the lower part of the pipe and "Grips" dug to take socket, collars etc. are included in the rate of laying the pipes.

3.2. The measurements shall be net without any allowance for cutting, and waste. The length of bends, junctions, and other connections shall be included in the total length of the drain pipes. Nothing extra shall be paid for the same. The rate includes necessary excavation refilling trenches etc. complete,

3.3. The rate shall be for a unit of One running meter.

24.1.(B) Providing and laying and jointing salt glazed stoneware pipes with lime concrete 1:2:4 (1 lime :2 fine sand : 4 graded brick aggregate 40 mm, nominal size)bedding with necessary form work and curing etc. complete : 150 mm. dia.

176

1.0. Materials & Workmanship : The relevant specifications of item 24.1.(A) shall be followed except that the that diameter of pipe shall be 150 mm. dia.

2.0. Mode of measurements and payment

2.1. The relevant specifications of item No, 24.1. (A) shall be followed.

2.2. The rate shall be for a unit of One running meter.

24.2.(A) Providing and laying cement concrete 1:5:10 (1 cement : 5 fine sand : 10 graded stone : aggregate 40 mm. nominal size) bedding for stoneware pipe of following internal diameter with necessary form work and curing complete : 100 mm. dia. 300 mm. width (112 mm. average bed thickness).

1.0. Materials : (1) Water shall conform to M-1 (2) Cement shall conform to M-3. (3) Sand shall conform to M-6 (4) Stone aggregate 40 run nominal size shall conform to M-12.

2.0. Workmanship

2.1. The relevant specifications of item 5.3.4. shall be followed except that the concrete work shall be carried out in trenches as bedding for stoneware pipes. The width of concrete shall be 300 mm. and average thickness of bedding shall be 112 mm The concrete shall be brought up at least to the invert level of the pipe to form a cradle and to avoid line contact between the pipe and the bed.

3.0. Mode of measurements & payment

3.1. The rate includes cost of all labour and materials required for satisfactory completion of this item.

3.2. The rate includes cost of necessary form work required if any

3.3. The rate shall be for a unit of One running meter.

24.2.(B) Providing and laying cement concrete 1:5:10 (1 cement : 5 fine sand : 10 graded stone aggregate 40 mm. nominal size) bedding for stoneware pipe of following internal diameter with necessary form work and curing complete : 150 mm. dia. 450 mm. width (166 mm. average bed thickness),

1.1. Materials & Workmanship : The relevant specifications of item 24.2 (A) shall be followed except that the cement concrete work shall be carried out for bedding of stoneware pipe of 150 mm. dia. The average thickness of bedding shall be- 166 mm. and width shall be 450 mm.

2.0. Mode of measurements & payment

2.1. The relevant specifications of item 24.2 (A) shall be followed.

2.2. The rate shall be for a unit of One running meter.

24.19(1) Providing and fixing S.W. gully trap with C.I. grating brick masonry chamber and watertight C.I. cover with frame of 300 mm. x 300 mm. size (Inside) with standard weight : (A) square mount taps 100 mm. x 100 mm. size P. type

1.0. Materials : (1) Water shall conform to M-1. (2) Cement mortar of proportion 1:5 shall conform to M-11. (3) Burnt brick shall conform to M-15. (4) The S.W. Gully trap of 100 mm. x 100 mm. size shall conform to M-70.

2.0. Workmanship

2.1. Excavation for gully trap shall be done true to dimensions and levels as indicated on plans or as directed. The excavation work shall generally be done as per relevant specifications of item 4.0.0. of earth work.

2.2. Fixing:

2.2.1. The gully trap shall be fixed over cement concrete 1:5:10 (1 cement : 5 sand : 10 graded brick bats aggregate 40 mm nominal size) foundation. 650 square and 100 mm. thick The depth of top of concrete below the ground level shall be 675 mm. The jointing of gully outlet to the branch drain shall be done similar to jointing of S.W. pipe as described in item No. 24.1 (A).

2.3. **Brick masonry chamber :** After fixing and testing gully and branch drain, a brick masonry 300 x 330 mm. inside with bricks in CM 1:5 (1 cement : 5 sand) shall be built with a 100 mm. brick work round on; gully trap from the top of bed concrete up to ground level. The space between the chamber walls and

the trap shall be filled with cement concrete 1:5:10. The upper portion of the chamber i.e. above the top level of the trap shall be plastered inside with cement mortar 1:3 (1 cement: 3 sand) finished with floating coat of neat cement. The corners and bottom of the chamber shall be rounded off so as to slope towards the grating.

2.4. C.I. cover with frame 300 mm, x 300 mm. (inside) size shall then be fixed on the top of the brick masonry with C.c. 1:2:4 (1 cement : 2 coarse sand : 4 graded aggregate 20 mm. nominal size) 40 mm. thick and rendered smooth. The finished top of the cover shall be left about 40 mm. above the adjoining ground level so as to exclude the surface water from entering the gully trap.

3.0. Mode of measurements & payment

3.1. The rate includes cost of all labour, materials, tools and plant etc. required for satisfactory completion of this item as described above.

3.2. The rate shall be for a unit of one number basis.

24.22. Providing and laying (to level or slopes) and jointing reinforced concrete light duty non-pressure pipes I.S. class N.P. 2 of the following internal diameters with collars and butt ends prepared for collar joints including testing of joints etc. complete. (B) 150mm. (C) 250 mm. (D) 300 mm. (E) 450 mm. (F) 500 mm. (G) 600 mm. (H) 900 mm.(K) 1000mm. (M) 1200 mm.

1.0. Materials : The reinforced concrete light duty non-pressure pipes of specified diameter shall conform to I.S. 458-1971.

2.0. Workmanship

2.1. The relevant specifications of item No. 24.1. A shall be followed for work of trenches except that the excavation in trenches shall be for. reinforced concrete pipes of specified diameter.

2.2. Laying

2.2.1. The pipes shall be lowered into the trenches carefully. Mechanical appliances may be used. Where necessary pipe shall be laid in straight lines or with easy curves and true to line and gradient as specified. The laying of pipe shall proceed up grade of a slope. In the pipe spigot and socket joints, the socket ends shall face upstream. In

case of pipes with joints to be made with loose collars, the collars shall be slipped on before the next pipe is laid.

2.2.2. In case where the foundation conditions are unusual such as the proximity of trees or holes, under existing or proposed all round in 150 mm. thick cement concrete 1:5; 10 (1 cement: 5 fine sand : 10 graded stone aggregate 40 mm. nominal size) or compacted sand or gravel:

2.2.3. In case where the natural foundation is inadequate the pipes shall be laid either in concrete cradle, supported on proper foundations or on any other suitably designed structure. If concrete bedding is used, the depth of concrete below bottom of the pipe shall be at least 1/4th of the internal diameter of the pipe subject to a minimum of 100 mm. and a maximum 300 mm. The concrete shall be extended up the sides of the pipe at least to a distance of 1/4th of the outside diameter for pipes 300 mm. and over in diameter.

2.2.4. The pipes shall be laid in the concrete bedding before the concrete has set. Pipes laid in trenches in earth shall be bedded evenly and firmly and as far as up to the haunches of the pipe as to safely transmit the load expected from the back fill through the pipe to the bed. This shall be done either by excavating the bottom of the trenches to fit the curve of the pipe or by compacting the earth under a round curve of the pipe to form an even bed, Necessary provision shall be made for joints wherever required.

2.3. Jointing

2.3.1. The joints shall be done by slipping the collar over and clear of the end of the pipe. The recess of the end of the pipe shall be filled with jute braiding in hot bitumen. The new pipe shall then be brought forward until the bitumen ring in recess of first pipe is set into the recess of the second pipe. The process shall be repeated for two or three pipes which shall then jacked up so as to thoroughly compress the bitumen. The quantity of jute and bitumen shall be just enough to fill the recess when pressed hard by jacking, care being taken that no offset of the jute braiding shall be visible either outside or inside of pipe. The collar shall then be set up over the joints covering equally both the pipe and leaving, an even caulking space all round. Cement and sand mortar: 1: 1.1/2 shall then be well punched or pressed home with a caulking tool within this caulking space. Care shall be taken that the underside of the joints is properly filled with mortar.

2.4. Curing

2.4.1. Every joints shall be kept wet for about 10 days for maturing. The section of the pipe line laid and jointed shall be covered immediately to protect from weather effects. Minimum bore of 100 mm. is considered adequate.

178

2.4.2. The joints shall be left exposed for observation.

2.5. Testing of Joints :

2.5.1. The testing of joints shall be done as per relevant specifications of item No. 24.1 (A) **except that** the testing of reinforced concrete pipes shall be done.

3.0. Mode of measurements & payment

3.1. The relevant specifications of item 24.1 (A) shall be followed except that the rate includes for laying to level or slope in trenches etc. (measured separately), making the joints a; Seated and testing to stand the water test.

3.2. The measurements shall be net without any allowance for cutting and waste. The length of bends, junctions and other connections (measured along the centre line) shall be included in the total length of the pipes, the connections being numbered afterwards and paid for extra over pipes.

3.3. The size of bend, junctions, etc, shall suit the size of pipe. The bore (internal diameter of pipe) shall be the criterion for payment.)

3.4. Nothing extra shall be paid separately for the use of mechanical appliances, where necessary, as described above.

3.5. The rate shall be for a unit of One running meter.

2.4.27. Costing Manhole with R.C.C. Top slab in 1:2:4 mix (1 cement: 2 coarse sand : 4 graded stone aggregate 20 mm. nominal size) foundation concrete 1:3:6 (1 cement : 3 coarse sand : 6 bricks bats 40 to 50 mm. size) inside plastering 15 mm. thick with C.M. 1:5 (1 cement : 5 coarse sand) finished with floating coat of neat cement and making channels in C.C. 1:2:4 mix (1 cement : 2 coarse sand : 4 stone aggregate 20 mm. nominal size) finished smooth complete including curing and testing (I) inside size 900 mm. x 120 mm. and 1.5 mm. deep, including C1 cover with frame size 560 mm. diameter, total weight of cover and frame to be not less than 128 Kgs. (Wt. of cover 64 Kg. and Wt. of frame 64 Kg.) (A) With 230 mm. thick walls of brick masonry using bricks having crushing strength not less than 35 kg/sq. cm. in C.M. 1:5 (1 cement : 5 coarse sand)

i. A type depth 0.90 meter for 150 mm. sewer

ii. B type depth 1.50 meter for 150 mm. sewer

iii. C type depth 2.25 meter for 150 mm. sewer

iv. D type depth 3.15 meter for 150 mm. sewer

1.0. Materials : Water shall conform to M-1. Cement shall conform to M-6. Burnt bricks shall conform to M-15. Brick bats of 40 to 50 mm. size shall conform to M-14. Stone coarse aggregate of 20 mm. nominal size shall conform to M-12. Grit shall conform to M-8. Cement mortar of specified proportion shall conform to M-11. The cast iron manhole cover of 560 mm. dia. with frame shall conform to I.S. 1726-1966.

2.0. Workmanship

2.1. The manholes of different types and sizes as specified shall be constructed in sewer line at such places and to such levels and dimension as shown in drawings of as directed.

2.2. The manholes shall be built on a bed of cement concrete 1:3:6 (1 cement : 3 coarse sand : 6 brick bats) (40 to 50 mm. nominal size) to the thickness of the bed concrete shall be 15 cms. for manhole up to 1. M. depth and 20 cms. for manholes over meter and up to over meter and up to 2 meters, depth and 30 cms. for manholes o greater

depth.

2.2.2. Projection of bed concrete beyond the masonry wall shall be 15 cms.

2.3. Walls

2.3.1. The walls of manhole shall be carried out with burnt bricks using having bricks. crushing strength not less than 35 Kg/Cms in C.M. 2 in C.M. 1:5 (1 cement : 5 coarse sand). The thickness of brick masonry wall shall be 230 mm. The jointing face of such brick shall be well buttered with cement mortar before laying so as to ensure a full joints.

2.4. Plaster

2.4.1. The inside of walls shall be plastered 15 mm. thick with C.M. 1:5 (1 cement : 5 coarse sand) and finished with floating coat of neat cement. All angles shall be rounded to 7.50 cms. radius and all rendered internal surfaces shall have hard impervious finish obtained by using a steel trowel. The external joints of masonry shall be finished smooth.

179

2.5. Channels & Benching :

2.5.1. Channels shall be semicircular in the bottom half and of diameter equal to the sewer. Above the horizontal diameter, the sides shall be extended vertically to the same level as the crown of the out going pipe and the top edge shall be suitably rounded off. The branch channels shall also be similarly constructed with respect to the benching but at their junction with the main channel an appropriate fall suitably rounded off in the direction of flow the main channel shall be given.

2.5.2. The channel and benching shall be done in C.C. 1:2:4 (1 cement : 2 coarse sand : 4 graded stone aggregate 20 mm. nominal size) rising at a slope in line from edges of channel. The channels of the bottom of the chamber shall be plastered with C.M. 1:2 (1 cement : 2 coarse sand) and steel troweled smooth.

2.6. Cover slab:

2.6.1. The cover slab of R.C.C. 1:2:4 (1 cement: 2 coarse sand: 4 graded stone aggregate 20 mm. nominal size) 15 cms. thick reinforced with 10 mm. bars at 15 cms. C/C both ways, surface and edges finished fair. Full bearing equal to the width of wall shall be given to the slab on all sides. The frame of manhole cover shall be embedded firmly in R.C.C. slab so that the top of the frame remains flush with the top of R.C.C. slab.

2.7. Testing:

2.7.1. Manhole shall be tested by filling with water to a depth not exceeding 1.2 M. as directed.

2.7.2. After completion of work, manhole cover shall be sealed by means of thick grease.

3.0. Mode of measurements and payment

3.1. The depth of manholes shall be distance between the top of the manhole cover and the invert level of the main drain. The rate includes all labours, materials, tools, and plant etc. required for satisfactory completion of this item as directed above.

3.2. The rate shall be for a unit of the One number.

24.28.(I) Extra rate for constructing B.B. masonry for every additional depth of 0.1 M. or part thereof over item 24.47 (I) for depth from 0.90 to 1.5 M.

1.0. Materials and Workmanship

The relevant specifications of item No. 24.27 (I) shall be followed for excavation same, except that the depth of manhole shall be done 0.1 M. or part thereof of more than 0.90 meter up to 1.5 M. The extra payment shall be made for additional depth of 0.1 M. or part thereof manhole done over and above the depth 0.90 meter.

2.0. Mode of measurements and payment

2.1. The relevant specifications of item No. 24.27 (I) shall be followed except that the extra rate shall be paid for every additional depth of 0.1. M. and part thereof shall be paid over and above the rate of item No. 24.27 (I)

2.2. The rate shall be for a unit of One number.

24.28.(II) Extra rate for constructing B.B. masonry for every additional depth of 0.1 M. and Part thereof over item 24.27 (II) for depth from 1.5 M. to 2.25 M.

1.0. Materials and Workmanship : The relevant specifications of item No. 24.27 (II) shall be followed except that the depth of manhole shall be done 0.1 M. or part thereof more than 1.5 M. up to 2.25 M. The extra payment shall be made for additional depth of 0.1 M. or part thereof manhole done over and above the depth 1.50 M. up to 2.25 M.

2.0. Mode of measurements & payment

2.1. The relevant specifications of item No. 24.27 (II) shall be followed except that the extra rate shall be paid for 0.1 M. or part thereof additional depth of manhole provided over and above item 24.27 (II).

2.2. The rate shall be for a unit of One number.

24.28.(III) Extra rate for constructing B.B. masonry for every additional depth of 0.1 M. or part thereof over item 24.27 (III) for depth from 2.25 to 3.15 M.

180

1.0. Materials and Workmanship : The relevant specifications of item No. 24.27 (III) shall be followed except that the depth of manhole shall be done 0.1 M. or part thereof more than 2.25 M. up to 3.15 M. Extra payment shall be made for additional depth of 0.1. M. or part thereof manhole done over and above depth 2.25 M. up to 3.15 M.

2.0. Mode of measurements & payment

2.1. The relevant specifications of item No. 24.27 (III) shall be followed except that the extra rate shall be paid for every additional 0.1 M. or part thereof depth provided over and above item 24.27 (III).

2.2. The rate shall be for a unit of One number.

24.28.(IV) Extra rate for constructing B.B. masonry for every additional depth of 0.1 M. or part thereof over item 24.27 (IV) for depth above 3.15 M.

1.0. Materials and Workmanship : The relevant specifications of item No. 24.27 (IV) shall be followed except that the depth of manhole shall be done 0.1 M. or part thereof more than 3.15 M above. 1.2. Extra payment shall be

made for additional depth of manhole 0.1 M. or part thereof done above 3.15 M. and above depth.

2.0. Mode of measurements and payment

2.1. The relevant specifications of item 24.27 (IV) shall be followed except that extra rate shall be paid for every additional 0.1 M. or part thereof depth provided for an above item 24.27 (IV).

2.2. The rate shall be for a unit of One number.

24.33. Providing and fixing C.I. steps of sizes 500 x 150 mm. 22.5 mm. and painting with two coats of anti-corrosive paint etc. complete.

1.0. **Materials** : The C.I. steps of size 500 x 150 x 22.5 mm. size shall conform J.S. 5455-1969. Paint shall conform to M-44.

2.0. Workmanship

2.1. The C.I. steps of size 500 x 150 x 22.5 mm. size shall be fixed in manhole as and where directed. The steps shall be staggered in vertical runs 380 mm. apart horizontally. The top step shall be 450 mm. below the manhole cover and lowest not more than 300 mm. above the benching. The steps shall be embedded in wall of manhole with C.C. : 1:3:6 up to 200 m. depth and the surface finished with cement plaster 15 mm. thick in C.M. 1:5. The steps shall be painted with two coats of anti-corrosive paint.

3.0. Mode of measurements & payment

3.1. The rate includes all labour, materials, tools and plants etc. required for satisfactory completion of this item.

3.2. The rate shall be for a unit of One number.

24.39. Providing and erecting at the site of work steel ventilating column of 150 mm. internal dia. and 12.20 M. high from G.L. to bottom of top grill, including C.I. grill and base plate, bolts and nuts etc. and excavation in foundation of size 120 x 120 x 165 cms. and filling the pit with 1st layer of cement concrete 1:3:6 mix (1 cement: 3 coarse sand : 6 graded stone aggregate 20 mm. nominal size) of size 120 x 120 x 90 cm. and remaining pit with B.B,C.C. 1:3:6 mix (1 cement : 3 coarse sand : 6 brick bats 40 to 50 mm. size) and providing filled in cement concrete : 1:2:4 mix (1 cement : 2 coarse sand : 4 graded stone aggregate 20 mm. nominal size) at G.L. and 3 coats of silver paint etc. complete.

1.0. Materials :

The steel ventilating column internal dia. 150 mm. 12.20 m. high shall be of standard many and best quality as approved. Stone aggregate of 20 mm. nominal size shall conform to M-12. Brick-bats-40 to 50 mm. nominal size shall conform to M-4. Cement shall conform to M-3. Water shall conform to M-1. Silver (Aluminum) paint shall conform to I.S. 2339-1963.

2.0. Workmanship

2.1. The vent shaft shall be provided at the starting point of main sewer and at such points where the flow of sewerage is disturbed i.e. at falls, siphons etc. As far as possible, the location shall be at such a place where it receive Sundays for the maximum period of the day.

2.2. A pit of 120 x 120 x 165 ms. size shall be dug The cement concrete of 1:3:6 (1 cement : 3 coarse sand : 6 graded stone aggregate 20 mm. nominal size) shall be first laid in the pit to form 90 cms. thick 181

concrete foundation which shall be allowed to set for 24 hours. The vent shaft shall then be erected at the centre of the pit truly in plumb by means of such as shear legs, pullies, backless and rope etc.

2.3. The connection with sewer man-hole shall be made using 150 mm. diameter cement concrete pipe. After the connection is completed, the pit shall be filled with cement concrete : 1:3:6 (1 cement: 3 coarse sand : 6 brick bats 40 to 50 mm. nominal size) round the vent shaft up to ground level except top 150 mm. which shall be filled with C.C. 1:2:4 (1 cement : 2 coarse sand : 4 graded stone aggregate 20 mm. nominal size) and rendered smooth. The junction of vent shaft with cement concrete shall be grouted with cement mortar 1:1 (1 cement : 1 sand). The concrete work shall be cured for 7 days.

2.4. The steel shaft shall be painted with silver paint (aluminum paint) 3 coats. The relevant specifications of item of painting shall be followed for painting.

3.0. Mode of measurements and payment

3.1. The rate shall include the cost of all labours and materials, tools and plant etc. required for satisfactory completion of this item as directed above.

3.2. The rate shall be for a unit of One number.

24.00.1.(A) Providing and laying lime concrete 1:2:4 (1 Lime Putty : 2 fine sand : 4 graded brick aggregate 40 mm. nominal size) bedding for stoneware pipes of following internal diameters with necessary form work and curing complete : 100 mm. dia (112 mm. average, bed thickness).

1.0. **Materials** : Water shall conform M-1. Lime mortar shall conform to M-10. Brick aggregate 40 mm. nominal size shall conform to M-14.

2.0. Workmanship

The relevant specifications of item No 5.1.8 shall be followed except that the proportion of mix shall be 1:2:4 (1 Lime Putty : 2 fine sand : 4 graded brick bats aggregate 40 mm. nominal size) and the concrete work shall be done in trenches for bedding of stoneware pipes of 100 mm. dia. The width of concrete shall be 300 mm. and the thickness of bedding shall be 112 mm. average.

3.0. Mode of measurements and payment

3.1. The relevant specifications of item 24.2 (A) shall be followed.

3.2. The rate shall be for a unit of One running meter.

24.00.1(B) Providing and laying lime concrete 1:2:4 (1 Lime Putty : 2 fine sand : 4 graded brick aggregate 40 mm. nominal size) bedding for stoneware pipes of following internal diameters with

necessary form work and curing complete :150 mm. dia. (166 mm. average bed thickness).

1.0. Materials and workmanship : The relevant specifications of 24.00.1 (A) shall be followed except that the concrete bedding shall be carried out for 150 mm. dia. stoneware pipe. The width of concrete bedding shall be 450 mm. and the average thickness shall be 166 mm.

2.0. Mode of measurements and payment

2.1. The relevant specifications of item No. 24.2 (A) shall be followed.

2.2. The rate shall be for a unit of One running meter.

24.27(I) Extra over item 24.1 for providing salt glazed stoneware fittings : Bends of required degree (Any Radius) of following internal diameters : A-100 mm. dia. B-150 mm. dia.

1.0. Materials & Workmanship

The relevant specifications of item 24.1 (A) shall be followed that the salt glazed stoneware bends of any degree of specified diameter shall be provided.

2.0. Mode of measurement & payment

2.1. The relevant specifications of item No. 24.1 (A) shall be followed except that extra payment shall be made for providing salt glazed stoneware bend of specified diameter or required degree of any radius over above the of item No. 24.1.

2.2. The rate shall be for a unit of One number.

182

24.17.(I)(A) Extra over item 24.1 for providing salt glazed stoneware fittings : Taper bend of required degree of following internal diameter. 100 mm. x 150 mm.

1.0. Materials & Workmanship : The relevant specifications of item 24.1 (A) shall be followed except that the salt glazed stoneware taper bend of required degree of 100 mm. x 150 mm. shall be fixed.

2.0. Mode of measurements & payment

2.1. The relevant specifications of item No, 24.1 (A) shall be followed except that extra payment shall be made for providing salt stoneware taper bend of required degree of 100 mm. x 150 mm. size over and above the rate of item No. 24.1.

2.2. The rate shall be for a unit of One number.

24.17.(II) Extra over item 24.1 for providing salt glazed stoneware fittings : Single junction of required angle of following internal diameter (A) 100 mm. dia. (B) 150 mm. dia.

1.0. Materials & Workmanship

The relevant specification of item 24.1 (A) shall be followed except that the salt glazed stoneware single of junction required angle of specified diameter shall be fixed.

2.0. Mode of measurements & payment

2.1. The relevant specifications of item 24.1 (A) shall be followed except that the extra rate shall be paid for providing salt glazed stoneware single junction of required angle for specified diameters over and above the rate of item 24.1.

2.2. The rate shall be for a unit of One number.

24.18. Providing and laying, jointing and jointing and pointing with stiff mixture of C.M. 1 : 1 (1 cement : 1 find sand) 150 mm. internal diameter salt glazed stoneware half round channels.

1.0. Materials and Workmanship : The relevant specifications of item 24.1 shall be followed except that the half round channels of 150 mm. internal diameters shall be fixed in cement mortar 1:1.

2.0. Mode of measurements and payment

2.1. The relevant specifications of item 24.1 (A) shall be followed.

2.2. The rate shall be for a unit of One running meter.

24.35. Supplying and fixing C.I. cover 300 x 300 mm. without frame for gully trap (Standard pattern), weight of cover shall not be less than 4.53 Kg.

2.0. Workmanship

The C.I. cover 300 x 300 mm. size without frame shall be fixed on top of the brick masonry with cement concrete : 1:2:4 (1 cement : 2 sand : 4 graded stone aggregate 20 mm. nominal size) 40 mm. thick and rendered smooth. The finished top of the cover shall be left about 40 mm. above the adjoining ground level so as to exclude the surface water from entering the gully trap.

3.0. Mode of measurements and payment

3.1. The relevant specifications of item No, 24.19 shall be followed.

3.2. The rate shall be for a unit of One number.

24.40. Constructing brick masonry road gully chamber 500 mm. x 450 mm. x 600 mm. including 500 mm. x 450 mm C.I. horizontal grating with frame complete.

1.0. Materials : Water shall conform to M-1. Cement shall conform to M-3. Sand shall confirm to M-6. Brick shall conform to M-15. C.I. Grating of 500 x 450 mm. size of standard make shall be of approved quality. Stone aggregate 40 mm. nominal size shall conform to M-12. coal tar shall conform to relevant M-5.

2.0. Workmanship

2.1. The chamber shall be of size 500 mm. x 450 mm. internal clear dimensions between the masonry wall faces. The height of 500 mm. shall be measured from the top of the bed concrete to the top of the C.I.

183

frame. The size of grating indicate the clear internal dimensions of the C.I. frame of the grating.

2.2. The excavation shall be done to true dimensions and levels.

2.3. The foundation concrete shall consist of 150 Cms x 100 Cms x 15 cms thick C.C. 1:5:10(1 cement : 5 sand : 10 graded stone aggregate 40 mm. nominal size).

2.4. The wall of the chamber shall be constructed in brick work C.M. 1:5 and 23 Cms. thick as per relevant specifications of item 6.12(8).

2.5. The walls and the bed concrete of chamber shall be plastered inside with 12 mm. thick cement plaster 1 : 3 (1 cement : 3 coarse sand) finished smooth.

2.6. The gully grating cover shall be hinged to frame to facilitate its opening for cleaning and repairs. The frames of the gully grating shall be fixed on the top of masonry wall of the chamber in 15 cms. thick C.C. 1:2:4 (1 cement : 2 coarse sand : 4 graded stone aggregate 20 mm. nominal size) laid over the full thickness of walls..

2.7. The chamber shall have connection pipe, the length of which in meter between the road gully chamber and the manhole of the drain shall not be less than 1/40 times the nominal diameter of the pipe in MM. i.e. for 150 mm* connection pipe the length shall not be cement plaster on the bed concrete.

2.8. **Painting** : After the completion of the work of exposed surface of the grating of the frame shall be painted with a thick coat of coal tar.

3.0. Mode of measurements and payment

3.1. The cost of connection pipes is not included in the item and shall be paid separately. However, fixing the connection pipes in the walls of gully chamber is included in the rate for gully chambers and nothing extra shall be paid for this separately.

3.2. The rate shall be for a unit of One number.

24.41. Constructing brick masonry road gully chamber 450 mm. x 450 mm. x 775 mm. with vertical grating complete.

1.0. **Materials and Workmanship** : The relevant specifications of item 24.40 shall be followed except size of road gully chamber is 450 mm x 775 mm. with vertical grating complete.

2.0. Mode of measurements and payment

2.1. The relevant specifications of item 24.40 shall be followed.

2.2. The rate shall be for a unit of one number.

24.42. Constructing brick masonry road gully chamber 1100 mm. x 500 mm. x 775 mm. including 500 mm. x 450 mm. C.I. horizontal grating with frame and vertical grating complete.

1.0. **Materials and Workmanship** : The relevant specifications of item 24.40 shall be followed except that the size of road gully chamber shall be 1100 mm. x 500 mm. x 775 mm. including 500 mm. x 450 mm. C.I. horizontal grating with frame and vertical grating complete.

2.0. Mode of measurements and payment

2.1. The relevant specifications of item No. 24.40 shall be followed.

2.2. The rate shall be for a unit of one sq. meter.

24.44(1) Constructing brick masonry chamber for underground C.I. inspection chamber and bends with brick having crushing strength not less than 35 Kg/ Cm. 2 in C.M/ 1:5 C.I. cover with frame (light duty) 455 x 610 mm. internal dimensions, total weight of cover with frame to be not less than 38 Kg. (Wt of cover 23 Kg. and Wt of frame 15 Kg.) R.C.C. top slab C.C. 1:2:4 mix (1 cement : 2 coarse sand : 4 graded aggregate 20 mm. size) foundation concrete 1:5:10, inside plaster 15 mm. thick with C.M. 1:3 finished smooth with a finishing coat of neat cement on walls and bed concrete etc. complete : Inside dimensions 455 mm. x 610 mm. and 450 mm. deep for single pipe-line.

184

1.0. **Materials** : Water shall conform to M-1. Cement shall conform to M-3. Coarse sand shall conform to M-5. Brick shall conform to M-15. Stone aggregate shall conform to M-12. Brick bat shall conform to M-14 M.S. bar shall conform to M-18.

2.0. Workmanship

2.1. C.I. inspection chamber with provision of C.I. bends of specified size with bolts, nuts and felt washers for underground drain shall be enclosed in masonry chamber which shall be constructed as under:

2.2. The excavation shall be done true to dimensions and level shown in one the plans or as directed.

2.3. Bed concrete shall be 15. Cms, thick C.C. 1:5:10 (1 cement : 5 coarse sand : 10 graded brick bat aggregates. The projection of bed concrete beyond the masonry walls shall be 7.5 cms.

2.4. Masonry walls and plaster work shall be carried out as per relevant specifications of item 24.40.

2.5. The cover slab shall be constructed as per relevant specifications of 24.27 (I).

3.0. Mode of measurements and payment

3.1. The earth work in excavation, providing and laying C.I. inspection chamber and bends shall be measured and paid for separately.

3.2. The rate shall be for a unit of One number.

24.44.(II) Constructing brick masonry chamber for underground C.I. inspection chamber and bends with brick having crushing strength not less than 35 Kg/ Cm. 2 in C.M/ 1:5 C. cover with frame (light duty) 455 x 610 mm. internal dimensions, total weight of cover with frame to be not less than 38 Kg. (Wt of cover 23 Kg. and Wt of frame 15 Kg.) R.C.C. top slab with 1:2:4 mix (1 cement : 2 coarse sand : 4 graded stone aggregate 20 mm size) foundation concrete 1:5:10, inside plaster 15 mm. thick with C.M. 1:3 finished smooth with a floating coat of neat cement on walls and bed concrete etc. complete : Inside dimensions 500 mm. x 700 mm. and 450 mm. deep for pipe the with one or two inlets.

1.0. **Materials and Workmanship** : The relevant specifications of item 24.24 (I) shall be followed except that the inside dimension of brick masonry chamber shall be 500 mm. x 700 mm. and 450 mm. deep for pipe the with two inlets.

2.0. Mode of measurement and payment

2.1. The relevant specifications of item 24.44 (I) shall be followed. 2.2 The rate shall be for a unit of one number.

24.44.(II) Constructing brick masonry chamber for underground C.I. inspection chamber and bends with brick having crushing strength not less than 35 Kg/ Cm. 2 in C.M/ 1:5 C.I. cover with frame (light duty) 455 x 610 mm. internal dimensions, total weight of cover with frame to be not less than 38 Kg. (Wt of cover 23 Kg. and Wt of frame 15 Kg.) R.C.C. top slab with 1:2:4 mix (1 cement : 2 coarse sand : 4 graded stone aggregate 20 mm. size) foundation concrete 1:5:10, inside plaster 15 mm. thick with C.M. 1:3 finished smooth with a floating coat of neat cement on walls and bed concrete etc. complete : Inside dimensions 600 mm. x 850 mm. and 450 mm. deep for pipes line with three or more inlets.

1.0. Materials and workmanship : The relevant specifications of item No. 24 .44 (I) shall be followed except that the inside dimensions of chamber shall be 600 mm, x 850 mm. and depth 450 mm. for pipe lines with three or more inlets.

2.0. Mode of measurements & payments

2.1. The relevant specifications of item 24.44(1) shall be followed.

2.2. The rate shall be for a unit One number.

185

24.46. Extra over item 24.44 for every additional depth of 1 M. or part thereof beyond 450 mm. depth for brick masonry chamber, (i) For 455 mm. x 610 mm. size (ii) For 500 mm. x 700 mm. size (iii) For 600 mm. x 850 mm. size.

1.0. Materials & Workmanship : The relevant specifications of item 24.44 (i),(ii) (iii) shall **be followed** same except that **extra** depth of 0.1 M. or part thereof shall be constructed over and above the depth of respective items.

2.0. Mode of measurements & payment

2.1. The relevant specifications of item 24.44 (I) shall be followed except that the extra shall be paid for, providing additional depth of 0.1 M. or M. or part thereof over and above the item No 24.44. (I) 24.44 (II) 24.44 (III) as the case may be.

2.2. The rate shall be for a unit of One number.

24.00.2.(A) Providing soak pit of 2 cum. volume including excavating and filling brick bats with dry masonry work at top for 450 cms. height including covering, the top with stone including providing Vatas in C.M. 1:3 with finishing curing etc. complete as directed.

1.0. Materials : Water shall conform to M-1. Cement mortar con form to M-11. Burnt Bricks shall conform to M-15. Rough stone slab 40 x 50 mm. thick shall conform to M-48. Brick bat shall conform to M-14.

2.0. Workmanship

2.1. The excavation for soak pit shall be carried out as. per relevant specifications of item. 4.G0.1 (A) except that the size of soak pit such that the cleat volume 'Shall* remain 2 cum. The diameter and depth shall be as directed.

2.2. The periphery of the sock pit shall be provided with dry masonry wall with burnt bricks in 23 cms. thick. The masonry wall shall be done with best workman like manner in true line and plumb.

2.3. The soak pit shall be filled in with brick bats of burn brick 40 mm. nominal size in 45 cms. height. The work of filling brick-bats shall be done in such a way that no dry masonry shall be damaged during filling of brick bats.

2.4. The top of the soak pit shall be covered with rough kotah stone slab 40 to 50 mm. thickness. The length of the stone shall be in single piece in length.

2.5. The cement mortar 1:3 shall be used to fill up the joints and preparing vata as directed.

2.6. The cement work shall be cured for 4 days.

3.0. Mode of measurements and payment

3.1. The rate includes costs of all labour and material required for satisfactory completion o this item as described above.

24.00.2.(B) Providing soak-pit of 5 cum. Volume inc. excavating and filling brick bats with dry masonry work at top for 45 cms. height including covering the top with stone including providing vatas in C.M. 1:3 with finishing curing etc. complete as directed.

1.0. Materials and workmanship : The relevant specifications of item 24.00.2 (A) shall be followed except that the volume of soak pit shall be 5 cum. clear.

2.0. Mode of measurements and payment

2.1. The relevant specifications of item 24.00.2 (A) shall be followed.

2.2. The rate shall be for a unit of One number.

186

EQUIVALENT PLAIN AREAS OF UNEVEN SURFACES

(Vide specifications for items relating to : Painting & Polishing)

Sr.

No.

Description of work How measured Multiplying Factor

1. Paneled or framed and braced on ledged and battened or ledged and braced joinery.

Measured flat (not girthed) including chowkhat or frame edges, chocks clients etc. shall be deemed to be included in item.

1.30 (For each said)

2. Flush joinery Measured flat (not girthed) including chowkhat or frame. Edges, Chocks, cleats, etc. shall be deemed to be included in the item.
1.20 (For each side)
3. Fully glazed or gauzed joinery Measured flat (not girthed) including chowkhat or frame. Edges, Chocks, cleats, etc. shall be deemed to be included in the item.
0.80 (For each side)
4. Partly paneled and partly glazed or gauzed joinery Measured flat (not girthed) including chowkhat or frame. Edges, Chocks, cleats, etc. shall be deemed to be included in the item.
1.00 (For each side)
5. Fully venetioned or louvered joinery. Measured flat (not girthed) including chowkhat or frame. Edges, Chocks, cleats, etc. shall be deemed to be included in the item.
1.80 (For each side)
6. Weather boarding Measured flat (not girthed) supporting frame work shall not be measured separately.
1.20.(For each side)
7. Wood single roofing Measured flat (not girthed) 1.10(For each side)
8. Boarding with cover fillets at match boarding Measured flat (not girthed) 1.05 (For each side)
9. Tile and Slate battening Measured flat, overall, no deduction shall be made for open space over over)
0.80 (For painting all over)
10. Trellis (or Jafri) work one way or two way Measured flat, over all, no deduction shall be made for the open spaces supporting members shall not be measured separately)
1.00 (For painting all over)
187
11. Guard, bars, balustrades, gates, graying, grills, expanded metal and railings. Measured flat over all, No deduction shall be made for the open spaces, over)supporting members shall not be measured separately.
1.00 (For painting all over)
12. Gates and open palisade fencing including standards Measured flat over all No. deduction shall be made of open spaces : supporting members shall not be measured separately, (see note).
1.00 painting all over
13. Curved or enriched work Measured flat 2.0 (For each side)
14. Steel roller shutter Measured flat (size of opening)over all jamb, guides bottom rails and locking arrangement etc., shall be included in the item (top cover shall be measured separately).
1.10 (For each side)
15. Plain sheet door and windows Measured flat (not including) frame 1.10 (For each side)
16. Full glazed or gauze steel door and windows Measured flat (not girthed) including Frame edges etc.
0.50 (For each side)
17. Partly paneled and partly glazed or gauzed steel doors

Measured flat (not girthed) including frame edges etc.

0.08 (For each side)

18. Collapsible gate Measured flat (size of opening) no separate measurements shall be taken for the top and bottom guide rails, rollers, fittings, etc.

1.50 (For painting all over

Note : The height shall be taken from the bottom of the lowest of rail if the palisades do not go below it (or from the lower end of palisades, if they protect below the lower rail) up to the top of palisades, but not upto the top of standards if they are higher then the palisades.

188

Sr. No.

Particulars of fixtures & fastenings

Size in mm

Da. S.1:B-900-T-38

Da. S.1:B-900-T-38

Da. S.1:B-900-T-38

Da. S.1:B-900-T-38

Da. S.2:B-900-T-38

Da. S.2:B-900-T-38

Da. S.2:B-900-T-38

Da. S.2:B-900-T-38

1. Hold fast 300 x 40 x 3 6 6 6 6 6 6 6

2. Hold Fast 200 x 40 x 36 - - - - -

3. Coach \screws (Hexagonal Head) - - - - -

4. Butt Hinges 125 - - - 3 - - - 6

5. Bun Hinges 100 3 3 3 - 6 6 6 -

6. Butt Hinges 75 - - - - -

7. Butt Hinges 75-A - - - - -

8. Butt Hinges 50 - - - - -

9. Non projecting type Hinges (Box type) 22 - - - - -

10. Tee & Strap Hinges 300 - - - - -

11. Tee & Strap Hinges 200 - - - - -

12. Sliding Door Bolts 250 x 16 1 1 1 1 1 1 1 1

13. Tower Bolts (Barrel Type) 200 x 10 1 1 1 1 2 2 2 2

14. Tower Bolts (Barrel Type) 150 x 10 - - - - -

15. Tower Bolts (Barrel Type) 100 x 10 - - - - -

16. Tower Bolts (Barrel Type) 75 x 10 - - - - -

17. Tower Bolts (Barrel Type) 50 x 6 - - - - -

18. Door Latch 200 x 16 x 5 1 1 1 1 1 1 1 1

19. A Hooks and Eye 20 mm - - - - -

20. Bathroom Latches 60 x 12 - - - - -

21. Casement window fasteners - - - - -

22. Casement Stays (Straight Peg Stay O - - - - -

23. Ventilator Catch Lug. - - - - -

24. Handles 100 2 2 2 2 2 2 2 2

25. Handles 75 - - - - -

26. Doorstopper 75 1 1 1 1 2 2 2 2

27. Wooden Door Stop with Hinges - - - - -

28. Continuous Piano Hinges 30 width 30 width - - - - -

29. Haps and Staples (Safety types) 115 x 40 - - - - -

30. Haps and Staples (Safety types) 90 x 40 - - - - -

31. Cupboard Lock (6 Levers) - - - - -

32. Cupboard Knob - - - - -

189

Sr. No.

Db : S.1

Dc : S.1 : 900

Dc : S.1 : B : 900

Dd : S.1 : B : 900

Dd : S.1 : B : 900

De : S.1 : B : 900

De : S.1 : B : 900

Wa : S.1 : H : 1200

Wa : S.1 : B : 1200

- Wa : S.2 : H : 1200
- Wa : S.2 : H : 1200
- Va : Ind.
- S.W.
- Sv-Ind
- Wardrobe-S.2
- Showcase : CC : S.2
- General : CB : S.2
- Kitchen : CB : S.2
- Platform : CB : S.2
- Countersunk Wood Screw
- Size of Screws in mm
- and No. of Screws per
- Unit of fixture fastenings
- 1. 6 6 6 - 6 6 6 4 6 4 6 ----- 2 ----
- 2. ----- 4 --- 4 4 4 ----- 2 ----
- 3. ----- 8 8 8 8 8 4 -----
- 4. ----- 8 ---
- 5. 3 ----- 8 --
- 6. ----- 2 3 4 6 2 ----- 6 ---
- 7. ----- 4 4 8 --- 6 --
- 8. ----- 4 -- 4 --
- 9. ----- 2 2 -----
- 10. -- 3 - 3 - 3 ----- 8 ----
- 11. - 3 - 3 - 3 ----- 7 ----
- 12. - 1 1 1 1 1 1 ----- 16
- 12
-
- 13. ----- 8 --
- 14. - 1 1 1 1 1 1 ----- 6 --
- 15. ----- 2 2 3 3 ----- 6 --
- 16. ----- 1 ----- 6 --
- 17. ----- 2 2 2 4 ----- 6
- 18. -- 1 1 1 1 ----- 2 -
- 19. ----- 1 1 2 2 1 2 1 -----
- 20. ----- 6/4
- 21. ----- 1 -----
- 22. ----- 1 1 -----
- 23. ----- 1 -----
- 24. 2 2 2 2 2 2 ----- 2 - 2 ---- 4 -
- 25. ----- 1 1 2 2 1 ----- 2 4 2 -- 4 -
- 26. ----- 8
- 4
-
- 27. - 1 1 1 1 1 1 ----- 6 -
- 28. ----- 2 - 2 ----- 2

- Per 75 mm. length
- 29. ----- 1 1 1 ----- 7
- 30. ----- 1 ----- 1 --- 7
- 31. ----- 4
- 32. ----- 1 -----
- 190

CODE OF PRACTICE C-13 (B)
SCHEDULE OF FIXTURES AND
FASTENINGS FOR DOORS,
WINDOWS, VENTILATORS,
WARDROBES AND CUPBOARDS

NOTATIONS

- Da..... Teakwood doors
- fully paneled or fully
- glazed or partly
- paneled : and
- glazed
- Db..... Bathroom and W.C.
- door with single
- shutter
- Dc..... Doors plying

planked
Dd..... Doors battened
framed and braced
Wa..... Teakwood windows
fully paneled or fully
glazed or partly
paneled and glazed
Va-Ind..... Teakwood ventilator
(independent)
S.W..... Steel Windows
SV-Ind..... Steel ventilators
(independent)
CB..... Cupboard
S.1..... Single shutter
S.2..... Double shutter
S.4..... Four shutter
B..... Breadth of door
shutter
T..... Thickness of door
shutter
H..... Height of window
shutter.
900..... 900 mm & below
900..... above 900 mm
1200..... 1200 mm & below
1200..... above
191

NOTE : PLEASE READ CAREFULLY :

- (1) Where detailed specification of an item provides for specific size of any fixture or fastening that shall prevail over the provisions in this schedule.
- (2) Fixtures and fastenings (except hold fasts which shall be of M.S. plate only) shall be of Brass, copper, oxidised brass, chromium plated brass, Iron, copper oxidised iron, or chromium plated iron as specified in the item of the work or detailed specifications.
- (3) External door and door failing in staircase excepting the door in balcony shall have sliding door bolt of size 300 mm. x 18 mm. in place of 250 mm. x 16 mm- as shown in this schedule.
- (4) The length of tower old shown is for a door having shutter height up to 2100 mm. only. For door having shutter height more than 2100 mm. the length of tower bolts to be increased to the extent of increase of door shutter height beyond 2100 mm.
- (5) 150 mm. x 150 mm. size glass vision panel shall be provided in the doors of Officers chamber in addition to the scheduled provision if so directed by the Engineering in charge.
- (6) Diamond shape chromium plated brass peeping plate of approved quality shall be provided in one entrance door in residential building in addition to the scheduled provisions.
- (7) Drawer up a wardrobe shall be provided with one furniture handle and one drawer lock (4 levers) in addition to its scheduled provision.
- (8) For door and window with steel frame, 75 mm. size screws, shall be provided both in top bottom frame for fixity as shown below:
 - (a) For width up to 1200 mm..... 2 Nos.
 - (b) For width above 1200 mm. and up to 1800 mm..... 3 Nos.
 - (c) For every additional width of 500 mm. over and above 1800 mm..... 1 No.
- (9) When the mortise lock (6 levers) and latch is specified to be provided to a door either in the item of work itself or by a separate entry, the requirement of providing sliding door bolt, door latch and handles as per his schedule shall be dispensed with.
- (10) For door/window with ventilator at top, fixtures and fastenings of door/window plus those of ventilator (excluding hold fasts) shall be used.
- (11) Where the item of the work, or its specification provides for anodised aluminum fixtures, all the fixtures except hinges and screws will be of anodised aluminum and chromium plated iron hinges and screws shall be used.
- (12) For door, window, or cupboard frame abutting concrete section, instead of hold fasts as shown in the schedule-, coach screws of size mentioned below shall be used:
 - (a) Teak wood frame..... 125 mm.
 - (b) Steel frame..... 75 mm.
- (13) The locking etc. in the door latch shall be so positioned that the can be properly rocked even if part of the latch, when fully slided, remains in the frame or masonry.
- (14) Showcase cupboards having single shutter shall be provided with all catcher instead of tower bolt (barrel type) as per schedule.
- (15) The size of the handle shown in the schedule indicates grip length.
- (16) Door stopper shall be shown in the schedule indicates grip length.
- (17) Piano hinges shall be for the full height of the shutter.

(18) Shutter with pivot arrangements shall be provided with two pivots of approved size instead of hinges as per the schedule.

(19) For butt hinges, only lengths are indicated in the schedule. The width of each flap being 5 mm. less than the thickness of the shutter to which they are to be fixed and the thickness of the flap shall be as specified in the relevant I.S. for heavy, medium or light as specified in the detailed specifications of the item of work.

Schedule for Testing of Materials

For ensuring quality control and workmanship, various test prescribe below corresponding to the material concerned shall be taken as periodic intervals as stipulated below be taken.

The Material shall be got tested Govt. recognized Laboratory (R & B) or field Laboratory of GERI (R & 6) for which 1 % of the estimated amount to tender shall be recovered from the contractor from the R.A. Bill and Final Bills as the testing charges shall be paid by the Govt. to the GERI. However if the charges increase over 1 % no excess recovery shall be made from the contractor as per resolution of B&C department dated 10th May 1985, vide TNC/1085 (4) S.

Item No.

as per

Sch. B

Brief Description of

Materials to be tested

Qty. of

Material

Prescription of test which shall
be carried out

Frequency @ which test
shall be carried out

Total No. of

Test to be
taken

1. Kapchi - Gradation test

-

- Impact Value

- Flakiness Index of aggregate

CMT 1 to 100 – 1 test

100 to 500 – 3 tests

500 to 1500 – 5 tests

1500 to 5000 – 7 tests

2. Grit - Stripping Value

3. Sand - Special gravity

- Water absorption

- Fineness Modulus

- Silt – Content

- Soundness

4. Tiles - Dimension Test

- Transverse strength

- Water Absorption

- Abrasion Test

5. Teakwood - Anatomy Test

- Density Test

- Moisture Content Test

6. Bricks - Water absorption

- Effluence

- Size

- Comprehensive Strength

1 Test @ 50,000 Bricks

7. Cement - Consistency

- Setting Time

- Compressive Strength

1 Test @ 10.0 M.T.

As per manual of Quality

Control

8. Steel - Tensile Strength

- Yield Stress

- Elongation

- Size

9. C.C. Cube test 1:2:4 - Compressive Strength 1 to 5 Cum. 1 No.

6 to 15 Cum. 2 Nos.

16 to 20 Cum. 3 Nos.

21 to 50 Cum. 4 Nos.

51 & Above Cum. 4 +

1 for each Cum or part

thereof

The contractor shall have to pay 1% of the estimate cost put to tender towards all testing of materials & same shall be

deducted from their bills for the works. The testing of various materials shall be carried out in GERI and result received shall be binding to all. i.e. contractor and Govt.

Testing Charges of GERI shall be born by Govt. No refund be made or extra charge over 1 % shall be recoverable form the contractor.

SIGN OF CONTRACTOR

Signature of The Contractor

**Signature of EXECUTIVE ENGINEER
BUILDING DEPARTMENT**

**BHAVNAGAR MUNICIPAL CORPORATION
BHAVNAGAR**

SPECIFICATION FOR LANDSCAPING WORK

1. AREA CLEANING:

Clearing of the site and roughly dressing the same manually or mechanical devices, including cutting down all waste vegetation, removal of the existing roots of plants/trees, removing debris or previously executed civil work.

2. AREA DRESSING & LEVELING

(2"-3" spreading of existing soil & manual compaction as per drawing, design , specification and direction of EIC. Making the soil free from debris, weeds etc. (Minimum of 90% accuracy required).

3. SHRUBBERY /HEDGE PLANTATION

(To be planted on soil already area dressed or contoured. All shrubs to be as per specified in list attached. Development of bed, plantation of shrubbery including application of FYM (5.00 M3 in 100 M2). Average 7 plants in1 M2.

4. GRASS PLANTATION

(To be planted on soil already area dressed or contoured. All grasses to be as specified as per list. Development of bed, plantation of shrubbery including application of FYM (5.00 M3 in 100 M2). (Vetiveria zizanioides, Saccharum munja grass)

5. TREE PLANTATION (10' to 12' height)

(supply & plantation): To be planted on soil already area dressed or contoured. Excavation of pit 1mt x 1mt x 1mt depth.

Mixing of FYM & existing soil in ratio 1:2 and planting of plants. Trees to be as er specified in the attached list. Tree plantation should be carried out neatly accurately and with perfection as per the design and drawing. Plastic bags or pots should be removed carefully and soil around the roots should not be dropped or disturbed. Water retaining basin should be made neatly around the each plantation.

6. Supply of Sweet Earth:

Supply and Spreading of Good earth at site including cost or royalty. As directed by site

in charge. no void

LIST OF PLANTS

Sr.No. Name of plant M2 Minimum size from top of bag

- 1 *Bauhinia alba* 2.5'
- 2 *Bougainvillia* 2'
- 3 *Ficus long island* 2.5'
- 4 *Galphimia gracilis* 2'
- 5 *Hymenocallis speciosa* 2.5'
- 6 *Ixora Singaporensis (pink)* 2.5'
- 7 *Jasminum Sambac* 2.5'
- 8 *Leucothyllum frutescens* 2.5'
- 9 *Murraya exotica* 2.5'
- 10 *Nerium (dwarf)* 2.5'
- 11 *Nerium var.* 2.5'

LIST OF TREES

Sr.No. Name of Trees Minimum size from top of bag

- 1 *Azadirachta indica*
- 2 *Bauhinia blakena*
- 3 *Butea Monosperma*
- 4 *Couropita guianensis*
- 5 *Dalbergia sissoo*
- 6 *Engenia jambolana*
- 7 *Ficus Virens*
- 8 *Ficus religosa*
- 9 *Ficus bengalensis*
- 10 *Mangifera indica*
- 11 *Millingtonia hortensis*
- 12 *Polythea lonifolia*
- 13 *Plumeria*
- 14 *Terminalia arjuna*

Each having 10 to 12 feet height with girth of 3 inch

Sr.No. Name of Grass M2 Minimum size from top of bag

LIST OF GRASS

- 1 *Vetiveria zizanioides* 2'
- 2 *Saccharum munja grass* 2'

NOTE:- IF ANY CHANGES IN SELECTION OF PLANTS, TREES, GRASS, GROUND COVERAGES ETC WITH PRIOR APPROVAL OF ARCHITECT/AUTHORITY(EIC)

SIGN OF CONTRACTOR

Signature of The Contractor

Signature of
EXECUTIVE ENGINEER
BUILDING DEPARTMENT

**EXECUTIVE ENGINEER
BUILDING DEPARTMENT
BHAVNAGAR MUNICIPAL CORPORATION
BHAVNAGAR**

**PROPOSED DEVELOPMENT OF NIGHT SHELTER AT FULSAR, FOR BHAVNAGAR MUNICIPAL
CORPORATION(B.M.C), BHAVANAGAR**

SECTION-III

**SPECIAL TECHNICAL SPECIFICATION FOR
BUILDING WORKS.**

ARCHITECTS:-

CHINTAN SACHAPARA

ARCHITECTS

3, SHAHIBAUG, ABOVE HOME DÉCOR, WAGHA WADI ROAD,

BHAVNAGAR

PHONE : 9428401640

SPECIFICATION

CONCRETE

Applicable Codes

Materials

- | | | |
|-----|-----------|--|
| 1. | IS.269 | Specification for 33 grade ordinary Portland cement. |
| 2. | IS.455 | Specification for Portland slag cement. |
| 3. | IS.1489 | Specification for Portland-Pozzolana cement (Part 1&2). |
| 4. | IS: 8112 | Specification for 43 grade ordinary Portland cement. |
| 5. | IS: 12269 | Specification for 53 grade ordinary Portland cement. |
| 6. | IS: 12330 | Specification for sulphate resisting Portland cement. |
| 7. | IS: 383 | Specification for coarse and fine aggregates from natural sources for concrete. |
| 8. | IS: 432 | Specification for mild steel and medium (tensile steel bars and hard-drawn steel) wires for concrete reinforcement. (Part 1 and 2) |
| 9. | IS: 1786 | Specification for high strength deformed steel bars and wires for concrete reinforcement. |
| 10. | IS: 1566 | Specification for hard-drawn steel wire fabric for concrete reinforcement. |

11. IS: 9103 Specification for admixtures for concrete.
12. IS: 2645 Specification for integral cement water- proofing compounds.
13. IS: 4990 Specification for plywood for concrete shuttering work.

Material Testing

- 1) IS.4031 Methods of physical tests for hydraulic cement (Parts 1 to 15)
- 2) IS: 4032 Method chemical analysis of hydraulic cement.
- 3) IS: 650 Specification for standard sand for testing of cement.
- 4) IS: 2430 Methods for sampling of aggregates for concrete.
- 5) IS.2386 Methods of test for aggregates for concrete (Parts 1 to 8)
- 6) IS: 3025 Methods of sampling and test (physical and chemical) for water used in industry.
- 7) IS: 6925 Methods of test for determination of water-soluble chlorides in concrete admixtures.

Material Storage

- 1) IS: 4082 Recommendations on stacking and storing of construction materials at site.

Concrete Mix Design

- 1) IS: 10262 Recommended guidelines for concrete mix design.
- 2) SP: 23 (S&T) Handbook on Concrete Mixes

Concrete Testing

- 1) IS.1199 Method of sampling and analysis of concrete.
- 2) IS: 516 Method of test for strength of concrete.
- 3) IS: 9013 Method of making, curing and determining compressive Strength of accelerated cured concrete test specimens.
- 4) IS: 8142 Method of test for determining setting time of concrete by penetration resistance.
- 5) IS: 9284 Method of test for abrasion resistance of concrete.
- 6) IS: 2770 Methods of testing bond in reinforced concrete.

Equipments

- 1) IS: 1791 Specification for batch type concrete mixers.
- 2) IS: 2438 Specification for roller pan mixer.
- 3) IS: 4925 Specification for concrete batching and mixing plant.
- 4) IS: 5892 Specification for concrete transit mixer and agitator.
- 5) IS: 7242 Specification for concrete spreaders.
- 6) IS: 2505 General Requirements for concrete vibrators: Immersion type.
- 7) IS: 2506 General Requirements for screed board concrete vibrators.

- 8) IS: 2514 Specification for concrete vibrating tables.
- 9) IS: 3366 Specification for pan vibrators.
- 10) IS: 4656 Specification for form vibrators for concrete.
- 11) IS: 11993 Code of practice for use of screed board concrete vibrators.
- 12) IS: 7251 Specification for concrete finishers.
- 13) IS: 2722 Specification for portable swing weighs batchers for concrete (single and double bucket type).
- 14) IS: 2750 Specification for steel scaffoldings.

Codes Of Practice

- 1) IS: 456 Code of practice for plain and reinforced concrete.
- 2) IS: 457 Code of practice for general construction of plain and reinforced concrete for dams and other massive structures.
- 3) IS: 3370 Code of practice for concrete structures for storage of liquids (Parts 1 to 4)
- 4) IS: 3935 Code of practice for composite construction.
- 5) IS: 2204 Code of practice for construction of reinforced concrete shell roof.
- 6) IS: 2210 Criteria for the design of reinforced concrete shell structures and folded plates.
- 7) IS: 2502 Code of practice for bending and fixing of bars for concrete reinforcement.
- 8) IS: 5525 Recommendation for detailing of reinforcement in reinforced concrete works.
- 9) IS: 2751 Code of practice for welding of mild steel plain and deformed bars used for reinforced concrete construction.
- 10) IS: 9417 Specification for welding cold worked bars for reinforced concrete construction.
- 11) IS: 3558 Code of practice for use of immersion vibrators for consolidating concrete.
- 12) IS: 3414 Code of practice for design and installation of joints in buildings.
- 13) IS: 4326 Code of practice for earthquake resistant design and construction of building.
- 14) IS: 4014 Code of practice for steel tubular scaffolding (Parts 1 & 2)
- 15) IS: 2571 Code of practice for laying inset cement concrete flooring.
- 16) IS: 7861 Code of practice for extreme weather concreting: Part 1 Recommended practice for hot weather concreting.

Construction Safety

- 1) IS.3696 Safety code for scaffolds and ladders. (Parts 1 &
- 2) IS: 7969 Safety code for handling and storage of building materials.
- 3) IS: 8989 Safety code for erection of concrete framed structures.

General

The ARCHITECT/OWNER shall have the right at all times to inspect all operations including the sources of materials, procurement, layout and storage of materials, the

concrete batching and mixing equipment and the quality control system. Such an inspection shall be arranged and the ARCHITECT/OWNER's approval obtained, prior to starting of concrete work. This shall, however, not relieve the Contractor of any of his responsibilities. All materials, which do not conform to the Specifications, shall be rejected.

Materials should be selected so that they can satisfy the design requirements of strength, serviceability, safety, durability and finish with due regards to the functional requirements and the environmental conditions to which the structure will be subjected. Materials complying with codes/standards shall generally be used. Other materials may be used after approval of the ARCHITECT/OWNER and after establishing their performance suitability based on previous data, experience or tests.

Materials

Cement:

Unless otherwise called for by the ARCHITECT/OWNER, cement shall be ordinary Portland cement conforming to IS: 269, IS: 8112 or IS: 12269.

Where Portland pozzolana or slag cements are used, it shall be ensured that consistency of quality is maintained, there will be no adverse interactions between the materials and the finish specified is not marred.

Only one type of cement shall be used in any one mix. The source of supply, type or brand of cement within the same structure or portion thereof shall not be changed without approval from the ARCHITECT/OWNER.

Cement, which is not used within 90 days from its date of manufacture, shall be tested at a laboratory approved by the ARCHITECT/OWNER and until the results of such tests are found satisfactory, it shall not be used in any work.

Aggregates (General):

Aggregates shall consist of naturally occurring stones (crushed or uncrushed), gravel and sand. They shall be chemically inert, strong, hard, clean, durable against weathering, of limited porosity, free from dust/silt/ organic impurities/deleterious materials and conform to IS: 383. Aggregates such as slag, crushed over burnt bricks, bloated clay ash, sintered fly ash and tiles shall not be used.

Aggregates shall be washed and screened before use where necessary or if directed by the ARCHITECT/OWNER.

Aggregates containing reactive materials shall be used only after tests conclusively prove that there will be no adverse effect on strength, durability and finish, including long-term effects, on the concrete.

The fineness modulus of sand shall neither be less than 2.2 nor more than 3.2.

The maximum size of coarse aggregate shall be as stated on the drawings but in no case greater than 1/4 of the minimum thickness of the member.

Plums 160 mm and above of a reasonable size may be used in mass concrete fill where directed. Plums shall not constitute more than 20% by volume of the concrete.

Water

Water used for both mixing and curing shall conform to IS: 456. Potable waters are generally satisfactory. Water containing any excess of acid, alkali, sugar or salt shall not be used.

Reinforcement

All reinforcement steel shall be HYSD steel grade – Fe500 conforming to relevant I.S. 1786 for water retaining structure

All reinforcement shall be clean, free from pitting, oil, grease, paint, loose mill scales, rust, dirt, dust, or any other substance that will destroy or reduce bond.

Admixtures

Accelerating, retarding, water reducing and air entraining admixtures shall conform to IS: 9103 and integral water proofing admixtures to IS: 2645.

Admixtures may be used in concrete as per manufacturer's instructions only with the approval of the ARCHITECT/OWNER. An admixture's suitability and effectiveness shall be verified by trial mixes with the other materials used in the works. If two or more admixtures are to be used simultaneously in the same concrete mix, their interaction shall be checked and trial mixes done to ensure their compatibility. There should also be no increase in risk of corrosion of the reinforcement or other embeddings.

Calcium chloride shall not be used for accelerating set of the cement for any concrete containing reinforcement or embedded steel parts. When calcium chloride is permitted such as in mass concrete works, it shall be dissolved in water and added to the mixing water by an amount not exceeding 1.5 percent of the weight of the cement in each batch of concrete. The designed concrete mix shall be corrected accordingly.

Wastage

Wastage allowance for cement and steel shall be considered in the item rate and no extra payment shall become payable to the Contractor on any account.

Samples and Tests

All materials used for the works shall be tested before use.

Manufacturer's test certificate shall be furnished for each batch of cement/steel and when directed by the ARCHITECT/OWNER samples shall also be got tested by the Contractor in a laboratory approved by the ARCHITECT/OWNER at no extra cost to Employer. ARCHITECT/OWNER may appoint separate third party inspection for the material testing to ensure the quality of the work. The Contractor shall replace the defective material as an outcome of these tests. Sampling and testing shall be as per IS: 2386 under the supervision of the ARCHITECT/OWNER.

Water to be used shall be tested to comply with requirements of IS: 456.

The Contractor shall furnish manufacturer's test certificates and technical literature for the admixture proposed to be used. If directed, the admixture shall be got tested at an

approved laboratory at no extra cost.

Storing of Materials

All materials shall be stored in a manner so as to prevent its deterioration and contamination, which would preclude its use in the works. Requirements of IS: 4082 shall be complied with.

The Contractor will have to make his own arrangements for the storage of adequate quantity of cement. If such cement is not stored properly and has deteriorated, the material shall be rejected. Cement bags shall be stored in dry weatherproof shed with a raised floor, well away from the outer walls and insulated from the floor to avoid moisture from ground. Not more than 15 bags shall be stacked in any tier. Storage arrangement shall be approved by the ARCHITECT/OWNER. Storage under tarpaulins shall not be permitted. Each consignment of cement shall be stored separately and consumed in its order of receipt.

Each size of coarse and fine aggregates shall be stacked separately and shall be protected from leaves and contamination with foreign material. The stacks shall be on hard, clean, free draining bases, draining away from the concrete mixing area.

The Contractor shall make his own arrangements for storing water at site in tanks to prevent contamination.

The reinforcement shall be stacked on top of timber sleepers to avoid contact with ground/water. Each type and size shall be stacked separately.

Concrete

General

Concrete grade shall be as designated on drawings. In concrete grade M15, M20 etc. the number represents the specified characteristic compressive strength of 150 mm cube at 28 days, expressed in N/sq.mm as per IS: 456. Concrete in the works shall be "DESIGN MIX CONCRETE" or "NOMINAL MIX CONCRETE". All concrete works of grade M5, M7.5 and M10 shall be NOMINAL MIX CONCRETE whereas all other grades, M15 and above, shall be DESIGN MIX CONCRETE.

Design Mix Concrete

(a) Mix Design & Testing

For Design Mix Concrete, the mix shall be designed according to IS: 10262 and SP: 23 to provide the grade of concrete having the required workability and characteristic strength not less than appropriate values given in IS: 456. The design mix shall be cohesive and does not segregate and should result in a dense and durable concrete and also capable of giving the finish as specified. For liquid retaining structures, the mix shall also result in watertight concrete. The Contractor shall exercise great care while designing the concrete mix and executing the works to achieve the desired result.

The minimum cement content for Design Mix Concrete shall be as per Appendix-A of IS: 456 or as given below, whichever is higher.

Grade of Concrete	Minimum Cement Content in Kg/Cu. m of Concrete
-------------------	--

M15	260
M20	315
M25	360

The minimum cement content stipulated above should be adopted irrespective of whether the Contractor achieves the desired strength with less quantity of cement. The CONTRACTOR's quoted rates for concrete shall provide for the above eventuality and nothing extra shall become payable to the CONTRACTOR in this account. Even in the case where the quantity of cement required is higher than that specified above to achieve desired strength based on an approved mix design, nothing extra shall become payable to the CONTRACTOR.

It shall be the Contractor's sole responsibility to carry out the mix designs at his own cost. He shall furnish to the ARCHITECT/OWNER at least 30 days before concreting operations, a statement of proportions proposed to be used for the various concrete mixes and the strength results obtained. The strength requirements of the concrete mixes ascertained on 150 mm cubes as per IS: 516 shall comply with the requirements of IS: 456.

Grade of Concrete	Minimum Compressive Strength N/sq.mm at 7 days	Specified Characteristic Compressive Strength N/sq.mm at 28 days
M 15	10.0	15.0
M 20	13.5	20.0
M 25	17.0	25.0
M 30	20.0	30.0
M 35	23.5	35.0
M 40	27.0	40.0

A range of slumps which shall generally be used for various types of construction unless otherwise instructed by the ARCHITECT/OWNER is given below:

Structure/Member	Slump in millimeters	
	Maximum	Minimum
Reinforced foundation walls and footings	75	25
Plain footings, caissons and substructure walls	100	25
Slabs, Beams and reinforced walls	75	25
Pump & miscellaneous Equipment Foundations	100	25
Building columns	50	25
Pavements	50	25
Heavy mass construction	50	25

(b) Batching & Mixing of Concrete:

Proportions of aggregates and cement, as decided by the concrete mix design, shall be by weight. These proportions shall be maintained during subsequent concrete batching by means of weigh batchers capable of controlling the weights within one percent of the desired value.

Amount of water added shall be such as to produce dense concrete of required consistency, specified strength and satisfactory workability and shall be so adjusted to account for moisture content in the aggregates. Water- cement ratio specified for use by the ARCHITECT/OWNER shall be maintained. Each time the work stops, the mixer shall be cleaned out, and while recommencing; the first batch shall have 10% additional cement to allow for sticking in the drum.

Arrangement should be made by the Contractor to have the cubes tested in an approved laboratory or in field with prior consent of the ARCHITECT/OWNER. Sampling and testing of strength and workability of concrete shall be as per IS: 1199, IS: 516 and IS: 456, IS 3370.

Nominal Mix Concrete

(a) Mix Design & Testing

Mix design and preliminary tests are not necessary for Nominal Mix Concrete. However works tests shall be carried out as per IS: 456. Proportions for Nominal Mix Concrete and w/c ratio may be adopted as per Table 3 of IS: 456. However it will be the Contractor's sole responsibility to adopt appropriate nominal mix proportions to yield the specified strength.

(b) Batching & Mixing of Concrete

Based on the adopted nominal mixes, aggregates shall be measured by volume. However cement shall be by weight only.

Formwork

Formwork shall be all inclusive and shall consist of but not be limited to shores, bracings, sides of footings, walls, beams and columns, bottom of slabs etc. including ties, anchors, hangers, inserts, false work, wedges etc.

The design and engineering of the formwork as well as its construction shall be the responsibility of the Contractor. However, if so desired by the ARCHITECT/OWNER, the drawings and calculations for the design of the formwork shall be submitted to the ARCHITECT/OWNER for approval.

Formwork shall be designed to fulfill the following requirements:

- (a) **Sufficiently rigid and tight to prevent loss of grout or mortar from the concrete at all stages and appropriate to the methods of placing and compacting.**
- (b) **Made of suitable materials.**
- (c) **Capable of providing concrete of the correct shape and surface finishes within the specified tolerance limits.**
- (d) **Capable of withstanding without deflection the worst combination of self weight, reinforcement and concrete weight, all loads and dynamic effects arising from construction and compacting activities, wind and weather forces.**
- (e) **Capable of easy striking out without shock, disturbance or damage to the concrete.**
- (f) **Soffit forms capable of imparting a camber if required.**
- (g) **Soffit forms and supports capable of being left in position if required.**
- (h) **Capable of being cleaned and/or coated if necessary immediately prior to casting the concrete; design temporary openings where necessary for these purposes and to facilitate the preparation of construction joints.**

The formwork may be of timber, plywood, steel, plastic or concrete depending upon the type of finish specified. Sliding forms and slip form may be used with the approval of the ARCHITECT/OWNER. Timber for formwork shall be well seasoned, free from sap, shakes, loose knots, worm holes, warps and other surface defects. Joints between formwork and formwork and between formwork and structures shall be sufficiently tight to prevent loss of slurry from concrete, using seals if necessary.

The faces of formwork coming in contact with concrete shall be cleaned and two coats of approved mould oil applied before fixing reinforcement. All rubbish, particularly chippings, shavings, sawdust, wire pieces dust etc. shall be removed from the interior of the forms before the concrete is placed. Where directed, cleaning of forms shall be done by blasting with a jet of compressed air at no extra cost.

Forms intended for reuse shall be treated with care. Forms that have deteriorated shall not be used. Before reuse, all forms shall be thoroughly scraped, cleaned, nails removed, holes suitably plugged, joints repaired and warped lumber replaced to the satisfaction of the ARCHITECT/OWNER. The Contractor shall equip himself with enough shuttering to allow for wastage so as to complete the job in time.

Permanent formwork shall be checked for its durability and compatibility with adjoining concrete before it is used in the structure. It shall be properly anchored to the concrete.

Wire ties passing through beams, columns and walls shall not be allowed. In their place bolts passing through sleeves shall be used. Formwork spacers left insitu shall not impair the desired appearance or durability of the structure by causing spalling, rust staining or allowing the passage of moisture.

For liquid retaining structures, sleeves shall not be provided for through bolts nor shall through bolts be removed if provided. The bolts, in the latter case, shall be cut at 25 mm depth from the surface and the hole made good by cement mortar of the same proportion as the concrete just after striking the formwork.

Where specified all corners and angles exposed in the finished structure shall have

chamfers or fillets of 20 mm x 20 mm size.

Forms for substructure may be omitted when, in the opinion of the ARCHITECT/OWNER, the open excavation is firm enough (in hard non-porous soils) to act as a form. Such excavations shall be larger, as approved by the ARCHITECT/OWNER, than that required as per drawing to compensate for irregularities in excavation.

The Contractor shall provide adequate props carried down to a firm bearing without overloading any of the structures.

The shuttering for beams and slabs shall be so erected that the side shuttering of beams can be removed without disturbing the bottom shuttering. If the shuttering for a column is erected for the full height of the column, one side shall be built up in sections as placing of concrete proceeds or windows left for placing concrete from the side to limit the drop of concrete to 1.0m or as approved by the ARCHITECT/OWNER. The Contractor shall temporarily and securely fix items to be cast (embedment/ inserts) in a manner that will not hinder the striking of forms or permit loss of grout.

Formwork showing excessive distortion, during any stage of construction, shall be repositioned and strengthened. Placed concrete affected by faulty formwork, shall be entirely removed and formwork corrected prior to placement of new concrete at Contractor's cost.

The striking time for formwork shall be determined based on the following requirements:

- (a) Development of adequate concrete strength;
- (b) Permissible deflection at time of striking form work;
- (c) Curing procedure employed - its efficiency and effectiveness;
- (d) Subsequent surface treatment to be done;
- (e) Prevention of thermal cracking at re-entrant angles;
- (f) Ambient temperatures; and
- (g) Aggressiveness of the environment (unless immediate adequate steps are taken to prevent damage to the concrete).

Under normal circumstances (generally where temperatures are above 20°C) forms may be struck after expiry of the time period given in IS: 456 unless approved otherwise by the ARCHITECT/OWNER. For Portland Pozzolana/slag cement the stripping time shall be suitably modified as approved by the ARCHITECT/OWNER. It is the Contractor's responsibility to ensure that forms are not struck until the concrete has developed sufficient strength to support itself, does not undergo excessive deformation and resist surface damage and any stresses arising during the construction period.

Reinforcement Workmanship

Reinforcing bars supplied bent or in coils shall be straightened cold without damage. No bending shall be done when ambient temperature is below 5°C. Local warming may be permitted if steel is kept below 10° C.

All bars shall be accurately bent gradually and according to the sizes and shapes shown on the drawings/ schedules or as directed by ARCHITECT/OWNER.

Re-bending or straightening incorrectly bent bars shall not be done without the approval

of the ARCHITECT/OWNER.

Reinforcement shall be accurately fixed and maintained firmly in the correct position by the use of blocks, spacers, chairs, binding wire etc. to prevent displacement during placing and compaction of concrete. The tied in place reinforcement shall be approved by the ARCHITECT/OWNER prior to concrete placement. Spacers shall be of such materials and designs as will be durable, not lead to corrosion of the reinforcement and not cause spalling of the concrete cover.

Binding wire shall be 16-gauge soft annealed wire. Ends of the binding wire shall be bent away from the concrete surface and in no case encroach into the concrete cover.

Substitution of reinforcement, laps/splices not shown on drawing shall be subject to ARCHITECT/OWNER's approval.

Tolerances

Tolerance for formwork and concrete dimensions shall be as per IS: 456 unless specified otherwise.

Tolerances specified for horizontal or vertical building lines or footings shall not be construed to permit encroachment beyond the legal boundaries.

The formwork shall be designed and constructed to the shapes, lines and dimensions shown on the drawings within the tolerances given below:

(a) Deviation from specified dimensions of cross section of columns and beams	- 6 mm + 12 mm
(b) Deviations from dimensions of footings (Tolerances apply to concrete dimensions only, not to positioning of vertical reinforcing steel or dowels)	
1) Dimension in plan	- 12 mm + 50 mm
2) Eccentricity	0.02 times the width of the footing in the direction of deviation but not more than 50 mm
3) Thickness	± 0.05 times the specified thickness

Preparation Prior to Concrete Placement

Before concrete is actually placed in position, the inside of the formwork shall be cleaned and mould oil applied, inserts and reinforcement shall be correctly positioned and securely held, necessary openings, pockets, etc. provided.

All arrangements-formwork, equipment and proposed procedure, shall be approved by the ARCHITECT/OWNER. Contractor shall maintain separate Pour Card for each pour as per the format enclosed.

Transporting, Placing and Compacting Concrete

Concrete shall be transported from the mixing plant to the formwork with minimum time lapse by methods that shall maintain the required workability and will prevent segregation, loss of any ingredients or ingress of foreign matter or water.

In all cases concrete shall be deposited as nearly as practicable directly in its final position. To avoid segregation, concrete shall not be rehandled or caused to flow. For locations where direct placement is not possible and in narrow forms the Contractor shall provide suitable drops and "Elephant Trunks". Concrete shall not be dropped from a height of more than 1.0m.

Concrete shall not be placed in flowing water. Under water, concrete shall be placed in position by tremies or by pipeline from the mixer and shall never be allowed to fall freely through the water.

While placing concrete the Contractor shall proceed as specified below and also ensure the following:

- (a) Continuously between construction joints and pre- determined abutments.
- (b) Without disturbance to forms or reinforcement.
- (c) Without disturbance to pipes, ducts, fixings and the like to be cast in; ensure that such items are securely fixed. Ensure that concrete cannot enter open ends of pipes and conduits etc.
- (d) Without dropping in a manner that could cause segregation or shock.
- (e) In deep pours only when the concrete and formwork designed for this purpose and by using suitable chutes or pipes.
- (f) Do not place if the workability is such that full compaction cannot be achieved.
- (g) Without disturbing the unsupported sides of excavations; prevent contamination of concrete with earth. Provide sheeting if necessary. In supported excavations, withdraw the linings progressively as concrete is placed.
- (h) If placed directly onto hardcore or any other porous material, dampen the surface to reduce loss of water from the concrete.

- (i) Ensure that there is no damage or displacement to sheet membranes.
- (j) Record the time and location of placing structural concrete.

Concrete shall normally be compacted in its final position within thirty minutes of leaving the mixer. Concrete shall be compacted during placing with approved vibrating equipment without causing segregation until it forms a solid mass free from voids thoroughly worked around reinforcement and embedded fixtures and into all corners of the formwork. Immersion vibrators shall be inserted vertically at points not more than 450 mm apart and withdrawn slowly till air bubbles cease to come to the surface, leaving no voids. When placing concrete in layers advancing horizontally, care shall be taken to ensure adequate vibration, blending and melding of the concrete between successive layers. Vibrators shall not be allowed to come in contact with reinforcement, formwork and finished surfaces after start of initial set. Over-vibration shall be avoided.

Concrete may be conveyed and placed by mechanically operated equipment after getting the complete procedure approved by the ARCHITECT/OWNER. The slump shall be held to the minimum necessary for conveying concrete by this method. When concrete is to be pumped, the concrete mix shall be specially designed to suit pumping. Care shall be taken to avoid stoppages in work once pumping has started.

Except when placing with slip forms, each placement of concrete in multiple lift work,

shall be allowed to set for at least 24 hours after the final set of concrete before the start of subsequent placement. Placing shall stop when concrete reaches the top of the opening in walls or bottom surface of slab, in slab and beam construction, and it shall be resumed before concrete takes initial set but not until it has had time to settle as approved by the ARCHITECT/OWNER. Concrete shall be protected against damage until final acceptance.

Mass Concrete Works

Sequence of pouring for mass concrete works shall be as approved by the ARCHITECT/OWNER. The Contractor shall exercise great care to prevent shrinkage cracks and shall monitor the temperature of the placed concrete if directed.

Curing

Curing and protection shall start immediately after the compaction of the concrete to protect it from:

- (a) Premature drying out, particularly by solar radiation and wind;
- (b) Leaching out by rain and flowing water;
- (c) Rapid cooling during the first few days after placing;
- (d) High internal thermal gradients;
- (e) Low temperature or frost;
- (f) Vibration and impact which may disrupt the concrete and interfere with its bond to the reinforcement.

All concrete, unless approved otherwise by the ARCHITECT/OWNER, shall be cured by use of continuous sprays or ponded water or continuously saturated coverings of sacking, canvas, hessian or other absorbent material for the period of complete hydration with a minimum of 7 days. The quality of curing water shall be the same as that used for mixing.

Where a curing membrane is approved to be used by the ARCHITECT/OWNER, the same shall be of a non-wax base and shall not impair the concrete finish in any manner. The curing compound to be used shall be approved by the ARCHITECT/OWNER before use and shall be applied with spraying equipment capable of a smooth, even textured coat.

Curing may also be done by covering the surface with an impermeable material such as polyethylene, which shall be well sealed and fastened.

Construction Joints and Keys

Construction joints will be as shown on the drawing or as approved by the ARCHITECT/OWNER. Concrete shall be placed without interruption until completion of work between construction joints. If stopping of concreting becomes unavoidable anywhere, a properly formed construction joint shall be made with the approval of the ARCHITECT/OWNER.

Dowels for concrete work, not likely to be taken up in the near future, shall be coated with cement slurry and encased in lean concrete as indicated on the drawings or as

approved by the ARCHITECT/OWNER.

Before resuming concreting on a surface, which has hardened all laitance and loose stone, shall be thoroughly removed by wire brushing/hacking and surface washed with high pressure water jet and treated with thin layer of cement slurry for vertical joints and horizontal layers.

When concreting is to be resumed on a surface, which has not fully hardened, all laitance shall be removed by wire brushing, the surface wetted, free water removed and a coat of cement slurry applied. On this, a layer of concrete not exceeding 150 mm thickness shall be placed and well rammed against the old work. Thereafter work shall proceed in the normal way.

Foundation Bedding

All earth surfaces upon which or against which concrete is to be placed, shall be well compacted and free from standing water, mud or debris. Soft or spongy areas shall be cleaned out and back filled with either soil-cement mixture, lean concrete or clean sand compacted as approved by the ARCHITECT/OWNER. The surfaces of absorptive soils shall be moistened.

Concrete shall not be deposited on large sloping rock surfaces. The rock shall be cut to form rough steps or benches by picking, barring or wedging. The rock surface shall be kept wet for 2 to 4 hours before concreting.

Finishes

General

The formwork for concrete works shall be such as to give the finish as specified. The Contractor shall make good any unavoidable defects as approved consistent with the type of concrete and finish specified; defects due to bad workmanship (e.g. damaged or misaligned forms, defective or poorly compacted concrete) will not be accepted. The Contractor shall construct the formwork using the correct materials and to meet the requirements of the design and to produce finished concrete to required dimensions, plumbs, planes and finishes.

Surface Finish Type F1

The main requirement is that of dense, well-compacted concrete. No treatment is required except repair of defective areas, filling all form tie holes and cleaning up of loose or adhering debris. For surfaces below grade, which will receive waterproofing treatment, the concrete shall be free of surface irregularities, which would interfere with proper and effective application of waterproofing material specified for use.

Surface Finish Type F2

The appearance shall be that of a smooth dense, well-compacted concrete showing the slight marks of well fitted shuttering joints. The Contractor shall make good any blemishes.

Surface Finish Type F3

This finish shall give an appearance of smooth, dense, well-compacted concrete with no

shutter marks, stain free and with no discolouration, blemishes, arises, airholes etc. Only lined or coated plywood with very tight joints shall be used to achieve this finish. The panel size shall be uniform and as large as practicable. Any minor blemishes that might occur shall be made good by the Contractor.

Integral Cement Finish on Concrete Floor

In all cases where integral cement finish on a concrete floor has been specified, the top layer of concrete shall be screeded off to proper level and tamped with tamper having conical projections so that the aggregate shall be forced below the surface. The surface shall be finished with a wooden float and a trowel with pressure. The finish shall be continued till the concrete reaches its initial set. No cement or cement mortar finish shall be provided on the surface. Where specified, a floor hardener as approved by the ARCHITECT/OWNER shall be supplied and used as recommended by the manufacturer.

Repair and Replacement of Unsatisfactory Concrete

Immediately after the shuttering is removed, all the defective areas such as honey-combed surfaces, rough patches, holes left by form bolts etc. shall be inspected by the ARCHITECT/OWNER who may permit patching of the defective areas or reject the concrete work.

All through holes for shuttering shall be filled for full depth and neatly plugged flush with surface.

Rejected concrete shall be removed and replaced by the Contractor at no additional cost to the Employer.

For patching of defective areas all loose materials shall be removed and the surface shall be prepared as approved by the ARCHITECT/OWNER.

Bonding between hardened and fresh concrete shall be done either by placing cement mortar or by applying epoxy. The decision of the ARCHITECT/OWNER as to the method of repairs to be adopted shall be final and binding on the Contractor. The surface shall be saturated with water for 24 hours before patching is done with 1:5 cement sand mortar. The use of epoxy for bonding fresh concrete shall be carried out as approved by the ARCHITECT/OWNER.

Vacuum Dewatering of Slabs

Where specified floor slabs, either grade or suspended, shall be finished by vacuum dewatering including all operations such as poker vibration, surface vibration, vacuum processing, floating and trowelling as per equipment manufacturers recommendation. The equipment to be used shall be subject to the ARCHITECT/OWNER's approval.

Hot Weather Requirements

Concreting during hot weather shall be carried out as per IS: 7861 (Part I).

Adequate provisions shall be made to lower concrete temperatures, which shall not exceed 40°C at the time of placement of fresh concrete.

Where directed by the ARCHITECT/OWNER, the Contractor shall spray non-wax based curing compound on unformed concrete surfaces at no extra costs.

Cold Weather Requirements

Concreting during cold weather shall be carried out as per is: 7861 (Part II).

The ambient temperature during placement and up to final set shall not fall below 5 Deg.C. Approved antifreeze/accelerating additives shall be used where directed.

For major and large scale concreting works the temperature of concrete at times of mixing and placing, the thermal conductivity of the formwork and its insulation and stripping period shall be closely monitored.

Liquid Retaining Structures

The Contractor shall take special care for concrete for liquid retaining structures, underground structures and those others specifically called for to guarantee the finish and water tightness.

The minimum level of surface finish for liquid retaining structures shall be Type F2. All such structures shall be hydro-tested.

The Contractor shall make all arrangements for hydro-testing of structure, all arrangements for testing such as temporary bulk heads, pressure gauges, pumps, pipe lines etc.

The Contractor shall also make all temporary arrangements that may have to be made to ensure stability of the structures during construction.

Any leakage that may occur during the hydro-test or subsequently during the defects liability period or the period for which the structure is guaranteed shall be effectively stopped either by cement/epoxy pressure grouting, guniting or such other methods as may be approved by the ARCHITECT/OWNER. All such rectification shall be done by the CONTRACTOR to the entire satisfaction of the ARCHITECT/OWNER at no extra cost to the EMPLOYER.

Testing Concrete Structures for Leakage

Hydrostatic test for water tightness shall be done at full storage level or soffit of cover slab, as may be directed by the ARCHITECT/OWNER, as described below:

In case of structures whose external faces are exposed, such as elevated tanks, the requirements of the test shall be deemed to be satisfied if the external faces show no sign of leakage or sweating and remain completely dry during the period of observation of seven days after allowing a seven day period for absorption after filling with water.

In the case of structures whose external faces are buried and are not accessible for inspection, such as underground tanks, the structures shall be filled with water and after the expiry of seven days after the filling, the level of the surface of the water shall be recorded. The level of water shall be recorded again at subsequent intervals of 24 hrs.

Over a period of seven days. Backfilling shall be withheld till the tanks are tested. The total drop in surface level over a period for seven days shall be taken as an indication of the water tightness of the structure. The ARCHITECT/OWNER shall decide on the actual permissible nature of this drop in the surface level, taking into account whether the structures are open or closed and the corresponding effect it has on evaporation losses. Unless specified otherwise, a structure whose top is covered shall be deemed to be water tight if the total drop in the surface level over a period of seven days does not exceed 40 mm.

Each compartment/segment of the structure shall be tested individually and then all together.

For structures such as pipes, tunnels etc. the hydrostatic test shall be carried out by filling with water, after curing as specified, and subjecting to the specified test pressure for specified period. If during this period the loss of water does not exceed the equivalent of the specified rate, the structure shall be considered to have successfully passed the test.

Optional Tests

If the ARCHITECT/OWNER feels that the materials i.e. cement, sand, coarse aggregates, reinforcement and water are not in accordance with the Specifications or if specified concrete strengths are not obtained, he may order tests to be carried out on these materials in laboratory, to be approved by the ARCHITECT/OWNER, as per relevant IS Codes. Contractor shall have to pay for these tests.

In the event of any work being suspected of faulty material or workmanship requiring its removal or if the works cubes do not give the stipulated strengths, the ARCHITECT/OWNER reserves the right to order the Contractor to take out cores and conduct tests on them or do ultrasonic testing or load testing of structure, etc. The ARCHITECT/OWNER also reserves the right to ask the Contractor to dismantle and re-do such unacceptable work, at no cost to the Employer. Alternately ARCHITECT/OWNER also reserves the right to ask the CONTRACTOR to dismantle and re-do such unacceptable work at the cost of CONTRACTOR.

Grouting

Standard Grout

Grout shall be provided as specified on the drawings.

The proportion of Standard Grout shall be such as to produce a flowable mixture consistent with minimum water content and shrinkage. Surfaces to be grouted shall be thoroughly roughened and cleaned. All structural steel elements to be grouted, shall be cleaned of oil, grease, dirt etc. The use of hot, strong caustic solution for this purpose will be permitted. Prior to grouting, the hardened concrete shall be saturated with water and just before grouting, water in all pockets shall be removed. Grouting once started shall be done quickly and continuously. Variation in grout mixes and procedures shall be permitted if approved by the ARCHITECT/OWNER. The grout proportions shall be limited as follows:

Use	Grout Thickness	Mix Proportions	W/C Ratio
------------	------------------------	------------------------	------------------

			(max)
a) Fluid mix	Under 25mm	One part Portland Cement to one part sand	0.44
Use	Grout Thickness	Mix Proportions	W/C Ratio (max)
b) General mix	25mm and over but less than 50mm	One part Portland Cement to 2 parts of sand	0.53
c) Stiff mix	50mm and over	One part Portland Cement to 3 parts of sand	0.53

Non-Shrink Grout: **Non –shrink grout where required shall be provided in strict accordance with the manufacturer’s instructions / specifications on the drawings**

General

Inspection: All materials, workmanship and finished construction shall be subject to continuous inspection and approval of ARCHITECT/OWNER. Materials rejected by ARCHITECT/OWNER shall be expressly removed from site and shall be replaced by Contractor immediately.

Clean-Up: Upon the completion of concrete work, all forms, equipment, construction tools, protective coverings and any debris, scraps of wood, etc. resulting from the work shall be removed and the premises left clean.

Acceptance Criteria: Any concrete work shall satisfy the requirements given below individually and collectively for it to be acceptable.

- a) properties of constituent materials;
- b) characteristic compressive strength;
- c) specified mix proportions;
- d) minimum cement content;
- e) maximum free-water/cement ratio;
- f) workability;
- g) temperature of fresh concrete;
- h) density of fully compacted concrete;
- i) cover to embedded steel;
- j) Curing;
- k) tolerances in dimensions;
- l) tolerances in levels;
- m) durability;

- n) surface finishes;

- o) special requirements such as;
 - i) water tightness
 - ii) resistance to aggressive chemicals
 - iii) resistance to freezing and thawing
 - iv) very high strength
 - v) improved fire resistance
 - vi) wear resistance
 - vii) resistance to early thermal cracking

The ARCHITECT/OWNER's decision as to the acceptability or otherwise of any concrete work shall be final and binding on the Contractor.

For work not accepted, the ARCHITECT/OWNER may review and decide whether remedial measures are feasible so as to render the work acceptable. The ARCHITECT/OWNER shall in that case direct the Contractor to undertake and execute the remedial measures. These shall be expeditiously and effectively implemented by the Contractor. Nothing extra shall become payable to the Contractor by the Employer for executing the remedial measures.

Water stops

Material: The material for the PVC waterstops shall be a plastic compound with the basic resin of polyvinyl chloride and additional resins, plasticizers, inhibitors, which satisfies the performance characteristics specified below as per IS:12200. Testing shall be in accordance with IS:8543.

a)	Tensile strength	:	3.6 N/mm ² minimum
b)	Ultimate elongation	:	300% minimum
c)	Tear resistance	:	4.9 N/mm ² minimum
d)	Stiffness in flexure	:	2.46 N/mm ² minimum
e)	Accelerated extraction		
	i) Tensile strength	:	10.50 N/mm ² minimum
	ii) Ultimate elongation	:	250% minimum
(f)	Effect of Alkali	:	7 days
	i) Weight increase	:	0.10% maximum
	ii) Weight decrease	:	0.10% maximum
	iii) Hardness change	:	± 5 points
(g)	Effect of Alkali	:	28 days
	i) Weight increase	:	0.40% maximum
	ii) Weight decrease	:	0.30% maximum
	iii) Dimension change	:	±1%

PVC water stops shall be either of the bar type, serrated with centre bulb and end grips for use within the concrete elements or of the surface (kicker) type for external use.

PVC water stops shall be of approved manufacture. Samples and the test certificate shall be got approved by the ARCHITECT/OWNER before procurement for incorporation in the works. Alternatively G.I. sheet of 18 gage (1.3mm) thick and 200mm wide can be used by the contractor as construction joints.

Alternatively contractors can use G.I sheet 200mm wide and 18 gauge thick as constructions joints

Workmanship

Water stops shall be cleaned before placing them in position. Oil or grease shall be removed thoroughly using water and suitable detergents.

Water stops shall be procured in long lengths as manufactured to avoid joints as far as possible. Standard L or T type of intersection pieces shall be procured for use depending on their requirement. Any non-standard junctions shall be made by cutting the pieces to profile for jointing. Lapping of water stops shall not be permitted. All jointing shall be of fusion welded type as per manufacturer's instructions.

Water stops shall be placed at the correct location/level and suitably supported at intervals with the reinforcement to ensure that it does not deviate from its intended position during concreting and vibrating. Care shall also be taken to ensure that no honey-combing occurs because of the serrations/end grips, by placing concrete with smaller size aggregates in this region. Projecting portions of the waterstops embedded in concrete shall be thoroughly cleaned of all mortar/ concrete coating before resuming further concreting operations. The projecting waterstop shall also be suitably supported at intervals with the reinforcement to maintain its intended position during concreting so as to ensure that it does not bend leading to formation of pockets. In addition, smaller size aggregates shall be used for concreting in this region also.

Preformed Fillers and Joint Sealing Compound

Materials: Preformed filler for expansion/isolation joints shall be non-extruding and resilient type of bitumen impregnated fibres conforming to IS:1838 (Part I).

Bitumen coat to concrete/masonry surfaces for fixing the preformed bitumen filler strip shall conform to IS:702. Bitumen primer shall conform to IS:3384. Sealing compound for filling the joints above the preformed bitumen filler shall conform to Grade 'A' as per IS:1834.

Workmanship

The thickness of the preformed bitumen filler shall be 25mm for expansion joints and 50mm for isolation joints around foundation supporting rotatory equipment's. Contractor shall procure the strips of the desired thickness and width in lengths as manufactured. Assembly of small pieces/thicknesses of strips to make up the specified size shall not be permitted.

The concrete/masonry surface shall be cleaned free from dust and any loose particles.

When the surface is dry, one coat of industrial blown type bitumen of grade 85/25 conforming to IS:702 shall be applied hot by brushing at the rate of 1.20 kg/sq.m. When the bitumen is still hot the preformed bitumen filler shall be pressed and held in position till it completely adheres. The surface of the filler against which further concreting/masonry work is to be done shall similarly be applied with one coat of hot bitumen at the rate of 1.20 kg/sq.m.

Sealing compound shall be heated to a pouring consistency for enabling it to run molten in a uniform manner into the joint. Before pouring the sealing compound, the vertical faces of the concrete joint shall be applied hot with a coat of bitumen primer conforming to IS: 3384 in order to improve the adhesive quality of the sealing compound.

Expansion joints between beams/slabs shall be provided with 100mm wide x 4mm thick mild steel plate at the soffit of RCC beams/slabs to support and prevent the preformed joint filler from dislodging. This plate shall be welded to an edge angle of ISA 50 x 50 x 6mm provided at the bottom corner, adjacent to the expansion joint of one of the beams/slabs, by intermittent fillet welding. Steel surfaces shall be provided with 2 coats of red oxide zinc chrome primer and 3 coats of synthetic enamel paint finish.

15 SAMPLING AND STRENGTH OF DESIGNED CONCRETE MIX

15.1 General

Samples from fresh concrete shall be taken as per IS 1199 and cubes shall be made, cured and tested at 28 days in accordance with IS 516.

15.1.1 In order to get a relatively quicker idea of the quality of concrete, optional tests on beams for modulus of rupture at 72 ± 2 h or at 7 days, or compressive strength tests at 7 days may be carried out in addition to 28 days compressive strength test. For this purpose the values should be arrived at based on actual testing. In all cases, the 28 days compressive strength specified in Table 2 shall alone be the criterion for acceptance or rejection of the concrete.

15.2 Frequency of Sampling

15.2.1 Sampling Procedure

A random sampling procedure shall be adopted to ensure that each concrete batch shall have a reasonable chance of being tested that is, the sampling should be spread over the entire period of concreting and cover all mixing units.

15.2.2 Frequency

The minimum frequency of sampling of concrete of each grade shall be in accordance with the following:

Quantity of Concrete in the Number of Samples

Work, m ³ 1-5	1
6-15	2
16 – 30	3
31- 50	4
51 and above	4 plus one

additional sample for each additional 50 m' or part thereof

NOT---At least one sample shall be taken from each shift. Where concrete is produced at continuous production unit, such as ready-mixed concrete plant, frequency of sampling may be agreed upon mutually by suppliers and purchasers.

153 Test Specimen

Three test specimens shall be made for each sample for testing at 28 days.

Additional samples may be required for various purposes such as to determine the strength of concrete at 7 days or at the time of striking the formwork, or to determine the duration of curing, or to check the testing error. Additional samples may

also be required for testing samples cured by accelerated methods as described in IS 9103. The specimen shall be tested as described in IS 516.

15.4 Test Results of Sample

The test results of the sample shall be the average of the strength of three specimens. The individual variation should not be more than ± 15 percent of the average. If more, the test results of the sample are invalid

16 ACCEPTANCE CRITERIA

16.1 Compressive Strength

The concrete shall be deemed to comply with the strength requirements when both the following condition are met:

- a) The mean strength determined from any group of four consecutive test results compiles with the appropriate limits in col 2 of Table 11.
- b) Any individual test result complies with the appropriate limits in col 3 of Table 11.

16.2 Flexural Strength

When both the following conditions are met, the concrete complies with the specified flexural strength.

- a) The mean strength determined from any group of four consecutive test results exceeds the specified characteristic strength by at least 0.3 N/mm².
- b) The strength determined from any test result is not less than the specified characteristic strength less 0.3 N/mm².

16.3 Quantity of Concrete Represented by Strength Test Results

The quantity of concrete represented by a group of four consecutive test-results shall include the batches from which the first and last samples were taken together with all intervening batches. For the individual test result requirements given in cot 2 of Table 11 or in item (b) of 16.2, only the particular batch from which the sample was taken shall be at risk.

Where the mean rate of sampling is not specified the maximum quantity of concrete that four consecutive test results represent shall be limited to 60 m'.16.4 If the concrete is deemed not to comply pursuant to 16.3, the structural adequacy of the parts affected shall be investigated (see 17) and any consequential action as needed shall be taken.

GENERAL

1. Employer's Drawings

- 1.1. The drawings listed in the Tender document are the Employer's drawings and are provided by the Employer as illustrative of the Specification.

1.2. All data and information furnished in the drawings by the Employer is given in good faith but the Employer does not accept the responsibility for the completeness and accuracy thereof. The same shall be verified by the Contractor promptly pointing out errors or discrepancies thereof to the Engineer.

2. Drawing Sheet Format

- 2.1. All drawings provided by the Contractor shall be on standard size sheets, prepared on computer with AutoCAD 2011/13 and shall show the following particulars in a title block located in the lower right hand corner, in addition to the name of Contractor and equipment manufacturer, date, scale, drawing number, revision number (R0 for drawings submitted initially, R1, R2, etc. for drawings submitted subsequently) and title.



Name:- **PROPOSED DEVELOPMENT OF FIRE STATION AND FIRE STAFF
QUARTERS , AT PRABHUDAS TALAV, FOR BHAVNAGAR
MUNICIPAL CORPORATION, BHAVANAGAR.**

A blank space of 90 mm x 100 mm shall be provided for the Engineer's approval stamp and provision shall be made for details of revisions to be recorded.

2.2. All drawings submitted by the Tenderer/Contractor shall use the English language and preferably SI units. All drawings shall be clearly and fully cross-referenced to the other drawings as relevant.

3. Tender / Contract Drawings

3.1. Drawings submitted by the Tenderer shall show all the essential items of the Plant offered together with sufficient details to enable the general arrangement of the Plant to be determined.

3.2. The drawings and documents to be provided by the Tenderer / Contractor shall be as per the schedules of price but shall not be limited to those listed:

4. Submissions and Approval of Drawings

4.1. The following shall be the procedure for submission and approval of drawings:

4.1.1. The Contractor shall submit 4 copies of the drawings to the Employer. All the drawings are to be signed by the Contractor or his authorized representatives

4.1.2. The Engineer's Representative will review the drawings and, if found fit for approval, the Employer will return 2 copies to the Contractor duly approved.

4.1.3. In case the drawings/documents are not fit for approval but worth for review, the Engineer's Representative will mark the comments on the drawings and return 2 copies to the Contractor. In such case, the Contractor shall resubmit the revised drawings within two weeks as per sub-clause 5.1.1 above and the same shall be repeated till the drawings are finally approved as per sub-clause 5.1.2 above.

4.1.4. If the submitted drawings/documents are not worth for review, the Contractor will be informed accordingly.

4.1.5. On receipt of the approved drawings as per sub-clause 5.1.2 above, the Contractor shall submit floppy and documents to the employer.

4.1.6. After tests on completion, the Contractor shall submit, within 15 days of the conclusion of the tests,

floppies of the "As Built Drawings" to the Employer.

- 4.2. When the drawings are received by the Engineer's Representative after revision by the Contractor, he will only review the revision made and hence the Contractor shall carefully identify all the revised details / dimensions and also describe the revisions in the revision block.
- 4.3. No drawings, with corrections made after taking the prints, will be accepted.
- 4.4. Approval of drawings by the Engineer shall not relieve the Contractor of his responsibility in terms of the Contract.

5. Delivery, Unloading and Storing at Site

- 5.1. The Contractor shall be responsible for checking all materials delivered to Site and shall keep the Engineer's Representative fully informed of the state of deliveries. The Contractor shall carry out, at his cost, all instructions of Engineer or his Representative for proper unloading, preservation, maintenance, storage and security of materials delivered to Site until he fulfills all his obligations under the Contract.
- 5.2. The Contractor shall erect and maintain on the Site any temporary storage facility as required and approved by the Engineer.
- 5.3. Multiple handling and movement of materials during storage and retrieval shall be avoided.

6. Spare Parts:

- 6.1. Spare Parts required after the taking over the Plant shall be filled up by the bidder in the price schedule.
- 6.2. Spares during pre-commissioning trials, commissioning tests/maintenance, guarantee etc. shall be provided by the Contractor. The necessary spares shall be brought by the Contractor prior to the pre-commissioning test so as to avoid the downtime of equipment due to non-availability of them. All these spares have to be provided as required, by Contractor free of cost.
- 6.3. All spare parts shall be new, unused and strictly interchangeable with the parts for which they are intended to be replacements and shall be treated and packed for long storage under the climatic conditions prevailing at the Site. Each spare part shall be clearly marked or labeled on the outside of its packing with its description, number and purpose. When more than one spare is packed in a single case or other container, a general description of its contents shall be shown on the outside of such case or container and a detailed list enclosed. All cases, containers and other packages shall be marked and numbered in an approved manner for the purpose of identification. Spares shall be delivered to Site after the completion of erection but before start of commissioning of Plant along with technical leaflets and details. Spare parts shall be indicated in the assembly drawing showing clearly the part numbers.
- 6.4. All cases, containers or other packages are liable to be opened for such examination as the Engineer's Representative may require and packing shall be designed to facilitate opening and thereafter re-packing. In the event of the some

specific spares offered in the Contract being withdrawn from manufacture owing to changes in design of equipment or similar reasons viz., model being obsolete etc., the Contractor shall inform the Employer before such withdrawal so that the Employer can take timely alternative steps.

7. Tools:

7.1. Tools shall be delivered to site just prior to Tests on Completion.

7.2. The specified tools shall not be used for the erection of the Plant being supplied and except that the Engineer may call upon the Contractor to demonstrate their use or effectiveness, they must be handed over to the Employer in a completely new and unused condition. Should the Contractor require any such tools at site for erection, he shall provide his own.

The test equipment shall include special purpose items essential to the testing or re-calibration of related items of Facilities.

MATERIALS AND WORKMANSHIP

1. Introduction

1.1. This part of the Specification sets out the general standards of materials to be supplied and the workmanship required to be ensured by the Contractor. All component parts of the Works shall, unless otherwise specified, comply with the provisions of employer's requirement or be subject to the approval of the Employer. Particular attention shall be paid to a neat, orderly and well-arranged installation carried out in a methodical competent manner.

2. Reference Specifications and Standards

2.1. Where reference is made in the Specification to a British Standard Specification (hereinafter abbreviated to 'B.S') issued by the British Standards Institution of 2, Park street, London W.1., or to an Indian Standard Specification (I.S.) issued by the Bureau of Indian Standards, (earlier known as Indian Standard Institution), Manak Bhavan, 9 Bahadur shah Zafar Marg, New Delhi 110 002, or American Society for

Testing and materials (ASTM) issued by ASTM 1916 Race Street, Philadelphia, P.A., 19103, U.S.A. or American national Standards Institute (ANSI) issued by ANSI 1430, Broadway, New York, N.Y., 10018, U.S.A. or Japanese Industrial Standards (JIS) issued by Japanese Standards Association, 4-1-24, Akasaka, Minato-Ku, Tokyo 107, Japan or to any other equivalent Standard it shall be to the latest revision of that Standard at the Tender opening date.

- 2.2. The Contractor may propose at no extra cost to the Employer, the use of any relevant authoritative Internationally recognised Reference Standard.
- 2.3. All details, materials and equipment supplied and workmanship performed shall comply with the specified Standards. If Tenderer offers equipment to other Standards, the equipment/material should be equal or superior to those specified and full details of the difference shall be supplied.
- 2.4. In the event of conflict between this Specification and the Codes for equipment, provisions of this Specification shall govern. Certain specifications issued by national or other widely recognised bodies are referred to in this Specification. In referring to the Standard Specifications the following abbreviations are used:

IS	:	Indian Standard
ANSI	:	American National Standards Institute
API	:	American Petroleum Institute
ASME	:	American Society of Mechanical Engineers
ASTM	:	American Society of Testing and Materials
AWS	:	American Welding Society
AWWA	:	American Water Works Association
ISO	:	International Organization for Standardization
DIN	:	Deutsches Institute fur Normung
BS	:	British Standard
IEC	:	International Electrotechnical Commission
IEE	:	Institution of Electrical Engineers
IEEE	:	Institute of Electrical and Electronic Engineers
NEMA	:	National Electrical Manufacturers Association
AGMA	:	American Gear Manufacturer's Association

3. Materials - General

- 3.1. All materials incorporated in the Works shall be the most suitable for the duty concerned and shall be new and of reputed make/approved quality, free from imperfections and selected for long life and minimum maintenance. Non-destructive tests, if called for in the Specification, shall be carried out. All submerged moving parts of the Plant, or shafts and spindles or faces etc. in contact with them shall be of corrosion resistant materials. All parts in direct contact with various chemicals, shall be completely resistant to corrosion, or abrasion by these chemicals, and shall maintain their properties without aging due to the passages of time, exposure to light or any other cause.

4. Workmanship – General

- 4.1. Workmanship and general finish shall be of first class quality and in accordance with best workshop practice.
- 4.2. All similar items of the Plant and their component parts shall be completely interchangeable. Spare parts shall be manufactured from the same materials as the originals and shall fit all similar items.

- 4.3. All parts, which can be worn or damaged by dust, shall be totally enclosed in dust proof housings. All materials incorporated in the Works shall be the most suitable for the duty concerned, free from imperfections and selected for long life and minimum maintenance. All necessary accessories required for satisfactory and safe operation of the Plant shall be supplied by the Contractor unless it is specifically excluded from his scope. Suitable provision by means of eyebolts or other means are to be provided to facilitate handling of all items that are too heavy or bulky for lifting and carrying by two men.

5. **Welding**

- 5.1. Welding shall comply with the latest revision of the BS 5135 Code.
- 5.2. Welders shall be qualified in accordance with the requirement of the appropriate section of BS 4871. The Engineer shall have the right to call for further qualification from time to time from any welder who in the opinion of the Engineer does not produce weld in accordance with the qualification. Each welder shall be assigned a number and letter. Each weldments shall clearly be identified as to its welder marking the welder's Code adjacent to the welds. A record chart shall be maintained for each welder showing the procedures for which he has qualified, the date of such qualification, the type of defects produced and their frequency. The Engineer shall disqualify the welder whose Work requires a disproportionate amount of repairs. All procedures where required shall be qualified as per BS EN 283-3.
- 5.3. Inspection and quality of surveillance shall not be limited to the examination of finished welds. The techniques employed shall be based on methods which are known to produce good results and which have been verified at Site by actual demonstration.
- 5.4. Haphazard striking of the electrodes for establishing an arc shall not be permitted. The arc shall be struck either on the joint or on a starting tag. The starting tag shall be of the same material or a material compatible with the base metal being welded. In case of any inadvertent strike on place other than the welding, the area affected shall be ground flushed and examined by liquid penetration method.
- 5.5. Generally, a stringer bead technique shall be used with a slight oscillation of necessary to avoid slag and to minimize the number of beads needed to fill exceed 3 times the wire diameter. Vertical welds shall be made in upward direction. For all pipes above 300 mm dia., welding shall be done whenever possible, by 2 welders working simultaneously along both sides of the pipe.
- 5.6. The root pass shall have less than 1.5 mm internal reinforcement. Defects like icicles, burn through and excessive "such back", etc. shall be cause for rejection of welds.
- 5.7. Final welds shall be suitable for appropriate fabrication of the non-destructive examination of the weld. If grinding is necessary, the weld shall be blended into the parent metal without gouging or thinning of the parent metal in any way. Uneven and excessive grinding may be a cause for rejection. Fillet weld shall preferably be convex and free from undercutting and overlap at the toe of weld. Convexity and concavity shall not exceed 1.5 mm. The leg lengths shall not exceed the specified size by more than 1.5 mm.
- 5.8. All attachments such as lugs, brackets and other non-pressure parts shall also be done by qualified welders in accordance with the design details and materials specifications. Temporary attachments shall be removed in a manner that will not damage the parent metal. Areas of temporary attachments shall be dressed smooth and examined by ultrasonic or liquid penetration methods.
- 5.9. All tack welds shall be made using qualified procedure and welders, the number of size of tack welds shall be kept as small as to consist of adequate strength and joint alignments. All tack welds shall be examined visually for defects and if found defective shall be completely removed. As welding proceeds, tack welds shall be either removed completely or shall be properly prepared by grinding or filling their starting ends so that they may be satisfactorily incorporated in the welds. Unacceptable defects shall be removed by grinding machine or chipping or gouging. Flame gouging may be permitted provided gouged surfaces are ground at least by 1.0 mm below the deepest indentation.
- 5.10. All weld repairs shall be carried out using the approved welding procedures and welders. Re-welded areas shall be re-examined by the methods specified for the original welds and the Engineer's Representative shall duly qualify repair procedures.

6. Pre-heating and Post-heating Treatment

- 6.1. Pre-heating and post heating treatment shall conform to the relevant application Codes. Pre-heating not exceeding 121 deg. C for all carbon steel construction above 25 mm thickness would be mandatory. Such pre-heating would be maintained during flame cutting, flame or arc gouging, welding and repairs and may be done by gas heating by gas torches/gas rings with neutral flame. The temperature shall be checked by temperature indicating crayons. However, such pre-heating will not be necessary for welds less than 6 mm size. In large diameter pipe fabricated out of plate materials, production control test plates in accordance with the BS 4870 part 1 Table 6 to represent 30% of the long seams and each welder's performance would be mandatory.

7. Electrodes

- 7.1. All electrodes shall be stored in their original sealed containers under dry conditions. Electrodes shall remain identified until consumed. All electrodes shall be dried before use. Drying ovens shall be provided in Work areas for drying purposes. Electrodes withdrawn from oven shall be promptly used and excess unused electrodes shall be promptly returned to oven.

8. Examination/NDT/Radiography

- 8.1. The various stages of examination and types shall be as stipulated in the respective fabrication Codes. Radiographic examination shall be carried out as per provisions of BS 2600 or BS 2910; Ultrasonic tests where called for shall be carried out as per provisions of BS 3926; magnetic particle tests shall be carried out as per BS 6072. Liquid penetration tests shall be carried out as per BS 6443.

9. Stainless Steel Welding

- 9.1. All welding consumable such as electrodes, filler weirs, argon gas for shielding and purging shall be of high quality and the proposed brand shall be furnished for approval of the Engineer. Weld deposits shall have similar or higher physical properties and similar chemical composition to the members joined.
- 9.2. All electrodes shall be purchased in sealed containers only and stored in their packing intact. The packets opened shall be consumed as early as possible. The electrodes removed from the containers shall be kept in holding ovens at temperatures recommended by electrode manufacturer. Special care shall be taken in avoiding mixing of electrodes in the oven. The electrodes and filling wires shall be free from rust, oil, grease, earth and other foreign matter.
- 9.3. Argon gas with purity 99.5% shall be used for shielding and purging. The purity of gas shall be certified by the gas manufacturers.
- 9.4. Non-destructive examination of the welds shall be carried out to ensure quality of weld.
- 9.5. The electric current for welding shall be direct current, straight polarity (electrode negative). The welding current shall be kept minimum possible to ensure minimum heat affected zone in the parent material. Other side of the weld joint shall be periodically flushed with argon gas.

10. Castings

- 10.1. Cast iron shall be of standard grey close-grained quality. The structure of the castings shall be homogeneous and free from non-metallic inclusions and other injurious defects. All surfaces of castings, which are not machined, shall be smooth and shall be carefully fettled to remove all foundry irregularities.
- 10.2. Minor defects in depth not exceeding 12.5 percent of total metal thickness and which will not ultimately affect the strength and serviceability of the casting may be repaired by approved welding techniques. The

Engineer shall be notified of large defects and no repair welding of such defects shall be carried out without prior approval of the Engineer. If the removal of metal for repair should reduce the stress resisting cross section of the casting by more than 25 percent, or to such an extent that the computed stress in the remaining metal exceeds the allowable stress by more than 25 percent, then casting shall be rejected. Test coupons cast simultaneously with the main castings shall be identified to check physical, chemical analysis of casting. Major defects on casting are not acceptable. Castings repaired by welding for minor defects shall be stress-relieved after such welding. Non-destructive tests as directed by the Engineer will be required for any casting containing defects whose extent cannot otherwise be judged, or to determine where repair welds have been properly made.

11. Forging

- 11.1. All major stress-bearing forging shall be made to a Standard Specification. Forging shall be subjected to magnetic particle testing or dye penetration test at the areas of fillets and change in section. The testing shall be conducted after rough machining (10 microns). Any defect, which will not machine out during the final machining, will be gouged out fully, inspected by dye penetration or magnetic particle inspection to ensure that the defect is fully removed and repaired using an approved repair procedure. Any indication, which proves to penetrate deeper than 2.5% of the finished thickness of the component, shall be reported to the Engineer giving the details like location, length, width and depth. For the magnetic particle inspection the choice of wet or dry particles shall be at the Contractor's discretion.
- 11.2. All forging shall be demagnetized after test and shall be heat-treated for the relief of residual stresses.

12. Design Life

- 12.1. The Works as a whole shall be new, of sound workmanship, robustly designed for a long reliable operating life and shall be capable of 24 hours per day continuous operation for prolonged period in the climatic and working conditions prevailing at the Site, and with the minimum of maintenance. Particular attention shall be given to temperature changes, the stability of paint finish for high temperatures, the rating of engines, electrical machinery, thermal overload services, cooling systems and the choice of lubricants for possible high and prolonged operating temperatures. The Contractor shall be called upon to demonstrate this for any component part either by service records, or evidence of similar equipment already installed elsewhere or relevant type tests. Routine maintenance and repair shall as far as possible not requires the services of highly skilled personnel.
- 12.2. The Plant shall be designed to provide easy access to and replacement of component parts, which are subject to wear, without the need to replace whole units. No parts in contact with water shall have a life from new to replacement or repair of less than five years.
- 12.3. Design features shall include the protection of Plant against damage caused by vermin, dirt, dust and dampness and to reduce risk of fire. Plant shall operate without undue vibration, and parts shall be designed to withstand the maximum stresses under the most severe condition of normal service. Materials shall have a high resistance to change in their properties due to the passage of time, exposure to light, temperature and any other cause, which may have a detrimental effect upon the performance or life of the Works.
- 12.4. Plant located outside lockable areas/building shall have additional features to prevent un-authorized operation.

13. Name Plate

- 13.1. Each item of the Plant shall have permanently attached to it in a conspicuous position, a nameplate and rating plate. Upon these shall be engraved or stamped, the manufacturer's name, type and serial number of Plant, details of the loading and duty at which the item of Plant has been designed to operate, and such diagrams as may be required by the Engineer. All indicating and operating devices shall have securely attached to them or marked upon them designations as to their function and proper manner of use.
- 13.2. Nameplates, rating plates and labels shall be of a non-flame propagating materials, either non-hygroscopic or transparent plastic with engraved lettering of a contrasting colour. Fixing shall be by means of non-corrosive screws; drive rivets or adhesives shall not be used.

- 13.3. Warning labels shall be provided where necessary to warn of dangerous circumstances or substances. Inscriptions or graphic symbols shall be black on a yellow background.
- 13.4. Instruction labels shall be provided where safety procedures such as wearing of protective clothing are essential to protect personnel from hazardous or potentially hazardous conditions. These labels shall have inscriptions or graphic symbols in white on a blue background.

14. Nuts, Bolts, Studs and Washers

- 14.1. Nuts, bolts, studs and washers for incorporation in the Plant shall conform to the requirements of the appropriate standard. Nuts and bolts shall be of the best quality of specified grade, machined on the shank and under the head and nut
- 14.2. Fitted bolts shall be a light driving fit in the reamed holes they occupy, shall have the screwed portion of such a diameter that it will not be damaged in driving and shall be marked in a conspicuous position to ensure correct assembly at Site.
- 14.3. Washers, locking devices and anti-vibration arrangements shall be provided where necessary. Jointing hardware for the entire Plant shall be provided with sufficient spares to cater for site losses.
- 14.4. Where bolts pass through structural members taper washers shall be fitted, where necessary, to ensure that no bending stress is caused in the bolt. Where there is a risk of corrosion, bolts, nuts and studs shall be designed so that the maximum stress does not exceed half the yield stress of the material under any conditions. All bolts, nuts and washers that are subject to frequent adjustment or removal in the course of maintenance and repair shall be made of nickel-bearing stainless steel.
- 14.5. The Contractor shall supply all holding down, alignment and leveling bolts complete with anchorages, nuts, washers and packing required to attach the Plant to its foundations, and all bed plates, frames and other structural parts necessary to spread the loads transmitted by the Plant to concrete foundations without exceeding the design stresses.

15. Allowances for Wastage

- 15.1. The Contractor shall supply reasonable excess quantities to cover wastage of those consumable, which will be normally subject to waste during erection, commissioning and setting to Work.

16. Painting – General

- 16.1. The Contractor shall be responsible for the cleaning, preparation for painting, and priming or otherwise protecting, as specified, all parts of the Plant at the place of manufacture prior to packing.
- 16.2. Parts may be cleaned but surface defects may not be filled in before testing at the manufacturer's works. Parts subject to hydraulic test shall be tested before any surface treatment. After test, all surfaces shall be thoroughly cleaned and dried out, if necessary by washing with an approved de-watering fluid prior to surface treatment. Except where the specification provides to the contrary all painting materials shall be applied in strict accordance with the paint manufacturer's instructions.
- 16.3. All protective coatings shall be suitable for use in warm humid climates. All primers, under coats and finishes shall be applied by brush or airless spray, except where otherwise specified. Consecutive coats shall be in distinct but appropriate shades. All paints shall be supplied from the store to the painters, ready for application, and addition of thinners or any other material shall be prohibited.

17. Painting at Place of Manufacture

- 17.1. Steel and cast iron parts shall be sand blasted to near white cleaning before painting. Edges, sharp corners etc. shall be ground to a curve before sand blasting. A primer coat of a zinc rich epoxy resin based coating with at least 75 microns dry film thickness is to be provided. In addition the parts are to be provided with adequate number of coats of coal tar epoxy polyamine coating to a dry film thickness of 175 microns including primer coating.

18. Painting at Site

- 18.1. Immediately on arrival at the site, all items of Plant shall be examined for damage to the paint coat applied at the manufacturer's works, and any damaged portions shall be cleaned down to the bare metal, all rust removed, and the paint coat made good with similar paint.
- 18.2. After erection, such items, which are not finish painted, shall be done so and, items that have been finish painted at the manufacturer's works shall be touched up for any damaged paintwork. For finish painting, two coats of synthetic enamel conforming to IS: 2932 shall be applied. Dry film thickness of each coat shall be at least 25 microns.
- 18.3. The dry paint film thickness shall be measured by Electrometer or other instruments approved by the Employer. In order to obtain the dry film thickness specified the Contractor should ensure that the coverage rate given by the paint manufacturer would enable this thickness to be obtained. Strength of adhesion shall be measured with an adhesion tester and this value shall not be less than 10 kg/cm². Painted fabricated steel work which is to be stored prior to erection shall be kept clear of the ground and shall be laid out or stacked in an orderly manner that will ensure that no water or dirt can accumulate on the surface. Suitable packing shall be laid between the stacked materials. Where cover is provided, it shall be ventilated.

26.0 Mode of measurement and payments: **Payment will be as per payment schedule.**

EXECUTIVE ENGINEER,
BUILDING DEPARTMENT
BHAVNAGAR MUNICIPAL CORPORATION
BHAVNAGAR

**EXECUTIVE ENGINEER
BUILDING DEPARTMENT
BHAVNAGAR MUNICIPAL CORPORATION
BHAVNAGAR**

**PROPOSED DEVELOPMENT OF FIRE STATION AND FIRE STAFF QUARTERS AT PRABHUDAS
TALAV, FOR BHAVNAGAR MUNICIPAL CORPORATION, BHAVANAGAR**

SPECIFICATION FOR LANDSCAPING WORK

**DEV DUTT PANDYA AND ASSOCIATES
ARCHITECT & INTERIOR DESIGNERS,
DM-10, NEAR BINDUNI WAS, KALVIBID MAIN ROAD,
BHAVNAGAR-364002
PHONE NO (0278) 2569070/80**

SPECIFICATION FOR LANDSCAPING WORK

1. AREA CLEANING:

Clearing of the site and roughly dressing the same manually or mechanical devices, including cutting down all waste vegetation, removal of the existing roots of plants/trees, removing debris or previously executed civil work.

2. AREA DRESSING & LEVELING

(2"-3" spreading of existing soil & manual compaction as per drawing, design, specification and direction of EIC. Making the soil free from debris, weeds etc. (Minimum of 90% accuracy required).

3. SHRUBBERY /HEDGE PLANTATION

(To be planted on soil already area dressed or contoured. All shrubs to be as per specified in list attached. Development of bed, plantation of shrubbery including application of FYM (5.00 M3 in 100 M2). Average 7 TO 8 plants in 1 M2.

4. GRASS PLANTATION

(To be planted on GARDEN soil already area dressed or contoured. All grasses to be as specified as per list. Development of bed, plantation of shrubbery including application of FYM9(FARM YARD MANURE) (5.00 M3 in 100 M2). (Vetiveria zizanioides, Saccharum munja grass)

5. TREE PLANTATION (MINIMUM 10' to 12' height)

(supply & plantation): To be planted on soil already area dressed or contoured.

Excavation of pit 1mt x 1mt x 1mt depth.

Mixing of FYM(FARM YARD MANURE) & existing soil in ratio 1:2 and planting of plants. Trees to be as er specified in the attached list. Tree plantation should be carried out neatly accurately and with perfection as per the design and drawing. Plastic bags or pots should be removed carefully and soil around the roots should not be dropped or disturbed. Water retaining basin should be made neatly around the each plantation.

6. Supply of Sweet Earth:

Supply and Spreading of Good earth at site including cost or royalty. As directed by site in charge. no void

LIST OF PLANTS

Sr.No. Name of plant M2 Minimum size from top of bag

1	Nerium var.	2.5'
2	Bougainvillia	2'
3	Ficus long island	2.5'
4	Galphimia gracilis	2'
5	Hymenocallis speciosa	2.5'
6	Ixora Singaporensis (pink)	2.5'
7	Jasminum Sambac	2.5'
8	Leucothylum frutescens	2.5'
9	Murraya exotica	2.5'
10	Nerium (dwarf)	2.5'
11	Bauhinia alba	2.5'

LIST OF TREES

Sr.No. Name of Trees Minimum size from top of bag

1	Azadirachta indica
2	Bauhinia blakena
3	Butea Monosperma
4	Couropita guianensis
5	Dalbergia sissoo
6	Engenia jambolana
7	Ficus Virens
8	Ficus religosa
9	Ficus bengalensis
10	Terminalia arjuna
11	Millingtonia hortensis
12	Polythea lonifolia
13	Plumeria
14	Mangifera indica

Each having 10 to 12 feet height with girth of 3 inch

Sr.No. Name of Grass M2 Minimum size from top of bag

LIST OF GRASS

1	Vetiveria zizanioides	2'
2	Saccharum munja grass	2'

ANTI TERMITE TREATMENT

Anti termite treatment shall be done for various types of works as under and care should be taken that proportion of chemical containing active ingredient Chlorpyrifos and other materials is maintained throughout the work and thoroughly follow instructions as per company's manual. The contractor shall have to give guarantee of the same for ten years in writing and 10 % of the above bill amount shall be retained and the same shall be release after guarantee period.

STAGE : 1

Treat the bottom surface and sides (up to 30 cm height) of the excavations made for column pits, wall trenches and basements @ 5L per sq.m of surface area.

STAGE : 2

Treat the refill earth on both sides of all built up any vertical surfaces of masonry / R.C.C. work (approximate width 30 cm and depth 45 cm) @ 7.5 L per sq.m of vertical surface of substructure.

STAGE : 3

Drill 12 mm holes at the junction of floor and walls at 30 cm c/c to reach the soil below and squirt the emulsion @ 1 litre per hole or till refusal and seal the holes properly. Treat the entire surface (before laying the floor) @ 5 liter per sq.m.

STAGE : 4

Treat the lintel , sill and vertical jambs of all door and window frames by spraying them with chemical .

**EXECUTIVE ENGINEER
BUILDING DEPARTMENT
BHAVNAGAR MUNICIPAL CORPORATION
BHAVNAGAR**

**PROPOSED DEVELOPMENT OF FIRE STATION AND FIRE STAFF QUARTERS AT PRABHUDAS
TALAV, FOR BHAVNAGAR MUNICIPAL CORPORATION, BHAVANAGAR**

.

**SECTION- IV
ELECTRICAL SPECIFICATIONS**

**ARCHITECTS:
DEV DUTT PANDYA & ASSOCIATES
ARCHITECTS AND INTERIOR DESIGNERS
DM-10 BINDU NIWAS, KALVIBID,
BHAVNAGAR- 364002
PHONE: (0278) 2569070,2569080.**

SPECIFICATIONS FOR ELECTRICAL WORKS

**SUBJECT TO THE GENERAL CONDITIONS OF
CONTRACT IN FORCE
(1986)
GENERAL**

1. Wiring Rules :

The installation generally shall be carried out in conformity with relevant Indian Standard Specifications and code of practices prevalent. Indian Electricity Rules 1956 and Indian Electricity Act. 1910 as amended from the time to time.

2. Definition :

The definition of terms shall be in accordance with Indian Standard code of Practice for Electrical wiring Installation IS-732-1982 except for the definition of point in case of Internal Electrical Installation. For definition of point wiring and measurement of Electrical works IS-59008-1970 shall be referred to.

3. Voltage and Frequency of Supply :

All current consuming devices shall be suitable for frequency of 50 C/s and system of voltage meant for unless otherwise specified.

4. Layout of wiring and its description:

(i) The wiring shall be carried out as per Schedule "power" wiring must be in screwed conduit and shall be kept separate and distinct from lighting wiring. All wiring must be done on the distribution system with main and branch distribution boards at convenient centres and without isolated fuses. All conductors shall be run as far as possible along the walls and ceiling as to be easily accessible and capable of being thoroughly inspected. The balancing of circuits will be arranged before hand by the Executive Engineer C. P. Division No. 3.

(ii) Within one month of the taking over the installation, the Contractor shall supply to the Executive Engineer, C. P. Division No. 3 a complete set of wiring diagrams of the same on drawings to be supplied when available by the Executive Engineer, C. P. Division No. 3., and to the satisfaction of the Executive Engineer, C. P. Division No. 3. and these wiring plans shall be "Drawings" within the meaning of the term as used in the General Conditions of contract.

5. Conductors :

All conductors unless otherwise specified shall not be less than 1.5 Sq. mm. for point wiring and 2.5 Sq. mm. for mains. Conductors for power and lighting circuits shall be of adequate size to carry the designed circuit load without exceeding the permissible thermal limits for the installation, and such sizes will be stipulated in specifications and or drawings.

6. Cables :

6.1 All cables shall conform to relevant Indian Standards.

6.2 Conductors of all cable except the flexible cable shall be of aluminium. The smallest aluminium conductors for the final circuit shall have nominal cross sectional area of not less than 1.5 Sq. mm. The minimum size of the aluminium conductors for power wiring shall be 4 Sq. mm.

6.3.1 Conductors of flexible cables shall be of copper. The minimum cross sectional area of such a cables shall be 14.0193 mm. The flexible cable shall have uniform and adequate insulation.

6.3.2 Unless the flexible cables and conductors are protected by armour or though rubber or PVC Sheath, these shall not be used in workshops and other places where they are liable to mechanical damage.

6.3.3 Core flexible cables shall be used for connecting single phase Appliances for phase, neutral & earth connections.

7. Fall of Potential :

The cross sectional area of all conductors inside buildings shall be so proportioned to their lengths that the drop in voltage between main fuses and the farthest point of any lump shall not exceed three percent of the voltage of the consumer's with all the consuming devices in use.

7.1 If the CABLE SIZE is increased to avoid the voltage drop in circuit current rating of the cable shall be more than that for which the circuit is designed. In each circuit or sub circuit every cable shall have a current rating not less than that of the fuse which protects the circuit or sub circuit respectively for current higher than the full load current.

8. Ratings of lamps and fans socket out lets : Points and exhaust fans

8.1 Incandescent lamps installed in residential and non-residential buildings shall be rated at 60 watts & 100 watts respectively.

8.2 Table fans and ceiling fans shall be rated at 60 watts, exhaust fan shall be rated according to their capacity.

- 8.3 5 Amp. socket outlet points and 15 Amp. sockets outlet points shall be rated at 100 watts and 1000 watts respectively for the purpose of load assessment unless values of the load are known or specified.
9. **Tests :**
- 9.1 Before the installation is commissioned following tests shall carried out :
- (1) Insulation Resistance test
 - (2) Polarity Tests of Switches
 - (3) Earth Continuity tests
 - (4) Earth Electrodes Resistance test
- 9.2.1.1 The insulation resistance shall be measured between earth and the whole system of conductors or any section there of with all fuses in place and all switches closed, and except in earthed concentric wiring all lamps in position or both poles of the installation otherwise electrically connected together direct current pressure of not less than twice the working pressure provided that it need not exceed. 500 volts for medium voltage circuits where the supply is derived that it need not exceed. 500 volts for medium voltage circuits where the supply is derived from the three wire D.C. or a poly phase. A.C. System, the neutral pole of which is connected to earth either direct or through added resistance, the working pressure shall be deemed to be that which is maintained between the phase conductor and the neutral.
- 9.2.1.2 The insulation resistance shall also be measured between all conductors to one pole or phase conductor of the supply and all the conductors connected to the neutral or to the order pole or phase conductors of the supply with all lamps in position and switches in 'OFF' position and its value shall be not less than in that specified in Sub-Clause 9.2.1.3.
- 9.2.1.3 The insulation resistance in Megohms measured as above shall not be less than 50 Megohms divided by the number of outlet or when PVC insulated cables are used for wiring 12.5 Megohms divided by number of outlets.
- 9.2.1.4 Where a whole installation is being tested, a lower value than that given by the formula, subject to a minimum of 1 Megohm is acceptable.
- 9.2.1.5 A preliminary and similar test be made before lamps, etc. are installed and in this event the insulation resistance to earth should be not less than 100 Megohms divided by the number of outlet or when PVC insulated cables are used for wiring 25 Megohms divided by number of outlets.
- 9.2.1.6 The term "Outlet" includes every switch except that a switch combined with a socket outlet, appliance or lighting fitting is regarded as one outlet.
- 9.2.1.7 Control rheostat heating and power appliance and electric sign may, if required, be dis-connected from the circuit during the test, but in that event the insulation resistance between the case or frame work, and all live parts of each rheostat, appliance and sign, shall be not less than that specified in the relevant Indian Standard Specification or where there is no such specification shall be not less than half a Megohm.
- 9.2.2 **Polarity Test :**
- 9.2.2.1 In a two wire installation a test shall be made to verify that all switches in every circuit have been fitted in the same conductor throughout & such conductor shall be labeled or marked for connection to the phase conductor or to the non-earthed conductor of the supply.
- 9.2.2.2 In a three wire or a four wire installation a test shall be made to verify that every non-linked single pole switch is fitted in a conductor which is labeled or marked for connection to one of the phase conductor of the supply.
- 9.2.2.3 The installation shall be connected to the supply for testing. The terminals of all switches shall be tested by a test lamp one lead of which is connected to the earth. Glowing of test lamp to its full brilliance, when the switch is in 'on' position irrespective of appliance in position or not shall indicate that the switch is connected to the right polarity.
- 9.2.3 **Earth Continuity Test :**
- The earth continuity conductor including metal conduits and metallic envelopes of cables in all cases shall be tested for electric continuity and the electrical resistance of the same along with the earthing lead but excluding any added resistance or earth leakage circuit breaker measured from the connection with the earth electrode to any point in the earth continuity conductor in the completed installation shall not exceed one ohm.
- 9.2.3.1 **Earth Electrode Resistance Test :**
- Earth electrode Resistance test may be carried out by Megger Earth Testers containing a direct reading ohm-meter, a hand driven generator and auxiliary electrodes.
- 9.3 On completion an electric installation (addition and alteration) a certificate shall be furnished by the Contractor countersigned by the certified Supervisor under whose direct supervision the installation was carried out. This certificate shall be in the prescribed form as given in Appendix-'B' in addition to the test certificate required by Local Electrical Supply Authorities.
10. **Joint and looping back :**
- Unless with the sanction of Executive Engineer Divisions all joints in conductor shall be means of approved mechanical connectors in suitable and approved junction boxes but looping back system shall be preferable. In wiring unless otherwise specified Phase and live conduct shall be looped at the switch box where as a neutral conductor can be looped from light, fan or socket. In non-residential buildings, neutral and earth continuity wire shall be brought to each of the switch boards should be of adequate size to accommodate at least one number of 5 Amps. socket outlet and control switch in future.
11. **Switches :**
- Main Switchgears, Switch Board and their location :

- 11.1 All main switches (other than those of iron clad pattern) carrying current of 10 Amp. and above shall be fitted for back connections and shall be suitably protected.
- 11.2 All switches and circuit breakers shall be constructed in accordance with the I. S. 4237-1967. General requirement for switchgear and control gear for voltage not exceeding 1000 volts and other relevant I.S. provided also that spring shall be either of phospher bronze or if steel shall be copper or Nickel plated and that handle shall be so fastened that they do not tend to unscrew or become loose.
- 11.3 All main switches shall be either of metal clad enclosed pattern or of any insulated enclosed pattern which shall be fixed at close proximity to the point of entry of supply.
- 11.4 Switch boards shall not be erected above gas, stoves, or sinks or within 2.5 m. of any washing unit in the washing rooms of laundries or in the bath rooms, lavatories, toilets or kitchens.
- 11.5 Switch boards, if unavoidably fixed in places likely to be exposed to weather, to drip or to abnormal moist temperature the outlet casing shall be weather proof and shall be provided with glands or bushing of adopted to receive screwed conduit according to the manner in which cables are run PVC and double flanged bushes shall be fitted in the holes of the switches for entry and exit of wires.
- 11.6 A switch board not be installed so that its bottom is within 1.25 m. above the floor unless the front of the switch board is completely enclosed by a door or the switch board is located in a position to which only authorized persons have access.
- 11.7 Switch boards shall be recessed in the wall if so specified in the schedule of work or in the special specification. The front shall be fitted with hinged pannel of other suitable material such as bakelite in wood frame with locking arrangement, the outer surface of door being flush with the walls. Ample room shall be provided at the back for connections and at the front between the switchgear mountings and the door.
- 11.8 Equipments which are on the front of a switch board shall be so arranged that inadvertently personal contact with live parts is unlikely during the manipulation of switchgears, changing of fuses or like operations.
- 11.9 No holes other than the holes by means of which the panel is fixed shall be drilled closer than 1.3 cms. form any edge of the pannel.
- 11.10 The various live parts, unless they are effectively screened by substantial barriers of non-hydroscopic, no-inflammable insulating material, shall be so spaced that space shall not be maintained between such parts and earth.
- 11.11 The arrangement of gear shall be such that they shall be readily accessible and their connections to all instruments and apparatus shall also be traceable.
- 11.12 In every case in which switches and fuses are fitted on the same pole, these fuses shall be so arranged that the fuses are not alive when their respective switches are in the off position.
- 11.13 No fuses other than fuses in instrument circuit shall be fixed on the back of or behind a switch board pannel or frame.
- 11.14 All the metal switchgears and switch boards shall be painted, prior to erection with one coat of antirust primer. After erection they shall be painted with two coats of approved enamel or aluminium paint as required on all sides whenever accessible.
- 11.15 All switch board connected to medium voltage and above shall be provided with 'Danger Notice Plate' conforming to relevant Indian Standards.
12. **Control at Point of Commencement of Supply :**
- 12.1 There shall be a linked main switchgear with fuse on each live conductor of the supply mains at the point of entry. The wiring throughout the installation shall be such that there is no break in the neutral wire except in the form of a linked switchgear. The neutral shall also be distinctly marked. In this connection Rule 32 (2) of the Indian Electricity Rules, 1966 (See Appendix - 'A') shall also be referred.
- 12.2 The main switchgear shall be situated as near as practicable to be termination of service line and shall be easily accessible without the use of any external aid.
- 12.3 On the main switchgear, where the conductor of a two wire system or an earthen neutral conductor of a multi-wire system or a conductor which is to be connected thereto, an indication of a permanent nature shall be provided to identify the earther neutral conductor. In this connection Rule 32 (1) of Indian Electricity Rules, 1956 (See Appendix 'S') shall be referred.
- 13.0 **Switch Board & Distribution Boards :** Metal clad switch gear shall preferably be mounted on any of the following types of Board.
- 13.1 **Hinged type Metal Boards :** These shall consist of a box made of sheet metal not less than 2 mm. thick and shall be provided with a hinged cover to enable the board to swing open for examination of the wiring at the back. The joints shall be welded. A teak wood board, thoroughly protected both inside and outside with good insulating conforming to IS-347-1952 specification for varnish shellac for general purpose, and of not less than 6.5 mm. thickness, shall be provided at the back for attachment of incoming and outgoing cables. There shall be a clear distance of not less than 2.9 cm. between the teak wood beard and the cover, the teak wood board and the cover, the distance being increased for larger boards in order that on closing of the cover, the insulation of the cables is not subjected to damage and no short length of cables is subjected to excessive twisting or bending in any case. The board shall be security fixed to the wall by means of rag bolts, plugs of wooden Gutties and shall be provided with a locking arrangement and earthing stud. All wires passing through the metal board shall be bunched. Alternatively, hinged type metal boards shall be made of sheet munted on channel or angle iron frame.

Note : Such type of boards are particularly suitable for small switch-boards for mounting metal-clad switchgear connected to supply at low voltages.

13.2 Fixed type Metal Boards : These shall consist of an angle of channel of iron frame fixed on the wall or on floor and supported on the wall at the top if necessary. There shall be a clear distance of one meter in front of the switch board. If there are attachments of base connections at the back of the switch board Rules 51 (1) (c) of Indian Electricity Rules, 1956 shall apply.

NOTE : Such type of boards are particularly suitable for large switchboard for mounting large number or switchgears of higher capacity metal clad switchgears or both.

13.3 Teakwood Boards : for small installations connected to a single phase 230 volts supply teak wood boards may be caused as main boards or sub-board. These shall be of seasoned teak or other durable wood with solid back impregnated with varnish of approved quality with all joints dovetailed.

13.4 In large size medium voltage installations, before proceeding with actual construction of the boards, a proper drawing showing the detailed dimensions and design including the disposition of the mountings, which shall be symmetrically and neatly arranged for arriving at the overall dimensions, shall be prepared and approved by the Engineer-in-charge.

13.5 Recessing of Boards : Where so specified the switch boards shall be recessed in the wall. The front shall be fitted with hinged pannel of teak wood or other suitable materials such as bakelite, or with unbreakable glass doors in teak wood frame with locking arrangement, the other surface of the door being flush with the walls. Ample room shall be provided at the back for connection and at the front between the switchgear mountings.

13.6 Arrangement of Apparatus :

(a) Equipment which is on the front of switch board shall be so arranged that inadvertently personal contact with live parts is unlikely during the manipulation of switches, changing of fuses or like operation.

(b) No apparatus shall project beyond any edge of pannel. No fuse body shall be mounted within 2.5 cm. of any edge of the panel and no hole other than holes by means of which the panel is fixed shall be drilled closer than 1.3 cms from any edge of the pannel.

(c) The various live parts, unless they are effectively screened by substantial barriers of non-hydroscopic, non-inflammable insulating material, shall be so spaced that an arc cannot maintain between such parts and earth.

(d) The arrangement of the gear shall be such that they shall be readily accessible and their connections to all instruments and apparatus shall also be easily traceable.

(e) In every case in which switches and fuses are fitted on the same pole, these fuses shall be so arranged that the fuses are not alive when their respective switches are in the 'OFF' position.

(f) No fuses other than fuses instrument circuit shall be fixed on the back of or behind a switch board pannel or flame.

13.7 Marking of Apparatus :

(a) Where a board is connected to voltage higher than 250 volts, all the apparatus mounted on it shall be marked in the following colours to indicate the different poles or phases to which the apparatus of its different terminals may have been connected.

Alternating Current

Three-phase-red

Yellow & Blue

Natural-Black

Direct Current

Three wire system-2 outer wires

Positive red & Negative Blue

Natural-Black

Where fuse-wire three phase wiring is done, the neutral shall be in on colour and the other three wires in another colour.

(b) Where a board has more than one switch, each such switch shall be marked to indicate which section of the installation it controls.

(c) All markings required ounder the rule shall be clear permanent.

13.8 Main & Branch Distribution Board :

13.8.1 Main and branch distribution boards shall be of any type mentioned in 13.1

13.8.2 Main distribution boards shall be provided with a switch or air circuit breaker on each pole of each circuit a fuse on the phase or live conductor and a link on the neutral or earthed conductor of each circuit. The switches shall always be linked.

13.8.3 Branch Distribution Board :

13.8.3.1 Branch distribution boards shall be provided with a fuse or a miniature circuit breaker or both the adequate rating setting chosen on the live conductor of each circuit and the earthed neutral conductor shall be connected to a common link and be capable of being disconnected individually for testing purposes. At least one spare circuit of the same capacity shall be provided on each branch distribution board.

13.8.3.2 In residential installations, lights and fans any be wired on a common circuit, such sub, circuit shall not have more than total of ten points of lights, fans and socket outlets. The load of such circuit shall be restricted to 800 watts. If a separate fan circuit is provided, the number of fans in the circuit shall not exceed ten. Power sub-circuits shall be designed according to the load but in no case shall there be more than two outlets on each sub-circuits.

13.8.3.3 In industrial and other similar installations requiring the use of group control of switching operation, circuits, for socket outlets any be kept separate form fans and lights. Normally fans and lights may be wired on a common circuit, however, if need sub-circuit shall not exceed 3000 Watts. In case of new installation, all circuits and sub-circuits shall be designed by making provision of 20 percent increase in load due to any future modification. Power sub-circuits shall be designed according to the due to any future modification Power sub-circuits shall be designed according to the load but in no case shall there be more than four outlets in each sub-circuits.

13.9 Installation of Distribution Boards :

13.9.1 The distribution fuse-boards shall be located as near as possible to be center of the load they are intended to control.

13.9.2 These shall be of either metal-clad type, or all insulated type. But, if exposed to weather or damp situations, they shall be of the weather proof type and, if installed where exposed to exposed to explosive dust, vapur or gas, they shall be of flame proof type.

13.9.4 Where two or more distribution fuse boards feed low voltage these distribution boards shall be :

(1) Fixed not less than 2 m. apart, or

(2) Arranged so that it is not possible to open two at a time, namely they are interlocked and the metal case is marked 'Danger 415 Volts', or

(3) Installed in a room or enclosure accessible to only authorized persons.

13.9.5 All distribution boards shall be marked 'Lighting', 'Power', as the case may be and also marked with the voltage and number of phases of the supply. each shall be provided with a circuit list giving details of each circuit which it controls and the current rating of the circuit and size of fuse-element.

13.9.6 Triple pole distribution boards shall not be generally used for final circuit distribution unless specific approval of Engineer-in-charge is obtained. In special cases where use of Triple pole distribution boards are inevitable they shall be of H.R.C. fuse type only.

13.10 Wiring and Distribution Board :

13.10.1 In wiring a branch board, total load of the consuming devices shall be divided, as far as possible, evenly between the number of ways of the boards leaving the spare circuit for future extension.

13.10.2 All connection between pieces of apparatus or between apparatus and terminals on a board shall be neatly arranged in a definite sequence following the arrangement of the apparatus mounted thereon, avoiding unnecessary crossing.

13.10.3 Cables shall be connected to a terminal only be soldered or welded or crimped lugs using suitable sleeve, lugs or ferrules unless the terminal is of such a form that it is possible to securely clamp them without the cutting away of cable stands.

13.10.4 All bare conductor shall be rigidly fixed in such a manner that clearance of at least 2.5 cms. is maintained between conductor of opposite polarity or phase and between the conductors and any martial other then insulating material.

13.10.5 If required a pilot lamp shall be fixed and connected through on independent single pole switch and fuse to the bus-bars of the board.

13.10.6 In a hinged type board, the incoming and outgoing cables shall be fixed at one or more points according to the number of cables on the back of the board leaving suitable space in between cables and shall also, if possible be fixed at the corresponding points on the switch board pannel. The cables between these points shall be arranged to on the switch board pannel. The cables between these points shall be arranged to form a "U" or "S" shaped loop which shall be of such length as to allow the switchboard pannel to swing through an angle of not less then 90⁰.

14.0 Capacity of Circuits :

14.1 Lights and fans may be issued on a common circuits and such a circuit shall not have more than a total of ten points of lights, fan and socket outlets, or a load of 800 watts whichever is less. The power circuits shall be designed with a maximum of two outlets per circuits generally when load is not known or specified. In non-residential buildings at important District centres however one outlet per circuit may be preferred. The circuit shall be designed based on the loading of the circuit where not specified, the load shall be taken as 1 KW per outlet, Where the load is more than 1 KW it should be controlled by a isolator switch or miniature circuit breaker.

15.0 Passing Through Walls and Floors :

15.1 Where conductors pass through walls one of the following methods shall be employed. Care shall be taken to see that wires pass very freely through protective pipe or box and that the wires pass through in a straight line without any twist or cross in wires, on either ends of such holes.

(a) A teak wood box entending through the whole thickness of the wall shall be buried in he wall and casings or conductors shall be carried so as to allow 1.3 cms. air space on three sides, of the casing conductor.

(b) The conductor shall be carried either in a rigid steel conduit conforming to "IS : 1653-1964 specification for Rigid Steel conduits of Electrical wiring (Revised) or a rigid non-metallic conduit conforming to *IS : 2509-1963 specification for Rigid Non Metallic conduits for Electrical Installations, or in a porcelain tube of such size which permits easy drawing in. The end of conduit shall be neatly bushed with porcelain, wood or other approved material.

(c) Insulated conductors while passing through floors shall be protected from mechanical injury by means of rigid steel conduit (see * IS 1653-1964) to height not less than 1.5 m. above the floors and flush with the ceiling below. This steel conduit shall be earthed and securely bushed.

15.2 Where a wall tube passes outside a building so as to be exposed to weather, the outer end shall be belt mounted and turned down wards, and properly bushed on the open end.

16.0 Fixing to Walls and Ceilings :

Plugs for ordinary walls or ceilings shall be of well seasoned teak or other approved hardwood not less than 5 cm long 2.5 c. square on the inner end and 2 cm. square on the outer end. They shall be cemented into walls to within 7.5 mm of the surface, the remaining being finished according to the nature of the surface plaster or lime punning.

16.1 Where owing to irregular crossing or other reasons the plugging of the walls or ceiling with wood plugs presents difficulties, the wood casing, wood batten, metal conduit or cleat (as the case may be) shall be attached to the wall or ceiling in an approved in the walls before they are plastered.

16.2 To achieve neatness, plugging of walls or ceiling may be done by an approved type of asbestos, metallic or a fiber fixing plug.

17.0 Branch Switches :

Where the supply is derived from a three-wire or four-wire source, and distribution is done on the two wire system, all branch switches shall be placed in the outer or live conductor of the circuit and no single-phase switch or fuse shall be inserted in the middle wire, earth or earthed neutral conductor of the circuit, Single-pole switches (other than for multiple control) caring not more than 15 amperes may be of tumbler type which shall be 'ON' when the handle known is down.

18.0 Fittings :

Where conductors are required t be threaded through tubes or channels formed in the metal work of fittings these must be free from sharp angles or projecting edges and such size that will enable them to be wired the conductors used for the final sub Circuits without removing the boarding, taping or outer covering. As far as possible, all tubes and channels should be of sufficient size to permit 'Looping back' of wires cables and flexible cords other than those designed for high temperature shall not be used for wiring fittings except for portable fittings. All fittings must have not less than a half inch male nipple. Fittings and lamp holders for gas filled lamps shall be adequately ventilated.

18.1 Where light fitting is supported by one or more flexible cords, the maximum weight to which the twin flexible cords may be subjected shall be as follows :

Nominal cross sectional Area cord. mm ²	No. & Dia in mm of wires.	Max Permissible weight Kg.
0.5	16/0.2	1.7
0.75	24/0.2	2.6
1.0	32/0.2	3.5
2.5	48/0.2	5.3
3.5	80/0.2	8.8
4	128/0.2	14.0

8.2 No inflammable shade shall form a part of light unless such shade is well protected against all risks of fire. Celluloid shade or light fitting shall not be used under any circumstances.

8.3 Fitting of Wire :

The use of fitting wire shall be restricted to the internal wiring and the lighting fittings. Where fitting wire is used for wiring, the sub-circuit loads shall be terminated in a ceiling zone or connector from which they shall be carried into the fitting.

9.0 Lamp Holders :

Lamp holders for use on brackets and the like shall be in accordance with "IS : 1258-1967, specification for Boyonet lamp holder and all those for use flexible panants shall be provided with cord grips. All lamp holders shall be provided with shade carriers. Where centre contact Edison screw lamp holders are used, the outer or screw contacts shall be connected to the middle wire, the natural, and the earthed conductor of the circuit.

20. Outdoor Lamps :

External and road lamps shall have weather proof fittings of approved design so as to effectively prevent the admission of moisture. An insulating distance piece of moisture proof materials shall be inserted in the fittings. Flexible cord and cord grip lamp holders shall not be used where exposed to weather. In verandahs and similar exposed situations where pendants are used, they shall be of fixed road type.

21.0 Lamps :

All incandescent lamps, unless otherwise required and suitably protected, shall be hung at a height of not less than 2.5 m above the floor level, They shall be in accordance with IS : 418 : 1957 specification for Tongster Filament General service electric lamps.

22.0 Fans, Regulators and Clamps :

22.1.0 Ceiling fans :

			S	B	S	B	S	B	S	B	S	B	S	B
1.0	1/1.12	5	4	7	5	13	10	20	14	-	-	-	-	-
1.5	1/1.40	4	3	7	5	12	10	20	14	-	-	-	-	-
2.5	1/1.80	3	2	6	5	10	8	18	12	-	-	-	-	-
4	1/2.24	3	2	4	3	7	6	12	10	-	-	-	-	-
		(3/1.06*)												
		(7/0.85)												
6	1/2.80	2	-	3	2	6	5	10	8					
		(7/1.06*)												
10	1/3.55+	-	-	2	5	4	8	7	-	-	-	-	-	-
		7/1.40*	-	-	2	-	4	3	6	5	8	6	-	-
16	7/1.70	-	-	-	-	2	-	4	3	7	6	-	-	-
25	7/2.24	-	-	-	-	-	-	3	2	5	4	7	6	9
35	7/2.50	-	-	-	-	-	-	2	-	4	3	7	5	8
50	7/3.00+	-	-	-	-	-	-	-	-	2	-	5	4	6

*For Cu. Conductors only.

+ For Al. conductor only.

NOTE 1 The cable shows the maximum capacity of conditions for the simultaneous drawing-in of cables. The table applies to 250 volts grade cable. The columns headed 'S' apply to runs of conduit which have distance not exceeding 4.25 M between draw in boxes, and which do not deflect from the straight by angle of more than 15⁰. The columns headed 'B' apply to runs of conduit which deflect from the straight by an angle of more than 15⁰.

NOTE 2 In case of inspection type draw-in box has been provided and if the cables is first drawn through one straight conduit, then through the drawn box, and then through the second straight conduit, such systems may be considered as that of a straight conduit even if the conduit deflects through the straight by more than 15⁰.

25.1.4 Protection against dampness - In order to minimize condensation or sweating inside the tube, all outlets of conduit system shall be properly drained and ventilated, but in such a manner as to prevent the entry of insects as far as possible.

25.1.5 Protection of conduit against rust : The outer surface of the conduit pipes, including all bends, unions, tees junction boxes, etc., forming part of the conduit system shall be adequately protected against rust particularly when such system is exposed to weather. In all cases, no bare threaded portion of conduit pipe shall be allowed unless such bare threaded portion is treated with anti-corrosive preservative or covered with approved plastic compound.

25.1.6 Fixing of conduit - Conduit pipes shall be fixed by heavy gauge saddles, secured to suitable wood plugs or any other approved plug with screws in an approved manner at an interval of not more than one metre but on either side of couplers bends or similar fittings. Saddles shall be fixed at a distance of 30 cm. from the centre of such fittings.

25.1.7 Bends in conduit - All necessary bends in the system including diversion shall be done by bending pipes. or inserting suitable solid or inspection type normal bends, elbows or similar fittings; or by fixing cast iron inspection boxes whichever is more suitable. Conduit fitting shall be avoided as far as possible. On conduit system exposed to weather, where necessary, solid type fitting shall be used. Radius of such bends in conduit pipes shall be not less than 7.5 cm. No length of conduit shall have more than the equivalent of four quarter bends from outlet, the bends at the outlets not being counted.

25.1.8 outlets - All outlets for fitting switches etc. shall be boxes of suitable metal or any other approved outlet boxes for other surface mounting or flush mounting system.

25.1.9 Conductor - All conductor used in conduits wiring shall preferably be stranded. No single-core cable or nominal Cross-sectional area greater than 130 mm² shall be enclosed in a conduit and used for alternating current.

25.1.10 Erection and earthing of conduit - The conduit of each circuit or section shall be completed before conductors are drawn in. The entire system of conduit after erection shall be tested for mechanical and electrical continuity throughout and permanently connected to earth conforming to the requirements specified under 7 by means of special approved tupe earthing clamp efficiently fastened to conduit pipe in a workman like manner for a perfect continuity between each wire and conduit Gas or water pipes shall not be used as earth medium. If conduit pipes are liable to mechanical damage they shall be adequately protected.

25.2 Recessed Conduit wiring system with Rigid Steel conduits - Recessed conduit wiring system shall comply with all the requirements for surface conduit wiring system specified in 6.5.1.1 to 6.5.1.10 and addition, conform to the requirements specified in 6.5.2.1 to 6.5.2.4.

25.2.1 Making of chase - The chase in the wall shall be neatly made and be of ample dimensions to permit the conduit to be fixed in the manner disired. In the case of buildings under construction, chases shall be provided in the wall, ceiling etc., at the time of their construction and shall be filled up neatly after erection of conduit and brought to the original finish or the wall.

25.2.2 Fixing of conduit in chase - The conduit pipe shall be fixed by means of staples or by means of saddles not more than 60 cm. apart. Fixing of standard bends or elbows shall be avoided as far as practicable and all curves maintained by bending the conduit pipe itself with a longe radius which will permit easy drawing in of conductors. All threaded joints of rigid steel conduit shall be treated with some approved preservative compound to secure protection against rust.

25.2.3 Inspection boxes - Suitable inspection boxes shall be provided to permit periodical inspection and to facilitate removal of wires, if necessary. These shall be mounted flush with the wall. Suitable ventilating holes shall be provided in the inspection box covers.

25.2.4 Type of accessories to be used - All outlets such as switches and wall sockets, may be either or flush mounting type or surface mounting type.

(a) Flush mounting type : All flush mounting outlets shall be of cast iron mild steel boxes with a cover of approved insulating material or shall be a box made of suitable insulating material. The switches and other outlets shall be mounted on such boxes as would be approved. The metal box shall be efficiently earthed with conduit by an approved means of earth attachment.

(b) Surface mounting type - If surface mounting type outlet box is specified, it shall be of any approved insulating material and outlet mounted in an approved manner.

25.2.5 When crossing through expansion joints in buildings, the conduit sections across the joint may be through flexible conduits of the same size as the rigid conduit.

25.3 Conduit Wiring system with Rigid Non-Metallic Conduits : Rigid Non-Metallic conduits are used for surface, recessed and concealed conduit wiring.

25.3.1 Type and size - All non metallic conduits used shall conform to IS : 2509-1963-The conduit may be either threaded type or plain type as specified in IS : 2509-6913* and shall be used with the corresponding accessories (See IS : 3419-1965) specification for Fittings for Rigid Non-Metallic Conduits).

25.3.2 Bunching off cables - Conductors of AC supply and DC supply shall be bunched in separate conduits. The number of insulated cables that may be drawn into the conduits are given in Table III. In this table space factor does not exceed 40 percent.

**TABLE - III
MAXIMUM PERMISSIBLE NUMBER OF 250 VOLTS GRADE SINGLE -
CORE CABLE THAT MAY BE DRAWN INTO RIGID NON-METALLIC CONDUITS**

Size of cable		Size of conduit (mm.)					
Nominal Cross Sectional Area	No. & Diameter in mm. of wires	16	20	25	32	40	50
		(Number of Cables, Max)					
mm ²							
1.0	1/1.12*	5	7	13	20	-	-
1.5	1/1.40	4	6	10	14	-	-
2.5	1/1.80	3	5	10	14	-	-
	3.1.06*						
4	1/2.24	2	3	6	10	14	-
	7/0.85*						
6	1/2.80	-	2	5	8	11	-
	7/1.06*						
10	1/3.55+	-	-	4	7	9	-
	7/1.40*						
16	7/1.70*	-	-	2	4	5	15
25	7/2.24	-	-	-	2	2	6
35	7/2.50	-	-	-	-	2	5
50	7/300+	-	-	-	-	2	3
	19/1.80						

* For copper conductors only.

+ For aluminium conductors only.

25.3.3 Conduit joints - Conduit joints shall be jointed by means of screwed or plain couplers depending on whether the conduits are screwed or plain. Where there are long runs of straight conduit. Inspection type couplers shall be provided at intervals. For conduit fittings and accessories reference may be made to IS : 3419-1965.

- 25.3.4 Fixing of conduits** - The provision of 25.1.6 shall apply except that the spacing between saddles or supports is recommended to be 60 cms. for rigid non-metallic conduits.
- 25.3.5 Bends in conduit** - Wherever necessary, bends or diversions may be achieved by bending the conduits (See 6.5.3.9) or by employing normal bends, inspection bends, inspection boxes, elbows or similar fittings.
- 25.3.6** Conduit fittings shall be avoided, as far as possible on outdoor system.
- 25.3.7 Outlets** - All the outlets for fittings, switches, etc., shall be boxes of substantial construction. In order to minimize condensation or switching inside the conduit, all outlets of conduit system shall be properly drained and ventilated, but in such a manner as to prevent the entry of insects, etc. as far as possible.
- 25.3.8** For use with recessed conduit wiring system the provisions of 6.5.2.1 to 6.5.2.4 shall apply.
- 25.3.9** Heat may be used to soften conduit for bending and forming joints in case of plastic conduits. As the material softens when heated, fitting of conduit in close proximity to hot surfaces should be avoided. Caution should be exercised in the use of the conduit in locations where the ambient temperature is 50°C or above. Use of such conduits in place where ambient temperature is 60°C or above is prohibited.

PVC INSULATED P.V.C. SHEATHED OR T.R.S. WIRING SYSTEM

26.0 GENERAL :

This system of wiring, is suitable for low pressure installation, and shall not be used in places exposed to sun and rain nor in damp places, provided they are sheathed in the special approved protective covering and well protected to withstand dampness.

26.1 Attachment to walls and ceiling :

26.1.1

All cables on brick walls, stone or plastered walls ceiling shall be run on well seasoned, perfectly straight and well varnished on four sides, teak wood or any approved hardwood battens not less than 10 mm finished thick, width of which shall be such as to suit total width of cables laid on the batten, prior correction, these shall be painted with one coat of varnish or approved paint of colour to match with surrounding. These battens shall be secured to wall and ceilings by flat head wood screws to rows plug or phill plug at an interval not exceeding 75 cm. Wood plug can be used only with special approval of the Engineer-in-charge. The flat head wood screws shall be counter within wood batten and smoothed down with file.

26.1.2

Where wiring is to be carried out along the face of the rolled steel joints, a wooden batten of adequate width shall first be laid on the same and dipped to it as inconspicuously as possible. The wiring should then be fixed to this backing in the ordinary way. Where wiring passes through structural steel work, the hole shall be suitably bushed to prevent the abrasion of the cables.

26.1.3

Attachment to false ceiling : In no case, the open wiring shall be run above the false ceiling without the approval of Engineer-in-charge.

26.2.0

Link dips : Only aluminium alloy clips/joint clips shall be used. The thickness shall be 0.32 mm (30 SWG) for lengths of 25 mm to 40 mm and 40 mm (28 SWG) for lengths of 50 mm to 80 mm. The width shall not be less than 8 mm in all these cases. Link clips/joint clips shall be so arranged that one single clip shall not hold more than two core or three single core TRS of PVC insulated and PVC sheathed upto 2.5 sw. mm. above while a single clip shall hold a single twin core or two single core cables. The clips shall be fixed on varnished wood batten switch iron pins and spaced at interval of 15 cm both in the case of horizontal and vertical runs.

26.3.0

Bends in wiring : The wiring shall not in any circumstances be bent so as to form an abrupt right angle but must be rounded off at the corners to radius not less than six times the overall diameter of the cable.

26.4.0 Protection of wiring form Mechanical Damage :

26.4.1

In cases where there are chances of any damage to wiring, such wiring shall be drawn complying with the all the requirements of conduit wiring system.

26.4.2

Such protective covering shall in all cases be fitted on all down drops within 1.5 m. from the floor or from floor level up to the switch board whichever is less.

26.5.0

Passing through floors: All cables taken trough floor shall be enclosed in heavy gauge steel conduit extending 1.5 m. above the floor or up to the switch board, whichever is less and flush with the ceiling below or by means of any approved type of metallic covering. The ends of all conduits or pipes shall be neatly bushed with porcelain wood or other approved material. The conduit pipes, shall be security earthed.

26.6.0

Passing through walls: When conductors pass through walls, any one of the following methods shall be employed. Care should be taken to see that wires pass very freely through protective pipe or box and that wires pass through in a straight line without any twist or cross in wires on either ends of such holes.

(a)

A box of teak wood or approved hard wood extending through the hole thickness of the wall shall be buried in the wall and casings or conductors shall be carried so as to allow 1.3 cm air space on the three sides of the casing or conductor.

(b)

The conductors shall be carried in an approved heavy gauge solid drawn or lap weld conduit or in a porcelain tube of such a size that it permits easy drawing in, the ends conduit shall be neatly bushed with porcelain, wood or other approved material.

26.6.1

Where a wall tube passes outside a building so as to be exposed to weather, the outer end shall be mounted and turned downwards and property bushed on the open end. The conduit shall be neatly arranged so that the cables enter them without bending.

26.7.0

Buried cables: The TRS or PVC sheathed cable shall not normally be buried directly in plaster. Where so specific in the special specification they may be taken in teak wood channeling of ample capacity or conduit pipe buried in the wall.

26.8.0

Stripping of outer covering - While cutting and stripping of the outer covering of the cable care shall be taken that the sharp edge of the cutting instrument does not touch the inner insulation of the conductors. The protective outer covering of the cables shall be stripped off near connecting terminal and this protective covering shall be maintained up to the close proximity of connecting terminals as far as practicable. Care shall be taken to avoid hammering on link clips with any metal instrument after the cables are laid. Where junction boxes are provided they shall be made moisture proof with a plastic compound.

27.0 PAINTING WORK IN GENERAL:

27.1

Paints : Paints, oils varnishes, etc., of approved make in original to the satisfaction of the Engineer-in-charge shall only be used.

27.2

Preparation of surface : The surface shall be thoroughly cleaned and dusted before painting is started. The proposed surface shall be inspected by Engineer-in-charge or his authorized agent and shall have received the approval before painting is commenced.

- 27.3 Application :** Paint shall be applied with brush. The paint shall be spread as smooth & even as possible. Particular care shall be paid to rivets, nuts, bolts and cover lapping. Before drawing cut, it shall be continuously stirred in the smaller containers with a smooth stick while it is being applied.
Each coat shall be allowed to dry out sufficiently before a subsequent coat is applied.
- 27.4 Scope :** Painting on old surface in indoor situations will not include primer coat except where specially mentioned in the schedule of work or special specification. However, where rust has formed on iron and steel surfaces the spots will be painted with one anti-rust primer coat.
- 27.5 Precautions :** All furniture fixtures glazing floors, etc., shall be protected by covering. All stains, smears, polishing, dropping of every kind shall be removed. While painting of wiring etc. it shall be ensured that painting of wall ceiling etc., is not spoiled in any way.
- 27.6 Painting of conduit and accessories:** After installation surface of conduit pipes, fittings switch and regulator boxes, etc. shall be painted with two coats of approved enamel paint or aluminium paint as required to match the finish of surrounding wall trusser, etc.
- 28 Link clip :**
The clip for batten wiring shall be of Aluminium conforming to I. S. specification No.2415-1975.

APPENDIX - 'A'

Important Clauses of Indian Electricity Rules, 1956 Following clauses of Indian Electricity Rules, 1956 shall in particular be taken care of in the execution of electrical works

Clause No

Subject

3. Authorisation.

- 29. Construction, installation, protection, operation and maintenance of electric supply lines and apparatuses.
- 31. Cut-out on consumer's premises.
- 32. Identification of earthed and earthed neutral conductors and position of switches and cut-out therein.
- 33. Earthed terminal on consumer's premises.
- 36. Handling of electric supply lines and apparatus.
- 41. Distinction of circuits of different voltages.
- 42. Accidental charge.
- 43. Provisions applicable to protective equipment.
- 44. Instructions for restoration of persons suffering from electric shock.
- 45. Precautions to be adopted by consumers, owners, electrical Contractors, Electrical workmen and suppliers.
- 46. Periodical inspection and testing of consumer's installation.
- 48. Precautions against leakage before connection.
- 50. Supply to consumers.
- 51. Provisions applicable to medium, high voltage installations.
- 58. Point of commencement of supply.
- 59. Precautions against failure of supply; Notice of failures.
- 61. Connection with earth, (Low and Medium Voltage system).
- 64. Use of energy of high and extra-high voltage system.
- 67. Connection with earth. (High & Extra-high voltage system).
- 68. General conditions as to transformation and control of energy.

All Clauses under Chapter VIII on Overhead Lines.

- 137. Mode of entry.
- 138. Penalty for braking seal.
- 139. Penalty for breach of rule 45.
- 140. Penalty for breach of rule 82.
- 141. Penalty for breach of rules.

APPENDIX - 'B'

Form of Completion Certificate

I/We certify that the installation detailed below has been installed by me/us and tested and that to the best of my/our knowledge and belief, it complies with Indian Electricity Rules 1956 as well as the C.P.W.D. General Specification for Electrical Works 1972.

Electrical Installation at Voltage and system of supply

(1) Particulars of Works :

(a)	Internal Electrical Installation	No. Total Load	Type of system of wiring.
	(i) Light point		
	(ii) Fan point		
	(iii) Plug point		
	(a) 3 pin 5 Amp.		
	(b) 3 pin 15 Amp.		

(b) Others :

Description		HP/KW
(a) Motor:	(i)	
	(ii)	
	(iii)	

(c) Other Plants:

(d) if the work involves installation of overhead line/or underground cable :

- (a) (i) Type & Description of overhead line.
- (ii) Total length & No. of spans.
- (iii) No. of street light & its description
- (b) (i) Total length of under ground cable & its size.
- (ii) No. of joint.

End joint:
Tee joint:
St. through joint:

(2) Earthing :

- (i) Description of earthing electrode :
- (ii) No. of earth electrodes :
- (iii) Size of main earth lead :

(3) Test Results :

(a)	Insulation Resistance :	
	(i) Insulation resistance of the whole system of conductors to earth	Megohms
	(ii) Insulation resistance between the phase conductors and neutral	Megohms
	Between phase R and neutral	Megohms
	Between phase Y and neutral	Megohms
	Between phase B and neutral	Megohms
	(iii) Insulation resistance between the phase conductors in case of polyphase supply.	
	Between phase R & phase Y	Megohms
	Between phase Y & phase B	Megohms
	Between phase B & phase R	Megohms

(b) Polarity Test:

Polarity of non-linked single pole branch switches.

(c) Earth continuity Test:

Maximum resistance between any point in the earth continuity conductor including metal conduits & main earthing lead. ohms

(d) Earth Electrode Resistance:

Resistance of each electrode.

- (i) ohms
- (ii) ohms
- (iii) ohms
- (iv) ohms

(e) Lighting Protective System:

Resistance of the whole of lighting-protective system to earth before any bonding is effected with electrode and metal in/on the structure. ohms

Signature of Supervisor

Signature of Contractor

Name & Address

Name & Address

SPECIFICATION

All Specification, standard, publication etc. specified mean the latest standards, publication etc. pertaining to Electrical Installation and should conform to the following wherever applicable.

- (1) Indian Electricity Act. 1910 with its amendments.
- (2) Indian Electricity Rules, 1956 and its amendments.
- (3) Indian Electricity supply Act. 19948.
- (4) Regulation for Electrical Equipment in building by I.E.F. London.
- (5) The Factory Act, 1948 and its amendments.
- (6) I. S.-732-1982 Part-I, II & III code of practice for Electrical wiring and fittings in buildings for low and medium voltages.
- (7) I. S. 4064-1967 H. D. Air break switches and fuses for Voltages not exceeding 1100 volts.
- (8) I.S. 3043 - Earthing code of practice for
- (9) I.S. - 1554 Part-I 1970 PVC insulated (Heavy duty) Electrical Cables for working voltages upto and including 1100 volts.
- (10) I.S. : 694 - 1964 Part - II - PVC insulated cable with Aluminium conduits (revised) for voltages upto 1100 volts.
- (11) I.S. : 5908-1970 Electrical installations in buildings method of measurements of.
- (12) I.S. : 4237-1967 General requirement for switchgear and control for voltage not exceeding 1000 volts.
- (13) I.S. 1653-1964 - Rigid steel conduits for electrical wiring (revised)
- (14) I.S. : 2509-1973 - Rigid steel conduits for electrical installation. (First revision)
- (15) I.S. : 1258 - 1967 - Bayonet lamp holders (First revision)
- (16) I.S. : 418-1957 - Tungsten-Filament General service electric lamps (Third revision)
- (17) I.S. : 374-1966 - Fans and Regulators, ceiling type, electric (second revision)
- (18) I.S. : 2667-1964 Fittings for rigid steel conduits for electrical wiring.
- (19) I.S. : 3419-1976 - Fitting for rigid non-metallic conduits (First revision)
- (20) National Electric Code, 1986

ANNEXURE - I

Abstract of the Wiring Rules of the Institution of Electrical Engineer

(referred to in the specification)

DEFINITIONS (See Clause 2 of the Specification)

Systems :

All electrical system in which all the conductor and apparatus are electrically connected to a common source of supply.

- (1) **Earthed:** Effectually connected to the general mass of the earth, Solidly earthed means earthed without the intervention of a fuse, switch, circuit-breaker, resistor reactor or solenoid.
- (2) **Uninsulated Conductor:** A conductor without provision, by the interposition of a dielectric or otherwise, for its insulation from earth.
- (3) **Bare :** Not covered with insulating material.
- (4) **Dielectric :** Any material which offers high resistance to the passage of the an electric current.
- (5) **Bunch Conductor :** When more than one conductor is contained within a single duct or groove or when they are run enclosed and not spaced apart from each other.
- (6) **Points :** In wiring as per I.S. : 5908-1970-Method of measurements of electrical installation in buildings.
- (7) **Switch Board :** An assemblage of switchgear with or without instruments, but the term does not apply to a group of local switches in a final sub-circuit where each switch has its own insulating base.
NOTE : In the Electricity (Factories Act) special regulations, 1908 and 1944 the term "Switchboard" includes "Distribution board".
- (8) **Single pole switch :** A switch suitable for closing and or opening a circuit on one phase or pole only.
- (9) **Linked switches :** A switch the blades of which are so linked mechanically as to make or break all poles simultaneously or in a definite sequence.
- (10) **Fuse Switch :** A switch the moving part of which carries one or more fuses.
- (11) **Three Wire System :**
 - (a) **Outer Conductor:** Those between which there is the greatest difference of potential. This use of the word outer must not be confused with the use of the work when applied to the external conductor of a concentric main.
 - (b) **Neutral Conductors:** The term includes the neutral conductor of a 3 phase 4 wire system, the conductor of a single phase or d. c. installation which is earthed by the supply undertaking (or otherwise at the source of the supply) and the middle wire of common return conductor of a 3 wire D. C. or single phase A.C. system.
- (12) **Semi enclosed machine:** One in which the ventilating openings in the frame are covered with -
 - (a) Grids expanded metal or wire gauge, with openings of less than 1/4 inch so as to obstruct free ventilation.
 - (b) Wire gauge, in which the opening are less than 1/4 inch but not less than 3/32 inch (diameter or width) :
 - (c) Screens with smaller openings than the above.
- (13) **Totally - enclosed Machine:** One in which the enclosing case and bearings are dust proof and which does not allow circulation of air between the inside and outside of the case.
- (14) **Pipe Ventilated Machine:** An enclosed machine in which the frame is so arranged that the ventilating air may be conveyed to it through a pipe attached to the frame, the ventilation opening maintained by the fanning action produced by the machine - itself.
- (15) **Forced draught Machine:** An enclosed machine in which the ventilating air supply is maintained by an independent fan external to the machine itself.
- (16) **Protected Machine:** One having end shield bearings and in which there is free access to the interior without opening doors or removing covers.

SWITCHES AND CIRCUIT BREAKERS

(See clause II of Specifications)

(17) Switches and Circuit Breakers :

Switches and circuit breakers (rules 2b.36 and 37) whether fixed separately or combined with lamps, holders or fittings, must comply with the following requirements :

- (a) Overt heading must not take place at the point of contact or elsewhere, when the full current flows continuously.
- (b) They must be so constructed or arranged that the contacts cannot accidentally close when left open.
- (c) The basis must be of incombustible, non-conducting and moisture proof material.
- (d) Circuit breaker must be so arranged and placed that no combustible material is endangered by their action.

- (e) Unless placed in an engine room or in a compartment especially arranged for the purpose, they must have their live parts covered. The covers must be of incombustible material and must be either non-conduction or of rigid metal and clear of all internal mechanism. For more than 6 amperes, at pressures exceeding 125 Volts metal covers must be lined with insulating material.
- (f) In positions where they are liable to injury or come into contact with goods, they must be further protected by an open fronted box or other suitable guard.
- (g) Handles must be insulated and so arranged that the hand cannot touch live metal, or be injured through and adjacent fuse blowing.
- (h) Switches having a handle projecting through an open slot in the cover, must not be used.

Signature of Contractor

EXECUTIVE ENGINEER
BUILDING DEPARTMENT
BHAVNAGAR MUNICIPAL CORPORATION,
BHAVNAGAR

GENERAL REQUIREMENTS

1.1 **Scope of works :**

The work covered by electrical specification consists supplying and installing, electrical wiring system complete in strict accordance with this specification and the applicable drawing and subject to the terms and conditions of the contract. It includes -

- (a) Conduit and wiring system for fans, lighting points, clocks, sockets, etc., including fixing of lighting fixtures and fans etc., **and miscellaneous points.**
- (b) Conduit and wiring system for **exhaust fans sockets etc.**
- (c) Panel boards, distribution boards.
- (d) Complete power and lighting
- (e) Grounding system.
- (f) Conduits system.
- (g) Street lighting system
- (h) Other miscellaneous electrical

1.2 **Completeness of Contract:**

Any work fittings accessories or apparatus which may not have been specifically mentioned in the specification but which are necessary in the equipment for efficient working of the plant should be deemed to be included in the contract and should be executed and provided by the Contractors. All plant and apparatus should be complete in all the details, whether such details, are mentioned in the specifications or not.

Three prints and one permanent negative of each of the finally approved drawings incorporating all the modifications proposed by the Department should be submitted. No modifications should be made in a drawing already approved by the Engineer-in-charge without his prior consent.

Approval of the Contractor's drawing will not relieve the Contractor of any part of his obligation to meet all the requirements of the contract.

1.3 **Guarantee :**

The performance of all the equipment's and the installations should be guaranteed at least for a minimum period of one year from the date of taking over the installation by the Department. All equipments must comply with the relevant IS-BS specifications.

1.4 **Interchangeability:**

All corresponding parts of similar plant and equipment should be interchangeable in every way.

1.5 **Tools:**

All special tools required for dismantling and assembly of the equipment covered by the contract shall be supplied as obligation under the contract.

A list of items to be supplied by the Contractor should be submitted along with the tender.

Specifications for Electrical Installation in Buildings

1 GENERAL :

1.1 These specifications relate to the electrical installations in the buildings of P.W.D. Electrical. The specifications cover general requirements to be fulfilled. These general specifications are supplemented by the specifications for the particular buildings separately attached.

1.2 These specifications are governed by the General conditions of the contract attached hereto.

1.3 APPLICABLE RULES AND REGULATIONS :

1.3.1 Installation shall be carried out in conformity with the regulations for electrical equipments of buildings, published by the institute of Electrical Engineers London (14th Edition 1966 and as amended up to date) hereinafter referred to as the I.E.E. wiring regulations. Where these specifications or the special specifications for the particular building attached hereto are at variance with the I.E.E. regulations these specifications or special specifications as the case may be, shall be followed. The installation shall also comply with the requirements of the Indian Electricity Act. 1910 as amended up to date and rules issued there under and also the regulations for the electrical equipments of buildings issued by the Bombay Regional Council of Engineer Association of India. Where not specified otherwise, the installation should generally follow the Indian standard codes of practice and in their absence the relevant British Standard of practices. All the materials shall comply with the relevant Indian Standard or British Standard specifications.

1.4 DEFINITIONS :

1.4.1 The definitions of terms in the I.E.E. Regulations shall apply in general.

1.5 DRAWINGS:

1.5.1 The preliminary drawings only indicate the general scheme of requirement. The exact position of all points, control switch boxes, runs of wiring and/or conduits joint boxes, inspection boxes, mains, and sub-distribution boards, mains etc., shall be got approved by the Engineer-in-charge. All circuits shall be clearly numbered in wiring diagrams and building plans. The detailed design of a switch-board, special fixture or any other part of the electrical installation as may be called for by the engineer-in-charge shall also be supplied by the Contractor and should be got approved by the Engineer-in-charge. Three sets of completion drawings and wiring diagrams showing the installations as executed shall be supplied by the Contractor along with the completion certificate.

1.6 MATERIALS :

All Materials shall be new and of the best quality conforming to the relevant I.S.B.S. specifications. They must be the products of reliable manufacturers of many years of standings. All like parts of materials shall be interchangeable. In case of equipments such as circuit breakers, switch fuses etc., a descriptive and illustrated literature shall accompany the tender. The names of manufacturers of various materials shall be furnished in proforma in Appendix-I Sample of materials wherever required should be approved by the application of suitable paints. The supply of all equipments, switchgears etc. shall be complete with accessories, fittings and mountings as may be required for their proper performance, and as specified in the relevant IS-BS Code of Practice and Standards.

1.7 WORKMANSHIP :

1.7.1 Good workmanship and neat finished appearance are the prerequisites for complying with the clauses of these specifications. With a view to ensure fine workmanship the tenderers shall employ licensed wiremen with an experience of not less than 5 years in the type of work they are engaged. The work should be done under supervision of licensed Electrical Supervisors with good educational qualifications and considerable experience.

1.7.2 Tenderers shall furnish the names of Supervision and their wiremen who will be engaged in this work with details of their experience.

1.8 CO-OPERATION WITH CIVIL AND OTHER WORKS CONTRACTORS :

1.8.1 The tenderer, after the award of the contract, shall co-operate with the civil and other Contractors and shall co-ordinate his work with the work of other Contractors with the least amount of dislocation and in reference to the other works. Tenderers shall go through the drawings carefully and shall furnish the Engineer-in-charge with all the details of openings in the walls etc. they may be required for concealing any of the electrical equipments or accessories. Where the Contractor fails to furnish such information as may be required for the purpose of concealing the equipments etc., they shall be made at his (Contractor) cost and expense. Any alteration to parts of the building shall be carried out with prior permission of the competent authority. All chases of the structural work shall be made good at the contractor's expense and brought to the original shape finish and colour.

1.9 TESTING :

The electrical Contractor shall be completely responsible for the testing and commissioning of those installations covered by these specifications in compliance with the standard procedure, in obtaining permission of the Government Electrical Inspector. Any modification which is demanded by Government Electrical Inspector shall have to be carried out within the scope of the contract. The contractor shall submit four copies of drawings of installations as per regulations for shall be provided by the Contractor for carrying out the installation work. All tests shall be carried out in the presence of the Engineer-in-charge or his authorized representative and his approval obtained for the test results.

1.10 COMPLETION CERTIFICATE AND MAINTENANCE GUARANTEE :

1.10.1 After the completion of the installation and testing, the Contractor should furnish a certificate in the proforma in Appendix-III, at the time of taking over the installation by the Department. The installation shall be guaranteed for period of 12 months from the date of taking over by the Department. During the period of guarantee all defects in material or in workmanship shall be rectified or replaced free of cost to the Department.

1.11 TENDERER'S ABILITY :

1.11.1 In order to enable the Department to assess the ability of the tenderer to execute the work, the tenderer shall furnish evidence of his experience and capacity to carry out the work of the magnitude and nature.

1.12 RATES :

1.12.1 The rates of items shall include all taxes, transport, loading and unloading charge and all such charges that may be required to be incurred for the supply and installation of the materials at site. The rates shall be firm and variations in the market are not entertained. Break up figures as required in the schedule of work shall also be furnished. As far as possible indigenous materials only shall be included for supply. Where it is unavoidable, imported items may be included and tenderer should clearly indicate materials, quantity, rate and amount of these items.

1.13 STORAGE SPACE :

No covered storage space will be provided by the Department. The Contractor has to make his own arrangement. However, the Department may give an open space near the place of execution where the Contractor can build his own stores for executing the work.

1.14 DEPARTURE FROM SPECIFICATIONS :

The tenderer should clearly indicate departure, if any, from the specifications with reasons for the same.

1.15 EXTRA ITEMS :

Rates for extra items shall generally be derived from the rates already available in the schedule. Where it is not possible, the rates shall be mutually agreed upon and the Contractor shall furnish a detailed analysis of the rates claimed by him.

2. TECHNICAL SPECIFICATIONS :

2.1 Supply System :

The wiring installations shall be suitable for 3 phase 4 wire, 400-400 v 50 cycles system of supply. Colour code of different phase shall be followed as per standard.

2.2 Wiring for Lights and Fans :

2.2.1 Looping system of wiring shall be adopted. No joints shall be made at intermediate runs of cables and where they are unavoidable, such joints shall be through approved mechanical connections.

2.2.2 Point Wiring :

Point wiring shall consist of the branch wiring from the switch board together with the controlling switch or push as far as and including the ceiling rose or any other approved connector or socket, outlets. In case of more than one light being controlled by one switch the wiring upto the ceiling rose of the first light including the switch shall be considered as primary, point, Loop wiring from light shall be considered as a 'Secondary' point and rates shall be quoted separately, including final connections to fixtures and plugs.

2.2.3 Conductors :

No conductor for final sub circuit wiring for light and socket outlets shall have a cross section less than that of 2.5 sq. m (aluminium).

2.2.4 Loading :

No final sub-circuit radiating from the fuse board of a sub-distribution board and wires with 25 sq. m. (At.) cable shall carry more than 10 lights, fans or socket outlets or a connected load of 800 watts whichever is greater. The following wattages may be assumed for estimating the load on each sub-circuit unless otherwise known or specified.

Incandescent Lamps	100	watts
Ceiling fans	60	watts
5-A Socket Outlets (lighting)	100	watts
4. ft. fluorescent tube	50	watts
5. ft. fluorescent tubes	100	watts

In each sub-distribution board at least one way preferably two ways shall be left spare for future requirement. A wiring diagram giving the details of the exact utilization of the ways shall be prepared and fixed in the sub-distribution board itself or any other easily accessible place. The ways of sub-distribution board shall accordingly numbered.

2.2.5 Local Control Switches (General) :

Local control switches for circuit carrying not less than 5-A shall be piano type and shall conform to relevant I.S. Standards. The switch shall be 'ON' when the knob is in the down position. All local control switches shall be connected in the phase or live conductor only and not in the neutral conductor, switch box is 1.3 mtr. from the finished floor level

unless otherwise stated. All switch boxes shall be provided with 1/8" thick Perspex cover fixed to the switch box with chromium plated counter sunk screws (brass).

2.2.5A Switches (Two way) :

- (a) Two way switches shall be piano type single pole, double throw, 250V, suitable for flush mounting and of 5A capacity as per the drawings. All switches shall be recessed in an embedded metal box.
- (b) Each box shall have suitable outlet for fixing conduits directly.
- (c) Each box shall have Perspex cover painted inside with the wall colour, if required.
- (d) Each switch shall be suitable for the position in a corridor stairway wiring.

2.2.5.B Switch Boxes (General) :

Electrical circuits shall be written suitably on the cover of all switch boxes, as approved by the Engineer-in-charge (Elect). Whenever different phase are terminated in a switch box bakelite partition shall be provided. Each case shall be provided with a G. I. Earth stud nut and washers for earth connectors.

2.2.6 Ceiling Rose :

Ceiling rose shall be used on circuits having a voltage normally exceeding 200V. Only one flexible cord shall be attached to a ceiling rose. Only 3-pin 5A socket outlet shall be provided in lighting circuits. All socket outlets shall be provided with control switch and they shall be mounted in switch boxes in an approved manner.

2.2.7 Fittings :

These shall be of approved type as specified in the tender schedule. The sub circuits leads should terminate in a ceiling rose or conductor in the fitting and internal connection made there from. Wherever these fitting are suspended they shall be done so through the conduits and ball and socket joints. All fittings shall be grounded by a G. I. conductor not less than 16 S. W. G.

2.2.8 Flexible wiring :

Flexible cords of not less then 23/0076 size shall be used. The weight of suspension shall be governed by I.E.E. Regulations.

2.2.9 Ceiling Fans :

All ceiling fans shall be wired to ceiling rose and suspended from a hook shackle or clamp and insulated from the same. All joints in the suspension road shall be screwed and secured by means of split pins. The fan clamps supplied by the Contractor shall be suitable for the ceiling or proof member as the case may be. For concrete roofs, fan hooks shall be buried in concrete during construction in an approved manner and securely bound to the reinforcement.

2.2.10 Conduits and Earthing :

All conduits feeding lighting and fan circuits shall be provided with earth continuity G.I. conductor as specified for power wiring. All conduits shall be as specified for power wiring.

2.3.1 Point wiring :

Point wiring for power shall be as defined under section 2.2.2 and shall include the switches and sockets.

2.3.2 Loading :

All distribution board for power wiring shall be not less than 15A per way. Loading per way shall not exceed normally 100 watts. The following loads may be assumed if exact figures are not known :

3-Pin 15A Outlets	1000	Watts
3-Pin 5A	Outlets	100 Watts

2.3.3 Wiring for Motors :

2.3.3.1Final sub-circuits loop in motors shall be connected to separate ways of the Distribution board even if the current in the sub-circuit is less than 15A. No looping is permissible.

2.3.3.2All wiring shall be carried in H. G. conduit as specified in I. S. specification for gauge for different sizes of conduits. When the motor is resiliently mounted flexible conduit with approved adopters shall be used for the last few feet. Where cables are used sufficient loop shall be left.

2.3.3.3All switch fuse units controlling circuits feeding motor shall be provided with H.R.C. fuses or as specified.

2.3.3.4The frame of every motor and its association control gear shall be earthed by two separate and distinct connections to earth. Connector shall be capable of carrying 3 times the rating of fuse or 1.1/2 time the setting of the circuit breakers but in no case less than No. 8 S.W.G. or 7064 or equivalent cross section of copper. Where practicable, the earth connection shall be visible for periodical inspection. Gas or water pipes shall not be used for earth connections.

2.3.3.5 Socket Outlets and Control Switches 5A and 15A :

All socket outlets shall be of 3 pin type, the third pin being connected to the earth stud of nearest distribution board by separate earthing wire. The socket shall conform to I. S. : 1293/1938. single pole, piano type. Each socket outlets shall be provided with a control switch of appropriate rating and as specified. The switch and socket shall be mounted inside the iron clad box provided with 1/8" perspex cover as directed by the Engineer-in-charge or as specified in schedule of quantities. Inside switch box ample space shall be available around switches for connecting wires to switches. All socket outlets for power shall be mounted at the skirting level unless otherwise specified or as directed by the Engineer-in-charge.

The three phase plug receptacles shall have their earth terminals connected by independent earth wires to ring main earth strips on the building. In building where explosion proof fixtures are installed single phase plug receptacles as well as light points shall be connected to ring main ground bus installed in the building by separate earth wires of approved size.

Socket outlet shall have some provision not to receive the matching plug unless the grounding pin is in correct position. The grounding pin of the plug shall make the contact first and break the contact last at the time of inserting or removing the plug respectively.

The grounding terminal shall be connected to the enclosed metal body by providing G.I. stud. nut washers welded to the box

Each unit shall be suitable for flush mounting as required and indicated in the applicable drawings.

Combination unit of socket outlet and switch shall be complete with necessary internal wiring. The switch/socket shall be mounted on M. S. bracket enclosed in a box.

2.4 Conduit Wiring :

2.4.1 Where conduit wiring is adopted the type and size of the conduit shall be as indicated in the drawing. The minimum of the conduit shall be 19 mm.

2.4.2 The Contractor shall thoroughly study the structural arrangements of the buildings and wherever necessary, shall in consultation with Department's representatives at site, make suitable adjustments in the cable routings, earthing arrangements, and location boxes, fitting etc. with a view to avoid interference with any part of the building, structure, equipment or any other work in the building or to effect any improvement in the arrangement.

2.4.3 Protection of conduit against rust :

Conduit shall be given two coats of oxide paint before they are placed in position. All exposed conduit shall be painted after installation with the colour as approved by the Engineer-in-charge. This does not apply to galvanized conduit.

2.4.3.A Protection against insects and damp :

In order to minimize condensation or sweating inside the conduit, system shall be properly drained and ventilated in such a manner as to prevent the entry of insects.

2.4.4 Conduit shall first be installed as a complete system without cables and shall be continuous from outlet to outlet from fitting to fitting and mechanically and electrically connected to all boxes and fittings.

2.5 SPECIFICATION FOR POWER CONTROL AND TELEPHONE CABLES :

1. SCOPE :

- i. The specifications cover the supply and installation of medium voltage power and control cables either in ground or trench depending on the conditions at site including accessories for the same. The work in general, consists of supplying, laying terminating and connecting all. 1.1 KV APLSTS PVC power and control cables.
- ii. The Contractor shall supply all accessories including jointing and terminating materials, compound, tapes supporting materials, cleats cables lugs, concrete stabs, bricks sand, cables markers etc., as required to make the installation work including digging and back filling of the trenches as required.

II. SPECIFICATIONS :

- i. All power cables to be supplied mentioned as 'APLSTS' in the Schedule should be mass impregnated non-draining, paper insulated lead sheathed, double steel tape armoured and must comply with the latest IS BS specifications.
- ii. All cabling materials such as cable compound, cable lugs, tapes shall be of approved quality acceptable to the type recommended by the manufacturer of the cable for which it is used and approved by the Department.
- iii. Installation of all equipment shall also conform to the applicable Codes and practice as per the IS and shall be executed to comply with the latest Indian Electricity rules as regards the safety, earthing of equipments and other essential provision specified therein.
- iv. Only approved make of cable be used. ICC and CCI will be preferred.
- v. The cables shall generally be laid as per IS Code of Practice.

III. GENERAL RULES FOR CABLE LAYING :

- i. Installation shall be carried out in a neat, workmen like manner by skilled experienced and competent workmen in accordance with the standard practices.
- ii. Cables shall be laid preferably in one piece length to avoid joints. If straight joint are found necessary, these can be introduced with prior approval of the Engineer-in-charge. The cost of the straight joint however, shall not be borne by the Department. But in no case joint shall be within the conduit G.I. pipe and duct.
- iii. proper care should be exercised in handling the cable to avoid formation of kink etc. and should it become necessary a cable be bent to a radius not less than 20 times the overall diameter of the cable.
- iv. Method of installation, routing of cable etc., shall in every case be subject to the Department's approval and the Contractor shall modify and or certify at no extra cost to the Department any portions of the installation which do not meet with the Department's approval. All damages to the civil or other works on this account shall be made good by the Contractor at no extra cost to the Department.
The electrical Contractor while notifying the building Contractor for such work shall furnish the proper drawings, fully explaining the work involved or indicate at site actual work to be carried out as may be required by the building Contractor. The electrical Contractor shall also notify the building contractor in wiring, for finishing up as required, of any such work as soon as the electrical work with respect to the same has been completed.
- v. Where cables pass through Hume pipes, Contractor shall fix hard wood bushed round the cables at the ends of Hume pipes. Where the cables pass through the floors or chambers and in such other situations as the Engineer shall require, the Contractor shall seal cable holes in a manner approved by Engineer-in-charge. Where cables pass through roads nallahs, etc., cables must be protected by Class 'A' Hume pipe of diameter not less than 6" (15 cm)
- vi. The cable route shall be the shortest and there shall be minimum interference with built up areas, lawns etc.
- vii. Care shall be exercised for providing suitable props for supporting other service lines on earth at the time of excavation. Where cutting of a lawn become inevitable it should be with the approval of the Engineer-in-charge.
- viii. Excavation of the trenches shall be executed with vertical sides and the trenches shall be kept as straight as possible. The exact location of each trench shall be settled by the Engineer-in-charge on the site when the contractor is in a position to commence each portion of the work.

The trench shall be not less than 1/2 meter wide and 90 cms deep. If more cables are to be laid, the width should be suitably increased.

- ix. After the cables are laid, the trench shall be filled in layers, the earth in each layer being well rammed by spraying water and consolidated and sufficient allowance made for settlement. The extra earth over the trench should be removed from the place of trench to a place as decided by the Engineer-in-charge at site.
- x. Ends of cables shall be properly sealed to prevent entry of moisture prior to installation.
- xi. Where it is as specified as 1/2 core in multicore cables, the 1/2 core shall be a neutral conductor having reduced section.
- xii. For all multicore cables each core and tails shall be brought out, marked and or coloured in an approved manner.
- xiii. Cables termination shall be done with suitable compression brass glands in the case of PVC cables and cast iron trifurcating boxes in the case APLSTS cables. The armour should be connected to the right main earth in building with duplicate earth wires as per the relevant IS/BS specifications.
The core isolation over each conductor shall however be retained throughout the run of the conductor up to the end where lugs shall be fitted thereon for connections. The lugs shall be fitted by means of approved solder and flux as a leap, and Eyre No. 7 liberally used.
The joint shall be mechanically strong and pressure tested.

2.6 DISTRIBUTION BOARDS AND PANELS :

General Requirements :

- 2.6.1 All distribution panels shall comply with I.E.E. Rules 60-61. A clear distance of 0.91b meter in front of the switch board shall be kept. Where bare connections or attachments are provided at the back of the switch board the space behind the panel shall be either less than 0.299 meter or more than 0.762 main width. There shall be a passage way from the furthers outstanding part of any attachment or conductor. If the space behind the switch board exceeds 0.76 main width there shall be a passage way from either end of the switch board clear to height of 1.928 m width 0.299 m. All wiring connection shall be made neatly and securely.
- 2.6.2 For circuits carrying more than 10 Amps. tinned cable sockets shall be used. All connections shall be so made as to form their own diagram. Circuit shall be clearly numbered to correspond to wiring diagram. Names of the distribution boards shall be painted as directed by the Engineer-in-charge. All the switch fuse units and isolators D.Bs. shall be complete with earthing lugs neutral bar link. H.R.C. fuses and of approved make.
- 2.6.3 Skeleton type panels shall have rigid framework adequately braced and supported. The switch and distribution boards shall be neatly arranged in the frame. The details of the framework and the arrangement of switches shall be got approved by the Engineer-in-charge before the panel is fabricated.
- 2.6.4 All cubical type panels shall have rigid supporting frames adequately braced over which sheet metal shall be neatly secured. All switches, distribution boards etc. shall be neatly arranged on the panels and all connections made from the back of switches. The panels shall be rendered dust and vermin-proof. The interior of the panels shall not be accessible to unauthorized persons.
- 2.6.5 The recess type boards shall be embedded in wall in a cupboard with a metal hinged door with locking arrangement. In all recessed conduit work in distribution boards shall be recessed. Where recessing is not possible, free standing panel may be provided as approved by the Engineer-in-charge.
- 2.6.6 All individual components i.e. switch fuse units D. Bs. etc. shall be connected by earth continuity wire of appropriate size with the main earth bus of the panel D. B. etc. The panel switches or D.Bs. shall be earthed by not less than 2 distinctive paths to earth. Earthing of metallic parts of exposed metal shall not be effected through any structural metal work which houses the installation. Where metallic parts are not required to be earthed and are liable to become alive should the installation of the contractor become defective such metallic parts shall be separated by durable non-conducting material from any structural work.
 - (a) power panels shall be 3 phase, 4 wire, 400/230 volts for the distribution of 3 phase or single phase power loads. Lighting panels shall be 3 phase, 4 wire 400 230 volts for single phase lighting load distribution on all 3 phase.
 - (b) All panels shall be done or protected front type with no mechanical or electrical defects.
 - (c) Bus bars shall be of electrolytic copper or aluminium as specified and the properly tinned sizes as indicated on applicable drawings as required.
 - (d) All knockouts for branch circuits, conduit entries shall be drilled in and files as required. For lighting panels the top and bottom cover plates shall be removable type.
 - (e) Main disconnects device for all panel boards shall be of switches of disconnect type and of the size as indicated. It shall be mounted directly below the panel or through a short thread conduit of required size.
 - (f) The main disconnect for all panel boards shall have an entry suitable for PVC armoured cable from bottom.
 - (g) All panel boards shall be provided with an earthing terminal and plug for connection to the grounding system.
 - (h) Temperature rise of all electrical parts shall not be more than 300⁰ C with full load measured at room temperature.
 - (i) Buses shall be securely supported so that ordinary vibrations will not cause any of the parts to become loose.
 - (j) All barriers and supports of current carrying parts shall be of moisture resistant insulating material and shall not be adversely affected by arcing.

- (k) The locations of panels shown in the drawings are only tentative. Panels may be located at place approved by the Engineer-in-charge.
- (l) All civil works connected with fixing such as grouting chasing and making good shall be the tenderer's responsibility.
- (m) Wires adequate capacity with proper size of lugs shall be used for interconnections.
- (n) Panel should be self-supported on angle channel iron framework. It should be preferably of bolted construction in case of transportation and flexibility. The frame shall be of the required size for the mounting of the equipment on it. It shall be bolted or grouted rigidly after levelling and alignment.
- (o) The cupboard and D. B. should be of such size so as to be accommodated in the existing room as per I. S. rules and I. S. codes of practice for installations of medium voltage switchgear.
- (p) Fabrication drawing showing the detailed dimensions and panels and its components indicating the frame work earthing positioning of switches, D. Bs. cable boxes, adopter chambers etc. shall be furnished to the Engineer-in-charge. Panel should be guaranteed for satisfactory operations for a period of one year after handing over.
- (q) The panel should be painted with anticorrosive paint suitable for humid and salty atmosphere on two coats of primer.

Switch Gears, Powers Panels D. B. and S. F. Us.

2.6.8 The main bus bar shall have continuous current rating as specified with neutral bar having half of full load rating of the phase bus bar. The sizes of the bus bars shall be so selected that the current density in bar does not exceed 150 amps. per sq.mm. for copper. The length of bus-bar chamber should be as suitable length to fix all the switches etc. as per prevailing standards. Clear spacing of two adjacent buses shall be 1.1/2" Minimum bar should be taped all along with colour coated 11 KV grade PVC tape. The maximum internal support for each unsupported length shall exceed 600 mm. The bus bar shall be of copper/aluminium and fabricated to the relevant standards specification. In case aluminium bus bar is used special with high conductivity aluminium bus bar alloy E 91 C frame conforming to E. S. S. 2898 shall be used. The current density shall not exceed 800A per sq. inch. Hylam barriers will be provided over the joints to prevent any short circuit.

The bus bar enclosing shall be made out of not less than 16 gauge M. S. sheets construct on with angle iron support. All interconnections between bus bars S. F. Us. and D. Bs. shall be of adequate size and details of such interconnection shall be furnished to the Engineer-in-charge for his approval.

The bus bar shall be air insulated extensible type rectangular one. The bus bars chamber shall be dust tight by providing gaskets secured properly so as to tender it vermin proof.

The Combination Fuse-switch unit should comply with IS 4064 BS 861 and BBS 2510 wherever applicable. It should be suitable to accommodate High Reputing Capacity Cartridge Fuse links complying with IS 2208 or BS 88 and having certified returning capacity of not less than 35 MVA at 440 volts (AC5 duly). The switch gear (panels D. Bs. etc.) shall be installed generally as per IS-Part I 3072 and as specified and shown in drawings.

All fuse switch units shall be provided with non-deteriorating HRC fuse links complying with IS 2208-1962 and having rupturing capacity of 35 MVA at 415 volts or as specified.

All switches above 60 amps. rating shall be provided with suitable size adapter boxes. All switches mounted on the top of the busbars shall be provided with detachable type reverse entry adapter boxes. Suitably engraved lables shall be provided for each circuit as well as for the board.

A meter with sector switches and LMH metre shall be provided where specifically mentioned. Small wiring for the inter-connecting shall be colour coded and provided with numbered figures for easy identification of circuits.

- (a) The distribution boards should be totally enclosed metal clad complying with B. S. 214. The M. S. sheet steel enclosures for recessed D. Bs. shall be of not less than 14 gauge.
- (b) The D. B. shall be with hinged door and the locking arrangements as approved by the Engineer-in-charge.
- (c) All the components shall be enclosed in the enclosure. The mounting of D. B. shall be got approved by the Engineer-in-charge before carrying out the installation.
- (d) The D. Bs. shall have proper size cut outs for conduits entry or cable entry or cable entry as required and these shall be made on site.
- (e) Adequate spacing shall be provided inside the D. Bs. for easy removal of the fuses and carry out the interconnection.
- (f) A set of insulating barriers have to be provided between incoming breakers switches and fuses.

Switch fuse Units :

- (a) All the D.P.T.P. and T.P.N. switch fuse units shall be totally enclosed iton clad quick make, quick dreak type to best Indian make conforming to the I.S. or B.S. 3185 specifications. All the switch fuse units shall have mechanical interlock with a door so that the door cannot be opened when the switches are in 'ON' position. The switches should be of double break isolation type to ensure safely.
- (b) Each T.P. & T.P.N. switch fuse unit shall be earthed with two distinct earth connections.
- (c) Suitable insulator shall be provided between phase.
- (d) There shall be suitable natural link in the fuse box.

- (e) All T. P. & T.P.N. switch fuse units shall be rated for 500 volts and D.P. (required for single phase supply) and S.P.N. switches for 250-volts.
- (f) The H.R.C. cartridge fuse shall conform to H. S. 88 (1952).
The O.C. Bs. ACB shall be suitable for 400/440 volts 3 phase 50 cycle supply capable of interrupting a fault MVA. of not less than 31. The circuit breaker shall conform to the BSS-936-1940 BSS 3659 with such tripping arrangements as may as required under special specifications for the building. Efficient and fool-proof mechanical interlocking shall be provided for the safe operation and maintenance. The rate shall be inclusive of the first filling of oil.

2.7 Instrumentation :

The instruments and meters wherever shall be housed in special sheet steel box located between switch fuses units and bus bar chambers. The instruments etc. shall be mounted on the hinged cover with their dial flushed. All instruments shall have protective H. R. C. fuse links. All interconnections and small wiring shall be neatly dressed arranged and duly coloured for easy identification of circuits.

Meters shall be provided as required in the Schedule. Meters shall be dead head and be suitable for 400/440 volt 3 phase 4 wire 50 cycles (in balanced load) supply.

Each selector switch shall be 3 point and of minimum 250 volts grade with silver tippe contacts suitable for metering circuits. Current transformer shall be of 5VA burden and 250V grade. Every unit shall be prewired and interconnected to the system for its required indicating performance. Indicating Lamps shall have independent circuit fuse.

2.8 FIXING OF LIGHTING FIXTURES :

1. Location of fixtures their manner of fixing mounting height etc. indicated in relevant drawing. Actual location and levels shall however be arrived at site in co-ordination with other services etc. and prior approval of the Engineer-on-charge regarding the actual location, manner of fixing shall be obtained before the work is taken up in hand.
2. In all cases the Contractor shall provide necessary interconnection wiring earthing painting etc. all necessary for complete installation. The Contractor shall also test and commission the fixtures during completion of the work.
3. General arrangement of fixtures layout ins indicated in drawings. Care shall be taken to see that all light fixtures are in a row in a room or particular area, are in absolute line and plump and are symmetrically disposed with respect to finished surfaces of walls columns beams etc.
4. The inter-connections wiring from the light outlet point up to the fixture shall be carried out by means of flexible copper wire of section not less than 1.5 mm².
5. All fixtures suspended by means of conduits shall be done with all and socket joints or as per approved design.

2.9 Telephone System :

1. Empty conducting shall be done, reseed or exposed to surface along with pull boxes, junction boxes and telephone outlet boxes, in areas and location as indicated in the relevant drawing as per materials and methods as described in regard to conducting under section "Wiring in Conduits" except the G. I. pull wires of gauge not less than 20 SWG shall be kept pulled through conduits in all sections so that in future telephone wires can be pulled easily.
2. Location shown on the drawing are approximate and final location shall be decided in the field by the Engineer-in-charge.

SECTION - G SPECIFICATION FOR EARTHING

1. Installation of Earthing Plates :

All installation of earthing shall conform to Indian Electricity Rules, IS-3043 latest edition and I.E.E. The copper earth plates should be tinned before installation. The earth plates of copper 60 cm x 60 cm x 3.515 mm thick size as mentioned in the schedule should be in separate pits at least 150 cms to 300 cms. away from the building at a depth necessary to reach moist earth surface but with a minimum depth of 2.5 mtr from the finished ground level up to the top vertical dodge of earth electrode. The earth plate shall be thoroughly cleaned to remove all dirt from the surface and be tinned properly for electrical contact with the main ground. Each earth pit should be provided with 38 mm. dia. G.I. pipe 2.5 Mts. long or more depending upon the depth of pit over the vertical edge of earth plate (with top end of pipe provided with a closed to coupler). Alternative layers of salt and coke shall be provided surrounding the plate. The pits shall be filled when the plates are in position and with type approval of Engineer-in-charge.

To facilitate watering the pit, a concrete compartment should be made with funnel with mesh and cover plate as per rules provided in ISI regulations. The masonry enclosures shall be 25 cm x 25 cm (deep) with C. I. lid of 23 cm x 30 cm size. After installation, the earthing resistance of each earth plate should be measured by resistance meggar in the presence of Engineer-in-charge, three days after the completion of earthing work, and the value should conform to regulations.

Signature of
The Contractor

Signature of
EXECUTIVE ENGINEER
BUILDING DEPARTMENT
BHAVNAGAR MUNICIPAL CORPORATION
BHAVNAGAR

LIST OF APPROVED ELECTRICAL PRODUCTS

Sr. No.	Item	Make
1	P.V.C. Pipe and it's accessories	Vraj, Nihar, Precision
2	P.V.C. Wire	Finolex, R.R., Havells
3	Cables	Polycab, Avocab, RR cable
4	Switch & it's accessories	M.D.S., NW, MK "ivory", Opel
5	MCB & Switch Gear	L&T, Schneider, Seimens
6	TL Fixtures	Crompton, Bajaj, Havells
7	Ceilling Fan "Power Saver"	Crompton, Bajaj, Havells, Orient, Usha
8	Ex. Fan	Crompton, Bajaj, Havells
9	Cable Gland	HMI, Cable Grip
10	Lugs	Dowells
11	Data / Communication Cable	Finolex, R.R., Digilink
12	D.B's	L&T, Schneider, M,D.S.
13	L.E.D/C.F.L	Havells, Crompton, Bajaj, Philips

**EXECUTIVE ENGINEER
BUILDING DEPARTMENT
BHAVNAGAR MUNICIPAL CORPORATION
BHAVNAGAR**

**PROPOSED DEVELOPMENT OF FIRE STATION AND FIRE STAFF
QUARTERS , AT PRABHUDAS TALAV,
FOR
BHAVNAGAR MUNICIPAL CORPORATION,
BHAVANAGAR.**

.

**SECTION- V
LIST OF APPROVED MATERIALS**

**ARCHITECTS:
DEV DUTT PANDYA & ASSOCIATES
ARCHITECTS AND INTERIOR DESIGNERS
DM-10 BINDU NIWAS, KALVIBID,
BHAVNAGAR- 364002
PHONE: (0278) 2569070,2569080.**

**MUNICIPAL CORPORATION
BHAVNAGAR**

VENDOR LIST

(A) LIST OF APPROVED VENDORS FOR CIVIL WORKS

Sr. No.	ITEMS	Approved Brands / Quality
1	CEMENT PPC 53 Grade & SULPHATE RESISTANT CEMENT,S.R.C.	Ambuja, Hathi, Ultra Tech, Sanghi, Siddhi, Hi-bond
2	BRICKS	MBM, Arjun, PBM, 555, Kisan, ABM, TRD, Paresh, Dhara, B.R.C., Kiran, BMB, Kirit, Sonal
3	Steel TMT, CRS	TISCO, SAIL, VIZAG, Kamdhenu, NATIONAL, Electrotherm, JSW, Welspun steel, Pollad Steel, DIAMOUND TMT, M. G. Steel, Friends Steel, Crown next TMT, Briskon TMT
4	VITRIFIED TILES	Asian, Kajaria, Jonson, Varmora, Simpolo, OASIS
5	CERAMIC TILES	Asian, Kajaria, Johnson, Varmora, Simpolo, OASIS
6	GLAZED TILES	Asian, Kajaria, Johnson, Varmora, Simpolo
7	ACRYLIC PAINT	ICI, Asian, Nerolac, Burger
8	OIL BOUND DISTEMPER	ICI, Asian, Nerolac, Burger
9	EXTERIOR WEATHER PROOF EMULSION PAINT	ICI, Asian, Nerolac, Burger
10	Oil Paint	ICI, Asian, Nerolac, Burger
11	SANITARY WARE	Cera, Hindware, Parryware
12	CAST IRON PIPES AND FITTINGS.	NECO, Swayarhoo, Bengal, Oriental Castings, Electro steel Castings
13	P.V.C. PIPES AND FITTING (UPVC/CPVC)	Finolex, Supreme, Jain, Kisan, Astral, Dutron, Prince
14	CHROMIUM PLATED WATER SUPPLY FITTINGS	Jaquar, Ess Ess, Plumber ,ESSCO, Crown, Metro, Prince
15	GALVANIZED PIPE	Tata, Essco, Jaquar, Ess Ess, Plumber
16	GALVANIZED FITTINGS	'R' Brand, 'RV' Brand, Kranti
17	C.I. MANHOLE COVER	Manish, Sil, NECO
18	PLUMBING FIXTURES	Jaguar, Plumber, Essco
19	PVC WATER TANK (100% VIRGIN PVC)	SIntex, Aqua
20	ALUMINIUM SHEETS AND ACCESSORIES	Nalco, Jindal, Hindalco, Banko
21	ALUMINIUM EXTRUDED DOOR/ WINDOW SECTION	Jindal, Hindalco, Banko, Ajin India, Aldowin, Alumilite
22	ALUMINIUM HARDWARE	Rajdoot, Belu, Diamond, Glider, Ajin India, Aldowin, Alumilite
23	WATER PROOFING MATERIALS	Zycosil, Dr. Fixit, Kerakoll, Pidilite, Roff
24	DOOR CLOSER	Efficient Gadget, Everite, Hardwin, Aldowin, Ozone
25	DOOR FITTINGS	Godrej, Efficient Gadgets (E.G.) Dunex, Doorset, Suzu, Coral
26	HINGES	Suzu, Yama, E.P.P.W.
27	SCREW AND BOLTS	Nettle Folds, GKW, Stud
28	BOLTS & FASTENERS	Hilti, Fisher
29	LIFT	Top, Express, Omega, OTIS, Schander, TRIO, Aegis Elevator, Mitsubishi, Aditya, Siemens slider
30	ROOFING MATERIAL – Galvalume sheets	TATA, Essar, Jindal
31	Slag Cement	SANGHI CEMENT Sanghipuram

Sr. No.	ITEMS	Approved Brands / Quality
32	CPVC PIPES FOR AUTOMATIC SPRINKLER FIRE EXTINGUISHING SYSTEM	ASTRAL POLY TECHNIK LIMITED પાકિંગ એરિયા, બેઈઝમેન્ટ એરિયા જેવા વિસ્તારો સિવાય માત્ર કન્સીલ્ડ પાર્શીય માટે આ કંપનીના CPVC pipe નો ઉપયોગ fire sprinkler piping માટે કરવાની મંજૂરી આપવામાં આવે છે.
33	AAC Blocks	NXTBLOC
34	Jointing Mortar	NXTFIX Block
35	Ready Mix Plaster	NXTPLAST
36	Block joining Masonry Mortar	Unifix
37	Tile adhesive	Unifix
38	RCC bench	Sardar Pre cast
39	Rubber mould garden curbin	Sardar Pre cast
40	Rubber mould Paver block	Sardar Pre cast
41	Fencing Pole	Sardar Pre cast
42	RCC Masonry block	Sardar Pre cast
43	Pre cast wall	Sardar Pre cast

(B) LIST OF APPROVED VENDORS FOR MECHANICAL & ELECTRICAL WORKS

Sr. No.	Description	Name of Manufacturer
1	HSCF Pump	Crompton Greaves Ltd
		Kirloskar Brothers Limited (KBL)
		JASCO
		Mather & Platt Pumps Ltd.
		Jyoti Ltd.
2	Electric Motor	Lubi Industries LLP
		Bharat Bijlee Ltd.
		Jyoti Ltd.
		JSL Industries Ltd.
		Jeumont Electrical India Pvt. Ltd.
3	Electrical Panel	LHP
		Crompton Greaves Ltd
		Bhagyashree Power Control
		Dynamic Control System
		Elembica Services
		JSL Industries Ltd.
4	Kinetic Air Valve	Nutral Power Tech
		Kirloskar Brothers Limited (KBL)
		FOURESS Engineering (India) Limited.
		Durga Valves Pvt.Ltd
		Orbinox
5	Expansion Bellows	શ્રી કિશોર ઇન્જિનીયરિંગ
		Precise Engineers
6	Dewatering (Drain) Pump(Submersible/Horizontal)	KSB Pumps
		Kirloskar Brothers Limited (KBL)
		JASCO
		Crompton Greaves Ltd
		La Gajjar Machinery Pvt Ltd.
		Pullen Pumps Industries Pvt. Ltd.
7	Sluice Valves and Sluice Gate	MBH
		Kirloskar Brothers Limited (KBL)
		DURGA Valves Pvt.Ltd
		L & T Valves
		Jupiter
8	UPVC Pipe	SACHDEVA
		Supreme Industries Ltd.,Mumbai
		Dutron Polymers Ltd
		Parixit Industries Ltd., A'bad
9	HDPE Pipe	Jain Irrigation Systems Ltd., Jalgaon
		Parixit Industries Ltd., A'bad
		Jain Irrigation Systems Ltd., Jalgaon
		Dutron Polymers Ltd
		Jindal
10	C.I. Pipe	Essar Steel
		Electro Steel, Kejriwal, Oriental Castings, BIC, Jindal, Lanco Industries Ltd.,Chennai, Kesins
13	EOT Crane	Grip Engineering Pvt. Ltd., JAPS Project, Brady & Morris Engineering Co. Ltd., Techno Industries
14	Cable & Wires	KEI Industries Ltd.
		Polycab Wires Pvt. Ltd.
		Aerolex Cables Pvt. Ltd.
		Allwin Industries
		Finolex Cables
		L&T Cables
		ULTRA CAB (India) Limited
15	Transformer	Atlanta Electricals Pvt. Ltd.
		Powerlite Electricals

Sr. No.	Description	Name of Manufacturer
		Voltamp Transformers Ltd. SKP Transformers Arya Electronics
16	Components for MCC :	
	Switch	L&T, Siemens
	HRC Fuse	L&T, Siemens
	Timer	L&T, Siemens
	Relay	L&T, Siemens
	Push Button Stations	L&T, Siemens
	Indicating Lamp	L&T, Siemens
	Cable Jointing Kit	CCI, M. Seal
	MCB/DB's	MDS, Siemens, Indokupp
17	Capacitors	L&T, Crompton, Khatau Note: Capacitors shall be oil fill type
18	KWH Meter	Simco, Jaipur, GEC
19	Light Fittings: (Indoor & Outdoor Luminaries)	Philips, Crompton, Bajaj, NESSA Illumination
20	Exhaust Fans	Crompton, Bajaj,
21	Ceiling Fans	Crompton, Bajaj, Havells
22	Air Blowers	Everest Ltd. Swan Pneumatics (P) Ltd
23	Alum Dosing Pumps	Asia LMI VK Pumps Swelore
24	Pressure Gauges	General Instruments Bells Control H. Guru Marketing
25	Level Gauge / Indicator	R K Dutt Levecon S. B. Electromec
26	Clarifier Equipment	Enviro Control Associates Voltas Ltd Hindustan Dorr-Oliver Geomiller/Triveni
27	Chlorination System	Industrial Device (I) Pvt. Ltd Metito Chloroequip Pennwalt
28	Gear Box	Greaves Radicon Elecon Shanti
29	Level Switches	Level-Tech Revathi Electronics Levec
30	Refrigerator	LG, Samsung, Kelvinator
31	PVC Pipes for Fluid	Finolex, Jain Irrigation
32	PVC Conduits for Electricals	Precision, Shakti
33	Butterfly Valve	KIRLOSKAR Brothers Limited(KBL), DURGA valves Pvt Ltd, L & T valves, R&D MULTIPLE, Jupiter, श्री कृष्ण इन्वेंटरिज IVC, IVI, Audco, R & D multiple, Jupiter, Cair, Orbit Engineers
34	Check Valve (Dual Plate check Valve)	KIRLOSKAR Brothers Limited(KBL), DURGA valves Pvt Ltd, Orbinox, R&D MULTIPLE, Orbit Engineers
35	Metallic Expansion Bellow	Beloflex(B.D. Engineers), Stanfab Engineering Pvt. Ltd., D. Wren Engineering Pvt. Ltd., Sur Industries,
36	Centrifugal / Centrifugal Non Clog Pumps	Beacon Weir, KSB, Mather & Platt (Wilo), Worthington, WPIL, Xylem pumps , Grundfos Pumps Pvt. Ltd., MBH, JASCO
37	Submersible non Clog Pumps / Submersible Centrifugal Pumps	Kirlosker, KSB, ABS, ITT- Flyght, Xylem pumps, Grundfos Pumps Pvt. Ltd. , MBH, JASCO, AQUA, Jyoti, PULLEN PUMPS, Alpha, Het Pump

Sr. No.	Description	Name of Manufacturer
38	Screw Pump	Roto, Netzsch, Tushaco, Seepex
39	Metering / Dosing Pumps	Swellore, V.K. Pumps, Shapotools
40	Non Return Valves (Single / multi door) / Dual Plate Check Valves	Kirlosker, IVC, IVI, R & D multiple, Durga, Jupiter, Cair, Orbit Engineers
41	Knife Gate valves	Jash, Fouess, Vass (Dezurick), Vag, Orbinox, Orbit Engineers
42	Sluice gates / open Chanel Gates	Jash Engineering, IVC, R & D Multiple, Jupiter
43	Mechanical Fine Screens – Step (Mat) Type / Drum Type	Jash, Huber, Johnson, Savi, Italy, Apollo Screens
44	Mechanical Course bar Screen	Jash, Huber, Johnson, HDO, Triveni, Savi, Italy
45	Manual Bar Screen	Jash, Japs, HDO, Triveni, Auric
46	Grit mechanism	EIMCO – KCP, Hindustan Dorr – Oliver, Jash-Shivpad, Triveni, Voltas
47	Diffused Aeration System	EDI, OTT, Rehau
48	Air Blower	Kay, Swam, Everest, Usha Compressors, Gardner Denver
49	Agitator / mixer	Remi, Schurtek, Fibre & Fibre, Milton Roy
50	Gear Boxes	Greaves, Elecon, CPEC, PEPL, Bonfiglioli
51	Centrifuge	Humboldt, Alpha Laval, Hiller
52	HDPE Pipes	Astral, Dutron, Duraline, Narmada, RIL (PIL), Penwalt, Anjney, jain irrigation, Sangir
53	Air Compressor	Ingersoll – Rand, khosla, Kirlosker, CPE, Alpha
54	Bearing For All Equipments	SKF, FAG, Tata
55	Fasteners	Precision, Durakhanawala, Echjay, Tata, Sundaram
56	Mechanical Seals	Eagle Seals (Sealol), Durametallc, Burgman
57	Electric Actuator	Auma ,Rotork, Emerson, Pentair
58	(1) CATEGORY III Indoor LED fittings, LED Panel light, LED down light, outdoor LED ligh (street light, LED flood light, LED Post top lantern, LED bollard) (2) Solar LED Light	NESSA ILLUMINATION TECHNOLOGIES PVT.LTD., Litsun, Nextray
59	STREET LIGHT POLES	AMBICA POLES (for octogonal poles,swage poles,street loght poles, high mast poles,decorative poles, conical poles, JETCOTECH Engineering LLP
60	Resilient Seated Slice Valve	Cair
61	Air Vale	Cair, Orbit Engineers
62	Flow Control valve	Cair
63	Altitude Control valve	Cair, Orbit Engineers
64	Pressure reducing valve	Orbit Engineers
65	Pressure relief valve	Orbit Engineers
66	Ball valve	Orbit Engineers
67	Mast pole	JETCOTECH Engineering LLP
68	Earthing material	JETCOTECH Engineering LLP
69	Hot dip galvanizing	JETCOTECH Engineering LLP
70	LED Highbay	Litsun

(C) LIST OF APPROVED VENDOR FOR INSTRUMENTATION SYSTEM

SR NO	DESCRIPTION	Name Of Manufacturer
1	Electromagnetic Flow Meter	E+H, Siemens, Abb, Fuji, Yokogawa, Krohne-Marshall, AAROHI Embedded System Pvt Ltd., Emerson, SBEM
2	Pressure Gauges	Wika, H.Guru, General Instruments Consortium Manometer (India) P. Ltd. , Baumer, Waaree
3	Pressure Switch	Danfoss , Indfoss , Switzer
4	Process Analyzers (pH, DO, Free / Residual Chlorine , BOD / COD)	E+H , Emerson , Hach , Chemitech , Polymetron, Wtw (Forbes Marshall),Yokogawa
5	Ultrasonic transmitter level / diff. level / flow	E+H, Siemens – Milltronics, Krohne, Vega
6	Hydraulic level transmitter	E+H,Siemens, ABB, Forbes- Marshall, Emerson, SBEM
7	Displacer/Float Switches	Levcon, Nivo, Toshbro, Pune Techtrol , SBEM
8	PP Float / Buoyancy switch	Pepprl + Fuchs, Baumer, Waaree, E+H , Pune Techtrol , SBEM
9	Float & Board Type Level Gauge	Levcon, Nivo, Toshbro, Pune Techtrol, SBEM
10	Electromagnetic Flow Meter	E+H, Siemens, ABB, Fuji, Yokogawa, Krohne-Marshall
11	Field Transmitter (P, DP,F, L , T)	ABB, Fuji, Yokogawa, Honeywell, Emerson
12	Pressure Gauges	Wika, H.Guru, General Instruments Consortium Manometer (India) P. Ltd., Baumer, Waaree
13	Panel Mounted Process Indicator & Flow Integrator	Masibus, Nishko, Nivam, Selectron, Radix, Yokogawa, ABB
14	Pressure Switch	Danfoss, Indfoss, Switzer
15	Programmable Logic Controllers	Rockwell (Allen Bradeley), Siemens, Schneider, Fuji, ABB, GE Fanuc
16	Control Panel Enclosure	Rittal, Enklotek, Bartakke, BCH, Eldon
17	Alarm Annunciator	Aplab Ltd., Minilec , IIC
18	Solenoid valves	Asco, Rotex, Schrader
19	Tube Fitting	Excel Hydropneumatic, Multimetal, Placka
20	Instrument Valves , Manifolds	Aptek, Anmol (Superlok), Excel Hydropneumatic, General
21	Fitting	Instrument Consortium , Multimetal, Technomatic, Placka
22	Pneum , Brass Fitting	Swagelok, Multimetal Industries, SMC, Festo
23	Control Panel Accessories / Components	
a.	Miniature Relay	Wago, Omron,Phoenix, Rockwell
b.	Indication Pilot Lamps (LED Type)	Teknic, Schneider, Siemens
c.	Push Button / Selector Switch (with NO/NC Elements)	Teknic, Schneider, Siemens
d.	DC Power Supplies (DIN Rail mounted)	Phoenix, Omron, Schneider, Rockwell
e.	Terminals	Elmex, Phoenix, Wago, Connectwell
f.	Panel Wires	Finolex , Havell's , R R Kabel
g.	Panel Illumination	Philips , Crompton , GE
24	Instrument Cables (Power , Signal , Control)	Associated Cables, Associated Flexible and Wires P.Ltd., Brooks Cables, Thermo Cables, Udey Pyro
25	Cable Glands	Ex- protecta, Braco, Sudhir, Comet, Connectwell
26	Junction Box	Ex- protecta, CEAG, Sudhir, Baliga, FCG

27	Cable Tray	M.M.Engineering, Globe, Jacinth, Equi. Reputed, JETCOTECH Engineering LLP
28	Computer System	HP-Compaq, Dell, IBM, Sony, Samsung
29	UPS	Hirel-Hitachi, Emerson, APC
30	<ol style="list-style-type: none">1. PLC (Programmable Logic Controller)2. SCADA (Supervisory Control and Data acquisition)3. VFD (Variable Frequency Drive Up to 500 KW)4. ACB (Air Circuit Breaker up to 6000A)5. MCCB (Moulded Case Circuit Breaker up to – 1600 A)6. MCB (Miniature Circuit Breaker up to – 63 A)7. ELCB (Earth Leakage Moulded Case Circuit Breaker up to 1600 A)8. Contractor up to – 800 A & OLR (Over load Relay) up to 630 A9. Multi Functional Meters10. MPCB (Motor Protection Circuit Breaker up to 32 A)	MITSUBISHI ELECTRIC INDIA PRIVATE LIMITED, Emerald House, EL-3, J Block, M.I.D.C., Bhosari, Pune 411026

**(D) LIST OF APPROVED VENDORS FOR MATERIALS RELATED TO WATER
SUPPLY AND SEWERAGE NETWORK**

SR. NO.	ITEMS	NAME OF AGENCIES
1	A C Pressure pipe - 293 - MAZZA process	Lotus, Kirti
2	A C Pressure pipe MEGHNANI process	Lotus, Kirti, Hindustan
3	Sluice Valve	Durga, kartar, Kirloskar, Jupiter, SACHDEVA (C.I. & D.I.), શ્રી કિર્તી ઇન્જીનિયરિંગ, Cair, Orbit Engineers
4	DI Pipe	Electrotherm (I) Ltd.,Ahmedabad, Lanco Industries Ltd.,Chennai, Electrsteel, Jindal Saw Ltd.,Ahmedabad, Kesins, Welspun
5	R.C.C. PIPE (COLLAR JOINT & SOCKET SPIGOT JOINT) CLASS NP3 & NP4, & R.C.C. COLLARS	VIPUL SPUN PIPES (SIHOR & LATHIDAD,BOTAD), KATARIYA & CO. (DHASSA), OMKARESHVAR PIPES (NAVAGAAM), OMKAR PIPES (LATHIDAD, BOTAD), MARUTI PIPES (BAGODARA ,AHMEDABAD), KALATHIYA PIPES(BAGODARA ,AHMEDABAD), R. S. PIPES (BODELI), UMA HUME PIPES (KALOL, GANDHINAGAR), SIDHDHIVINAYAK (KARDEJ ,BHAVNAGAR)
6	R.C.C. MACHINEOLE FRAME & COVER, INLET FRAME COVER 10T.(600*450 MM.) , 20T.,35T., & 50T.	SONI CEMENT PRODUCT , VIPUL SPUN PIPES, KATARIYA & CO., OMKARESHVAR PIPES, OMKAR PIPES, MARUTI PIPES, KALATHIYA PIPES , R. S. PIPES, UMA HUME PIPES, SIDHDHIVINAYAK , S.K. Corporation, Laxmi Price Industries, S.J.Corporation, Sardar pre cast
7	Stone ware PipeManufacturer having BIS Certificate for ISI marking	Krishna Pipe, j.K. Pipe, Taya ceramic, Burn & co., perfect Potteries, Navroji Vakil, Kashmira
8	D.I. & C.I. FITTINGS	RG BRAND, ESSEM Engineering Industries, Bikaners Engineers works
9	CID Joints	ESSEM Engineering Industries
10	Valves & Graded Castings	ESSEM Engineering Industries
11	Pipe Fittings	ESSEM Engineering Industries,

Whenever the make of any item / component used in the construction of this project is not mentioned anywhere, the contractor shall get the same duly approved from the Architect / Employer/Executive Engineer Building Department, Bhavnagar Municipal Corporation prior its use / installation.

For any kind of material

Note:

- (A) **Before starting of work contractor must get all samples/make approved from Architect/EIC before using at site.**
- (B) **Consultants/EIC reserve the right to add or delete name of any manufacture as and when required.**
- (C) Consultants/EIC reserve rights to select any of the specified brands mentioned above.
- (D) In the case of discrepancy between descriptions of Bill of Quantities and / or the drawing, "Drawing" of preference shall be observed. All and above AUTHORITY/ AUTHORITY'S Architect/EIC decision shall be final.
- (E) All the works shall be executed in technically correct and in good workmanship like manner.
- (F) **All the works shall be strictly executed in the manner as advised By The Architect/EIC OF BHAVNAGAR MUNICIPAL CORPORATION.**

SIGNATURE OF CONTRACTOR with seal

SPECIAL NOTES :

- The successful tenderer will have to supply the makes from above in consultation with the Client/Architect/Consultant/Engineer in charge without any extra cost.
- Tenderer should have to specify the list of makes considered in the tender while quoting the rates in the tender, in covering letter of separate letter enclosure. However, the final decision for accepting make specified by tenderer would be of client/Architect/Consultants/Engineer in charge.
- As far as possible, the successful tenderer will have to place order directly to the manufacturer OR it's authorized dealer.
- The Client/Architect/Consultants/Engineer in charge have right to check the challans of supplier.
- Make of components required to be used by contractor to complete the installation, if not mentioned any where, shall be required to GOT IT APPROVED by Client/Architect/Consultant/Engineer in charge before installation in writing manner.
- Within a week of work order, the contractor shall submit the sample of each item / component of above mentioned approved make for the approval of the Client/Architect/Consultant/Engineer in charge.

Sign & Seal of Contractor

FREQUENCY AND ACCEPTANCE CRITERIA'S FOR BUILDING MATERIALS USED FOR CONSTRUCTION

S. No.	Building Materials	Test to be carried out	Frequency of tests	Acceptance criteria	
1	Water	Chemical analysis	Once for approval of	TDS: (mg./litre) 2000	

S. No.	Building Materials	Test to be carried out	Frequency of tests	Acceptance criteria	
			source and subsequently in case of doubt.	Sulphate (as SO ₄ : (mg./litre) 400 P.H. value 6.5 to 8.5 Chloride: (mg./litre) 1000 for plain concrete, 500 for RCC work Organic matter : 2000 Inorganic Matter : 3000 Fluoride : (as F) mg/L 1.5 Magnesium : (as Mg) mg/L 100 Alkanity : (as CaCo ₃) mg/L 600	
2	Cement	(a) Consistency (b) Setting time (i) Initial (ii) Final (c) Finess by specific surface	One test for every 50 M.T. and on change of brand	(a) About 30 % (b) (i) Not less than 30 minutes (ii) Not More than 600 minutes. (c) 2250 Cm ² /g for O.P.C (d)	OR as per IS require ments.
		(d) Compressive Strength, N/mm ² not less than		IS 269-1989 Gr.33	
		i) 3 days ii) 7 days iii) 28 days		IS 8112-1983 Gr.43	
		(e) Soundness by le-chatelier		IS12269-1987 Gr.53	
3	Sand	a) Silt content b) Gradation, fineness Modulus c) Zoning tests d) Sp. Gravity e) Water absorption(%)	On test during working season. Minimum two tests. i.e. prior to Monsoon and after monsoon (Minimum one test for 150 m ³ of material used)	a) Upto 3% b) As per standard fixed under specification. Looking to the purpose of the use. For - Concrete – IS 383-1970 - Masnory Mortar – IS2116-1980 - Plaster – IS 1542-1992 c) Ordinary sand falling under zone (iv) shall not be used. d) As per IS 383 – 1970 e) As per IS 383 – 1970	
4	Kapchi and Metal (for RCC Work)	a) Specific gravity b) Absorption c) Impact value % d) Flaking Index e) Gradation percent passing of IS sieve	2 tests per season i.e. prior to and after monsoon / minimum one test for 150 m ³ of material used	a) Up to 3.00 generally b) Up to 1.5% c) Not more than 45% or as per IS 2386(part-I)-1986 d) Not more than 25% or as per IS 383-1970 e) As per IS 2386(part-I)-1986	
5	Bricks	a) Water absorption b) Efflorescence c) Compressive strength d) Dimension	One set of test every 50,000 bricks and on change of brand mark	a) Not more than 20 % b) Moderate c) Minimum range 35 Kg/Cm ² individual result may fall below upto 20% d) Length 452 to 468 cm Width 216 to 224 cm Depth 136 to 144 cm	Or require ment as per IS 1077-1992
6	Reinforcem ent	a) Ultimate tensile strength b) Yield stress (Proof stress) c) Elongation	Each set of test for each diameter of bars for every 20 M.T. or part thereof.	a) 42 Kg/mm ² for M.S. bars and 49.50 Kg/mm ² for twisted & TMT bars b) 26 Kg/mm ² for M.S. bars and 42.50 Kg/mm ² for twisted bars c) 23% of M.S. bars and 14.50% for twisted & TMT bars (CTD)	
7	C.C. Cubes		Ordinary & controlled concrete (IS 456/2000) quantity of concrete. Number in work of M ³ of sample.	Strength of cubes for different grade at 28 days. (1) Grade M100 100 Kg/cm ² (2) Grade M150 150 Kg/cm ² (3) Grade M200 200 Kg/cm ² (4) Grade M250 250 Kg/cm ² (5) Grade M300 300 Kg/cm ²	
			Quantity Cmt.	No of Samples	

S. No.	Building Materials	Test to be carried out	Frequency of tests	Acceptance criteria
			1 - 5 - 6 - 15 1 16 - 30 2 31 - 50 2 51 & above 2 One additional sample for each 50 M ³ or part thereof. (One sample consists of 3 cubes minimum)	
8	Flooring Tiles / Mosaic / Plain		One test for every 10,000 no. of tiles used and on change of brand mark	

- | | | |
|--------------------------|---------------------|---|
| a) Water Absorption | Six full size tests | a) Not more than 10 % |
| b) Transverse Strength " | " | b) 30 Kg/Cm ² |
| c) Abrasion | " | c) Average wear shall not exceed 3.5 mm wear on any individual specimen shall not excess 4 mm |
| d) Size | " | d) As per standard fixed under specification |

9	Bansi Pahadpur Stone	a) Water Absorption b) Crushing strength	2 sets of test per working seasons to i.e. prior and after monsoon.	a) Not More than 10 % b) Not less than 175 Kg/Cm ²
10	Teak Wood	a) Color b) Hardness c) Density d) Moisture e) Porosity f) Soft g) Identification	One test	As per I.S. specification
11	Seasoned & chemically treated wood	(a) Moisture content (IS 237 : 1973)		Moisture content

	Zone I	Zone II	Zone III	Zone IV
I. Doors & Windows	10	12	14	16
II. 50 mm and above in thickness	8	10	12	14
III. Thinner than 50 mm				

				Average moisture content of all the sample from a lot shall be within +3 percent. Samples with 45% of the maximum permissible moisture content for the particular and use and locality indicated above.																				
		(b) Absorption of the preservative windows (IS 401-1982)	One sample from lot.	(For zone refer Map given in IS 287 : 1973)																				
				<table border="1"> <thead> <tr> <th>Preservation</th> <th>Recommended Absorption Kg/m</th> </tr> </thead> <tbody> <tr> <td>a) CTC / LTC</td> <td>80</td> </tr> <tr> <td>b) CCA</td> <td>4</td> </tr> <tr> <td>c) RCC</td> <td>4</td> </tr> <tr> <td>d) CCE</td> <td>6.5</td> </tr> <tr> <td>e) CZC</td> <td>6.5</td> </tr> <tr> <td>f) Copper naphtenate abietate</td> <td>.4</td> </tr> <tr> <td>g) Zine naphtanate/ abitate</td> <td>0.6</td> </tr> <tr> <td>h) PCP</td> <td>5</td> </tr> <tr> <td>i) Boric Acid</td> <td>5</td> </tr> </tbody> </table>	Preservation	Recommended Absorption Kg/m	a) CTC / LTC	80	b) CCA	4	c) RCC	4	d) CCE	6.5	e) CZC	6.5	f) Copper naphtenate abietate	.4	g) Zine naphtanate/ abitate	0.6	h) PCP	5	i) Boric Acid	5
Preservation	Recommended Absorption Kg/m																							
a) CTC / LTC	80																							
b) CCA	4																							
c) RCC	4																							
d) CCE	6.5																							
e) CZC	6.5																							
f) Copper naphtenate abietate	.4																							
g) Zine naphtanate/ abitate	0.6																							
h) PCP	5																							
i) Boric Acid	5																							
12	Crushed Metal & Kapchi (for Road work)	1) Gradation 2) Flackiness 3) Impact value 4) Soundness 5) Specific garvity	1 test for 100 cu.m. 3 test for 101 to 500 cu.m. 5 test for 501 to 1500 cu.m. 7 tests for 1501 to 5000 cu.m.	1) As per IS 2386 (Part-I) – 1986 2) Not more than 15% for WBM Not more than 25% for RCC wearing surface Not more than 25% for																				

S. No.	Building Materials	Test to be carried out	Frequency of tests	Acceptance criteria	
		6) Water absorption		bituminous wearing surface 3) Not more than 35% for WBM Not more than 45% for RCC wearing surface Not more than 30% for bituminous wearing surface 4) Not more than 20% for WBM Not more than 12% for bituminous wearing surface 5) upto 3.00% 6) upto 1.5%	

Note: Tests as may be directed by Executive Engineer irrespective of provisions shown above shall have to be got conducted.

Sign & Seal of Contractor



Bhavnagar Municipal Corporation



- એજન્સી દ્વારા કામ શરૂ કરતા પહેલા સ્થળ સ્થિતિ મુજબના ફોટા ગ્રાફ રજૂ કરવાના રહેશે અને ત્યારબાદ જ કામગીરી શરૂ કરવાની રહેશે. વખતો વખત ટેન્ડર માં સમાવેશ થતી આઈટમો ની કામગીરી ના ફોટા ગ્રાફ રજૂ કરવાના રહેશે.
- આ તમામ ભાવમાં જી.એસ.ટી.નો સમાવેશ કરવામાં આવેલ નથી. સરકારશ્રીના નિયમાનુસાર અલગથી જી.એસ.ટી ચુકવવામાં આવશે. વધુમાં એજન્સીને સરકારશ્રીના નિયમનુસાર જી.એસ.ટી.નું ચુકવણું કરવાનું રહેશે.
- સ્થળે VFRPBL JLH , F. G 5; FZ Yતી હોય તો VF DF8[JLH 5|B\$XG VUJL TDFD jI J:YF Sllg8FS8Z[: JBR[SZJFGL ZCXP TDPH SM. VS: DFT S[HFGCFGL YFI TMT[VUJL TDFD HJFANEZL Sllg8FS8ZGL ZCXP
- હાલના વેન્ડર લીસ્ટ અને ભવિષ્યમાં જે તે સમયે જ્યારે ભાવનગર મહાનગરપાલિકા અને સક્ષમ સત્તા વેન્ડરમાં ફેરફાર કરશે તે અધતન વેન્ડર લીસ્ટ માન્ય ગણીને કોન્ટ્રાક્ટરશ્રીએ સાઈટ પર માન્ય મટીરીયલ વપરાશમાં લેવાનું રહેશે તે બાબતે વધારાના ભાવ તફાવત ખર્ચ ચુકવવામાં નહિ આવે.
- SFD X- SZTF 5J[SFDGL IJUTMNXFJT] AMO" SFD 56" YTF ; JML Sllg8FS8Z[: JBR[, UFOL ZFBJFG] ZCXP[VgI YF SM. 56 ; DI[AMO" , FU[, DF, D GCL 50X[tI FZ[-15I F 5 ___qV GL 5G<8L , FU] 50XP
- ટેન્ડર/એજન્સીએ ટેન્ડર ડોક્યુમેન્ટ સાથે ESIC કોડ/રજીસ્ટ્રેશન ફરજિયાત રજૂ કરવાનું રહેશે, ESIC કોડ/રજીસ્ટ્રેશન સિવાયનું ટેન્ડર માન્ય ગણાશે નહીં.
- કોન્ટ્રાક્ટરશ્રીએ બાંધકામ માં OPC ૫૩ ગ્રેડ સિમેન્ટ વાપરવાની રહેશે.
- ❖ p5ZMST TDFD XZTM VDM V[JFRLL4JRFJL4; DHL4JRFZLG[8gOZDF EEFJM EZ[, K[H[DG[q VDG[SA], DHIZ K[VGI T[DJHA VDM SFD SZJF AWF. V[KLVF

Sllg8FS8ZGL ; CL P

Sllg8FS8ZG[GFD P

Sllg8FS8ZGM I; SSM

TFZLB

**MUNICIPAL CORPORATION
BHAVNAGAR**

VENDOR LIST

(A) LIST OF APPROVED VENDORS FOR CIVIL WORKS

Sr. No.	ITEMS	Approved Brands / Quality
1	CEMENT OPC 53 Grade & SULPHATE RESISTANT CEMENT,S.R.C.	Ambuja, Hathi, Ultra Tech, Sanghi, Siddhi, Hi-bond
2	BRICKS	MBM, Arjun, PBM, 555, Kisan, ABM, TRD, Paresh, Dhara, B.R.C., Kiran, BMB, Kirit, Sonal
3	Steel TMT, CRS	TISCO, SAIL, VIZAG, Kamdhenu, NATIONAL, Electrotherm, JSW, Welspun steel, Pollad Steel, DIAMOUND TMT, M. G. Steel, Friends Steel, Crown next TMT, Briskon TMT
4	VITRIFIED TILES	Asian, Kajaria, Jonson, Varmora, Simpolo, OASIS
5	CERAMIC TILES	Asian, Kajaria, Johnson, Varmora, Simpolo, OASIS
6	GLAZED TILES	Asian, Kajaria, Johnson, Varmora, Simpolo
7	ACRYLIC PAINT	ICI, Asian, Nerolac, Burger
8	OIL BOUND DISTEMPER	ICI, Asian, Nerolac, Burger
9	EXTERIOR WEATHER PROOF EMULSION PAINT	ICI, Asian, Nerolac, Burger
10	Oil Paint	ICI, Asian, Nerolac, Burger
11	SANITARY WARE	Cera, Hindware, Parryware
12	CAST IRON PIPES AND FITTINGS.	NECO, Swayarhoo, Bengal, Oriental Castings, Electro steel Castings
13	P.V.C. PIPES AND FITTING (UPVC/CPVC)	Finolex, Supreme, Jain, Kisan, Astral, Dutron, Prince
14	CHROMIUM PLATED WATER SUPPLY FITTINGS	Jaquar, Ess Ess, Plumber ,ESSCO, Crown, Metro, Prince
15	GALVANIZED PIPE	Tata, Essco, Jaquar, Ess Ess, Plumber
16	GALVANIZED FITTINGS	'R' Brand, 'RV' Brand, Kranti
17	C.I. MANHOLE COVER	Manish, Sil, NECO
18	PLUMBING FIXTURES	Jaguar, Plumber, Essco
19	PVC WATER TANK (100% VIRGIN PVC)	Sintex, Aqua
20	ALUMINIUM SHEETS AND ACCESSORIES	Nalco, Jindal, Hindalco, Banko

Sr. No.	ITEMS	Approved Brands / Quality
21	ALUMINIUM EXTRUDED DOOR/ WINDOW SECTION	Jindal, Hindalco, Banko, Ajin India, Aldowin, Alumilite
22	ALUMINIUM HARDWARE	Rajdoot, Belu, Diamond, Glider, Ajin India, Aldowin, Alumilite
23	WATER PROOFING MATERIALS	Zycosil, Dr. Fixit, Kerakoll, Pidilite, Roff
24	DOOR CLOSER	Efficient Gadget, Everite, Hardwin, Aldowin, Ozone
25	DOOR FITTINGS	Godrej, Efficient Gadgets (E.G.) Dunex, Doorset, Suzu, Coral
26	HINGES	Suzu, Yama, E.P.P.W.
27	SCREW AND BOLTS	Nettle Folds, GKW, Stud
28	BOLTS & FASTENERS	Hilti, Fisher
29	LIFT	Top, Express, Omega, OTIS, Schander, TRIO, Aegis Elevator, Mitsubishi, Aditya, Siemens slider
30	ROOFING MATERIAL – Galvalume sheets	TATA, Essar, Jindal
31	Slag Cement	SANGHI CEMENT Sanghipuram
32	CPVC PIPES FOR AUTOMATIC SPRINKLER FIRE EXTINGUISHING SYSTEM	ASTRAL POLY TECHNIK LIMITED પાર્કિંગ એરિયા, બેઈઝમેન્ટ એરિયા જેવા વિસ્તારો સિવાય માત્ર કન્સીલ્ડ પાઈપીંગ માટે આ કંપનીના CPVC pipe નો ઉપયોગ fire sprinkler piping માટે કરવાની મંજૂરી આપવામાં આવે છે.
33	AAC Blocks	NXTBLOC
34	Jointing Mortar	NXTFIX Block
35	Ready Mix Plaster	NXTPLAST
36	Block joining Masonry Mortar	Unifix
37	Tile adhesive	Unifix
38	RCC bench	Sardar Pre cast
39	Rubber mould garden curbin	Sardar Pre cast

Sr. No.	ITEMS	Approved Brands / Quality
40	Rubber mould Paver block	Sardar Pre cast
41	Fencing Pole	Sardar Pre cast
42	RCC Masonry block	Sardar Pre cast
43	Pre cast wall	Sardar Pre cast

(B) LIST OF APPROVED VENDORS FOR MECHANICAL & ELECTRICAL WORKS

Sr. No.	Description	Name of Manufacturer
1	HSCF Pump	Crompton Greaves Ltd
		Kirloskar Brothers Limited (KBL)
		JASCO
		Mather & Platt Pumps Ltd.
		Jyoti Ltd.
2	Electric Motor	Lubi Industries LLP
		Bharat Bijlee Ltd.
		Jyoti Ltd.
		JSL Industries Ltd.
		Jeumont Electrical India Pvt. Ltd.
3	Electrical Panel	LHP
		Crompton Greaves Ltd
		Bhagyashree Power Control
		Dynamic Control System
		Elembica Services
		JSL Industries Ltd.
4	Kinetic Air Valve	Nutral Power Tech
		Kirloskar Brothers Limited (KBL)
		FOURESS Engineering (India) Limited.
		Durga Valves Pvt.Ltd
		Orbinox
	શ્રી કિલોસ્કાર બ્રાધર્સ લિમિટેડ	
5	Expansion Bellows	Precise Engineers
6	Dewatering (Drain) Pump(Submersible/ Horizontal)	KSB Pumps
		Kirloskar Brothers Limited (KBL)
		JASCO
		Crompton Greaves Ltd
		La Gajjar Machinery Pvt Ltd.
		Pullen Pumps Industries Pvt. Ltd.
		MBH
7	Sluice Valves and Sluice Gate	Kirloskar Brothers Limited (KBL)
		DURGA Valves Pvt.Ltd
		L & T Valves
		Jupiter
		SACHDEVA

Sr. No.	Description	Name of Manufacturer
8	UPVC Pipe	Supreme Industries Ltd., Mumbai
		Dutron Polymers Ltd
		Parixit Industries Ltd., A'bad
		Jain Irrigation Systems Ltd., Jalgaon
9	HDPE Pipe	Parixit Industries Ltd., A'bad
		Jain Irrigation Systems Ltd., Jalgaon
		Dutron Polymers Ltd
		Jindal
		Essar Steel
10	C.I. Pipe	Electro Steel, Kejriwal, Oriental Castings, BIC, Jindal, Lanco Industries Ltd., Chennai, Kesins
13	EOT Crane	Grip Engineering Pvt. Ltd., JAPS Project, Brady & Morris Engineering Co. Ltd., Techno Industries
14	Cable & Wires	KEI Industries Ltd.
		Polycab Wires Pvt. Ltd.
		Aerolex Cables Pvt. Ltd.
		Allwin Industries
		Finolex Cables
		L&T Cables
		ULTRA CAB (India) Limited
15	Transformer	Atlanta Electricals Pvt. Ltd.
		Powerlite Electricals
		Voltamp Transformers Ltd.
		SKP Transformers
		Arya Electronics
16	Components for MCC :	
	Switch	L&T, Siemens
	HRC Fuse	L&T, Siemens
	Timer	L&T, Siemens
	Relay	L&T, Siemens
	Push Button Stations	L&T, Siemens
	Indicating Lamp	L&T, Siemens
	Cable Jointing Kit	CCI, M. Seal
	MCB/DB's	MDS, Siemens, Indokupp
17	Capacitors	L&T, Crompton, Khatau Note: Capacitors shall be oil fill type
18	KWH Meter	Simco, Jaipur, GEC
19	Light Fittings: (Indoor & Outdoor Luminaries)	Philips, Crompton, Bajaj, NESSA Illumination
20	Exhaust Fans	Crompton, Bajaj,
21	Ceiling Fans	Crompton, Bajaj, Havells
22	Air Blowers	Everest Ltd.
		Swan Pneumatics (P) Ltd
23	Alum Dosing Pumps	Asia LMI
		VK Pumps
		Swelore
24	Pressure Gauges	General Instruments
		Bells Control
		H. Guru Marketing
25	Level Gauge / Indicator	R K Dutt

Sr. No.	Description	Name of Manufacturer
		Levecon
		S. B. Electromec
26	Clarifier Equipment	Enviro Control Associates
		Voltas Ltd
		Hindustan Dorr-Oliver
		Geomiller/Triveni
27	Chlorination System	Industrial Device (I) Pvt. Ltd
		Metito
		Chloroequip
		Pennwalt
28	Gear Box	Greaves
		Radicon
		Elecon
		Shanti
29	Level Switches	Level-Tech
		Revathi Electronics
		Levec
30	Refrigerator	LG, Samsung, Kelvinator
31	PVC Pipes for Fluid	Finolex, Jain Irrigation
32	PVC Conduits for Electricals	Precision, Shakti
33	Butterfly Valve	KIRLOSKAR Brothers Limited(KBL), DURGA valves Pvt Ltd, L & T valves, R&D MULTIPLE, Jupiter, श्री कृष्णा एन्जिनीयर्स IVC, IVI, Audco, R & D multiple, Jupiter, Cair, Orbit Engineers
34	Check Valve (Dual Plate check Valve)	KIRLOSKAR Brothers Limited(KBL), DURGA valves Pvt Ltd, Orbinox, R&D MULTIPLE, Orbit Engineers
35	Metallic Expansion Bellow	Beloflex(B.D. Engineers), Stanfab Engineering Pvt. Ltd., D. Wren Engineering Pvt. Ltd., Sur Industries,
36	Centrifugal / Centrifugal Non Clog Pumps	Beacon Weir, KSB, Mather & Platt (Wilo), Worthington, WPIL, Xylem pumps , Grundfos Pumps Pvt. Ltd., MBH, JASCO
37	Submersible non Clog Pumps / Submersible Centrifugal Pumps	Kirlosker, KSB, ABS, ITT- Flyght, Xylem pumps, Grundfos Pumps Pvt. Ltd. , MBH, JASCO, AQUA, Jyoti, PULLEN PUMPS, Alpha, Het Pump
38	Screw Pump	Roto, Netzsch, Tushaco, Seepex
39	Metering / Dosing Pumps	Swellore, V.K. Pumps, Shapotools
40	Non Return Valves (Single / multi door) / Dual Plate Check Valves	Kirlosker, IVC, IVI, R & D multiple, Durga, Jupiter, Cair, Orbit Engineers
41	Knife Gate valves	Jash, Fouess, Vass (Dezurick), Vag, Orbinox, Orbit Engineers
42	Sluice gates / open Chanel Gates	Jash Engineering, IVC, R & D Multiple, Jupiter
43	Mechanical Fine Screens – Step (Mat) Type / Drum Type	Jash, Huber, Johnson, Savi, Italy, Apollo Screens

Sr. No.	Description	Name of Manufacturer
44	Mechanical Course bar Screen	Jash, Huber, Johnson, HDO, Triveni, Savi, Italy
45	Manual Bar Screen	Jash, Japs, HDO, Triveni, Auric
46	Grit mechanism	EIMCO – KCP, Hindustan Dorr – Oliver, Jash-Shivpad, Triveni, Voltas
47	Diffused Aeration System	EDI, OTT, Rehau
48	Air Blower	Kay, Swam, Everest, Usha Compressors, Gardner Denver
49	Agitator / mixer	Remi, Schurtek, Fibre & Fibre, Milton Roy
50	Gear Boxes	Greaves, Elecon, CPEC, PEPL, Bonfiglioli
51	Centrifuge	Humboldt, Alpha Laval, Hiller
52	HDPE Pipes	Astral, Dutron, Duraline, Narmada, RIL (PIL), Penwalt, Anjney, jain irrigation, Sangir
53	Air Compressor	Ingersoll – Rand, khosla, Kirlosker, CPE, Alpha
54	Bearing For All Equipments	SKF, FAG, Tata
55	Fasteners	Precision, Durakhanawala, Echjay, Tata, Sundaram
56	Mechanical Seals	Eagle Seals (Sealol), Durametallic, Burgman
57	Electric Actuator	Auma ,Rotork, Emerson, Pentair
58	(1) CATEGORY III Indoor LED fittings, LED Panel light, LED down light, outdoor LED ligh (street light, LED flood light, LED Post top lantern, LED bollard) (2) Solar LED Light	NESSA ILLUMINATION TECHNOLOGIES PVT.LTD., Litsun, Nextray
59	STREET LIGHT POLES	AMBICA POLES (for octogonol poles,swage poles,street loght poles, high mast poles,decorative poles, conical poles, JETCOTECH Engineering LLP
60	Resilient Seated Slice Valve	Cair
61	Air Vale	Cair, Orbit Engineers
62	Flow Control valve	Cair
63	Altitude Control valve	Cair, Orbit Engineers
64	Pressure reducing valve	Orbit Engineers
65	Pressure relief valve	Orbit Engineers
66	Ball valve	Orbit Engineers
67	Mast pole	JETCOTECH Engineering LLP
68	Earthing material	JETCOTECH Engineering LLP
69	Hot dip galvanizing	JETCOTECH Engineering LLP
70	LED Highbay	Litsun

(C) LIST OF APPROVED VENDOR FOR INSTRUMENTATION SYSTEM

SR NO	DESCRIPTION	Name Of Manufacturer
1	Electromagnetic Flow Meter	E+H, Siemens, Abb, Fuji, Yokogawa, Krohne-Marshall, AAROHI Embedded System Pvt Ltd., Emerson, SBEM
2	Pressure Gauges	Wika, H.Guru, General Instruments Consortium Manometer (India) P. Ltd. , Baumer, Waaree
3	Pressure Switch	Danfoss , Indfoss , Switzer
4	Process Analyzers (pH, DO, Free / Residual Chlorine , BOD / COD)	E+H , Emerson , Hach , Chemitech , Polymetron, Wtw (Forbes Marshall),Yokogawa
5	Ultrasonic transmitter level / diff. level / flow	E+H, Siemens – Milltronics, Krohne, Vega
6	Hydraulic level transmitter	E+H,Siemens, ABB, Forbes- Marshall, Emerson, SBEM
7	Displacer/Float Switches	Levcon, Nivo, Toshbro, Pune Techtrol , SBEM
8	PP Float / Buoyancy switch	Pepprl + Fuchs, Baumer, Waaree, E+H , Pune Techtrol , SBEM
9	Float & Board Type Level Gauge	Levcon, Nivo, Toshbro, Pune Techtrol, SBEM
10	Electromagnetic Flow Meter	E+H, Siemens, ABB, Fuji, Yokogawa, Krohne-Marshall
11	Field Transmitter (P, DP,F, L , T)	ABB, Fuji, Yokogawa, Honeywell, Emerson
12	Pressure Gauges	Wika, H.Guru, General Instruments Consortium Manometer (India) P. Ltd., Baumer, Waaree
13	Panel Mounted Process Indicator & Flow Integrator	Masibus, Nishko, Nivam, Selectron, Radix, Yokogawa, ABB
14	Pressure Switch	Danfoss, Indfoss, Switzer
15	Programmable Logic Controllers	Rockwell (Allen Bradeley), Siemens, Schneider, Fuji, ABB, GE Fanuc
16	Control Panel Enclosure	Rittal, Enklotek, Bartakke, BCH, Eldon
17	Alarm Annunciator	Aplab Ltd., Minilec , IIC
18	Solenoid valves	Asco, Rotex, Schrader
19	Tube Fitting	Excel Hydropneumatic, Multimetal, Placka

20	Instrument Valves , Manifolds	Aptek, Anmol (Superlok), Excel Hydropneumatic, General
21	Fitting	Instrument Consortium , Multimetal, Technomatic, Placka
22	Pneum , Brass Fitting	Swagelok, Multimetal Industries, SMC, Festo
23	Control Panel Accessories / Components	
a.	Miniature Relay	Wago, Omron,Phoenix, Rockwell
b.	Indication Pilot Lamps (LED Type)	Teknic, Schneider, Siemens
c.	Push Button / Selector Switch (with NO/NC Elements)	Teknic, Schneider, Siemens
d.	DC Power Supplies (DIN Rail mounted)	Phoenix, Omron, Schneider, Rockwell
e.	Terminals	Elmex, Phoenix, Wago, Connectwell
f.	Panel Wires	Finolex , Havell's , R R Kabel
g.	Panel Illumination	Philips , Crompton , GE
24	Instrument Cables (Power , Signal , Control)	Associated Cables, Associated Flexible and Wires P.Ltd., Brooks Cables, Thermo Cables, Udey Pyro
25	Cable Glands	Ex- protecta, Braco, Sudhir, Comet, Connectwell
26	Junction Box	Ex- protecta, CEAG, Sudhir, Baliga, FCG
27	Cable Tray	M.M.Engineering, Globe, Jacinth, Equi. Reputed, JETCOTECH Engineering LLP
28	Computer System	HP-Compaq, Dell, IBM, Sony, Samsung
29	UPS	Hirel-Hitachi, Emerson, APC
30	<ol style="list-style-type: none"> 1. PLC (Programmable Logic Controller) 2. SCADA (Supervisory Control and Data acquisition) 3. VFD (Variable Frequency Drive Up to 500 KW) 4. ACB (Air Circuit Breaker up to 	MITSUBISHI ELECTRIC INDIA PRIVATE LIMITED, Emerald House, EL-3, J Block, M.I.D.C., Bhosari, Pune 411026

	6000A) 5. MCCB (Moulded Case Circuit Breaker up to – 1600 A) 6. MCB (Miniature Circuit Breaker up to – 63 A) 7. ELCB (Earth Leakage Moulded Case Circuit Breaker up to 1600 A) 8. Contractor up to – 800 A & OLR (Over load Relay) up to 630 A 9. Multi Functional Meters 10. MPCB (Motor Protection Circuit Breaker up to 32 A)	
--	--	--

**(D) LIST OF APPROVED VENDORS FOR MATERIALS RELATED TO WATER
SUPPLY AND SEWERAGE NETWORK**

SR. NO.	ITEMS	NAME OF AGENCIES
1	A C Pressure pipe MAZZA process	Lotus, Kirti
2	A C Pressure pipe MEGHNANI process	Lotus, Kirti, Hindustan
3	Sluice Valve	Durga, kartar, Kirloskar, Jupiter, SACHDEVA (C.I. & D.I.), શ્રી કિર્તિ ઇન્જિનીયર્સ, Cair, Orbit Engineers
4	DI Pipe	Electrotherm (I) Ltd.,Ahmedabad, Lanco Industries Ltd.,Chennai, Electrsteel, Jindal Saw Ltd.,Ahmedabad, Kesins, Welspun
5	R.C.C. PIPE (COLLAR JOINT & SOCKET SPIGOT JOINT) CLASS NP3 & NP4, & R.C.C. COLLARS	VIPUL SPUN PIPES (SIHOR & LATHIDAD,BOTAD), KATARIYA & CO. (DHASSA), OMKARESHVAR PIPES (NAVAGAAM), OMKAR PIPES (LATHIDAD, BOTAD), MARUTI PIPES (BAGODARA ,AHMEDABAD), KALATHIYA PIPES(BAGODARA ,AHMEDABAD), R. S. PIPES (BODELI), UMA HUME PIPES (KALOL, GANDHINAGAR), SIDHDHIVINAYAK (KARDEJ ,BHAVNAGAR)
6	R.C.C. MACHINEOLE FRAME & COVER, INLET FRAME COVER 10T.(600*450 MM.) , 20T.,35T., & 50T.	SONI CEMENT PRODUCT , VIPUL SPUN PIPES, KATARIYA & CO., OMKARESHVAR PIPES, OMKAR PIPES, MARUTI PIPES, KALATHIYA PIPES , R. S. PIPES, UMA HUME PIPES, SIDHDHIVINAYAK , S.K. Corporation, Laxmi Price Industries, S.J.Corporation, Sardar pre cast

7	Stone ware PipeManufacturer having BIS Certificate for ISI marking	Krishna Pipe, j.K. Pipe, Taya ceramic, Burn & co., perfect Potteries, Navroji Vakil, Kashmira
8	D.I. & C.I. FITTINGS	RG BRAND, ESSEM Engineering Industries, Bikaners Engineers works
9	CID Joints	ESSEM Engineering Industries
10	Valves & Graded Castings	ESSEM Engineering Industries
11	Pipe Fittings	ESSEM Engineering Industries, Bikaners Engineers works
12	CI/DI/MS graded castings	Bikaners Engineers works
13	Scraper machine hole	Sardar Pre cast

Note: The vendor list changes from time to time. The vendor list of that time has to be followed during the work. Any material not as per the prescribed specification and included in the vendor list shall be rejected and action taken to remove such material from the vendor list.

રસ્તા, પુલો તથા મકાનોના બાંધકામની વિગતો તથા
સ્પેશીફિકેશન અંગેના કામના સ્થળ પર બોર્ડ મુકવા બાબત.

ગુજરાત સરકાર
જાહેર બાંધકામ વિભાગ
પરિપત્ર ક્રમાંક બીડીજી/૩૨૭૭/(૧૬૫૭)સ
સચિવાલય, ગાંધીનગર.
તા. ૨૬/૪/૧૯૭૮

પરિપત્ર:-

જાહેર બાંધકામ વિભાગ મારફત થતાં રસ્તા, પુલો તથા મકાનોના બાંધકામની વિગતો તથા સ્પેશીફિકેશનની માહિતી જાહેર જનતાને જે તે કામના સ્થળ ઉપર આ માટે મળી શકે તેથી જાહેર જનતા તે અંગે યોગ્ય સુચનો કરી શકે. તે માટે કામ સાઈટ ઉપર સરળ ભાષામાં બોર્ડ મુકવા અંગેની બાબત સરકારશ્રીની વિચારણામાં હતી. સરકારે આ અંગે યોગ્ય વિચારણા કરી ઠરાવેલ છે કે આ વિભાગ તરફથી કરવામાં આવતાં રસ્તા, પેલો તથા મકાનોના કામો માટેની નીચે જણાવ્યા મુજબની વિગતો દર્શાવતા બોર્ડ કામના સ્થળ ઉપર જાહેર જનતાની જાણ માટે મુકવા :-

જાહેર વિજ્ઞપ્તિ

આ રસ્તાનું / પુલનું મકાનનું કામ ગુજરાત રાજ્યના જાહેર
બાંધકામ વિભાગ હેઠળના વિભાગ હેઠળ
..... પેટાવિભાગ હસ્તક ચાલે છે.

આ કામના સામાન્ય સ્પેશીફિકેશન નીચે પ્રમાણે છે.

૧. રસ્તા અંગેના સ્પેશીફિકેશન :-
ઓવરસાઈઝ મેટલનું સે.મી. દર્શાવેલ જાડો થર
૨. મેટલ સે.મી. દર્શાવેલ જાડો થર.
૩. પેટીનું નામ સે.મી.નું ભરવામાં આવે છે.

(૨) પુલનું કામ :-

૧. પુલના ગાળા દરેક મીટર લંબાઈનો
૨. પીયર કેપનું ક્રોક્ષીટ ૧:૨:૪ ના પ્રમાણમાં.
૩. સ્લેબનું ક્રોક્ષીટ ૧:૨:૪ હાઈગ્રેડ કે વીલીટી કન્ટ્રોલ ૧૫૦ કે ૨૦૦ એમએમ.
૪. પુલના પાયાનો ક્રોક્ષીટ ૧:૩:૬ ના પ્રમાણમાં થાંભલા અને એબટમેન્ટનું ક્રોક્ષીટન ૧:૩:૬ ના પ્રમાણમાં.

(૩) મકાનો :-

૧. પાયાનું ક્રીકીટ પત્થરનું ૧:૩:૬ નું

૨. ઈંટોનું ચણતર અને ૧ અને ૬નું પ્રમાણ

૩. ભોંયતળીયુ ૧:૨:૩ નું ચુનાનું ક્રીકીટ કે ૧:૪:૭ સીમેન્ટનો ક્રીકીટ ઉપર ૧ ઈંચ સાઈઝની મોઝેક ટાઈલ્સ.

૪. બારી બારણા સાગી લાકડાના.

૫. આર.સી.સી.કામ ૧:૨:૪ કે ૧૫૦ એમ.કે. ૨૦૦૦ એમ.નું

આ કામની વિગતે સ્પેશીફિકેશન નાયબ ઈજનેરશ્રી પેટા વિભાગની કચેરીએ ઓફીસના સમય દરમ્યાન કોઈપણ સમયે જોઈ શકાશે.

તો માહિતી માટે તે અધિકારીનો સંપર્ક સાંધવો.

આ કામની માહિકી જાહેર જનતાની છે અને કામમાં જોઈ ક્ષતિ કે અનિયમિતતા જણાય તો તે બાબતમાં જાહેર બાંધકામ વિભાગના અધિક્ષક ઈજનેરશ્રી જેની કચેરી સ્થળે છે તેમનું ધ્યાન કરવા વિનંતી છે.

કાર્યપાલક ઈજનેર
માર્ગ અને મકાન વિભાગ

રસ્તા, પુલો તથા મકાનોના બાંધકામની વિગતો તથા
સ્પેશીફિકેશન અંગેના કામના સ્થળ પર બોર્ડ મુકવા બાબત.

ગુજરાત સરકાર
માર્ગ અને મકાન વિભાગ
ઠરાવ ક્રમાંક ટીએનસી/૧૦૯૨/૨૧/સ
સચિવાલય, ગાંધીનગર.
તા. ૧૮/૧૧/૧૯૯૧

સંદર્ભ: સરકારશ્રીની સરખા ક્રમાંકની તા. ૨૦/૧૨/૯૦ નો ઠરાવ.

આમુખ: રસ્તા, પુલો તથા મકાનોના બાંધકામની વિગતો તથા સ્પેશીફિકેશન અંગેના કામના સ્થળ પર બોર્ડ મુકવા અંગેની બાબત
સરકારશ્રીની વિચારણા હેઠળ હતી.

ઠ રા વ :-

પુખ્ત વિચારણાને અંતે આથી ઠરાવવામાં આવે છે કે, રસ્તા, પુલો મકાનો વર્કઓર્ડર મળ્યા પછી તુર્તજ કામના સ્થળે
કરવાના કામના સ્પેશીફિકેશન અંગેનું બોર્ડ કોન્ટ્રાક્ટરે પોતાના ખર્ચે મુકવાના રહેશે.

ઉપરોક્ત શરત ટેન્ડરના ભાગ તરીકે ગણવાની રહેશે અને ટેન્ડરમાં તેનો સમાવેશ કરવાનો રહેશે.

આ હુકમોનો અમલ હુકમો રવાના થયાના તારીખથી કરવાનો રહેશે.

આ હુકમો આ વિભાગના સરખા ક્રમાંકની ફાઈલ પર નાણાં સલાહકારશ્રીની તા. ૧૧/૯/૯૧ ના મળેલ સંમતિથી બહાર
પાડવામાં આવેલ છે. આ હુકમો માર્ગ અને મકાન વિભાગના બધા જ કામોને લાયુ પડશે.

ગુજરાતના રાજ્યપાલશ્રીના હુકમથી અને તેમના નામે,

(એ. જે. દોશી)
નાયબ સચિવ
માર્ગ અને મકાન વિભાગ

રસ્તા પુલો તથા મકાનો બાંધકામની વિગતો તથા સ્પેશીફીકેશન અંગેના કામના સ્થળ પર બોર્ડ મુકવા બાબત.

ગુજરાત સરકાર
માર્ગ અને મકાન વિભાગ
ઠરાવ ક્રમાંક ટીએનસી/૧૦૮૦/૨૪/સ
સચિવાલય, ગાંધીનગર.
તા. ૨૭/૧૧/૧૯૯૦

સંદર્ભ: જા.બાં.વિ.ના પરિપત્ર ક્રમાંક બીકે/૩૨૭૭/(૧૬૫)ન, તા. ૨૬/૪/૭૮

ઠ રા વ :-

રસ્તા, પુલો તથા મકાનોના બાંધકામની વિગતો તથા સ્પેશીફીકેશન અંગેના કામના સ્થળ ઉપર બોર્ડ મુકવા અંગેની સંદર્ભમાં દર્શાવેલ પરિપત્રથી જરૂરી સુચનાઓ આપવામાં આવેલ છે. આવા કામની વિગત દર્શાવતા બોર્ડ મુકવા અંગેનો ખર્ચ વિભાગ તરફથી કરવામાં આવતો હતો. કામ પુર્ણ થયા બાદ આવા બોર્ડ બીન જરૂરી પડી રહેતા હતા. આવો ખર્ચ નિવારવાની બાબત સરકારશ્રીની વિચારણામાં હતી. પુર્નવિચારણા અંગે આથી ઠરાવવામાં આવે છે કે જ્યારે રસ્તા / પુલ / મકાનનું કામ હાથ ધરવાનું નક્કી કરવામાં આવે ત્યારે આવું બોર્ડ કામ રાખનાર ઠેકેદારે તેમના ખર્ચે મુકવાનું રહેશે. કામ ચાલુ કરવાનો હુકમ આપવામાં આવે તે પહેલા આ બાબતની જરૂરી સંમતિ સંબંધીત ઈજારદાર પાસેથી લેખિતમાં મેળવી લેવી. તેમજ કોન્ટ્રાક્ટ ધ્વારા આવું બોર્ડ મુકવામાં આવે તે અંગે પુરતી કાળજી રાખવી.

આ હુકમો આ વિભાગની સરખા ક્રમાંકની ફાઈલ ઉપર નાણાંકીય સલાહકારશ્રીની તા. ૧૫/૨/૯૧ ની નોંધથી મળેલ સંમતિથી બહાર પાડવામાં આવેલ છે.

ગુજરાતના રાજ્યપાલશ્રીના હુકમથી અને તેમના નામે,

(પ્ર. ર. ચોકસી)
ખાસ ફરજ પરના અધિકારી
માર્ગ અને મકાન વિભાગ

ક્રમાંક : ૫૨૪-૬૧૦૪-૨૨૨ રેઈટ-ડીટીપી-૩૯૭૧-ન,

ગુજરાત સરકાર
માર્ગે અને મકાન વિભાગ,
બ્લોક નં. ૧૪/૨, સરદારભવન,
સચિવાલય, ગાંધીનગર
તા. ૨૯-૦૭-૨૦૦૪

પ્રતિ,
અધિકારક ઈજનેરશ્રી (સર્વે),
રાજ્ય વિભાગ,

વિષય :- ટેન્ડરમાં સ્ટાર રેઈટ તથા ડી.ટી.પી. મંજૂરીના માસ અને વર્ષે દર્શાવવા બાબત.

સંદર્ભ :- ઠરાવ ક્રમાંક ટીએનસી - ૧૦૮૯/૪-સી, તા. ૩૧-૦૮-૧૯૯૧.

જે ટેન્ડરમાં સીમેન્ટ / સ્ટીલ ઈજારદારે ખરીદવાનો હોય અને તેઓને આ માલસામાનના ભાવો તથા ટેન્ડરમાં દર્શાવેલ સ્ટાર રેઈટના ભાવોનો તફાવત સરભર કરી આપવાનો હોય તેવા ટેન્ડરમાં આ માલસામાનના સ્ટાર રેઈટની જોગવાઈ નીચે મુજબ કરવાની ટેન્ડરના કલોઝ પલ A માં જોગવાઈ છે.

૧. જે માસ તથા વર્ષમાં ડી.ટી.પી. મંજૂર થયા હોય તે માસ અને વર્ષે કોરા ટેન્ડર ઈસ્યુ કરતી વખતે તેમાં દર્શાવવાના રહેશે.
૨. સીમેન્ટ માટેના ભાવો જે માસમાં ડી.ટી.પી. માં મંજૂર થયું હોય તે માસના અધિકત વિક્રેતા પાસેથી મેળવી કોરા ટેન્ડર ઈસ્યુ કરતી વખતે તેમાં દર્શાવવાના રહેશે.
૩. સ્ટીલ તથા એચ.વાય.એસ.ડી.બાર માટે સેઈલ કંપની માંથી જે માસમાં ડી.ટી.પી. મંજૂર થયું હોય તે માસનો ભાવ મેળવી કોરા ટેન્ડર ઈસ્યુ કરતી વખતે તેમાં દર્શાવવાનો રહેશે.
- ૨/- એવું જણાય છે કે આ જોગવાઈનો યુક્ત પછે અમલ થતો નથી અને સ્ટાર રેઈટમાં વિવિધ વિભાગો ધ્વારા એક સુત્રતા જળવાતી નથી.
- ૩/- આથી સર્વેને આજ્ઞાનુસાર સુચના આપવામાં આવે છે કે કોરા ટેન્ડર પેપર્સ ઈસ્યુ કરતી વખતે આ જોગવાઈ મુજબના ભાવો અને ડી.ટી.પી. મંજૂર થયાનું માસ, વર્ષે અવશ્ય દર્શાવવા ટેન્ડરો મંજૂર કરવા દરખાસ્ત કરવામાં આવે ત્યારે આ દરખાસ્તમાં, દર્શાવેલ સ્ટાર રેઈટ અંગેના આધાર / પુરાવા રજૂ કરવા અને આ જોગવાઈ મુજબ જ ટેન્ડર પેપર્સમાં ભાવો દર્શાવેલ છે તે મતલબનું કા.ઈ.શ્રી.નું પ્રમાણપત્ર પણ રજૂ કરવું. વધુમાં આ સ્ટાર રેઈટ અને અંદાજી ભાવોના, ભાવ તફાવતને કારણે ટેન્ડરની અંદાજી રકમ સંબંધે ઈચા / નીચાની પરિસ્થિતિ પણ ટેન્ડર મંજૂરીની દરખાસ્તમાં અવશ્ય કરવી.
- ૪/- આ સુચનાઓનો યુક્તપછે અમલ કરવા વિનંતી છે અને આ અંગેની યુક્તની ગંભીર નોંધ લેવામાં આવશે તેની નોંધ લેવા વિનંતી છે.

(સં. મ. ભટ્ટ)
ઉપસચિવ (મકાનો)
માર્ગે અને મકાન વિભાગ.

નકલ રવાના :
સર્વે કાર્યપાલક ઈજનેરશ્રી,
રાજ્ય વિભાગ,

**રાજ્ય સરકારના બાંધકામ માટે વપરાતા ગૌણ
ખનીજની રોયલ્ટી ભરવા બાબત.**

ગુજરાત સરકાર
ઉદ્યોગ અને ખાણ વિભાગ.
ઠરાવ ક્રમાંક : એમએમઆર/૧૧૨૦૦૦/૨૦૧૩/છ
સચિવાલય, ગાંધીનગર
તારીખ :- ૧-૮-૨૦૦૪

વંચાણે લીધા :-

- (૧) ઉદ્યોગ ખાણ અને ઉર્જા વિભાગનો ઠરાવ ક્રમાંક : એમસીઆર- ૨૧૬૮-૭૩૮૦-છ તા.૧૨/૧૨/૧૯૬૯
- (૨) ઉદ્યોગ ખાણ અને ઉર્જા વિભાગનો ઠરાવ ક્રમાંક : એમસીઆર- ૨૧૬૮-૮-૬૬૮૫-છ તા.૧/૧/૧૯૮૭
- (૩) ઉદ્યોગ ખાણ અને ઉર્જા વિભાગનો ઠરાવ ક્રમાંક : એમસીઆર- ૨૧૮૮-(૮)૬૫-છ તા.૨૫/૧/૧૯૯૧
- (૪) ઉદ્યોગ અને ખાણ વિભાગનો ઠરાવ ક્રમાંક:એમસીઆર-૧૦૯૭-૨૮૫૬-છ, તા.૬/૧૧/૧૯૯૭
- (૫) માન.મુખ્યમંત્રીશ્રીના અધ્યક્ષપણા હેઠળ યોજાયેલ એમ્પ્રાવર્ડ કમીટીની તા.૧૮/૬/૨૦૦૪ ની બેઠકની કાર્યવાહી નોંધ.

ઠરાવ :-

ઉદ્યોગ, ખાણ અને ઉર્જા વિભાગના સંદર્ભ - (૩) હેઠળના ઠરાવથી એવી જોગવાઈ કરવામાં આવેલ કે રાજ્ય સરકારના , પંચાયતોના અને સરદાર સરોવર નમોદા નિગમના બાંધવામાં આવતાં રસ્તાઓના કે સિંચાઈ વગેરેના કામો માટે જ્યારે સાદી માટી (ઓર્ડીનરી ક્લે-અર્થ) અને (સોફ્ટ) મુરમ વાપરવામાં આવે ત્યારે ગુજરાત ગૌણ ખનિજ નિયમ , ૧૯૬૬ મુજબ રોયલ્ટી લેવાના નિયમો લાગુ પડશે નહીં. એટલે કે આ કામો માટે કોન્ટ્રાક્ટરો પાસે સાદી માટી (ઓર્ડીનરી ક્લે- અર્થ) અને (સોફ્ટ) મુરમ માટે રોયલ્ટી લેવાથી થશે નહીં તથા સંદર્ભ- (૪) હેઠળના વિભાગના તા.૬/૧૧/૯૭ ના ઠરાવથી ગુજરાત વિદ્યુતબોર્ડ દ્વારા હાથ ધરવામાં આવતાં કામો માટે પણ ઉપર મુજબ રોયલ્ટી મુક્તિનો લાભ આપવામાં આવેલ.

ઉપરોક્ત જોગવાઈના કારણે રાજ્યમાં ગેરકાયદેસર રીતે આ ખનીજોનો વપરાશ થતો હોવાનું જણાયેલ છે. જેના પરિણામે રાજ્ય સરકારે રોયલ્ટીની આવક ગુમાવવી પડે છે માટે ઉપરોક્ત હુકમોની જોગવાઈની સમીક્ષા કરી તે દૂર કરવાની બાબત સરકારશ્રીની વિચારણા હેઠળ હતી. તા.૧૮/૬/૨૦૦૪ ના રોજ માન.મુખ્યમંત્રીશ્રીના અધ્યક્ષપણા હેઠળ

યોજાયેલ એમ્પ્રાવર્ડ કમીટીની બેઠકમાં નક્કી થયા મુજબ સંદર્ભ-૩ તથા સંદર્ભ-૪ હેઠળના વિભાગના તા.૨૫/૧/૯૧ તથા તા.૬/૧૧/૯૭ ના ઠરાવો આથી રદ કરવામાં આવે છે.

ગુજરાતના રાજ્યપાલશ્રીના હુકમથી અને તેમના નામે.

(આર.બી.વ્યાસ)
નાય.બ સચિવ
ઉદ્યોગ અને ખાણ વિભાગ

ગુજરાત સરકાર
માર્ગ અને મકાન વિભાગ
પરિપત્ર ક્રમાંક : ટીએનસી-૧૦-૨૦૦૨-(૧૪)-સ,
સચિવાલય, ગાંધીનગર
તારીખ :- ૨૭-૪-૨૦૦૫

વિષય :- રાજ્ય સરકારના બાંધકામ માટે વપરાતા ગૌણ ખનિજની રોયલ્ટી ભરવા બાબત.
સંદર્ભ :- ઉદ્યોગ અને ખાણ વિભાગનો ઠરાવ ક્રમાંક : એમએમઆર-૧૧૨૦૦૦-૨૦૧૩-૧૭, તા.૧-૯-૨૦૦૪

પરિપત્ર :-

ઉદ્યોગ, ખાણ અને ઉજ્જૌ વિભાગના તા.૨૫-૧-૯૧ ના ઠરાવ ક્રમાંક : એમસીઆર-૨૧૮૮-(૮) -૬૫-૧૭ અન્વયે રાજ્ય સરકારના, પંચાયતના અને સરદાર સરોવર નમૈદા નિગમના બાંધવામાં આવતાં રસ્તાઓના કે સિંચાઈ વગેરેના કામો માટે જ્યારે સાદી માટી (ઓડીનરી કલે-અર્થ) અને (સોફ્ટ) મુરમ વાપરવામાં આવે ત્યારે ગુજરાત ગૌણ ખનિજ નિયમ-૧૯૬૬ મુજબ રોયલ્ટી લેવાનો નિયમ લાગુ પડશે નહીં. એટલે કે આ કામો માટે કોન્ટ્રાક્ટરો પાસે સાદી માટી (ઓડીનરી કલે -અર્થ) અને (સોફ્ટ)મુરમ માટે રોયલ્ટી લેવાની થશે નહીં તેવી જોગવાઈ કરવામાં આવેલ. હવે ઉપર સંદર્ભમાં દર્શાવેલ ઉદ્યોગ અને ખાણ વિભાગના તા.૧-૯-૨૦૦૪ ના ઠરાવથી તા. ૨૫-૧-૯૧ ના ઠરાવ રદ કરવામાં આવેલ છે.

આથી હવે બી-૧ ટેન્ડર ફોર્મ માં ખંડ - ૩૬ અને બી-૨ ટેન્ડર ફોર્મમાં ખંડ-૩૫ માં નીચે મુજબ સુધારો કરવામાં આવે છે.

રાજ્ય સરકારના બાંધકામ માટે વપરાતા ગૌણ ખનિજની રોયલ્ટી બાબત.

(૧) તા.૧-૩-૯૧ ના ઠરાવ મુજબ મુરમ સિવાયના

અન્ય સુધીના શબ્દો રદ કરી ફક્ત નીચે મુજબ જોગવાઈ અમલમાં રહેશે.

ગૌણ ખનિજ બાબતમાં રા.ગૌ.ખ.નિ.૧૯૬૬ અને તેના અનુસંધાનમાં વખતોવખત બહાર પાડવામાં આવેલ ઠરાવો લાગુ પડશે, અને તે મુજબ લીઝ કે પરમીટ લેવાનું અને રોયલ્ટી ભરવાની રહેશે.(ઉદ્યોગ અને ખાણ વિભાગ ઠરાવ ક્રમાંક એમએમઆર-૧૧-૨૦૦૦-૨૦૧૩-૧૭ તા.૧-૯-૦૪)

(અશોક પંડ્યા)
ઉપસચિવશ્રી,
માર્ગ અને મકાન વિભાગ

પ્રતિ,

સર્વે અધિક્ષક ઈજનેરશ્રી,

(મા.મ.વર્તુળો/ પંચાયત (મા.મ.)વર્તુળો/ એક્સપ્રેસ વે વર્તુળ / રાજ્ય માર્ગ યોજના વર્તુળ /
રાષ્ટ્રીય ધોરી માર્ગ વર્તુળો / પાટનગર યોજના વર્તુળ સહિત)

સર્વે કાર્યપાલક ઈજનેરશ્રીઓ (ઉપરોક્ત વર્તુળો હેઠળના તમામ વિભાગો સહિત)

નકલ રવાના :-

- ઉદ્યોગ અને ખાણ વિભાગ, સચિવાલય, ગાંધીનગર
- નમૈદા , જળસંપત્તિ , પાણી પુરવઠા અને કલ્પસર વિભાગ,સચિવાલય, ગાંધીનગર
- નિયામકશ્રી, ઈજનેરી સંશોધન સંસ્થા, વડોદરા
- નિયામકશ્રી, એન્જીનીયરીંગ સ્ટાફ કોલેજ, ગાંધીનગર
- મેનેજીંગ ડીરેક્ટરશ્રી, ગુજરાત રાજ્ય બાંધકામ નિગમ લી. ગાંધીનગર
- મેનેજીંગ ડીરેક્ટરશ્રી, ગુજરાત રાજ્ય માર્ગ વિકાસ નિગમ લી, ગાંધીનગર
- સર્વે તાંત્રિક અધિકારીશ્રીઓ (ના.કા.ઈ.સહિત) મા.મ.વિ.વિભાગ,સચિવાલય,
- સર્વે પ્રોજેક્ટ શાખાઓ, મા.મ.વિ.સચિવાલય,
- સીલેક્ટ કાઈલ.

મશીન ક્રશ્ડ સ્ટોન એગ્રીગેટના ફલેકીનેશ
અને ઈલોન્ગેશન ઈન્ડેક્સના સંયુક્ત ધોરણો
અપનાવવા બાબત.

ગુજરાત સરકાર
માર્ગ અને મકાન વિભાગ
પરિપત્ર ક્રમાંક - એસઓઆર. - ૧૦૨૦૦૬ / ૧૦૪ / સ. ૧
સચિવાલય, ગાંધીનગર.
તા. ૨૧/૧/૨૦૦૭

પ્રસ્તાવના :-

'મશીન ક્રશ્ડ સ્ટોન એગ્રીગેટ' એ બાંધકામમાં વપરાતું મુખ્ય મટીરીયલ્સ છે. આ 'મટીરીયલ્સ' માટેના ગુણવત્તાના વિવિધ ધોરણો પૈકીનો એક 'ફલેકીનેશ અને ઈલોન્ગેશન ઈન્ડેક્સ (સંયુક્ત)' છે જે મીનીસ્ટ્રી ઓફ રોડ ટ્રાન્સપોર્ટ એન્ડ હાઈવેઝ (MORT & H) દ્વારા પ્રકાશીત સ્પેશીફિકેશન ફોર રોડ એન્ડ બ્રીજ વર્કની ચોથી આવૃત્તિમાં દર્શાવ્યા અનુસાર ૩૦ % થી વધુ ન હોવો જોઈએ. જ્યારે અગાઉ મીનીસ્ટ્રી ઓફ સરકેઈસ ટ્રાન્સપોર્ટની બીજી આવૃત્તિમાં ફક્ત ફલેકીનેશ ઈન્ડેક્સનું ધોરણ વધુમાં વધુ ૩૫ % સુધીનું હતું. આમ સંશોધનો / અનુભવ તેમજ અર્થતંત્ર મશીનરીની ઉપલબ્ધીનો વ્યાપ / સરળતા તેમજ આર્થિક પાસાઓને ધ્યાને લઈને ગુણવત્તાનાં ધોરણોમાં પણ નવા સુધારા / વધારા કરવામાં આવે છે. અગાઉના ફલેકીનેશ ઈન્ડેક્સના ધોરણોમાં હવે ઈલોન્ગેશન ઈન્ડેક્સ પણ જોડી સંયુક્ત ધોરણ દાખલ કરવામાં આવેલ છે. પરંતુ હાલ ગુજરાત રાજ્યમાં આવેલ ક્રશર યુનિટો પૈકીના મોટા ભાગના યુનિટો પરંપરાગત પધ્ધતિથી કાર્યરત છે. તેમાંથી નવા સંયુક્ત ધોરણો પરિપુર્ણ કરે તેવો ઉત્પાદિત માલ મળી શકતો નથી. જે એક વ્યવહારીક મુશ્કેલી છે. પરંપરાગત પધ્ધતિનાં ક્રશરમાં આ પ્રકારની મુશ્કેલીઓ આવે છે. તે બાબતનો ઉલ્લેખ ટેકનીકલ જર્નલમાં પ્રસિધ્ધ થતા ટેકનીકલ પેપર્સમાં પણ થયેલ છે. આથી સંયુક્ત ધોરણો મેળવવા હાલના ક્રશર યુનિટોમાં સારા એવા પ્રમાણમાં સુધારા વધારા કરવા આવશ્યક બને તેમ છે. જેમાં વધારાનું નાણાંકીય રોકાણ પણ કરવું પડે તેમજ સમય પણ વ્યતિત થાય આથી ફલેકીનેશ તેમજ ઈલોન્ગેશન ઈન્ડેક્સના સંયુક્ત ધોરણોનો અમલ કરવા (ઈજારદારોને) પૂરતો સમય આપવો પણ જરૂરી છે. તે ધ્યાને લઈ નીચે મુજબની સૂચનાઓ આપવામાં આવે છે.

મીનીસ્ટ્રી ઓફ રોડ ટ્રાન્સપોર્ટ એન્ડ હાઈવે દ્વારા સ્પેશીફિકેશન ફોર રોડ એન્ડ બ્રીજ વર્કની સને ૨૦૦૧ ની ચોથી આવૃત્તિ અનુસાર મશીન ક્રશ્ડ સ્ટોન એગ્રીગેટ માટે ફલેકીનેશ તેમજ ઈલોન્ગેશન સંયુક્ત ઈન્ડેક્સની મહત્તમ ૩૦ % ની મર્યાદાનું ધોરણ અપનાવવાનું નક્કી કરવામાં આવેલ છે.

માર્ગ અને મકાન વિભાગ હસ્તક ચાલતા કામોમાં પ્રવર્તમાન સ્પેશીફિકેશન પ્રમાણે ફલેકીનેશ અને ઈલોન્ગેશનના સંયુક્ત ઈન્ડેક્સની મહત્તમ મર્યાદા ૩૦ % રાખવામાં આવે છે.

ગુજરાત રાજ્યમાં મોટા ભાગના ક્રશીંગ યુનિટો ખાનગી માલિકીના છે અને તેમાં જરૂરી યાંત્રિક ફેરફારો કરવામાં આવે તો સંયુક્ત ઈન્ડેક્સના ધારાધોરણો જળવાઈ રહે તેવાં માલ મળી શકે.

ગુજરાત રાજ્યમાં ચાલતા ખાનગી ક્રશીંગ મશીનોમાં જરૂરી યાંત્રિક સુધારા વધારા તા.૩૦/૯/૦૭ સુધીમાં કરવામાં આવે તો જ તા.૧/૧૦/૦૭ પછીથી માર્ગ અને મકાન વિભાગના રસ્તાઓમાં વપરાતા એગ્રીગેટની ગુણવત્તા ધારાધોરણ મુજબની મળી રહે. આથી નીચે મુજબની સુચનાઓ આપવામાં આવે છે.

- (અ) માર્ગ અને મકાન વિભાગમાં ચાલતા કામોના ઈજારદારોએ જે તે ક્રશીંગ યુનિટોમાં જરૂરી યાંત્રિક સુધારા વધારા થઈ ગયેલ છે અને ધારા ધોરણ મુજબની ગુણવત્તાનાં એગ્રીગેટ મળી રહે છે તેવું પ્રમાણપત્ર અધિક્ષક ઈજનેરશ્રી (યાંત્રિક) અમદાવાદ મા.મ. વર્તુળ, અમદાવાદનું હોય તેની પાસેથી જ માલસમાન ખરીદ કરવાનો રહેશે. આ પ્રમાણિત થયેલ ક્રશીંગ યુનિટ સિવાયના કોઈપણ ક્રશર પાસેથી માલસમાન સપ્લાય ન થાય તેની કાળજી લેવાની રહેશે. અધિક્ષક ઈજનેરશ્રી (યાંત્રિક) દ્વારા સર્ટીફાઈડ ન થયેલ ક્રશીંગ યુનિટ પાસેથી આવેલ ધારાધોરણ વગરનો માલસમાન આઉટરાઈટ રીજેક્ટ કરવામાં આવશે.
- (બ) માર્ગ અને મકાન વિભાગના એસ.ઓ.આર. માં તથા અંદાજોમાં એગ્રીગેટના ભાવમાં જરૂરી સુધારા વધારા કરીને તા.૧/૧૦/૦૭ થી અમલમાં લાવવાના રહેશે.
- (ક) દરેક વિભાગીય કચેરીઓએ તેઓના તાબામાં જે જે ઈજારદારોની નોંધણી થયેલ છે તેઓને સદરહુ સુચનાઓ અમલ કરવા માટે લેખિત જાણ કરવાની રહેશે તથા ખાનગી ક્રશીંગ યુનિટોને પણ આની લેખિત જાણ કરવાની રહેશે. સદરહુ સુચનાના અમલ માટે ખાનગી ક્રશર યુનિટો તેમજ ઈજારદારો સાથે દરેક વિભાગીય કચેરીએ એક સંયુક્ત બેઠક કરીને સમજ આપવાની રહેશે જેથી તા.૧/૧૦/૦૭ પછી માર્ગ અને મકાન વિભાગ હસ્તક ચાલતા કોઈપણ કામોમાં ધારા ધોરણ મુજબની ગુણવત્તા સિવાયનો માલસમાન વાપરવામાં ન આવે તેની તકેદારી રાખવાની રહેશે.

ઉપરોક્ત સુચનાઓનો અમલ યુસ્તપણે કરવાનો રહેશે.

(એસ.એ.ભટ્ટ)
ઉપસચિવ મુ.મ.
માર્ગ અને મકાન વિભાગ.

મશીન ક્રશ્ડ સ્ટોન એગ્રીગેટના ફલેક્રીનેશ
અને ઈલોન્ગેશન ઈન્ડેક્સના સંયુક્ત ધોરણો
અપનાવવા બાબત.

ગુજરાત સરકાર
માર્ગ અને મકાન વિભાગ
પરિપત્ર ક્રમાંક - આરજીએન - ૧૦૨૦૦૬ - ૧૦૪ - સ.૧,
સચિવાલય, ગાંધીનગર.
તા. ૧૭/૧૦/૨૦૦૭

સંદર્ભ :- સરખા ક્રમાંકના પરિપત્ર તા.૨૫/૧/૨૦૦૭.

પ્રસ્તાવના :-

ગુજરાત સરકારશ્રીના માર્ગ અને મકાન વિભાગ દ્વારા સંદર્ભીત પરિપત્ર ક્રમાંક : એસ.ઓ.આર. ૧૦૨૦૦૬ / ૧૦૪ / સ.૧, તા.૨૫/૧/૨૦૦૭ થી બાંધકામમાં વપરાતા મશીન ક્રશ્ડ સ્ટોન એગ્રીગેટ માટે ફલેક્રીનેશ તેમજ ઈલોન્ગેશન સંયુક્ત ઈન્ડેક્સની મહત્તમ ૩૦% મર્યાદાનું ધોરણ અપનાવવાનું નક્કી થયેલ હતું. જે માટે ગુજરાત રાજ્યમાં ચાલતા ખાનગી ક્રશીંગ યુનીટોમાં જરૂરી તાંત્રિક સુધારા વધારા તા.૩૦/૯/૨૦૦૭ સુધીમાં કરવા અને તા.૧/૧/૨૦૦૭ પછી થી માર્ગ અને મકાન વિભાગના રસ્તાઓના કામ વપરાતા એગ્રીગેટ ધારા ધોરણ મુજબની ગુણવત્તા વાળો વાપરવામાં આવે તેમ જણાવેલ હતું.

ક્રશર યુનીટોમાં જરૂરી સુધારા વધારા સુચવેલ સમયગાળામાં થઈ શકેલ ન હોવાથી વારંવાર સમય મર્યાદા વધારવા માટેની રજુઆતો થયેલ હતી.

ઉપરોક્ત બાબતે સરકારશ્રી દ્વારા પુખ્ત વિચારણાને અંતે ક્રશીંગ યુનીટોમાં જરૂરી સુધારા વધારા કરવા માટેની અંતિમ તા.૩૦/૯/૨૦૦૭ ને બદલે તા.૩૧/૧૨/૦૮ કરવામાં આવેલ છે.

ઉપરોક્ત સુચનાઓનો અમલ ચુસ્તપણે કરવાનો રહેશે.

(એસ.એ. ભટ્ટ)
ઉપસચિવશ્રી (મુ.મ.)
માર્ગ અને મકાન વિભાગ.

નકલ રવાના :-

- સચિવશ્રી (મા.મ) ના . અંગત સચિવશ્રી, મા.મ. વિભાગ, સચિવાલય, ગાંધીનગર.
- સર્વે મુખ્ય ઈજનેરશ્રીઓ અને અ.સ. શ્રીઓ, મા.મ. વિભાગ, સચિવાલય, ગાંધીનગર.
- સર્વે અધિક્ષક ઈજનેરશ્રીઓ
- સર્વે તાંત્રિક અધિકારીશ્રી, મા.મ. વિભાગ, સચિવાલય, ગાંધીનગર.
- ફાઈલ ક્રમાંક :- એસ.ઓ.આર. / ૧૦૨૦૦૬ / (૧૦૪) / સ.૧ માં રાખવા સારૂ.
- સિલેક્ટ ફાઈલ.

Instruction on implementation of
the building and other Construction
workers Act 1996
and building and other Construction
workers Welfare Cess Act, 1996.

Government of Gujarat
Labour & Employment Department
G.R. No. CWA-2004-841-M3
Sachivalaya, Gandhinagar,
Dated : 30 January 2006.

Read : Labour & Employment Department, Gandhinagar GR.No.CWA-2004-1831-M(3) Dated : 9-12-2005.

RESOLUTION

Building and other construction workers are one of the largest and most vulnerable segments of the unorganized labour. Their work is characterized by by inherent risk to life and limb of the work and also by the casual nature, temporary relationship between employer and employee, uncertain working hours, lack of basic amenities and inadequate welfare facilities.

Government of India has decided to constitute. Welfare boards for such workers in every state and accordingly, the Building and other Construction Workers (Regulation of Employment & conditions of Service) Act, 1996 was enacted by parliament and brought into force from 19th August, 1996. implementation of the Act. Including cess collection has already commenced in Karnataka, tamil nadu and dilhi. Under the side Act. Government of Gujarat has constituted a board under section 18. The stat Government has been powers to make rules for carrying out the provisions of this Act.

Accordingly, Government of Gujarat made Gujarat Building and other Construction Workers (Regulation of Employment and condition of Service) Rules, 2003 and published these Rules vide Notification No.GHR-2003-111-CWA-2000-1869-M(3), dated 18th August, 2003. Government of Gujarat has also constituted the Gujarat Building and other Construction workers Welfare Board vide Notification No. GHR/2004/163/CWA/2004/3743-M(3), dated 18th December, 2004. Secretary (Labour) has been appointed as Chairman.

Government of India has also enacted the Building and other construction workers welfare cess Act. (hereinafter called as cess Act) and brought it in force from 19th August, 1996. the cess Act provided for the levy and collection of cess on the cost of construction incurred by the employers, for increasing the resources of the welfare board. Section 3 of the Cess Act provides that cess shall be levied and collected at a rate not less than 1 % of the cost of construction incurred by an employer. Rule 5 of the Building and other construction worker welfare cess Rules, 1998 reads as fallows :-

- (1) The proceeds of the cess collected under Rule 4 shall be transferred by such Government office, public sector Undertaking, local authority. Or cess collector, to the Board along with the from of Challan prescribed (and in the head of account of the Board) under the accounting provedures of the state, by whatever name they are known.

- (2) Such Government office or public sector undertaking may deduct from the cess collected or claim from the Board, as the case may be, actual collection expenses not exceeding one per cent of the total amount collected.
- (3) The amount collected shall be transferred to the board within thirty days of its collection.

Moreover, under Rule 6, every employer, within thirty days of commencement of his work of payment of cess, as the case may be, has to furnish information in form 1 to the assessing Officer. Under Rule 12, the Assessing Officer, in cases where the employer has pay the cess or has paid less cess, can impose it penalty upto the amount of cess payable.

By Government of Gujarat Notification No. GHR/2005/04/CWA/2004/841/M3, dated 3rd January, 2005, all heads of the department of the Government of Gujarat, all Executive heads of public sector undertaking and all Executive head of local Authorities (except Gram panchayat and Nagar Panchayat) are declared as cess Collectors and Assessing Officers.

The Building and other Construction workers Welfare board has passed the necessary resolution to collect the cess with effect from 18th December, 2004.

According, the cess is payable by Government offices, public sector undertaking, local Authority or cess collector to the board in challan proscribed, in the following head / sub head :

Major Head :- 0230 – Labour and Employment

Minor Head :- 106-Fees under Contract Labour (Regulation and abolition) Rules

Sub Head :- (04)-Income from cess levied under Gujarat Building & other Construction worker's Welfare cess Act, 1996.

Approval of the Finance Department, Government of Gujarat has been taken for meeting the expenditure to be included for the various welfare activities by the Gujarat Building & other construction workers welfare board and the opening of the accounting Head / Sub –Head in file No 2004-1831-M3 on 1st December, 2005 (Copy of Resolution dated 9/12/2005 is enclosed)

All Government, public sector undertaking and local authorities are instruction to pay the above cess as per the Act. All Department Public sector Undertaking and local authorities are also advised to incorporate the 1 % cess in their estimates for all new works.

By order and in the name of Government of Gujarat.

(Vinod Babbar)
Principal Secretary Government
Labour & Employment Department

:: પરિપત્ર ::

“Demand Draft for E.M.D. & Tender fee shall be submitted in electronic format only through online (by Scanning) while uploading the bid. This submission shall mean that EMD & tender fee are received electronically. However for the purpose of realization of D.D. bidder shall send the D.D. in original through R.P.A.D. so as to reach to Executive Engineer, R&B Division, Porbandar within 7 days from the last date of uploading. Penaltrative action for not submitting D.D. in original to E.E. by bidder shall be initiated. D.D. for exemption Certificate is not necessary. However Exemption Certificate shall have to be submitted electronically through online.

Any documents in supporting of tender bid shall be submitted in electronic format only through online (by scanning etc.) & hard copy will not be accepted separately.”

“ટેન્ડર માટે બાનાની રકમ (ઈ.એમ.ડી.) તથા ટેન્ડર ફીના ડીમાન્ડ ડ્રાફ્ટ ઓન લાઈન સ્કેન કરી ઈલેક્ટ્રોનિક ફોરમેટમાં ટેન્ડર અપલોડ કરવાના રહેશે. આ પ્રકારે રજૂ થયેલ વિગતે બાનાની રકમ અને ટેન્ડર મળ.લ ગણવાની રહેશે અને તદઅનુસાર ટેન્ડર ખોલવામાં આવશે તે અનુસાર ઈલેક્ટ્રોનિક ફોરમેટમાં રજીસ્ટ્રેશન, બેંક સોલવંશી, બાનાની રકમ અને ટેન્ડર ફી મળેલ હોય તેની જ ઓફર ખોલવામાં આવશે. ખરેખર ચુકવણા માટે ટેન્ડર ભરનારે ડીમાન્ડ ડ્રાફ્ટ અસલમાં રજીસ્ટર્ડ પોસ્ટ એ.ડી. થી કાર્યપાલક ઈજનેરશ્રી, માર્ગ અને મકાન વિભાગ, પોરબંદર ને અપલોડીંગની છેલ્લી તારીખ થી દિવસ-૭ માં મળે તે અનુસાર રજૂ કરવાનો રહેશે. અસલમાં ડીમાન્ડ ડ્રાફ્ટ નહી મોકલનાર સામે શિક્ષાત્મક પગલા શરૂ કરવામાં આવશે. બાના મુકિત માટે ડીમાન્ડ ડ્રાફ્ટ જરૂરી બનશે નહિ, પરંતુ બાના મુકિત પ્રમાણપત્ર ઈલેક્ટ્રોનિકલી ઓન લાઈન રજૂ કરવાનું રહેશે.”

ટેન્ડર બીડનાં માટે જરૂરી આધાર માટેના કોઈપણ ડોક્યુમેન્ટ ઓન લાઈન ઈલેક્ટ્રોનિક ફોરમેટમાં સ્કેન કરી મોકલવાના રહેશે અને હાડ કોપી અલાયદી રીતે સ્વીકારવામાં આવશે નહિ.

ગુજરાત રાજ્યપાલશ્રીના હુકમથી અને તેમના નામે.

સહી/-
ઉપસચિવ
માર્ગ અને મકાન વિભાગ

ઇ-ટેન્ડરીંગમાં ટેન્ડર ફી અને અન્ય
ડોક્યુમેન્ટસ રજૂ કરવા અંગે.

ગુજરાત સરકાર
માર્ગ અને મકાન વિભાગ,
પરિપત્ર ક્રમાંક :- પરચ - ૧૦૨૦૦૮-૫-સ (પાર્ટફાઇલ)
સચિવાલય, ગાંધીનગર,
તા. ૨૭-૧૧-૨૦૦૮

વંચાણે લીધા :- તા. ૧૮/૧/૦૮ નો પરિપત્ર ક્રમાંક : પરચ - ૧૦૨૦૦૮-૫-સ

પરિપત્ર :-

માર્ગ અને મકાન વિભાગમાં હાલમાં ટેન્ડરો ઇ-ટેન્ડર પધ્ધતિથી સ્વીકારવામાં આવે છે. તે અન્વયે સમાન ક્રમાંકના તા. ૧૮/૧/૦૮ના પરિપત્રમાં ટેન્ડર ફી અને બાનાની રકમ જે તે કાર્યપાલક ઇજનેરને ખરેખર ચુકવવા માટે દિન-૭માં અસલમાં રજીસ્ટર્ડ પોસ્ટ એ.ડી.થી મોકલવાની તેમજ અસલમાં ડીમાન્ડ ડ્રાફ્ટ નહિ મોકલનાર સામે શિક્ષાત્મક પગલા લેવાની જોગવાઈ હતી.

ઉપરોક્ત પરિપત્રમાં નીચે મુજબ અંશતઃ સુધારો કરી આ શરતનો સમાવેશ ટેન્ડર નોટીસ / ટેન્ડરના મુસદ્દામાં Through R.P.A.D. so as to reach to E.E. Division - Within 7 days from the last date of uploading ને બદલે to S.E. at the time of tender opening or send the same through R.P.A.D. so as to reach to E.E. Division - Within 7 days from the last date of opening." સુધારો કરવામાં આવે છે. તેમજ ખરેખર ટેન્ડર ફી તેમજ બાનાની રકમ નિયત સમયમાં ઇજારદાર ન ભરે તો ઇજારદારની નોંધણી એક વર્ષ માટે એબેન્સમાં રાખવાની કાર્યવાહી કરી ઇ-ટેન્ડરીંગ નો કોડ એક વર્ષ માટે રદ કરાશે.

ગુજરાત રાજ્યપાલશ્રીના હુકમથી અને તેમના નામે.

(આર. કે. ચૌહાણ)
ખાસ ફરજ પરના અધિકારી
માર્ગ અને મકાન વિભાગ

ટેન્ડરમાં ભરેલ અસામાન્ય ઉંચા ભાવોના સંદર્ભે કામ પર પડતા ખર્ચ પર નિયંત્રણ રાખવા તથા કામની નાણાકીય પ્રગતિ ભૌતિક પ્રગતિ સાથે સુમેળમાં રહે તે માટે જરૂરી જોગવાઈ કરવા બાબત

ગુજરાત સરકાર
માર્ગ અને મકાન વિભાગ,
પરિપત્ર ક્રમાંક :- પરચ - ૧૦૨૦૦૮-(૬૧)-સ
તા. ૨૭-૧૧-૨૦૦૮

પરિપત્ર :-

ટેન્ડરમાં અસામાન્ય ઉંચા કે નીચા ભાવો ઇજારદારશ્રીઓ દ્વારા ઘણી વાર ભરાતા હોવાનું સરકારશ્રીના ધ્યાન પર આવેલ છે. આવા કિસ્સાઓમાં કામની નાણાકીય પ્રગતિ અને ભૌતિક પ્રગતિનો સુમેળ ન રહેવાની સંભાવના રહેલી છે. આથી કામની ભૌતિક પ્રગતિ પ્રમાણે નાણાકીય પ્રગતિ રહે કે જેથી સરકારશ્રી પર સમય પહેલા અયોગ્ય નાણાકીય બોજ ન પડે તે માટે નીચે મુજબની જોગવાઈ ટેન્ડરમાં કરવાનો નિર્ણય કરવામાં આવેલ છે. આ જોગવાઈ તમામ કામોના આ પરિપત્રની તારીખ પછી મંજૂર થતાં ડી.ટી.પી. માં અચૂક પણ કરવાની રહેશે.

જોગવાઈ :-

જે કોઈ આઈટમનો ભરેલ ભાવ. તે આઈટમના ટેન્ડરમાં મુકેલ અંદાજી ભાવ કરતા ટેન્ડરમાં મુકેલ અંદાજી રકમથી સમગ્ર ટેન્ડર જેટલા ટકા ઉંચુ કે નીચુ મંજૂર થયુ હોય તે ટકાવારીથી ૧૦% થી વધુ ઉંચો રહેતો હોય તેવી આઈટમનું ચકવણું રનીંગ બિલ વદતે જે તે આઈટમના અંદાજી ભાવ + / - મંજૂર ટેન્ડરની ટકાવારી + તે આઈટમના અંદાજી ભાવની ૫% ની મર્યાદામાં કરવામાં આવશે. આ રીતે વીથહેલ્ડ રાખેલ રકમ કામ સંતોષકારક રીતે પુર્ણ થયે ફાઈનલ બિલ મંજૂર કરતી વતખે વ્યાજભારણ વગર છુટી કરવામાં આવશે.

ઉદાહરણ :-

ઉક્ત જોગવાઈની સ્પષ્ટ સમજણ માટે આ સાથે આપેલ ઉદાહરણ ધ્યાને લેવું

૧	ટેન્ડરમાં મુકેલ અંદાજી રકમ	:	રૂ. ૧૦૦/-
૨	મંજૂર થયેલ ટેન્ડરની રકમ	:	રૂ. ૧૧૦/-
૩	ટેન્ડરમાં મુકેલ અંદાજી રકમ સામે ખરેખર મંજૂર થયેલ ટેન્ડરની ટકાવારી	:	૧૦%
૪	ટેન્ડરની એક આઈટમનો ટેન્ડરમાં મુકેલ અંદાજી ભાવ	:	રૂ. ૧૦/-
૫	તે આઈટમનો ભરેલ ભાવ	:	રૂ. ૧૪/-
૬	તે આઈટમમાં ભરેલ ઉંચા ભાવની ટકાવારી	:	૪૦%
૭	તે આઈટમ માટે રનીંગ બિલ વખતે ચુકવવાપાત્ર ભાવ	:	રૂ. ૧૦/- કો. ૩ પ્રમાણ ૧૦% ઉંચા અંદાજી ભાવના ૫% રૂ. ૧૧.૫૦
૮	ફાઈનલ બિલ વખતે વ્યાજ ભારણ વગર ચુકવવાપાત્ર થતો વીથહેલ્ડ રાખેલ ભાવ.	:	રૂ. ૧૪.૦૦-૧૧.૫૦ રૂ. ૨.૫૦

જો સદર આઈટમના ભાવ રૂ. ૧૨.૦૦ કે તેથી નીચો ભરેલ હોત તો રનીંગ બિલમાં ભાવ કપાત આ જોગવાઈ મુજબ કરવાની રહેત નહીં.

(આર. કે. ચૌહાણ)
ખાસ ફરજ પરના અધિકારી
માર્ગ અને મકાન વિભાગ

બાંધકામના મટીરીયલ્સ તેમજ કોમ્પોનેન્ટ્સ સેમ્પલની ગુણવત્તા માટે પરીક્ષણ પૈકીના ૮૦% પરીક્ષણ સ્થળ પર તથા ૧૦% પરીક્ષણ સરકાર માન્ય લેબોરેટરી / ગેરી ધ્વારા તથા ૧૦% ગેરી લેબોરેટરીમાં કરાવવા બાબત

ગુજરાત સરકાર
માર્ગ અને મકાન વિભાગ
પરિપત્ર ક્રમાંક : ૫૨૪/૧૦૨૦૦૭/૨૮/સ
સચિવાલય, ગાંધીનગર
તારીખ : ૩૧/૧૨/૨૦૦૮

પરિપત્ર

બાંધકામના મટીરીયલ્સ તેમજ કોમ્પોનેન્ટ્સના સેમ્પલની ગુણવત્તા માટેના પરીક્ષણ હાલ ગેરી કે સરકાર માન્ય સંસ્થા (લેબોરેટરી) મારફતે કરવામાં આવે છે. કામોની પ્રગતિની સમીક્ષા દરમ્યાન ક્ષેત્રીય અધિકારીઓ તરફથી જાણવા મળેલ છે કે ઉક્ત હયાત પ્રક્રિયામાં ટેસ્ટીંગના પરિણામો વિલંબથી મળે છે, જેમાં સમય પણ ખૂબ વ્યતિત થાય છે. ઇજારદાર એસોસિએશન તરફથી આવી રજૂઆતો મળે છે, આથી આ મુશ્કેલી ધ્યાને લેતા ઇજારદારશ્રી ધ્વારા જે તે કામ માટે સ્થાપવામાં આવતી લેબોરેટરીમાં સ્થળ પર જ પરીક્ષણ કરવામાં આવે તો વિલંબ નિવારી શકાય તે બાબત વિચારણા હેઠળ હતી, પુખ્ત વિચારણાના અંતે નીચે મુજબની નીતિ હાલના તબક્કે અનુસરવા નક્કી કરવામાં આવ્યું છે.

નીચે જણાવેલ પરીક્ષણોમાં પ્રવર્તમાન પધ્ધતિમાં ફેરફાર કરી ફીક્વન્શી અનુસાર જરૂરી પરીક્ષણો પૈકી ૧૦% સરકાર માન્ય લેબોરેટરી / ગેરી તથા ૧૦% ગેરી લેબોરેટરી અને ૮૦% ફીલ્ડ લેબોરેટરી ધ્વારા કરાવવાના રહેશે. પરંતુ ગેરીમાં નીચેના દરેક પૈકી ઓછામાં ઓછું ૧(એક) પરીક્ષણ ગેરી લેબોરેટરીમાં કરવાનું રહેશે તથા ઓછામાં ઓછું એક પરીક્ષણ ગેરી / સરકાર માન્ય લેબોરેટરીમાં કરાવવાનો રહેશે. જેમાં નીચે દર્શાવેલ પરીક્ષણો સ્થળ પર કરવાના રહે છે.

એ	એગ્રીગેટ	(૧) ગ્રેડેશન (૨) ફલેક્રીનેશ અને ઈલોગેશન વેલ્યુ (૩) ઇમ્પેક્ટ વેલ્યુ (૪) વોટર એબસોર્પશન
બી	માટી	(૧) ફિલ્ડ એફડીડી અને એફએમસી (૨) સીવ એનાલીસીસ
સી	રેતી	(૧) ગ્રેડેશન
ડી	ઇટો	(૧) ડાયમેનશન અને ટોલરન્સ ટેસ્ટ (૨) વોટર એબસોર્પશન
ઇ	કોક્રીટ	(૧) નોન ડીસ્ટ્રીક્ટીવ ટેસ્ટ (એલ્ટ્રા સોનીક ટેસ્ટીંગ પધ્ધતિથી) (૨) સ્લમ્પ ટેસ્ટ (૩) કોમ્પ્રેસીવ સ્ટ્રેન્થ
એફ	બીટયુમીનસ મીક્સ	(૧) ડામરની ટકાવારી
જી	ડ્રાય મીક્ષ મટીરીયલ	(૧) ગ્રેડેશન

શરતો :-

- (૧) ઇજારદારે કામની ગુણવત્તા માટે ધારા ધોરણ પ્રમાણેની અને ઉપર જણાવેલ પરિક્ષણો માટે પ્રમાણિત થયેલ જરૂરી તમામ સાધનો સહિતની ફિલ્ડ ટેસ્ટીંગ લેબોરેટરી સ્વ ખર્ચે કામના સ્થળે યોગ્ય જગ્યા ઉપર સ્થાપવાની રહેશે. રસ્તાના કામ માટે લાગુ પડતા પ્લાન્ટના સ્થળને કામનું સ્થળ ગણી શકાય. પરંતુ કામનું સ્થળ લેબોરેટરીથી દૂર હોય તો ઇજારદારશ્રી ધ્વારા મોબાઇલ લેબોરેટરીની જરૂરી વ્યવસ્થા રાખવાની રહેશે.
- (૨) કાર્યપાલક ઇજનેરશ્રી જ્યારે સ્થળ પર તેઓનું ચેકીંગ કરવા જાય ત્યારે ટેસ્ટીંગ તેઓએ તેમની રૂબરૂમાં પણ કરાવવાનું રહેશે.
- (૩) ધારા ધોરણ પ્રમાણેના પરીક્ષણોની સંખ્યા પૈકી ૮૦% પરીક્ષણ ફિલ્ડ લેબોરેટરીમાં ઇજારદારના અધિકૃત ક્વોલીટીકોન્ટ્રોલ ઇજનેર કે જેઓને સંબંધિત કાર્યપાલક ઇજનેરશ્રીએ આઈ-કાર્ડ આપેલ હોય તેમનાં ધ્વારા ખાતાના ના.કા.ઈ./મ.ઈ./અ.મ.ઈ.ની હાજરીમાં જ કરવાના રહેશે અને પરિણામોમાં સંયુક્ત સહીઓ કરવાની રહેશે જ્યારે ૧૦% પરિક્ષણ ગેરી/સરકાર માન્ય લેબોરેટરી (ઓછામાં ઓછું એક પરીક્ષણ) અને ૧૦% ગેરી લેબોરેટરી (ઓછામાં ઓછું એક પરીક્ષણ) મારફતે કરાવવાના રહેશે.
- (૪) કુલ પરિક્ષણોના ૮૦% પરિક્ષણ એક જ સ્થળે એકજ સમયે એકજ તબક્કામાં નહીં કરતાં કામની પ્રગતિ મુજબ જે તબક્કાએ જે તે કામગીરીને અનુરૂપ જે મટીરીયલ્સ વાપરવાનું થતુ હોય તુદાનુસાર શરૂઆતના તબક્કામાં રાખવું વચ્ચેના તબક્કામાં તેમજ આખરી તબક્કામાં કરાવવાનું રહેશે. આમ છતાં આ બાબતે સ્થાનિક કક્ષાએથી ના.કા.ઈ.શ્રીએ જરૂરીયાત મુજબ તબક્કાવાર પરીક્ષણો તકકી કરવાના રહેશે.
- (૫) ગુણવત્તા નિયમન ધારા-ધોરણ પ્રમાણેના બધા જ રજીસ્ટર નિયમિત રીતે નિભાવવાના રહેશે અને તે જે તે સ્થળે લેબોરેટરીમાં ઉપલબ્ધ રહે તેમ રાખવાના રહેશે.
- (૬) જો કોઈ કારણોસર ટેસ્ટીંગના સાધન અપ્રાપ્ય હોય અથવા વસાવવામાં સમય જાય તેમ હોય કે વ્યવહારૂ ન હોય (જેમ કે ઇલેક્ટ્રોમેટ્રિક બેરીંગ) તો આવા પરીક્ષણો ગેરી/સરકાર માન્ય સંસ્થાઓમાં કરાવી શકાશે. અને આ બાબતનો નિર્ણય સંબંધિત કા.ઈ.શ્રી / ના.કા.ઈ.શ્રીએ કરવાનો રહેશે. ગેરીમાં ન થઈ શકે તેવા ટેસ્ટ સરકાર માન્ય લેબોરેટરીમાં કરાવી શકાય.
- (૭) વિભાગના ક્ષેત્રિય તાંત્રિક સ્ટાફ ના.કા.ઈ./મ.ઈ./અ.મ.ઈ.એ તેમજ ઇજારદારના તાંત્રિક સ્ટાફ ધ્વારા ગેરીમાં પરીક્ષણ જાતે કરવાનો સંતોષકારક અનુભવ મેળવી આ બાબતનું ગેરીનું પ્રમાણપત્ર પણ મેળવવાનું રહેશે. જે તે જિલ્લા/પ્રાદેશિક સ્તરે ગેરીની લેબોરેટરીમાં કોર્પ કન્ડક્ટ કરવા માટે જરૂરી ફી જે તે વિભાગના કા.ઈ.શ્રીએ ચુકવવાની રહેશે અને આ કાર્યવાહી સમયબદ્ધ પૂર્ણ થાય તે માટે સંબંધિત અ.ઈ.શ્રીએ આ કામગીરીની વખતોવખત સમીક્ષા કરવાની રહેશે.
- (૮) આ પરિપત્રથી ઉપર જણાવેલા પરીક્ષણો પૈકી ૮૦% પરીક્ષણો ક્ષેત્રિય લેબોરેટરીમાં કરવાનો સમય તા.૧/૧/૨૦૧૦ થી કરવાનો રહેશે.
- (૯) ગેરીમાં ટેસ્ટીંગ કરાવતાં સમયે ગેરીનો ટેસ્ટીંગ ચાર્જ ત્વરીત ભરવાનો રહેશે. જેથી પરીક્ષણના પરીણામો સમયસર મેળવી શકાય.

સહી/-

(આર. કે. ચૌહાણ)

ખાસ ફરજ પરના અધિકારી (વિ.યો.)

માર્ગ અને મકાન વિભાગ

ટેન્ડર ફોર્મ બી-૨ ના કોન્ટ્રાક્ટરોની
માર્ગદર્શન માટે સામાન્ય નિયમો
અને સૂચનોના સૂચન નં.૧૮ માં
સ્પષ્ટતા કરવા બાબત

ગુજરાત સરકાર
માર્ગ અને મકાન વિભાગ
ક્રમાંક:- ટીએનસી-૧૦-૨૦૧૩-(૦૨)-સી
સચિવાલય, ગાંધીનગર
તા. ૧૦-૦૫-૨૦૧૩

સંદર્ભ:- મા.મ.વિભાગના ઠરાવ ક. ટીએનસી-૧૦૯૦-(આઈબી-૨૨)-(૧૦)-સી તા.૨૪-૦૫-૧૯૯૦

આમુખ:-

ઉપરોક્ત વિષય અન્વયે ના સંદર્ભિત ઠરાવ માં સૂચન નં.૧૮ માં "આ કામ માટે
ટેન્ડરો રજીસ્ટર ટપાલ દ્વારા રવાના કરવામાં આવે ત્યારબાદ ટેન્ડર પર સ્વિકારવાની
સૂચિત તારીખથી ૯૦/૧૨૦ દિવસ સુધી ઓફર ખુલ્લી રહેશે." તેમ દર્શાવેલ છે.

હવે ઉદ્યોગ અને ખાણ વિભાગના ઠરાવ નં. એસપીઓ-૧૦૨૦૦૫-૧૪૦૭-સીએચ
તા.૨૨-૧૧-૨૦૦૬ ના સંદર્ભે કામોના ટેન્ડર Online માંગવામાં આવે છે અને ઉપરના
સૂચન નં. ૧૮ માં "ટેન્ડર પર સ્વિકારવાની સૂચિત તારીખથી ૯૦/૧૨૦ દિવસ સુધી
ઓફર ખુલ્લી રહેશે" તેવી જોગવાઈ ના કારણે ટેન્ડર ની વેલીડીટીમાં વિસંગતતા ઉભી
થવા બાબતની ગુજરાત કોન્ટ્રાક્ટર એસોસીએશન ની વિવિધ સ્તરે રજુઆતો મળેલ છે.
આ રજુઆતો પર પુખ્ત વિચારણાને અંતે આ બાબતે નીચે મુજબની સ્પષ્ટતા કરવામાં
આવે છે.

સ્પષ્ટતા

" Online Tender System માં સીગલ કવર સીસ્ટમ વાળા ટેન્ડરોમા ટેન્ડર વેલીડીટી નો
સમય ટેન્ડર ઓનલાઈન ખોલ્યા તારીખથી જ્યારે ટુ કવર બીડ સીસ્ટમમાં ટેન્ડર
વેલીડીટીનો સમય ટેકનીકલ બીડ ખોલ્યા તારીખથી ગણવાનો રહેશે."

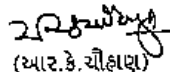
(આર.કે.ચૌહાણ)
ખાસ ફરજ પરના અધિકારી(વિ.વો.)
માર્ગ અને મકાન વિભાગ

ટેન્ડરમાં ભરેલ અસામાન્ય ઊંચા ભાવોના સંદર્ભે કાઠ પર પડતા પ્રાર્થ પર નિયંત્રણ રાખવા તથા કામને નાણાકીય પ્રગતિ સારી સુમેળમાં રહે તે માટે જરૂર જોગવાઈ કરવા બાબત

ગુજરાત સરકાર
માર્ગ અને મકાન વિભાગ
પરિપત્ર ક્રમાંક:- પરચ-૧૦૨૦૦૮-(૬૧)-સી
તા. ૦૩-૦૫-૨૦૧૩

વંચાણે લીધા:- પરિપત્ર ક્રમાંક:- પરચ-૧૦૨૦૦૮-(૬૧)-સી તા. ૨૭-૧૧-૨૦૦૮

સામાન્ય:-

ટેન્ડર માં ઈજારદારશ્રીઓ દ્વારા ભરાતા Imbalanced ભાવો વાળા ટેન્ડરના કિસ્સાઓમાં ઈજારદારશ્રીઓ દ્વારા ઊંચા ભાવની આઈટમોની કામગીરી થયા બાદ નીચા ભાવની આઈટમોની કામગીરી ન કરવામાં આવે તેવી પરિસ્થિતિ પર નિયંત્રણ રાખવા માટે તા. ૨૭-૧૧-૨૦૦૮ નો પરિપત્ર જરૂરી જોગવાઈ સાથે બહાર પાડવામાં આવેલ. આ પરિપત્ર અંગે વિવિધ સ્તરોએ થયેલ રજૂઆતોને ધ્યાને લેતાં અને તેના પર પુખ્ત વિચારણાના અંતે આ પરિપત્રના બીજા ફકરાની છેલ્લી લીટી "આ રીતે વીથહેલ રાખેલ રકમ કામ સંતોષકારક રીતે પૂર્ણ થયે ફર્નલ બીલ મંજૂર કરતી વખતે વ્યાજભારણ વગર છૂટી કરવામાં આવશે" તેની જગ્યાએ નીચે મુજબનો સુધારો કરવામાં આવે છે.

સુધારો:-

"આ રીતે વીથહેલ રાખેલ રકમ અસાધારણ નીચા ભાવ ભરેલ હોય તેવી આઈટમની નાણાકીય પ્રગતિનાં પ્રમાણસર રનીંગ બીલમાંથી છૂટી કરવાની રહેશે. જે કિસ્સામાં અસાધારણ નીચા ભાવ ભરેલ કોઈપણ આઈટમ ન હોય તેવા કિસ્સામાં અસાધારણ ભાવો ભરેલ આઈટમની સામે વીથહેલ રાખેલ રકમ બાકી રહેતી કામગીરી થાય તેના પ્રમાણસર રનીંગ બીલમાંથી છૂટી કરવાની રહેશે."

વધુમાં વંચાણે લીધેલ પરિપત્ર ના ઉદ્દેશ્યમાં દર્શાવેલ ક્રમાંક-૮ રદ કરવામાં આવે છે.

ઉપરોક્ત સુધારાનો અમલ આ પરિપત્રની તારીખ પછી મંજૂર થતા ડી.ટી.પી. માં અચૂકપણે કરવાનો રહેશે.

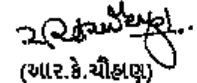

(આર.કે.ચૌહાણ)

ખાસ ફરજ પરના અધિકારી(વિ.ઓ.)
માર્ગ અને મકાન વિભાગ

પ્રતિ,

સર્વે અધિક્ષક ઈજનેરશ્રીઓ, મા.મ. વિભાગ (પાટનગર મોજના વર્તુળ, નેશનલ હાઈવે વર્તુળ, સહિત).
સર્વે અધિક્ષક ઈજનેરશ્રીઓ (પંચાયત) મા.મ. વિભાગ.
સર્વે કાર્યપાલક ઈજનેરશ્રીઓ, મા.મ. વિભાગ.
સર્વે કાર્યપાલક ઈજનેરશ્રીઓ, (પંચાયત), મા.મ. વિભાગ.

નકલ રવાના:-

૧. અગ્ર સચિવશ્રીના અંગત મદદનીશશ્રી, મા.મ. વિભાગ, સચિવાલય, ગાંધીનગર
૨. સર્વે મુખ્ય ઈજનેર અને અ.શ્રીઓ, મા.મ. વિભાગ.
૩. સર્વે તાંત્રિક ઉપ સચિવશ્રીઓ, મા.મ. વિભાગ.
૪. ના.કા.ઈ.શ્રીઓ, મા. મ. વિભાગ.
૫. નાણાં શાખા, મા.મ. વિભાગ.
૬. ના.સે.અ, સી શાખા, મા.મ. વિભાગ., સિલેક્ટ હાઈલ.
૭. શાખા સિલેક્ટ હાઈલ -૨૦૧૩

Modification in Defect Liability
Clause 17 A of Tenders for
Building works

Government of Gujarat
Roads & Buildings Department
Circular No. PRCH-102013-207/2759/N
Sachivalaya, Gandhinagar
Date :- 27-05-2013

Ref :- Circular No. PRCH-102008-(2076) – N Dt. 3-12-2009

R&B Department had issued a circular as referred above where in following provision has been made for building works.

The Defects Liability period shall be as under for original building works:

Three years of elapse of three monsoon periods following date of possession of building taken over by user agency OR Four years of elapse of four monsoon periods following the certified date of completion, Whichever is earlier.

After due considerations on the representations received at various levels from the Gujarat Contractor Associations the above clause is now modified as under

The defects Liability period shall be as under for original building works:

" One year or elapse of one monsoon period from the certified date of completion whichever is greater "

The other conditions in the above said circular will remain as it is.

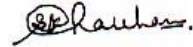

(R.K. Chauhan)

Officer on Special Duty(S.P.)

Road & Buildings Department

To,

All , Superintending Engineers, State,Ahmedabad city,Capital,Project and Panchayat Circles, R & B Department,

All,Executive Engineers under above circles.

Copy To:

1. PA to Principal Secretary(R&B), Sachivalaya, Gandhinagar.
2. All Chief Engineers & Additional Secretaries (R&B), Sachivalaya, Gandhinagar.
3. Select File.

પરફોર્મન્સ બોન્ડ તથા જામીન અનામત પેટે બેંક
ગેરેન્ટી મેળવવા બાબત

ગુજરાત સરકાર

માર્ગ અને મકાન વિભાગ

પરિપત્ર ક્રમાંક: ટી.એન.સી-૧૦-૨૦૧૩-૩૨(ભાગ-૧)-સ

સચિવાલય, ગાંધીનગર

તા.૧૯-૧૧-૨૦૧૩

વંચાણે લીધો પરિપત્ર ક્રમાંક:- ટી.એન.સી-૧૦૯૧/આઈ.બી/૧૦/૧૧/સ તા.૩૧-૩-૧૯૯૯

આમુખ:-

વંચાણે લીધેલ પરિપત્ર મુજબ હાલમાં ૧૫ લાખ કે તેથી વધુ રકમની કામો માં ઈજારદારશ્રી પાસેથી પરફોર્મન્સ બોન્ડ લેવાની જોગવાઈ છે. પરંતુ હવે મોટા ભાગના કામો ૧૫ લાખ થી વધુ રકમના હોય છે અને ચાલુ મરામતના કામો પણ હવે ૧૫ લાખ થી વધુ રકમના હોય છે. આ બાબતે કોન્ટ્રાક્ટસ ઓસોસીએશન તરફથી પણ પરફોર્મન્સ બોન્ડ માટે કામની રકમ ની મર્યાદા વધારવા માટેની રજુઆત કરવામાં આવેલ છે. આથી વહીવટી સરળતા અને અનુકૂળતા જાળવાય તે હેતુસર પરફોર્મન્સ બોન્ડ માટે કામની રકમમાં ફેરફાર કરવાનું સરકારશ્રીની વિચારણા હેઠળ હતું

પરિપત્ર:-

પુખ્ત વિચારણાને અંતે નક્કી થયેલ છે કે હવે ૩.૧૫ લાખ કે તેથી વધુ રકમને બદલે ૩.૩૦ લાખ કે તેથી વધુ રકમ ના સરકારી કામોમાં ઈજારદારશ્રી પાસેથી પરફોર્મન્સ બોન્ડ લેવાના રહેશે.

આ પરિપત્ર વિભાગની સરખા ક્રમાંકની કાંઈલ પરની નોંધ પર નાણાંવિભાગની તા.૨૨-૯-૧૩ ના રોજથી પ્રતોલ સંમતીથી બહાર પાડવામાં આવે છે.

ગુજરાત ના રાજ્યપાલશ્રીના હુકમથી અને તેમના નામે.



(આર.કે.ચૌહાણ)

ખાસ ફરજ પરના અધિકારી(રિ.ચો.)

માર્ગ અને મકાન વિભાગ

બાંધકામના કોન્ટ્રાક્ટર પાસેથી સી.યુ.રી.ટી ડીપોઝીટ
સ્વિકારવાની પ્રથામાં અંશતઃ ફેરફાર કરવા બાબત

ગુજરાત સરકાર
માર્ગ અને મકાન વિભાગ
ઠરાવ ક્રમાંક: ટીએનસી-૧૦-૨૦૧૩-૩-(બાગ-૨)-સી
સચિવાલય, ગાંધીનગર
તા.૨૦-૧૧-૨૦૧૩

વંચાણે લીધો ઠરાવ ક્રમાંક:- ટીએનસી-૧૦૮૮/આઈબી/૧૮/(૧૩)/સ તા.૩૧-૮-૧૯૪

આમુખ:-

કોન્ટ્રાક્ટરોને આપવામાં આવતા કામો માં સીક્યુરીટી ડીપોઝીટ અંગેની હાલની પદ્ધતિ પ્રમાણે એગ્રીમેન્ટ સમયે ૫% પરફોર્મન્સ બોન્ડ બેંક ગેરંટી સ્વરૂપે, ૨.૫% સીક્યુરીટી ડીપોઝીટ નર્મદ બોન્ડ અથવા એન.એસ.એસ. સ્વરૂપે લેવામાં આવે છે તેમજ ૨.૫% રકમ ઈજારદારશ્રીના રનોંગ બીલમાંથી કપાત સ્વરૂપે વસુલ કરવામાં આવે છે. કોન્ટ્રાક્ટર્સ એસોસિએશન દ્વારા નાણાકીય તરલતા હેઠળ તે માટે ૨.૫% લેખે કાપવામાં આવતી સીક્યુરીટી ડીપોઝીટની રકમ બેંક ગેરંટી સામે છુટી કરવાની રજુઆત કરવામાં આવેલ હતી. જે બાબત વિચારણા હેઠળ હતી.

ઠરાવ:-

પુખ્ત વિચારણાને અંતે સરકારી કામોના કોન્ટ્રાક્ટ માટે સીક્યુરીટી ડીપોઝીટ સ્વિકારવાની હાલની પ્રથામાં નીચે મુજબ નો ફેરફાર કરવામાં આવે છે.

૧. હાલમાં પ્રથમ તબક્કે લેવામાં આવતી ૨.૫% સીક્યુરીટીની રકમ જે નર્મદા બોન્ડ/ એન.એસ.એસ. સ્વરૂપે લેવાની જોગવાઈ છે, તે કવે નર્મદા બોન્ડ/ એન.એસ.એસ. તેમજ શીક્વલ બેંકની એફ.ડી.આર. સ્વરૂપે પણ લઈ શકાયો.
૨. રનોંગ બીલમાંથી કપાત થતી ૨.૫% સીક્યુરીટી ડીપોઝીટની રકમ ઈજારદારશ્રી દ્વારા શીક્વલ બેંકની બેંક ગેરંટી રજુ કર્યોથી નીચે જણાવ્યા મુજબ રીલીઝ કરવાની રહેશે.

ક્રમ	નાણાકીય પ્રગતિ	રનોંગ બીલમાંથી ૨.૫% લેખે સીક્યુરીટી ડીપોઝીટ પેટે કાપવામાં આવેલ રકમ માંથી છુટી કરવા પાત્ર રકમ	બેંક ગેરંટીની રકમ
૧	ટેન્ડરની રકમના ૨૫%	રનોંગ બીલમાંથી કાપવામાં આવેલ રકમ અથવા કામની અંદાજિત કિંમતના ૦.૬૨૫%. બેમાંથી જે ઓછી રકમ હોય તે.	રીલીઝ કરવામાં આવેલ રકમ જે લી
૨	ટેન્ડરની રકમના ૫૦%	રનોંગ બીલમાંથી કાપવામાં આવેલ રકમ અથવા કામની અંદાજિત કિંમતના ૧.૨૫%, બેમાંથી જે ઓછી રકમ હોય તે.	રીલીઝ કરવામાં આવેલ રકમ જે લી
૩	ટેન્ડરની રકમના ૭૫%	રનોંગ બીલમાંથી કાપવામાં આવેલ રકમ અથવા કામની અંદાજિત કિંમતના ૧.૮૭૫%, બેમાંથી જે ઓછી રકમ હોય તે.	રીલીઝ કરવામાં આવેલ રકમ જે લી

ઉપરોક્ત બેંક ગેરંટીની મુદત કામ પુર્ણ થવાની ખરેખર તારીખથી છ(છા)માસ વધુ સમયની લેવાની રહેશે તથા ઈજારદારશ્રી પાસેથી બાંહેધરીપત્ર મેળવવાનો રહેશે કે, જે કામ પુર્ણ કરવાની સમયમર્યાદામાં વધારો થશે તો વધારેલ સમયમર્યાદાની તારીખથી ૬ માસ વધુ સમયમર્યાદા વાળી બેંક ગેરંટી નેઓશ્રી દ્વારા પુરી પાડવામાં આવશે.

કામ પુર્ણ થાય ત્યાં સુધી ઈજારદારશ્રી પાસેથી લેવાની થતી ૧૦% સીક્યુરીટી ડીપોઝીટનું પ્રમાણ કોઈપણ સ્વરૂપે જળવાઈ રહે તેની અચૂક કાળજી રાખવાની રહેશે.

આ ઠરાવ વિભાગનો સરખા ક્રમાંકની ફાઇલ પરની નોંધ પર નાણાવિભાગની તા.૬-૧૦-૧૩ ના રોજથી મળેલ સંમતીથી બહાર પાડવામાં આવે છે.

ગુજરાત ના રાજ્યપાલશ્રીના હુકમથી અને તેમના નામે.

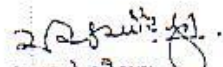
(આર.કે.ચૌહાણ)
પાસ ફરજ પરના અધિકારી(વિ.વો.)
માર્ગ અને મકાન વિભાગ

સ્પષ્ટતા કરતા જણાવવાનું કે, ટેન્ડર કલોઝ નં. પલ્એની મુળ જોગવાઈ જે પ્રથમ ત્રણ પંક્તિમાં જણાવેલ છે તેમાં સ્પષ્ટ જણાવેલ છે કે, ".....SHALL BE ADJUSTED FOR INCREASE OR DECREASE IN THE RATES OF THESE MATERIALS AS UNDER" આમ આ કલોઝની આ જોગવાઈ હેઠળ જ આગળની કાર્યવાહી તે પ્રમાણે કરવાની થાય છે.

આમ, ઉપરોક્ત બાબતે સર્વે કાર્યપાલક ઈજનેરશ્રી તેમજ એકાઉન્ટન્ટશ્રીઓનું ધ્યાન દોરવું જરૂરી છે અને આવા વસુલાતપાત્ર કિસ્સામાં વસુલાત કરવામાં આવે તે બાબતે ધ્યાન આપવા તાકીદ કરવામાં આવે છે. જો આમ કરવામાં ચુક થશે તો સંબંધિત નાયબ કાર્યપાલક ઈજનેરશ્રી, કાર્યપાલક ઈજનેરશ્રી, વિભાગીય સિસાબનીશ / અધિકારીની સીધી જવાબદારી રહેશે.

સદર બાબતે સર્વે અધિક્ષક ઈજનેરશ્રીઓને સુચના આપવામાં આવે છે કે, તેઓના હસ્તકના વિભાગોમાંથી આ પ્રકારના કામો જુદા તારવી તેમાં વસુલાત કરવામાં આવી છે કે નહીં તે બાબતે યોગ્ય ચકાસણી કરી લેવી અને જો વસુલાત કરવામાં ના આવી હોય તો તે અંગે ત્વરિત જરૂરી વસુલાત કરવા જરૂરી સુચના સંબંધિત કાર્યપાલક ઈજનેરશ્રીને આપવી.

(અન.જી. પરમાર)
ખાસ ફરજ પરના અધિકારી (વિ.યો.)
માર્ગ અને મકાન વિભાગ

S.E. RAJKOT
R & B Circle No. II

INWARD 306
DATE: 3/3

મકાનો તથા પુલોના આર.સી.સી. કામોમાં લોખંડના સળીયાના માપો લખવા તથા ચૂકવણામાં લેપ લેન્ય ની લંબાઈ ગણતરીમાં નહીં લવા બાબત

ગુજરાત સરકાર
માર્ગ અને મકાન વિભાગ
સચિવાલય, ગાંધીનગર
પરિપત્ર ક્રમાંક:- PDW-10-2017-01-C
તા.૧૫-૦૨-૨૦૧૭

પરિપત્ર:-

મકાન, રસ્તા અને પુલોના કામોમાં આર.સી.સી. આઇટમોમાં સમાવિષ્ટ સ્ટીલ રેઇનફોર્સમેન્ટના માપો લખવા અને ચૂકવણા દરમ્યાન લેપની લંબાઈ ગણતરીમાં લેવામાં આવે છે. રેઇનફોર્સમેન્ટમાં લેપની વધુ સંખ્યાને પ્રોત્સાહન ન આપતા સળંગ રેઇનફોર્સમેન્ટ (સળીયા) જ મહદઅંશે વપરાય એ તાંત્રિક રીતે વધુ યોગ્ય છે.

MORT&H સ્પેશીફિકેશનના પ્રવર્તમાન ધારાધોરણ મુજબ રેઇનફોર્સ (સળીયા)ના ચૂકવણામાં લેપની લંબાઈના માપો ગણતરીમાં લેવામાં આવતા નથી. (Section 1608)

MORT&H સ્પેશીફિકેશનના પ્રવર્તમાન ધારાધોરણ મુજબ માર્ગ અને મકાન વિભાગ હેઠળ મકાન, રસ્તા અને પુલના રેઇનફોર્સ (સળીયા)ના સ્પેશીફિકેશનમાં Mode of Measurement & Payment માં હવે પછી નીચે મુજબના ફેરફાર કરવા આથી સુચના આપવામાં આવે છે.

<u>EXISTING ITEM</u>	<u>PROPOSED AMENDMENT</u> (As per MORT&H Specification Item No.1608)
<p><u>મકાનના સ્પેશીફિકેશન</u></p> <p>5.4.10 Providing an Mild Steel reinforcement for R.C.C. work including bending binding and placing in position etc. complete up to floor two level.</p> <p>5.4.11 High yield deform bars steel reinforcement for R.C.C. work including bending, binding and placing in position complete up to floor two level.</p> <p>3.2 Reinforcement shall be measured in length including overlaps, separately for different diameters as actually used in the work. Where welding or coupling is resorted to in place lap joints, such</p>	<p><u>મકાનના સ્પેશીફિકેશન</u></p> <p>5.4.10 Providing an Mild Steel reinforcement for R.C.C. work including bending binding and placing in position etc. complete up to floor two level.</p> <p>5.4.11 High yield deform bars steel reinforcement for R.C.C. work including bending, binding and placing in position complete up to floor two level.</p> <p>3.2 Reinforcement shall be measured in length including hooks, if any, separately for differnent diameters as actually used in work, excluding overlaps. From the length so</p>

Ext. DTP ની
Incompletable
BY
E

2

<p>joints shall be measured for payment as equivalent length of overlap as per design requirement. From the length so measured, the weight of reinforcement shall be calculated in tones on the same basis of as per M-18 even though steel is supplied to the contractor by the department on actual weight. Length shall include hooks at the ends Wastage and annealed steel wire for binding shall not be measured and the cost of these items shall be deemed to be included in the rate for reinforcement.</p>	<p><i>measured, the weight of reinforcement shall be calculated in tonnes on the basis of IS: 1732. Wastage, overlaps, couplings, welded joints, spacer bars, chairs, stays, hangers and annealed steel wire or other methods for binding and placing shall not be measured and cost of these items shall be deemed to be included in the rates for reinforcement.</i></p>
<p><u>EXISTING ITEM</u></p>	<p><u>PROPOSED AMENDMENT</u> (As per MORT&H Specification Item No.1608)</p>
<p><u>रस्ताला स्पेशलीकेशन</u> Item No. 39 : Providing steel reinforcement. a) Providing and placing in position mild steel bar reinforcement including cutting, bending, hooking and tying complete as per details. b) High yield strength deformed bars reinforcement. (10) Reinforcement shall be measured in length separely for different diameters as actually used in the work, from the length so measured the weight of reinforcement shall be calculated in tones on the same basis of IS : 1732 even though steel is supplied to the contractor by the Department on actual wieghment. Length shall ilcude hooks at ends. Wastage and annealed steel wire for binding shall not be measured and cost of thes items shall be deemed to be</p>	<p><u>रस्ताला स्पेशलीकेशन</u> Item No. 39 : Providing steel reinforcement. a) Providing and placing in position mild steel bar reinforcement including cutting, bending, hooking and tying complete as per details. b) High yield strength deformed bars reinforcement. (10) Reinforcement shall be measured in length including hooks, if any, separately for differencnt diameters as actually used in work, excluding overlaps. From the length so measured, the weight of reinforcement shall be calculated in tonnes on the basis of IS: 1732. Wastage, overlaps, couplings, welded joints, spacer bars, chairs, stays, hangers and annealed steel wire or</p>

3

included in the rates for reinforcement.	<i>other methods for binding and placing shall not be measured and cost of these items shall be deemed to be included in the rates for reinforcement.</i>
<p><u>પુલના સ્પેશીફિકેશન</u> Item: 21 –Providing (A) Mild Steel Reinforcement (B) High Yield Strength Deformed bars, reinforcements. (10) Reinforcement shall be measured in length including overlaps, separately for different diameter, as actually used in the work, where welding or coupling is restored to, in place of lap-joints, such joints shall be measured for payment as the equivalent length of over lap as per design requirement. From the length so measured the weight of reinforcement shall be calculated in tones on the same basis of IS 1732 even though steel is supplied to the contractor by the Department on actual weight. Length shall include hooks at ends. Wastage and annealed steel wire for binding shall not be measured and cost of these items shall be deemed to be included in the rates for reinforcement.</p>	<p><u>પુલના સ્પેશીફિકેશન</u> Item: 21 –Providing (A) Mild Steel Reinforcement (B) High Yield Strength Deformed bars, reinforcements. (10) Reinforcement shall be measured in length including hooks, if any, separately for different diameters as actually used in work, excluding overlaps. From the length so measured, the weight of reinforcement shall be calculated in tonnes on the basis of IS: 1732. Wastage, overlaps, couplings, welded joints, spacer bars, chairs, stays, hangers and annealed steel wire or other methods for binding and placing shall not be measured and cost of these items shall be deemed to be included in the rates for reinforcement.</p>

aydun
(એન. જી. પરમાર)
ખાસ ફરજ પરના અધિકારી (વિ.યો.)
માર્ગ અને મકાન વિભાગ

વિભાગીય અધિકારી
જાણીતા માર્ગ વિભાગ
સરકાર

માર્ગ અને મકાન વિભાગના કામોમાં ડીફેક્ટ
લાયેબીલીટી પીરીયડમાં ફેરફાર કરવા બાબત

ગુજરાત સરકાર
માર્ગ અને મકાન વિભાગ
ઠરાવ ક્રમાંક: ટીએનસી/૧૦/૨૦૧૬/કલોઝ-૧૭ એ/સુધારો/(૧)/સ
સરદાર ભવન, બ્લોક નં.૧૪
સચિવાલય, ગાંધીનગર
તા.૧૨/૦૫/૨૦૧૬

સંદર્ભ:- માર્ગ અને મકાન વિભાગના કામો માટે નિયત કરેલ ટેન્ડર ફોર્મ બી-૧ અને બી-૨ ના કલોઝ-૧૭ એ માંની
જોગવાઈ

આમુખ:-

ગુજરાત સરકાર માર્ગ અને મકાન વિભાગ દ્વારા હાથ ધરવામાં આવતા કામો માટે નિયત કરેલ ટેન્ડર ફોર્મ
બી-૧ અને બી-૨ નો ઉપયોગ કરવામાં આવે છે. આ કામોમાં ડીફેક્ટ લાયેબીલીટી પીરીયડ માટે નિયત કરેલ ટેન્ડર
ફોર્મ બી-૧ અને બી-૨ ના કલોઝ-૧૭ એ મુજબની કાર્યવાહી કરવામાં આવે છે. આ ડીફેક્ટ લાયેબીલીટી પીરીયડની
જોગવાઈઓમાં ફેરફાર કરવાની બાબત સરકારશ્રીની સક્રિય વિચારણા હેઠળ હતી.

ઠરાવ:-

ઉપરોક્ત બાબતે પુખ્ત વિચારણાના અંતે માર્ગ અને મકાન વિભાગના કામો માટે નિયત કરેલ ટેન્ડર ફોર્મ
બી-૧ અને બી-૨ માંના ડીફેક્ટ લાયેબીલીટી પીરીયડ અંગેના કલોઝ-૧૭ એ માંની જોગવાઈઓમાં નીચે મુજબનો
ફેરફાર કરવામાં આવે છે.

Clause	Existing Provision	Modified Provision
17 A (b)	For all works costing more than Rs.50,000/- and up to Rs.1 crore (amount put to tender), period shall be 6 months from the certified date of completion or one monsoon, whichever is later.	For all works costing more than Rs.50,000/- and up to Rs.1 crore (amount put to tender), period shall be 12 months from the certified date of completion or one monsoon, whichever is later.
17 A (c)	For major projects costing more than Rs. 1 crore , period shall be 12 months from the certified date of completion which should include one monsoon	For major projects costing more than Rs. 1 crore, (amount put to tender) , period shall be 36 months (thirty six) from the certified date of completion or three monsoons, whichever is later.

ઉપરોક્ત ઠરાવ સરખા ક્રમાંકની ફાઇલ પરની નોંધમાં માનનીય મંત્રીશ્રી (મા.મ.)ની તા.૧૦/૦૫/૨૦૧૬ના
રોજ મંજૂરી મેળવી બહાર પાડવામાં આવેલ છે. આ ઠરાવના ઇચ્છુ તારીખથી ઉપરોક્ત સુધારેલ જોગવાઈઓનો
ચુસ્તપણે અમલ કરવાનો રહેશે.

ગુજરાતના રાજ્યપાલશ્રીના હુકમથી અને તેમના નામે,

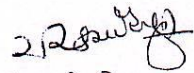
(આર.કે.ચૌહાણ)
ખાસ ફરજ પરના અધિકારી (વિ.ચો.)
માર્ગ અને મકાન વિભાગ
ગાંધીનગર

**INVITATION OF TENDER ON PERCENTAGE
RATE (B-1) TENDER CONTRACT FORM**

Government of Gujarat
Road & Buildings Department
No.TNC-1088-D-347-(7)-C
Schivalaya, Gandhinagar
Date:- 11/07/2017

Reference:-

1. R & B Department Resolution No.CON-1269-PAC-(52)-C, Dated 05/06/1985
2. R & B Department Resolution No.TNC-1088-D-347-(7)-C dated 22/04/1988
3. R & B Department Resolution No. TNC-1088-D-347-(7)-C dated 05/08/1988
4. R & B Department Resolution No. TNC-1088-D-347-(7)-C dated 15/12/2003

RESOLUTION

1. The question of raising monetary limit for B-1 tender form from Rs.50.00 lakhs (Rupees Fifty Lakhs only) was under consideration of Government. Government is pleased to order that the monetary limit of Rs.50.00 lakhs (Rupees Fifty Lakhs only) for B-1 tender form (fixed under aforesaid G.R. dated 15/12/2003) is hereby enhanced to Rs.12.00 Crore (Rupees Twelve Crore only) for Road works, and Rs.10.00 Crore (Rupees Ten Crore only) for Bridge and Building works. This enhanced monetary limit shall be applicable to the tenders to be invited hereafter with the strict application of a condition that tenders for the works amount put to tender upto Rs.12.00 Crore (Rupees Twelve Crore only) for Road works, and Rs.10.00 Crore (Rupees Ten Crore only) for Bridge and Building works should invariably be invited on B-1 tender form only.
2. Other safeguards and instructions in the G.Rs. mentioned in reference should be strictly followed.
3. These orders are issued with the concurrence of Finance Department dated 27/06/2017 on this Department's file No. TNC-102013-731236-04-C

By order and in the name of the Governor of Gujarat,

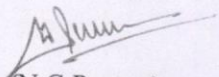
(N.G.Parmar)
Officer on Special Duty (S.P)
R&B Department
Gandhinagar

ટેન્ડરમાં જથ્થાવધારા તથા
જથ્થાવધારાના ભાવના માપદંડમાં
સુધારણા કરવા બાબત

ગુજરાત સરકાર
માર્ગ અને મકાન વિભાગ
બ્લોક નં.૧૪/૨, સરદાર ભવન,
સચિવાલય, ગાંધીનગર
ઠરાવ ક્રમાંક: TNC-10-2017-01-C
તા.૧૧/૦૭/૨૦૧૭

ઠરાવ

ટેન્ડરમાં જથ્થાવધારા તથા જથ્થાવધારાના ભાવના માપદંડ બાબતે બી-૧ અને બી-૨ ટેન્ડરના કલોઝ-૧૪.૨ માં જણાવ્યા મુજબ જથ્થાવધારા માટે ૩૦ ટકા સુધીનો જથ્થો ટેન્ડરના ભાવથી અને ૩૦ ટકાથી વધુ જથ્થામાં વધારો હોય તો જે તે વર્ષમાં કામગીરી કરેલ હોય તે વર્ષના એસ.ઓ.આર.થી કરવાની જોગવાઈ છે.

સદરહુ જોગવાઈમાં સુધારણા કરવા બાબતે સરકારશ્રીમાં ઘણા લાંબા સમયથી વિચારણા હેઠળ હતું. જે અન્વયે નીચે મુજબનો સુધારો કરવામાં આવે છે.

EXISTING CLAUSE	AMENDMENT
Form B-1 Clause- 14.2 Form B-2 Clause- 14.2 Except that when the quantity of any item exceeds the quantity as in the tender by more than 30% the contractor will be paid for the quantity in excess of 30% at the rate entered in the SOR of the year during which the excess in quantity is first executed and for the material consumed in excess quantity the rate for the material to be charged would be basic rate taken into account for fixing the rate for the SOR above instead of the rate stipulated in Schedule-A.	Form B-1 Clause- 14.2 Form B-2 Clause- 14.2 Except that when the quantity of any item exceeds the quantity as in the tender by more than 10% the contractor will be paid for the quantity in excess of 10% at the rate entered in the SOR of the year during which the excess in quantity is first executed or tender rate whichever is less.

ઉપરોક્ત તમામ સુચનાનો અમલ ચુસ્તપણે તાત્કાલિક અસરથી કરવાનો રહેશે.

ગુજરાત રાજ્યના રાજ્યપાલશ્રીના હુકમથી અને તેમના નામે,

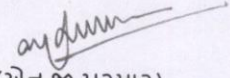
(એન.જી.પરમાર)

ખાસ ફરજ પરના અધિકારી (વિ.યો.)
માર્ગ અને મકાન વિભાગ
ગાંધીનગર

**STANDARDS FOR CEMENT
CONSUMPTION FOR DIFFERENT
ITEMS OF WORK**

Government of Gujarat
Roads & Building Department,
Circular No. PRC/10/2017/Cement Consumption/16/C
14, Sardar Bhavan, 2nd Floor,
Sachivalaya, Gandhinagar
Date:- 11/05/2017

Read:- Government of Gujarat, Road & Building Department, Sachivalaya, Gandhinagar Circular No. SOR/1085/7/H(1) dated 08/12/1986.

CIRCULAR

The uniform rate of cement consumption for various item was prepared and circulated vide No. SOR/1085/7/H(1) dated 08/12/1986.

At the outset, current practice of estimating cement consumption in concrete item of various Building, Bridge and Road project is based on above circular. However, it is generally observed that the cement consumption derived by actual mix design is lower than the standard cement consumption. Some of provision of the said circular become obsolete due to subsequent revisions in the relevant IS code and IRC code. The maximum cement consumption as per IS : 456-2000 and IRC : 112-2011 is 450 Kg./m³. Also cement industry and aggregate crushing industry have involved better quality of cement and aggregate over the years which have far reaching impact on mix design of the present day concrete.

Mix design report of GERI reflecting entire Gujarat region have been considered in averaging the cement consumption in various grade of design mix concrete. To minimize the difference between standard cement consumption of cement and actual consumption derived by mix design by GERI and the cement consumption as per provision of IS and IRC code falling cement consumption is proposed for estimation purpose.

Looking the above facts, the cement consumption mentioned in circular vide No. SOR/1085/7/H(1) dated 08/12/1986 is required to modify as per below:

EXISTING ITEM			AMENDMENT		
Item	Unit	Quantity of cement to be used per unit quantity of work in Kg	Item	Unit	Quantity of cement to be used per unit quantity of work in Kg.
Building, Road & Bridge Items					
Providing & casting in situ ordinary cement concrete M75 for PCC work	Cu.m.	160	Providing & casting in situ ordinary cement concrete M7.5 for PCC work	Cu.m.	160
Providing & casting in situ ordinary cement concrete M100 for PCC work	Cu.m.	220	Providing & casting in situ ordinary cement concrete M10 for PCC work	Cu.m.	220
Providing & casting in situ ordinary cement concrete M150 for PCC work	Cu.m.	320	Providing & casting in situ ordinary cement concrete M15 for PCC work	Cu.m.	290
Providing and casting situ control cement concrete M200 for RCC work	Cu.m.	400	Providing and casting situ control cement concrete M20 for RCC work	Cu.m.	360
Providing and casting situ control cement concrete M250 for RCC work	Cu.m.	450	Providing and casting situ control cement concrete M25 for RCC work	Cu.m.	380
Providing and casting situ control cement concrete M350 for RCC work	Cu.m.	500	Providing and casting situ control cement concrete M35 for RCC work	Cu.m.	425
Providing and casting situ control cement concrete M400 for RCC work	Cu.m.	525	Providing and casting situ control cement concrete M40 for RCC work	Cu.m.	440
Providing and casting situ control cement concrete M450 for RCC work	Cu.m.	540	Providing and casting situ control cement concrete M45 for RCC work	Cu.m.	450
New Item					
-	-	-	Providing and casting situ control cement concrete M30 for RCC work	Cu.m.	410

The cement consumption of other than above concrete item and other details mentioned in circular vide No. SOR/1085/7/H(1) dated 08/12/1986 will be remain same.

(N.G. Parmar)
Officer on Special Duty (S.P.)
R&B Department
Gandhinagar

To,

- 1) The Personal Secretary, Office of the Secretary, Road & Building Department, Sachivalaya, Gandhinagar
- 2) The Personal Secretary, Office of the Secretary, Narmada, Water Resources, Water Supply and Kalpsar Department, Sachivalaya, Gandhinagar
- 3) The Personal Secretary, Office of the Principal Secretary, Health & Family Welfare Department, Sachivalaya, Gandhinagar
- 4) The Personal Secretary, Office of the Additional Chief Secretary, Urban Development and Urban Housing Department, Sachivalaya, Gandhinagar
- 5) The Personal Secretary, Office of the Principal Secretary, Panchayat, Rural Housing and Rural Development Department, Sachivalaya, Gandhinagar
- 6) Accountant General, Rajkot/Ahmedabad
- 7) All the Chief Engineers, Road & Building Department, Sachivalaya, Gandhinagar
- 8) All the Chief Engineers, Narmada, Water Resources, Water Supply and Kalpsar Department, Sachivalaya, Gandhinagar
- 9) The Managing Director, Gujarat State Road Development Corporation, Nirman Bhavan, Gandhinagar
- 10) The Chief Engineer & Director, Staff Training College, Gandhinagar
- 11) The Director, Gujarat Engineering Research Institute (GERI), Vadodara
- 12) The Under Secretary, Gujarat Vigilance Commission, Vigilance Bhavan, Gandhinagar
- 13) All the Superintending Engineers, Road & Building Department (State, Panchayat, National Highway, Capital Project Circle, Electric Circle)
- 14) All the Executive Engineers, (as above circles)
- 15) All Technical Officers, Road & Building Department, Sachivalaya, Gandhinagar
- 16) All Technical Branches, Road & Building Department, Sachivalaya, Gandhinagar
- 17) President, Gujarat Contractors Association, Gajjana Hall, Law Garden, Law College Road, Ahmedabad
- 18) Branch Select file-2017.

રસ્તા, પુલો અને મકાનોની ગુણવત્તા
ચકાસણી માટેના નિયતપત્રકોનો ઉપયોગ
ઇન્સ્પેક્શન નોંધ માટે કરવા બાબત

ગુજરાત સરકાર
માર્ગ અને મકાન વિભાગ
બ્લોક નં.૧૪/૨, સરદાર ભવન,
સચિવાલય, ગાંધીનગર
ક્રમાંક: PRC-10-2017-31-C
તા.૨૬/૦૫/૨૦૧૭

પરિપત્ર

માર્ગ અને મકાન વિભાગના રસ્તા, પુલ અને મકાનના કામો ઇજારદારશ્રી મારફત કરાવવામાં આવે છે. આ કામોની ગુણવત્તા ચકાસણી કરવાનું કામ ગુણવત્તા નિયમન (મા.મ.) વિભાગ દ્વારા કરવામાં આવે છે. કામોની ચકાસણી માટે ગુણવત્તા નિયમન (મા.મ.) વિભાગ હેઠળ ગુજરાત રાજ્યમાં કુલ-૬ (છ) કાર્યપાલક ઇજનેરશ્રીઓની નિમણૂક કરવામાં આવેલ છે. કામોની ગુણવત્તા ચકાસણી કરી તેનો સ્થળસ્થિતિ મુજબનો ઇન્સ્પેક્શન રીપોર્ટ કાર્યપાલક ઇજનેરશ્રી દ્વારા તૈયાર કરી જે તે સંબંધિત કાર્યપાલક ઇજનેરશ્રીને પૂર્તતા અર્થે સાદર કરવામાં આવે છે અને એની જાણ જે તે વિભાગના સંબંધિત અધિક્ષક ઇજનેરશ્રી અને મુખ્ય ઇજનેરશ્રીને કરવામાં આવે છે. ગુણવત્તા નિયમનના કાર્યપાલક ઇજનેરશ્રીઓ દ્વારા રજુ કરવામાં આવતા ઇન્સ્પેક્શન રીપોર્ટની વિગતોમાં એકસરખા ફોર્મેટ વિભાગ દ્વારા નિયત કરેલ ન હોવાથી એકસૂત્રતા રહેતી નથી.

મુખ્ય ઇજનેરશ્રીઓની કમિટીમાં નક્કી થયા મુજબ ઇન્સ્પેક્શન રીપોર્ટમાં એકસૂત્રતા રહે અને પી.એમ.જી.એસ.વાય.માં “ગ્રેડ સિસ્ટમ” વાળો રીપોર્ટ સાદર કરવામાં આવે છે એ પદ્ધતિએ ઇન્સ્પેક્શન રીપોર્ટનું ફોર્મેટ બનાવવા જણાવવામાં આવેલ હતું. માર્ગ અને મકાન વિભાગના રસ્તા, પુલ અને મકાન માટેના ગુણવત્તા ચકાસણી કરવા માટેના ઇન્સ્પેક્શન રીપોર્ટના ફોર્મેટ ગ્રેડ સિસ્ટમવાળા આ સાથે તૈયાર કરવામાં આવેલ છે. હવે પછી ગુણવત્તા વિભાગના મુખ્ય ઇજનેરશ્રી, અધિક્ષક ઇજનેરશ્રી, કાર્યપાલક ઇજનેરશ્રી, સંબંધિત અધિક્ષક ઇજનેરશ્રી તથા જે કોઈ પણ અધિકારીશ્રી ગુણવત્તા ચકાસણીની કામગીરી કરે તેમણે આ ફોર્મેટનો ઇન્સ્પેક્શન રીપોર્ટ માટે ઉપયોગ કરવાનો રહેશે.

કામની ચકાસણી કર્યા બાદ કામનો એકંદરે ગ્રેડ “S (Satisfactory), SRI (Satisfactory but require improvement) કે U (Unsatisfactory)” આપવાનો રહેશે.

(૧) જો ગુણવત્તા ચકાસણીમાં કામનો એકંદરે ગ્રેડ “S” મળશે તો એ કામ Satisfactory કક્ષાનું હોય કોઈ પૂર્તતા કરવાની રહેતી નથી.

(ર) જો ગુણવત્તા ચકાસણીમાં કામની એકંદરે ગ્રેડ "SRI" (Satisfactory but require improvement) મળશે તો જે તે આઇટમમાં "SRI U" ગ્રેડ મળેલ છે એ આઇટમની સુધારણા ટેન્ડરમાં જણાવેલ સ્પેશીકીકેશન મુજબ કરી એનો "ATR" (Action Taken Report) સંબંધિત કાર્યપાલક ઇજનેરશ્રીએ તૈયાર કરી જે તે ગુણવત્તા નિયમન વિભાગના કાર્યપાલક ઇજનેરશ્રીની કરીથી સ્થળ મુલાકાત કરાવશે અને ગુણવત્તા નિયમન વિભાગના કાર્યપાલક ઇજનેરશ્રી પૂર્તતા સાથે સહમત હોય તો અહેવાલ અધિક્ષક ઇજનેરશ્રી, ગુણવત્તા નિયમન વિભાગને સાદર કરશે. અધિક્ષક ઇજનેરશ્રી, ગુણવત્તા નિયમન વિભાગ પૂર્તતા અહેવાલ યોગ્ય હશે તો રીગ્રેડ એટલે "SRI U" માંથી "S" માટે ભલામણ કરશે. ત્યારબાદ સદરહુ પૂર્તતા અહેવાલ સંબંધિત અધિક્ષક ઇજનેરશ્રી મારફત સંબંધિત મુખ્ય ઇજનેરશ્રીને સાદર કરવાનો રહેશે. સંબંધિત મુખ્ય ઇજનેરશ્રીએ સદરહુ "ATR" મુખ્ય ઇજનેરશ્રી ગુણવત્તા નિયમન વિભાગને પૂર્તતા ગ્રાહ્ય રાખી "S" ગ્રેડીંગ આપવા માટે ભલામણ સદર કરવાનો રહેશે. ગુણવત્તા નિયમન વિભાગમાંથી પૂર્તતા ગ્રાહ્ય રાખી "S" ગ્રેડીંગનું પ્રમાણપત્ર મુખ્ય બાદ જ આ આઇટમનું બાકીનું ચૂકવણ કરવાનું રહેશે.

(૩) ગુણવત્તા ચકાસણીમાં કામની એકંદરે ગ્રેડ "U" (unsatisfactory) મળશે તો જે તે આઇટમમાં "SRI U" મળેલ છે એ આઇટમમાં સુધારણા અથવા Reconstruction (આઇટમ કરીથી કરવી) ટેન્ડરમાં જણાવેલ સ્પેશીકીકેશન મુજબ કરી એનો "ATR" સંબંધિત કાર્યપાલક ઇજનેરશ્રીએ તૈયાર કરી જે તે ગુણવત્તા નિયમન વિભાગના કાર્યપાલક ઇજનેરશ્રીની કરીથી સ્થળ મુલાકાત કરાવશે અને ગુણવત્તા નિયમન વિભાગના કાર્યપાલક ઇજનેરશ્રી પૂર્તતા સાથે સહમત હોય તો અહેવાલ અધિક્ષક ઇજનેરશ્રી, ગુણવત્તા નિયમન વિભાગને સાદર કરશે. અધિક્ષક ઇજનેરશ્રી, ગુણવત્તા નિયમન વિભાગ પૂર્તતા અહેવાલ યોગ્ય હશે તો રીગ્રેડ એટલે "SRI U" માંથી "S" માટે ભલામણ કરશે. ત્યારબાદ સદરહુ પૂર્તતા અહેવાલ સંબંધિત અધિક્ષક ઇજનેરશ્રી મારફત સંબંધિત મુખ્ય ઇજનેરશ્રીને સાદર કરવાનો રહેશે. સંબંધિત મુખ્ય ઇજનેરશ્રીએ સદરહુ "ATR" મુખ્ય ઇજનેરશ્રી ગુણવત્તા નિયમન વિભાગને પૂર્તતા ગ્રાહ્ય રાખી "S" ગ્રેડીંગ આપવા માટે ભલામણ સદર કરવાનો રહેશે. ગુણવત્તા નિયમન વિભાગમાંથી પૂર્તતા ગ્રાહ્ય રાખી "S" ગ્રેડીંગનું પ્રમાણપત્ર મુખ્ય બાદ જ સમગ્ર કામનું બાકીનું ચૂકવણ કરવાનું રહેશે.

કોન્ટ્રોલન સુચનાની આમલ ધુન્નપણે તત્કાલિક અસરથી કરવાનો રહેશે.

વિ.કે.સી.-

- (૧) રસ્તા, પુલ અને મકાનના કામોની ગુણવત્તા ચકાસણી માટેના નિયત પત્રકો
(૨) એ.ટી.આર.નું નિયત પત્રક

(એન.જી.પરમાર)
ખાસ કરજ પરના અધિકારી (વિ.યો.)
માર્ગ અને મકાન વિભાગ
ગાંધીનગર

Consolidated Tender Details

Home > Consolidated Tender Details

Tender Id: 139007

[View BOQ/Item Details](#)

Organization Name	Bhavnagar Municipal Corporation
Location	Bhavnagar
Department	Urban Development and Urban Housing Department
Sub Department	Bhavnagar Municipal Corporation
IFB/Tender Notice No	BUILDING / Fulsar-Night Selter / 2024-25 (Second Attempt)
Tender Creation Date	19-12-2024 19:14
Tender Type	Open
Tender Title/Name of Project	NIGHT SELTER (GOV. DAY-NULM)
Description of Material/Name of Work	PROPOSED DEVELOPMENT OF NIGHT SHELTER AT FULSAR, FOR BHAVNAGAR MUNICIPAL CORPORATION, (B.M.C) BHAVANAGAR
Sector Category	Urban Development
Form of Contract	Works
Product Category	Civil Works - Buildings
Tender Category	WORKS
Estimated Cost Value	119940841.00 INR (Eleven Crores Ninety Nine Lacs Forty Thousand Eight hundred Forty One)
Is ECV Visible to Supplier?	Yes
Tender Currency Type	Single
Tender Currency Setting	Indian Rupee

Tender Currency Setting	Indian Rupee
Period of Completion/Delivery Period	32 Months
Procurement Type	Works
Consortium / Joint Venture	N/A
Rebate	N/A
Alternate decrypter	N/A

Calender Details

Bid Document Download Start Date	20-12-2024 12:15
Bid Document Download End Date	30-12-2024 18:00
Bid Submission Start Date	20-12-2024 12:15
Bid Submission Closing Date	30-12-2024 18:00
Tender NIT View Date	20-12-2024 12:00
Remarks	<p>CLASS OF REGISTRATION REQUIRED FOR BIDDER MUST BE "AA" Class & Above and Special Building Category-I Demand Draft only for tender FEE and EMD shall be submitted in Electronic Formate through online scanning along with all the supporting documents such as Registration, Bank Solvency Certificate etc. while uploading the bid. Offer of those will be opened whose EMD & Tender fee is received electronically alongwith the bids. however for the purpose of realization of Demand Draft, bidder shall send them in original alongwith all the required documents mentioned in the tender documents through RPAD/Speed post/Reg AD so as they reach to the office of The Executive Engineer,Building Department, Sir Mangalsinhji road, Municipal Corporation, Bhavnagar during office hours before 02-12-2025 17:00 pm. Penaltative action shall initiated for not submittin</p>

	g the supporting documents in original to The Executive Engineer, Building Department by bidder. Hard copy of Price bid will not be accepted and considered. Successful Bids (Preliminary & Technical Bid), if possible will be opened on the 03-1-2025, 17:30 pm at the Office of City Engineer, BMC
Bid validity	180

Amount Details

Bidding Processing Fee (OFFLINE)	21240.00 INR(Twenty One Thousand and Two hundred Forty)
Bidding Processing Fee Payable to	Commissioner, Municipal Corporation, Bhavnagar
Bidding Processing Fee Payable at	Commissioner, Municipal Corporation, Bhavnagar
Bid Security/EMD/Proposal Security INR(OFFLINE)	1200000.00 INR (Twelve Lacs)
Bid Security/EMD/Proposal Security INR Payable to	Commissioner, Municipal Corporation, Bhavnagar
Bid Security/EMD/Proposal Security INR Payable at	Commissioner, Municipal Corporation, Bhavnagar
Exempted Fee	No

Other Details

Officer Inviting Bids	Executive Engineer, Building Department, Municipal Corporation, Bhavnagar
Bid Opening Authority	Tender Committee
Address	Executive Engineer, Building Department, Municipal Corporation, Mangalsihji Road, Kalanala - Bhavnagar

General Terms & Conditions

General Terms and Conditions

- (1) Bidders can download the tender document free of cost from the website.
- (2) Bidders have to submit Technical bid as well as Price bid in Electronic format only on nprocure website till the Last Date & time for submission.
- (3) Offers in physical form will not be accepted in any case.
- (4) Free vendor training camp will be organized every Saturday between 4.00 to 5.00 P.M. at (n)code solutions-A Division of GNFC Ltd., Bidders are requested to take benefit of the same.

Bidders who wish to participate in online tenders will have to procure / should have legally valid Digital Certificate as per Information Technology Act-2000 (Class-III) using which they can sign their electronic bids. Bidders can procure the same from any of the license certifying Authority of India or can contract (n)code solutions- A division of GNFC Ltd, who are licensed Certifying Authority by Govt. of India.

In case bidders need any clarifications or if training required to participate in online tenders, they can contact (n)Procure Support team:-

(n)code Solutions-IT division of GNFC Ltd.,
(n)Procure Cell
501, GNFC Infotower, S.G. Road,
Bodakdev, Ahmedabad – 380054 (Gujarat)

+Contact Details

Phone

+91-79-40007517, 40007514, 40007515.

E-mail : nprocure@ncode.in

TOLL FREE NUMBER: 73590 21663

Other Terms & Conditions as per detailed tender documents



Tender Documents

Sr No	Document Name	Document Definition	Document Size
1	2. TENDER CONDITION.pdf	2. TENDER CONDITION.pdf	151.15 KB
2	9 BMC vendor list 27-11-2024.pdf	9 BMC vendor list 27-11-2024.pdf	1,067.54 KB
3	13. Paripatra.pdf	13. Paripatra.pdf	5,003.82 KB
4	ELE 1.pdf	ELE 1.pdf	548.71 KB
5	ELE 2.pdf	ELE 2.pdf	773.9 KB
6	ELE first floor plan at night shelter.pdf	ELE first floor plan at night shelter.pdf	275.81 KB
7	ELE ground floor plan at night shelter.pdf	ELE ground floor plan at night shelter.pdf	372.25 KB
8	electric details of night shelter.pdf	electric details of night shelter.pdf	855.47 KB
9	fire 1.pdf	fire 1.pdf	340.1 KB
10	fire 2.pdf	fire 2.pdf	312.64 KB
11	FIRST FLOOR.pdf	FIRST FLOOR.pdf	250.27 KB
12	GROUND FLOOR.pdf	GROUND FLOOR.pdf	588.35 KB
13	SCHEDULE-B (TENDER SHEET)FOR NIGHT SHELTER-12-11-2024.pdf	SCHEDULE-B (TENDER SHEET)FOR NIGHT SHELTER-12-11-2024.pdf	242.92 KB
14	SEC.pdf	SEC.pdf	179.74 KB
15	SITE PLAN.pdf	SITE PLAN.pdf	566.15 KB
16	TECHNICAL BID-NIGHT SHELTER AT FULSER FOR BMC-28-07-2024.pdf	TECHNICAL BID-NIGHT SHELTER AT FULSER FOR BMC-28-07-2024.pdf	53.62 KB
17	TERRACE.pdf	TERRACE.pdf	72.75 KB
18	1. N.I.T.pdf	1. N.I.T.pdf	195.68 KB
19	2. FORM B-24-12-2024.pdf	2. FORM B-24-12-2024.pdf	2,468.03 KB

Tender Stages

Stage Name	Evaluation Date	Minimum Forms for Submission	Evaluation Dependency
Preliminary Stage	03-01-2025 17:25	0	
Commercial Stage	03-01-2025 17:30	0	Preliminary Stage

1. Preliminary Stage

Form Id	Form Name	Form Mode	Submission Type	Mandatory	Action
5	Tender Fee Form	Library-Standard	Single	Yes	
6	Emd Fee Form	Library-Standard	Single	Yes	

Documents required for Stage - Preliminary Stage

Sr No	Document Name	Mandatory
1	[1] D.D. of Tender Fee	Yes
2	[2] D.D. of EMD	Yes
3	[3] Bank Solvency 20 Percent Estimated Cost Of Current Calendar Year of 2023	Yes
4	[4] Registered Certificate	Yes
5	[5] Pan Card Number	Yes
6	[6] G.S.T. Number	Yes
7	(7) The bidder shall have to submit valid certificate of registration for having EPF number and ESIC number.	Yes
8	[7] Other Required Document As per tender.	Yes

2. Commercial Stage

Form Id	Form Name	Form Mode	Submission Type	Mandatory	Action
4	Percentage Rate	Library-Secured	Single	Yes	

Evaluation Committee

Stage	Opening	Decryptor		Stage
		Primary Decryptor	Alternate Decryptor	
Preliminary Stage	Bharat M Advani (bmcbmadvani)	Bharat M Advani(bmcbmadvani)	N/A	Bharat M Advani (bmcbmadvani)
Commercial Stage	Bharat M Advani (bmcbmadvani)	Bharat M Advani(bmcbmadvani)	N/A	Bharat M Advani (bmcbmadvani)

Legends	
Icon	Description
	View

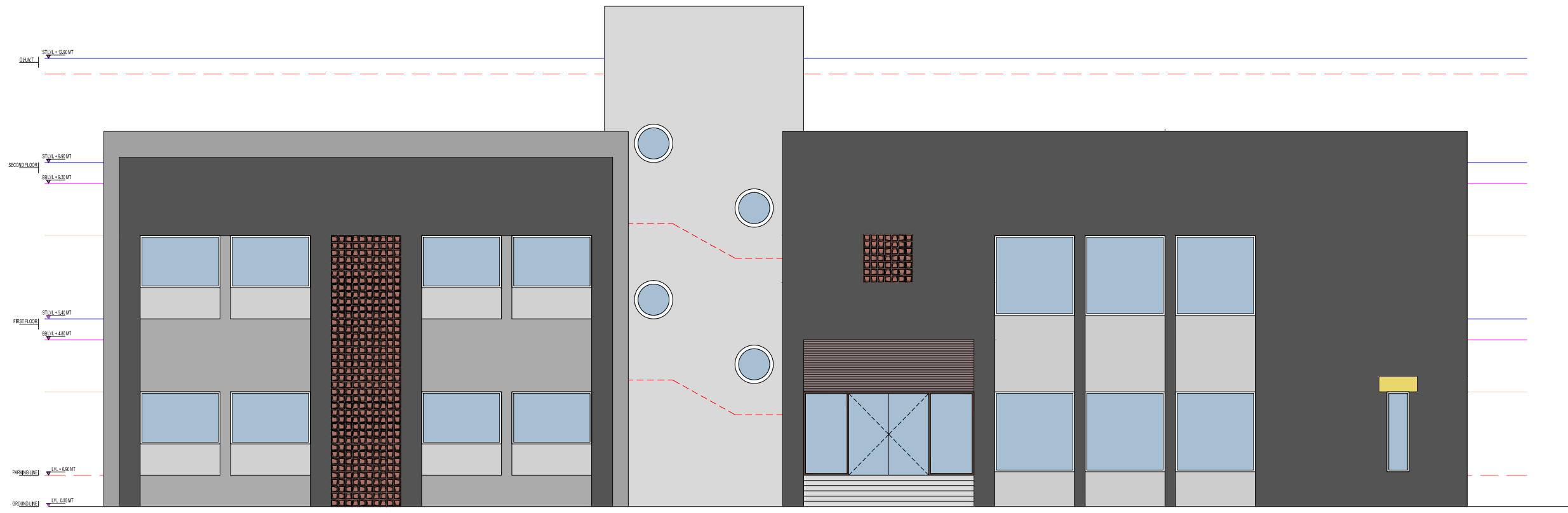

FRONT SIDE ELEVATION

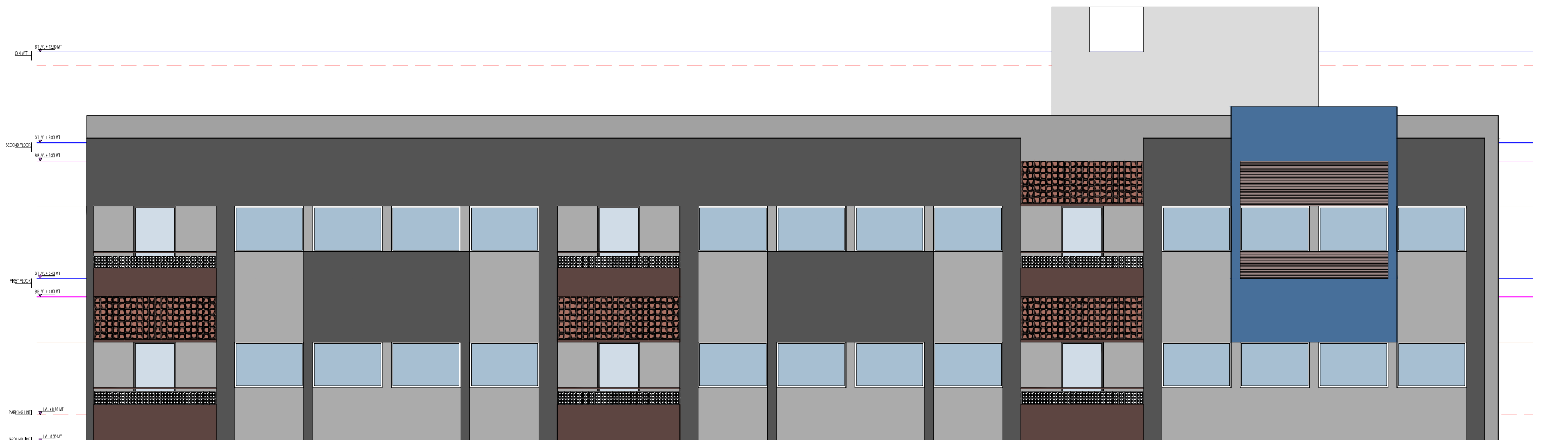

LEFT SIDE ELEVATION

PROJECT NO.
BMC -03/gd
DRAWING NO.
A3-05

TITLE :-
ELEVATIONS

B.M.C.
PROPOSED NIGHT
SHELTER AT FULSAR T.P.
SCHEME, BHAVNAGAR FOR
BMC

DWG.DATE:-
31-03-2023

1) ALL DIMENSIONS ARE IN METERS. 2) ALL DIMENSIONS TO BE READ AND NOT MEASURED. 3) ALL DIMENSIONS ARE FROM UNFINISHED SURFACES. 4) ALL STRUCTURAL DRGS. TO BE READ SIMULTANEOUSLY WITH ARCHITECTURAL DRGS. 5) ALL DIMENSIONS TO BE VERIFIED BY THE CONTRACTOR AND ANY AMBIGUITY TO BE BROUGHT TO THE IMMEDIATE NOTICE OF THE ARCHITECT. 6) ALL INTERNAL WALLS, BEAMS, COLUMNS AND SLABS ARE FINISHED WITH 12.5MM THK. SMOOTH PLASTER UNLESS OTHERWISE SPECIFIED. 7) ALL EXTERNAL WALLS ARE FINISHED WITH 25MM. THK. SANDFACED PLASTER UNLESS OTHERWISE SPECIFIED. 8) ALL LEVELS ARE INDICATED CONSIDERING THE EDGE OF APPERTANT ROAD AS + 0000 LVL.

THESE DRAWINGS & DESIGNS ARE THE SOLE PROPERTY OF **AR. CHINTAN SACHAPARA** AND AS SUCH SHALL NOT BE REPRODUCED IN ANY FORM WITHOUT EXPRESSED WRITTEN PERMISSION OF **AR. CHINTAN SACHAPARA**. ALL DRAWINGS AND RELATED DOCUMENTS SHALL BE RETURNED TO **AR. CHINTAN SACHAPARA** UPON REQUEST.

IT IS THE RESPONSIBILITY OF THE CLIENT OR THE PROJECT MANAGEMENT COMPANY/ BMC'S ENGINEERS TO CHECK THE COORDINATION OF THE DRAWING WITH SITE BOUNDARIES. **AR. CHINTAN SACHAPARA** DO NOT HOLD ANY RESPONSIBILITIES IN CASE OF LEGAL CONFLICTS AND /OR MISHANDLED SITE COORDINATION.



CHINTAN SACHAPARA ARCHITECTS
ARCHITECTURE & INTERIOR DESIGN
+ 91 - 94 - 28 - 401 - 640
3, SHAHIBAUG, ABOVE HOMEDECOR,
WAGHAWADI ROAD, BHAVNAGAR.

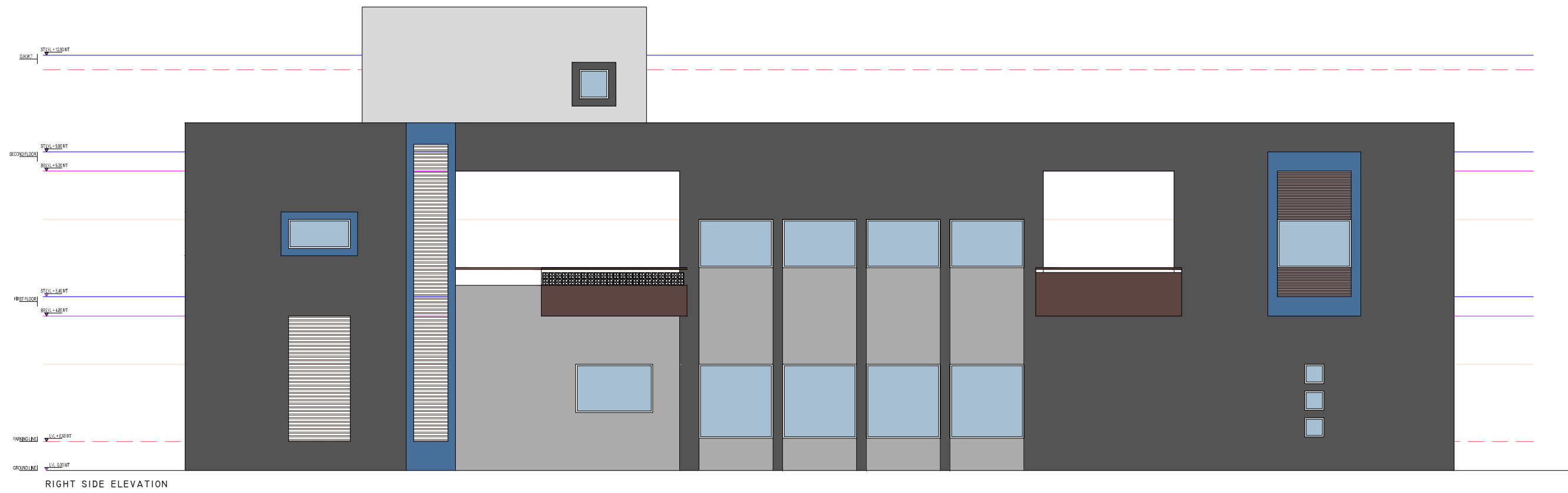

RIGHT SIDE ELEVATION

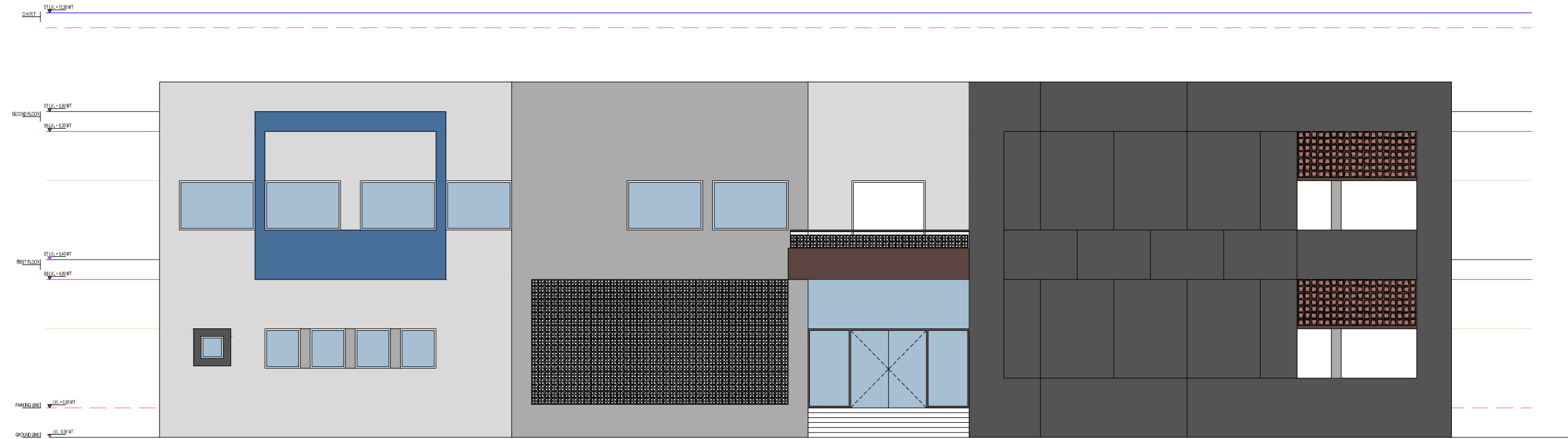

REAR SIDE ELEVATION

PROJECT NO. BMC -03/gd DRAWING NO. A3-06	TITLE :- ELEVATIONS	B.M.C. PROPOSED NIGHT SHELTER AT FULSAR T.P. SCHEME, BHAVNAGAR FOR BMC	DWG.DATE:- 31 -03 -2023	1) ALL DIMENSIONS ARE IN METERS. 2) ALL DIMENSIONS TO BE READ AND NOT MEASURED. 3) ALL DIMENSIONS ARE FROM UNFINISHED SURFACES. 4) ALL STRUCTURAL DRGS. TO BE READ SIMULTANEOUSLY WITH ARCHITECTURAL DRGS. 5) ALL DIMENSIONS TO BE VERIFIED BY THE CONTRACTOR AND ANY AMBIGUITY TO BE BROUGHT TO THE IMMEDIATE NOTICE OF THE ARCHITECT. 6) ALL INTERNAL WALLS, BEAMS, COLUMNS AND SLABS ARE FINISHED WITH 12.5MM THK. SMOOTH PLASTER UNLESS OTHERWISE SPECIFIED. 7) ALL EXTERNAL WALLS ARE FINISHD WITH 25MM. THK. SANDFACED PLASTER UNLESS OTHERWISE SPECIFIED. 8) ALL LEVELS ARE INDICATED CONSIDERING THE EDGE OF APPERTANT ROAD AS + 0000 LVL.	THESE DRAWINGS & DESIGNS ARE THE SOLE PROPERTY OF AR. CHINTAN SACHAPARA AND AS SUCH SHALL NOT BE REPRODUCED IN ANY FORM WITHOUT EXPRESSED WRITTEN PERMISSION OF AR. CHINTAN SACHAPARA . ALL DRAWINGS AND RELATED DOCUMENTS SHALL BE RETURNED TO AR. CHINTAN SACHAPARA UPON REQUEST.	IT IS THE RESPONSIBILITY OF THE CLIENT OR THE PROJECT MANAGEMENT COMPANY/ BMC'S ENGINEERS TO CHECK THE COORDINATION OF THE DRAWING WITH SITE BOUNDARIES. AR. CHINTAN SACHAPARA DO NOT HOLD ANY RESPONSIBILITIES IN CASE OF LEGAL CONFLICTS AND /OR MISHANDLED SITE COORDINATION.	 CHINTAN SACHAPARA ARCHITECTS ARCHITECTURE & INTERIOR DESIGN + 9 1 - 9 4 - 2 8 - 4 0 1 - 6 4 0 3, SHAHIBAUG, ABOVE HOMEDECOR, WAGHAWADI ROAD, BHAVNAGAR.
---	-----------------------------------	---	----------------------------	--	--	---	---

ELECTRICAL LEGEND FOR GROUND FLOOR

SYMBOL	DESCRIPTION	HEIGHT(M) FOR FFL
	18W RECESSED MOUNTED LED DOWN LIGHT	IN CEILING
	18W SURFACE MOUNTED LED DOWN LIGHT	IN CEILING
	20W RECESSED MOUNTED LED DOWN LIGHT	IN CEILING
	10W BRACKET LIGHT POINT	2.1 mmm
	1200mm DIA CEILING FANT	IN CEILING
	EXHAUST FAN	IN WINDOW
	5A SOCKET OUTLET FOR EXHAUST FAN	NEAR WINDOW
	SWITCH BOARD WITH 5A SOCKET (SB)	0.9 m
	SWITCH BOARD WITHOUT 5A SOCKET (SB)	0.9 m
	5A SWITCH SOCKET OUTLET (P)	0.9 m
	15A SWITCH SOCKET OUTLET (PP)	0.9 m
	5/15A PROJECTOR SOCKET (ON UPS POWER)	IN CEILING
	AC SOCKET - 15A SWITCH SOCKET OUTLET	2.6 m
	3 PHASE INDUSTRIAL TYPE SOCKET 200mm(W)x200mm(H)x100mm(D) HENSEL CAT. REF. - 6000101	1.2 m
	COMPUTER DATA POINT	0.9 m
	TELEPHONE POINT	0.9 m
	LIGHTING DISTRIBUTION BOARD (LDB)	1.5 m
	CAMERA POINT	BB

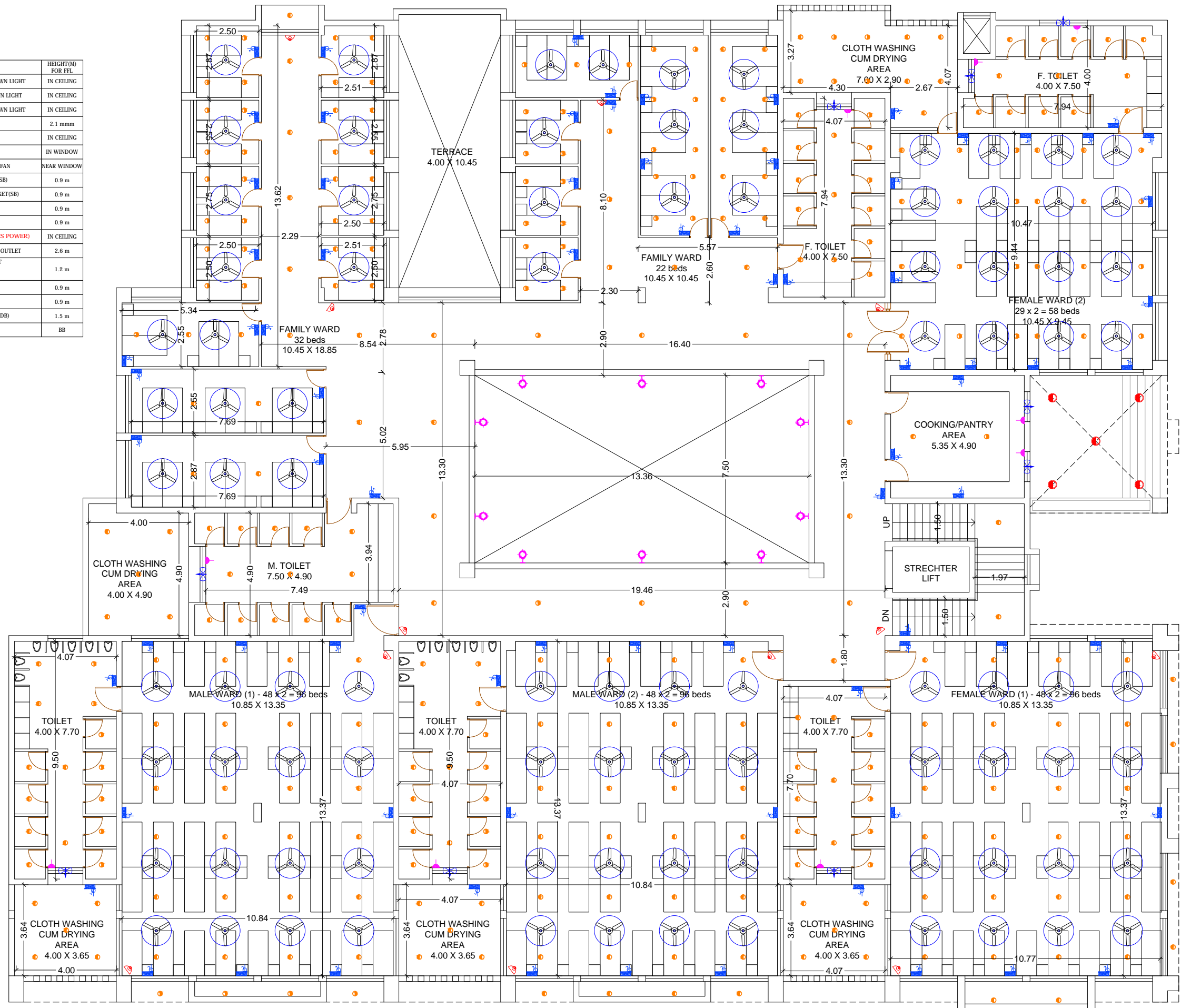

FIRST FLOOR PLAN

RIGHT SIDE

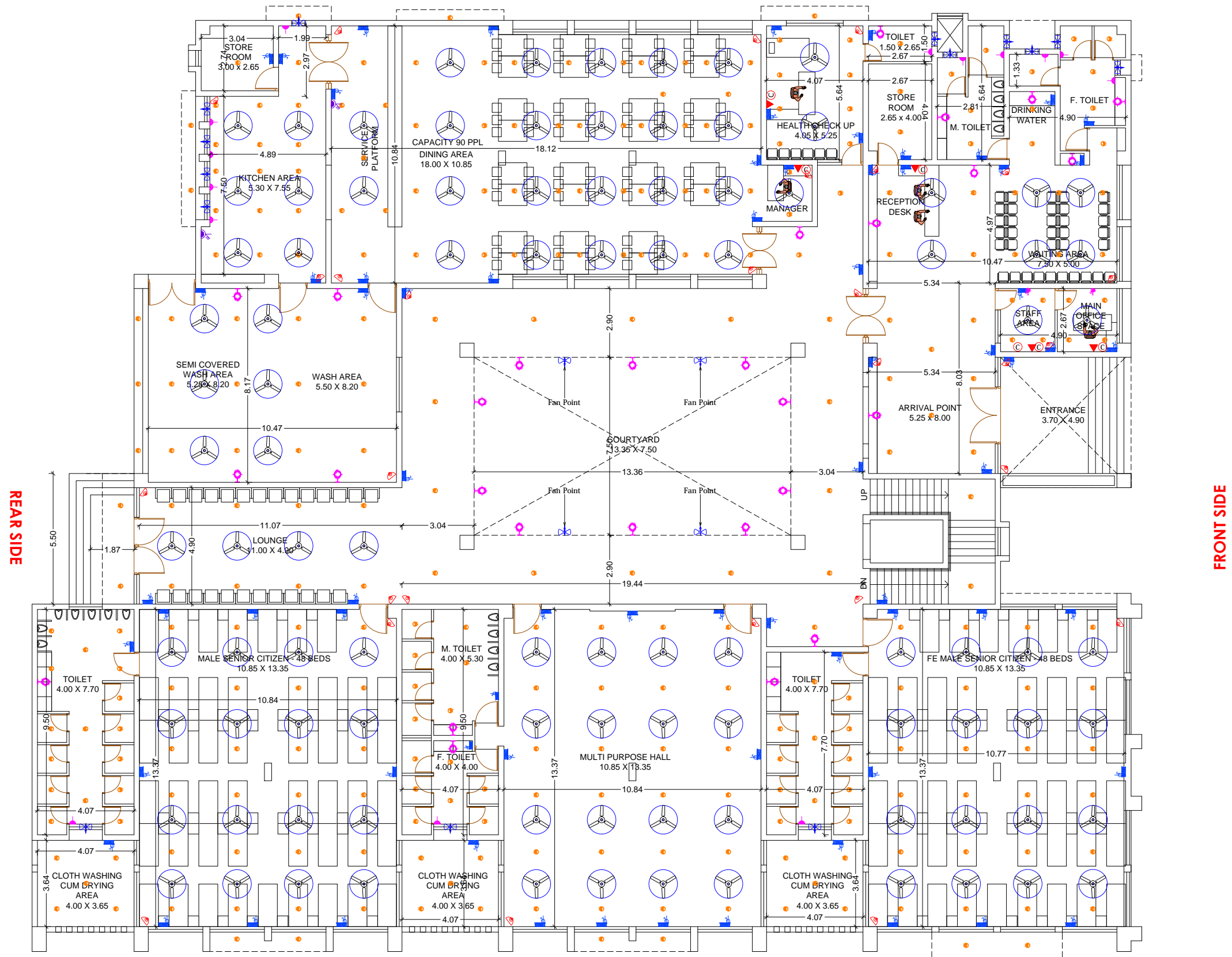

REAR SIDE

FRONT SIDE

GROUND FLOOR PLAN

main lt panel

1500

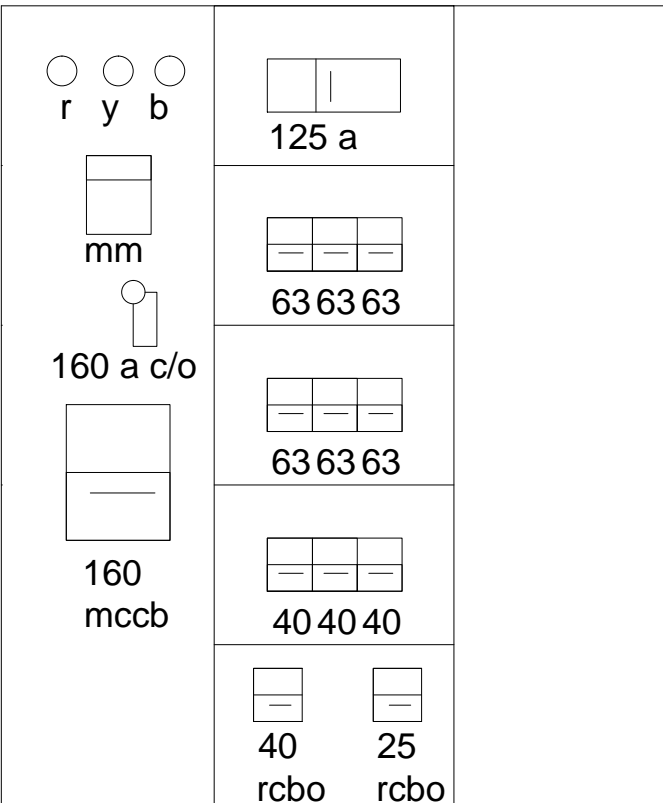

300

- 160 a mccb
- 160 a c/o incommer

- 125a mccb fire panel
- 63a mcb gf/ ff dbs
- 40a street light
- 40a security
- 40a spare
- 40 rcbo lift
- 25 rcbo lift lighting



900

PANEL SPECIFICATION

out of 16 swg crcasheet duly powder coated 85 microns duly painted siemence
grey colour ral 7032 cubical type dust and vermin proof, bottom entry, front
operated, with 400 mm angle stand and provision of gland plate size @
1500x900x300 mm

incommer

160a 3p 36ka mccb with

4p 160a c/o on load switch

multimediameter, ryb lamp

out going

125a 3p 36ka mccb 1 no

63a 4p 10ka tp mcb 3 nos

63a 4p 10ka tp mcb 3 nos

40a 4p mcb 10ka 3 nos

40a 4p rcbo 1nos

25a 2p rcbo 1 nos

Switch gear

multimediameter

wire

lugs

conductor

c/o switch

connector

lamp

scheinder make

conserve, schneider

isi rr/ finolex

dowells

elmax

hpl make

connect well/ elmax

led schneider

sld

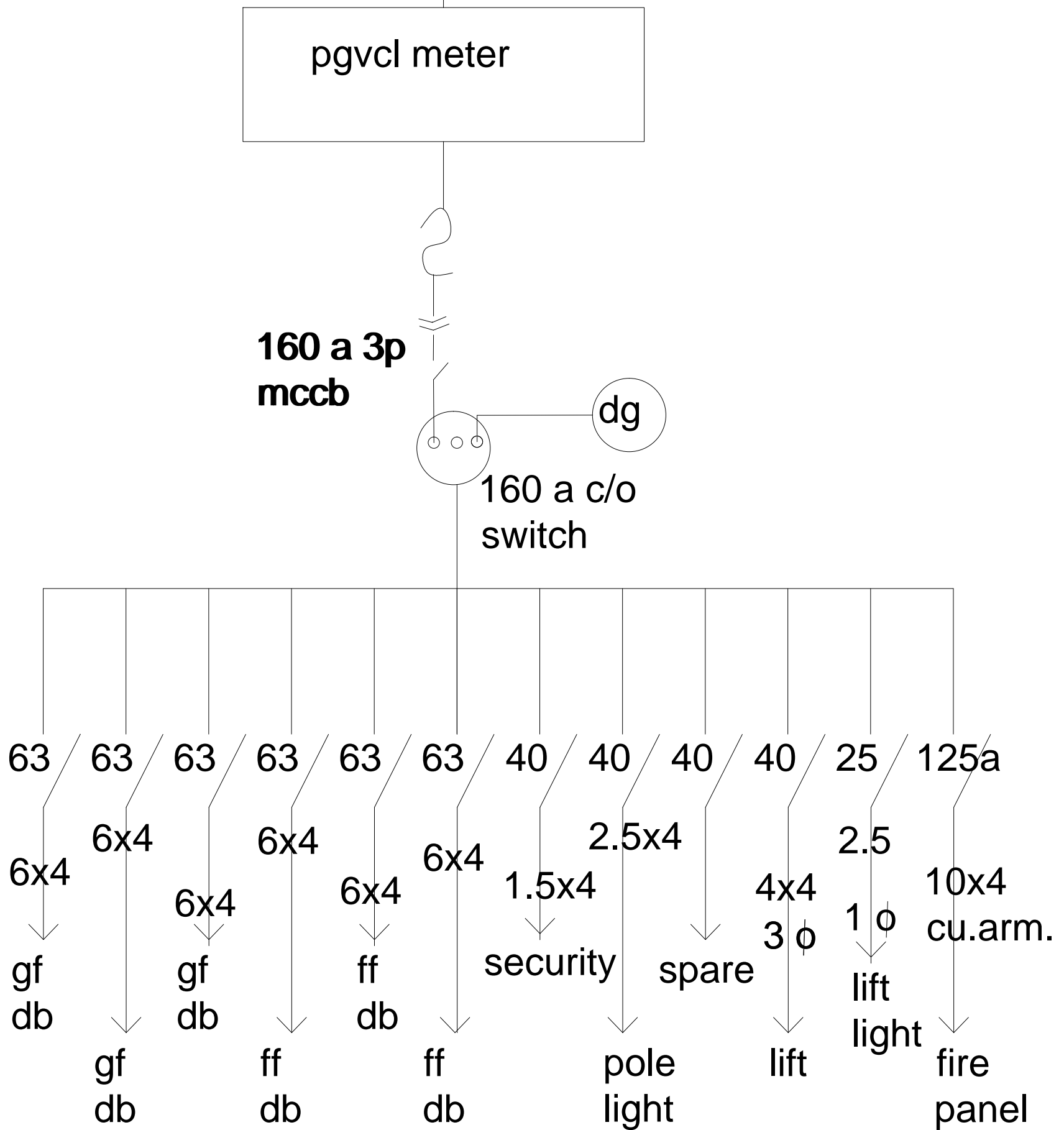

note:-

- pgvcl meter to panel cable not counted as length is not finalised.
- camera and its accessories not counted. wiring provision done.
- nvr location in office.
- main It panel and dg location in electrical room.
- fire panel location b/h building, near child play area.
- ckt distribution from db as per measurement sheets. no change allow.

Material Specification		
Sr. no	Item	Specification
1	PVC Pipe & it's accessories	ISI Precision Vraj, Nihir
2	PVC Wire/Cable	Finolex/RR/KEI
3	Switch & it's accessories	Schneider/Legrand/havells
4	DB/MCB/Reeb	hager/Schneider/Legrand
5	Ceilling Fan	Crompton/Havell's/USHA
6	Exhaust Fan	Crompton/Havell's/USHA
7	LED Flood Light	Crompton/Havell's/philips
8	ac	mitsubishi/ ogeneral
9	water cooler	usha/ bluestar/ lyod
10	lugs	dowells
11	glands	hmi/ cable grip
12	dgset	kirlosker/ cummins/ mahindra
NOTE : All LIGHTING FIXTURES MUST BE APPROVED BY ARCHITECT/ bmc before proceding materials (MAKE, MODEL,		

load calculation					
no	item	qty	watt	total watt	
1	led lights	645	20	12900	
2	ceilling fans	188	60	11280	
3	ex. Fans	25	40	1000	
4	kitchen equipments	1s	5000	5000	
5	a/c	2	1800	3600	
6	lift	1	3700	3700	
7	water cooler	2	500	1000	
8	o/s lights	14	40	560	
9	fire pump	1	20000	20000	
			total	59040	watt
			say	60 kw	
			pgvcl demand	40 kw	
			d.g. set	62.5 kw	

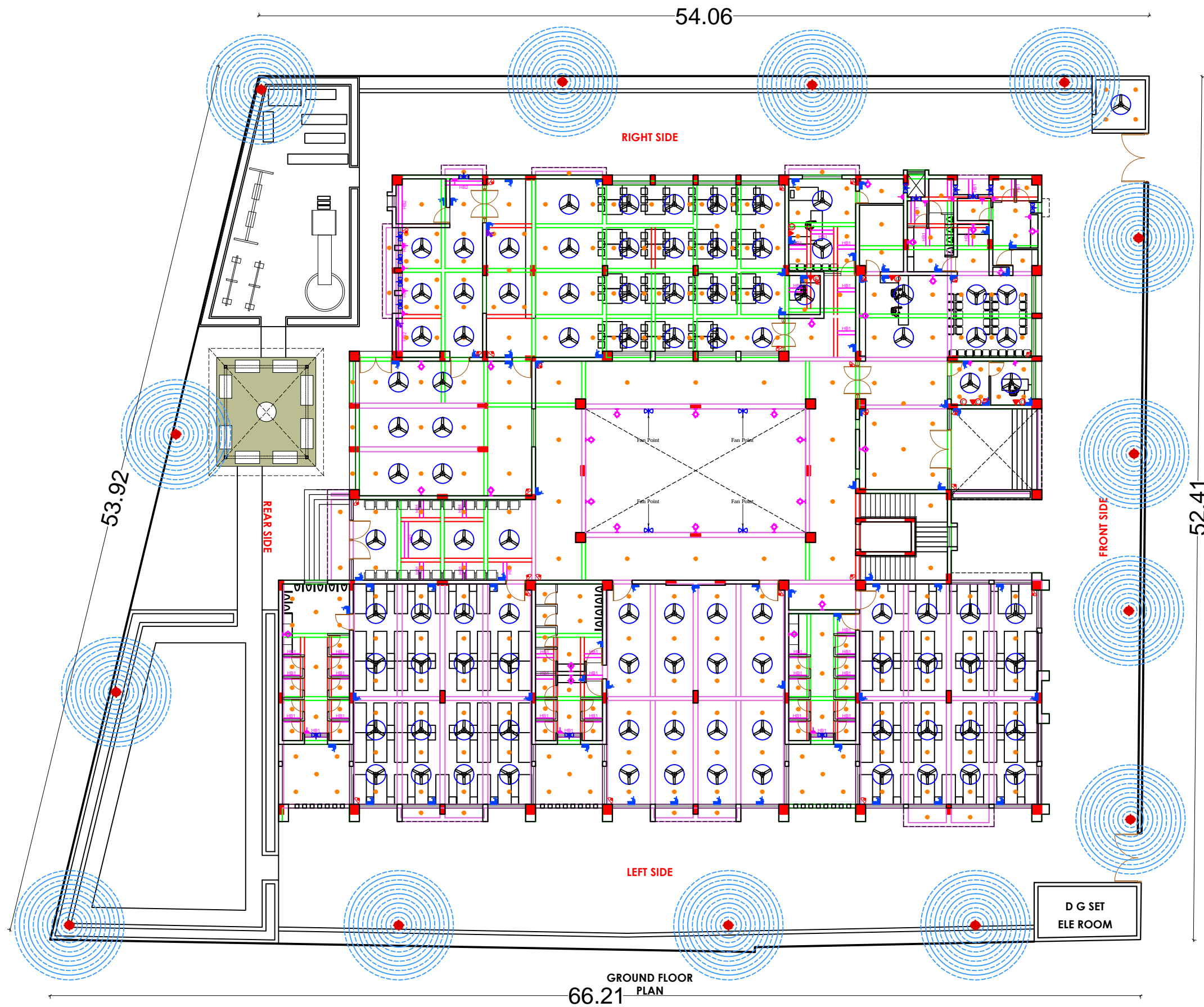

FIRE FIGHTING LEGENDS	
LEGEND	DESCRIPTION
	FIRE HOSE REEL (WITH 30M HOSE)
	HOSE BOX SINGLE DOOR (WITH 15M CANVAS HOSE)
	Four Way
	Fire Hydrant
	PENDENT TYPE SPRINKLER
	25 NB SPRINKLER PIPE
	50 NB SPRINKLER PIPE
	80 NB SPRINKLER PIPE
	100 NB HYDRANT PIPE
	SMOKE DETECTOR
	ABC TYPE FIRE EXTINGUISHER
MP	MAIN FIRE PUMP
CP	CONTROL PANEL FOR PUMP

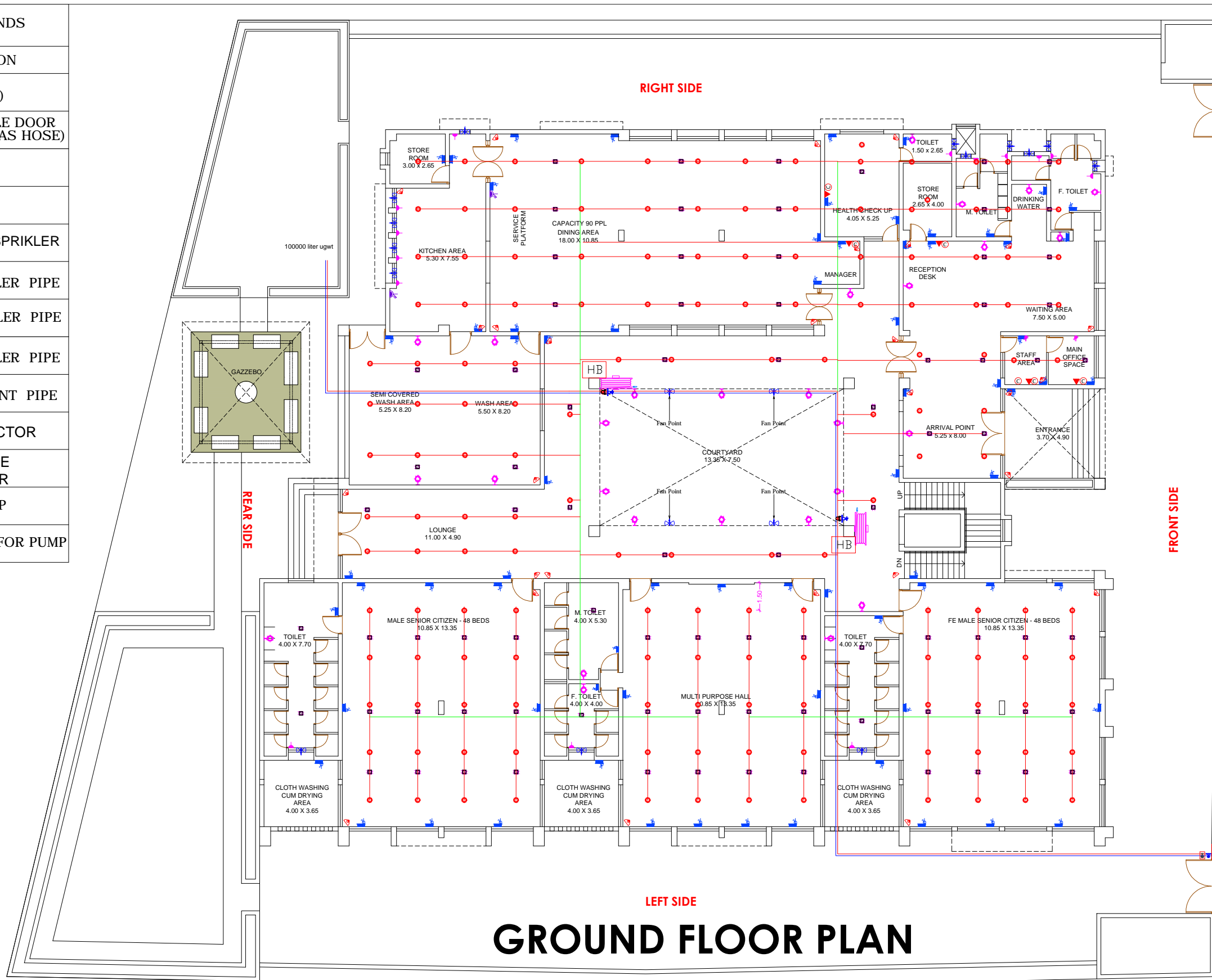

GROUND FLOOR PLAN

PROJECT NO. BMC -03/gd	TITLE :- GROUND FLOOR PLAN	B.M.C. PROPOSED NIGHT SHELTER AT FULSAR T.P. SCHEME, BHAVNAGAR FOR BMC	DWG.DATE:- 31-03-2023	<p>1) ALL DIMENSIONS ARE IN METERS. 2) ALL DIMENSIONS TO BE READ AND NOT MEASURED. 3) ALL DIMENSIONS ARE FROM UNFINISHED SURFACES. 4) ALL STRUCTURAL DRGS. TO BE READ SIMULTANEOUSLY WITH ARCHITECTURAL DRGS. 5) ALL DIMENSIONS TO BE VERIFIED BY THE CONTRACTOR AND ANY AMBIGUITY TO BE BROUGHT TO THE IMMEDIATE NOTICE OF THE ARCHITECT. 6) ALL INTERNAL WALLS, BEAMS, COLUMNS AND SLABS ARE FINISHED WITH 12.5MM THK. SMOOTH PLASTER UNLESS OTHERWISE SPECIFIED. 7) ALL EXTERNAL WALLS ARE FINISHED WITH 25MM. THK. SANDFACED PLASTER UNLESS OTHERWISE SPECIFIED. 8) ALL LEVELS ARE INDICATED CONSIDERING THE EDGE OF APPERTANT ROAD AS + 0000 LVL.</p>	THESE DRAWINGS & DESIGNS ARE THE SOLE PROPERTY OF AR. CHINTAN SACHAPARA AND AS SUCH SHALL NOT BE REPRODUCED IN ANY FORM WITHOUT EXPRESSED WRITTEN PERMISSION OF AR. CHINTAN SACHAPARA . ALL DRAWINGS AND RELATED DOCUMENTS SHALL BE RETURNED TO AR. CHINTAN SACHAPARA UPON REQUEST.	IT IS THE RESPONSIBILITY OF THE CLIENT OR THE PROJECT MANAGEMENT COMPANY/ BMC'S ENGINEERS TO CHECK THE COORDINATION OF THE DRAWING WITH SITE BOUNDARIES. AR. CHINTAN SACHAPARA DO NOT HOLD ANY RESPONSIBILITIES IN CASE OF LEGAL CONFLICTS AND /OR MISHANDLED SITE COORDINATION.	<p>CHINTAN SACHAPARA ARCHITECTS ARCHITECTURE & INTERIOR DESIGN + 91 - 94 - 28 - 401 - 640 3, SHAHIBAUG, ABOVE HOMEDECOR, WAGHAWADI ROAD, BHAVNAGAR.</p>
----------------------------------	--------------------------------------	---	--------------------------	--	--	---	--

FIRE FIGHTING LEGENDS	
LEGEND	DESCRIPTION
	FIRE HOSE REEL (WITH 30M HOSE)
	HOSE BOX SINGLE DOOR (WITH 15M CANVAS HOSE)
	Four Way
	Fire Hydrant
	PENDENT TYPE SPRINKLER
	25 NB SPRINKLER PIPE
	50 NB SPRINKLER PIPE
	80 NB SPRINKLER PIPE
	100 NB HYDRANT PIPE
	SMOKE DETECTOR
	ABC TYPE FIRE EXTINGUISHER
MP	MAIN FIRE PUMP
CP	CONTROL PANEL FOR PUMP

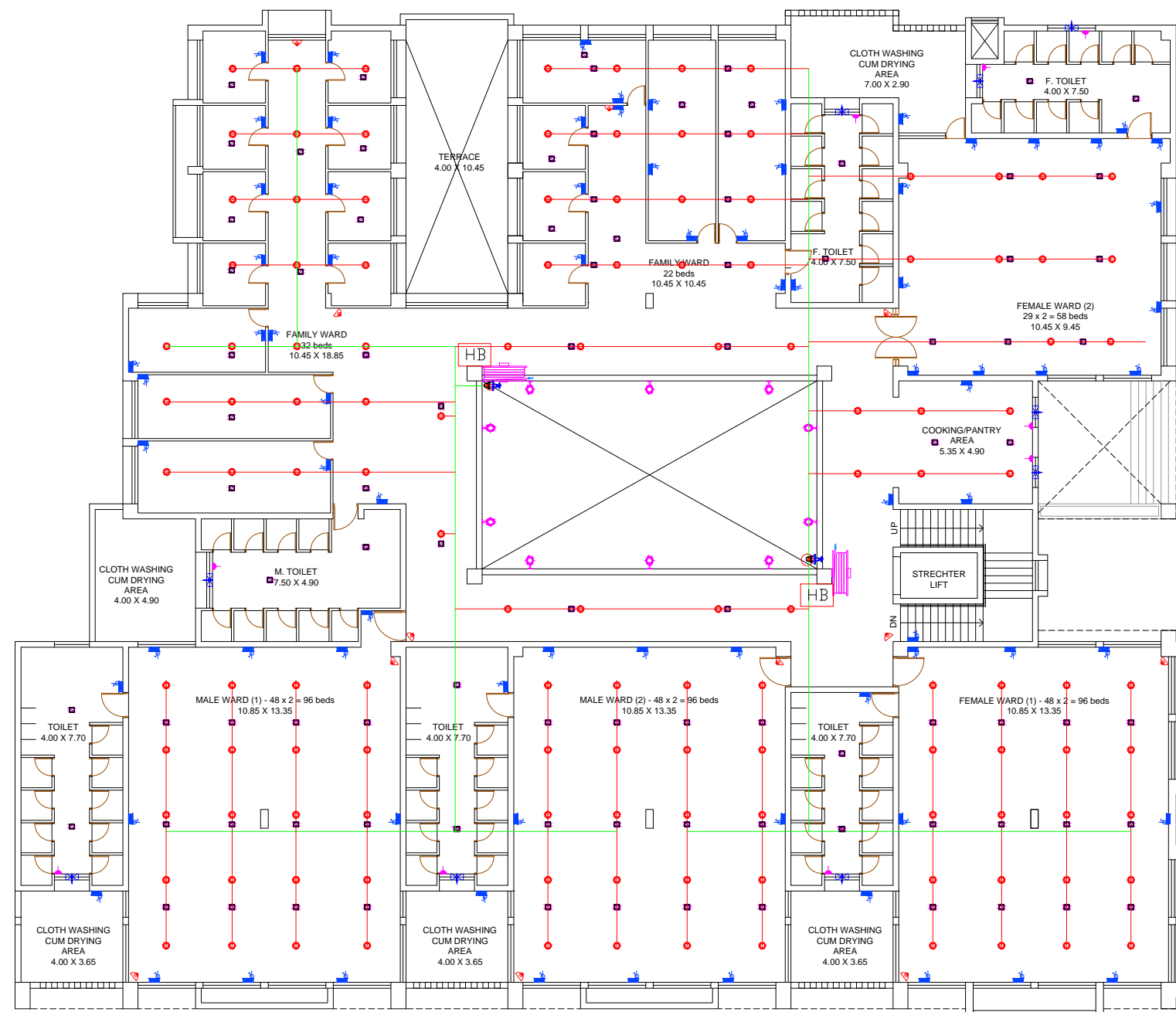

FIRST FLOOR PLAN

PROJECT NO. BMC -03/gd	TITLE :- GROUND FLOOR PLAN	B.M.C. PROPOSED NIGHT SHELTER AT FULSAR T.P. SCHEME, BHAVNAGAR FOR BMC	DWG.DATE:- 31-03-2023		1) ALL DIMENSIONS ARE IN METERS. 2) ALL DIMENSIONS TO BE READ AND NOT MEASURED. 3) ALL DIMENSIONS ARE FROM UNFINISHED SURFACES. 4) ALL STRUCTURAL DRGS. TO BE READ SIMULTANEOUSLY WITH ARCHITECTURAL DRGS. 5) ALL DIMENSIONS TO BE VERIFIED BY THE CONTRACTOR AND ANY AMBIGUITY TO BE BROUGHT TO THE IMMEDIATE NOTICE OF THE ARCHITECT. 6) ALL INTERNAL WALLS, BEAMS, COLUMNS AND SLABS ARE FINISHED WITH 12.5MM THK. SMOOTH PLASTER UNLESS OTHERWISE SPECIFIED. 7) ALL EXTERNAL WALLS ARE FINISHED WITH 25MM. THK. SANDFACED PLASTER UNLESS OTHERWISE SPECIFIED. 8) ALL LEVELS ARE INDICATED CONSIDERING THE EDGE OF APPERTANT ROAD AS + 0000 LVL.	THESE DRAWINGS & DESIGNS ARE THE SOLE PROPERTY OF AR. CHINTAN SACHAPARA AND AS SUCH SHALL NOT BE REPRODUCED IN ANY FORM WITHOUT EXPRESSED WRITTEN PERMISSION OF AR. CHINTAN SACHAPARA . ALL DRAWINGS AND RELATED DOCUMENTS SHALL BE RETURNED TO AR. CHINTAN SACHAPARA UPON REQUEST.	IT IS THE RESPONSIBILITY OF THE CLIENT OR THE PROJECT MANAGEMENT COMPANY/ BMC'S ENGINEERS TO CHECK THE COORDINATION OF THE DRAWING WITH SITE BOUNDARIES. AR. CHINTAN SACHAPARA DO NOT HOLD ANY RESPONSIBILITIES IN CASE OF LEGAL CONFLICTS AND /OR MISHANDLED SITE COORDINATION.	 CHINTAN SACHAPARA ARCHITECTS ARCHITECTURE & INTERIOR DESIGN + 91 - 94 - 28 - 401 - 6403, SHAHIBAUG, ABOVE HOMEDECOR, WAGHAWADI ROAD, BHAVNAGAR.
----------------------------------	--------------------------------------	---	--------------------------	--	---	--	---	--

FIRST FLOOR PLAN

BEDS CAPACITY AT F.F. LEVEL					
Ward	Bed No.	Bath	WC	Urinal	Basin
Male Ward (1)	96	04	05	07	04
Male Ward (2)	96	04	05	07	04
Female Ward (1)	96	04	05		04
Female Ward (2)	58	04	05		04
Family Ward	54	09	10		08
Total	400	21	30	14	20

	Bed No.	Bath	WC	Urinal	Basin
GROUND LEVEL	96	12	15	11	12
FIRST LEVEL	400	21	30	14	20
TOTAL	496	33	45	25	32

DOOR WINDOW SCHEDULE

WINDOW	Size
W1	2.30 x 2.40
W2	1.00 x 2.40
W3	0.60 x 0.60
W4	1.20 x 1.20
W5	0.65 x 2.40
V1	1.40 x 0.60
V2	0.6 x 0.90
V3	1.20 x 0.60
D/W	1.40 x 2.40
D/W 1	2.25 x 2.40
D/W 2	2.65 x 2.40

DOOR	Size
D1	2.40 x 2.40
D2	2.00 x 2.40
D3	1.80 x 2.40
D4	0.90 x 2.40
D5	0.75 x 2.40
D6	1.20 x 2.40
D7	1.00 x 2.40
D8	1.50 x 2.40

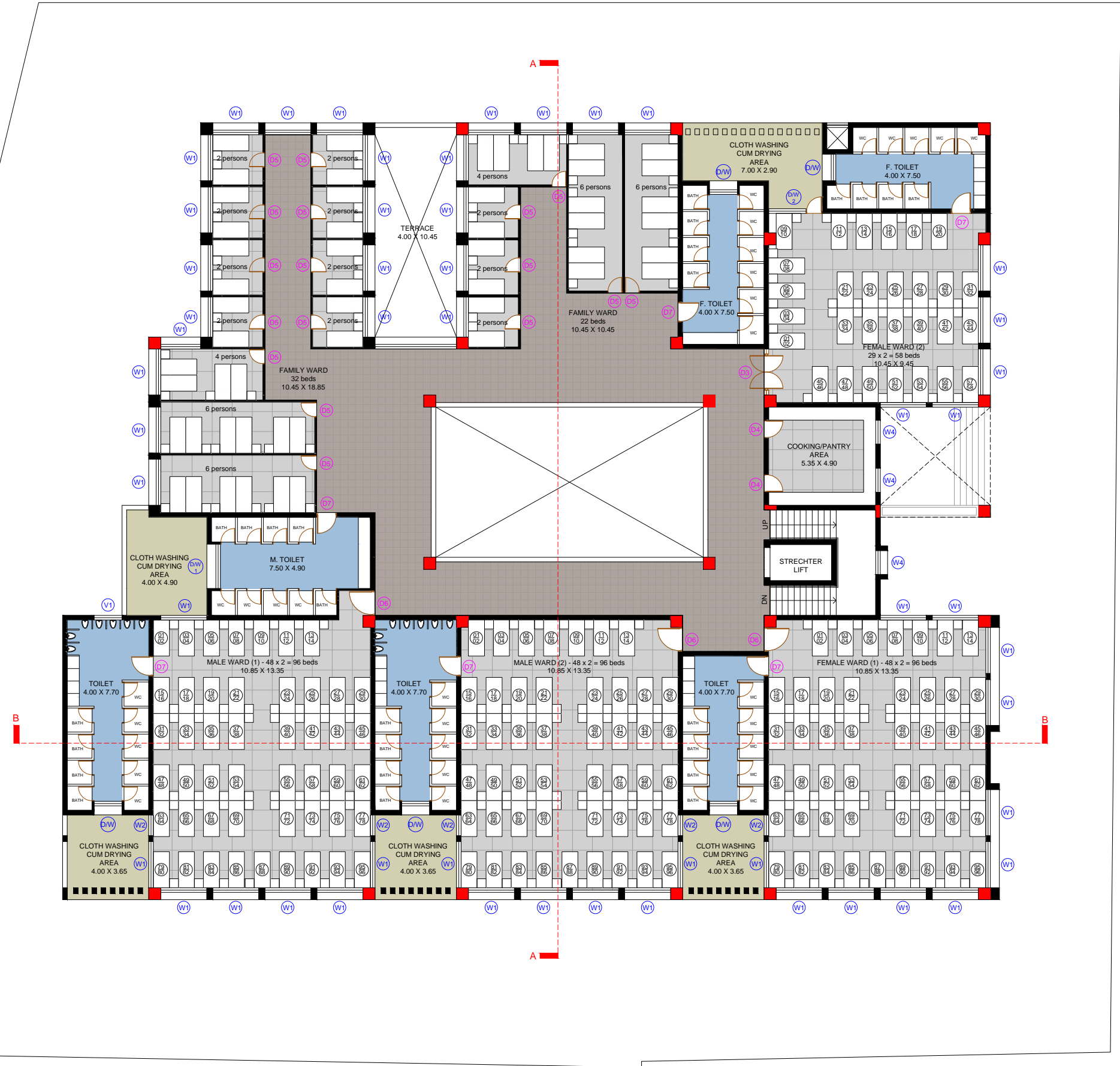

PROJECT NO.
BMC -03/gd

DRAWING NO.
A3-03

TITLE :-
FIRST FLOOR PLAN

B.M.C.
PROPOSED NIGHT
SHELTER AT FULSAR T.P.
SCHEME, BHAVNAGAR FOR
BMC

DWG.DATE:-
31-03-2023

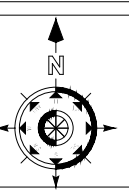

1) ALL DIMENSIONS ARE IN METERS. 2) ALL DIMENSIONS TO BE READ AND NOT MEASURED. 3) ALL DIMENSIONS ARE FROM UNFINISHED SURFACES. 4) ALL STRUCTURAL DRGS. TO BE READ SIMULTANEOUSLY WITH ARCHITECTURAL DRGS. 5) ALL DIMENSIONS TO BE VERIFIED BY THE CONTRACTOR AND ANY AMBIGUITY TO BE BROUGHT TO THE IMMEDIATE NOTICE OF THE ARCHITECT. 6) ALL INTERNAL WALLS, BEAMS, COLUMNS AND SLABS ARE FINISHED WITH 12.5MM THK. SMOOTH PLASTER UNLESS OTHERWISE SPECIFIED. 7) ALL EXTERNAL WALLS ARE FINISHED WITH 25MM. THK. SANDFACED PLASTER UNLESS OTHERWISE SPECIFIED. 8) ALL LEVELS ARE INDICATED CONSIDERING THE EDGE OF APPERTANT ROAD AS + 0000 LVL.

THESE DRAWINGS & DESIGNS ARE THE SOLE PROPERTY OF **AR. CHINTAN SACHAPARA** AND AS SUCH SHALL NOT BE REPRODUCED IN ANY FORM WITHOUT EXPRESSED WRITTEN PERMISSION OF **AR. CHINTAN SACHAPARA**. ALL DRAWINGS AND RELATED DOCUMENTS SHALL BE RETURNED TO **AR. CHINTAN SACHAPARA** UPON REQUEST.

IT IS THE RESPONSIBILITY OF THE CLIENT OR THE PROJECT MANAGEMENT COMPANY/ BMC'S ENGINEERS TO CHECK THE COORDINATION OF THE DRAWING WITH SITE BOUNDARIES. **AR. CHINTAN SACHAPARA** DO NOT HOLD ANY RESPONSIBILITIES IN CASE OF LEGAL CONFLICTS AND/OR MISHANDLED SITE COORDINATION.

CHINTAN SACHAPARA ARCHITECTS

ARCHITECTURE & INTERIOR DESIGN
+ 91 - 94 - 28 - 401 - 640
3, SHAHIBAUG, ABOVE HOMEDECOR,
WAGHAWADI ROAD, BHAVNAGAR.

BHAVNAGAR MUNICIPAL CORPORATION



Bid Documents For

**PROPOSED DEVELOPMENT OF NIGHT SHELTER AT FULSAR, FOR
BHAVNAGAR MUNICIPAL CORPORATION (B.M.C), BHAVANAGAR**

NOTICE INVITING TENDER & QUALIFICATION CRITERIA

ARCHITECTS:

CHINTAN SACHAPARA

ARCHITECTS

**3, SHAHIBAUG, ABOVE HOME DÉCOR, WAGHA WADI ROAD,
BHAVNAGAR**

PHONE : 9428401640

EXECUTIVE ENGINEER

Building Department

**Bhavnagar Municipal
Corporation**

Mangalsinhji Road,

Bhavnagar – 364 001

BHAVNAGAR MUNICIPAL CORPORATION	
Notice Inviting On-Line Tender	
Tender Notice No. BUILDING / Fulsar-Night Selter/ 2024-25	
Department Name	: Building Department
IFB No.	: BUILDING / Fulsar-Night Selter / 2024-25
Name of Project	: NIGHT SELTER GOV. (DAY-NULM)
Name of Work	: PROPOSED DEVELOPMENT OF NIGHT SHELTER AT FULSAR, FOR BHAVNAGAR MUNICIPAL CORPORATION, (B.M.C) BHAVANAGAR
Tender Type	: Open – Percentage rate Tender
Estimated Contract Value (INR)	: 11,99,40,841.00
Period of Completion (in month)	: 32 (THIRTY TWO) Months Including Monsoon period
Bidder Nationality	: LCB (Local Competition Bidding)
Qualification Of Bidder	: Duly registered with R&B in Class “AA” Class & Above and Special Building Category-I
Bid Call (Nos)	: 1
Tender Currency Type	: Single
Tender Currency Settings	: Indian Rupee(INR)
Joint Venture / Consortium	: N.A.
Rebate	: N.A.
Amount Details	
Bid Document Fee	: Rs.18000.00 + 3240.00 (18% GST) = 21240.00 in the Form of DD only/-(Rs. Twenty One Thousand Two Hundred Fourty Only)
Bid Document Fee	: Commissioner, Bhavnagar Municipal

Payable To	corporation, Bhavnagar
Bid Security /EMD(INR)	: Rs. 12,00,000.00 (Rs. Twelve Lakhs Only.)(only D.D.)
Bid Security/ EMD in favour of	: Commissioner, Bhavnagar Municipal Corporation, Bhavnagar
Tender Dates	
Bid Document Downloading Start Date	: Dt. 14/11/2024
Bid Document Downloading End Date	: Dt. 16/12/2024 18:00
Pre-Bid Meeting &Time	: Dt. 21/11/2024 11:45Am (office of the City Engineer, Municipal Corporation, Bhavnagar)
Last Date &Time of Online Bid Submission	: Dt. 16/12/2024 18:00
Physical Submission of EMD Document Fee PQ Bid & Supporting all documents	: Dt. 16/12/2024 to Dt. 19/12/2024up to 06:10pm office of the Executive Engineer, Building Department, BMC-Bhavnagar
Opening Of Bid(Online) & TechnicalBid	: Dt. 20/12/2024, 17:00
Penalty	0.10 % of contract value per day to the maximum amount of 10% of contract value
Opening Of PriceBid (Online)	: Intimation through letter.
Bid Validity Period	: 180 Days
<u>Qualification of Bidder:</u>	Tenderer shall be required to submit the enlisted documents in hard copy along with the Qualification Bid. If documents are insufficient or it does not match the required criteria mentioned below, then the Price Bid of the tenderer shall not be opened. Mainly tenderer shall fulfill following Technical & Financial pre- qualification criteria as a main contractor. The tenderer shall fulfill the

following all points A to Q requirements /experiences for qualification.

A. The Bidder must have achieved average annual turnover during last three financial years, ending on 31st March 2024 of Rs. **359.82 LAKHS.**

B. The Bidder shall have positive Net worth for latest financial year(2023-24) of Rs. **119.94 LAKHS** as on 31st March 2024.

C. The Bidder must have experience of successful completion of similar work on its own in India within last 7 years as on date of bid submission

(a) One Project of minimum value Rs.80% of the Project Value

OR

(b) Two Projects of minimum value Rs.50% of the Project Value each

OR

(c) Three Projects of minimum value 40% of the Project Value of each

Note: Similar work shall mean Construction of Building Work as mentioned in tender documents in any of government organizations only. like **R&B/Govt./Semi Govt./PSUs/Government Undertaking /Government Companies Department**

D. Available Bid Capacity(ABC) -must be more than the estimated tender cost.

Note: Available Bid Capacity (ABC) will be derived by the following method. ABC is calculated as $ABC = 2 * A * N - B$

Where,

A = Maximum value of works executed in any one year during the last five years (updated to present price level by applying enhancement factor) taking into

account the completed as well as works in progress.

N=Number of year sprescribed for completion of the works for which tenders are invited i.e. 12/12= 1.00

B=Value of existing commitments and on-going works to be completed during that next N year (period of completion of the works for the tenders are invited.)

Note: The statements/certificate showing the value of existing commitments and ongoing works as well as the stipulated period of completion remaining

for each of the works listed should be signed by the respective Employer or his authorized representative, not below the rank of an Executive Engineer or equivalent.

E. The cost of materials supplied by the Government/Clients shall not be taken into account for experience purpose.

F. An attested copy of registration with R&B etc. **Registration required: "AA" Class & Above and Special Catogary Building-I. Bank Solvency of Current Financial Year (2024-25) (20% of Tender amount.) of any Nationalized/Scheduled Bank except Co-operative Bank.**

G. Following enhancement factors will be used for the cost of works executed and financial figures to arrive at common base or the value of the works completed in India. Cut of month shall be considered from month of tenders submission.

Year	Multiplying fa
------	----------------

	ctor
Immediate last year of the assessment year*	1.1
Second	1.21
Third	1.33
Fourth	1.46
Fifth	1.61
Sixth	1.77
Seventh	1.95

*Here assessment

year shall be reckoned from year and month in which tender is submitted.

- H. The experience of Joint Venture/Back-to-back work/Nominated Sub-contractors by agencies shall not be considered.
- I. The Bidders should submit Solvency Certificate minimum value of Rs. **(20% of Tender amount.)** issued by schedule bank / Nationalized bank only and should be valid for at least up to six months from the date of submission.
(Considering validity as 1 year from date of issue of Solvency Certificate)
- J. The Bidders should submit the list of the works already completed during last 7 year in prescribed Performa and attested copies of certificates issued by head of the office concerned for completed work.
- K. The Bidders shall submit Declaration regarding the work on hand with the bidder in prescribed Performa. Attested copies of work orders, interim certificate if any shall also be attached as supporting documents for above.
- L. The Bidders shall submit the attested copy of partnership deed, power of attorney, et c.

	<p>M. Joint Ventures shall not be allowed.</p> <p>N. Even though the Bidder meets the above criteria, they are subject to be disqualified if they have</p> <ul style="list-style-type: none"> i) Made misleading or false presentations in the forms, statements and attachments submitted in proof of the qualification requirements ; and/ or ii) During verification if it is found from client that of poor performance such as abandoning the works, for financial failure or abnormal delay in work etc. iii) Regarding Litigation, in case where Bidder or JV partner or MOU Partner is involved in illegal practice like any activities of corruption, coercive practice or debarred/blacklisted in last 2 years by Any Govt / Organization in respect of performance of Bidder / MOU partner / JV partner, BMC authority requires that bidders under this contract, observe the highest standard of ethics during the procurement and execution of such contracts. <ul style="list-style-type: none"> (1) Will reject a proposal for award if it determines that the bidder has engaged in any corrupt or fraudulent practices in competing for this contract or in past history and (2) Will reject a proposal if it found debarred/blacklisted by any State Govt. / Govt. of India/ Semi Government/ PSU in last 10 years. iv) The bidder or MOU partner
--	--

shall not be under any Insolvency/Bankruptcy code (IBC) resolution process at National Company Law Tribunal (NCLT) or under any Corporate Debt Restructuring (CDR) mode in the past 10 years in India from the date of the submission of the bid.

- O. The Bidder shall not state that in case the Bidder/MOU partner is blacklisted/stated as defaulter/banned participating in tenders by any of government agencies / semigovernment agencies/PSUs in India during last 10 years then in that case, the Bidder will be disqualified though the bidder satisfies all the pre-qualification conditions mentioned above, and the bidder will be debarred for next 3 years from participating in tender process for BMC.
- P. Bidders should be selected based on quality work done by them and if necessary tender committee will inspect bidders ongoing and completed work.
- Q. The decision of the commissioner to quality the bidder will be the final.
- R. Conditional Tenders will be outrightly rejected.
- S. The applicant must submit this confirmation letter on Rs. 300.00 stamp paper with notary for Operating and Maintenance of proposed work shall include labour, all materials, plants, plants casualities, fertilizers, pesticides, tools, watering security of premises shall be responsibility of the Tenderer during the course of work and 2 years after the time of completion certificate from authority and all charges for the same borne by the Contractor (Tenderer). 1% from every

running bill shall be deducted towards SECURITY DEPOSITE of Operating and Maintenance of proposed work. ~~IF WILL~~ ~~BEREALEASEDAFETR~~ ~~COMPLETIONPERIODOF24~~ ~~MONTHSOF~~ ~~&M.~~

- T. If work is not completed within time limit, penalty of 0.10% per month will be deducted from running bill and it will be upto 10%.
- U. FDR For EMD and SD, or bank guarantee issued by state bank of India will not be accepted. Bidder should submit FDR or bank guarantee issued by any other nationalized bank only.
- V. Bidders shall quote the rate with all taxes including GST. No extra payment for GST will be done by BMC.

VARIATION IN QUANTITIES

Schedule of prices contain estimated quantities and actual quantities as executed becomes payable at agreed rates. However, accepted rates will be valid till variation in quantities up to any extent of the quantities so specified.

- W. Other terms and conditions of the tenders shall be read and considered as a part of the tender documents. The rates/prices quoted by the bidders will be final and any sort of escalation will not be considered.

Note:

Star Rate, Price Escalation, price Variation in any items of Schedule-B / Extra item will Not be given by Bhavnagar Municipal Corporation. If Same will be stated in any Bid Documents will not be Considered.

<p><u>Remarks</u></p>	<p>: Only Offer of those shall be opened whose EMD & Tender Fee evidence is received electronically along with the bids. However, for the purpose of realization of Demand Draft, bidders shall send them in original through RPAD/Speed Post/Reg.A.D. so as they reach to the office of Executive Engineers</p> <p>- Building Dept., Bhavnagar Municipal Corporation, Bhavnagar during office hours between Dt. 16/12/2024 to Dt. 19/12/2024. Penetrative action shall be imposed for not submitting the supporting documents in original to E.E. by bidder. All the successful bids, if possible, will be physical document opened on 20/12/2024, 17:00 in presence of tender committee at the City Engineer's Office, Commercial stage will be opened after approved this tender document Bhavnagar Municipal Corporation, Bhavnagar. FDR FOR EMD OR SD, OR BANK GAURANTEE issued by state bank of India will not be accepted</p>
<p>General Terms & Conditions</p>	<p>: Bidders who wish to participate in this E-Tender will have to procure valid digital certificate as per Information Technology Act 2000. Bidders can procure this certificate from any of the Government approved certifying agency i.e. (n) Code Solution.</p> <p>DOWNLOAD OF TENDER DOCUMENT:</p> <p>The tender document for this work is available only in digital format which can be downloaded free of cost by the bidder.</p> <p>SUBMISSION OF TENDER:</p> <p>Tenderer shall submit their offer in electronic format on above mentioned website on or before the scheduled date and time as mentioned, after Digitally Signing the same.</p>

Bidders shall upload the tender documents after submitting the DD details for tender fees and EMD in form of DD/Bank Guarantee details online. The Demand Draft toward Tender Document fees can be submitted along with Earnest Money Deposit before the due date as specified above.

This should be as per details given online and it should be drawn before last date of the uploading of the tender

The intending bidders shall have to submit the following documents in Physical form along with the EMD and tender fees.

- (a) Documents required for evaluation as sought in different annexure duly digitally signed.
- (b) Power of attorney.
- (c) Company's profile and certificate of Registration of company under the law.

The Bidder should submit price Bid digitally only. **Price bid in physical form shall Not be accepted** and any such offer if received by Bhavnagar Municipal Corporation same will be out rightly rejected.

Technical bid in physical form is not required to be submitted by all bidders. However, non-submission of technical bid does not absolve bidders from and liability of the tender. Only successful bidders have to submit the technical bid duly signed in physical form upon intimation from BMC.

OPENING OF TENDER:

The Technical Bid will be opened on the specified date

	<p>online website https://tender.nprocure.com/ Bidders or their representative who wish to participate in online tender opening can log on to www.tender.nprocure.com on the due date and time, mark their presence and participate in online tender opening. Bidders who wish to remain present at Bhavnagar Municipal Corporation, only one representative of each firm will be allowed to remain present.</p>
<p>Information for online participation</p>	<ol style="list-style-type: none"> 1. Internet site address for e-Tendering activities will be www.tender.nprocure.com 2. Interested bidders can view detailed tender notice and download tender documents from the above-mentioned website. 3. Bidders who wish to participate in online tender have to register with the website through the "New User Registration" link provided on the home page. Bidder will create login id & password on their own in registration process. 4. Bidders who wish to participate in this tender need to procure Digital Certificate as per Information Technology Act-2000 using that they can digitally sign their electronic bids. Bidders can procure the same from many of the CCA approved certifying agencies, or they may contact (n) code Solution at below mentioned address and they will assist them in procuring the same. Bidders who already have a valid Digital Certificate need not to procure the same. In case bidders need any clarification regarding online participation, they can contact M/S (n) code Solution 301, G.N.F.C. Info Tower,

	<p>NeargrantBhagwatiHotel, Ahmedabad380015, India. Tel: +917926857316 Tel: +917926857317 Tel: +917926857318 E-Mail: URL: www.tender.nprocure.com</p> <p>5. Bidderswho wishtoparticipateine- Tenderneedtofilldatainpredefinedformssoften derfee,EMD, PQ(Technical)orexperiencedetailsandPricebi d only.</p> <p>6. Biddershoulduploadscancopiesofreferenced ocumentsinsupportoftheireligibilityofthe bid.</p> <p>7. Afterfillingdatainpredefined formsbiddersneedtoclickonfinalsubmissionli nktosubmittheirencryptedbid.</p> <p>BiddercanalsosubmitDocumentFees,EMD,Techn icalbiddocument&ReferenceDocumentsinhard copyifsuchinstructionsaregivenbytenderingauth ority.</p>
OfficerInvitingBids	ExecutiveEngineer, BuildingDepartment, B havnagar Municipal Corporation, Bhavnagar.
BidOpeningAuthorityMembersincommittee	(1)City Engineer (2)Executive Engineer Building Department.) (3)ChiefAccountant (4)ChiefAuditor
Address	Building Department, Bhavnagar Municipal Corporation, Sir Mangalsinhji Road, Bhavnagar
ContactPerson	For further details of any query regarding the tender Contact to: Executive Engineer (Building Department), Bhavnagar Municipal Corporation., Sir Mangal sinhji Road, Bhavnagar-364001

	Mobileno.8128207404 E-mail: building.bmcgujarat@gmail.com
--	---

Date : /11/2024
Place: Bhavnagar

**Executive Engineer
Building Department
Bhavnagar Municipal Corporation**

FORM B- 1

OMD" B v!

**EXECUTIVE ENGINEER, BUILDING DEPARTMENT,
BHAVNAGAR MUNICIPAL CORPORATION,
BHAVNAGAR**

**PERCENTAGE RATE TENDER AND CONTRACT FOR
WORKS**

SFDM DF8G] 8SFJFZL NZJF/] 8fj0Z VGI SMg8FS8

Name of Work:

કામનું નામ

**PROPOSED DEVELOPMENT OF NIGHT SHELTER
AT FULSAR, FOR BHAVNAGAR MUNICIPAL
CORPORATION, BHAVNAGAR**

Division:-

**EXECUTIVE ENGINEER, BUILDING DEPARTMENT,
BHAVNAGAR MUNICIPAL CORPORATION,
BHAVNAGAR**

8fj0Z VF%I F TFZLB TFP **As per NIT** 8fj0Z : JLSFZJFGL Kf, L TFZLB TFP ...**As per NIT** (Online)
; DI 0 SRZLGF SFDSFHGF 18:00 S, FSM; jwl

Issue To - શ્રી

G[VF%I P

IJEFULI IC; FAGLX

OPENED BY

The City
Engineer, in presence of tender Committee
Bhavnagar Municipal Corporation,
Bhavnagar

ON DATE

**EXECUTIVE ENGINEER,
BUILDING DEPARTMENT,
BHAVNAGAR MUNICIPAL
CORPORATION, BHAVNAGAR**

SFI 5F, S . HGZ

MEMORANDUM OF WORKS IN BRIEF

1. Name of work : **PROPOSED DEVELOPMENT OF NIGHT SHELTER AT FULSAR, FOR BHAVNAGAR MUNICIPAL CORPORATION, (B.M.C) BHAVNAGAR**

2. Estimated Cost : Rs. **11,99,40,841.00**

3. Earnest Money : Rs **12,00,000.00**

4. Validity period of tender offered **180 days from the stipulated date of receiving of the tender but no modification shall be allowed after the last submission date of tender.**

5. Security Deposit

(i) Demand Draft of Nationalized Bank :- **7.5% of contract value**

(ii) In the form of small savings : **NIL**

(iii) To be deducted from bills : **2.5% of running bill amount**

(iv) Performance Bond : **NIL**

TOTAL : 10%

6. Time allowed for completion of the work : **32 months (INCLUDING MONSOON PERIOD)**

7. Other details

(I) The tender must be submitted to **EXECUTIVE ENGINEER,
BUILDING DEPARTMENT,
BHAVNAGAR MUNICIPAL CORPORATION,
BHAVNAGAR by e-submission as
per the schedule mentioned in the tender
notice**

(ii) Mode of Sending the tender : as mentioned in the tender notice

(iii) Description essential to be NA

made on sealed cover :

(iv) Mode of quoting rate : Figures as well as in words in Schedule "B"

TENDER

Date: _____

To,
Executive Engineer,
BUILDING DEPARTMENT,
Bhavnagar municipal Corporation,
BHAVNAGAR.

Dear Sirs,

We hereby offer to execute the proposed work **PROPOSED DEVELOPMENT OF NIGHT SHELTER AT FULSAR, FOR BHAVNAGAR MUNICIPAL CORPORATION ,(B.M.C) BHAVANAGAR**

Under PERCENTAGE RATE contract at the respective rates as mentioned in the accompanying schedule of quantities and rates (schedule-B).

We have studied the site and have read the terms and conditions of work, drawings, special conditions, articles of agreement, conditions of contracts and specifications.

We agree to finish the entire work within **32 (thirty Two) months** (INCLUDING MONSOON PERIOD)from the date of order for commencement of work.

We have deposited as earnest money a sum of **RUPEES ELEVEN LAKHS NINTY NINE THOUSAND FOUR HUNDRED NINE ONLY** with you, which amount is not to bear any interest and we do hereby agree that this sum shall be forfeited by you if we fail to execute the contract when called upon to do so, in the event of your accepting our tender.

Yours faithfully,

Name in capital letters : _____

Name of firm : _____

Name of directors : _____

Name of partners : _____

TENDER TO BE SUBMITTED BY e-submission as mentioned in the tender notice

Article of Agreement

This Articles of Agreement is made on the ___day of ___2024 between The Executive Engineer, BUILDING DEPARTMENT, Bhavnagar Municipal Corporation, Bhavnagar. (here in after called " The Owner ")

On one part an _____

Whose registered office is situated at

(here in after called "The Contractor") of the other part

WHEREAS the owner is desirous of constructing **PROPOSED DEVELOPMENT OF NIGHT SHELTER AT FULSAR, FOR BHAVNAGAR MUNICIPAL CORPORATION, (B.M.C) BHAVANAGAR** (here in after called "The Work") at Bhikda canal near shampara bridge, Bhavnagar, and has caused Drawings and Bills of Quantities showing and describing the work to be done and prepared by and under the direction of **Architect CHINTAN SACHAPARA** and whereas the Contractor has supplied the owner with a full priced copy of said Bills of Quantities (which copy is here in after referred to as "the Contract Bills") and whereas the said Drawings (here in after referred to as "the Contract Drawings") and the Contract Bills have been signed by or on behalf of the parties here to: and whereas the Contractor has deposited the sum of **RUPEES ELEVEN LAKHS NINETY NINE THOUSAND FOUR HUNDRED NINE ONLY** with the Owner for the due performance of this Agreement.

NOW IT IS HEREBY AGREED AS FOLLOWS :

1. For the consideration here in after mentioned the Contract will upon and subject to the conditions annexed carry out and complete the work shown upon the contract drawings and described by or referred to in the Contract Bills and in the said conditions.
2. The Owner will pay the Contractor the sum of **(RUPEES ELEVEN CORERS NINETY NINE LAKHS FORTY THOUSAND EIGHT HUNDRED FORTY ONE ONLY)** (here in after referred to as "the Contract Sum") of such other sum as shall become payable here under at the times as in the manner specified in the said conditions.
3. The term "The Architect " in Conditions shall mean the said
CHINTAN SACHAPARA
ARCHITECTS

3, SHAHIBAUG, ABOVE HOME DÉCOR, WAGHA WADI ROAD,
BHAVNAGAR
PHONE : 9428401640
4. or in the event of his death or ceasing to be the Architect for the purpose of this Contract, such other person as the Owner shall nominate for that purpose, not being a person to whom the Contractor shall object for reasons considered to be sufficient by an arbitrator appointed in accordance with the said Conditions Provided always that no person subsequently appointed to be the Architect under this contract shall be entitled to disregard or overrule any certificate or opinion or decision or approval or instruction given or expressed by the Architect for the time being.
2. The said condition and appendix there to shall be read and construed as Forming part of this Agreement, and the parties hereto shall respectively abide by, submit themselves to the conditions and perform the agreements on their parts respectively in such conditions contained.

AS WITNESS the hands of the said Parties.

Signed by the said
in the presence of

Owner

Witness : _____

Name : _____

Address : _____

Signed by the said

Contractor.

Witness : _____

Name : _____

Address : _____

Bank Guarantee is applicable only when the estimated cost of work is more than Rs. 50 lacs.

BANK GUARANTEE

Where _____ as _____ M/s
_____ (hereinafter
called _____ the Tenderer) is desirous and preferred to tender for works
in accordance with the terms and conditions of tender for the work of
**PROPOSED DEVELOPMENT OF NIGHT SHELTER AT FULSAR, FOR
BHAVNAGAR MUNICIPAL CORPORATION, (B.M.C) BHAVANAGAR**
and where as We Bank, agree _____ to give the tenderer a guarantee for the Earnest Money.

1. Therefore, we hereby affirm that we are guarantors on behalf of the Tenderer up to total rupees _____ in words) Rs. _____ (in figures) and we undertake to pay to The Commissioner, Bhavnagar Municipal Corporation, Bhavnagar up to his first written demand, without demur, without delay and without the necessity of a previous notice of judicial or administrative procedures and without the necessity to prove to the Bank the defects or shortcomings or debits of the contractor any sum within the limit of Rs. _____.
2. We further agree that the Guarantee herein contained, shall remain in full force and effect during the period that would be taken for the acceptance of tender. However, unless a demand of claim under this guarantee is made on us in writing on or before the _____ (Date to be specified – will not be less than 180 days from the stipulated date of receiving the tender) we shall be discharged from all liabilities under the guarantee thereafter.
3. We undertake not to revoke the guarantee during its currency except with the previous consent of, The Commissioner, Bhavnagar Municipal Corporation, Bhavnagar in writing.
4. We lastly undertake not to revoke the guarantee for any charge in constitution of the Tenderer of of the Bank.

Date

Signature & Seal of

Guarantor _____

Bank Address _____

5. The contractor shall have to furnish PAN and intimate I.T. ward under which he is accessed.
6. Copies of certificated as regards previous experience, if any, must accompany the tender.
7. Declaration showing all works on hand with the Contractor and the value of works that remains to be executed in each case must accompany the tender.
8. All pages of Schedule 'A' and 'B' and specifications should be initialed by the Contractor.
9. All corrections, erasures and overwriting should be initialed by the Contractor.

10. Discrepancies and adjustment of Errors :

Any error in quantity or amount in Schedule 'B' showing items of work to be carried out shall be adjusted in accordance with the following rules.

- (a) In the event of a discrepancy between description in words and figures quoted by a tenderer in the rates column, the description in words shall prevail.

(b) In the event of an error occurring in the 'amount' column of the Schedule 'B' showing items of work, as a result of wrong multiplication of the unit rate and quantity; the unit rate shall be regarded as firm and multiplication shall be amended on the basis of the rate.

(c) All errors in totaling in 'amount' column in carrying forward totals shall be corrected.

(d) Any rounding of amount against "items" or in "totals" shall be ignored.

P

The tendered sum so altered shall for the purpose of the tender be substituted for the sum originally tendered and considered for acceptance.

10. (i) It may please be noted that the tender will be considered as invalid, especially, if the requirements as per instruction No. 1 to 10 above are not complied with before submitting the tender. Also please read carefully the face sheet and 'General Rules and Directions for the guidance of contractor's of this form.

(ii) Right is reserved to reject any or all tender(s) without assigning any reason(s) therefore.

10-A The tender documents shall have to be filled in either ink or by ball pen.

11. In addition to the above, the tender will also be liable to be rejected outright if-

(i) The tenderer proposes any alteration in the work specified or in the time allowed for carrying out the work or any condition or correction in any code or mode of Schedule 'B' or specifications.

any of the page of the tender is/are removed or replaced.

(ii) all corrections, additions or pasted slips are not initialed by the tenderer.

(iii) Any erasure is made by him in the tender and.

(iv) The tenderer or in the case of a firm, each partner or the person holding the power of attorney thereof does not sign or signature is/are not attested by a witness on page 15 of the tender in the space provided for the purpose.

11. A certificate of registration as approved contractor should be attached with tender.

Pages 5 & 6 are E-tendering of B-1 Tender Forms only

DATA SHEET for B-1 E-Tendering

(A) Details of Tender Item :-

Sr. No.	Name of Work	Estimated Tender Value (Rs. in lacs)	EMD (Rs. in lacs)	Tender fee in Rs.	Total Security Deposit @ 10%	Period for Completion of Work
1	2	3	4	5	6	7
1	PROPOSED DEVELOPMENT OF NIGHT SHELTER AT FULSAR, FOR BHAVNAGAR MUNICIPAL CORPORATION, (B.M.C) BHAVANAGAR	11,99,40,841.00	12,00,000.00	18000/- +18% GST= 21,240.00(Non refundable)	1,19,94,085.00	32 Months (INCLUDING MONSOON PERIOD)

(B) **Eligibility: Registered in "AA" Class and Above And Sp cat Building-I.**

- (C) Schedule for e-tendering is fixed as under:
- (i) Site Visit (if any) Bidder should visit before filling the tender.
 - (ii) Dowloading of tender documents **From Date As per NiT.**
Start & End Date Upto Date As per NiT .
 - (iii) Online submission of bid Upto Date As per NiT.**
 - (iv) Submission of EMD, Tender fee Submmision in electronic format only through Online by scanning and then the same should Be sent in original to **EXECUTIVE ENGINEER, BUILDING DEPARTMENT, BHAVNAGAR MUNICIPAL CORPORATION, BHAVNAGAR**
by As per NiT Evaluation done by Submitted hard copy only.
 - (v) Online Opening of Bid on Date As per NiT**
 Venue: The City Engineer, in presence of tender Committee Bhavnagar Municipal Corporation, Bhavnagar
 - (vi) Bid Validity period **180 Days from the end date of Downloading Bids.**
 - Bidders can download the tender documents free of cost from the website www.tender.nprocure.com
 - Bidders have to submit bid in Electronic format on above mentioned website till the date & time shown above.
 - Offers (Financial Bid) in physical form will not be accepted in any case.
 Bidders who wish to participate in online tenders will have to procure / should have legally valid Digital Certificate (Class-III) as per information Technology Act-2000 using which they can sign their electronic bids. Bidders can procure the same from any of the license certifying Authority of India or can contract (n) code solution – a division of GNFC Ltd., who are licensed certifying Authority by Govt. of India.
- (D) (i) Bid Inviting authority **EXECUTIVE ENGINEER, BUILDING DEPARTMENT, BHAVNAGAR MUNICIPAL CORPORATION, BHAVNAGAR**
- (ii) Bid Opening Authority The City Engineer, in presence of tender Committee Bhavnagar Municipal Corporation, Bhavnagar
- (E) Mode of Quoting Rates Percentage premium or rebate in words and figures

The list of certifying agencies are as mentionrd under:

<u>Sr. No.</u>	<u>Name of certifying Agency</u>	<u>Website address</u>
1.	(n) Code solution (G.N.F.C)	www.gnvfc.com
2.	Safecrypt	www.safecrypt.com
3.	TCS	www.tcs.-ca.tcs.co.in
4.	MTNL	www.mtnltrustline.com

at the end of Schedule-B

As a result of E-tendering the information / Instructiond on Pages 7 to 13 following may be read as modified below:-

Page - 7: para 5 is deleted and Paras 4, 9 and 12 on these pages are substituted as under.

NOTICE INVITING TENDER:

4. Bid document can be downloaded & Submitted in Electronic Format on web site

www.tender.nprocure.com from **per NiT**

9. The bidder should quote his bid premium or rebate at the end of schedule B. If he do not wish to quote premium or rebate, he should indicate "at par" in the blank space preceding "% above / below" in schedule B. Thereafter he should work out and indicate the offered bid amount both in words and figures in schedule B.

12. The Technical bid will be opened at 16.00 hours on **As per NiT** in the presence of bidderes who may choose to remain present in the office of the Bid opening Authority Specified in bid document.

Page-8 Vf 5FGf p5ZGL ; RGF ZP! GLR[D]HA ; WFZL JFRJL VGF; RGF \$ TYF 5 ZN U6JLP

2.1(i) The Financia; Bids shall be offered in Electronic format only on online website www.tender.nprocure.com till the date and time shown on Page 2 supra.

(ii) **Payment of tender fee and earnest money deposit:** Demand draft for E.M.D. & tender fee shall be submitted in electronic format only through online (by scanning)while uploading the bid.This submission shall mean that E.M.D. & tender fees **in DD format** is received for purpose of opening the bid.Accordingly offer of those shall be opened whose E.M.D.

& tender fees is received electronically.However for the purpose of realization of D.D. bidder shall send the D.D in original to **EXECUTIVE ENGINEER, BUILDING DEPARTMENT,**

BHAVNAGAR MUNICIPAL CORPORATION, BHAVNAGAR by **As per NiT** till 15:00 hours.

Any documents in supporting of tender bid shall be submitted in electronic formate through online (by scanning etc.) & haed copy will be accepted separately.” if tender fee and E.M.D. is not paid as shown in bid document action to hold his registration in abeyance shall be taken and his E-tendering code will be cancelled for one year.(dated 18-1-2008 & 27-11-2008)

page-9 Instructuion 8: words "digitally" be added between "be" and "Initialled"

Instruction 9, 10, 10A and! ZS are deleted

Instruction 11: is renumbered as 9 and subtited as under: - "9" In addition to the above, the bid will also be liable to be rejected if :-

(i) The bidder proposes any alteration in the work specified or in the time allowed for carrying out the work or any condition or correction made in any code or mode of Schedule-B or Specifications.

(ii) The bidder or the person authorised to sign on behalf of the bidder does not digitally sign the bid offer.

Page-11 The writing in lower part of this page begining with "OR" is deleted and Rules 2 and 4 are modofied as under:-"2" The bidder or the person authorised to sign digitally on bahalf of the bidder shall sign the bid document. The Copy of legal status of bidder (partnership Deed or Articles of Association of the Company) alongwith authority to sign digitally on behalf of the bidder will be frnished alongwith other documents to be despatched physically. "4" The words "at what rate, he is willing to undertake each items of work in second line of this instruction may be substituted to read as at what percentage above or below he is willing to undertake the work"

Page-12 Instruction No. 11 is deleted.

Page-13 Instruction No. 17 is substituted as under.

Signature of the contractor:

Signature of the
**EXECUTIVE ENGINEER,
BUILDING DEPARTMENT,
BHAVNAGAR MUNICIPAL CORPORATION,
BHAVNAGAR**

NOTICE INVITING TENDERS

1. Tenders are inviting on behalf of Governor of state of the Gujarat for work as per page number on of this booklet. The work is estimated to cost of **Rs11,99,40,841.00** this estimate however, is given as a rough guide.
2. **The work are required to be completed within 32 Months(Including monsoon period) as per the terms of the contract conditions.**
3. The contractor whose name is borne of the approved list of contractors of Gujarat State R&B Dept/W.R.D. with **"AA" Class & Above AND Sp Cat Building-I with Roads and Building Deptt. Of Govt. of Gujarat** will be permitted to tender. Not more than one tender shall be submitted by a contractor or by a firm of contractors. No two or more concerns in which an individual is interested as a proprietor and/ or a partner shall tender for the execution of the same work .if they do so, all such tender shall be liable to be rejected.

4. Applications for issue of tender documents shall be submitted to
**EXECUTIVE ENGINEER, BUILDING DEPARTMENT, BHAVNAGAR MUNICIPAL CORPORATION,
BHAVNAGAR** So as to reach his office not later then DATE as per mentioned time

5. Tender documents consisting of condition, specification, Schedule(s) of quantities of the various classes of work to be done, the conditions of contract etc. will be issued on (date) Dt. **As per NiT**
6. Copies of other drawings and documents pertain to tender and signed for the purpose of identification by the Accepting Officer or his accredited representative will be open for inspection by tender at the following offices during working hours between the dates mentioned in clause 5 above.
(a) **EXECUTIVE ENGINEER, BUILDING DEPARTMENT, BHAVNAGAR MUNICIPAL CORPORATION, BHAVNAGAR**
(b)
7. Tenderer are advised to visit the site sufficiently in advance of the date fixed for submission of the tender. A tenderer shall be deemed to have full knowledge of all the relevant documents samples, site etc. whether he inspects them or not.
8. Submission of a tender by tenderer implies that he has read this notice and all other contract documents and has made himself aware of the scope and specification of the work to be done and of conditions and rates at which stores, tool and plant etc. will be issued to him, by Government and local conditions and other factors bearing on the execution of the works.
9. A tender should quote in figures as well as in words the rate(s) tendered. The amount for each item should be worked out and the requisite total given. Special care shall be taken to write rates in figures as well as in words and the amount in figures only and in such a way that interpolation is not possible. The total amount shall be written both in figures and in words. In case of figures the words Rs. should be written before the figure of rupees and the words 'paise' after the decimal figure e.g. Rs. 2.15 p. and in case of words the words 'Rupees' should precede and the words 'paise' should be written at the end. Unless the rate is in whole rupees and followed by the word 'only', it should invariably be upto two places of decimal.
10. All rates shall be quoted on the tender form.
11. The tender for the works shall not be witnessed by a contractor or a contractor who himself / themselves has/have tendered or who may and has/have tender for the same works. Failure to observe this condition shall render the tender of the contractor tendering, as well as of those witnessing the tender, liable to rejection.
12. Tender shall be received Registered Post A.D/Courier by **As per NiT** shall be opened on **As per NiT** in the presence of tenders who may be present as per the rule of 4" General Rules and Directions for the Guidance of Contractors" Printed in this form.
13. ~~In the case of contractors who have not furnished standing security, the tender shall have to furnish earnest money. Treasury Challan / Deposit at call Receipt issued in favour of "Managing Director, Tourism Corporation of Gujarat Ltd, Gandhinagar Payable at Gandhinagar" by a scheduled or Nationalized bank . A contractor exempted from depositing earnest money/security in individual case (s) shall attach with the tender an attested copy of the letter exempting him from depositing earnest money/security and shall produce the original when called upon to do so.~~
14. A tender shall submit the tender which satisfied each and every condition laid down in this notice and tender documents, failing which the tender will be liable to be rejected.
15. The Governor of the State of Gujarat/ **The Commissioner, Bhavnagar Municipal Corporation, Bhavnagar** does not bind himself to accept the lowest or any tender or to give any reasons for the decision.
16. This notice of tender shall form part of the contract documents For and behalf of Governor for the state of Gujarat/ **The Commissioner, Bhavnagar Municipal Corporation, Bhavnagar**
17. **The Commissioner, Bhavnagar Municipal Corporation, Bhavnagar, reserves the rights to reject any or all tenders without assigning any reason thereof.**

Date:

Signature.....
Designation.....

FORM - B 1 / OMD" v B !

**EXECUTIVE ENGINEER, BUILDING DEPARTMENT, BHAVNAGAR
MUNICIPAL CORPORATION,
BHAVNAGAR**

PERCENTAGE TENDER AND CONTRACT FOR WORKS

SFDM DF8[G] 8SFJFZL v NZJF/ 8gOZ VG[SM8FS8

ADDITIONAL INSTUCTIONS TO PERSONS TENDERING 8gOZ EZGFZG[JWFZFL ; JRGFVM

1. **Competency of Tender** – No contract will be awarded except to responsible bidders capable of performing the class of works contemplated. Before the award of the contract, any bidder may be required to show that he has the necessary facilities, experience, ability and financial resources to perform the work in satisfactory manner within in the time stipulated. Contractor may be required to furnish the department with the statement as to their experience and their financial status.
2. Tender will be deemed to have inspected the site and to have satisfied as to the nature of all works, all existing roads, water-way and other means of communication and access to and from the site and work and the building that may be required for temporary purpose in connection with the construction, completion and maintenance of the works and must make his own inquiries as to work, yard sites and depot, and dumps and as to acquisition of such additional sites and areas as may be necessary for temporary purpose for constructing, completing and maintaining the works.
- 2.1 The tenders shall be received only under “**Registered Post**” ‘or’ by Express Delivery should be adopted under any circumstances
 I : Late tenders (i.e. tender received after the specified time of opening), delayed tenders (i.e. tenders received before the time of opening but after due date and time of receipt of tenders) and post tenders offers shall not be opened and considered at all.
 II : The tenders received after time & the date specified in the tender notice shall not be received by the concerned office,
 III : Necessary records should be maintained for refusal of such tenders in the registers for receiving tenders and should be initialed by the concerned Engineer.
- 3 **Payment:-** The tender must understand clearly that the rates quoted are for completed works and include all costs due to labour, scaffolding plant, supervision, service works, power, royalties and octroi etc. , and to include all extras to cover the cost of night work if and when required and no claim for additional payment beyond the price/rates quoted will be entertained and the tenderer will not be entitled subsequently to make any claim on the ground of misrepresentation or on the ground that he was supplied with information given by any person (whether the member is the employee of Public Works Department or not) . Any failure on his part to obtain all necessary information for the purpose of making his tender and filling the several prices and rates therein shall not relieve him from any risks or liabilities arising out. Of or consequent upon the submission of the tender.
4. **Tender Forms** – Every ‘blank’ in the form of the tender and in the schedule must be filled up by the tenderer and must return the document sent herewith.
5. Erasures- Person tendering are informed that no erasures or alterations by them in the text of the document sent herewith will be allowed and any such erasures or alternations will be disregarded.If there is any error in hiswriting,no overwriting should be done,the wrong word or a figure should be struck out and the correct one written above or near it in unambiguous way.Each correction should be initialed.

Contractors to please read this Carefully: SM8FS8ZIM[GLRGL AFATMSF/HL 5]JS JFRJF IJGTL KP

1. The percentage in Schedule ‘B’ must be given in words and figures. Amount thus worked out must also be entered in column and grand total of amount must be struck out by the tenderer.
- 1P JW[S]VMKFLG 8SFJFZLGF NZ XaNM TDPH VFSOFDF VF5JFP 8gOZ EZGFZ[VF ZLT[AGTL ZSD 56 BFGDFAGMJJL VG[ZSDGM[S] ; ZJF/MDSJMP
2. If the tender is taken in favour of the company, a power of attorney in favour of the person who may have signed the tender for the company must accompany the tender.
- ZP SM. S5GLG[GFD[8gOZ , JFDVVFj I]CMI TM S5GL JTL 8gOZ 5Z ; CLSZGF j I ISTG[VIWST SZT]DBt I FZGFD]8gOZ ; FY[ZH] SZJFGZCXF
3. ~~Solvency certificate of a Bank of an amount up to 20% of the tendered cost plus the amount of works on hand still to be executed will have to be produced by the contractor.~~
- #P 8gOZDA EZL S] BR" Jttf AFSL CMI TjF CFY WZL A5FDGL ZSDGF Z_ 8SF HB, I ZSD VU[ABC]5DF65+ SM8FS8ZLZH] SZJFGZCXF
4. ~~Challan for earnest money @ 1% of the estimated cost must accompany the tender. Tenderer may pay earnest money up to Rs.50,000 in cash or in the form of Crossed Demand Draft or fixed deposit of~~

~~fixed deposit at call receipts with a validity period of not less than six months of Nationalised or Scheduled or Co-operative Bank having 5 year standing drawn in favour of Managing Director, Tourism Corporation Executive Engineer/Divisional Officer concerned. Earnest money by cheque & Bank Guarantee shall not be accepted. vide R & BD G.R. No. TNC/1090/(100) (4) C dated 4-11-2000) However in respect of the works estimated to cost above Rs. laes, the amount of earnest money in excess of Rs..... can be offered by the contractor, at his choice, in the form of Bank Guarantee of the Scheduled Bank or Nationalised Bank only. The Bank Guarantee in such cases will be furnished in the following form. In such cases also, the amount of earnest money first Rs.50,000 will paid only in the form of cash or crossed demand drafts or fixed deposit receipts or deposit at call receipts worth the validity period of not less than 6 months of the nationalised or Scheduled or Co-operative Banks having five years standing.~~

If the contractor do not turn up to pay the Security Deposit and execute contract agreement within specified (or extended) time after intimation to him about acceptance of this offer, the earnest money paid for this work will be forfeited and according to clause -1 of this tender form tenderer's tender shall be rejected and then according to aforesaid provision of tender, action to blacklist the contractor will be initiated without Delay.

5. The contractor shall have to furnish Income Tax Clearance Certificate before his tender is accepted and intimate assessment number and ward under which he is assessed.

5P 5MTFG) 8g0Z : JLSZF1 T| 5C| F Sltg8S8Z| VFJSJZF| RST| S| FG| 5DF65+ ZH| SZJ| 50X| VG| VFSFZ6L GAZ VG| H| C9/ VFSFZ6L SZF. CMI T| JF| VUJG| HF6 SZJFGL ZCXP

6. Copies of certificate as regards previous experience, if any, must accompany the tender.

&P VUfpGM SM. VG| EJ CMI TM T| VUJG| 5DF65+ GL GS, M 8g0ZM; FY| ZH| SZJFGL ZCXP

7. Declaration showing all works on hand with the Contractor and the value of works that remains to be executed in each case must accompany the tender.

*P NZS S| DASltg8S8ZGF CFY 5ZGF AWF SFD VG| SZJFGL AFSL CMI T| JF SFDGF D| I VUJGM V| SZFZ 8g0Z ; FY| SZJFGM ZCXP

8. All pages of Schedule 'A' and 'B' and specifications should be initialed by the Contractor.

(P VG|)R cSc VG| cBc GF TDFD 5FGF VG| IJUTM 5Z Sltg8S8Z| 8S| ; CL SZJLP

9. All corrections, erasures and overwriting should be initialed by the Contractor.

)P TDFD ; WZF4 KSKFS VG| WBJ, F , BF6 5Z Sltg8S8Z| 8S| ; CL SZJLP

10 Discrepancies and adjustment of Errors : S; Z VU| IJ; UIT VG| IC; FA HMU 0

Any error in quantity or amount in Schedule 'B' showing items of works to be carried out shall be adjusted in accordance with the following rules.

CFY WZJFGF SFDI GL AFAT NXFJTL VG|)R cBc DFGF HyYF VYJF ZSDGL SM. 56 E|, R\$ GLRGF IGI DM VG| FZ ; ZEZ SZJFDFVFXP

a) In the event of a discrepancy between description in words and figures quoted by a tenderer in the rates column, the description in words shall prevail.

sSf 8g0Z EZGFZ| NZGF BFGFDFV H6FJ|, XaNMI VG| VFSOF J rR| SM. V; UITGF S| DFXaNMDFA H6FJ|, ZSD Dfg| ZFBJFDFV VFXP

b) In the event of an error occurring in the 'amount' coloumn of the Schedule 'B' showing items Of work, as a result of wrong multiplication of the unit rate and quantity; the unit rate shall be regarded as firm and multiplication shall be amended on the basis of the rate.

sBf VSD NZ VG| HyYFGF BMBF U| BfSFZGF SFZ6| SFDGL AFATM NXFJTL VH|)R cBc GF BFGFDFV L ZSDDFV E|, H6F1 TM VSD NZ Dfg| ZFBJFDFVFX| VG| NZGF VFWFZ| U| BfSFZ ; WZFJFDFVFXP

c) All errors in totalling in 'amount' column in carrying forward totals shall be corrected.

sUF ZSDGF BFGFDFV L TDH VFU/ BRTE ; ZJF/ FGL TDFD E|, M ; WZFJFDFVFXP

d) Any rounding of amount against "items" or in "totals" shall be ignored.

sWf cAFATM c VYJF c; ZJF/ Fcc ; FD| 5Z| VFSQ| SZ|, SM. 56 AFAT w| FGDA, JFDFVFX| GCLP

The tendered sum so altered shall for the purpose of the tender be substituted for the sum originally tendered and considered for acceptance.

8g0Z Df8| 8g0Z DFXNXFJ|, ZSDDFV SZJFDFVFX|, VF 5\$FZGF QZOFZ 8g0Z DFX EZ|, ZSDG| AN, | D\$| : JLS TL Df8| IJRFZJFDFV VFXP

10. i) It may please be noted that the tender will be considered as invalid, especially, if the requirements as per instruction No.1 to 10 above are not complied with before submitting the tender. Also please read carefully the face sheet and 'General Rules and Directions for the guidance of contractor's of this form.

! _P| P 8g0Z ZH| SZTF 5C| F BF; SZLG| p5ZGL ; RTF G| YL ! _ DFGL H-ZL| FTMG| 5F, G SZJFDFVFX| I| GCL CMI TM 8g0Z VDFg| U6JFDFVFX| T| GL GIMV , JF IJGTL KP J/L VF OMDG| DJB 5Q8 VGSltg8S8ZGF DFUNXG Df8| ; FDFg| IGI DM VG| ; RGVIM 56 SF/HL5| JS JFRJF IJGTL KP

10. ii) Right is reserved to reject any or all tender(s) without assigning any reason (s) therefore.

! _P ZP SM. 56 SFZ6 NXFJ| F| ; JF| SM. 56 S| AWF 8g0Z MV : JLSFZ SZJFGM CS VAFIWT ZC| KP

10-A The tender documents shall have to be filled in.

11. In addition to the above, the tender will also be liable to be rejected outright if
- The tenderer proposes any alteration in the work specified or in the time allowed for carrying out the work or any condition or correction made in any code or mode or Schedule 'B' or specifications.
 - Any of the page of the tender is/ are removed or replaced
 - All corrections, additions or pasted slips are not initialed by the tenderer.
 - Any erasure is made by him in the tender and.
 - The tenderer or in the case of a firm, each partner or the person holding the power of attorney thereof does not sign or signature is /are not attested by a witness on page, 15 of the tender in the space provided for the purpose.

12. A certificate of registration as approved contractor should be attached with tender.

! f p5ZGL AFATM p5ZAT 8p0Z GLRf; HUMDATZT VDFgl 9ZJFG[5F+ YXP
 i) The tenderer proposes any alteration in the work specified or in the time allowed for carrying out the work or any condition or correction made in any code or mode or Schedule 'B' or specifications.
 ! f 8p0Z EZGFZ4 IGI T SFD VYJF SFD DF8[DHZ SZ, VYJF VG;]R B GF SM. SMO VYJF 5wWIT VYJF IJUTMDADSI, XZT VYJF ; WZFDFASM. 0ZOFZ ; RJTF CMI P
 ii) Any of the page of the tender is/ are removed or replaced
 Zf 8p0ZG)SM. 5FG)S)5FGF SF-L GfbI)q GfbI F CMI S)AN<1)q AN<I F CMI
 iii) All corrections, additions or pasted slips are not initialed by the tenderer.
 #f AWF ; WZF WZF VYJF RIBFO, L SF5, LVM p5Z 8p0Z EZGFZ[8S; CL G SZL CMI
 iv) Any erasure is made by him in the tender and.
 \$f 8p0ZDATD6)SM. KSKFS SZL CMI 4 VG
 v) The tenderer or in the case of a firm, each partner or the person holding the power of attorney thereof does not sign or signature is /are not attested by a witness on page, 15 of the tender in the space provided for the purpose.
 5f 8p0Z EZGFZ VYJF 5f-LGL AFATDANZS EFULNFZ VYJF T[VUG)DBtI FZGFD)WZFJGFZ jI IST ; CL G SZ[VYJF 8p0ZGF 5FGF ! 5 p5Z T[DF8]ZFBJFDAVVFJ, L HuI FDA; CL q ; CLVM p5Z SM. ; F1RLV[; FB SZL G CMI P

GFW6L JU"	DHZ NZ[SB, L ISDTG)SFD OF/JFX]	GFW6L JU"	DHZ NZ[SB, L ISDTG)SFD OF/JFX]
V	-FP ; FT , FB ; WL	S	-FP A[, FB ; WL
A	-FP RFZ , FB ; WL	0	-FP ; F. 9 CHEZ ; WL

p5I)ST ISDT ; AWL DI INF ; DU)SFDGL DHZ YI, ISDT VUGL KP H)SFDGF EFU, F 5FOJFDAVf)I F CFI tI FZ, FU)50TL GYLP CFY 5ZGF ; 3/F SFD)GL DHZ YI, ISDT TYF IJRFZ6F CP/GF SFDGL ISDT ; ICT SFD)GL S, ISDT4 ; CSFZL DO/L H) JUDAZHL:8Z Y. CFI TGL GF6)SLI DI INFYL +6 U6L ZSD SZTRJWTL G CFI TH ; CSFZL DO/L IJRFZ6F CP/G)SFD DJ/JJF CSSNFZ YXP
 VF P5ZAT GLR)DHAGABF; 5SFZGATDH JWD, ; FD; G J5ZFT)CFI T)5SFZGFALR)H6FJ, SFD)56 DHZ ; CSFZL DO/LG)VF5JF5F+ GYLP
 ! f DF, ; FDFG JCG VUGFP
 Zf 5FTF/SJF XFZSD VUGF
 #f pt5FINT DF, ; FDFG S)Vg) DF, ; FDFGGL BZLNL S)5ZF 5FOJF AFATP
 \$f 5f 8 Sg8f, 4 JFBZ 5)DU TYF S, Z SFD)HJF BF; 5SFZGASFDP
 5f C)BDLTF %, Fg8 V)G)5JZ OLGLXZGASFD)
 &f U, 4 V)F5L, 4 X8; 4 AFZVF)GAU, F; 5G, 4 R, GCLh4 Afa0)JFI Z 0g; LU TDH VF 5SFZGAVg) SFD)H)DR)5DF6DA DF, ; FDFG J5ZFT)CFI P
 sVFWFZ HFCZ ARWSFD IGUD ; U)C EFUV! GFOSZ)Z_ \$ TYF DF2DP IHP GATEZLBv !)v&v() TYF #vZvZ___ TYF TTP Z_v*vZ___Z GF 9ZFJFP

Tender documents for work as specified on Page no, -1 of this Booklet

DECLARATION FORM V(SZFZG)OMD"

- I/We hereby declare that I/We have visited the site and fully acquainted myself/ourselves with the local situations regarding materials, labour and other factors pertaining to the work before submitting this tender.
 ! P C)q VD)VFYL V)SZFZ S~ K)q SZLV)KLV)S)VF 8p0Z ZH)SZTR5C, F DP q VD) :Y/GL D, FSFT , LWL K)VG)SFDG) , UTF DF, ; FDFG4 DHZ VG)AL)AFATMG), UTL : YFIGS 5IZI: YTLGL HFTvDFCLTL D)JL KP
- I/We hereby declare that I/We have carefully studied the conditions of contract, specifications and other documents of this work and agree for execute the same accordingly.
 ZP C)q VD)VFYL V)SZFZ S~ K)q SZLV)KLV)S)VF SBFS8ZGL XZTMGL IJUTMVG)8p0ZG), UTF N: TFJHMSF/05)JS Vel F; SIMK) VG)T)DHA TGMVD, SZJF ; DT K)q KLV)
- We have to receive payments,if delay is due to late receipt of grant-in-aid from Government for oanchayat works.(Applicable to panchayat works only)

DECLARATION CERTIFICATE (G.R. date 4-2-89 as revised by GR. No.TNC – 1083/6681/4/C, dated 31-8-1994)

(iv) I/We hereby declare that my/our near relative are not working in this Division or in its sub-division as an Ex.Engineer, Deputy Executive Engineer, Assistant Engineer, Additional Assistant Engineer, overseer, Divisional Accountant , Store, Keeper, or as incumbunt in BHAVNAGAR MUNICIPAL CORPORATION at today.

\$P C]q VD[VVYL V\$ZFZ S- K]q SZLV[KLV[S]DFZfQ VDFZF GHISGF ; UF VF IJEFULI SRZLDAFDPH T]C9/GL 58F IJEFULI SRZLVMDASFI 5F, S . HGZ4 GF1 A SFI 5F, S . HGZ4 DNNGLX . HGZ4 VIWS DNNGLX . HGZ4 . HGZ4 VIUZ; LI Z4 IJEFULI IC; FAGLX : 8MZSL5Z4 VgI 5NFIWSFZL TZLS[CF, 890Z EZJFGL TFZLB]SFD SZTF GYL4 S]C]M]M WZFJTF GYLP

General Rules and Directions for the Guidance of Contractors

SMg8FS8ZMGF DFUNXG DF8[; FDFgI IGI DM VGI; JRGFVM

1. All works proposed to be executed by the contractor shall be notified in a form of invitation to tender pasted on a board hung up in the office of the Managing Director and signed by the Managing Director.

! P SMg8FS8Z wJFZF SZJF IJRZF], TDFD SFDGL HFCZFT SFI 5F, S . HGZGL SRZLDA, 8SFI, AMO 5Z RIBFO, SFI 5F, S . HGZGL ; CLJF/F 890Z DUFJTF OMD wJFZF SZJFDFVFXP

This form will state work to be carried out as well as the date of submitting and opening tenders and the time allowed for carrying out the work, also the amount of earnest money to be deposited with the tender and the amount of the security deposit to be paid by the successful tenderer and percentage, if any, to be deducted from bill. It will also state whether a refund of quarry fees, royalties, octroi dues and ground rents will be granted. Copies of the specifications, designs and drawing and estimated rates, and any other documents, required in connection with work which shall be signed by the Engineer for the purpose of identification shall also be open for inspection by Contractor at the office of the Engineer during office hours.

CY WZJFGF SFDGL TPDH 890Z DMS, JFGL VG]BM, JFGL TFZLBM VG]SFDM 5Z]SZJF DF8[VF5JFDFVFXJTL DNTGL HF6 OFDDA SZFXP J/L 890Z ; FY[VGFDT D]JFDFAFGFL ZSD VG[H]G] 890Z :JLSZF1 T]6] HFDLG VGFDT 58] D]JFGL ZSD VG] IA, MDPYL 55FT SZJFGL SM. 8SFJZL CMI TM T]56 NXF]JFDFVFXJP J/L 5yYZGL BF6 VU]GL OL4 ZMI <8L4 VMS8MI GL , 6L ZSD VG] HDLGV EFOFGL ZSD ZL00 D/X] S] SD T] 56 T]DA H6FJFDFVFXJP IJUTM IOHF. GM OM. U VG] VNFHL NZ4 VG] JR NZ VG] SFD VU[H-Z CMI V]JF H]GF p5Z VM/B DF] SFI 5F, S . HGZ ; CL SZX[V]JF SM. N: TFJHML GS, M SRZLGF ; D1 NZIDI FG SFI 5F, S . HGZGL SRZLV]SMg8FS8ZMG]HM. HJF DF8]ZFB]JFDFVFXJP

Where the works are proposed to be executed according to the specifications recommended by a contractor and approved by a competent authority on behalf of the Governor of Gujarat, such specifications with designs and drawing shall form part of the accepted tender.

SMg8FS8Z[E, FD6 SIFDHA GF VG[U]HZFTGF VFJL ZFH1 5F, JTL ; tTF VIWSFZLV[DHZ SZ], IJUT D]HA SFD CFY WZJFG] IJRFI]CMI t]R10HF. GM VG]OM. U ; ICTGL VFJL IJUTM :JLST 890ZGM EFU AGL ZCXp

2. In the event of tender being submitted by a firm. It must be signed separated by each partner thereof or in event of the absence of any partner it shall be signed on his behalf by person holding a power of attorney authorising him to do so. Details of partner will be furnished in Annexure-I along with the copy of partnership.

ZP SM. V\$ 5[-L TZOYL 890Z ZH[YI]CMI t]FZ[T]GF EFULNFZ[V, U ZLT] ; CL SZJL VYJF EFULNFZ UZCFHZ CMI t]FZ[T]GF JTL TGF 5Z ; CL SZJF VIWST SZT]D]B]t]FZGF] WZFJTL SM. 56 j]ISTV[T]GF 5Z ; CL SZJFGL ZCXp EFULNFZML IJUT 5IZIX08v! DAFULNFZL BTGL GS, ; FY[VF5JFGL ZCXp

3. Receipts for payment made on account of any work, when executed by a firm , shall also be signed by all the partners except where the Contractors are described in their tender as a firm in which case the receipts shall be signed in the name of the firm by one of the partners or by some other person having authority to give effectual receipts for the firm.

#P SM. 5[-LV[SFD SZL V%]CMI t]FZ[T]SFD SZFI, R]S]6LGL 5CMRM 5Z 56 AWFH EFULNFZ[V] ; CL SZJFGL ZCXp 5ZT]H] 890ZDA SMg8FS8ZMG]V\$ 5[-L TZLS[NXF]I]F CMI t]FZ[V]5[-L JTL VGF SM. EFULNFZ[S]5[-L JTL 5FSL 5CMR VF5JFGL VIWST V]L ALH]0 SM. 56 j]ISTV[5CMRM 5Z ; CL SZJFGL ZCXp

4. The bidder should quote his bid premium or rebate at the end of Schedule B. If he do not wish to quote premium or rebate, he should Indicate "at par" in the blank space preceding "% above/below" in Schedule B. Thereafter he should work out and indicate the offered bid amount both in words and figures in Schedule B.

5P 890Z BM, TL JBT]OST 890Z EZGFZ . HFZNFZM VYJF TDPGF VIWST 5]TIGIWMG]H CFHZ ZC]F NJFDFVFXJP T]I; JFI GF VgI SM. . HFZNFZMG]CFHZ ZC]F NJFDFVFXJ]GICP

HM 890Z EZGFZ V\$ 56 . HFZNFZ S]TDPGF VIWST 5]TIGIWMG]CFHZ G CMI TM 890Z BM, GFZ VIWSFZL p5ZAT VMKFDVIMKF V\$ JW]VIWSFZL S] ; A]WT ; ZSFZL SRZLGA ; LGL Z VIWSFZLGL CFHZLDA 890Z BM, JFDFVFXJP VFJF 5] ; U]890Z G E I]CMI T]JF VgI . HFZNFZ S]T]M]GF 5]TIGIWMG]CFHZ ZC]F NJFDFVFXJ]GICP s5ZL5+ SDF8 8LVG; Lv! _) #v\$V; 4 TP &q *q) #FP

8j0Z BM, GFZ VVWSFZL HJNFHJNF 8j0ZMGL ZSD I MUI OMDGF TJ, GFtDS 5+SDRGMVXP 8j0Z : JLSFZTF Sltj8FS8Z[T]GL VM/B ; FY[V]F 8j0ZDA H6FJ, L IJUTM V[G]ALHF N:TFJHGL GS, M p5Z : CL SZJFGL ZCXP 8j0Z : JLSFZJFDRG VFJ[t]fz]8j0Z EZGFZ Sltj8FS8Z GF6A5ZT D?I FGL 5CIR VF5[V]B, [VD]6[EZ], L AFGGL ZSD TDG[I]Z00 SZJF JEFULI VVWSFZL ; AIWT ITHMZL VVWSFZL[V]WST SZXP

6. The officer competent to dispose off the tenders shall have the right of rejecting all or any of the tenders.
&P 8j0ZMGLGSF, SZJFGL ; tTF WZFJTF VVWSFZLGAWA[V]YJF SIM. 56 8j0ZGMV : JLSFZ SZJFGM VVWSFZ ZCXP

7. ~~No receipt for any payment alleged to have been made by a Contractor in regard to any matter relating to this tender or the contract shall be valid and binding on Government unless it is signed by the Executive Engineer.~~

*P ~~Vf 8j0Z S] Sltj8FS8ZG[, UTL SIM. 56 AFAT Sltj8FS8Z SZL L SCUFYL SIM. R5 J6LGM5CMR 5Z SF15F, S. HGZGL : CLG CIMI TIT]5CMR SF1NF Z VGL : ZSFZ AWG ZCXP[GICP~~

8. ~~The memorandum of the work to be tendered for and the schedule of materials to be supplied by Public Works Department and there rates shall be filled in and completed by the office of the Executive Engineer before the tender form is issued. If a form issued to an intending tenderer has not been so filled in and completed, he shall request the said officer to have it done before he completes and delivers his tender.~~

(P ~~8j0ZG]OMD* VF5TA5C] F SF15F, S. HGZGL SRZL[G]H] SFDG 8j0Z DFUJFDR VFJ]T]SFDML I MLI AWFSD IJEFU]5Z] 5F0JGF DF, ; FDFGL~~

~~V[G]JR V[G]TGF NZ 8FSLGT]OMD* 56*56[EZL VF5JFG]ZCXP 8j0Z EZJF DRUT SIM. Sltj8FS8ZG[V5F]H]VFJ]OMD*5DF6] ; 56*56[E]IC CIMI TIT]5M]FG]8j0Z 5Z]5] EZL[G] M5] T]5C] F p5Z D]A SZL VF5JFGL TD6]pST SRZL[G]JGTL SZJFGL ZCXP~~

9. Under no circumstances shall any Contractor be entitled to claim enhanced rate for any items in this contract.

)P SIM. 56 ; HUIJMDA[V]F Sltj8FS8DFGL SIM. 56 AFAT]DF8]SIM. Sltj8FS8ZG[JW]EFJ DFUJFGM CSS ZCXP[GICP

10. All corrections and additions or pasted slips should be initialed.

!_P TDFD ; JWFZ] JWFZ[S]RMBFQ, L SF5, LVIM 5Z 85L ; CL SZJFGL ZCXP

11. The measurements of work will be taken according to the usual method in use in the Public Works Department or as specified in technical specification and no proposals to adopt alternative methods will be accepted. The Zonal Engineer's decision as to what is the usual method in use in the Public Works Department will be final.

!!P SFDGF DF5 AWFSD IJEFUJGL ZFAJTF DJHAGL 5WWTL] VYJF 85GLS, ; 5] LOLSXGDR NXF]F V[G] FZ, ; JFDR VFJX] V[G] J5]5S 5WWTLV]M V5GFJJF VUJ]SIM. 56 NZBF:T : JLSFZX]GCL S. 5WWTL AWFSD IJEFUGL ZFAJTF DJHATL K]T]VUJGF SF15F, S. HGZGM IG61 VFBZL U6FXP

12. The Insurance Company's bond will not be accepted against the security deposit.

!ZP JLDAS5GLG]BT HFDLG VGFDT ; FD:]JLSFZJFDRVFJX]GCLP

13. In the event of any other of discrepancy in write upto tender documents the contractor will not take any undue advantage of such error or discrepancy and Engineer In Charge shall have power to interpret and decide correct meaning of contradictory erroneous writing..

14. The Contractor will have to construct a shed for storing controlled and valuable materials issued to him under schedule 'A' of the agreement at work-site having double locking arrangement. The materials will then be taken for use in the presence of the Department person. No materials will be allowed to be removed from the site of work.

!\$P SZFZGL V[G]JR S CP/ Sltj8FS8ZG[VF5JFDR VFJ], IGI+6 V[G] ISDTL DF, ; FDFG SFDGF : Y/[ZFBJF DF8] TD6] AJUOF TF/FTL j]J:YFJF/L V5 KF5ZL ANWJFGL ZCXP T]5KL IJEFUGL SIM. j]ISTGL CFHZLDR p5] MUDA, JF DF, ; FDFG TDFYL ACZ SF-JFGM ZCXP SFDGF : Y/YL SIM. 56 DF, ; FDFG B; JFJ N]FX]GCLP

15. No foreign exchange will be released by the Department for the purpose of plant and machinery required for the execution of the work contracted for.

!5P HG]DF8]Sltj8FS8 V5F]M CIMI T]SFD SZJF DF8]H-ZL %, F8 V[G]I+ ; FDUJ DF8]HFCZ AWFSD IJEFU SIM. H IJNXL C]O]FD6 K5]SZX] GCLP

16. Controlled materials (Essentiality Certificate)

!*P IGI+6 DF, ; FDFG sVFJx] S 5DF65+f

(i) As regard controlled materials, the Public Works Department will help to arrange for the permit as far as possible and help the Contractor in securing the same. All incidental charges met with in procuring these materials shall be borne by the Contractor himself. Though the Public Works Department will help to arrange for the permit as far as possible and help the Contractor in obtaining the materials, it shall not accept any responsibility for any loss on account of delay caused to the Contractor while obtaining the same.

! f IGI+T DF, ; FDFG 5ZT]AWFSD IJEFU XS] T5, L ZLT]5ZD]8 DF8GL j]J:YFDRDNN SZX]V[G]T] ; JGI' JT SZJFDRASltj8FS8ZG[DNN SZXP VF DF, ; FDFG D/]JFDRYI], TDFD V[G]JF]FUS BR"Sltj8FS8Z 5M]T]E]MUJXP AWFSD IJEFU 5ZD]8 D/]JF AG]T5, L DNN SZX] V[G]DF, ; FDFG D/]JF Sltj8FS8ZG[DNN SZXP T]KTA Sltj8FS8ZG[T]D/]JFDR SIM. IJ, A YJFG, L]M SIM. IJ, A S]G5XFG DF8]HFCZ AWFSD IJEFU HJFANFZ, BFX]GCLP

(ii)The contractor shall submit to the concerned or Zonal Engineer on close of every calendar month the monthly returns in the prescribed forms as to the receipts and actual use of the controlled materials during the month.

Zf NZ5 VUJ]H] DCLGFG]V]Sltj8FS8Z] DCLGF NZD]FG IGI+T DF, ; FDFGVL VFJS V[G]BZBZ J5Z]X VUJ]IGI T OMD]DHAGF DF; IS IGI T5+SM SF15F, S. HGZG]DMS, JFGF ZCXP

(iii) The contractor shall permit concerned or Executive Engineer or his representative to inspect the stock of the controlled materials stored by him at any time whenever the Executive Engineer or his representative so desire (s).

#f SF15F, S. HGZ VYJF TG]5]TIGIWM]H]FZ]. rK[t]fz]Sltj8FS8Z]TD6] ; UJCL ZFB], M IGI+T DF, ; FDFGGM : 8MS SIM. 56 JBT] T5F; JFDRV]JFGM ZCXP

17. The tender for the work shall remain open for period (120*) days from the actual date of down loading of the price bids for this work and that the tenderer shall not be allowed to withdraw or modify the offer on his own after downloading of price bid. If any tenderer withdraws or make any modifications or additions in the terms and conditions of his tender not acceptable to the Government (Public Works Department/BMC) then the Government shall without prejudice to any

beyond the proposed extension of time limit and the contractor shall have to furnish the undertaking for this alongwith the application for extension in time limit.

Sr	Monetary Progress	Portion of Security Deposit to be released	Against production of Bank guarantee of
1.	25% of tender cost	Equal to the amount retained from running Bills or 0.625% of the estimated cost of work, whichever is less	Equal to the amount to be released
2.	50% of tender cost	Equal to the amount retained from running Bills or 1.25% of the estimated cost of work, whichever is less	Equal to the amount to be released
3.	75% of tender cost	Equal to the amount retained from running Bills or 1.88% of the estimated cost of work, whichever is less	Equal to the amount to be released

25.2 It will have to be ensured that ten percent amount of security deposit in any form as permissible above is kept available with the employer till the actual date of completion of work. (Vide as per R & B circular No. TNC-10-2013-3-(Part-2)-C dated 20-11-2013)

TENDER FOR WORK - SFD DF8GL8qOZ

I/ We hereby tender for the execution for the Governor of Gujarat (hereinbefore and hereinafter referred to as Government) of the work specified in the underwritten memorandum within the time specified in such memorandum at the tendered rates specified in Schedule 'B' (memorandum showing item of works to be carried out) and in accordance in all respects with the specifications, designs, drawings and instructions in writing referred to in this tender and in Clause 13 of the annexed conditions of contract and agree that when materials for the work are provided by Government , such materials and the rates to be paid for them shall be as provided in schedule 'A' hereto.

VfYL Qq VDj; G; JR cBc CFY WZJFG SFDGL AFATIMNXEJTL I FNLDVIGIN08 8qOZGF NZYL VFJL I FNLDV9ZFEJ. DNTGL VNZ VQVF 8qOZGL ; FY[HMDj L Slt8FS8ZGL XZTMGF BD ! # DAH6fJj L , JBT IJUTIM IOhf. GM OM. U VQ; JRGVIMVQ; FZ AWL ZFTq GLRj H6fJj L I FNLDVNXEJj. JSFD SZJF DF8j UH-ZFTGF ZFH I 5f. sHDGj VCLVUfp VQ[CJ]5KL c; ZSFz: TZLSjH6fJj. Kpf DF8j8qOZ ZHjSZjKj SZLV[KLV]VQjTjSFD DF8j; ZSFZ TZOYL DF. ; FDFG 5ZM 5fOJFDAVfJj(tI FZjTjDF. ; FDFG VQjTjDF8jRjSjJfGF NZ ; FY[GL VQ; JR cS: DRAHIMJF/VMSI F'D]HAGL ZC[X]TjDGj VDGjSAj. Kp

* Strike out which ever is not applicable

*, FUjG 50TjCM TjKjSL GFBj

+ In figures as well as words

* VFSOF TjDH XaNMDA

Time allowed for the completion of work form date of written order to commence 32 (Thirty Two) months (Including Monsoon Period).

Should this tender be accepted I/We hereby agree to abide by and fulfill the terms and provision of the condition of the contract annexed here to so far as applicable and in default thereof to forfeit and pay to The Executive engineer, BUILDING DEPARTMENT, Bhavnagar Municipal Corporation, Bhavnagar the sums of money mentioned in the said conditions. The Executive engineer, BUILDING DEPARTMENT, Bhavnagar Municipal Corporation, Bhavnagar (Receipt No. _____ dated _____ for The Executive engineer, BUILDING DEPARTMENT, Bhavnagar Municipal Corporation, Bhavnagar at _____ in respect of sum of **Rs11,99,40,841.00** is forwarded herewith representing the earnest money deposit in full the value of which is to be absolutely forfeited by The Executive engineer, BUILDING DEPARTMENT, Bhavnagar Municipal Corporation, Bhavnagar should I/We not deposit the full amount of Security Deposit as specified in the memorandum of works in brief in accordance with Clause I of the said conditions, the sum of which is otherwise Rs._____.

Name of the Contractor _____

Address _____

Dated the ____ day of _____ 2024

Name of Witness _____

Address _____

Occupation _____

The Tender is hereby accepted by me on behalf of The Governor of Gujarat on the ____ day of _____ 2024.

Signature of the Contractor

**Executive Engineer,
BUILDING DEPARTMENT,
BHAVNAGAR MUNICIPAL CORPORATION
BHAVNAGAR**

1. DATA SHEET FOR B-1 E-TENDERING
2. NOTICE INVITING TENDERS
3. ADDITIONAL INSTRUCTIONS TO PERSONS TENDERING
4. DECLARATION FORM
5. DECLARATION CERTIFICATE
6. GENERAL RULES AND DIRECTIONS FOR THE GUIDANCE OF CONTRACTORS
7. TENDER FOR WORK
8. MEMORANDUM
9. TERMS & CONDITIONS OF CONTRACT

LIST OF TERMS AND CONDITIONS CLAUSE

DETAILS		
Clause 1	Security deposit	
Clause 2	Liquidated damages for delay	
Clause 3	Default by contractor	
Clause 4	Action when the progress of any particulars portion of the work is unsatisfactory	
Clause 5	Non exercise of powers under clause 3 not a waiver	
Clause 6	Power to seize tools, plants, machinery's, materials and stores of the contractor on Invocation of clause 3.	
Clause 7	Extension of time limit	
Clause 8	Final Measurements and final bill on completion of work	
Clause 9	Intermediate and final Payment	
Clause 10	Payment at reduced rates	
Clause 11	Bills to be submitted monthly	
Clause 12	Bills and rates payable	
Clause 13	Material to be supplied by the Owner	
Clause 14	Consumption and return of materials supplied by the Owner	
Clause 15	Safe custody of materials supplied by the Owner	
Clause 16	Drawings / Designs, Instructions of the Architect/Owner and Specification, order of precedence in case of discrepancies	
Clause 17	Excess over Tender Quantities, Extra Items and Variations	
Clause 18	No claim to any payment or compensation for alterations or for Restrictions of work.	
Clause 19	No claim for delay in supply of materials by the Owner	
Clause 20	Claims under the contract	
Clause 21	Remedies for inferior or bad work, materials or workmanship and maintenance clause.	
Clause 22	Defect liability clause.	
Clause 23	Work to be open for inspection contractor's responsible agent to be Present	
Clause 24	Employment of qualified Site Engineer by Contractor	
Clause 25	Notice to be given before work is covered up	
Clause 26	Damage to contract work-in-progress and damages to surrounding Properties	
Clause 27	Damages due to acts of God and unprecedented floods	
Clause 28	Contractor to supply plant ladders, scaffolding etc and is libel for damage arising from non-provision of lights, fencing etc.	
Clause 29	Regulations for scaffolds, working platforms, gangways and stairways	
Clause 30	Regulations for hoisting appliances	
Clause 31	Measure for prevention of fire	
Clause 32	Liabilities to contractors for any damages done in or outside work	
Clause 33	Deleted	
Clause 34	Work not to be sublet; consequences for unauthorized subletting, bringing and becoming insolvent	
Clause 35	Sums payable by way of compensation to be considered as reasonable compensation without reference to actual loss	
Clause 36	Changes in the constitution of firm to be notified	
Clause 37	Works to be under directions of Architect/Owner/Consultant	
Clause 38	Settlement of Disputed and Arbitration	

Clause 39	Lump sums in estimates	
Clause 40	Action where no specifications	
Clause 41	Definition of work	
Clause 42	Contractors percentage-whether applied net or gross amount of the bill.	
Clause 43	Royalties	
Clause 44	Compensation under the Workman, Compensation Act	
Clause 45	Liability of the contractor in case of accidents	
Clause 46	Arrangements for personal safely requirements and First aid	
Clause 47	Variation in quantity of work	
Clause 48	Employment of famine or other labour	
Clause 49	Claim for compensation for delay in starting the work	
Clause 50	Claim for compensation for delay in the execution of work	
Clause 51	Entering upon or commencing any portion of work	
Clause 52	Minimum age of persons employed	
Clause 53	The payment of fair wages etc.	
Clause 54	Method of payment	
Clause 55	Employment of scarcity labour	
Clause 56	Rates inclusive of sales tax etc.	
Clause 57	Employment thought Employment Exchange and local labour	
Clause 58	Fair wages	
Clause 59	List of Machinery	
Clause 60	Liabilities of contractor for idleness of Road Rollers deployed by the Owner on contract work	
Clause 61	Local labour on normal rates	
Clause 62	Land on Hire and rental charges	
Clause 63	Vaccination to labourers	
Clause 64	Camp facilities to workers	
Clause 65	Gum boots, hand gloves, masks etc. to labourers	
Clause 66	No distinction between Harijans and other workers	
Clause 67	Price Escalation clause.	DELETED
Clause 68	Fencing and Lighting	
Clause 69	Liabilities for accident to persons	
Clause 70	Access to site and work on site	
Clause 71	Reports regarding labour	

Clause 72	Treasure trove	
Clause 73	Indemnity	
Clause 74	Insurance of labourers	
Clause 75	Setting out	
Clause 76	Cement Register	
Clause 77	Materials and Works Test Register	
Clause 78	Progress Schedule	
Clause 79	Secured Advance	DELETED
Clause 80	Advance Payment	DELETED
Clause 81	Advance against machinery's	DELETED
Clause 82	Mobilization Advance	DELETED
Clause 83	License for contract labour	
Clause 84	Recovery of testing charges	
Annexure-1	Declaration regarding Income Tax, Addresses etc.	
Annexure-2	Basic rates considered by the contractor	
Annexure-3	Performance Bond	
Annexure-4	List of works already completed by the tenderer	
Annexure-5	List of plant and Machinery	
Annexure-6	Declaration regarding works on hand	
Schedule- 'A'	Materials to be supplied from Store	
Schedule- 'B'	Memorandum showing items of works to be carried out	
Schedule- 'C'	Time Schedule of completion	

TERMS & CONDITIONS OF CONTRACT

Clause 1 Security Deposit: The person/persons whose tender is accepted (hereinafter called the "Contractor" which expression shall unless excluded by, or repugnant to the context include his Legal heirs, executors, administration and assignees) shall (a) Deposit with the Owner a sum sufficient to make up the full security deposit specified in the tender in cash or in form of demand draft to Owner within a period of 10 days from the date of receipt of the notification of acceptance of his tender, or (b) (i) Initial Security Deposit of the total security deposits as specified in the tender form with the Owner in cash or in form of D.D. on receipt of notification of acceptance of his tender. If the Initial security deposit is not paid within the above specified time, no work order will be issued till the issue about delay is finally decided by the competent authority (b) (ii) The Owner shall be deemed to have been authorized to deduct to the balance of the security deposit as specified in the tender form from the amounts that become payable to the contractor for the work done under the contract from time to time, such deduction shall not exceed ten percentage of the amount so payable and the works whose amount paid in cash or by way of deduction shall be estimated amount is more than rupees held by Owner by way of Security deposit. Than rupees fifteen lacks, the contractor shall have to give the performance bond of any schedule bank equivalent to five percentage of the estimated amount put to tender along with the initial security deposits. All compensation, Liquidated damages or other sums or money payable by the contractor to Owner under the terms of this contract shall be deducted from or recouped by the realization of a sufficient part of his security deposit, or from the interest arising there from or performance bond or from any sums which may due or may become due by Owner to the Contractor on any account what so ever and whether in respect of this contract, any other contract, or otherwise. In the event of his security deposit being reduced by reason of any such deduction or recoupment as aforesaid, the contractor shall within ten days thereafter, make good in cash or as aforesaid any sum or sums required to make good the shortfall in the amount of the security deposit. If the amount of the security deposit to above be paid as specified above in cash or by D.D within the period specified above is not paid the tender/contract already accepted should be considered as canceled and legal steps shall be taken against the contractor for recovery of the amounts.

Clause 2 Liquidated damages for delay: -

- (i) If the contractor fails to complete the work under contract by the stipulation date he shall pay liquidated damages of Rs. 0.1 percentage of the contract value per day from the date of delaying the said work up to the date of completion and handing over to the Owner.
- (ii) However also if the contractor fails to complete any part of the works as designed in Schedule (C) by the time indicated against such part, he shall pay Liquidated damages per day from the date of delaying the said part of the works up to the date of completion of the said designated part at the rates shown in the said Schedule of the contract value of part for such failure till the said designated part is completed.
- (iii) The aggregate maximum of liquidated damages payable under clause No. 2 shall not exceed Rs. 0.1 percentage of contract value per day and shall be subject to the maximum amount of ten percentage of the estimated amount put to tender.
- (iv) Delays requiring payment of ten percentage liquidated damages of the amount put to tender for performance shall be sufficient causes for termination of contract and for forfeiture of security deposit including amount of performance bond in respect of works estimated to cost more than Rs. 15 lacks, for performance and registration of the contractor shall also be kept in abeyance for three years from the date as fixed in all cases. (See Schedule (C) on page No. 48)

Clause 3 Default by contractor:- If the contractor shall neglect or fail to proceed with the work with due diligence or if he violates any of the provision of the Contract, the Architect/Owner shall give the Contractor a notices, identifying deficiencies in performance and demanding corrective action. Such notice shall clearly state that is shall not remove any plant; equipment and material from the site. The Owner shall have a lien on all such plant, equipment and material from the date of such notice till the said deficiencies have been corrected as mentioned in the said notice. If the contractor fails to take satisfactory corrective action within ten days after receipts of notice, the Owner shall terminate the contract in whole. In case the entire contract is terminated the amount of security deposit and performance band if any together with the value of the work done but not paid for, shall stand forfeited to the Owner. The plants, equipment and materials, held under this clause shall then be at the disposal of the Owner to recover the amount equivalent to liquidated damages and registration of the contractor shall be kept in abeyance for three years from the date as fixed in all such cases. The Architect/Owner if necessary shall direct that a part or the whole of such plant, equipment and materials be removed from the site within a stipulated period. If the contractor fails to do so, the Architect/Owner shall cause them or any part of them to be sold holding the net proceeds of such sale to the credit of the Contractor. After settlement of accounts the lien by the Owner of the contractor's remaining plant equipment and balances of materials shall be released.

Termination of the contract in whole shall be an adequate authority for the Architect/Owner to demand discharge of the obligations from the guarantors of the security for the performance.

- Clause 4** If the progress of any particular portion of the work under Contract is unsatisfactory the Architect/Owner shall, notwithstanding that the general progress of the works is satisfactory, in accordance with clause 2 be entitled to take necessary action under clause 3, after giving the Contractor ten days' notice in writing and the contractor shall have no claim whatsoever for any compensation for any loss caused to him due to such action.
- Clause 5** In any case in which any of powers conferred upon the Architect/Owner by clause 3 hereof shall have become exercisable and the same shall not have been exercised, the non-exercise thereof shall not constitute a waiver of any of the conditions hereof and such powers shall notwithstanding be exercisable at any future date.
- Clause 6** In the event of the Architect/Owner taking action under clause 3, he may, if so desire, take possession of all or any tools, plants, machinery, materials and stores in or upon the work or the site thereof or belonging to the contractor or procured him and intended to be used for the execution of the work or any part thereof by paying or allowing for the same in account at the contract rate or in case of contract rates not being applicable at such reasonable rates, as may be comparable to current market rates where ascertainable of similar articles and comparable condition, to be certified by the Architect/Owner. In the alternative the Architect/Owner may by notice in writing to the contractor or his clerk of the works foreman or other authorized agent require him to remove such tools, plants, machines, materials or stores from the premises within a time to be specified in such notice and in the event of the contractor failing to comply with any such requisition, the Architect/Owner may remove them at the contractor's expenses or he shall remove them by auction or private sale at the risk and cost of the contractor in all respects, and the certificate of the Architect/Owner as to the expenses of any such removal and the amount of the proceeds, and expenses of any such removal shall be final and conclusive against the contractor.
- Clause 7** **Extension of time:-** If the contractor shall desire an extension of the time for completion of the work on the ground of his having been unavoidably hindered in its execution or any other ground he shall apply in writing to the Architect/Owner before the expiration of the period stipulated in the tender or before the expiration of 30 days from the dates on which he was hindered whichever is earlier and the Architect/Owner may, if in his opinion he believes that there are reasonable grounds for granting an extension, grant such extension as he thinks necessary or proper. The decision of the Architect/Owner in this matter shall be final.
- Clause 8** As soon as the work is completed, the contractor shall give a notice of such completion to the Architect/Owner and on receipt of such notice the Architect/Owner shall inspect the work and if he is satisfied that the work is complete in all respects then: -

- (i) For all works costing up to Rs. 50 Lacks (amount put to tender) the final measurements shall be recorded within 45 days from the date of physical completion of the work and the final bill shall be prepared within 45 days from the date of recording final measurement. The completion certificate shall be issued within one month from the date of final measurements subject to the contractor fulfilling his obligation as provided in the contract and subject to the work being complete in all respects.
- (ii) In respect of works costing more than Rs. 50 Lacks (amount put to tender) the final measurements shall be recorded within 75 days from the date of physical completion of the work and the final bill shall be prepared within 75 days from the date of recording final measurements subject to the contractor fulfilling his obligation as provided in the contract and subject to the work being complete in all respects.

When separate period of completion have been specified for item or groups of item, the Architect/Owner shall issue separate completion certificate for such item or group of item.

No certificate of completion shall be issued nor shall the work be considered to be complete till the contractor shall have removed from the premises, on which the work has been executed, all scaffolding, sheds and surplus materials, except such, as are required for rectification of defects; rubbish and all huts and sanitary arrangements required for his workmen on the site in connection with the execution of the work, as shall have been erected by the contractor for the workman and cleared all dirt from all parts of structure (s) in, upon or around which the work has been executed or of which he may have possession for the purpose of the execution thereof and cleared floors, gutters and drains, cased doors and sashes, oiled locks and fastenings labelled keys clearly and handed then over to the Architect/Owner or his representative and made the whole premises fit for

immediate occupation or use to the satisfaction of the Architect/Owner. If the contractor shall fail to comply with any of the requirements of these conditions as aforesaid, on or before the date of completion of the works, the Architect/Owner may, at the expense of the contractor, fulfill such requirements and dispose of the scaffolding, or surplus materials and except for any sum actually released by the sale thereof less the Cost of fulfilling the requirements is more than the amount realized such disposal as aforesaid the contractor shall forthwith, on demand, pay such excess. The Architect/Owner shall also have the rights to adjust the amount of excess against any amounts that may be the contractor.

- Clause 9** No payment shall be made for any work, estimated to cost less than rupees one thousand till after the whole of the side work shall have been completed and a certificate of completion given. But in the case of work estimated to cost more than rupees one thousand, the contractor shall on submitting a monthly bill therefore, be entitled to receive payment proportionate to the part of the work then approved and passed by the Architect/Owner, whose certificate of such approval and passing of the sum so payable shall be final and conclusive against the contractor. All such intermediate payments shall be regarded as payments by way of advance against the final payments only and as payments of work actually done and completed and shall not preclude the Architect/Owner from requiring bad, unsound imperfect or unskilled work to be removed and taken away and reconstructed. or re-erected, nor shall any such payment be considered as an admission of the contractor or any part therefore in any respect or the accruing of any claims, nor shall it conclude, or affect any way the power of the Architect/Owner as to the final settlement and adjustment of the accounts or otherwise or in any other way vary or effect the contract. The contractor shall submit the final bill within one month of the completion of the work, otherwise the Architect/Owner's certificate of the measurements and of the total amount payable for the work shall be final and binding on all parties.
- Clause 10** The rates for item of work shall be valid only when the items concerned are accepted as having been completed fully in accordance with the sectional specifications. In cases where the item of work are accepted as not completed, the Architect/Owner may make payment on account of such item at such reduced rate as the may consider reasonable in preparation of final or on account bill.
- Clause 11** **Bills to be submitted monthly:** A bill shall be submitted by the contractor each month on or before the date fixed by the Architect/Owner for all works executed in the previous month and Architect/Owner shall take or cause to be taken the requisite measurement for purpose of having the same verified and the claim, so for it is admissible shall be adjusted if possible within tenders from the presentation of the bill. If the contractor does not submit the bill within the time fixed as aforesaid, the Architect/Owner may depute a subordinate to measure up the said work in the presence of the contractor or his duly authorized agent whose countersignature to the measurement list shall be sufficient warrant and the Architect/Owner may prepare a bill from such list which shall be binding on the contractor in all respects.
- Clause 12** The contractor shall submit all the bills on the printed forms to be had on application at the office of the Architect/Owner. The charges to be made in the bills shall always be entered at the rates specified in the agreement or at the partly reduced rates subject to the approval by the Architect/Owner in the case of Items not completed/executed as per agreements or in the case of any extra work ordered in pursuance of these conditions and not mentioned or provided for in the tender, at the rate here in after provided for such work.
- Clause 13** If the specification of the work provides for the use of any special description of materials to be supplied from the Owneral store or if it is required that the contractor shall use certain stores to be provided by the Architect/Owner (such materials and stores and the prices to be charged therefore as here in after mentioned being so far as practicable for the convenience of the contractor but not so as in any way to control the meaning or effect of this contract specified in the schedule of memorandum here to annexed) the contractor shall be supplied with materials and stores as may be required from time to time to be used by him for the purpose of the contract only, and the value of the full quantity of materials and stores so supplied shall be set off deducted any sum then deposit, or the proceeds of sale thereof, if the deposit is held in govt. securities, the same or a sufficient portion thereof shall, in that case be sold for the purpose. All materials supplied to the contractor shall remain the absolute property of Owner and shall on no account be removed from the site of the work, and shall at all time, be open to inspection by the Architect/Owner. Any such materials, unused and in perfectly good condition at the time of completion or termination of the contract, shall be returned to the Owner store if the Architect/Owner so requires by a notice in writing given under his hand. But the contractor shall not be entitled to return any such materials except with the consent in writing of the Architect/Owner and in shall have no claim for compensation on account of any such materials supplied to him as aforesaid but remaining unused by him or for any wastage in or damage thereto.

Clause 14 The contractor shall be entitled use the materials supplied by the Owner only to the extent of quantities of such materials required for execution of the work as per theoretical calculations. The Architect/Owner may however, on being satisfied that a large quantity o such materials is required for the execution of the work, permit the contractor to use such large quantity of the materials. Such permission shall be given in writing.

Clause 15 All stores and materials such as cement, if the consumption of which exceeds 25 tone and steel etc. supplied to the contractor by Owner shall be kept by the contractor in separate god own provided with a double lock. The key of the lock shall remain with the Architect/Owner or his agent. The godown shall be accessible to the Architect/Owner or his agent at all times. No materials shall be allowed to be removed from the site of the work and any materials required for the execution of the work shall be taken out from the godown only in the presence of a duly authorized agent of the Architect/Owner.

Clause 16 (1) The contractor shall execute the whole and every part of the work in the most substantial and workman- like manner and as regards materials and in other respect in strict accordance with specifications.

The contractor shall also conform exactly, fully and faithfully to the design, drawing and instruction in writing for the work signed by the Architect/Owner. The design and the drawings shall we lodged in the office of the site Architect/Owner to witch the contractor shall be entitled to have access for the purpose of inspection at such office during office hours. Where the instructions referred to above are not contained in separate letters addressed to the contractor the same shall be recorded in the work-order book, which shall be maintained and kept on the site of the work. The contractor shall be required to sing such entries in the work-order book for any reason whatsoever, the entry of the instruction in the work-order book shall be deemed to be the due notice to him of the said instructions. The work-order book shall be open for inspection to the contractor on the site of the work during office hours.

(1) The contractor will be entitled to receive one copy of the accepted tender along with the work order free of cost and will also be entitled to receive three sets of contract and working drawing according to the progress of work as and when need free of cost.

(2) The several documents forming the contract are essential part of the contract and requirements occurring in one are binding as through occurring in all. They are intended to be mutually explanatory and complimentary and to describe and provide for a complex work.

In the event of any discrepancy in the several documents forming the contractor or in any one document, the following order of precedence should apply:

(a) **Dimension and quantities:** (i) Drawings (ii) Schedule-B of the Tender form (iii) specifications. On drawing, figures dimensions, unless obviously incorrect, will be following in preference to scaled dimensions.

(b) **Description:** (i) Schedule – B of the tender form: - (ii) Drawings (iii) Specifications. In the case of defective description or ambiguity, the Architect/Owner is entitled to issue further instruction direction in what manner the work is to be carried out. The contractor cannot take any advantage of any apparent error or omission in drawing or specification and the Architect/Owner shall be entitled to make correction and interpretations as necessary to fulfill plans and specifications.

Clause 17.1 The Architect/Owner shall have power to make any alterations in or addition to the original specifications, drawings, designs, and instructions that may appear to him to be necessary or advisable during the progress of the work and the contractor shall be bound to carry out the work in accordance with any instructions in this connection which may be given to him in writing signed by the Architect/Owner and such alteration shall not invalidate the contract and additional work which the contractor may direct to do in the manner above specified as part of the work shall be carried out by the contractor on the same conditions in all respects on which he agreed to the work and at the same rate as are as specified in the tender for the main work.

Clause 17.2 *Except that when the quantity of any item exceeds the quantity as in the tender by more than 10% the contractor will be paid for the quantity in excess of 10% at the rate entered in the S.O.R. of the year during which the excess in quantity is first executed and for the materials consumed in excess quantity the rate materials to be charged would be the basic rate taken into account for fixing the rate for the S.O.R. above instead of the rate stipulated in schedule – A.*

Clause 17.3 If the additional or altered work includes any class of work for which no rate is specified in this contract, then such class of work shall be carried out.

(i) At the rate derived from the item within the contract which is comparable to the involving additional or altered class of work; where there are more than one comparable items, the items of the contract which is nearest in comparison with regard to or class or classes of the work involved shall be selected and the decision of the owner as to he nearest comparable item shall be final and binding on the contractor.

- (ii) If the rate cannot be derived in accordance with (i) above, such class of works shall be carried out at the rate entered in the Schedule of Rates in the year in which the tender was received. Increased or decreased by the percentage by which the tender amount is more or less as compared to the amount arrived at the rates in the Schedule of Rates for the year in which the tender was received. If the Schedule of rates does not contain all the items, the percentage increase of the tender shall be calculated considering such items which were included in the Schedule of Rates for the year and for materials consumed on such item the rate to be charged would be the basic rate taken into account for fixing the rate in S.O.R. referred to above, instead of the rate stipulated in Schedule (A).
- (iii) If it is not possible to arrive at rate from (i) and (ii) above, such class of work shall be carried out at the rate decided by the competent authorities on the basis of detailed rate analysis after hearing the contractor before a Committee of two Engineers stationed at the same place or the nearest place.

Clause 17.4 If the additional or altered work, for which no rate is entered in the "Schedule of Rates" is ordered to be carried out before the rate is agreed upon then the contractor shall within seven days of the date of receipt by him of the order to carry out the work, inform the Architect/Owner of the rates, which it is his intention to charge for such class of work and if the Architect/Owner does not agree to this rates, he shall by notice in writing be at liberty to cancel his order to carry out such class of work and arrange to carry it out in such manner as he may consider it advisable, provided always that if, the contractor shall commence work or incur any expenditure there of before the rate shall have been determined as lastly herein before mention, then in such cases he shall only be entitled to be paid in respect of the work carried out or expenditure incurred by him prior to the date of the determination of the rate as aforesaid according to such rate or rates as shall be fixed by the Architect/Owner. In the event of the dispute, the decision of owner shall be final.

Where, however the work is to be executed according to the designs, drawings and specifications recommend by the contractor and accepted by the competent authority; the alternation above referred to shall be within the scope of such designs, drawings and specifications appended to the tenders. The time limit of the work shall be extended in the proportion that the increase in the cost occasioned by alternations bears to the cost of the original contract work and the certificate of the Architect/Owner as to such be final and conclusive.

Clause 17.5 For excess in items of well sinking, the rates for sinking in depth beyond the designed depth shall be as per the rate quoted by the contract in the statement of variation, If no rates of variation in sinking are quoted the rate payable shall be the tender rate for sinking designed level increased by the difference of schedule of rate for sinking at designed depth and sinking at final depth.

Clause 18 No claim for any payment of compensation for change or restriction of work: - If at any time after the execution on the contract documents the Architect/Owner shall for any reason whatsoever, require the whole or part of the work, as specified in the tender, be stopped for any period or shall not required the whole of part of the work to be carried out at all or to be carried out by the contractor he shall given notice in writing, stating the fact to the Contractor who shall thereupon suspended or stop the work totally or partially, as the case may be. In any such case, except provided hereunder, the Contractor shall have no claim to any payment or compensation whatsoever except as provided hereunder on account of any profit or advantage which he might have derived from the execution of the work in full but which he did not so derive in consequence of the full amount of the work not having been carried out, or on account of any loss that he may be put to on account of materials purchased or agreed to be purchased or for unemployment of labour required by him. He shall not have also any claim for compensation by reason of any alterations having been made in the original specifications, drawings, designs and instructions, which may involve any curtailment of the work, as originally contemplated.

- (1) However, the contractor will entitled for compensation for loss, if any on date of notice, for the purchased materials or for the contract executed for the materials to be purchased for such work. Such compensation will be paid only for actual loss for materials, if such materials so purchased or agreed to purchase is of required quantity/quality and was purchased/contracted to be purchased only for the same work. But to compensation shall be granted to contractor on material for which advance has been give to contractor by owner. The amount of loss for such claim will be decided by Architect/Owner.
- (2) The contractor also will be entitled for compensation of unemployed labourers for 7 days from the date of notice provided that in that opinion of Architect/Owner such labours were working for 7 days prior to the notice and would not be in a position to get employment elsewhere within 7 days from the date of such notice. The contractor should try to employ such unemployed labourers at other places from the date of such notice. In case the Contractor does not agree with decision of Architect/Owner. Engineer regarding the amount of compensation or loss it will be open for the contractor to appeal to Owner. Within one month from the date of knowledge of such decision. In such case the decision of Owner will be final and binding to the Contractor.
The Contractor shall not be entitled for loss of any expected profit of such work.

- Clause 19** The contractor shall not be entitled to claim any compensation from Owner on account of delay by Owner in the supply of materials entered In Schedule 'A' where such delay is caused by (i) Non supply due to short allotment of quota in case materials available under quota regulations (ii) Difficulties relation to the supply of railway wagon (iii) Force majeure. (iv) Act of God. (v) Act of the county's enemies or any other reasonable cause beyond the control of Owner.
In the case of such delay In the supply of materials, Owner shall grant such extension of time for the completion of the work as shall appear to the to the Architect/Owner the reasonable in accordance with the circumstances of the case. The ceeision of Architect/Owner for the extension of time shall accepted as final by the contractor.
- Clause 20** **Time limit for unforeseen claims:** the contractor shall not be entitled to any compensation from Owner on nay account unless where allowed by the conditions of this contact. In such cases, the contractor shall have to submit a claim in writing to the Owner within one month of the cause of such claim occurring.
- Clause 21** **Action & Compensation in case of bad work:** If at any time before the expiry of defects liability period as detailed in clause 22. It shall appear to the Architect/Owner or his sub-ordinate in charge inferior quality or that any materials or articles provided by him for the execution of the work are unsound, or of a quality inferior to that contracted for or are otherwise not in accordance with the contract. It shall be law full for the Architect/Owner to intimate this fact in writing to the contractor and then not with standing the fact that the work, materials of articles of complained of may have been passed, certificate and paid for the contractor shall be require, or if so required, shall remove the materials or articles so specified in whole in part and the case may provide other proper and suitable materials or articles at his own charge and cost, and in the event his failing to do so within a period to be specified by the Architect/Owner in the written intimation aforesaid, the contractor shall be liable to pay compensation at the rate of one percent on the amount of the estimate of the rectification for every day not exceeding ten days during which the failure so continues, and in the event of any such failure as aforesaid continuing beyond ten days, the Architect/Owner may rectify or remove, and re-execute the work or remove and replace the materials complained of as the case may be at the risk and expense in all respects of the contractor. Should the Architect/Owner consider that any such inferior work or materials as described above may be accepted or made use of, it shall be within his discretion to accept the same at such reduced rates as he may fix therefore.
However, the contractor shall be responsible for normal maintenance of the work till the final bill for work is prepared by Architect/Owner.
- Clause 22** **Defect liability periods:** *The contractor shall be responsible to make good and remedy at his own expense any defect, which may develop or may to be noticed before period mentioned hereunder form the certified date completion. The Architect/Owner shall give the contractor a notice in writing about the defects and the contractor shall make good the same within 15 days of receipt of notice. In the case of failure on the part of the contractor, The Architect/Owner shall be entitled to appropriate the whole or any part of the amount of security deposit towards the expenses, if any, incurred by him in rectification, removal or re-execution. **The defects liability period shall be 36(THIRTY SIX) months from the certified date of completion.***
- Clause 23** Work to be open to inspection – contractor or responsible agent to be present: - All works under or in course of execution or executed in pursuance of the contract shall, at all times be open to the inspection and supervision of the Architect/Owner and his subordinates and the contractor shall, at all times during the usual working hours, and all other times for which reasonable notice of the intimation of the Architect/Owner or his subordinate to visit work shall have been given to the contractor, either himself be present to receive orders and instructions or have a responsible agent duly accredited in writing present for that purpose. Orders given to the contractor duly authorized agent shall be considered to have the same force and effect as of they had been given to the contractor himself.
- Clause 24** **Employment of a qualified site Engineer by the Contractor. The contractor shall employ full- time technically qualified staff during the execution of his work as under:**
- 1. Two graduate Civil Engineer and three diploma Civil Engineer when cost of the work to be executed is more than Rs. 50 lacks.**
 - 2. One graduate & two Diploma Civil engineer when the work to be executed is more than 15 Lacks but less than Rs. 50 Lacks.**
 - 3. Minimum One Diploma Civil Engineer when the cost of work is less than Rs. 15 Lack but more than Rs. 5 Lacks.**

4. Minimum two Diploma Civil Engineer for the work when the cost of work to be executed is less than Rs. 5 Lacks. The Engineer so employed for the work must have sufficient experience to handle the work independently. Such an Engineer shall have to stay at the site of the work and he shall not be entrusted with other duty except this work. In case the contractor or partner of the contractor firm is a civil Graduate Engineer, Employment of a separate Engineer will not necessary provided that the Engineer partner himself attends the execution of the work on the site.

Clause 25 **Notice to be Given before work is covered up:** The contractor shall give not less than five day's notice in writing to the Architect/Owner or his subordinate in charge of the work before covering up or otherwise placing beyond the reach of measurement any work in order that the same may be measured and correct dimensions there of taken before the same is so covered up or placed beyond the reach of measurement and if any work shall be covered up or placed beyond the reach of measurement without search notice having been given or consent obtained the same shall be uncovered at the contractor's expense and any default thereof, no payment or allowance shall be made for such work or for the materials with which the same was executed.

Clause 26 If the contractor or his workmen, or servant shall break, deface injure or destroy any part of the building or the work in question in/on which they may be working or any building, road, fence enclosure or grass land or cultivated ground contiguous to the premises on which the works or any part thereof is being executed or if any damage shall be done the work from any cause whatever before a damage occurred/caused due to normal flood or rain or if any imperfections become apparent in it within three months of the grant of a certificate of completion, final or otherwise by the Architect/Owner, the contractor shall make good the same at own expenses or in default, the Architect/Owner may cause the same to be made good by the contractor, and deduct the expenses (of which the certificate of the Architect/Owner shall be final) from any sums that may thereafter become due to the contractor or from his security deposit or the proceeds of sale thereof or a sufficient portion thereof.

Clause 27 Neither party shall be liable to the other for any loss or damage occasioned by or arising out of acts of God, such as Unprecedented flood, volcanic eruption, earthquake or other convulsion of nature and other acts such as not but restricted to general strike, invasion, the acts of foreign countries, hostilities, or war like operations before or after declaration of war, rebellion, military or Usurped power which prevent performance of the contract and which could not have been foreseen or avoided by a prudent person.

Note: - "Unprecedented Flood" means the flood crossing the High flood level of the past _____ year(s) which is on the available record.

Clause 28 Contractor to supply plant, ladders, scaffolding etc. and is liable for damage arising from non provision of light, fencing etc.: The contractor shall supply at his own cost all materials (except special materials if any, as may, in accordance with the contract to be supplied from the Owners Stores), plant, tools, appliances, implements, ladder, condrage, tack, scaffolding, and any temporary which may be required for the proper execution of the work whether in the original, altered or substituted form and whether included in the specifications, or other documents forming part of the contract or referred in these conditions or not and which may be necessary for the purpose of satisfying with requirements of the Architect/Owner as to any matter or which under these conditions he is entitled to be satisfied or which he is entitled to require together with carriage therefore to and from the work. The Contractor shall also supply without charge the requisite number of persons with the means and work and materials necessary for the purpose there of setting out works and counting, weighing and assisting in the measurement or examination at any time and from time to time, of the Contractor and the expenses may deducted from any money due to the contractor under the contract of from his security deposit, or proceeds of sale there of a sufficient portion there of. The contractor shall provide all necessary fencing and lights required to protect the public from accident and shall also be bound bear expenses of defense of every suit, action or other legal proceeding at law that may be brought by any person for injury sustained owing to neglect of the above precautions and to pay any damages costs which may be awarded in such suit, action or proceedings to any such person, or which may with the consent of the Contractor, be paid in compromising any claim by any such person.

Clause 29 The Contractor shall provide suitable scaffolds and working platforms, gangways and stairways, and shall comply with the following regulations in connections therewith.

- (a) Suitable scaffold shall be provided for workmen for all works that cannot be safely done from a ladder or by other means.
- (b) A scaffold shall not be constructed and taken down or substantially altered except.
 - (i) Under the supervision of a competent and responsible person.
 - (ii) Appointed by contractor and by competent workers possessing adequate experience in this kind of work.
- (c) All scaffolds and appliances connected therewith and all ladders shall
 - (i) Be of sound materials

- (ii) Be of adequate strength having regard to the loads and strains to which they will be subjected, and
- (iii) Be maintained in proper condition
- (d) Scaffolds shall be so constructed that no part thereof can be displaced in consequence of normal use.
- (e) Scaffolds shall not be overloaded so far as practicable the load shall be evenly distributed.
- (f) Before installing the lifting gear on scaffolds, special precaution shall be taken to ensure the strength and stability of the scaffolds.
- (g) A competent person shall periodically inspect scaffolds.
- (h) Before allowing a scaffold to be used by his workmen, the Contractor shall, whether the scaffolds. Has been erected by his workmen or not, take steps to ensure that it complies fully with the regulation herein specified.
- (i) Working platforms, gangways shall be so constructed that no part thereof can bind to contractor, dag unduly or unequally.
 - (i) Be so constructed and maintained having regard to the prevailing conditions as to reduce as far as practicable risks of persons tripling or slipping and-
 - (ii) Be kept free from any unnecessary obstruction.
- (j) In the case of working platforms, gangways working places and stairways at a height exceeding ... (to be specified)
 - (i) Every working platform and every gangway shall be closely boarded unless other adequate measures are taken to ensure safety.
 - (ii) Every working platform and every gangway shall have adequate width, and
 - (iii) Every Working platform, gangway working place and stairway shall be suitably fenced.
- (k) Every opening in the floor to building or in a working platform shall, except for the time and provided with suitable means to prevent the fall of persons or materials.
- (l) When persons are employed on a roof where there is danger of falling from a height exceeding ... (to be specified) meters suitable precaution shall be taken to prevent the fall of persons of materials.
- (m) Suitable precautions shall be taken to prevent persons being struck by articles witch might fall from scaffold or other working pleased.
- (n) Safe means of access shall be provided to all working platform and other working places.

Clause 30 The Contractor shall comply with the following regulations as regards the hoisting appliances to be used by him-

- (a) Hoisting machines and tackle including their attachments, anchorage and supports shall.
 - (i) Be of good mechanical construction, sound materials and adequate strength and free from patent defect, and
 - (ii) Be kept in good repair and in working order
- (b) Every rope used in hosting or lowering materials or as a means of suspension shall be of suitable quality and adequate strength and free from patent defect.
- (c) Hoisting machines and tackles shall be examined and adequately tested after erection on the site and before use and re-examined in position at intervals to be prescribed by Architect/Owner.
- (d) Every chain, ring, hook, shackle, swivel and pulley block used in hoisting or lowering materials or as a means of suspension shall be periodically examined.
- (e) Every crane driver or hoisting-appliance operator shall be properly qualified.
- (f) No person who is below age of 18 years shall be in control of any hoisting machine, including any scaffolds, not shall given signals to the operator.
- (g) In the case of every hoisting machine and of every chain, ring hook, shackle, swivel and pulley block used in hoisting or lowering or as a means of suspension the safe working load shall be ascertained by adequate means.
- (h) Every hoisting machine and all gears referred to in preceding regulation shall be plainly market with the safe working load.
- (i) In the case of hoisting machine having a variable safe working load, each safe working load and conditions under which it is applicable shall be clearly indicated.
- (j) No part of any hoisting machine or gear referred to in regulation 'g' above shall be loaded beyond the working load except for the purpose of testing.
- (k) Motors, gears, transmission, or gear wiring and other dangerous parts of hoisting appliances shall be provided with sufficient safeguards.
- (l) Hoisting appliance shall be provided with such means as will reduce to a minimum the risk of the accidental descent of the load.
- (m) Adequate precautions shall be provided with such means as will reduce to a minimum the risk of suspended load becoming accidentally displaced.

Clause 31 Measures for Prevention of fire: The contractor shall not set fire to any standing jungle, trees, bush wood or grass without a written permit from the Architect/Owner. When such permit is given and also in all cases when destroying cut or dug up trees. Bush wood, grass etc. by fire, the contractor shall take necessary measure to prevent such fire spreading to or otherwise damaging surrounded property.

Clause 32 Liability of contractors for any damages done in or outside work area: Compensation for all damage done intentionally or unintentionally by Contractor's labours whether in or beyond limits of Owner property including any damage caused by the spreading of fire mentioned in the clause 31, shall be estimated by the Architect/Owner, shall be final and the contractor shall be bound to pay the amount of assessed compensation on demand, failing which the same will be recovered from the contractor as damages in the manner prescribed in clause 1 or deducted by the Architect/Owner from any sums that may be due or become due from Owner to the contractor under the contract or otherwise.
The contractor shall bear the expenses of defending any action or other legal proceeding that may be brought by any person for injury sustained by him owing to neglect or of precautions to prevent the spread of the fire and he shall also pay the damages and cost that may be awarded by the court in consequence

Clause 33 Deleted

Clause 34 Work not to be sublet. Contract may be rescinded and security deposit forfeited for subletting it without approval or for bribing a public officer or if contractor become insolvent: The contract shall not assigned or sublet without the written approval of the Architect/Owner. And if the contractor shall assign or sublet his contract or attempt to do so or become insolvent or commence any proceeding to get himself adjudicated insolvent or make any compromise with his creditors, or attempt to do so the Architect/Owner may, by notice in writing rescind the contract, Also if any bribe, gratuity, gift, loan perquisite reward or advantage, pecuniary or otherwise, shall either directly or indirectly be given promised or offered by the contractor, or any of his servants or agents to any public officer or person in the employ of Owner in any way relating to his office or employment or if any such officer or person shall become in any way directly or indirectly interested in contract, the Architect/Owner may thereupon by notice in writing rescind the contract, in the event of contract being rescinded, the security deposit of the contractor shall thereupon stand forfeited and be absolutely at the disposal of Owner and the same consequence shall ensue as if the contract had been rescinded under clause 3 thereof and in addition the contractor shall not be entitled to recover or be paid for any work therefore actually performed under the contract.

Clause 35 Sums payable by way of compensation to be considered as reasonable compensation without reference to actual loss: All sums payable by a contractor by way of compensation under any of these conditions shall be considered as a reasonable compensation to be applied to the use of Owner without reference to the actual loss or damage sustained and whether any damage has or had not been sustained.

Clause 36 Change in the constitution of firm to be notified: In the case of a tender by partners, any change in the constitution of a firm shall be forthwith notified by the Contractor to Architect/Owner for his information.

Clause 37 Works to be under directions of Architect/Owner/Consultant: All works to be executed under the contract shall be executed under the direction and subject to the approval in all respect of Architect/Owner/Consultant appointed by the Owner for the time being, who shall be entitled to direct at what points or point and in what manner they are to be commenced and from time to time carried on.

Clause 38 (1) Disputes to be referred to arbitrator: The disputes relating to this contract, so far as they relate to any of the following matters, whether such disputes arise during the progress of the work or after the completion or abandonment thereof, shall be referred to the Arbitration Tribunal, Gujarat State, Gandhinagar.

Namely-

(i) The rates of payment under clause 5 for any tools, materials and stores, in or upon the works of the site thereof belonging to the contractor or procured by him and intended to be used for execution of the work or any part thereof possession of which may have been taken by the Architect/Owner under the said clause 5 as completed fully in accordance with the sanctioned specifications.

(ii) The reduction in rates made by the Architect/Owner under clause 10 from the items of work not accepted as completed fully in accordance with the sanctioned specifications.

(iii) The rate of payment for any class of work which is included in the additional or altered work carried out by the contractor in accordance with the instructions of the Architect/Owner under clause 17 and the rates for which is to be ascertained under the said clause 17.

- (iv) The rates of payment for materials already purchased or agreed to be purchased by the contractor before receipt of notice given by the Architect/Owner under clause 18, and / or the amount of compensation payable to the contractor under the said clause for loss in respect of such materials.
- (v) The amount of compensation which the contractor shall be liable to pay under clause 21 in the event of his failure to rectify, remove or reconstruct the work within the period specified in the written intimation of the amount of expenses incurred by the Engineer-in-removing and under the said clause 21 in rectifying removing or re-executing the work or in removing and replacing the materials or ratifying complained of.
- (vi) The reduction of rates as may be fixed by the Architect/Owner under clause 21 for, the inferior work or materials rates as accepted or made use of.
- (vii) The amount of compensation payable by the contract for damages as estimated and assessed under clause 32.
- (viii) The amount payable to the contractor the work carried out under clause 40 in accordance with the instructions and the requirements of the Architect/Owner in a case where there are no specifications.
- (2) The provision of section-21 of the GPWD disputes Arbi. Tribunal Act-92 & order issued by the Govt. in connection with this Act will now apply for Arbitration (As per government in N.& W.R.D. letter No. SUT/ 1090/ 2679/K2 Dtd. 9/2/94.
- (3) The provision of Arbitration Act. Shall in so far as they are inconsistent with the provision of this act. Cease of to apply to any dispute arising from a works contract and all arbitration proceedings in relation to such dispute before an arbitrator; court of authority shall stand transferred to the tribunal.
- (4) The awards declared by the arbitrator should be speaking award, giving reasons and calculations for every item of claims. The decision will have to be implemented by all the departments of the State Government and public sector enterprises of Gujarat. (Resolution F.D. No. PB/1088/735/KT/Sachivalaya/Gandhinagar 5th October 1988.)
- (5) Incase of dispute leading to the contractor of Government of Gujarat approaching to Court of Law, it shall be within the jurisdiction where the site of work situated.
- (6) The reference to arbitration proceeding under this clause shall not:
 - (i) Affect the right of the Architect/Owner under clause 5 to take possession of all or any tools, plants, materials and stores in or upon the works of site thereof belonging to the contractor or procured by him and intended to be used for execution of the work or any part thereof.
 - (ii) Preclude the Architect/Owner from unitizing the materials purchased by the contractor in any work or from removing such materials to other places, during the period the work is stopped or suspended in pursuance of notice given to the contractor under clause 18.
 - (iii) Entitle the contractor to stop the progress of the work or the carrying out the additional or altered work in accordance with the provisions of clause 17 or as the case may be, of clause 40.

Clause 39 Lump sum in estimates: When the estimate on which a tender is made includes lump sum in respect of part of work, the contractor shall be entitled to payment in respect of the items of work involved or the part of the work in question at the same rates as are payable under this contract for such items, or if the part of the work in question is not the opinion of the Architect/Owner capable of measurement, the Architect/Owner may, as his discretion pay the lump sum amount entered in the estimate and the certificate in writing of the Architect/Owner shall be final and conclusive against the contractor with regard to any sum payable to him, under the provision of this clause.

Clause 40 Action where no specifications: In the case of work for which there is not such specification, such work shall be carried out in accordance with the Standard Specification and in the event of there being no Standard Specification, then in such case the work shall be carried out in all respect in accordance with the instructions and requirements of the Architect/Owner.

Clause 41 Definition of work: The expression or “Work” or “Works” where used in these condition shall unless, there be something in the subject or context repugnant to such contraction be construed to mean the work, or the works, contracted to be executed under or in virtue of the contract, whether temporary or permit and whether original, altered, substituted or additional.

Clause 42 Contractor’s percentage whether applied to net or gross amount of the bill: Percentage referred to in the tender shall be deducted from/added to the gross amount of the bill before deducting the value of any stock issued.

Clause 43 Non-refund of quarry fees & royalties: The contractor shall pay the royalty to the competent authority/local body as per rules. The contractor shall furnish quarterly the statement showing quantity of quarried materials, from whom purchased (with full address of the seller) and copies of bills for purchase to the District Officer of the Mining and Geology Owner or authority competent to levy royalty in the area of wok. Copy of such statement shall be furnished to the Owner etc. Contractor shall also furnish such additional information as regards royalty payment to the Owner and the Royalty authority. The royalty charges paid shall be borne by the Contractor and shall not be reimbursed by the Owner.

Clause 44 Compensation under the workmen's compensation Act: The contractor shall be responsible for and shall pay compensation to his workman payable under the Workmen's Compensation Act 1923. (VIII of 1923) hereinafter called said Act for injuries caused to the workman. If Owner pays such compensation as principal under sub-section 12(1) of the said Act on behalf of the Contractor it shall be recoverable by Owner shall be recovered in the manner laid down in clause 1 above.

Clause 45 The contractor shall be responsible for and shall pay the expenses of providing medical aid to any workman who may suffer a bodily injury as a result of an accident. If Owner incurs such expenses, the same shall be recoverable from the contractor for with and be deducted, without prejudice to any other remedy of Owner from amount due or that may become due to the contractor.

Clause 46 The contractor shall provided all necessary personal safety equipment and first aid apparatus available for the use of the person employed on the site and shall maintain the same in suitable condition for immediate use at any time shall comply with the following regulations in connection therewith:

- (a) The workers shall be required to use the equipment so provided by the Contractor and Contractor shall take adequate steps to ensure proper use of the equipment by those concerned.
- (b) When work is carried on in approximate to any place where there is a risk of drowning all necessary equipment shall be provided and kept for use and all necessary steps shall be taken for the prompt rescue of any person, in danger.
- (c) Adequate provision shall be made for prompt first aid treatment of all injuries to be sustained during the course of the work.

Clause 47 The quantities shown in the tender are approximate and no claim shall Be entrained for quantities of work executed being less than being less than those entered in the tender. In the case of increase in the quantities by more than 10%. The new rate will be paid to the contractor for the quantities in excess of 10%. The rate for the increased quantities as aforesaid will be fixed in the manner specified in clause 17.

Clause 48 Employment of famine or other labour: The contractor shall employ any famine, convict or other labour or particular kind or class, if ordered in writing to do so by the Architect/Owner.

Clause 49 No compensation shall be allowed for any delay caused in the starting of the work on account of delay in making available the full site of land at a time.

Clause 50 Claim for compensation for delay in the execution of work: No claim for compensation shall be allowed for any delay in execution of the work on account of Water standing in borrows pits or compartment. The rates are inclusive of hard or cracked soil, excavation in mud, sub soil water or water standing in borrow-pits and no claim for an extra rate be entertained unless otherwise expressly specified.

Clause 51 Entering upon or commencing any portion or work: The contractor shall not enter upon or commence any portion or work except with the written authority and authority and instruction of the Architect/Owner or of his subordinate in charge of work. Failing such authoritys the Contractor shall have no claim to ask measurement of or payment for work.

Clause 52

Clause 53 The employment of donkeys and / or other animals and the payment of fair wages: For Asphalt work (s) as far as possible, only the contractors should employ the adult persons. If the adult person is not available then the children below the age of 15 (fifteen years) should not be employment under any circumstance.

- (ii) No contractor shall employ donkey or other animals with breaching of string or thin rope. The breaching must be at least three inches wide and should be of tape (Nawar)
- (iii) No animal suffering from sores, lameness or emaciation or which is immature shall be employed on the work.
- (iv) The Architect/Owner or his agent is authorized to remove from the work any person or animal found working which dose not satisfy theses conditions and Owner shall accept no responsibility for any delay caused in the completion work by such removal.
- (v) The Contractor shall pay fair and reasonable wages to the workman employed by him in the contract undertaken by him. In the event of dispute arising between contractor and his workmen on the ground that the wages paid are not fair and reasonable, the dispute shall be referred without delay to the Architect/Owner who shall decide the same. The decision be of the Architect/Owner shall be conclusive and binding on the Contractor, but such decision shall not in any way effect the conditions in the contract regarding the payment to be made by Owner at the sanctioned tender rates.
- (vi) The contractor shall provide drinking water facilities to the works / labourers employed on Owner works. Amenities relating to sanitation shall also be provided to the workers / labourers the Architect/Owner shall give notice writing and it the contractor does not provide this facility to the.

Workers / labourers within a period of ten days from the date of the notice writing, the Architect/Owner shall thereupon make the arrangement for drinking water at the cost of the contractor.

(vii) The contractor shall the amenity of proper shade and shelter to the work's/ labourers and their children on Owner work as soon as the work starts. It is contractor fail to provide shed and shelter; the Architect/Owner shall provide it at the cost of contractor.

Clause 54 Method of payment: Payment to contractor shall be made by cheque drawn on any treasury bank of the Owner provided the amount exceeds Rs.10 amount not exceeding Rs.10 will be paid in cash.

Clause 55 Employment of scarcity labour: If Owner declares a state of scarcity or famine to exist in any village situated within 16 kilometers of the work, the Contractor shall employ upon such parts of the works as are suitable for unskilled labour any person certified to him by the Architect/Owner or by any other person to whom the Architect/Owner may have delegated this duty in writing to be in need of relief and shall be bound to say such persons which may arise in connection, with the implementation of this clause shall be decided by the Architect/Owner whose decision shall be final and binding on the contractor.

Clause 56 The rates to be quoted by the Contractor must be inclusive of all taxes No Extra payment on this account will be made to the contractor.

Clause 57 The Contractor should, as far as possible, obtain his requirement of labourers skilled and unskilled, from the nearest Employment Exchange so as to utilize the local employment potential. If there are no local Employment Exchange or such Exchange are not able to provide the required labour locally, suitable labourers should be utilized to the maximum extent possible.

Clause 58 Fair Wages: If Contractor fails to pay within '7' (Seven) days to the labourer(s) /workers(s) the minimum wages prescribed by the Owner under the Minimum Wages Act, 1948 as in force from time to time, the Architect/Owner shall be at liberty to deduct the amount payable to the labourer/workers from his (Contractors) bill or deposit(s) payable by the Contractor after making due inquiries and establishing the claim(s) of the labourer(s) / worker(s).

The Contractor shall not be entitled to any payment of compensation on account of any loss that the contractor may have to incur on account of the action as aforesaid. Before the action as aforesaid, is enforced, a notice in writing to the contractor shall be issued by the Architect/Owner to pay the wages as per Minimum Wages Act in force at the relevant time, If Contractor dose not act as aforesaid within seven days, then the action contemplated as above shall be taken against him.

Clause 59 List of machinery: The contractor shall also give of machineries in his possession and which they propose to use on the work.

Clause 60 (i) In case, the roller deployed by Owner for the use on contract work is kept idle by the contractor for want of adequate labour and materials, the contractor will have to pay rental charges as per prevailing rules even though items of rolling and watering are to be carried out by the Owner.

(ii) If the contractor doses not plan his program so as to suit the requirement of the Owner, the proportionate rental charges on roller shall be recovered from the contractor.

Clause 61 Local labours on normal rates: The contractor shall have to engage local labour and person seeking employment where available on normal rate.

Clause 62 Rent will be recovered from the contractor for the land given to them for stacking materials well as for contractor of temporary hutments etc.

Land measuring Charges

1. One hectare of less	Rs.5 Per month
2. More than 1 hectare & up to 2 hectares	Rs.10 Per month
3. More than 2 hectare & up to 3 hectares	Rs.15 Per month
4. More than 1 hectare & up to 4 hectares	Rs.20 Per month

Clause 63 The contractor shall employ only such labour who shall produce a valid certificate of having been vaccinated against small-box within a period of last three years.

Clause 64 Huts: The contractor shall build sufficient number of huts on a suitable plot of land for use of the labourers according to the following specifications.

(1) Huts of bamboo's and grass may be constructed.

(2) A good site shall be selected. High ground removed from jungle but well provided with trees shall be chosen wherever it is available. The neighborhood of rank jungle, grass or weeds should particularly be avoided. Camps should not be established close to large cuttings of earthwork.

- (3) The lines of huts shall have open spaces of at least 10 m between rows. When a good natural site cannot be procured, particular attention should be given to the drainage.
 - (4) There should be no over-crowding. Floor spaces at the rate of 2.8 Sq. m. per head shall be provided. Care should be taken to see that the huts are kept clean and in good order.
 - (5) The contractor must find out his own land. If he wants Owner land, he should apply for it and pay assessment for it.
2. **Drinking Water:** The contractor shall as far as possible, provide an adequate supply of chlorinated pure potable drinking water for the use of labourers. This provision shall be at the rate of not less than 4.5 liters per head. No provision need-be made where there is a suitable nalla, river or well within 4.0 km of the camp. However arrangement should as possible, be made to chlorinate water by chlorinated tablets before it is allowed for drinking purpose.
 3. **The contractor shall contract semi permanent latrines for the use of Labourers on the following scale, namely:**
 - (a) Where females are employed, there shall be at least one latrine for every 25 females
 - (b) Where males are employed, there shall be at least one latrine for every 25 males.
Provided that where the number of males or female exceed 100, it shall be sufficient if there is one latrine for every 25 males or females, as the case may be up to the first 100 and one for every 50 thereafter.
 4. **Privacy in latrines:** Every latrine shall be under cover and so partitioned off as secure privacy, and shall have a proper door and fastenings.
 5. **Notice to be displayed outside latrines and urinals:** (1) where workers of both sexes are employed there shall be displayed outside each block of latrine and urinal a notice in the language understood by the majority of the workers For Men Only or For Women Only: as the case may be.
5(2) The notice shall also bear the figures of a man or a women, as the case may be.
 6. **Urinals:** There shall be at least one urinal for male/female workers up to 50 employed at a time provided that where the number of male or female workmen, as the case may, be exceeds 500, it shall be sufficient if there is one urinal for every 50 males or females up to the first 500 and one for every 100 males or females or part thereof.
 7. **Latrines and Urinal to be accessible:** (1) The latrines and urinals shall be a conveniently situated and accessible to workers at all times at the establishment (2) (i) The latrines and urinals shall be adequately lighted and shall be maintained in a clean and sanitary condition at all times (ii) Latrines and urinals other than those connected with a flush sewage system shall comply with, the requirements of the Public Health Authorities.
 8. **Water for latrines to be accessible:** Water shall be provided by means of pipes or tanks otherwise so also be conveniently accessible in or near the latrines and urinals.
 9. **Bathing and washing places:** (1) The contractor shall construct sufficient number of bathing places; every unit of 20 persons being provided with a separate bathing place. (2) Washing places should also be provided for the purposes of washing clothes. Every unit of 30 persons shall have at least one washing place. (3) Such bathing and washing places should be suitably screened and separate places provided for male and female workers. (4) Such facilities shall be conveniently accessible and shall be kept in clean and hygienic condition.
 10. **Drainage:** The contractor shall make sufficient arrangement for draining away the sewerage water as well as water from the bathing and washing places and shall dispose off this water in such a way as not to cause nuisance. The contractor should obtain permission from the Gujarat Water Pollution Control Board, Gandhinagar if water is so be drained in river or near the well. The contractor would put malarial oil once in week stagnant water round about in the residence.
 11. **Medical facilities:** The contractor shall engage a medical officer with a traveling dispensary for a camp having 500 or more persons if there is no Government's or other private dispensary situated within 6 km. from the camp.
 12. **Conservancy and cleanliness:** The contractor shall provide the necessary staff for effecting the satisfactory conservancy and cleanliness of the camp to the satisfaction of the Architect/Owner. At least one sweeper per 200 persons should be engaged Conservancy staff should dump refuse in compost pit, away from the labour camp.

- 13. Health Provisions:** The District Health Officer of the District or the Deputy of Health Services shall be consulted before opening a labour camp and his instructions, on matters, such as the water supply, sanitary convenience, the camp-site, accommodation and food supply shall be followed by the contractor.
- 14. Precautions against epidemic:** (a) The authorities in charge of the colonies should get the labourers inoculated against cholera and plague and vaccinated against smallpox at the time or recruitment, if they are not inoculated or vaccinated within 6 months or 3 years respectively prior to the date of recruitment.
- (b) When, in any labour camp there is an epidemic disease or threatened with such an outbreak, the authorities in charge of the labour camp should ensure that all the inmates of the labour colonies are inoculated or vaccinated as the case may be depending on the diseases, within 72 hours after the outbreak.
- (c) The authorities in charge of the labour colony should arrange to communicate by wire regarding the outbreak of the epidemic diseases on the very day of outbreak, to the Mamlatadar of the Taluka the District Health officer or to the Deputy Director Public Health in charge of that area and the Director of Public Health. Thereafter they should continue to send daily reports to the above officers in the prescribed form regarding the progress of the epidemic disease.
- (d) When the authorities in charge of the labour colony suspect or have reason to believe that any inmate of the labour colony suffering from the infections or contagious disease, they shall forthwith arrange for the segregation of such person to isolated huts to be specifically provided for the purpose and also for their treatment.
- (e) As regional malaria epidemic outbreaks are likely to occur in such project areas, the authorities in charge of the labour colony should report promptly the occurrence unusual incidence of cases of malaria and also inform the District Health Officers of the District Deputy Director of Public Health (Malaria) and the Director of Public Health and also arrange to institute all necessary ant malarial measures as may be advised by the officials of the Public Health Owner.
- (f) The authorities in charge of the colonies should also arrange to carry out other measures that may be recommended by the officials of the Public Health Owner necessary to prevent or control the spread of disease.
- 15. Rest rooms:** (1) In every place where in contract labour is required to halt at night in connection with the contract works and in which employment of contract labour is likely to continue for three months or more, the contractor shall provide and maintain rest rooms or other suitable alternative accommodation within fifteen days of the employment of contract labour.
- (2) If the amenity referred to in sub rules is not provided by the contractor within the period prescribed the employed shall provide the same within a period of fifteen days of the expiry of the period laid down in the sub-rule (1)
- (3) Separate rooms shall be provided for women employees.
- (4) Effective and suitable provision shall be made in every rooms for securing and maintaining adequate ventilation for the circulation of fresh air and there shall also be provided and maintained sufficient and suitable natural or artificial lighting.
- (5) The rest rooms or other suitable alternative accommodation shall be of such dimensions as to provide latest a floor area or 1 sq. mt. for each person making use of rest rooms.
- (6) The rest rooms or other suitable alternative accommodation shall be so contracted as to afford adequate protection against heat, wind, rain and shall have smooth, hard and impervious surface.
- (7) The rest rooms or other suitable alternative accommodation shall be at convenient distance from the establishment and shall have adequate supply of wholesome drinking water.
- 16. Canteen Facilities:** (1) In every establishment of contact work and wherein work regarding the employment of contract labour is likely to continue for six months and wherein contract labour numbering one hundred or more are ordinarily employed, the adequate canteen facilities shall be provided by the contractor for the use of such contract labour within sixty days of the commencement of contract labour.
- (2) If the contractor fails to provide the canteen facilities of within time laid down the same shall be provided the principal employer within sixty days of the time allowed to the contractor.
- (3) The canteen shall be made by the contractor or principal employees as the case may be in an efficient manner.
- 17. Accommodation in canteen:** (1) The canteen shall consist of at least dining hall, kitchen storeroom, pantry and washing places separately for workers and for utensils.
- (2) (i) The floor shall be made of smooth and impervious materials and inside walls shall lime-washed or color washed at least once in each year, provided that inside walls of the kitchen shall be lime-washed every four months.
- (3) (i) The premises of the canteen shall be maintained in clean and sanitary condition.
- (ii) Wastewater shall be carried away in suitable covered drains and shall not allowed to accumulate so as cause nuisance.

(iii) Suitable arrangements shall be made for collection and disposal of garbage.

18. Accommodation in dining hall: (1) The dining hall accommodates at a time, at least 30% of the contract labour working at a time.

(2) The floor area of the dining hall excluding the area occupied per dinner to a accommodated shall as prescribed in sub rule (1)

(3) (i) A portion of the dining hall and service counter hall be partitioned and reserved for women workers, in proportion to their numbers (ii) Washing places for women shall be separate and screened to secure privacy.

(4) Sufficient table, stools, or benches shall be available for number of diners of be accommodated as prescribed in sub rule (1)

19. Equipment in Canteen:

(1) (i) There shall be provided and maintained sufficient utensils, crockery cutlery, furniture and any other equipment necessary for the efficient running of the canteen.

(ii) The furniture utensils and other equipment shall be maintained in a clean and hygienic condition.

(2) (i) Suitable clean clothes for the employees serving in the canteen shall also be provided and maintained.

(ii) A service counter, if provided, shall have a top of smooth and impervious materials.

(iii) Suitable facilities including adequate supply of hot water shall be provided for the cleaning of utensils and equipment.

20. Foodstuff to be served: The foodstuff and other items to be served in the canteen shall be in conformity with the normal food habits of the contract labour.

21. Prices to be displayed: The charges for foodstuff, beverages and other items served in the canteen shall be based on "no profit, no loss" and shall be conspicuously displayed in the canteen.

22. Canteen to be run on "No profit no loss" basis: in deriving the prices of food stuffs and other articles served in the canteen, the following items shall not be taken into consideration as expenditure, namely.

(a) The rent for the land and building

(b) The depreciation and maintenance charges for the building and equipment provided for in the canteen.

(c) The cost of purchase, repairs and replacement of equipment including furniture, crockery, cutlery and utensils.

(d) The water charges and other charges incurred for lighting and ventilation.

(e) The interest on the amount spent on the provisions and maintenance of furniture and equipment provided for in the canteen.

The local officers should check up whether, facilities as offered and which are admissible under the existing rules and orders are made available to the workers and enforce upon the contractors the necessity of adhering to the instructions from promotion of welfare of the workers according to the terms of the contract.

23. Books of accounts and registers of the canteen: The books of accounts and registers and other documents used in connection with the running of the canteen hall are produced on demand to an inspector.

24. Audit of the Accounts of the canteen: The accounts pertaining to the canteen shall be audited once every 12 months by registered accountants and auditors, provided that Labour Commissioner may approve of any other person to audit the accounts. If he is satisfied that it is not feasible to appoint a registered accountant and auditor in view of the site or the location of the canteen.

Clause 65 Contractor shall have to arrange for supply of gumboots. Hand gloves, mask etc. Invariably to the labourers/ workers engaged the contractor on asphalt work.

Clause 66 The contractor shall not show any distinction between Harijan and other class of labourers/workers employed to the carry out the work.

Clause 67 Price variation Clause: Price variation: For (A) Labour (B) Materials and (C) P.O.L The amount payable to the Contractor for the work done shall be adjusted for increase or decrease in the rates of labour/materials excepting those materials supplied by Owner as per Schedule A and P.O.L. as under:

(A) Labour: Increase or decrease in the cost due to labour shall be calculated quarterly in accordance with the following formula.

$$VI = 0.75 \times \left\{ \frac{PI \times R \times i - io}{100 \quad io} \right\}$$

DELETED

VI = Increase or decrease in the cost of work during the during the quarter under consideration due to change in rates of labour.

R = The value of work done in rupees during the quarter under consideration, after excluding the value of extra item and after deducting the cost of.

- (i) Materials supplied from the Owner store to the Contractor at fixed rate as specified in schedule A and
- (ii) Value of cement and steel brought by the contractor valued at star rate plus the increases / decrease for which price adjustment is done under sub-clause (B-2) below:

io = The average consumer price index for industrial workers for the quarter in which tenders were opened (as published in * ...)

i = The average consumer price index for industrials for the quarter under consideration.

PI = Percentage of labour components (specified in Schedule...)

* This refers to average consumers price index (Wholesale) for industries workers as applicable to Ahmedabad / Bhavnagar as published by Owner of India. Ministry of Labour Bureau.

* **(B) Materials other than Cement and steel and asphalt:** The increase or decrease in cost of materials other than cement and steel shall be calculated quarterly in accordance with the following formula.

$$V_m = 0.75 \times \left\{ \frac{PI \times R \times i - i_o}{100 - i_o} \right\}$$

<p>(ii) Value of cement and steel brought by the contractor valued at star plus the increase/decrease for which price adjustment is done under the clause below.</p> <p>io = The average wholesale price index (all commodities) for the quarter in which tenders were opened. (as published in @..)</p> <p>i = The average wholesale price index (all commodities) for the quarter under consideration.</p> <p>Pm = Percentage of materials component (specified in schedule)</p> <p>@ = For materials wholesale price index as published by Reserve Bank of India</p>	<p>the increase/decrease for which price adjustment is done under the clause below.</p> <p>io = The average wholesale price index (all commodities) for the quarter in which tenders were opened. (as published in @..)</p> <p>i = The average wholesale price index (all commodities) for the quarter under consideration.</p> <p>Pm = Percentage of materials component (specified in schedule)</p> <p>@ = For materials wholesale price index as published by Reserve Bank of India</p>
--	---

(C) P.O.L.: The increase or decrease in the cost of petrol, diesel, oil and lubricants shall be calculated quarterly in accordance with the following formula.

$$V_d = 0.75 \times \left\{ \frac{P_d \times R \times (D - D_o)}{100 - D_o} \right\}$$

Vd = Increase or decrease in the cost of work during the quarter under consideration (ii) Value

of cement steel brought by the contractor valued at star plus the increase/decrease for which price adjustment is done under sub clause above: -

Do = The average price of high-speed diesel (HSD) fixed by I.O.C. for the district which the work is to be carried out for the quarter in which the tenders were opened.

D = The average price of HSD fixed by the I.O.C. for the district in which the work is to be carried out the quarter under consideration.

Pd = Percentage of P.O.L Component (specified in schedule) of the item.

Conditions except for B-2 Formula:

- (1) No adjustment shall be done for the work done in the first twelve months of the limit. Adjustment payable/ recoverable will be calculated for the remaining work done during the subsequent period.
- (2) The sum total price adjustment will be limited to ... % of the subsequent period. Less the cost at cement and steel valued at input rates mentioned as under on which the sanctioned estimated is based.

QUANTITY

Input rate per ton

Cement: _____ Mts. Rs. _____

Mild Steel: _____ Mts. Rs. _____

HYSB Bars:

(3) The quarter referred to in the above formula shall mean the quarter of the calendar year January to March, April to June, to September and October to December, Even is the tenders are opened in the middle of a quarter, the average index for the calendar quarter will be considered. The same principle would apply for identifying the quarter when the work is completed in the middle of calendar quarter.

(4) The value of extra items will be excluded for working out the value of 'R' in the above formula in all these cases.

- (5) Intermediate payment of escalation to be made under this clause on each occasion shall be limited in such a manner that the up-to-date payment of escalation will not exceed the proportionate percentage of the ceiling of escalation as related to the proportionate value of the contract cost.
- (6) Price adjustment shall be applicable only for work that is carried out within the stipulated time or extensions thereof as are not attributable of the contractor. No claims for price adjustment other than those provided herein shall be entertained.
- (7) This clause will be applicable in respect of which of the estimated cost put to tender is above Rs.25.00 lacs and the time limit involved in more than 12 months.

STAR RATES

QUANTITY

Cement Rs. _____ Mt.
 Mild Steel Rs. _____ Mt.
 HYSD Steel Rs. _____ Mt.

[The above star rates are linked with Reserve Bank of India price index for steel and cement for the month in which the DTPs are approved. The rate for asphalt will be based on the rate of Koyli Refinery prevailing in the month in which the estimate is prepared.

The month in which DTPs are approved will be specified in the tender document.

Star rates should be mentioned in the tender copy as under:

- I. For Cement, Price of cement from authorized dealer should be obtained for the month in which the D.T.P.s are approved and mentioned as star rate before issue of tender copy.
- II. For steel & H.Y.S.D. bars, rate of SAIL should be obtained for the month in which the DTPs are approved and mentioned as star rate before issue of tender copy.
- III. For basic index specific month in which the DTPs are approved should be mentioned before issue of tender copy]

The fluctuations in rates of cement and steel shall be adjusted in the bills payable to the constrictors as under:

$$A = B \times \left\{ \frac{CI - 1}{Co} \right\} \times D$$

A= Difference of Amount payable or recoverable
 B= Star rate of steel/cement

CI- The (Quarterly) average corresponding index for steel cement for the quarter under consideration (as published in monthly bulletin for Reserve Bank of India)

Co- Price index of cement/steel for the month in which the DTPs are approved published in monthly bulletin of Reserve Bank of India).

D- Qty. of cement/steel actually brought by the contra (for on site of work and consumed in the work during the quarter duly supported bill as recorded in cement consumption register or MB (for steel)

Conditions for variation in prices of cement and steel only: -

- 1 No Ceiling for escalation for difference in the cost of steel and cement will be applicable.
- 2 This clause shall be operative from the date of issue of work order and up to expire of original and extended time limit.
- 3 This formula shall be used individually for cement/mild steel and Tor steel for calculating adjustment.
- 4 The cement and steel brought by the contractor on site of work shall be used only after the Owner tests the same is tested by the owner.
- 5 If such materials are not found, as per the requirement of I.S. specification, the contractor for which no claim shall be entertained shall remove the same.
- 6 This clause will be applied to the work estimated to cost above Rs.15 lacs. And the time limit involved is more than 12. Months.

Conditions for variation in rates of asphalt only: -

1. The contractor shall purchase asphalt directly from the refinery or oil Company only.
2. The contractor will not be furnished "P" from for purchase of quantity of asphalt required for this work. The test certificate regarding the grade of asphalt shall be produced in original all the gate passes issued by the refinery and also the bill in original to the Architect/Owner.
3. The contractor will have to produce in original all the gate passes issued by the refinery and also the bill in original to the Architect/Owner.
4. The contractor shall furnish the GERI Laboratory or other Laboratory approved by R & B Department shall have to be produced.
5. The difference between two actual rates of purchase as per original bill of the refinery produced and the star rate as indicated below for the quantity of asphalt actually used in the work during original time limit only will be paid/ recovered after the asphalt is consumed in said part of work. No escalation for the works estimated to cost up to 15 Lacks and involving use of asphalt will be payable.
 Star rate per MT Rs. _____ Rupees _____
6. The difference will be payable/recoverable from the date of issue of work order and this price variation will not be subject to any ceiling.

7. No advance payment or secured Advance will be payable against asphalt.
8. This part of clause for price variation of asphalt will be applicable for works estimated to cost above Rs. 15 Lacks and involving use of asphalt.

Clause 68 FENCING AND LIGHTING:

- (a) The contractor shall unless otherwise specified, be responsible for the proper fencing lighting grading and taking of the necessary safety measures for all works comprised in the contract and for the proper provision of temporary road, way foot-way, guards, fences, caution notices etc. as far as the same may be tendered necessary by reasons of the work for the accommodation of foot passengers or other traffic and of Owners and occupiers of adjacent property and the public and shall remain responsible for any accidents that any occur on account of his failure to take proper & timely precautions.
- (b) All the arrangements made for fencing and lighting shall be maintained by the contractor through the currency of the contract till the physical taking over of the work by Owner.

Clause 69 LIABILITIES OF ACCIDENTS TO PERSONS:

Responsibilities and liabilities of the contractor under Worker's Compensation Act are given in clause No.44 in addition following shall also apply: (a) On the occurrence of an accident, which result in death of workmen employed by the contractor or which is so serious as likely to result in death of any such workmen the contractor, shall within 24 hours of happening of such accident (s) intimate, in writing to the Architect/Owner the fact of such accident(s). The contractor shall indemnify Owner against all loss or damage sustained by the Owner resulting directly or indirectly from his failures to give intimation in the manner aforesaid including the penalties or fines, if any, payable by the Owner as a consequence of Owners failure to give notice under the Workmen's Compensation Act or otherwise to conform to the provisions of the said act in regard to such accident(s).

(b) In the case of an accident, in respect of which compensation may become payable under Workmen's Compensation Act, whether by the contractor or by the Owner as principal Employer, it shall be lawful for the Architect/Owner to retain out of money due and payable to the Contractor, such sum or sum of money as may, in the opinion of the Architect/Owner, be sufficient to meet such a liability. The opinion of the Architect/Owner shall be final in regard to all matters arising under this clause.

Clause 70 ACCESS TO SITE AND WORK IN SITE: The Engineer may, if he considers fit from to time, enter upon any land (s) which may be in possession of the contractor this contract for the purpose of agent or by other contractors, at his opinion and the contractor shall in accordance with the requirements of the Architect/Owner afford all reasonable facilities for execution of the work including occupation of lands by structure of otherwise for any other contractor employed by the site of work Owner and his workmen or for the workman of the Owner who may be employed in the execution on or near the site of the work not included in the contract or of any contract in connection with or ancillary to the work and in default, the contractor shall be liable to the Owner for any delay or expenses incurred by reason of such default, Provided always that if damage arising make a statement of the same to the Architect/Owner who shall from time assess the value in his judgment of such damage and the Owner shall from time to time pay to the contractor the amount (if any) accepted as justified by the Architect/Owner.

Clause 71 REPORTS REGARDING LABOUR:

The contractor shall submit the following reports to the Architect/Owner:

- (a)(i) A daily report in the suitable form of the strength of labour, both skilled and unskilled employed by him on the work(s). The contractor shall increase or decrease the strength both skilled and unskilled. If directed by the Architect/Owner. The submission of such reports shall not, however, relieve the contractor of his responsibilities and duties regarding progress or any obligations under the contract.
- (ii) A classified weekly returns in suitable form of the number of person employed on the works during the proceeding week.
- (iii) A weekly medical report in the suitable form showing the health of the contractor's camp, the number of person's ill incapacitated and the nature of their illness.
- (iv) A report of any accident, which may have occurred to be sent within 24 hours of occurrence.
- (v) Such other report as may be prescribed.

Clause 72 Treasure Trove:

In the event of discovery by the contractor or his employees, during the progress of work of any gold, silver, oil or other minerals of any description and precious stones, treasures, coins, quantities, relic, fossils or other articles or value of interest whether geological archaeological or any other such treasure & other things shall be deemed to be the absolute property of the Owner and the contractor shall duly preserve the same to the satisfaction of the Architect/Owner from time and relieve the same such person as the Architect/Owner may appoint.

The contractor shall take all reasonable precautions to prevent his workmen or any other person from removing or damaging any such articles or things, immediately after the discovery thereof and before removed acquaint the Architect/Owner with such discovery and carry out his orders for the disposal of the same.

Clause 73 Indemnity:

The contractor shall indemnify the Owner against all actions, suits claims & demands through or made against the Owner in respect of work of this contractor against any loss damage to Owner in consequences of any action or suit being brought against the contractor anything done or omitted to be done in execution of the work of this contract.

Clause 74 Insurance of Labours:

The contractor shall be responsible to arrange for insurance of all labourers, skilled and unskilled workers, and supervisors' etc. employed by him as per labour regulation of the state.

Clause 75 Setting out:

The contractor shall be responsible for the true and proper setting out of the works and the correctness of positions, levels, dimensions and alignments of all parts of the work and for the provisions all necessary instruments, appliance and labour in connection therewith, if at any time during the progress of the work, any errors, appear or arise in the position, levels, dimensions or alignment of any part of the work, the contractor, on being required to rectify such errors by the Architect/Owner shall at his own expense do so to the satisfaction of the Architect/Owner. If however, such error is based on incorrect data supplied in writing by the Architect/Owner: the expenses of rectifying the same shall be borne by the Owner. The checking of and setting out of any line or level by the Architect/Owner or his representative shall not in any, way, relieve the contractor of his responsibilities for the correctness of the error. The contractor shall carefully protect and observe all benchmarks site nails, page and other things used in setting out of the work

Clause 76 Cement Register:

A register in the prescribed from showing day-to-day receipt, consumption and balance of cement on site of work will be maintained by the Owner, which shall invariable be signed daily by the contractor or his authorized representative in token of its correctness.

Clause 77 Materials and Works Test Register:

A register in the prescribed perform showing day to day receipt consumption and balance of cement on the site of work by the contractor and every entry there of shall invariable be checked by the Architect/Owner.

Clause 78 Progress Schedule:

(a) The contractor shall furnish within one month (unless extended by Architect/Owner) of the order to start the work, the progress schedule in quadruplicate indicating the date of starting, the monthly progress expected to be achieved and the anticipated Completion date of each major item of work to be done by him also indicating dates of procurement and setting up the materials plants and machinery. The schedule should include a statement of proposed general and detailed arrangements for carrying out works, and of item, order and manner in which it is proposed general and detailed arrangements for carrying out works, and of item order and manner in which it is proposed that these shall be executed. The schedule should be framed keeping requirement of the clause 2 of tender from in view and be such as in practice to the achievement towards completion of the work in the time limit and of the particular items on the dates specified in the contract and shall have the approval of Architect/Owner. Further, the dates for the progress, as in this schedule shall be adhered to.

In case it is found necessary, at any stage to alter the schedule, the contractor shall submit in good. Time a revised schedule incorporating necessary modification proposed and get same approved from the Architect/Owner. No revised schedule shall be operative without such acceptance in writing. The Architect/Owner is further empowered to ask for more detailed schedules. Any week-by-week for any item or items and the contractor shall, supply the same as and when asked for.

(b) The Architect/Owner shall have, at all times, the right without in any way vitiating this contract forming grounds for any claim, to alter the order of the work of any part there of and the contractor shall after receiving such direction, proceed in the order direct. The contractor shall also revise the progress, schedules accordingly and submit four copies of the revised schedule to the Architect/Owner within seven days of the said Engineer's direction to alter the order of works.

(c) The contractor shall furnish sufficient plant. Equipment and labour and shall work such hours and shifts as may be necessary to maintain the progress of the work as per approved progress schedule. The working and shift hour shall comply with all the Owner regulations in force shall be such as

may be approved by the Architect/Owner and the same not be varied without the prior approval of Architect/Owner.

- (d) The contractor shall from time to time, as may be required by the Architect/Owner. Furnish the Architect/Owner with a statement in writing of the arrangements he proposes to adopt for the execution of this contract and the Architect/Owner may, if he considers necessary at any time advise alternation in the same, which the contractor shall adopt on notice thereof.
- (e) The progress schedule(s) shall be in the form of progress chart, forms, statements and/or reports as may be approved by the Architect/Owner.
The contractor shall submit four copies showing the progress of the work in the form of a chart etc. at periodical intervals as may be specified by Architect/Owner.
- (f) The approval of the progress schedules by Architect/Owner shall not relieve the contractor of the Schedule required by the Architect/Owner shall not entitle the contractor to any extra payment.

Clause 79 Secured Advance to Contractor:

- (1) Before any secured advance for metal is paid to the contractor, the metal shall have to be tested for its quality in the laboratory. Contractor's request for such secured advance will be considered only after test results of metals are received and results are satisfactory.
- (2) Advance on security of materials brought to site will not exceed 75% of the value (as assessed by the Architect/Owner) of such materials provided that they are of imperishable nature.
- (3) Recovery of advances will not be postponed until the whole of the work entrusted is completed. Secured advance will be recovered within 3 months from the month in which secured advance is given.
- (4) Secured advance is permissible on materials, which are all actually brought on site and are required by the contractor for use on items of works for which rates for finished work have been agreed upon.
- (5) Secured advance will be given only on materials for which the contractor pays the full value to the seller.

Clause 80 Advance Payment: Advance Payment for the work done, but not Measured, may be made up to 80% of the approximate value work done as shown in the progress reports of approximate measurement Sheets with location furnished by Architect/Owner subject to the following conditions: -

- (1) That in the case of advance payment on the item of earthwork payment should be made on the basis of detailed measurements except during the monsoon period (June to September).
- (2) That the detailed measurement should be recorded within the month from the date of payment of the bill incorporating the advance payment. However in the case of sectional measurements of earthwork, detailed measurements should be recorded within their months instead of one month stipulated above.
- (3) If, on recording of the detailed measurements, it is found that advance payment shall be refunded forthwith by the contractor or demand, if it cannot be adjusted from the bill in which the item/s on which advance payment was given are recorded by measurements.

Clause 81 Advance Against Machineries:

- 1. Secured advance on plants and machinery's brought to the site of work is admissible for the contracts estimated to cost more than Rs. Ten Lacks.
- 2. Simple interest in such advances granted to contractor against plants and machinery's brought to work sites be charged at the rate of ...% per annum.
- 3. The recovery of the advance shall be effected from the second month in which advance is given and full recovery will be completed by the time seventy five percent of scheduled time is completed.
- 4. Such advance will be limited to 5 percent of the estimated amount put to tender.
- 5. The advance will be limited to 5 percent actually brought to the work.
- 6. The machinery and equipment on which the advance is granted shall be of full undisputed Ownership of the contractor, and they shall be hypothecated to Owner and also comprehensively insured till the advance granted is fully recovered. The hypothecation deed shall be executed separately before the advance is actually given.
- 7. The advance will be granted as 75 percent of the cost of new equipment for which the contractor is able to produce purchase-voucher and other documents. This will not be applicable in the case second-hand equipment purchased by the contractor.
- 8. In the case of used or second-hand equipment brought by the contractor, advance will be allowed at 50 percent of the value of the equipment arrived at in following manner:-
 - (a) For used equipment, for which the records of original purchase price and utilization are available, depreciated value, so worked out.
 - (b) For used equipment, for which proper records of purchase price and past utilization are not available, approved valuer will assess the value. The value assessed will be based on the probable age of the equipment, its present condition and its probable depreciated value, in working out depreciation age of the equipment, its present condition and probable Owner of spares, repair, reconditioning of the equipment's shall not be taken into account towards the capital cost. The value arrived at by the will approved valuer will be final.
- 9. No. Advance may be allowed for equipment which is more than 8 years old or which has already worked for more than 80 percent of its life.

10. No. Advance shall be given to transport-vehicles like jeeps, station-wagons, estate-car and such other vehicle ordinarily required for transport purposes.
11. The recovery will have to be completed within the stipulated period of completion of work i.e. _____ months

Clause 82 Mobilization Advance:

1. Mobilization advance to the extent of 5% of the estimated cost may be granted at the commencement of the work after the contractor has set up camp on site has brought machinery equipment and centering etc., for well-sinking and has completed the work of service road, water-supply and lighting arrangements on the site of works which are estimated to cost over Rs.40 lacks.
2. The advance will carry a simple interest at the rate of _____ % Per annum.
3. The recovery of advance shall commence from the sixth month from the month in which the advance is paid and full recovery of advance and interest shall be completed by the end of _____ month from the date of issue of the work order, in other words, ~~the recovery of advance~~ and interest will spread over a spell of ...months or less a above in equal installments.
4. A bank guarantee from a schedule commercial bank shall have to be produced for the amount of advance applied for; the back guarantee can be scaled down to the extent of recovery of advances.
5. Mobilization advance will be treated as interest bearing refundable loan for purpose. The responsibility of the Contractor for the refund of Mobilization Advance is absolute and not dependent upon the completion of the work. The contractor will have to refund the advance with accrued interest irrespective of the fact whether either party of abandoned or finalized prematurely breaches the contract.

Clause 83 Before starting the work, the contractor will have to obtain the license from the District Assistant Labour Commissioner under the Contract Labour (Regulation and Abolition) Act, 1970 and contract Labour (Regulation and Abolition) Gujarat rules 1972 after paying necessary fees and deposit on the basis of the number of labourers to be employed on the work and will have to supply two true copies of the said license to the Deputy Executive Engineer before the work is started.

Clause 84 One percent of estimated cost put to tender for this work after deducting the cost of materials as per Schedule 'A' valued at basic rate in the sanctioned estimate shall be deducted from the running account bills of the contractor for testing the quality of materials and workmanship, no additional testing charges in addition to the above shall be recovered from the contractor.

However in respect of work involving use of asphalt, the contractor will set up the site testing Laboratory and will provide testing instruments etc. as under:

Laboratory: The contractor will construct pucca structure of minimum 25 square meter area duly connected with water and electric supply to house site testing Laboratory.

Instruments: The contractor will provide and install the instruments as per following I.S. Standard to carry out the test prescribes therein.

1. Penetration test as per I.S. 1203.
2. Softening point test as per I.S. 1204.
3. Ductility test as per I.S. 1208
4. Viscosity test as per I.S. 1206.
5. Specification gravity test as per I.S. 1202.

The instruments provided should be as per I.S. Standard, so certified and be regularly and periodically calibrated.

Frequency of tests will be as indicated in specifications and as referred in R. & B. D. G. R. No. SSR – 1099 – IB/91 (9) – C dated 26-7-1999.

Annexures: - The information in the following annexures specimens should be furnished on separate letter pad if necessary

Annexure 1

To,
Executive Engineer
Building Department,
Bhavnagar Municipal Corporation
_____Bhavnagar

DATE:

PLACE:

Details regarding my/our partners our Company (in the case of limited Company) Names, address (es), telephone numbers(s) Income Tax No etc. are as under:

Sr. No.	Names(s) of Person/ Partner Director of the company	Full address of the Places of business (with pin code)	Telephone No. (s) (office)	Residential Address(es)	Telephone No. (s) Resi.	Full address of income tax Office ward where income tax return is filed
1	2	3	4	5	6	7

I/We hereby agree to intimate to you about change if any, in the above mentioned address (es) and telephone No. (s) within Fifteen days of its occurrence till my/our deposit, for the said work paid by me/us is not returned to me/us.

Dated Signature of Tenderer

Annexure 3

PERFORMANCE BOND

(SEE CLAUSE NO. 1)

(The date of this bond must not be prior to the date of the instrument in connection with which it is given).

.....Principal (Contractor)
.....Surety (Bank)

Sum of Bond (express in words and figures)

Contract No. and date of contract

KNOW ALL MEN BY THESE PRESENTS, THAT WE, THE PRINCIPALS AND SURETY above named are held and firmly bound up to the hereinafter called the Employer in the amount stated for payment of which sum, well and truly to be made, we bind ourselves, our heirs, executors, administrators and successors jointly and severally, firmly by these presents subject to the provisions of which the aforesaid Contractor on demand and without demand on a claim being made by the employer.

THE CONDITION OF THIS OBLIGATION IS SUCH that whereas the principals have entered in to a contract with the Employer numbered and dates as shown above and hereto attached for the execution of work

NOW THEREFORE, if the Principal shall well and truly perform and fulfill all the undertakings, covenants, terms, conditions and agreements of said contract during the original terms of the said contract and any extensions thereof that extensions thereof that may be granted by the Employer with or without notice to the surety and during the life or any guarantee required under the contract and shall also well and truly perform and fulfill all the undertakings, covenants, terms, conditions and agreements of any all duty and unduly authorized modifications of said contract may hereafter be made, notice of which modifications to the surety being hereby waived or shall pay over, make good and reimburse to the Employer all loss and damages which the employer may sustain by reason of failure or default on the part of said Principal so to do. We further agree that the guarantee herein Contained shall remain in full force and effect during the period that would be taken for the validity of the said Contract, and that it shall continue to be enforceable till all the dues of the employer under or by virtue of the Contract have been fully paid and its claims satisfied or discharged or till the Employer certifies that the terms and conditions of the Contract have been fully and properly carried out by the said Contractor and accordingly discharges the guarantee. Unless a demand or claim under this guarantee is made on us in writing on or before the we shall be discharged from all liability under this guarantee thereafter.

IN WITNESS WHERE OF, the above bounded parties have executed this instrument under their several seals on the date indicated above the name and corporate seal of each corporate partly being hereto affixed and these presents duly signed by its undersigned by its undersigned representatives, pursuant to authority of its governing body.

In the presence of witness
Principal

1. as to(seal)
 2. as to(seal)
 3. as to(seal)
 4. as to(seal)
- by Affix Corporate Seal

Attested

Corporate surety

Business Address _____

Affix by corporate Seal

Title

For and on behalf of the Employer

Annexure 4

LIST OF WORKS ALREADY COMPLETED BY TENDERER

Sr. No.	Name of work	Place	Cost On completion	Time taken in months To complete the work	Remarks
1	2(a)	2(b)	3	4	5

* Necessary certificate from the officer concerned shall be attached with the tender.

Annexure 5

LIST OF PLANT AND MACHINERY IN GOOD WORKING ORDER AVAILABLE WITH THE TENDERER

Sr. No.	Plant or Machinery	Location	Age of Machinery	Make.	Capacity	Approximate Value	Remarks
1	2(a)	2(b)	3	4	5	6	7

* Necessary certificate from the officer concerned shall be attached with the tender.

Tender Sign of

Annexure 6

DECLARATION REGARDING WORKS ON HAND WITH TENDERER

Sr. No.	Name of work	Place	Estimated Cost	Date of issue of work order	Stipulated period of completion	Amount of work done on date of filling tender	Brief detail of delay if any	Remarks
1	2(a)	2(b)	3	4	5	6	7	8

* Size of Tender
Signature of Tenderer with Date

Note 1: Amount of work in column 6 should be given the month previous to the month in which tenders are invited.

* Necessary certificate from the officer concerned shall be attached with the tender.

SCHEDULE 'A'

Schedule showing (approximate) the materials to be supplied from the store for work contracted to be executed and the rates at which at which they are to be charged for

Particulars	Approximate Quantity	Rate of which the materials will be charged to the contractor		Place of delivery
1	2	Unit	Rate in Rupees	5
		3	4	

--	--	--	--	--

SCHEDULE – ‘B’

Memorandum showing items of works to be carried out

Items No.	Quantities estimated but may be more or less	Item of work	Estimated Rates		Unit	Total Amount according to estimated quantities
			In figure	Inwards		
1	2(a)	2(b)	3	4	5	6
	As per attached sheet					

I/We am/are willing to carry out the work at ...% above/below percent (should be written in figures and words) of the estimated rates mentioned above. Amount of my/our tender works out as under.

*Estimated amount Put to tender Rs. ... Add: ...% above Rs. ... Total Rs. ... In words	*Estimated amount Put to tender Rs.... Deduct ...% below Rs.... Net Rs.... In words...
---	---

(Please strike out whichever is not applicable)

- Note: 1 All work shall be carried out as per Public Works Owner Handbook and other standard specification or as directed.
 Note: 2 All the column is Schedule be filled in ink and the total of the entries in the last column should be struck by the contractor under his signature.
 Note: 3 Rates quoted include clearance of site (prior commencement of work and at its close) in all respect and hold good for work under all condition, site, moisture, weather etc.
 Note: 4 to be continued on additional sheets, if found necessary.

SCHEDULE – ‘C’

Time Schedule, for completion of different designate parts of the work and rte of liquidated damage of be paid by the Contractor, if he fails to complete the part of work within stipulated the limit it as detailed above:

Percentage of time of the total time limit	Time schedule of completion percentage of work	Rate of liquidated damages per day
1	2	3

<u>Earth Work</u> 25% 50% 75% 100%	16% 50% 75% 100%	0.1% 0.1% 0.1% 0.1%
<u>Buildings Works</u> 25% 50% 75% 100%	10% 40% 80% 100%	0.1% 0.1% 0.1% 0.1%
<u>Road Work</u> 25% 50% 75% 100%	25% 50% 75% 100%	0.1% 0.1% 0.1% 0.1%
<u>Bridge work</u> 25% 50% 75% 100%	10% 40% 80% 100%	0.1% 0.1% 0.1% 0.1%

**EXECUTIVE ENGINEER
BUILDING DEPARTMENT
BHAVNAGAR MUNICIPAL CORPORATION
BHAVNAGAR**

PROPOSED DEVELOPMENT OF NIGHT SHELTER AT FULSAR, FOR B.M.C, BHAVANAGAR

SECTION- II

SPECIAL CONDITIONS OF CONTRACT

ARCHITECTS:-

CHINTAN SACHAPARA

ARCHITECTS

3, SHAHIBAUG, ABOVE HOME DÉCOR, WAGHA WADI ROAD,

BHAVNAGAR

PHONE : 9428401640

SPECIAL CONDITIONS OF CONTRACT

1. The work under this contract is for the proposed development of **PROPOSED DEVELOPMENT OF NIGHT SHELTER AT FULSAR, FOR B.M.C, BHAVANAGAR**
- 2 The contractor shall execute the work as per the terms, conditions,
 - (v) Specifications, drawings and details attached here with and issued from time to time during the course of work along with necessary instructions. The special terms and conditions contained here with shall over rule, the general Terms and conditions, if any, such General Condition and terms are in conflict with such Special terms & conditions.
1. All the works contained in the Schedule and any further work that may come up during the continuance of the contract shall be carried out with the same schedule of Rates, terms, conditions, specifications and according to the instructions of the Architect and the Owner.
- 4 The teak wood shall be best quality Teak wood as mentioned in the list of approved materials or equivalent and approved by the Architect / Owner.
- 5 In all the items of works where it is with plaster or finish, it shall mean cement plaster of neeru / sand faced finish or as specified and instructed.
- 6 All the materials shall be in accordance with the general specifications of materials and list of approved materials attached.
- 7 Bricks shall be first class table moulded, kiln burnt and shall be approved by the Architect and having a minimum crushing strength of 35 kg / sq cm.
- 8 The coarse aggregate of R.C.C. & other cement concrete work shall be trap stones approved by the Architect/ Employer. Cement concrete for all R.C.C. and other work shall be machine mixed, machine vibrated and using boxes only and it shall be strictly carried out as per codal provisions, instructions and details given from structural consultant / architect / employer for each and every structural members.
- 9 The Marble slab shall be hard, uniform and homogeneous in texture. They shall have even crystalline grain and free from defects and cracks. The surface shall be mirror polished to even and perfectly plain surface and edged machine cut true and square. The rear face shall be rough to provide key for the mortar. The Marble slab shall be white or of other colour as specified and of best quality.
- 10 The kota flooring shall be of approved and uniform colour and free from flaws and shall be hand cut and mirror polished and in perfect right angle corner.
- (11) After hearing the approval of the tender, the contractor shall place the order immediately for materials like bricks; stones, etc. required for the work in order to get them on site well in advance of the requirement. Sample of every material and item of work to be executed for this work shall be approved in advance.
- (12) The contractor shall not claim any compensation for any items of works that can be carried out by specialist contractor / other contractor and which may be deleted from the contract.

- (13) The quantities in the schedule are approximate and likely to vary. No compensation or extra charges will be allowed for variation in quantities of work or for omission or alteration of any item of works.
- (14) The contractor shall have to procure steel and cement from the open market for the work and shall make necessary arrangements for its proper storage.
- (15) The work shall be carried out according to plans, specifications and conditions of contract as prepared by the Architect.
- (16) The work is to be completed within **32 Months(including Monsoon Period)** from the date of order for commencement of work and in a case of delay beyond the specified time, the contractor is liable to penalty @ 1% per month on the contract amount. This penalty shall be levied to the extent of 10% of the contract amount. When the penalty amount exceeds 10% of the contract amount the contractor shall stop work and the contract would be terminated by the Employer. The balance work shall be executed by any other contractor at the cost / risk / expense of the first contractor. In case of slow progress of work retention money @ 5% of the immediate running bill / bills shall be deducted / continue to be deducted. The same shall only be released after satisfactory progress of work is achieved as per the approved bar chart and certificate of the same has been obtained from the Architect / Employer.
- (17) The progress of the work shall be maintained by the contractor as instructed by the Architect / Employer.
- (18) The contractor shall have to take water and electric connection at site at his own expense and he shall have to arrange for storing sufficient quantities of water for construction at his cost. The charges for consumption of water and electricity will be borne by the contractor.
- (19) The contractor shall get the rate of such an item fixed and confirmed in writing before starting any extra item.
- (20) These special specifications shall apply to all the material and general specifications shall apply to those items for which there are no special specifications. The decision of the Architect shall be final and binding to both the parties.
- (21) The decision of the Architect shall in the matters of dispute, interpretation of any item of work, specifications and conditions shall be final and binding on both the parties.
- (22) The contractor before proceeding with the work shall deposit insurance policy of an approved Nationalized Insurance company, covering the risk of workman's compensation and third party damages with the Consultant as per the conditions No. 67 B1 of the conditions and renewal from time to time and acknowledgement of the same shall be given to the Employer
- (23) Contractors are request to fill their rates in schedule enclosed, total-up at the end and should clearly write the estimated amount in figures and words arrived at.
- (24) The construction must be completed with in **32 months(including Monsoon period)** from the date of order for commencement of work

- (25) R.C.C. Slabs of all bathrooms and toilet floor shall be sunk except on terrace slab.
- (26) The finished floor levels of balcony, toilets, w.c. and Bath room will be sunk compared to the adjoining finished floor level.
- (27) **Each interim bill submitted by the contractor for payment shall not be less than 5% of the contract amount**
- (28) The contractor shall pay a penalty as per clause no. 2 of general conditions of tender or as per clause no.16 of this special condition of tender whichever is more in case of delay and not sticking to the time schedule.
- (29) Without the prior consent, knowledge and written instruction from the employer or the Architect, the contractor shall not remove any materials, machinery implements from the site.
- (30) The contractor shall be solely responsible and shall bear the costs of materials and labour for re-doing any defective work specially in case of bends, chhajas, cornices and corner. They must be constructed in alignment and plumb and level or else it shall not be certified by the Architect.
- (31) Full-time Bhisties shall be employed by the Contractor for curing and properly watering the works. Number of Bhisties to be employed shall be as per the satisfaction and the instruction of the Architect. Vertical surfaces of all R.C.C. work shall be cured by covering it with wet hessian (kantana) and horizontal surfaces cured by making ponds on it of cement mortar upstands which shall be filled with water.
- (32) The contractor shall not charge extra for brick masonry tank which shall be duly constructed by him for the construction work and shall be demolished after the completion of the work.
- (33) The contractor shall provide at his own cost hutments for a labourers at the site. When any workman are temporarily accommodated within the premises and the contractor shall see to it that no mis-use of the premises is carried out and the same are vacated and the hutments removed before the completed work is handed over to the employer.
- (34) The contractor shall not either through his labourers or through himself cause of allow to be caused any nuisance or annoyance to the neighboring premises, neighbours and occupants of the property itself.
- (35) The contractor shall be responsible for any disfigurement damages to the property when in his possession, after being handed-over to him by the employer, in stipulated time, as laid out in the contract.
- (36) This contract shall include all that is attached detailed drgs, details, specifications, Article of Agreement and all conditions of contract mentioned.
- (37) The necessary certificate from various authorities for work done or to be done in accordance with rules and regulations of local authorities shall be obtained by the contractor.
- (38) The contractor shall make the name-board of the building of size 180cm x 240cm and fix it at the site at appropriate place as directed by the Architect and the contractor shall not

charge extra for it.

- (39) Sub-contractor for electrical and plumbing work shall be license holders and shall have prior approval of the Architect before being employed by the Contractor.
- (40) The contractor shall submit in the office of the Architect the report of the work done every week.
- (41) The contractor's rate shall include all the carting, royalty loading and unloading charges for all materials upto the site of proposed work.
- (42) **Plaster grooves in doors, windows, frames and hold fast over moulds shall be provided by the contractor. The rates of the doors and windows ventilators, rolling shutters, collapsible gate are inclusive of all the necessary hardware, paint, grooves etc. as decided by the Architect.**
- (43) **Drip mould 25mm wide (minimum) shall be provided on the projections of Chhajas concrete work and brick work from the building line and no extra charge shall be paid to the contractor for the same.**
- (44) Two sets of plans and working drawing will be supplied by the Architect to the successful tenderer free of cost from which atleast one set shall be cloth bound / laminated by the contractor and kept at site
- (45) The tender shall be accompanied with list of projects completed by the contractor with approximate value of each project.
- (46) After the completion of works a final coat of colour wash, white wash, oil bound distemper, cement paint or any other paint shall be done as suggested by the Architect
- (47) After completing the wash or colour, the main contractor shall hand-over the building of its part to the Electrical contractor. The Electrical contractor shall hand-over the building or its part after completing the electrical work to the main contractor, who shall execute repairing the damage of the plaster, if any and then carry out the final cost of colour-wash etc.
- (48) After verifying the bills with the site Engineer, the contractor shall submit the bill to the Employer.
- (49) Atleast one graduate civil engineer and an experienced clerk-of-works shall take the instructions from the site Engineer or the Architect from time to time, and they shall be employed by the contractor to remain continuously at site during the course of the entire work. All the work shall be carried out in daytime only from 8.30 am to 6 pm only and any time extension or work permission shall be given only after verifying the reasons.
- (50) The contractor shall provide 100mm thick R.C.C. runners at every 900mm height in all masonry walls and he shall not charge any extra for the same
- (51) The employer is not concerned in any rise or fall in the prices of any materials and charges for labour etc. and the contractor will not be entitled to claim any compensation arising from fluctuations.
- (52) The contractor shall be registered with the local self government as work supervisor & shall fill in & submit the 2-c form to the same as decided by the

Architect.

- (53) Wood work to be treated with anti-termite treatment where it comes in contact with the walls and as specified by the Architect / Employer.
- (54) The contractor shall not object to the Employer who also reserves the right to carry out any items specified in the tender to any other agency as the employers may deem it to be fit and the contractor shall not be paid for any such item that has not been executed by him.
- (55) The contractor shall agree with the rates of any items not considered in the contract and as settled by the Architect with the consent of the employer.
- (56) The possession of the building shall at all times remain with the employer and the contractor is not liable to the possession of the structure.
- (57) The contractor shall be responsible for giving proper co- operation and co- ordination to all other agencies from time to time.
- (58) Teak wood cover moulds and architraves out of 38mm x 25mm Teak wood Dundi as per the design and fixed to all frames as directed by the Architect. The Contractor shall not charge extra for the same.
- | | | | |
|-------------------------|----------------------------|-------------|-------------|
| Doors (Fully Panalled): | Stile | - | 150 x 35mm |
| | Horizontal member top rail | - | 150 x 35mm. |
| | Bottom rail | - | 150 x 35mm |
| | Lock rail | - | 180 x 35mm |
| | Frize rail | - | 150 x 35mm |
| | In filled panel- | - | 25mm thick. |
| Windows | : | Stile | - 75 x 35mm |
| | | Top rail | - 75 x 35mm |
| | | Bottom rail | - 75 x 35mm |
| | | Frieze rail | - 75 x 35mm |
- (59) The building shall be insured against all natural and man made calamities by the contractor during the course of construction from time to time, the value of which shall vary according to the quantum of work done. The premium shall be paid by the contractor but the policy shall be assigned in the favour of the employer and the contractor shall not claim extra for it
- (60) Photographs of size 7"x9" shall be provided by the contractor during the progress of work. Photographs shall be provided at different stages as suggested by the Architect.
- (61) 75% Security Deposit to be paid at the time of agreement and remaining 25% S.D. shall be deducted from running bills at the rate of 2.5% of the contract cost.
- (62) In the event of the tender being submitted by a firm or company it must be signed by the partners as per company's or firm's agreement deed, it shall be signed on his/their behalf by a person/persons holding a power of attorney authorizing to do so. Certified copies of Registration Certificate, Partnership Deed and Power of Attorney will have to be furnished when the tender is to

be considered for acceptance.

- (63) Every tenderer must see the site conditions, scope of works in relation to materials and workmanship, access to site, local condition, local by laws availability of services such as water, electricity, drainage etc. and no demands for extra rates or time from the contractor shall be entertained in this matter.
- (64) The tenderer shall not make any alterations, additions or amendments in the conditions of contract, specifications and descriptions incorporated, Additions or amendments shall be liable to rejection.
- (65) All rate shall be filled in English clearly and legibly.
- (66) All products in the amount columns will be subject to arithmetical check.
- (67) All correction in the rate, unit & amount columns of bills of quantities must be properly initialed.
- (68) The various work will be measured as per standard method of measurements and as laid down by B.I.S.
- (69) The contractor shall check & verify all dimensions on the site before talking up the work on hand.
- (70) In the event of any discrepancy specification in consistency, incompleteness or ambiguity on the drawings and/or specifications the same shall be brought to the notice of the Architect whose decisions on such discrepancy inconsistency incompleteness or ambiguity shall be final and binding on the tender.
- (71) The erection & display of any sub-contractor or advertisement by the contractor or any sub-contractor or person supplying labour, materials or services to the work is prohibited. However, sign relating to fire danger and safety is exempted from this prohibition.
- (72) During the execution of the work it shall be incubement on the part of the contractor to extend all facilities to the Architect and/ or his representative, the consulting Engineer and the clerk of the works to inspect, check and measure the work.
- (73) The quantities against each items given in schedule of quantities may change or be omitted totally without giving any reason and the contractor is bound in execute the item at the same rate as quoted inspite of any variation in the quantity of any items.
- (74) "Employer" shall mean Owner i.e bhavnagar municipal corporation and shall include their legal representative(s), assignee(s) or successor(s).
- (75) " Contractor shall mean the persons or person, firm or company whose tender has been accepted by the employer and includes the contractor's personal representative, executor, administrator, assignee(s) or successor(s).
- (76) "Architect" shall mean

ARCHITECTS:-

CHINTAN SACHAPARA
ARCHITECTS

3, SHAHIBAUG, ABOVE HOME DÉCOR, WAGHA WADI ROAD,

BHAVNAGAR

PHONE : 9428401640

to act as

Architect for the purpose of this contract.

- (78) No material shall be supplied by the Employer and in the event of the Owner supplying any material, the cost of the same shall be deducted from the total amount of the executed item.
- (79) No advance facility towards material stacked on site shall be granted.
- (80) Wherever in the general specification I.S. are mentioned it shall mean the relevant one.
- (81) The contractor shall also be liable to bear all municipal taxes for storages of materials etc.
- (82) Contractor shall agree to do less or more work than scheduled herewith the same special condition of contract, general condition, specifications & schedule of rate without claiming any variation whatsoever shall apply.
- (83) All surface concrete works like TRIMIX, PCC should be vibrated by surface vibrators.
- (84) All types of tests shall be carried out by contractor on his own expense wherever necessary according to given test report charts and submitted to Architect duly signed by authorized person.
- (85) Checklist as attached in this tender shall be submitted by contractor before starting any work duly signed by authorised person or representative of the contractor to the Architect.
- (86) All materials and all items of work and their execution shall be strictly in accordance with relevant I.S. Code including latest revisions of the same.
- (87) All soil tests as advised by the consultant shall be carried out by contractor at his own expense.
- (88) For Non S.O.R. / non tendered item the rate for the same shall be arrived at on the basis of comments Offered by the Architect on the rate analysis prepared and submitted by the contractor. The rate arrived at by the Architect shall be binding to the contractor and owner.
- (89) If there is no technical specification is mentioned that item should be execute as per instructions by Architect / Employer.
- (90) The contractor will have to take water and electric connections at site for which necessary deposits if any will be borne by the Owners, but the actual water and electrical consumption charges shall be borne by the Contractor. The Contractor shall have to arrange for holding sufficient quantity of water at site at his own expenses.
- (91) Contractor shall have to purchase stamp paper to execute this agreement as per Govt at their own cost and the employer shall not give compensation for the same.
- (92) All concrete work shall be cube tested by the Contractor. He shall obtain relevant certificate of test from Authority as prescribed by the Architect. The Contractor shall not be paid extra for these certificates and testing.
- (93) Contractor shall have to maintain cement consumption register as per design

mixes prescribed by the Structural Engineer and this register shall be made available to the Structural Engineer/ Architect/ Employer as and when demanded by them.

- (94) The Contractor shall obtain approval in writing from the Structural Engineer for the entire centering and shuttering as soon as it is put in place prior to placement of steel and concreting.
- (95) The Contractor shall obtain approval in writing from the Structural Engineer for the entire size, length, laps, cutting, placing, binding and placement of steel prior to concreting
- (96) The Contractor shall obtain approval in writing from the Structural Engineer for the entire concreting done for this work.
- (97) The Contractor shall have to submit earnest money deposit and security deposit in form of Small Savings Certificate, Nationalised Bank Fixed Deposit Receipt or in cash only as the amount indicated in memorandum of works in brief.
- (98) All rain water pipe outlet at terrace level/ chhaja level shall be covered with c.i. jali of size 15cmX15cm and fixed to rainwater down take pipe
- (99) **Before casting of any R.C.C. work of any type, form work shall be truly in line level and plumb. The joints of form work shall be finished with cement and grease in proportion of 1:1(1 cement : 1grease) and joints of same shall be covered with 2" wide cellophane tapes.**
- (100) All form work material shall be approved by site engineer before putting it to use and any change or rejection of formwork made by site engineer shall be binding to the contractor.
- (101) All R.C.C. members must be provided with proper cover as per structural engineer's details and the same shall be maintained throughout the work.
- (102) The coarse aggregate and sand for R.C.C work shall be used only after washing it thoroughly in water.
- (103) Railing of balcony, stair case shall be fixed to walls / columns by means of a flange.
- (104) Proper sized saddle shall be provided on wall to fix exposed cast iron/ galvanized line/pvc line to wall in such a way that clear distance between the wall and pipes shall be minimum 50mm. Saddle shall be made M.S. as per details.
- (105) All collar joints of cast iron pipe line shall be jute caulked using jute in first layer and second coat of cement finished on jute to ensure proper joints and all joints and pipes shall be tested to prevent any leakages.
- (106) All bends in cast iron pipe/pvc pipe shall be fitted with proper plug to
(vi) maintain it.
- (107) All pipe line shall be tested before concealing it and any fault that may
(vii) come during testing shall be rectified/replaced.
- (108) Starters shall be used to fix and cast column in R.C.C work and starters
(viii) shall be of good finish of M.S. of adequate size and shape and 75mm in

(ix) height.

- (110) **Grooves shall be provided at junction of plastered surface and wall dedo.**
- (111) All glazed/ceramic tiles in dedo shall be fixed at right angle corner by chamfering their edges at 45 degrees.
- (112) All corner joints in skirting shall be finished with 90 degrees offset and all exposed faces shall be finished with the same level of polish as that of skirting / wall dedo.
- (113) Plaster of paris coating shall be applied on all polished horizontal surfaces on completion of polishing work of stone. The same shall be removed and the stone surfaces thoroughly cleaned prior to handing over the completed work to the Owner.
- (114) Rainwater outlet at ground level shall be extended 30cm from wall and out at 45deg.
- (115) All door / window frames shall be fixed with ties and the same shall be maintained throughout the work till the shutters are fixed. Finished floor level shall be marked on all door frames.
- (116) Grill bars shall be fixed through the window frames and holes in frames shall be finished with mixture of saw dust and adhesives.
- (117) Wire mesh shall be fixed prior to plastering at junction of R.C.C and brick masonry, and chaises cut in walls for plumbing and electrical items.
- (118) Bottom of all electrical boxes shall be truly in tube level.
- (119) **All PCC,RCC,BRICK MASONARY AND plaster work shall be carried out using 53 grade ordinary Portland cement ONLY.**
- (120) All steel reinforcement shall be coated with anti corrosive coating as suggested by the Architect except for TMT / CRS Reinforcement.
- (121) All the work shall be strictly carried out according to drawings, details and instructions given from time to time by Architect / Employer
- (122) Use water and aggregates as specified in I.S. 456-2000 and relevant I.S code
- (123) Form work shall be sufficiently rigid to take up the load and stripping time for form work and props as mention in I.S 456-2000, Clause No. 11.3 page no.25
- (124) Locate construction joint at L/5 span of slabs and beams
- (125) For all structural members use specified concrete mix. At junction of members with grade of concrete use of higher grade.
- (126) During placing of concrete care shall be taken to prevent the displacement or bending of reinforcement from its original position.
- (127) Provide chair of one no. higher diameter than extra top reinforcement diameter.
- (128) **Pin bars shall be provided of minimum 25 mm diameter for extra bars in beams at top at 100 cm c/c distance.**
- (129) Production of concrete shall be mentioned in I.S 456-2000, clause no. 10.2.
- (130) Quality assurance measure shall be as mentioned in I.S 456-2000 clause

10.1.

- (131) Laps in reinforcement bars should be as per length as specified below for slabs and secondary beams, beams supported by beams (except main framing beams) laps may preferably be located at L/ 5 span from support and shall be staggered. For beams and slabs, laps should not be located at mid span and support. There shall be no laps in top and at junction of continuous beams.
- (132) Lap length of reinforcement shall be minimum 50 D (D = diameter of bars)
- (133) Concentration of load such as stacking of building materials on floors during construction shall be avoided.
- (134) All required testing materials, concrete and steel should be followed as per I.S 456-2000, clause no. 15,16 and 17 for continuous assessment of quality of work and materials. Care shall be taken for quality, consistency and soundness of work.
- (135) Curing in masonry should be atleast up to seven days.
- (136) Use of round stone shall not be permitted in any type of construction work
- (137) ***Any vertical R.C.C members shall be cast after construction of adjoining brick masonry work.***
- (138) Safety procedures shall be adhered to during progress of all types of work. The contractor shall take all safety measure such as training the staff/work men for Standard & precaution to take during execution of work for safety. All the contractors workmen shall be equipped with Safety shoes, safety helmet, safety belt, phase tester etc, as required for carrying out the work.
- (139) Contactor shall be responsible for the true and proper location, levels, dimensions and alignment of all parts of the work and if any mistakes are observed in the same they shall be corrected by contractor at his own cost.
- (140) All types of test for all R.C.C. work shall be made by contractor wether material is supplied by owner or not and test result submitted to the consultant and arrangement for same shall be made by contractor.
- (141) All types of test for all materials as suggested by the architect shall be carried out by the contractor free of cost. For testing of basic materials following shall be followed.
- a. sand : every 7 trucks or minimum 3 test in months which ever is more.
 - b. bricks : every 3 trucks or minimum 3 test in months which ever is more.
 - c. cement : test result obtain from company for each and every truck load .
 - d. steel : for every truck load.(aprox-7.5 to 10 tonne)
 - e. stone aggregate of any size : every 4 trucks or minimum 3 test in month which ever is more.
 - f. Stone : every 4 trucks or minimum 3 test in month which ever is more.
- In addition to all the above other required materials during course of construction shall be tested by the contractor as instructed by site engineer and the same shall be submitted to the Architect duly signed by authorized person of the contractor and no extra charge shall be paid for the same.
- (142) Contractor shall have to do the necessary liasoning work and make necessary arrangement for electrical connection, meter, water

connection within a month from the assignment of the work, failing which he shall not be paid for liasoning work charges as quoted in tender.

- (143) All vertical, horizontal and inclined surface joints in all types of R.C.C. form work shall be sealed with "75mm wide packing tapes" of approved make prior to any casting work.
- (144) Contractor shall have to make arrangement for column form work(farma) of minimum side 30cm in width and at least minimum 5nos of such form work for each column size as per structural design. Plywood form work shall not be allowed for columns.
- (145) The contractor shall have to cast concrete of minimum 300 bags of cement per day for R.C.C. work for slabs, beams, pardi, and other R.C.C .member.
- (146) The contractor shall inspect the site of work prior to bidding. Once the bids are received no excuses/claims for the condition of site, its surrounding area etc, shall be entertained. The material used in them and the rates received shall be considered final irrespective of the quantities of work to be executed.
- (147) The contractor shall be asked to submit reports of tests as specified by the consultant for any materials of their end products prior to their use,during their use and after their use, the expenses of their tests shall be borne by the contractor and he shall not be reimbursed any such expenses. These tests shall be conducted at site/or laboratories as specified by the consultant/engineer in charge.
- (148) The contractor shall commence and stop work at site for each and every item of work mentioned in this tender at the time as specified by the owner/Architect No compensation or extra payment shall be made for this.
- (149) Contractor shall keep on site all necessary construction equipments like Vibrator, Mixer machine, Mortar mixing equipments, Pumps, and other equipments in running conditions and the same shall be tested and checked be fore starting of work and stand by equipments of above shall be kept ready in case of any faults that may arise during work.
- (150) Contractor shall clean the site and make proper storage of construction equipments, materials, chemicals, after completion of day time work and any debris, loose powdered material shall be removed from site during the work with out disturbing the premises, traffic and surroundings area and make proper arrangement for disposal of the same.
- (151) During the course of work, the contractor and the work men shall abide by all security regulations that may be prescribed by the owner.
- (152) As far as possible the contractor shall not execute any work after the working hours as prescribed by the owner. In the eventuality of such a need arising, the contractor shall inform the Architect, engineer in charge and the owner in writing well in advance.
- (153) For the execution of this work the contractor shall strictly abide by all the instruction/conditions of this tender and those which may be issued to him from time to time. The contractor shall not claim any extra rate for abiding by any of such instruction/conditions unless agreed upon in advance.
- (154) The special construction chemicals used for this works are expensive and hazardous hence appointing a skilled person to handle these materials and use and apply them in workmanship manner will help in elevating the desired results. Some of the material used have a

prescribed pot life within which the same should be used after mixing. Therefore and contractor shall plan out their use and mix only that quantity of material which can be consumed in the prescribed quantity within the time limit prescribed by the manufacturer. The contractor shall take due care for providing prescribed drying/curing time obtain desired results.

- (155)** The contractor shall have to make two standard pucca RCC bench marks established on each side before commencement of work and connected to the G.T.S. bench marks according to which whole work shall be carried out. The levels shown on the contract drawings accompanying the tender are with reference to G.T.M.B.M., are tentative and for the purpose of general guidance only. the contractor shall establish reference bench mark at intermediate suggested spots. The maintenance of all these B.M.s shall be responsibility of the contractor.
- (156)** The contractor shall provide proper water proofing treatment to building As per company's specifications and shall give written guarantee for above for ten years to the employer in writing and 25% of that amount shall be retained by the employer and release after the end of guarantee period.
- (157)** The Contractor shall have to locate, line out the building and mark out The grid lines and various components of the buildings during the course of work, as per the drawings of the Architect, and get same approved by the representative of the Architect/ Employer.
- (158)** The Contractor shall have to use mixer machine of sufficient capacity, Vibrator of required type, boxes, etc. as required for R.C.C. work.
- (159)** The contractor shall have to wash material like Sand, Coarse aggregate, and other material with the help of bucket or as required and instructed by Consultant and upto the satisfaction of the consultant before put in use.
- (160)** The Contractor shall have to take temporary electrical connection of Sufficient capacity from Pgvcl and all charges and expenses shall be born by the contractor as applicable.
- (161)** During the entire course of work if any damages done to any of the existing steps, stones, structures or environment and ecology of the site, the Contractor shall have to bear all the expenses for rectifying it as suggested by the Architect.
- (162)** During the course of this work the contractor shall use only those equipment and machineries which give minimum vibration on their operation. If the Owner / consultant is dissatisfied about the extent of vibration of equipment and machineries used by the contractor, they shall intimate the contractor about the same and the contractor shall discontinue the usage of the said equipment / machineries immediately. and make alternative arrangement. For the discontinuation and stoppage of the said equipment /machineries the contractor shall not be given any extension in prescribed time limit of the tender nor paid extra.
- (163)** The Contractor may use the existing infrastructure developed by the Owner, but contractor shall have to bear the operational expenses of the said infrastructure for the period of use, during the course of usage of the infrastructure developed by the Owner. If any component of the said infrastructure is damaged during their usage by the contractor he shall rectify the said damage at his own cost. The Owner shall not encourage any demand for extension of time limit or extra cost in the course of any failure in the infrastructure laid by the Owner.
- (164)** The entire work shall be executed in such a way that the existing site

and its surroundings are not disturbed and the environment of the premises is maintained as per guidelines given by the Owner on time to time.

- (165) It is likely that the Owner may issue instructions to stop the work for a certain duration of time in which case the time limit of the tender shall be extended for the same duration without giving any increase in rate agreed upon in the tender.
- (166) Explosives of any kind shall not be permitted for any items of work of this contract other means may be permitted on obtaining prior approval of the consultants.
- (167) The Contractor shall submit a bar chart of the project indicating the time period within which the Contractor shall finish the work and the rate of progress of work that he intends to maintain. The Contractor shall strictly adhere to the bar chart submitted by him and approved by the Architect / Employer.
- (168) The Contractor shall provide proper anti- termite treatment to building, its periphery as per company specifications and shall give guarantee for above for 10 years to the Employer in writing and 25% of the bill amount of anti termite treatment shall be retained by the employer upto the end of guarantee period.
- (169) **Any State / Central Government Tax, GST, Royalty, labour Cess etc. that may be applicable on the Contractor's, bill amount from time to time shall be deducted from the contractor's interim / running bills at rates applicable at that time.**
- (170) **Please note that Rebaring/Anchoring not permitted for any RCC members like Lintel/Sill/Beams/Columns/Copings etc and also if required on site take prior approval from Architects/Structural Consultant/Authority fo the same. Rebaring/Anchoring of any sizes of Reinforcement Steel charges for any R.C.C. Items likes Lintels, Copings, Beams, Columns, R.C.C.Walls, R.C.C. Slabs etc shall be borne by the Contractor. The Contractor shall have to arrange at site at his own expenses.**
- (171) **JOINT VENTURE NOT PERMITTED FOR CONTRACT OF THE PROPOSED WORK.**
- (172) **ALL LIGHTING FIXTURES MUST BE APPROVED BY ARCHITECT (MAKE, MODEL, TYPE, WALTAGE)**
- (173) **All the necessary licences shall obtain for elevator/lift, fire and electric work from the concerned authority/department including necessary noc and conducting liasioning work for the same charges for the same borne(at their own expense) by The Contractor**

***All the above conditions are read by me carefully and are binding to me.**

**Signature of
Agency/The Contractor**

**Signature of
EXECUTIVE ENGINEER
BUILDING DEPARTMENT
BHAVNAGAR MUNICIPAL CORPORATION
BHAVNAGAR**

-: SPECIAL CONDITIONS:-

**1. The bidder to note the following qualifying criteria for bidding.
For Civil/Land Scaping/Electrical Works/Fire Fighting
Work**

i) Average Annual financial turnover during the last 3 years, ending 31st March of the previous financial year, should be at least 30% of the estimated cost. Proof for the same from registered chartered accountant shall have to be produced.

ii) Experience of having successfully completed similar works during last 7 years ending last day of month previous to the one in which applications are invited should be either of the following: -

a. Three similar completed works costing not less than the amount equal to 40% of the estimated cost.

or

b. Two similar completed works costing not less than the amount equal to 50% of the estimated cost.

or

c. One similar completed work costing not less than the amount equal to 80% of the estimated cost.

iii) Definition of "similar work" means the work of similar type of land scaping work for Garden, water bodies' work, paving/flooring work, R.C.C work for building constructed with framed structure.

2. A certificate in Form no 3A of the Competent Officer rank not less than Executive Engineer regarding completing a similar nature of work shall have to be produced by the bidder and the same shall be scanned and uploaded along with the bid at the time of submitting bid and with submission of hard copy. **A tender without the certificate shall be considered non responsive and will not be opened.**

3. For this contract in form B-2 the Government means Bhavnagar Municipal Corporation, Bhavnagar AND Superintending Engineer means City Engineer.

4. The Bank guarantee for the Security deposit shall be submitted for the period of eleven plus three months.

5. **1% from every running bill shall be deducted towards labor cess.**

6. The time for completion of the project shall be 32 Thirty Two months (Including monsoon period) from the issue of LOI.

7. **The Defect Liability period for the project shall be THREE years (Thirty Six Months) from the work completion certificate issued by Engineer in charge.**
8. **For the Electrical work the contractor shall have to prepare and submit complete electric wiring including installation of fixtures diagram** considering the lighting requirement of public building and submit the same for approval; on the approval the work shall be carried out accordingly. For this work all the details shall have to be derived as per the relevant provision of NBC for public building. This should also include water pump procurement and installation on the under ground tank with pump room, for protection from weather.
9. The cost of the permanent electric power connection shall be borne by the Corporation; however the contractor shall liaise for release of connection. The authority will extend every support for the application as well as to produce and submit the documents necessary for approval.
10. The specification for any item if not covered in the tender than it should be as decided by engineer in charge.
11. The contractor shall have to follow test schedule as per relevant IS standard even if not specify otherwise in the tender, at his own cost.
12. Site laboratory requirement shall be as follows

Sr.No.	Particular
1	Temporary room/shed 100 Sq-Ft
2	Slump cone
3	Sieves For Fine Aggregate
4	Sieves for Coarse Aggregate
5	Compressive Testing Machinery
6	Cube Moulds (15cm)-24 no.

13. The drawings attached with the tender are for the over view of the work, the detail drawings and structural design will be supplied by the BMC and the work shall have to carry out accordingly. The quantities may vary at the time of execution.
14. All the material shall be first got approved from the EIC before procurement or use.
15. **Having E.S.I.C/ valid Labor Licenses.**

Notes:-If the above mentioned all conditions are not met with the tender shall be rejected outright without any further processes or reasons.

16. The charges for consumption of water and electricity will be borne by the contractor.
17. The contractor shall get the rate of such an item fixed and confirmed in writing before starting any extra item.
18. The contractor shall not either through his labourers or through himself cause of allow to be caused any nuisance or annoyance to the neighboring premises, neighbours and occupants of the property itself.
19. The contractor shall be responsible for any disfigurement damages to the property when in his possession, after being handed-over to him by the employer, in stipulated time, as laid out in the contract.
20. Atleast one graduate civil engineer, one diploma civil engineer and an experienced clerk- of-works shall take the instructions from the site Engineer or the Architect from time to time, and they shall be employed by the contractor to remain continuously at site during the course of the entire work. All the work shall be carried out in daytime only from 8.30 am to 6 pm only and any time extension or work permission shall be given only after verifying the reasons
21. In the event of the tender being submitted by a firm or company it must be signed by the partners as per company's or firm's agreement deed, it shall be

signed on his/their behalf by a person/persons holding a power of attorney authorizing to do so. Certified copies of Registration Certificate, Partnership Deed and Power of Attorney will have to be furnished when the tender is to be considered for acceptance.

22. shall be English and 23. advance towards stacked shall be 24. in the

1	Cement	consistency	1-50 T 2- 50 to 100 T 3- 100 to 200 T
		Setting time Comp strength fineness	One per sample per lot or as required
2	Steel	Tensile, yield stress	1- 40 T
		Bend, re bend	1- 20 T
3	Aggregate	Gradation	1/150 m3 for concrete
		Sp. Gravity	2/ Season
		Flakiness	1/150 m3 for concrete
		Impact value	2/ Season
		Abrasion value	2/ Season
		soundness	2/ Season
		Alkali reactivity	2/ Season
		Petrographic examination	2/ Season
4	Water	Chemical analysis	1/ season
5	Sand	Gradation	1/150 m3 for concrete
		Sp. Gravity	2/ Season
		Silt content	2/season
		Alkali reactivity	2/ Season
		Petrographic examination	2/ Season
6	Brick	Compressive strength	One / 50000
		Water absorption	
		Size	
		Efflorescence	
7	Soil Compaction	Field density test	1/1000 Sq-Mt

All rate filled in clearly legibly. No facility material on site granted. Wherever general

specification I.S. are mentioned it shall mean the relevant one.

25. The contractor shall also be liable to bear all municipal taxes for storages of materials etc.

26. The General frequency for testing shall be as follows

27. The charges for consumption of water and electricity will be borne by the contractor.

28. All required testing materials, concrete and steel should be followed as per I.S 456-2000, clause no. 15,16 and 17 for continuous assessment of quality

of work and materials. Care shall be taken for quality, consistency and soundness of work.

29. Curing in masonry should be atleast up to seven days
30. Contractor shall keep on site all necessary construction equipments like Vibrator, Mixer machine, Mortar mixing equipments, Pumps, and other equipments in running conditions and the same shall be tested and checked before starting of work and stand by equipments of above shall be kept ready in case of any faults that may arise during work.
31. The Contractor shall have to locate, line out the building and mark out the grid lines and various components of the buildings during the course of work, as per the drawings of the Architect, and get same approved by the representative of the Architect/ Authority. (also done plot station survey if required charges will be borne by the contractor.)
32. The Contractor shall have to use mixer machine of sufficient capacity, Vibrator of required type, boxes, etc. as required for R.C.C. work.
33. The entire work shall be executed in such a way that the existing site and its surroundings are not disturbed and the environment of the premises is maintained as per guidelines given by the Owner on time to time.
34. **Any State / Central Government Tax, GST, Royalty, labour Cess etc. that may be applicable on the Contractor's, bill amount from time to time shall be deducted from the contractor's interim / running bills at rates applicable at that time**

***All the above conditions are read by me carefully and are binding to me.**

Signature of Agency/contractor

**EXECUTIVE ENGINEER
BUILDING DEPARTMENT
BHAVNAGAR MUNICIPAL CORPORATION
BHAVNAGAR**

Special Conditions of Contract

Labour:

The Contractor shall, unless otherwise provided in the Contract, make his own arrangements for the engagement of all staff and labour, local or other, and for their payment, housing, feeding and transport.

The contractor shall, if required by the Engineer, deliver to the Engineer a return in detail, in such form and at such intervals as the Engineer may prescribe, showing the staff and the numbers of the several classes to labour from time to time employed by the contractor on the Site and such other information as the Engineer may require.

Compliance with Labour Regulations:

During continuance of the contract, the Contractor and his sub contractors shall abide at all times by all existing labour enactments and rules made there under, regulations, notifications and bye laws of the State or Central Government or local authority and any other labour law (including rules), regulations, bye laws that may be passed or notification that may be issued under any labour law in future either by the State or the Central Government or the local authority. Salient features of some of the major labour laws that are applicable to construction industry are given below: The Contractor shall keep the Employer indemnified in case any action is taken against the Employer by the competent authority on account of contravention of any of the provisions of any Act or rules made there under, regulations or notifications including amendments. If the Employer is caused to pay or reimburse, such amounts as may be necessary to cause or observe, or for non observance of the provisions stipulated in the notifications/bye laws/Acts/Rules/Regulations including amendments, if any, on the part of the Contractor, the Engineer/Employer shall have the right to deduct any money due to the Contractor including his amount of performance security. The employer/Engineer shall also have right to recover from the Contractor any sum required or estimated to be required for making good the loss or damage suffered by the Employer.

The employees of the contractor and the subcontractor in no case shall be treated as the employees of the Employer at any point of time.

SALIENT FEATURES OF SOME MAJOR LABOUR LAWS APPLICABLE TO ESTABLISHMENTS ENGAGED IN BUILDING AND OTHER CONSTRUCTION WORK:

- a) Workmen Compensation Act, 1923: The Act provides for compensation in case of injury by accident arising out of and during the course of employment.
- b) Payment of Gratuity Act, 1972: Gratuity is payable to an employee under the Act on satisfaction of certain conditions on separation if an employee has completed 5 years service or more or on death the rate of 15 days wages for every completed year of service. The Act is applicable to all establishments employing 10 or more employees.
- c) Employers P.F. and Miscellaneous Provision Act, 1952: The Act provides for monthly contributions by the employer plus workers @ 10% or 8.33%. The benefits payable under the Act are:
 - (i) Pension or family pension on retirement or death, as the case may be
 - (ii) Deposit linked insurance on the death in harness of the worker.
 - (iii) Payment of P F accumulation on retirement/death etc.
- d) Maternity benefit Act, 1951: The Act provides for leave and some other benefits to Women employees in case of confinement or miscarriage etc.
- e) Contract Labour (Regulation & Abolition) Act 1970: The Act provides for certain welfare measures to be provided by the contractor to contract labour and in case the Contractor fails to provide, the same are required to be provided, by the Principal Employer by Law. The Principal Employer is required to take Certificate of Registration and the Contractor is required to take license from the designated Officer. The Act is applicable to the establishments or Contractor of Principal Employer if they employ 20 or more contract labour.
- f) Minimum Wages Act 1948: The Employer is supposed to pay not less than the minimum wages fixed by appropriate Government as per provision of the Act if the employment is a scheduled employment. Construction of Buildings, Roads, Runways are scheduled employments.
- g) Payment of Wages Act 1936: It lays down as to by what date the wages are to be paid, when it will be paid and what deductions can be made from the wages of the workers.
- h) Equal Remuneration Act 1979: The Act provides for work of equal nature to male and female workers and for not making discrimination against female employees in the matters of transfers, training and promotions etc.
- i) Payment of Bonus Act 1965: The Act is applicable to all establishments employing 20 or more employees. The Act provides for payments of annual bonus subject to a minimum of 8.33% of wages and maximum of 20% of wages to employees drawing Rs. 3500/- per month or less. The bonus to be paid to employees getting Rs. 2500/- per month or above up to Rs. 3500/- per month shall be worked out by taking wages as Rs. 2500/- per month only. The act does not apply to certain establishments. The newly set up establishments are exempted for five years in certain circumstances. Some of the State Government has reduced the employment size from 20 to 10 for the purpose of applicability of the act.

- j) Industrial Disputes Act 1947: The act lays down the machinery and procedure for resolution of Industrial disputes, in what situations a strike or lock-out becomes illegal and what are the requirements for laying off or retrenching the employees or closing down the establishment.
- k) Industrial Employment (Stranding Orders) Act 1946: It is applicable to all establishments employing 100 or more workmen (employment size reduced by some of the States and Central Government to 50). The Act provides for laying down rules governing the conditions of employment by the Employer on matters provided in the Act and get the same certified by the designated Authority.
- l) Trade Unions Act, 1926: The Act lays down the procedure for registration of trade unions of workmen and employers. The trade unions registered under the Act have been given certain immunities from civil and criminal liabilities.
- m) Child Labour (Prohibition & Regulation) Act 1986: The Act prohibits employment of children below 14 years of age in certain occupations and process and provides for regulation of employment of children in all other occupations and process. Employment of Child Labour is prohibited in building and construction industry.
- n) Inter-State Migrant workmen's (Regulation of Employment & Conditions of service) Act 1979: The act is applicable to an establishment which employs 5 or more interstate migrant workmen through an intermediary (who has recruited workmen in one state for employment in the establishment situated in another state). The inter-state migrant workmen, in an establishment to which this Act becomes applicable, are required to be provided certain facilities such as housing, medical aid, traveling expenses from home up to the establishment and back, etc.
- o) The Building and other construction workers (Regulation of Employment and conditions of service) Act 1996 and the Cess Act of 1996 : All the establishments who carry on any building or other construction work and employs 10 or more workers are covered under this Act. All such establishments are required to pay cess at the one of the cost of construction . The Employer of the establishment is required to provide safety measures at the building or construction work and other welfare measures, such as Canteen, First Aid facilities, Ambulance, Housing accommodations for workers near the work place etc. The Employer to whom the Act applies has to obtain a registration certificate from the Registering Officer appointed by the Government. **The employer will deduct one percent of the bill amount as labour cess from each running bill paid to the contractor.**
- p) Factories Act 1948: The Act lays down the procedure for approval of plans before setting up a factory, health and safety provisions, welfare provisions, working hours, annual earned leave and rendering information regarding accidents or dangerous occurrences to designated authorities. It is applicable to premises employing 10 persons or more with aid of power or 20 or more persons without the aid of power engaged in manufacturing process.

3. Sub Contracting

Please add the following as the Contractor shall not be required to obtain any consent from the employer for:

- a) the sub-contracting of any part of the works for which the sub contractor is named in the contract;
- b) the provision of labour; and
- c) the purchase of materials which are in accordance with the standards specified in the Contract.

Beyond this if the contractor proposes sub contracting any part of the work during execution of works, because of some unforeseen circumstances to enable him to complete the work as per term of the contract, the Engineer will consider the following before according approval:

- a. The contractor shall not sub contract the whole of the works
- b. The contractor shall not sub contract any part of the work without prior consent of the Engineer. Any such consent shall not relieve the contractor from any liability or obligations under the contract and he shall be responsible for the acts, defaults and neglects of any sub contractor, his agents or workmen as fully as if they were the acts, defaults or neglects of the contractor, his agents or workmen.
- c. The Engineer should satisfy whether (a) the circumstances warrant such sub contracting, and (b) the sub contractors so proposed for the work possess the experience, qualifications and equipment necessary for the job proposed to be entrusted to them in proportion to the quantum of work to be sub contracted.
 - If payments are proposed to be made directed to that sub –contractor, this should be subject to specific authorization by the prime contractor so that this arrangement does not alter the contractor’s liability or obligations under the contract.

4. PROTECTION OF ENVIRONMENT :

Add the following as GCC Clause 16.2:

The Contractor shall take all reasonable steps to protect the environment on and off the site and to avoid damage or nuisance to persons or to property of the public or others resulting from pollution, noise or other causes arising as a consequence of his methods of operation.

During continuance of the contract, the contractor and his sub contractors shall abide at all times by all existing enactments on environmental protection and rules made there under, regulations, notifications and bye laws of the State or Central Government, or local authorities and any other law, bye-law, regulations that may be passed or notification that may be issued in this respect in future by the State or Central Government or the local authority.

Salient features of some of the major laws that are applicable are given below:

The Water (Prevention and Control of Pollution) Act, 1974m, This provides for the prevention and control of water pollution and the maintaining and restoring of wholesomeness of water.

“Pollution” means such contamination of water or such alteration of the physical chemical or biological properties of water or such discharge of any sewage or trade effluent or of any other liquid, gaseous or solid substance into water (whether directly or indirectly) as may, or is likely to, create a nuisance or render such water harmful or injurious to public health or safety, or to domestic, commercial industrial, agricultural or other legitimate uses, or to the life and health of animals or plants or of aquatic organisms

The Air (prevention and Control of Pollution) Act, 1981. This provides for prevention, control and abatement of air pollution, Air Pollution means the presence in the atmosphere of any air pollutant, which means any solid liquid or gaseous substance (including noise) present in the atmosphere in such concentration as may be or tend to be injurious to human beings or other living creatures or plants or property or environment.

The Environment (Protection) Act, 1986,. This provides for the protection and improvement of environment and for matters connected therewith, and the prevention of hazards to human beings, other living creatures, plants and property. Environment includes water, air and land and the inter relationship which exists among and between water, air and land and the inter relationship which exists among and between water, air and land, and human beings, other living creatures, plants, micro organism and property.

The public liability Insurance Act, 1991. This provides for public liability insurance for the purpose of providing immediate relief to the persons affected by accident occurring while handling hazardous substances and for matters connected herewith or incidental thereto, Hazardous substance means any substance or preparation which is defined as hazardous substance under the Environment (Protection) Act, 1986. and exceeding such quantity as may be specified by notification by the Central Government.

5. Testing of Materials and works.:

- 5.1 All materials before being incorporated in the work shall be inspected and if necessary tested before approval by the Engineer in charge / Consultant. The contractor shall prepare a mock-up of various construction elements (including finishes) involved in the job, thereby setting the performance standards, as per the directions of the Engineer. Any work, on which such materials are used without prior inspection (and when necessary testing) and without approval and written permission of the Engineer, is liable to be considered as defective and not acceptable.
- 5.2 An authorized representative of the Contractor shall remain present at the time when the samples are taken and shall authenticate the facts, if so required. Where the contractor's agent fail to be present as aforesaid, the samples or cores etc. collected by the Engineer or his representative shall be considered to be authentic. The Contractor will, however, be informed of the details of such samples having been collected.
- 5.3 The materials, mixes and cores shall be tested day to day and periodically at the laboratory and the results given thereby shall be considered correct and authentic by the Contractor. The Contractor shall be given opportunity to access all operations and tests that may be carried out as aforesaid so that he may satisfy himself regarding the procedure and methods adopted. It shall then be the Contractor's responsibility to produce on the works, materials and finished items to the standard based on the laboratory designs and tests.

6. Water Supply

The Contractor will have to make his own arrangements for supply of water to his labour camp and for works. All pumping installations, pipe networks and distribution system will have to be provided for and installed by the contractor at his own cost.

The price/rate tendered with this contract shall envisage all cost required for providing adequate potable water for labour and construction.

In the event of water being supplied by the owner, the cost towards distribution shall be borne by the contractor. The owner shall levy charges as per actual costs. The water shall be available only after the contractor provides for a calibrated water meter duly approved by the Engineer-in-charge / Consultant / Architect.

The non-availability of water for any reasons whatsoever shall not constitute any reason for delay or extension of time, extra claims or additional cost incurred for the performance of this contract. The owner bears no liability or responsibility for provision of the same and the arrangement of water is the responsibility of the contractor.

7. Power Supply

Contractor will have to make his own arrangements for supply of temporary power to his labor camp and for works. All installations and distribution system will have to be made and statutory approvals will have to be obtained by the contractor at his own cost.

The price / rate tendered with this contract shall envisage all cost required for providing adequate power for area lighting & construction works.

In the event of power being supplied by the Owner, at the discretion of the owner, charges as per actual cost shall be levied by the owner. The same shall be available only after the contractor provides for a calibrated meter duly approved by the Engineer-in-charge / Consultant/ Architect

The non-availability of power for any reason whatsoever shall not constitute any reason for delay, extension of time ,extra claims or additional cost incurred for the performance of this contract.

The owner bears no liability or responsibility for provision of power and the arrangement of power & generators if required, is the responsibility of the contractor and cost towards the same is deemed to be included in the rates /prices.

All distribution arrangements made by the contractor shall be removed on completion of the work.

The work to be carried out under the contract shall except as otherwise provided in these conditions include all labour, materials, tools, plants, equipments and transport which may be required in preparation of and for and in the full and entire execution and completion of the works. The descriptions given in the schedule of quantities shall unless otherwise stated be held to included waste on materials, carriage and cartage, carrying in, return of empties, hoisting, setting, fitting and fixing in position and all other labours necessary in and for the full and entire execution and completion as aforesaid in accordance with good practice and recognized principles.

The rates quoted by the Contractors should also include for providing all scaffolding, hoists, tackle and other plant, shuttering profiles and apparatus generally required for the proper execution of the work. The contractors shall be provided without extra charges all labour and apparatus required by EXECUTIVE ENGINEER, BUILDING DEPARTMENT, BHAVNAGAR MUNICIPAL CORPORATION for testing and measuring the works and for weighing measuring, providing or testing the efficiency of any portion of the works and shall also at his own cost provide all planking gang ways, etc. necessary for affording access to every part of the works.

The Contractor is expected to quote rate for each item after careful analysis of cost involved for the performance of the completed item considering all specifications and conditions of contract. This will

avoid loss of profit or gain incase of curtailment or change of specification for any item. In case it is noticed that the rates quoted by the tenderer for any item are unusually low. Analysis for such rates will have to be furnished by the tenderer on demand, to satisfy EXECUTIVE ENGINEER, BUILDING DEPARTMENT, BHAVNAGAR MUNICIPAL CORPORATION about the reasonableness of the rates.

The Contractor shall provide at his cost all temporary lighting arrangement required for the works and to enable contractors to complete the works in the specified time.

The contractor shall provide and maintain at his own expense all lights, guards, fencing and watching when and wherever necessary or required by the Engineer – in – charge / Project Architect / PMC for the protection of the works or for the safety and convenience of those employed on the works or the public.

All scaffolding and ladders that may be necessary for taking measurement at site will be provided by the Contractor.

The whole of the works included in any contract shall be executed by the Contractor whom the work entrusted and the Contractor shall not directly or indirectly transfer assign or under let the contract or any part share thereof of any interest therein without the prior written consent of EXECUTIVE ENGINEER, BUILDING DEPARTMENT, BHAVNAGAR MUNICIPAL CORPORATION and no undertakings shall relieve the contractor from the full and entire responsibilities of the contractor or from active superintendence of the works during the progress.

The Contractor shall provide suitable stone with flat tops and build the same in concrete for temporary bench marks. All the pegs for setting out the work and fixing the necessary levels required for the execution thereof shall if desired by the Engineer – in – charge like wise be built in masonry at such places and in such manner as **The** EXECUTIVE ENGINEER, BUILDING DEPARTMENT, BHAVNAGAR MUNICIPAL CORPORATION, BHAVNAGAR may determine.

Particular care must be taken to see that the floors are not overloaded by stacks of materials during construction. It is important that no load comes on the reinforced concrete floors until they are at least 3 weeks old and at no time must the load placed upon them exceed the load for which they are designed.

The Contractor shall cover up and protect from injury from any cause all new work also for supplying all temporary doors, protection to windows and any other requisite protection for the whole of the works executed whether by himself or specified tradesmen and any damage caused must be made good by the contractors at his own expenses to the full satisfaction of Engineer In charge / Project Architect / PMC.

In order to exercise the required degree of constant control over the ingredients of concrete and their proportions the Contractor shall set up and maintain at his own expense a testing laboratory at site manned by a qualified and experienced technician. The Contractor shall provide all apparatus required for testing of concrete and its ingredients and in particular he must provide the following :

- i) Compression testing machine of minimum capacity of 200 tonnes.
- ii) A complete set of standard sieves.
- iii) Sieve vibrator.
- i) Slump cones. (2 Nos.)
- ii) Adequate number of standard moulds. (12 Nos. Min.)
- iii) Weighing balance. (2 Nos.)
- iv) Curing tanks for cubes.

Any other apparatus deemed necessary by EXECUTIVE ENGINEER, BUILDING DEPARTMENT, BHAVNAGAR MUNICIPAL CORPORATION or its Consultants for proper control shall be provided by the Contractor at his own cost.

In addition to previous stipulations, the Contractor shall be represented at site at all times during the tenure of the contract by responsible and qualified engineers approved by **The** EXECUTIVE ENGINEER, BUILDING DEPARTMENT, BHAVNAGAR MUNICIPAL CORPORATION, BHAVNAGAR Such engineer shall form the Contractor's Project Management & Site Supervisory Team. They shall be in constant attendance upon all activities of the work.

The successful tenderer is bound to carry out any item of work up to any deviation in quantities, for the completion of the job.

The rate quoted shall include the cost of supplying colour photographs and digital photograph of 8" x 10" size including negative to employer after completion of work from various angle one set each to Employer and the architect separately in respect of each floor as directed.

Mix design for various strength requirements shall be done through approved Engineering Research Lab, as approved by Engineer in charge / Project Architect / PMC only at Contractor's cost including all testing charges for the same with maintaining cement consumption as per requirement of IS 456.

For controlled concrete work agency is at liberty to carry out the concrete work by ready mix concrete without any extra / additional cost after approval of Engineer in charge.

The work of landscaping, water proofing & sprinkler irrigation system shall be got executed through specialized agency approved by Engineer in charge / Architect / PMC by the general civil contractor.

Page no. 19 clause no11 of General condition of contract of the tender document- Add other taxes such as VAT, Service tax, WCT etc. to this clause.

The contractor must have to submit details of the electrical, landscaping, water proofing work, anti-termite treatment, sprinkler irrigation work & restoration work agencies involved for approval of Engineer in charge / Project Architect / PMC.

**EXECUTIVE ENGINEER
BUILDING DEPARTMENT
BHAVNAGAR MUNICIPAL CORPORATION
BHAVNAGAR**

**PROPOSED DEVELOPMENT OF NIGHT SHELTER AT FULSAR, FOR BHAVNAGAR MUNICIPAL
CORPORATION(B.M.C), BHAVANAGAR**

SECTION- III

**GENERAL TECHNICAL SPECIFICATIONS
FOR BUILDING WORKS.**

ARCHITECTS:-

CHINTAN SACHAPARA

ARCHITECTS

***3, SHAHIBAUG, ABOVE HOME DÉCOR, WAGHA WADI ROAD,
BHAVNAGAR***

PHONE : 9428401640

GENERAL TECHNICAL SPECIFICATIONS FOR BUILDING WORKS

SPECIFICATIONS OF MATERIALS INDEX

Particulars Page No.

General Technical Specifications-General 5

Standard Technical Specifications 7

M. 1. Water 9

M. 2. Lime 9

M. 3. Cement 9

M. 4. White Cement	9
M. 5. Coloured Cement	9
M. 6. Sand	9
M. 7. Stone Dust	10
M. 8. Stone Grit	10
M. 9. Cinder	11
M. 10. Lime Mortar	11
M. 11. Cement Mortar	11
M. 12. Stone coarse aggregates For Nominal Mix Concrete	11
M. 13. Black trap or equivalent Hard Stone Coarse aggregate For design Mix Concrete	12
M. 14. Brick bats aggregates	12
M. 15. Brick	13
M. 16. Stone	13
M. 17. Laterite stone	13
M. 18. Mild Steel Bars	13
M. 19. High yield strength steel deformed bars	13
M. 20. High tensile steel wires	13
M. 21. Mild Steel binding Wires	14
M. 22. Structural Steels	14
M. 23. Galvanised iron sheets	14
M. 23. A G.I. Valleys gutters ridges	14
M. 24. Asbestos cement sheets	14
M. 25. Mangalore pattern roof tiles	14
M. 26. Shuttering	14
M. 27. Expansion Joints, premodulded Filler	15
M. 28. Expansion Joints, copper strips & hold Fasts	15
M. 29. Teak wood	15
M. 29. A Non Teak wood	16
M. 30. Wooden Flush door shutters (Solid Core)	16
M. 31. Aluminium Doors, Windows, Ventilators	17
M. 32. Rolling steel gate	17
M. 33. Collapsible steel gate	17
M. 34. Welded steel Wire Fabric	17
M. 35. Expanded metal sheets	18
M. 36. Mild Steel Wires (Wire gauze Jali)	18
M. 37. Plywood	18
M. 38. Glass	18
M. 39. Acrylic sheets	19
M. 40. Particle board	19
M. 41. Expanded polystyrene or Framed sty roper slabs	19
M. 42. Resign boded Fiber glass	19
M. 43. Fixtures and Fastening	19
M. 44. Paints	21
M. 45. French Polish	21
M. 46. Marble pipes For marble mosaic terrazzo	21
M. 47. Flooring tiles	22
M. 48. Rough Kota stone	23
M. 49. Polished Kota stone	23

4

Particulars Page No.

M. 50. Dholpur Stone slab	23
M. 51. Marble slab	23
M. 52. Granite stone slab	23
M. 53. P.V.C. Flooring	24
M. 54. Facing tiles	24
M. 55. White glazed tiles	24
M. 56. Galvanized iron pipes and fitting	25
M. 57. Bib cooks and stop cock	25
M. 58. Gun metal Wheel valve	25
M. 59. while glazed porcelain wash basin	25
M. 60. European type water closed	25
M. 61. Orrissa type water closet	25
M. 62. Indian type water closet	25
M. 62. A Foot Rests	26
M. 63. Glazed earthenware sink	26

- M. 64. Glazed earthenware lipped type flat back urinal/Corner type urinal 26
- M. 65. Low level enamel Hushing tank 26
- M. 66. Cast Iron flushing cistern 26
- M. 67. Flush cock 26
- M. 68. Cast iron pipes and fitting 26
- M. 69. Nahni Trap 27
- M. 70. Gulley Trap 27
- M. 71. Glazed stoneware pipes and filling 27
- M. 72. Wall peg rail 27
- M. 73. G. 1. Water spout 27
- M. 74. Asbestos cement pipe (A.C. pipe) 28
- M. 75. Crydon ball valve 28
- M. 76. Bitumen felt for water proofing and damp proofing 28
- M. 77. Selected Earth 28
- M. 78. barbed-Wire 28

DETAILED SPECIFICATIONS

- Section – 4 Excavation 29
- Section – 5 Plain & R.C.C. Work 37
- Section – 6 Masonry work 50
- Section – 7 Rubble masonry work 57
- Section – 9 Centering and form work 63
- Section – 10 Wood Work, Doors, windows 68
- Section – 11 Steel shutters, Windows, Ventilators 78
- Section – 12 Labour for fixing fixtures and fastenings 82
- Section – 13 Glazing 85
- Section – 14 Paving & Floor Finishes 88
- Section – 15 Roof Covering 104
- Section – 16 Ceiling & Lining 116
- Section - 17 Plastering and Painting 119
- Section – 18 White washing and Distempering 125
- Section – 19 Painting and Polishing 138
- Section – 20 Demolition and Disentangling 147
- Section – 21 Repairs to Buildings 152
- Section – 22 Miscellaneous Buildings items 153
- Section – 23 Water Supply, Plumbing and Sanitary fittings 160
- Section – 24 Drainage & Sewerage 175
- Annexure Equivalent plain area for uneven surface for painting 186
- Annexure Schedule of Fixtures & Fastenings for doors, windows, ventilators, Wardrobes and cupboards 188

5

GENERAL TECHNICAL SPECIFICATIONS FOR BUILDING WORKS

GENERAL:

1. In the specifications "as directed" / "approved" shall be taken to mean "as directed" / "approved by the Engineer-in-Charge".

2. Wherever a reference to any Indian Standard appears in the specifications, it shall be taken to mean as a reference to the latest edition of the same in force on the date of agreement.
3. In "Mode of Measurement" in the specifications wherever a dispute arises in the absence of specific mention of a particular point of aspect the provisions on these particular points, or aspects in the relevant Indian Standards shall be referred to
4. All measurements and computations, unless otherwise specified, shall be carried out nearest to the following limits:
 - (i) Length, width and depth (height) 0.01 meter
 - (ii) Areas 0.01 Sq.Mt.
 - (iii) Cubic Contents 0.01 Cu.Mt.In recording dimensions of work the sequence of length, width and height (depth) or thickness shall be followed.
5. The distance which constitutes lead shall be determined along the shortest practical route and note necessarily the route actually taken The decision of the Engineer-in-charge in this regard shall be taken as final.
6. Where no lead is specific, it shall mean "all leads"
7. Lift shall be measured from plinth level.
8. Up to "floor two level" means actual height of floor (Maxi 4 M) up to 3 Mt. above plinth level.
9. Definite particulars covered in the items of work, though not mentioned or elucidated in its specifications shall be deemed to be included therein.
10. Reference to specifications of materials as made in the detailed specification of the items of works is in the form of a designation containing them under the specification of the material and prefix 'M' e.g. 'M-5',
11. Approval to the samples of various materials given by the Engineer-in-charge shall not absolve the contractor from the responsibility of replacing defective material brought on site or materials used in the work found defective at a later date. The contractor shall have no claim to any payment or compensation whatsoever on account of any such materials being rejected by the Engineer-in-charge.
12. The contract rate of the item of work shall be for the work completed in all aspects.
13. No collection of materials shall be made before it is got approved from the Engineer-in-charge.
14. Collection of approved materials shall be done at site of work in a systematic manner. Materials shall be stored in such a manner as to prevent damage, deterioration or intrusion of foreign matter and to ensure the preservation of their quality and fitness for the work
15. Materials, if and when rejected by the Engineer-in-charge, shall be immediately removed from the site of work.
16. No materials shall be stored prior to, during and after execution of a structure in such a way as to cause or lead to damage or overloading of the various components of the structure.
17. All works shall be carried out in a workmanlike manner as per the best techniques for the particular item.
18. All tools, templates, machinery and equipment for correct execution of the work as well as for checking lines, levels, alignment of the works during execution shall be kept in sufficient numbers and in good working condition on the site of the work.
19. The mode, procedure and manner of execution shall be such that it does not cause damage or over-loading of the various components of the structure during execution or after completion of the structure.
20. Special modes of construction not adopted in general Engineering practice if proposed to be adopted by the Contractor, shall be considered only if the contractor provides satisfactory evidence that such special mode
6
Of construction is safe, sound and helps in speedy construction and Completion of work to the required strength and quality. Acceptance of the same by the Engineer-in-Charge shall not, however absolve the contractor of the responsibility of any adverse effects and consequences of adopting the same in the course of execution of completion of the work.
21. All installations pertaining to water supply and fixtures there of as well as drainage lines and sanitary fittings shall be deemed to be completed only after giving satisfactory tests by the contractor.
22. The contractor shall be responsible for observing the rules and regulations imposed under the "Minor Minerals Act", and such of the laws and rules prescribed by Government from time to time.
23. All necessary safety measures and precautions (including those laid down in the various relevant Indian Standards) shall be taken to ensure the safety of men. Materials and machinery on the works as also of the work itself.
24. The testing charges of all materials shall be borne by the Contractor.
25. Approval to any of the executed items for the work does not in any way relieve the contractor of his responsibility for the correctness, soundness and strength of the structure as per the drawings and specifications
7

GENERAL

STANDARD TECHNICAL SPECIFICATIONS

Sr. No. of the
item in the
Schedule 'B' of
tender
Sr. No. of
applicable
Specification

Sr. No. of the
item in the
Schedule 'B' of
tender

Sr. No. of
applicable
Specification

Sr. No. of the
item in the
Schedule 'B' of
tender

Sr. No. of
applicable
specification

1 25 49

2 26 50

3 27 51

4 28 52

5 29 53

6 30 54

7 31 55

8 32 56

9 33 57

10 34 58

11 35 59

12 36 60

13 37 61

14 38 62

15 39 63

16 40 64

17 41 65

18 42 66

19 43 67

20 44 68

21 45 69

22 46 70

23 47 71

24 48 72

8

Sr. No. of the
item in the
Schedule 'B' of
tender

Sr. No. of
applicable
Specification

Sr. No. of the
item in the
Schedule 'B' of
tender

Sr. No. of
applicable
Specification

Sr. No. of the
item in the
Schedule 'B' of
tender

Sr. No. of
applicable
specification

73 99 125

74 100 126

75 101 127

76 102 128

77 103 129

78 104 130

79 105 131

80 106 132
81 107 133
82 108 134
83 109 135
84 110 136
85 111 137
86 112 138
87 113 139
88 114 140
89 115 141
90 116 142
91 117 143
92 118 144
93 119 145
94 120 146
95 121 147
96 122 148
97 123 149
98 124 150
9

SPECIFICATIONS OF MATERIALS

M-1. Water

1.1. Water shall not be salty brackish and shall be clean, reasonably clear and free objectionable quantities of silt and traces of oil and injurious alkalis, salts, organic matter and other deleterious material which will either weaken the mortar of concrete or cause efflorescence or attack the steel in R.C.C. Container for transport, storage and handling of water shall be clean. Water shall conform to the standard specified in I.S. 456-1978.

1.2. If required by the Engineer-in-Charge it shall be tested by comparison with distilled water Comparison shall be made by means of standard cement tests for soundness time of setting and mortar strength as specified in I.S. 269-1976. Any indication of unsoundness charge in time of setting by 30 minutes or more or decrease of more than 10 per cent in strength, of mortar prepared with water sample when compared with the results obtained with mortar prepared with distilled water shall be sufficient cause for rejection of water under test.

1.3. Water for curing mortar, concrete or masonry should not be too acidic or too alkaline .

It shall be free of elements which significantly affect the hydration reaction or otherwise interfere with the hardening of mortar or concrete during curing or those which produce objectionable stains or other unsightly deposits on concrete or mortar surfaces

1.4. Hard and bitter water shall not be used for curing

1.5. Potable water will generally found suitable for curing mortar or concrete.

M-2. Lime

2.1. Lime shall be hydraulic lime as per I.S. 712-1973 Necessary tests shall be carried out as per I.S. 6932 (Parts I to X) 1973

2.2. The following field tests for limes are to be earned out:

(1) A very rough idea can be formed about the type of lime by its visual examination i.e. fat lime bears pure white colour, lime in form of porous lumps of dirty white colour indicates quick lime, and solid lumps are the un burnt lime stone.

(2) Acid tests for determining the carbonate content in lime Excessive amount of impurities and rough determination of class of lime.

2.3. Storage shall comply with J.S. 712-1973 The slaked lime, if stored, shall be kept in a weather proof and dampproof shed with impervious floor and sides to protect it against rain, moisture, weather and extraneous materials mixing with it. All lime that has been damaged" in any way shall be rejected and all rejected materials shall be removed from site of work.

2.4. Field testing shall be done according to I.S 1624-1974 to show the acceptability of materials.

M-3. Cement

3.1. Cement shall be ordinary Portland slag cement as per I.S.269-1976 or Portland slag cement as per I.S. 455-1976

M-4. White Cement

4.1. The white cement shall conform to I S. 8042-E-1978.,

M-5. Coloured Cement

5.1. Coloured cement shall be with white of grey Portland cement as specified in the item of the work.

5.2. The pigments used for coloured cement shall be of approved quality and shall not exceed 10% of cement used in the mix. The mixture of pigment add cement shall be properly ground to have a uniform colour and shade. The pigments shall have such properties to provide for durability underexposure to sunlight and weather.

5.3. The pigment shall have the property such that it is neither affected by the cement nor detrimental to it

M-6 Sand

6.1. Sand shall be natural sand, clean, well graded hard strong, durable and gritty particles free from injurious amounts of dust, clay kankar nodules, soft or flaky particles shale, alkali salts organic matter, loam, mica or other deleterious substances and shall be got approved from the Engineer-in-Charge. The sand shall not contain more contain more than 8 percent of silt as determined by field test, if necessary the sand shall

10

be washed to make it clean.

6.2. Coarse Sand : The fineness modulus of coarse sand shall not be less than 2.5 and shall not exceed

3.0. The sieve analysis of coarse shall be as under.

I.S. Designation Sieve passing sieve Percentage by weight

Designation

I.S. Sieve Percentage by

weight passing Sieve

4.75 mm

2.36 mm

1.18 mm

100

90 to 100

70 to 100

600 micron

300 micron

150 micron

30 - 100

50 - 70

0 - 50

6.3. Fine Sand :

The fineness modulus shall not exceed 1.0 The sieve analysis of fine sand shall be as under.

I.S. Designation Percentage by weight

Sieve passing

I.S. Designation Percentage by weight

Sieve passing

4.75 mm

2.36 mm

1.18 mm

100

100

75 to 100

600 micron

300 micron

150 micron

40 - 85

5 - 50

0 - 10

M-7. Stone Dust

7.1. This shall be obtained from crushing hard black trap or equivalent. It shall not contain more than 8% of silt as determined by field test will measuring cylinder. The method of determining silt contents by fields test is given as under :

7.2. A sample of stone dust to be tested shall be placed without drying in 200 mm. measuring cylinder. The quantity of the sample shall be such that it fills the cylinder up to 100 mm. mark. The clean water shall be added up to 150 mm. mark. The mixture shall be stirred vigorously and the content allowed to settle for 3 hours.

7.3. The height of silt, visible as settled layer above the stone dust shall be expressed as percentage of the height of the stone dust below The stone dust containing more than 8% silt shall be washed so as to bring the content within the allowable limit.

7.4. The fineness modulus of stone dust shall not be less than 1.80

M-8. Stone Grit

8.1. Grit shall consist of crushed or broken stone and be hard, strong, dense, durable, clean of proper gradation and free from skin or coating likely to prevent proper adhesion of mortar Grit shall generally be cubical in shape and as far as possible flakey elongated pieces shall be avoided. It shall generally comply with the provisions of I.S. 383-1970. Unless special stone of particular quarries is mentioned grit shall be obtained from the best black trap or equivalent hard stone as approved by the Engineer-in-charge. The grit shall have no deleterious with cement.

8.2. The grit shall conform to the following gradation as per sieve analysis :

I.S. sieve designation Percentage by weight I.S. Sieve designation Percentage by weight

12,50 mm 100 % 4.75 mm 0-20%

1000 mm 85 - 100% 2.36 mm 0-25%

8.3. The crushing strength of grit will be such as to allow the concrete in which it used to build-up the specified strength of concrete

8.4. The necessary tests for grit shall be carried out as per the requirements of I.S.2386- (parts-I to VIII) 1963-as per instructions of the Engineer-in-charge. The necessity of test will be decided by the Engineer-in-charge.

11

M-9. Cinder

9.1. Cinder is will burnt furnace residue which has been fused or sintered into lumps of varying sizes

9.2. Cinder aggregates shall be well burnt furnace residue obtained from furnace using coal fuel only It shall be sound clean and free from clay dirt, ash or other deleterious matter

9.3. The average grading for cinder aggregates shall be as mentioned below .

I.S. Designation Percentage by weight Sieve

passing

I.S. Designation Percentage by weight

Sieve passing

20 mm

10 mm

100

86

4.75 mm

2.36 mm

70

52

M-10. Lime Mortar

10.1. Lime : Lime shall conform to specification M-2, Water : Water shall conform to specification M-1 and Sand: Sand shall conform to specification M-6

10.2. Proportion of Mix:

10.2.1. mortar shall consist of such proportions of slaked lime and sand as may be specified in item The slaked lime and sand shall be measured by volume

10.3. Preparation of mortar;

10.3.1. Lime mortar shall be prepared by wet process as per I S 1625-1971 .Power driven mill shall be used for preparation of lime mortar. The slaked lime shall be placed in the mill in an even layer and ground for 180 revolutions with a sufficient water. Water shall be added as required during grinding (care being taken not to add more water) that will bring the mixed material to a consistency of stiff paste. Thoroughly wetted sand shall then be added evenly and the mixture ground for another 180 revolutions.

10.4. Storage:

10.4.1. Mortar shall always be kept damp, protected from sun and ram till used up, covering it by tarpaulin or open sheds.

10.5. Use:

10.5.1. All mortar shall be used as soon as possible after grinding. It should be used on the day on which it prepared, But in no case mortar made earlier than 36 hours shall be permitted for use.

M-11. Cement Mortar

11.1. Water shall conform to specification M-1, Cement : Cement shall conform to specifications M-3 and Sand : Sand shall conform to M-6

11.2. Proportion of Mix

11.2.1. Cement and sand shall be mixed to specified proportion, sand being measured by measuring boxes, the proportion of cement will be by volume on the basis of 50 Kg/Bag of cement being equal to 0.0342 Cu.m. The mortar may be hand mixed or machine mixed as directed.

11.3. Proportion of Mortar :

11.3.1. In hand mixed mortar, cement and sand in the specified proportions shall be thoroughly mixed dry on a clean impervious platform by turning over at least 3 times or more till a homogeneous mixture of uniform colour is obtained. Mixing platform shall be so arranged that no deleterious extraneous material shall get mixed with mortar or mortar shall flow out. While mixing, the water shall be gradually added and thoroughly mixed to form a stiff plastic mass of uniform colour so that each particle of sand shall be completely covered with a film of wet cement. The water cement ratio shall be adopted as directed

11.3.2. The mortar so prepared shall be used within 30 minutes of adding water. Only such quantity of mortar shall be prepared as can be used within 30 minutes

M-12. Stone Coarse Aggregate For Nominal Mix Concrete

12.1. coarse aggregate shall be of machine crushed stone of black trap or equivalent and be hard strong, dense, durable, clean and free from skin and coating likely to prevent proper adhesion of mortar

12.2. The aggregate shall generally be cubical in shape Unless special stones of particular quarries are mentioned aggregates shall be machine crushed from the best black trap or equivalent hard stone as approved Aggregate shall have no deleterious reaction with cement. The size of the coarse aggregate for plain cement and ordinary reinforced cement concrete shall generally be as per the table given below.

12

However, in case of reinforced cement concrete the maximum limit may be restricted to 6 mm. less than the minimum lateral clear distance between bars or 6- mm. less than the cover whichever is smaller.

I S. Sieve

Designation

Percentage passing for single

Sized aggregates of Nominal size

I S. Sieve

Designation

Percentage passing for single

Sized aggregates of Nominal size

40 mm 20 mm 16 mm 40 mm 20 mm 16 mm

80 mm - - - 12.5 mm - - -

63 mm 100 - - 10 mm 05 0.20 0.30
40 mm 85-100 100 - 4.75 mm - 0.5 0.5
20 mm 0.20 85-100 100 ' 2.35 mm - - -
16 mm 85-100

Note : This percentage may be varied some what by the Engineer-in-charge when considered necessary for obtaining better density and strength of concrete.

12.3. The grading test shall be taken in the beginning and at the change of source of materials. The necessary tests, indicated in I.S. 383-1970 and 456-1978 shall have to be carried out to ensure the acceptability. The aggregates shall be stored separately and handled in such a manner as to prevent the intermixing of different aggregates. If the aggregates are covered with dust, they shall be washed with water to make them clean. .

M-13. Black Trap or Equivalent Hard Stone Coarse

13.1. Aggregate For Design Mix Concrete . Coarse aggregate shall be of machine crushed stone of black trap or equivalent hard stone and be hard, strong, dense, durable, clean and free from skin and coating likely to prevent proper adhesion of mortar.

13.2. The aggregates shall generally be cubical in shape. Unless special stones of particular quarries are mentioned, aggregates shall be machine crushed, from the best, black trap or equivalent hard stones as approved, Aggregate shall have no deleterious with cement

13.3. The necessary tests indicated in I.S. 383-1970 and I.S.456-1978 shall have to be carried out to ensure the acceptability of the material.

13.4. If aggregate is covered with dust it shall be washed with water to make it clean.

M-14. Brick Bats Aggregate

14.1. Brick bat aggregate shall be broken from well burnt or slightly over burnt and dense bricks. It shall be homogeneous in texture, roughly cubical in shape, clean and free from dirt of any other foreign material. The brick bats shall be of 40 mm - 50 mm. size unless otherwise specified in the item The under burnt or over burnt brick bats shall not be allowed.

14.2. The brick bats shall be measured by suitable boxes or as directed.

M-15. Bricks

15.1. The bricks shall be hand or machine molded and made from suitable soils and kiln burnt. They shall be free from cracks and flaws and nodules of free lime they shall have smooth rectangular faces with sharp corners and shall be of uniform colour.

The bricks shall be moulded with a frog of 100 mm. x 40 mm. and 10 mm. to 20 mm. deep on one of its flat sides. The bricks shall not break when thrown on the ground from a height of 600 mm.

15.2. The size of modular bricks shall be 190 mm.x 90 mm.x 90 mm.

15.3. The size of the conventional bricks shall be as under :

(9" x 4.3/8" x 2,3/4") 225 x 110 x 75 mm.

15.4. Only bricks of one standard size shall be used on one work. The following tolerances shall be permitted in the conventional size adopted in a particular work.

Length + 1/8" (3.0 mm.) Width ± 1/16" (1.50 mm.) Height + 1/16" (1.50 mm.)

15.5. The crushing strength of the bricks shall not be less than 35 Kg/Sq. Cm. The average water absorption shall not be more than 20 percent by weight Necessary tests for crushing strength and water

13

absorption etc. shall be carried out as per I.S. 3495 (Part-I to IV) - 1976

M-16. Stone

16.1. The stone shall be of the specified variety such as Granite/Trap Stone/ Quartzite or any other type of good hard stones. The stones shall be only from the approved quarry and shall be hard sound, durable and free from defects like cavities, cracks, sand holes, flaws injurious veins, patches of loose or soft materials etc., and weathered portions and other structural defects Or imperfections tending to affect their soundness and strength. The stone with round surface shall not be used. The percentage of water absorption shall not be more than 5% of dry weight. When tested in accordance with I.S. 1124-1974. The minimum crushing strength of stone shall be 200 Kg/.Sq. Cm. unless otherwise, specified

16.2. The samples of the stone to be used shall be got approved before the work is started

16.3. The Khanki facing stone shall be dressed by chisel as specified in the item for khanki facing in required shape and size. The face of the stone shall be so dressed that the bushing on the exposed face shall not project by more than 40 mm. from the general wall surface and on face to be plastered it shall not project by more than 19 mm. nor shall it have depressions more than 10 mm. from the average wall surface

M-17. Laterite Stone

17.1. Laterite stone shall be obtained from the approved quarry it shall be compacted in texture sound, durable and free from soft patch. It shall have minimum crushing strength of 100 Kg/Sq. Cm. in its dry condition. It shall not absorb water more than 20% of its own weight, when immersed for 24 hours in water. After quarrying, the stone shall be allowed to weather for some time before using in work.

17.2. The stone shall be dressed into regular rectangular blocks so that all faces are free from waviness and unevenness, and the edges true and square

17.3. Those types of stone in which white clay occurs should not be used

17.4. Special corner stones shall be provided where so directed.

M-18. Mild Steel Bars

18.1. Mild steel bars reinforcement for R.C.C. work shall conform to I.S. 432 (Part -II) 1966 and shall be of tested quality. It shall also comply with relevant part of I.S. 456-1978.

18.2. All the reinforcement shall be clean and free from dirt, paint, grease, mill scale or loose or thick rust at the time of placing

18.3. For the purpose of payment, the bar shall be measured correct up to 10 mm. length and weight payable worked out at the rate specified below :

1. 6 mm 0.22 Kg/Rmt. 8. 20 mm. 2.47 Kg/Rmt
2. 8 mm. 0.39 Kg/Rmt. 9. 22 mm. 2.98 Kg/Rmt.
3. 10 mm. 0.62 Kg/Rmt. 10. 25 mm. 3.85 Kg/Rmt.
4. 12 mm. 0.89 Kg/Rmt. 11. 28 mm. 4.83 Kg/Rmt.
5. 14 mm 1.21 Kg/Rmt. 12. 32 mm. 6.31 Kg/Rmt.
6. 16 mm 1.58 Kg/Rmt 13. 36 mm. 7.99 Kg/Rmt. *
7. 18 mm. 2.00 Kg/Rmt. 14. 40 mm. 9.86 Kg/Rmt.

M-19. High Yield Strength Steel Deformed Bars

19.1. High yield strength steel deformed bars shall be either cold twisted other rolled and shall conform to I.S. 1786-1966 and I.S. 1139-1966 respectively.

19.2. Other provisions and requirements shall conform to specification No. M-18 for Mild Steel Bars.

M-20. High Tensile Steel Wires

20.1. The high tensile wires for use in pre stressed concrete work shall conform to I.S.2090-1962.

20.2. The tensile strength of the high tensile steel bars shall be as specified in the item. In absence of the given strength the minimum strength shall be taken as per Para 6-1 of the I.S. 1785-1962. Testing shall be done as per I.S. requirements.

20.3. The high tensile steel shall be free from loose mill scale, rust, oil, grease, or any other harmful matter. Cleaning of steel bars may be carried out by immersion in solvent solution, wire brushing or passing through
14

a pressure box containing Carborundum.

20.4. The high tensile wire shall be obtained from manufacturers. in coils having diameter not less than 350 times the diameter of wire itself so that wire springs back straight on being uncoiled .

M-21. Mild Steel Binding Wire

21.1. The mild steel wire shall be of 1.63 mm. or 1.22 mm. (16 to 18 gauge) diameter and shall conform to I.S. 280-1972.

21.2. The use of black wire will be permitted for binding reinforcement bars. It shall be free from rust oil paint, grease loose mill scale or any other undesirable coating which may prevent adhesion of cement mortar

M-22. Structural Steel

22.1. All structural Steel! shall conform to I S. 226-1985: The steel shall be free from the defects mentioned in I.S 226-1975 and shall have a smooth finish. The material shall be free from loose mill scale, rust pits or other defects affecting the strength and durability. River bars shall conform to I.S. 1148-1973.

22.2. When the steel is supplied by the Contractor test certificate of the manufacturers shall be obtained according to I.S. 226-1975 and other relevant Indian Standards.

M-23. Galvanised Iron Sheets

23.1. The galvanised iron sheets shall be plain or corrugated sheets of gauges as specified in item The G.I. Sheets shall conform to I.S.277-1977. The sheets shall be undamaged in carnage and handling either by rubbing off of zinc coating or otherwise. They shall have clean and bright surface and shall be free from dents, bends, holes, rust or white powdery deposit.

23.2. The length and width of G.I. sheets shall be as directed as per site condition.

M-23.A :G.I. Valleys gutter, ridges

23.A.1. The G.I. ridges and hips shall be of plain galvanised sheets Class - 3 of the thickness as specified in item. These shall be 600 mm. in width and properly bent up to shape without damage to the sheets in process of bending.

23.A.2. Valleys gutters and flashings shall also be of galvanised sheet of thickness as specified in item Valleys Shall be 900 mm. wide overall and flashing shall be 380 mm. wide overall They shall be bent to the required shape without damage to the sheet in the process of bending.

M-24. Asbestos Cement Sheets

24.1. Asbestos cement sheets plain, corrugated of semi-corrugated shall conform to I.S.459-1970 The thickness of the sheets shall be as specified in the item. The sheets shall be free from all defects such as cracks, holes, deformities chipped edges or otherwise damaged.

24.2. Ridges & Hips :

24.2.1. Ridges and hips shall be of same thickness as that of A.C. sheets. The types, of ridges shall be suitable for the type of sheets and location.

24.2.2. Other accessories to be used in roof such as flashing pieces eaves filler pieces, valley gutters, north light, and ventilator curves, barge boards etc, shall be of standard manufacture and shall be suitable for the type of sheets and location.

M-25. Manglore Pattern Roof Tiles

25.1. The mangalore pattern tiles shall conform to I S 654-1972 for Class AA or Class A type as specified in item. Samples of the tiles to be provided shall be got approved from the Engineer-in-charge. Necessary tests shall be carried out as directed.

M-26. Shuttering

26.1. The shuttering shall be either of wooden planking of 30 mm. minimum thickness with or without steel lining or of steel plates stiffened by steel angles The shuttering shall be supported on battens and beams and props of vertical bullies properly cross braced together so as to make the centering rigid. In places of bullies props, brick pillar of

adequate section built in mud mortar may be used

26.2. The form work shall be sufficiently strong and shall have camber so that it assumes correct shape after deposition of the concrete and shall be able to resist forces caused by vibration of live load of men working over it and other incidental loads associated with it. The shuttering shall have smooth and even surface and its joints shall permit leakage of cement grout

26.3. If at any stage of work during or after placing concrete in the structure, the form work sags or bulges out beyond the required shape of the structure, the concrete shall be removed and work redone with fresh concrete and adequately rigid form work. The complete form work shall be got inspected by and got approved from the Engineer-in-charge,

before the reinforcement bars are placed in position

26.4. The props shall consist of bulbies having 100 mm minimum diameter measured at mid length and 80 mm. at thin end shall be placed as per design requirement. These shall rest squarely on wooden sole plates 40 mm. thick and minimum bearing area of 0-10 sq m laid on sufficiently hard base.

26.5. Double wedges shall further be provided between the sole plate and the wooden props so as to facilitate tightening and easing of shuttering without jerking the concrete

26.6. The timber used in shuttering shall not be so dry as to absorb water from concrete and swell or bulge nor so green or wet as to shrink after erection. The timber shall be properly sawn and planed on the sides and the surface coming in contact with concrete. Wooden form work with metal sheet lining or steel plates stiffened by steel angles shall be permitted

26.7. As far as practicable, clamps shall be used to hold the forms together and use of nails and spikes avoided.

26.8. The surface of timber shuttering that would come in contact with concrete shall be well wetted and coated with soap solution before the concreting is done. Alternatively coat of raw linseed oil or oil of approved manufacture may be applied in place of soap solution. In case of steel shuttering either soap solution or raw linseed oil shall be applied after thoroughly cleaning the surface. Under no circumstances black or burnt oil shall be permitted.

26.9. The shuttering for beams and slabs shall have camber of 4 mm per meter (1 in 250) or as directed by the Engineer-in-charge so as to offset the subsequent deflection. For cantilevers, the camber at free end shall be 1/50 of the projected length or as directed by the Engineer-in-charge.

M- 27. Expansion Joints - Permoulded filler

27.1. The item provides for expansion joints in R.C.C. frame structures for internal joints, as well as exposed joints, with the use of premoulded bituminous joint filler.

27.2. Premoulded bituminous joints filler i.e. performed strip of expansion joints filler shall not get deformed, or broken by twisting bending or other handling when exposed to atmospheric condition. Pieces of joints filler that have been damaged shall be rejected

27.3. Thickness of the per-moulded joints filler shall be 25 mm. unless otherwise specified.

27.4. Premoulded bituminous joints filler shall conform to I S 1838-1961

M-28. Expansion joints-Copper strips & hold .fasts

28.1. The item provide for expansion joints in R.C.C. frame structure for internal joints, as well as exposed joints, with the use of premoulded bituminous joints filler.

28.2. Copper sheet shall be of 1.25 mm. width and or 1 25 mm. width and the " U " shape in the middle. Copper strip shall have holdfast of 3 m.m diameter copper rod fixed to the plate soldered on strip at intervals of about 30 cm or as shown in the drawing or as directed. The width of each flange (horizontal side) of the copper plate to be embedded in the concrete work shall be 25 mm depth of "U" to be provided in the expansion joint, in the copper plate shall be of 25 mm.

M-29. Teak wood

29.1. The teak wood shall be of good quality as required for the item to be executed. When the kind of wood is not specifically mentioned, good Indian teak wood as approved shall be used.

29.2. Teak wood shall generally be free from large, loose dead or cluster knots, flaws, shakes, warps, twists, bends or any other defects. It shall generally be uniform in substance and of straight fibers as far as possible. It shall be free from rot decay, harmful fungi and other defects of harmful nature which will affect the strength, durability or its usefulness for the purpose for which it is required. The colour shall be uniform as far as possible. Any effort like painting using any adhesive materials made to hide the defects shall render the pieces liable to rejection by the Engineer-in-charge.

29.3. All scantlings, planks etc., shall be sawn in straight lines and planes in the direction of grains and of uniform thickness.

16

29.4. The tolerances-in the dimensions shall be allowed at the rate of 1.5 mm. per face to be planed.

29.5. First class teak wood

29.5.1. First class teak wood shall have no individual hard and-sound knots, more than 6 sq. cm. in size and the aggregate area of such knots shall not be more than 1% of area of piece, The timber shall be closed grained.

29.6. Second Class Teak Wood:

29.6.1. No individual hard and sound knots shall be more than 15 sq. cms. in size and aggregates area of such knots shall be not exceed 2% of the area of piece.

M-29. A Non-teak wood:

The non-teak wood shall be chemically treated, seasoned as per I.S. Specifications and of good quality. The type of wood shall be got approved before collecting the same on site. Fabrication of wooden members shall be started only after approval.

For this purpose wood of Bio, Kalai, Sires. Saded, Behda, Jamun, Sisoo will be used for door where as only Kalai.

Sires, Halda. Kalam etc. will be permitted for shutters after proper seasoning and chemical treatment.

The non-teak wood shall be free from large loose dead of cluster knots, flows, shakes, warps, bends or any other defects, It shall be uniform in substance and of straight fibers as far as possible It shall be free fro rots, decay, harmful fungi and other defects of nature which will effect the strength, durability or its usefulness for the purpose for which it is required. The colour of wood shall be uniform as far as possible. The scantlings planks etc. shall be saw in straight lines and planes in the direction of grain and of uniform thickness. The department will use the Agency to produce certificate from Forest Department in event of dispute and the decision of the Department shall be final and binding to the contractor. The tolerance in the dimension shall be allowed at 1.5 mm. per face to be planed.

M-30. Wooden flush door shutters (solid core)

30.1. The solid core type flush door shutters shall be of decorative or non-decorative type as specified in the drawing. The size and thickness of the shutter shall be as specified in drawings or as directed. The timber species for core shall be used as per I.S.2202 (part -I) 1980. The timber shall be free from decay and insect attack Knots and knot holes less than half the width of cross-section of the members in which they occur may be permitted. Pitch pockets, pitch streaks and harmless pin holes shall be permissible except in the exposed edges of the core members. The commercial plywood, cross-bands shall conform to I.S. 303-1275

30.2. The face-panel of the shutters shall be formed by gluing by the hot press process on both faces of the core with either plywood or cross-bands and face veneers. The hopping, rebating, opening of glazing, venation etc., shall be provided if specified in the drawing.

30.3. All edges of the door shutters shall be square. The shutters shall be free from twist or warp in its plane. Both faces of the shutters shall be sand papered to smooth even texture.

30.4. The shutters shall be tested for-

(1) End immersion test: The test shall be carried out as per I.S.2202 (part-1) 1980 There shall be no delamination at the end of the test.

(2) Knife Test : The face panel when tested in accordance with I.S 1659-1979 shall pass the test.

(3) Glue adhesion test : The flush door shall be tested for glue adhesive test in accordance with I S 2202 (part -I) 1980. The shutters shall be considered to have passed the test, if no delamination occurs in the glue lines in the plywood and if no single determination more than 80 mm in length and more than 3 mm in depth has occurred in the assembly glue lines between the plywood face and the style and rail. Delamination at the corner shall be measured continuously around the corner Delamination at the knots, knot hole and other permissible wood defectects shall not be considered in assessing the sample.

30.5. The tolerance in size of scud core type flush door shall-be as under :
In Nominal thickness \pm 1.2 mm. In Nominal height \pm 3m

30.6. The thickness of the shutter shall be uniform throughout with a permissible variation of not more than 0.8 mm when measured at any points.

17

M-31. Aluminum doors, windows, ventilators

31.1. Aluminum alloy used in the manufacture of extruded window sections shall conform to I.S. designation HEAWP of I.S. 733-1975 and also to I S. Designation WVG-WP of I.S 1285-1975 The section shall be as specified in the drawing and design. The fabrication shall be done as directed

31.2. The hinges shall be cast or extruded aluminum hinges of same type as in window but of larger size.

31.3. The hinges shall normally be of 50 mm. projecting type. Non-projecting type of hinges may also be used if directed. The handles of door shall be of specified design A suitable lock for the door Operable either from outside or inside shall be provided. In double shutter door, the first closing shutter shall have concealed aluminum alloy bolt at top and bottom.

M-32. Rolling Shutters

32.1. The rolling shutters shall conform to I.S.6248-1979 Rolling shutters shall be supplied of specified type with accessories. The size of the rolling shutters shall be specified in the drawings. The shutters shall be specified in the drawings. The shutters shall be constructed with interlocking lath sections formed from cold rolled steel strips not less than 0.9 mm. thick and 80 mm. wide for shutters up to 3.5 m. width not less than 1.25 mm. thick and 80 mm wide for shutters 3.5 m. in width and above unless otherwise specified.

32.2. Guide channels shall be of mild steel deep channel section and of rolled pressed or built up (fabricated) joint less construction The thickness of sheet used shall not be less than 3 15 mm.

32.3. Hood covers shall be made of M.S. Sheets not less than 0.90 mm. thick. For shutters having width 3.5 Meter and above, the thickness of M.S. sheet for the hood cover shall be not less than 1 25 mm.

32.4. The spring shall be of best quality and shall be manufactured from tested high tensile spring steel wire of strip of adequate strength to balance the shutters in all position. The spring pipe shaft etc. shall be supported on strong M S of malleable C I. brackets. The brackets shall be fixed on or under the lintel as specified with-raw! plugs and screws bolts etc.

32.5. The rolling shutters shall be of self rolling up to 8 Sq. m. clear area without ball bearing and up to 12 Sq.m. clear area with ball bearing. If the rolling shutters are of larger, then gear operated type shutters shall be used.

32.6. The locking arrangement shall be provided at the bottom of shutter at both ends The shutters shall be opened from outside.

32.7. The Shutters shall be completed with door suspension shafts, looking arrangements, pulling hooks, handles and other accessories.

M-33. Collapsible Steel Gate

33.1. The collapsible steel gate shall be in one or two leaves and size as per approved drawings or as specified. The gate shall be fabricated from best quality mild steel channels, flats etc. Either steel pulleys or ball-bearings shall be

provided in every double channel Unless otherwise specified the particulars of collapsible gate shall be as under.

- (a) Pickets : These shall be of 20 mm. M.S. channels of heavy sections unless otherwise shown on drawings. The distance centre to centre of pickets shall be 12 cms .with an opening of 10 Cms
- (b) Pivoted M.S. flats shall be 20 mm x6 mm
- (c) Top and bottom guides shall be from tee of flat iron of approved size.
- (d) The fittings like stoppers fixing, locking cleats, brass handles and cast iron rollers shall be of approved design and size

M-34. Welded Steel Wire Fabric

34.1 Welded steel wire fabric for general purpose shall be manufactured form cold drawn steel wire "as drawn" or galvenised steel conforming to I.S. 226-1975 with longitudinal and transverse wire securely connected at every intersection by a process of electrical resistance welding and conforming to I.S.4948-1974. it shall be fabricated and finished in workmanlike manner and shall be free from injurious defects and shall be rust proof The type of mesh shall be oblong or square as directed The mesh sizes and sizes if wire for square 3b well as oblong welded steel wire fabric shall be as directed The steel wire fabric in panels shall be in one whole piece in each panel as far as stock sizes permit.

18

M-35 Expanded Metal Sheets

35.1. The expanded metal sheets shall he free from flaws joints broken strands laminations and other harmful surface defects. Expanded metal steel sheet shall confirm to IS-412-1975. except that blank sheets need not be with guaranteed mechanical properties The size of the diamond mesh of expanded metal and dimensions of strands (width and thickness) shall be as specified. The tolerance on nominal weight of expanded metal sheets shall be of + 10 percent.

35.2. Expanded metal in panels shall be in one whole piece in each panel as far as stock sizes permit. The expanded metal sheets shall be coated with suitable protective coating to prevent corrosion.

M-36. Mild Steel Wire (Wire Gauze Jali)

36.1. Mild steel wire may be galvanized as indicated. All finished steel wire shall be well cleanly drawn to the dimensions and size of wire as specified in item. The wire shall be sound free from splits surface flaws, rough jagged and imperfect edges and other harmful surface defects and shall conform to I.S. 280-1978.

M-37. Plywood

37.1. The plywood for general purpose shall conform I.S. 303-17-1975.

Plywood is made by cementing together than boards or starts of wood into panels. There are always an odd number of layers, 3,5,7,9, ply etc. The piles are placed so that grain of each layer is at right angles to the grain in the adjacent level.

37.2. The chief advantages of plywood a single board of the same thickness is the more uniform strength of the plywood, along the length and width of the plywood and greater resistance to cracking and splitting with charge in moisture content.

37.3. Usually synthetic resins are used to gluing, phenolic resins are usually cured in a hot press which compresses and simultaneously heats the plies between hot plates which maintain a temperature of 90 degree C to 140 degree C and a pressure of 11 to 14 Kg/ Sq. Cm on the wood. The time of heating may be anything from 2 to 60 minutes depending upon thickness

37.4. When water glue are used the wood absorbs so much water that the finished plywood must be dried carefully. When synthetic resins are used as adhesive the finished plywood must be exposed to an atmosphere of controlled humidity until the proper amount of moisture has been absorbed.

37.5. According to I.S. 303-1975 the plywood for general purpose shall be of the grades namely BWR, WWR and CWR depending up to the adhesives used for bonding the veneers and it will be further classified into six types namely AA, AB, AC, BB, BC and CC based on the quality of the two faces each face being of three kinds namely A, Band C After pressing, the finished plywood should be reconditioned to a moisture content not less than 8 percent and not more than 16 percent.

37.6. Thickness of plywood Boards.

TABLE

Board Thickness Board Thickness Board Thickness Board Thickness

3 ply. 3 mm. 5 ply. 5 mm. 7 ply. 9 mm. 9 ply. 16 mm

4 mm. 6 mm. 13 mm. 19 mm.

5 mm. 7 mm. 16 mm. 11 ply. 19 mm.

6 mm. 8 mm. 9 ply. 13 mm. 25 mm.

M-38. Glass

38.1. All glass shall be of the brief quality, free from specks, bubbles, smokes veins, air holes blisters and other defects. The kind of glass to be used shall be as mentioned in the item or specification or in the special provision or as shown in detailed drawings. Thickness of glass panes shall be uniform. The specifications for different kinds of glass shall be as under.

38.2. Sheet Glass

38.2.1. In absence of any specified thickness or weight in the item or detailed specifications of the item of work, sheet glass shall be weighing 7.5 Kg/Sq. m for panes up to 600 mm x 600 mm.

38.2.2. For panes larger than 600 mm x 600 mm and up to 800 mm x 800 mm the glass weighing not less than 8.75 Kg/Sq m shall be used For bigger panes up to 900 mm x 900 mm. glass weighing not less

19

than 8.75 Kg/Sq. m shall be used. For bigger panes up to 900 mm x 900 mm. glass weighting not less than 11.25

Kg/Sq. m. shall be used

38.2.3. Sheet glass shall be patent flattened glass of best quality and for glazing and framing purposes shall conform to I.S. 1761-1960. Sheet glass of the specified colours shall be used, if so shown, on detailed drawings or so specified. For important buildings and for panes with any dimension over 900 mm plate glass of specified thickness shall be used

38.3. Plate Glass:

38.3.1. When plate glass is specified it shall be "polished patent plate glass" of best quality. It shall have both the surface ground flat and parallel and polished to obtain clear undisturbed vision and reflection. The plate glass shall be of the thickness mentioned in the item or as shown in the detailed drawing or as specified. In absence of any specified thickness, the thickness of plate glass to be supplied shall be 6 mm. and a tolerance of 0.20 mm shall be admissible

38.4. Obscured Glass:

38.4.1. This type of glass transmits light so that vision is partially or almost completely obscured. Glass shall be plain rolled, figured, ribbed or fluted, or frosted glass as may be specified as required. The thickness and type of glass shall be as per details on drawings or as specified or as directed

38.5. Wired Glass:

38.5.1. Glass shall be with wire netting embedded in a sheet of patent glass. Electrically welded 13 mm Georgian square mesh shall be used. Thickness of glass shall not be less than 6 mm. Wired glass shall be of type and thickness as specified

M-39. Acrylic Sheets

39.1. Acrylic sheets shall be of thickness as specified in the item and of an specified shape and size as the case may be. Panels may be flat or curved. It should be light in weight. It shall be colourless or coloured or opaque as specified in the item. Colourless sheet shall be as transparent as the finest optical glass. Its light transmission rate shall be about 95%. Transparency shall not be affected for the sheets of larger thickness, it shall be extremely resistant to sunlight, weather and low temperatures.

It shall not show any significant yellowing or change in physical properties or loss of light transmission over a longer period of use. The sheet shall be impact resistant also. Sheets should be of such quality that they can be cut, bent, jointed as desired. Solution for the joints shall be used as per the requirement of manufacturer.

M-40. Particle board

40.1. The particle boards used for face panels shall be of best quality free from any defects. "The particle boards shall be made with phenolaldehyde adhesive. The particle boards shall conform I S 3087-1905" Specification for wood particle board for general purpose". The size and the thickness shall be as indicated.

M-41. Expanded polystyrene or framed styroper slabs

41.1. The expanded polystyrene ceiling boards and tiles shall be of approved make and shall be of sizes, thickness, finish and colour as indicated. It shall be of high density and suitable for use as insulating material. The insulating material shall be like slabs of Thermocole etc.

M-42. Resin bonded fiber glass.

42.1. The resin bonded fiber glass tiles or rolls shall be of approved make and shall be of sizes, thickness, and finish as indicated.

42.2. For test of Mineral wool thermal insulation [Blanket I S 3144-1965 shall be followed

42.3. Insulation wool blanks shall be with the following coverings on one or both sides as indicated

(1) Bituminous Hessian Kraft paper suitable for use in position where moisture has to be excluded.

(2) Hessian cloth or Kraft paper for keeping out dust

(3) G.I wire netting, suitable for surfaces to be plaster over

M-43. Fixtures and fastenings

43.1. General:

43.1.1. The fixtures and fastenings, that is butt hinges, tee and strap hinges, sliding door bolts, tower bolts, door latch, bath-room latch, handles, door stoppers, casement window fasteners, casement

stays and ventilators catch shall be made of the metal as specified in the item or its specification.

43.1.2. They shall be of iron, brass, aluminum, chromium plated iron, chromium plated brass, copper oxidised iron, copper oxidised brass or anodised aluminum as specified

43.1.3. The fixtures shall be heavy, medium or light type. The fixtures and fastenings shall be smooth finished and shall be such as will ensure ease of operations.

43.1.4. The samples of fixtures and fastenings shall be got approved as regards, quality and shape before providing them in position

43.1.5. Brass and anodised aluminium fixtures and fastenings shall be bright finished

43.2. Holdfasts:

43.2.1. Holdfasts shall be made from mild steel flat 30 cm length and one of the holdfasts shall be bent at right angle and two nos of 6 mm. diameter holes, shall be made in it for fixing it to the frame with screws. At the other end, the holdfast shall be forked and bent at right angles in opposite directions

43.3. Butt hinges:

43.3.1. Railway standard heavy type butt hinges shall be used when so specified

43.3.2. Tee and strap hinges shall be manufactured from M S Sheet

43.4. Sliding door bolts (Aldrops):

43.4.1. The aldrops as specified in the item shall be used and shall be got approved.

43.5. Tower bolts (Barrel Type):

43.5.1. Tower bolts as specified in the item shall be used and shall be got approved

43.6. Door Latch:

43.6.1. The size of door latch shall be taken as the length of latch.

43.7. Bathroom Latch:

43.7.1. Bathroom latch shall be similar to tower bolt.

43.8. Handle:

The size of the handles shall be determined by the inside grip length of the handles. Handles shall have a base plate of length 50 mm. more than the size" of the handle.

43.9. Door Catch:

43.9.1. Door stoppers shall be either floor door stopper type or door catch type Floor stopper shall be of overall size as specified and shall have a rubber cushion.

43.10. Door Stoppers:

43.10.1. Door catch shall be fixed at a height to about 900 mm from the floor level such that one part of the catch is fitted on the inside of the shutter and the other part is fixed in the wall with necessary wooden plug arrangements for appropriate fixity The catch shall be fixed 20 mm inside the face of the door for easy operation of catch.

43.11. Wooden Door Stop with hinges:

43.11.1. Wooden door stop of size 100 mm x 50 mm x 40 mm shall be fixed on the door frame with a hinges of 75 mm. size and at a height of 900 mm. from the floor level The wooden door stop shall be provided with 3 coats of approved oil paint

43.12. Casement Window Fastener:

43.12.1. Casement window fastener for single leaf window shutter shall be left or right handed as directed

43.13. Casement stays (Straight Red Stay):

43.13.1. The stays shall be made from a channel section having three holes at appropriate position so that the window can be opened either fully or partially as directed. Size of the stay shall be 250 mm to 300 mm. as directed.

43.14. Ventilator Catch:

43.14.1. The pattern and shape of the catch shall be as approved

43.15. Pivot:

43.15.1. The base and socket plate shall be made from minimum 3 mm. thick plate: and projected pivot shall not be less than 12 mm 'diameter and 12 mm. length and shall be firmly riveted to the base plate in

21
case of iron pivot and in single piece plate in the case of brass pivot.

M-44. Paints:

44.1. (A) Oil paints :

44.1.1. Oil paints shall be of the specified colour and as approved The ready mixed paints shall only be used. However, if ready mixed paint of specified shade or tint is not available white ready mixed paint with approved stainer will be allowed In such a case the contractor shall ensure that the shade of the paint so allowed shall be uniform.

44.1.2. All the paints shall meet with the following general requirements

(i) Paint shall not show excessive setting in a freshly opened full can and shall easily be ready spread with a paddle to a smooth homogeneous state. The paint shall show no curdling, levering caking or colour separation and shall be free from lumps and skins

(ii) The paint as received shall brush easily, possess good leveling properties and show no running or sagging tendencies

(iii) The paint shall not skin within 48 hours in a three quarters filled closed container

(iv) The paint shall dry to a smooth uniform finish free from roughness, grit unevenness and other imperfections

44.1.3. Ready mixed paint shall be used exactly as received from the manufacturers and generally according to their instructions and without any admixtures whatsoever

44.2. (B) Enamel paints:

44.2.1. The enamel paint shall satisfy in general requirements in specification of oil paints, Enamel paint shall conform to I.S. 2933-1975.

M-45. French Polish

45.1. The French polish of required tint and shade shall be prepared with the below mentioned ingredients and other necessary materials:

(i) Denatured spirit of approved quality (ii) Chandras (iii) Pigment.

45.2. The French polish so prepared shall conform to I S : 348-1 9C8.

M-46. Marble chips for marble mosaic terrazzo

46.1. The marble chips shall be of approved quality and shades. It shall be hard, sound, dense and homogeneous in texture with crystalline and coarse grains It shall be uniform in colour and free from stains cracks, decay and weathering.

46.2. The size of various colours of marble chips ranging from the smallest up to 20 mm shall be used where the thickness of top wearing layer is 6 mm size The marble chips of approved quality and colours only as per grading as decided by the Engineer-in-charge shall be used for marble mosaic tiles or works

46.3. The marble chips shall be machine crushed. They shall be free from foreign matter, dust etc. Except as above, the chips shall conform to I S 2114-1962

M-47. Flooring Tiles

47.1. (A) Plain Cement tiles;

47.1.1. The plain cement tiles shall be of general purpose type. These are the tiles in the manufacture of which no pigments are used. Cement used in the manufacture of tiles shall be as per Indian Standards.

47.1.2. The tiles shall be manufactured from a mixture of cement and natural aggregates by pressure process. During manufacture the tiles shall be subjected to pressure of not less than 140 Kg/Sq. Cm. The proportion of cement to

aggregate in the backing of the tiles shall be not less than 1.3 by weight. The wearing face, through the tiles are of plain cement, shall be provided with stone chips of 1 to 2 mm. size. The proportions of cement to aggregate in the wearing layer of the tiles shall be three parts of cement to one parts chips by weight. The minimum thickness of wearing layer shall be 3 mm. The colour and texture of wearing layer shall be uniform throughout its face and thickness. On removal from mould, the tiles shall be kept in moist condition continuously at least for seven days and subsequently, if necessary, for such long period as would ensure their conformity to requirements of I.S.1237-1980 regarding strength resistance to wear and water absorption.

47.1.3 The wearing face of the tiles shall be plane, free from projections, depressions and cracks and shall be reasonably parallel to the back face of the tile. All angles shall be right angle and all edges shall be sharp and true.

22

47.1.4. The size of tiles generally be square shapes 24.85 Cm x24.85 Cm. or 25 Cm x 25 Cm The thickness of tiles shall be 20 mm.

47.1.5. Tolerance of length and breadth shall be plus or minus one millimeter Tolerance on thickness shall be plus 5mm.

47.1.6. The tiles shall satisfy the tests as regards transverse strength, resistance to wear and water absorption as per I.S 1237-1980.

47.2. (B) Plain Coloured Tiles:

47.2.1. The tiles shall have the same specification as for plain cement tiles as per (A) above expect that they shall have a plain wearing surface wherein pigments are used. They shall conform it I.S. 1237-1980.

47.2.2. The pigments used for colouring cement shall not exceed 10 percent by weight of cement used in the mix. The pigments, synthetic or otherwise, used for colouring tiles shall have permanent colour and shall not contain materials detrimental to concrete

47.2.3 The colour of the tiles shall be specified in the item or as directed

47.3. (C) Marble mosaic tiles:

47.3.1. These tiles have same specification as per plain cement tiles except the requirements as stated below

47.3.2. The marble mosaic tiles shall conform to I.S 1237-1980. The wearing face of the tiles shall be mechanically ground and filled. The wearing face of tiles shall be free from projections depressions and cracks and shall be reasonably parallel to the back face of the tiles. All angles shall be right angles and all edges shall be sharp and true.

47.3.3. Chips used in the tiles be from smallest up to 20 mm. size. The minimum thickness of wearing layer of tiles shall be 6 mm. For pattern of chips to be had on the wearing face a few samples with or without their full size photographs as directed shall be approved by the Engineer-in-charge, for approval.

47.3.4. Any particular samples if found suitable shall be approved by the Engineer-in-charge, or he may ask for a few more samples to be presented The samples shall have of be made by the contractor till a suitable sample is finally approved for use in the work. The Contractor shall ensure that the tiles supplied for, the work shall be in conformity with the approved sample only, in terms of its dimensions, thickness of backing layer and wearing surface, materials, ingredients, colour, shade, chips, distribution etc. required.

47.3.5. The tiles shall be prepared form cement conforming to Indian Standards or coloured port land cement generally depending upon the colour of tiles to be used or as directed.

47.4. (D) Chequered Tiles :

47.4.1. Chequered tiles shall be plain cement tiles or marble mosaic tiles. The former shall have the same specification as per (A) above and the latter as per marble mosaic tiles as per (C) except as mentioned below

47.4.2. The tiles shall be of nominal size of 250 mm. x 250 mm. or as specified. The centre to centre distance of chequer shall not be less then 25 mm. and not more than 50 mm. The overall thickness of the tile shall be 22 mm

47.4.3. The grooves in the chequers shall be uniform and straight. The depth of the grooves shall not be less than 3 mm. The chequered tiles shall be plain coloured or mosaic as specified The thickness of the upper layer measured from the top of the chequers shall not be less than 6 mm. The tiles shall be given the first grinding with machine before delivery to site

47.4.4. Tiles shall conform or relevant I.S 1237-1980. 47.5.

(E) Chequered Tiles For Stair Cases :

47.5.1. The requirements of these tiles shall be the same as chequered tiles as per (D) above except in following respects :

(1) The length of a tile including nosing shall be 300 mm (2) The minimum thickness shall be 28 mm (3) The nosing shall have also the same wearing layer as at the top. (4) The nosing edge shall be rounded (5) The front portion of the tile for a minimum length of 75 mm. from and including the nosing shall have grooves running parallel to nosing and at centers not exceeding 25 mm Beyond that the tiles shall have normal chequer pattern.

23

M-48. Rough Kotah Storm

48.1. The Kotah stones shall be hard even, sound, and regular in shape and generally uniform in colour. The colour of the stone shall generally be green Brown coloured shall not be allowed for use They shall be without any soft veins, cracks or flaws.

48.2. The size of the stones to be used for flooring shall be of size 600 mm x 600 mm and/or size 600 mm. x 450 mm as directed However smaller sizes will be allowed to be used to the extent of maintaining required pattern. Thickness shall be as specified

48.3. The edges of stones shall be chisel dressed on accounts of chisel dressing of edges shall be permitted for length as well as breadth. Tolerance in thickness shall be + 3 mm

48.4. The edges of stones shall be truly chiseled and table rubbed with coarse sand before paving. All angles and edges of the stones shall be true, square and free from chipping and surface shall be true and plain

48.5. When machine cut edges are specified, the exposed and the edges at joints shall be machine cut The thickness of the exposed machine cut edges shall be uniform

M-49. Polished Kotah Stoics

49.1. Polished kotah stone shall have the same specification as per rough kotah stone except as mentioned below

49.2. The stones shall have machine polished surface. When brought on site, the stones shall be single polished or double polished depending upon its use. The stones for paving shall generally be single polished The stones to be used for dedo, skirting, sink, veneering, sills steps etc. where machine polishing after the stones are fixed in situ is not possible shall be double polished

M-50. Dholpur Stone Slab

50.1. Dholpur stone slab shall be of best quality as approve by the Engineer-in-charge The stone slab shall be without my veins, cracks, and flaws The stone slab shall be even sound and durable regular in snaps and of uniform colour

50.2. The size of the stone shall be as specified in the item or detailed drawing or as approved by the Engineer-incharge The thickness of the stone shall be as specified in the item of work with the permissible tolerance of plus or minus 2 mm. The provision in respect of .polishing as for polished kotah stone shall apply to polished Dholpur stone also. All angles and edges of the face of the stone slab shall be fine chiseled or polished as specified in the item of work and all the four edges shall be machine cut All angles and edges of the stone slab shall be true and plane

50.3. The sample of stone shall be got approved by the Engineer-in-charge for a particular work It shall be ensured' that the stones to be used in a particular work shall not differ much in shade or tint from the approved sample

M-51. Marble Slab

51.1. Marble slab shall be white or of other and of best quality as approved by the Engineer-in-charge

51.2. Slabs shall be hard, close, uniform and homogeneous in texture. They shall have even crystalline gram and free from defects and cracks. The surface shall be machine polished to an even and perfect plane surface and edges machine cut true and square. The rear f ice shall be rough to provide key for the mortar

51.3. Marble slabs with natural veins, if selected shall have to be laid as per the pattern given by the Engineer-incharge. Size of the slab shall be minimum 460 mm x450 mm and preferably 600 mm 'x 600 mm. However, smaller sizes will be allowed to be used of the extent of maintaining required pattern.

51.4. The slab shall not be thinner than the specified thickness at its thinnest part. A few specimen of finished slab to be used shall be deposited by the Contractor in the office for reference

51.5. Except as above the marble slabs shall conform to I.S. 1130-1969

M-52. Granite Stone slab

52.1. Granite shad be of approved colour and quality. The stone shall be hard, even sound and regular in shape and generally uniform in colour. It shall be without any soft veins, cracks of flaws

52.2. The thickness of the stone shall be specified in items

52.3. AH exposed faces shall be double polished to tender truly smooth and even reflecting surface. The 24

exposed edges and corners shall be rounded off as directed The exposed edges shall be machine cut and shall have uniform thickness.

M-53. P.V.C. Flooring

53.1. P.V.C. sheets for P.V.C., floor covering shall be of homogenous flexible type conforming to I S 3462-1966. The P.V.C. covering shall neither develop any toxic effect while put to use nor shall give off any disagreeable odour.

53.2. Thickness of flexible type covering tiles shall be as specified in the description of the item

53.3. The flexible type shall be backed with Hessian or other woven fabric The following tolerances shall be applicable on the nominal dimensions of the rolls or tiles :

(a) Thickness + 015 mm.

(b) Length or Width

(1) 300 mm. Square tiles + 0.20 mm. (3) 900 mm Square tiles + 0.60 mm.

(2) 600 mm. Square tiles + 0 40 mm. (4) Sheets and roll + 0.10 percent.

53.4. Adhesive:

53.4.1. The adhesive for PVC flooring shall be of the type and make recommended by the manufactures of PVC sheets/tiles.

M-54. Facing Tiles

54.1. The facing tiles (burnt clay facing bricks) shall be free from cracks, and nodules of free lime. They shall be thoroughly burnt and shall have plane rectangular faces with parallel sides and sharp straight right angled faces. The texture of the finished surface that will be exposed when in place shall conform to an approved sample consisting not less than for stretcher bricks each representing the texture desired. The facing tiles shall have a pleasing appearance, sufficient resistance to penetration by ram and greater durability than common bricks. The tiles shall conform to I.S. 2691-1972.

54.2. The standard size of facing brick tiles shall be 19 x 9 x 4 cms. The facing brick tiles shall be provided with frog which shall conform to I.S. 11077-1976.

54.3. The permissible tolerance in dimensions specified above shall be as follows:

Size Tolerance for

1st Class Brick 2nd Class Brick

19 cm. + 6 mm. + 10 mm.

9 cm. + 3 mm. + 7 mm.

4 cm. + 1.5 mm. + 3 mm.

The tolerance for distortion or warpage of face or edges of individual brick from a plane surface and from a straight line

respectively shall be as follows:

Facing dimensions Permissible tolerance

Max. below 19 cms. Max. 2.5 mm.

-do- above 19 cms. Max. 3.0 mm.

54.5. The average compressive strength obtained as a sample of five tiles when tested in accordance with the procedure laid as per I S 1077-1976 shall be not less than 175 Kg/Sq Cm. The average compressive strength of any individual bricks shall be not less than 160 Kg / Sq.Cm.

54.6. The average water absorption for five bricks tiles shall not exceed 12 percent of average weight of brick before testing. The absorption for each individual bricks shall not exceed 25 percent.

54.7. The brick tiles when tested in accordance with I.S. 1077-1976, the rate of efflorescence shall not be more than "Slightly effloresced"

M-55. White glazed tiles

55.1. The tiles shall be of best quality as approved by the Engineer-in-charge. They shall be flat and true to shape They shall be free from cracks, crazing sports chipper) edges and corners. The glazing shall be of uniform shade.

55.2. The tiles shall be nominal size of 150 mm x 150 mm unless otherwise, specified. The maximum

25

variation the stated sizes other than the thickness of tile shall be plus or minus 1.5 mm. The thickness of tile shall be 6 mm. Except as above the tiles shall conform to I.S. 1977-19/0

M-56. Galvanised from pipes and fittings

56.1. Galvanised iron pipes shall be of the medium type and of required diameter and shall comply with I.S. 1239-1979. The specified diameter of the pipes shall refer to the inside diameter of the bore. Clamps, screw and all galvanised iron fittings shall be of the standard 'R' or equivalent make

M-57. Bib cock and stop cock

57.1. A bib cock is a draw off tap with a horizontal inlet and free outlet A stop cock is a valve with suitable means of connection for insertion in a pipe line for controlling or stopping the flow

57.2. They shall be of screw down type and of brass chromium plated and of diameter as specified in the description of the item. They shall conform to I.S. 781-1977 and they shall be of best Indian make. They shall be polished bright.

57.3. The minimum finished weight of bib cock and stop cock shall be as given below

Diameter Bib cock Stop cock Diameter Bib cock Stop cock

8 mm 0.25 kg. 0.25 kg. 15 mm 0.40 kg. 0.40 kg.

10 mm 0.30 kg. 0.35 kg. 20 mm 0.75 kg. 0.75 kg.

M-58. Gun metal wheel valve

58.1. The gun metal wheel valve shall be of approved quality. These shall be of gun metal fitted with wheel and shall be of gate valve opening full way and of the size specified. These shall conform to I.S. 778-1971.

M-59. White glazed porcelain wash basin

59.1. Wash basin shall be of white porcelain first quality best Indian make and it shall conform to I.S. 2556 (Part -IV) -1972 and I.S. 771-1979. The size of the wash basin shall be as specified in item. Wash basin shall be of one piece construction with continued over flow arrangements All internal angles shall be designed so as to facilitate cleaning. Wash basin shall have single tap hole as specified. Each basin shall have a circular waste hole which is either riveted or beveled internally with 65 mm. diameter at top and 10 mm. depth to suit the waste fitting. The necessary stud slot to receive the bracket on the under side of the basin shall be provided Basin shall have an internal soap holder which shall fully drain into the bowl.

59.2. White glazed pedestal of the quality and colour as that the basin shall be provided where specified in the item. It shall be completely recessed at the back for reception of supply and wash pipe. It shall be capable of supporting the basin rigidly and adequately and shall be so designed as to make the height from the floor the floor to top of the rim of basin 750 mm. to 800 mm. as directed.

M-60. European type water closet/with low flushing

60.1. The European type water closet shall be white glazed porcelain first quality and shall be of wash down type conforming to I.S. 2556-1973 and I.S. 771-1979

60.2. 'S' trap shall be provided as required with water seal not than 50 mm. The solid plastic seat and cover shall be of best Indian make conforming to I.S 2548-1980. They shall be made of moulded synthetic materials which shall be tough and hard with high resistance to solvents and shall be free from blisters and surface defects and shall have chromium plated brass hinges and rubber buffer of suitable size.

M-61. Orrissa type water closet

61.1. The Specification of Orrissa type white glazed water closet of first quality shall conform to I.S. 2256 (Part-III) -1981 and relevant specification of Indian type water closet except that pan will be with the integral squatting pan of size 580 mm x 400 mm with raised footrest.

M-62. Indian type water closet

62.1. The Indian type white glazed water closet of first quality shall be of size as specified in the item and conforming to I.S. 771-1979 and I.S. 2556 – (Part-II) 1981. Each pan shall have integral flushing. It shall

26

also have an inlet at back and or front for connecting flush pipes as directed. The inside of the bottom of the pan shall have sufficient slope from the front towards the outlet and surface shall be uniform and smooth. Pan shall be provided with 100 mm. diameter 'P' or 's' trap with approximately 50 mm. Water seal and 50 mm. diameter vent horn.

M-62. A. Foot Rests

62.A.1. A pair of white glazed earthen ware rectangular foot to minimum size 250 mm.x 130 mm. x 20 mm shall be provided with the water closet.

M-63. Glazed Earthen Ware Sink

63.1. The glazed earthen-ware sink shall be of specified size, colour and quality. They sink shall conform, to I.S. 771 part – II – 1979. The brackets for sinks shall conform to I.S 775-1970

63.2. The pipes shall conform to I.S. 1239-part-I 1973 and I.S. 404-1962. for steel and lead pipes respectively. 32 mm. brass waste coupling of standard pattern with brass chain and rubble plug shall be provided with sink.

M-64. Glazed earthen-ware Lipped type flat back urinal/corner type urinal

64.1. The lipped type urinal shall be fiat back or corner type as specified in the item and shall conform to I.S 771-1979. It shall be of best Indian make and size as specified and approved by the Engineer-in-charge. The flat back of corner type urinal must be of 1st quality free from any defects, cracks etc.

M-65. Low level Enamel flushing tank

65.1. The low level enamel flushing tank shall be of 15 liters capacity. It shall conform of I S 774-1971. The flushing cistern shall be of best quality and free from any defects. The flushing tank shall have outlet 32 mm. diameter. The outlet shall be connected with W.C. pan by lead pipe or P.V.C. pipe as specified. The flushing tank shall be provided with inlet and outlet for fixing G.I. inlet pipes and over-flow pipes. The flushing cistern shall be provided with chromium plated handle for flushing The flushing tank shall be provided with bracket of cast iron so that it can be fixed on wall at specified height. The brackets shall conform to I.S. 775-1970.

M-66. Cast iron flushing cistern.

66.1. The cast iron flushing cistern shall be of 15 liters capacity. It shall conform to I.S. 774-1971. The flushing cistern shall be of best quality free from any defects. The flushing cistern shall have outlet of 32 mm diameter. The lead pipe shall conform to I.S 404 (Part-I) - 1962; For fixing G.I. inlet pipes and overflow pipe 20 mm. dia. inlet and outlet shall be provided The flushing cistern shall be provided with galvanised iron chain and pull of sufficient length and shall be got approved from the Engineer-in-charge. The cast iron flushing cistern shall be painted with one coat of anticorrosive paint and two coats of paints The flushing cistern shall be fixed on two C I brackets The C I brackets shall conform to I S 775-1970.

M-67. Flush cock.

67.1. Half turn flush cock (Heavy weight) shall be of gun metal chromium plated of diameter as specified in the description of the item. The flush cock shall conform to relevant Indian Standard.

M-68. Cast iron pipes and fittings.

68.1. All soil water, vent and anti syphonage pipes and fitting shall conform to I S. 1729-1964. The pipes' shall have spigot and socket ends with head on spigot end. The pipes and fitting shall be true to shape smooth, cylindrical, their inner and outer surfaces being as nearly as' practicable concentric. They shall be sound and nicely cast and shall be free from cracks, laps, pinholes or there imperfection and shall be neatly dressed and carefully fettled.

68.2. The end of pipes and fittings shall be reasonable square to their axis.

68.3. The sand of cast iron pipes shall be of the diameter as specified in the description and shall be in lengths of 1.5 M., 1.8 M. including socket ends of the pipe unless shorter lengths are either specified or required at junctions etc. The pipes and fittings shall be supplied without ears unless specified or directed otherwise.

27

68.4. Tolerances :

68.4.1. The Standard weights and thickness of pipes shall be as shown in the following table
A tolerance up to minus 10 per cent may however be -allowed against these standard weights

Sr. No.	Nominal
	dia. of bore
	Thickness Overall
	1.5 m. long
	Weight of pipe
	1.8 m long
	excluding ears
	2.m long
1.	
2	
	75 mm.
	100. mm.
	5.0 mm.
	5.0 mm.
	12.38 Kg.
	18.14 Kg.
	16.52 Kg.
	21.67 Kg.
	18.37 Kg.
	24.15 Kg.

68.4.2. A tolerance up to minus 15 percent in thickness and 20 mm. length will be allowed For fittings tolerance in lengths shall be plus 25 mm. and minus 10 mm.

68.4.3. The thickness of fittings and their socket and spigot dimensions shall conform to the thickness and dimensions specified for the corresponding sizes of straight pipes. The tolerance in weights and thickness shall be the same as for straight pipes.

M-69. Nahni Trap

69.1. Nahni trap shall be of cast iron and shall be sound and free from porosity or other defects which affect

serviceability The thickness of the base metal shall not be less than 6.5 mm The surface shall be smooth and free .form craze, chips and other flaws or any other kind of defects which affect serviceability The size of nahni trap shall be specified and shall be of self cleaning design.

69.2. The Nahni trap shall be of-quality approved by the Engineer-in-charge and shall generally conform to the relevant Indian Standards.

69.3. The Nahni trap provide shall be with deep seal, minimum 50 mm. except at places where trap with deep seal cannot be accommodated. The cover shall be cast iron perforated cover shall be provided on the trap of appropriate size.

M-70. Gully Trap

70.1. Gully trap shall conform to I.S. 651-1980. It shall be some, free .from defects such as fire-cracks or hair cracks. The glaze of the traps shall be free from crazing. They shall give a sharp clear note when struck with light hammer. There shall be no broken blisters.

70.2. The size of the gully trap shall be as specified in the item.

70.3. Each gully trap shall have one C.I. grating of square size corresponding to the dimensions, of inlet of gully trap. It will also have a water tight C.I. cover with frame inside dimensions 300 mm. x 300 mm. the cover with frame inside dimensions 300 mm. x 300 mm. the cover and weighing not less than 4.53 Kg. and the frame not less than 2.72 Kg. The grating cover and frame shall be of sound and good casting and shall have truly square machined seating faces.

M 71. Glazed Stone Ware pipe And Fittings

71.1. The pipes and fittings shall be of best quality as approved, by the Engineer-in-charge. The pipe shall be of best quality manufactured from stone- ware of fire clay, salt glazed thoroughly burnt through the whole thickness, of a close, even texture, free from air blows, fire blisters, cracks and other imperfections, which affect the serviceability. The inner and outer surfaces shall be smooth and perfectly glazed. The pipe shall be capable to withstand pressures or 1.5 M lead without showing sign of leakage. The thickness of the wall shall not be less than 1/12th of the internal dia. The depth of socket shall not be less than 38 mm. The socket shall be sufficiently large to allow a joint of 6 mm. around the pipe.

71.2. The pipes shall generally conform to relevant I S 651-1980.

M-72. Wall Peg Rail

72.1. The aluminum wall peg rail shall have three aluminum pegs approved quality and size. It shall be fixed on teakwood plank of size 450 mm x 75 mm x 20 mm. The teakwood shall be French polished or oil painted as specified.

M-73. G.I. Water Spot

73.1. The G.I. pipes of 40 mm dia shall be of medium quality and specials shall be of 'R' brand or equivalent brand of best approved quality

28

73.2. The pipe shall have length as required for the thickness of wall in which it is fixed and at outside end tee bend cut at half the length shall be provided and at other end coupling shall be provided to have better fixing. The water spout shall be provided as per detailed drawing or as directed

M-74. Asbestos Cement pipe (A.C. pipe)

74.1. The asbestos cement pipe of diameter as specified in the description of the item shall conform to I.S. 1626-1980. Special like bends, shoes, cowls, etc. shall conform to relevant Indian Standards The intent of pipe shall have is smooth finish, regular surface and regular internal diameter. The tolerance in all dimensions shall be as I.S. 1626-part-I-1980.

M-75. Crydon Ball valve

75.1. Ball valve of screwed type including polythene float and necessary level etc shall be of the size as mentioned in the description of item and shall conform to I.S 1703-1977

M-76. Bitumen Felt For Water proofing And Damp Proofing

76.1. Bitumen felt shall be on the fiber bases and shall be of type 2, self finished felt grade-2 and shall conform to I.S. 1322-1970

M-77. Selected Earth

77.1. The selected earth shall be that obtained from excavated material or shall have to be brought from outside as indicated in the items If item does not indicate anything the selected earth shall have to be brought from outside.

77.2. The selected earth shall be good yellow soil and shall be got approved from the Engineer-in-charge. In no case black cotton soil or similar expansive and shrinkable soil shall be used. It shall be clean and free from all rubbish and perishable materials, stones or brick bats. The clods shall be broken to a size of 50 mm or less. Contractor shall make his own arrangement at his own cost for land for borrowing selected earth. The stacking of material shall be done as directed by the Engineer-in-charge in such a way not to interfere with any construction all activities and in proper stacks.

77.3. When excavated material is to be used only selected stuff got approved from the Engineer-in-charge shall be used. It shall be stacked separately and shall, comply with all the requirements of selected earth mentioned above

M-78. Barbed Wire

78.1. The barbed wire shall be of galvanised steel and it shall generally conform to I.S. 278-1978. The barbed wire shall be of types-I whose nominal diameter for line wire shall be 2.5 mm. and point wire 2.24 mm. The nominal distance between two bars shall be 75 mm unless otherwise specified in the item. The barbed wire shall be formed by twisting together two wire wires. One containing the barbs. The size of the line and point wires and barb spacing shall be as specified above. The permissible deviation from the nominal diameter of the line wire and point wire shall not exceed + 0.08 mm

78.2. The barbs shall carry four points and shall be formed by twisting two point wires, each two turns tightly round one line wire making altogether four complete turns. The barbs shall have a length of not less than 13 mm and not

more than 18 mm. The point shall be sharp and cut at an angle not greater than 35 degree of the axis of the wire forming the barbs.

78.3. The line and point wires shall be circular in section, free from scale and other defects and shall be uniformly galvanized. The line wire shall be in continuous length and shall not contain any welds other than those in the rod before it is drawn. The distance between two successive splices shall not be less than 15 meters.

78.4. The lengths per 100 Kg. of barbed wire I.S. type I shall be as under:
Nominal 1000 meter Minimum 934 meter Maximum 1066 Meter.

29

SECTION -4

Excavation

4.0.0. (A) Excavation for foundation up to 1.5 M. depth including sorting out and stacking of useful materials and disposing of the excavated stuff up to 50 meter lead in loose or soft soil.

1.0. General

1.1. Any soil which generally yields to the application of pickaxes and shovels, phawaras rakes or any such ordinary excavating implement or organic soil, gravel silt, sand turf loam, clay, peat etc., fall under this category

2.0. Clearing the site

2.1. The site on which the structure is to be built shall be cleared, and all obstructions loose stone, materials and rubbish of all kind bush wood and trees shall be remove! as directed The materials so obtained shall be property of the Government and shall be conveyed und stacked as directed within 50 m lead. The roots of the trees coming in the sides shall be cut and coated with a hot asphalt

2.2. The rate of side clearance is deemed to be included in the rate of earth work for which no extra will be paid.

3.0. Setting out

After clearing the site the centre lines will be given, by the Engineer-in-charge. The contractor shall assume full responsibility for alignment, elevation and dimension of each and all 'parts of the work. Contractor shall supply labours materials, etc. required for setting out the reference marks and bench 'marks and shall maintain them as long as required and directed.

4.0. Excavation

The excavation in foundation shall be carried out in true line and level and shall have the width and depth as shown in the drawings or as directed. The contractor shall do the necessary shoring and shutting or providing necessary slopes to a safe angle, at his own cost. The payment for such precautionary measures shall be paid separately it not specified. The bottom of the excavated area shall be leveled both longitudinally and transversely as directed by removing and watering as required No. earth filling will be allowed for brining it to level If by mistake or any excavation is made deeper or wider than, that shown on the plan or directed. The extra depth or width shall be made up with concrete of same proportion as specified for the foundation concrete at the cost of the contractor. The excavation up to 1.5 m depth shall be measured under this item.

5.0. Disposal of the excavated stuff

5.1. The excavated stuff of the selected type shall be used in filling the trenches and plinth or leveling the ground in layers including ramming and watering etc.

5.2. The balance of the excavated quantity shall be removed by the contractor from the site of work to a place as directed with lead up to 50 M. and all lift.

6.0. Mode of measurements & payment

6.1. The measurement of excavation in trenches for foundation shall be made according to the sections of trenches shown on the drawing or as per sections given by the Engineer-m-charge. No payment shall be made for surplus excavation made in excess of above requirements or due to stopping and sloping back as found necessary on account of conditions of soil and requirements of safety.

6.2. The rate shall be for a unit of one cubic meter

4.0.0. (B): Excavation for foundation up to 1.5 M. depth including sorting out and stacking of useful materials and disposing of the excavated stuff up to 50 meter lead in dense or hard soil.

1.0. Dense or Hard Soil

Any soil which generally require close application of picks or jumpers or scarifies to. loosen it stiff clay, gravel and stone etc. fall under this category.

2.0. Workmanship

The relevant specifications of item No. 4.0.0.(A) shall be followed except that the excavation work shall be carried out in dense or hard soil,

3.0. Mode of measurements & payment

3.1. The relevant specifications of item No. 4.0.0. (A) shall be followed

3.2. The rate shall be for unit of one cubic meter.

4.0.0.(C): Excavation for foundation up to 1.5 M. depth including sorting out and stacking of useful

30

materials and disposing of the excavated stuff up to 50 meter lead in hard murrum.

1.0. Hard murrum.

The hard murrum shall be clean of good binding quality and of approved quality obtained from approved quarries of disintegrated rocks which contain sons materials and natural mixture of clay of clarions origin The size of hard murrum shall not be more than 20 mm.

2.0. Workmanship

The relevant specification of item No. 4.0..0.(A) shall be followed except that the excavation work shall be carried in hard murrum.

3.0. Mode of measurements & Payments

3.1. The relevant specifications of item No. 4 0.0. (A) shall be followed.

3.2. The rate shall be for a unit of one cubic meter.

4.0.0.(D): Excavation for foundation up to 1.50 M. depth including sorting out and stacking of useful materials and disposing of the excavated stuff up to 50 meter lead-soft rock not requiring blasting.

1.0. Workmanship

1.1. The relevant specifications of item No. 4.0.0.(A) shall be followed except that the excavation shall be earned out for foundation upon 1.5 M lift in soft rock not requiring blasting

1.2. The excavation in soft or disintegrated rock shall be carried out by crow bars, pickaxes or pneumatic drills or any other suitable means

1.3. If contractor desires to resort to blasting, he can do so with permission of the Engineer-in-charge but nothing extra shall be paid to him.

1.4. The materials available from soft excavation shall be properly stacked within 50 M. lead and 1 5 m. lift and shall be the property of department.

1.5. The classification of strata of the foundation soil shall be done by the Engineer-in-charge and shall be acceptable to the contractor

1.6. However this shall include the type of rock and boulder which may quarried or split with crow bars. Laterite and conglomerate also come under this category.

2.0. Mode of measurements & Payment

2.1. The relevant specifications of item No. 4.0 0 (A) shall be followed.

2.2. The rate shall be for a unit of one cubic metre.

4.0.0.(E): Excavation for foundation up to 1.5 M. depth including sorting out and stacking of useful material and disposing of the excavated stuff up to 50 meter lead in hard rocks.

1.0. Workmanship

1.1. The relevant specification of item No. 4.0.0.(A) shall be followed except that the excavation for foundation work shall be carried out in hard rock.

1.2. Excavation shall be done by blasting to the dimensions shown in the drawings or as directed. The blasting shall be carried out only with written permission of the Engineer-in-charge. All the laws, regulations etc,- pertaining to the precautions, acquisition, transport, landing and use of explosive shall be rigidly followed. The Magazine for the storage for the explosive shall be built to the design and specifications of explosive authority and located at the approved site No unauthorised persons shall be admitted into the magazine and when not in use it shall be kept securely locked No matches or inflammable materials shall be allowed in Magazine. The Magazine shall have an effective lightning conductor. The rules of explosive 1940 revised from time to time shall be followed strictly for obtaining starting, handling, undertaking blasting work.

1.3. The contractor shall be responsible for damage to property, workmen public due to any accident due to use of explosives and operations

1.4. Precautions

1.4.1. The blasting operation shall remain in charge of competent and experienced supervisor and workmen who are thoroughly acquainted with the detail of handling explosive and blasting operations. The blasting shall be carried out during fixed hours of the day, preferably during the mid-day lunch hours or at the close of the work as ordered in writing by the Engineer-in-charge. The hours of blasting shall be notified in advance to the people in the vicinity. All the charges shall be prepared by the man in charge only.

1.4.2. Red danger flags shall be displayed prominently in all direction during the blasting operations.

1.4.3. People except those who actually light the fuse shall be prohibited from entering into this area. The flags shall be stationed at 200 m. from the firing-site in all directions and all persons including workmen shall be excluded from the flagged area at least 1.0 minutes before the firing warning whistle being sounded for this purpose

1.4.4. During excavation in rock by blasting, the lowest 15 cm. of strata shall be blasted with light charge so

31

as not to shatter or weaken the underlying rock on which the foundation will be actually laid If excavation in rock is done to large widths and length than those shown on the drawings or as directed, no payment shall be made for such over break. If excavation is done to depths greater than shown on the drawings or directed, excess depth shall be made up with foundation grade concrete as directed at the contractor's cost.

1.4.5. The charged hole shall be drilled to the required depth and in suitable places when blasting is done with powder, the fuse cut to the required length shall be inserted in the holes and the powder dropped in. The powder shall be gently tamped with copper rod with rounded ends. The explosive powder shall then be covered with trapping materials which shall be tamped lightly out firmly. When blasting is done with dynamite and other high explosive, dynamite cartridges shall be prepared by inserting the square cut ends of fuse into the detonator, and finished with dippers at the open ends The detonator should be gently pushed into the detonator and finished with dippers at the opened ends. The detonator should be gently pushed explosive. Bore holes shall be of such size that the cartridges can be easily passed down. The holes shall be cleared of all debris and explosive inserted The space for about 20 cms, above the charge shall then be gently filled with dry clay pressed home and rest of tamping is with firmed any convenient materials gently packed with a wooden cover.

1.4.6. At a time not more than 10 such charge shall be prepared and fired. The man in charge shall blow a whistle in a recognised manner for cautioning the people. All the people shall then be required to move to number of explosions. He shall satisfy himself that all the charges have been exploded before allowing the workmen to go to the work site.

1.4.7. The contractor shall be fully responsible to strictly follow the prevailing rules and procedures regarding

blasting procedures

1.5. Misfire

1.5.1. In case of a misfire the following procedure shall be observed :

1.5.2. Sufficient time shall be allowed to account for the delayed blast. The man in charge shall inspect all the charges and determine the missed charge.

1.5.3. If it is the blasting powder charge it shall be completely flooded with water. A new hole shall be drilled at, about 45 cm. from the old and fired. This should blast the old charge Should^ it not blast the old charge, the procedure shall be repeated till the old charge is blasted.

1.5.4. In case of charge of gelatins, dynamite etc, the man in charge shall gently remove the tamping and the primer with detonator and primer shall then be used to blast the charge. Alternatively the hole may be cleared of one foot of tamping and the direction then ascertained by placing a stick in the hole Another hole may then be drilled 15 cm away and parallel to it. The man in charge shall report to the office all cases of misfire and cause of the same and what steps were taken in connection therewith.

1.5.6. If a misfire has been found to be due to defective dynamite, the whole quantity in the box from which defective article was taken must be sent to authority as directed for inspection to ascertain whether all the remaining materials in the box are also defective or not.

1.6. Accidents:

1.6.1. The contractor shall be solely responsible for any accident during the entire procedure of handling explosive and blasting and shall pay necessary compensation to persons affected or damage to lands or property etc, due to the blasting, without extra claims on the department.

1.7. Account:

1.7.1. A careful and day to day account of explosives shall be maintained by the contractor in an approved manner and shall be open to inspection of the Engineer-in charge Surprise visits may also be paid by the Engineer-in-charge to the storage and in case of any unaccountable shortage or unsatisfactory accounting, the contractor shall be liable to be penalised by forfeiture of part or whole of his Security Deposit or by cancellation of tender in which case he shall not be entitled for any compensation .-

1.8. Disposal of Excavated Materials:

1.8.1 No materials excavated from foundation trenches of whatever kind they may be, are to be placed even temporarily nearer than 1.5 m. or distance prescribed by the Engineer from the outer edge of excavation. All materials excavated shall remain the property of Government. Rate for excavation includes sorting out of useful materials and stacking them separately as directed within the specific lead. Materials suitable and useful for backfilling or other use shall be stacked in convenient places but not in such a way as to obstruct free movement of men, animals and vehicles or encroach upon the area required for constructional purpose. The site shall be left clean of all debris on completion.

1.8.2. Disposal of excavated materials is subject to the following :

32

Unsuitable materials obtained from clearing site and excavation shall be disposed off within a lead of 50 meters as directed. Useful materials obtained from clearing site and excavation shall be stacked within a lead of 50 M beyond the building areas as directed. Materials suitable for back-filling shall be stacked at convenient places within a lead of 50 M. from the structure for reuse. Useful stones from rock excavation shall be stacked neatly. within a lead of 50 M. and will be allowed to be used by the contractor on payment at rates laid down in the contract or if not so laid down, at scheduled rates of the Division or at a mutually agreed rates if there are no such rates in the schedule of rates.

1.8.3. If surplus materials are required to be conveyed beyond 50 M, conveyance will be paid for under a separate item

2.0. Mode of measurements & Payment

2.1. The work shall be measured for the work limited to the dimensions shown on drawings or directed Excavation to dimension in excess of the above will not be measured or paid for and if so ordered by the Engineer the contractor shall have to fill up the excess depth with cement concrete specified for foundation without extra payment.

2.2. Driving of sounding bars, drill holes to explore the nature of substratum up to a total length of meter distributed in 2 or 3 places in each foundation if necessary, will be considered incidental work and will not be paid for separately.

2.3. Removal of slips and blows in the foundation trenches will not be measured or paid for.

2.4. if it is necessary in the opinion of the Engineer-in-charge to carry foundation below the levels shown on the plans, the excavations for the 1.5 M of addition depth will be included in the quantity for the particular classification and will be paid for as extra at rate to be decided under the general conditions of contract unless, the contractor is willing to accept payment as tendered rates.

2.5. The rate shall be for a unit of one cubic meter

4.0.0.1.(A): Excavation for foundation for depth from 1.5 M. to 3.0 M. including sorting out and stacking or useful materials and disposing of the excavated stuff up to 50 M. lead-loose or soft soil.

1.0. Workmanship

1.1. The relevant specifications or item No. 4.0.0. (A) shall be followed except that the excavation work shall be carried out to loose or soft soil with lift 1.5 M. to 3.0 M.

2.0. Mode of Measurement & Payment

2.1. The relevant specifications of item No. 4.0.0.(A) shall be followed.

2.2. The excavation work of from 1.5 M. to 3.0 M. shall be measured under this item

2.3. The rate shall be for a unit of one cubic meter

4.0.0.1.(B): Excavation for foundation for depth from 1.5 M. to 3.0 M. including sorting out and stacking of

useful materials and disposing of excavated stuff up to 50 M. lead in Dense or Hard soil.

1.0. Workmanship

The relevant specifications of item No. 4.0.0.(B) shall be followed except that the excavation work shall be carried out with 1.5 M. to 3.0 M. lift in dense or hard soil.

2.0 Mode of Measurement & Payment

2.1 The relevant specifications of item No.4.0.0.(A) shall be followed.

2.2. The excavation work from 1.5 to 30M shall be measured under this item

2.3. The rate shall be for a unit of one cubic meter.

4.0.0.1.(C): Excavation for foundation for depth from 1.5 M. to 3.0 M. including sorting out and stacking of useful materials and disposing of excavated stuff up to 50 M. lead in Hard murrum.

1.0. Workmanship

1.1. the relevant specifications of item No. 4.0.0. (A) shall be followed except that the excavation work shall be carried out from 1.5 M. to 3.0 M lift in hard murrum.

2.0. Mode of Measurement & Payment

2.1. The relevant specifications of item No. 4.0.0. (A) shall be followed.

2.2. The excavation work from 1.5 M to 3.0 M shall be measured under

2.3. The rate shall be for unit of one cubic meter

4.0.0,1.(D): Excavation for foundation for depth 1.5 M. to 3.0 M. including sorting our and stacking

33

of useful materials and disposing of excavated stuff up to 50 M. lead in soft rock not required blasting.

1.0. Workmanship

The relevant specifications item No. 4.0.0.(D) shall be followed except that the excavation work shall be earned out from 1.5 M. to 3.0 M. lift in soft rock not required blasting.

2.0. Mode of Measurement & Payment

2.1. The relevant specifications of item No 4.0.0.(A) shall be followed.

2.2. The excavation work from 1 5 M, to 3 0 M lift shall be measured under this item.

2.3. The rate shall be for a unit of one cubic meter

4.0.0.1.(E): Excavation for foundation for depth 1.5 M. to 3.0 M. including sorting out and stacking of useful materials and disposing of excavated stuff up to 50 M. lead in hard rock

1.0. Workmanship

1.1. The relevant specifications of item No. 4.0.0.(E) shall be followed except that the excavation work shall be carried out from 1.5 M. to 3.0 M. lift in hard rock.

2.0. Mode of Measurement & Payment

2.1. The relevant specifications of item No. 4.0.0. (A) shall be followed.

2.2. The excavation-work from 1.5 M, to 3.0 lift shall be measured under this item

2.3. The rate shall be for a unit of cubic meter

4.0.0.2. (A): Excavation for foundation for depth from 3.0 M. to 5.0 M. including sorting out and stacking of useful materials and disposing of the excavated stuff Upton 50 M. lead in loose or soft soil.

1.0. Workmanship

1.1. The relevant specifications of item No. 4.0.0.(A) shall be followed except that the excavation work shall be carried out from 3.0 M. to 5.0. M. lift in loose or soft soil.

2.0. Mode of Measurement & Payment

2.1. Relevant specifications of item No. 4.0.0.(A) shall be followed.

2.2. The excavation work from 3.0 M. to 5.0 M. lift shall be measured under this item.

2.3. The rate shall be for a unit of one cubic meter.

4.0.0.2.(B): Excavation for foundation for depth from 3.0 M. to 5.0 M. including sorting our and stacking of useful materials and disposing of the excavated stuff up to 50 M. lead in Dense or Hard soil.

1.0. Workmanship

1.1. The relevant specifications of item No. 4 0.0.(B) shall be followed except that the excavation work shall be carried out from 3.0.m. to 5.0.m. lift in Dense or Hard soil.

2.0. Mode of Measurement & Payment

2.1. The relevant specifications of item No. 4.0.0.(A) shall be followed:

2.2. The excavation work from 3.0. M. to 5,0 M. lift shall be measured under this item.

2.3. The rate shall be for a unit of one cubic metre.

4.0.0.2.(C): Excavation for foundation for depth from 3.0 M. to 5.0 M. including sorting out and stacking of useful material and disposing of the excavated stuff up to 50 M. lead in Hard murrum.

1.0. Workmanship

1.1. The relevant specifications items No. 4 0.0. (C) shall be followed except that the excavation work shall be carried out from 3.0 m to 5 0 M in Hard murrum.

2.0. Mode of Measurement & Payment

2.1. The relevant specifications of item No. 4.0.0.(A) be followed.

2.2. The excavation work from 3.0 M. to 5.0. lift shall be measured under this item.

2.3. The rate shall be for a unit of one cubic metre.

4.0.0.2.(D) Excavation for foundation for depth from 3.0 M. to 5.0 M. including sorting out and stacking of useful materials and disposing of the excavated stuff up to 50 M. in soft rock not required blasting.

1.0. Workmanship

1.1. The relevant specification-of item NO 4 0.0.(D) shall be followed except that the excavation work shall be carried out from 3.0. M to 5.0. M soft rock not requiring blasting

2.0. Mode of Measurement & Payment

34

2.1. The relevant specification of item No. 4.0 O.(A) shall be followed.

2.2. The excavation work from 30 M. to 5 0 M. lift shall be measured under this item.

2.3. The rate shad be for a unit of one cubic meter

4.0.0.2.(E): Excavation for foundation depth from 3.0 M. to 5.0 M. including sorting out and stacking of useful material land .disposing of the excavated stuff up to 50 M. lead in Hard rock.

1.0. Workmanship

1.1. The relevant specifications of item No 4.0.0.(E) shall be followed except that the excavation work shall be earned out from 3.0. M. to 5.0 M in hard rock

2.0. Mode of Measurement & Payment

2.1. The relevant specification of item No. 4.0.0.(A) shall be followed.

2.2. The excavation work from 3.0. M to 5.0 M. lift shall be measured under this item.

2.3. The rate shall be for a unit of one cubic meter.

4.0.0.3.(A): Extra for additional depth more than 5.0 M. for excavation for foundation including sorting out and stacking of useful material disposing of the excavated stuff up to 50 M. lead in loose or soft soil.

1.0. Workmanship

1.1. The relevant specification of item. No 4 0.0 (A) shall be followed except that the excavation work shall be earned out from more than 5 0 M. lift in loose or soft soil

2.0. Mode of Measurement & Payment

2.1. The relevant specifications of item No. 4.0.0.(A) shall be followed

2.2. The rate shall be paid extra over and above the rate of item No. 4 0 0.2.(A) for carrying' out excavation work for additional depth from 5.0 M. and above.

2.3. The rate shall be for a unit of cubic per meter

4.0.0.3.(B): Extra for additional depth more than 5.0 M. for excavation for foundation including sorting and stacking of useful materials disposing of excavated stuff up to 50 M. lead in Dense or Hard soil.

1.0 Workmanship

1.1. The relevant specifications of item No. 4.0.0.(B) shall be followed except that the excavation work shall be carried out from more than 5.0. M. lift in dense or hard soil.

2.0. Mode of Measurement & Payment

2.1. The relevant specifications of item No. 4 0.0 (A) shall be followed.

2.2. The rate shall be paid extra over and above the rate of item No 4 0.0 2.(B) for carrying out excavation work for additional depth from 5 0 M. and above.

2.3. The rate shall be for a unit of one cubic meter.

4.0.0.3.(C): Extra for additional depth more than 5.0 M. for excavation for foundation including sorting out and stacking of useful materials disposing of excavated stuff up to 50 M. lead in Hard murrum.

1.0. Workmanship

1.1. The relevant specification of item No. 4.0.0 (C) shall be followed except that the excavation work shall be carried out from more than 5 0 M. lift in hard rnurrum.

2.0. Mode of Measurements & Payment

2.1. The relevant specification of item No. 4.0.0.(A) shall be followed.

2.2. The rate shall be paid extra over and above the rate item No 4.0.0 2.(C)for carrying out excavation work for additional depth from 5 0 M. and above.

2.3. The rate shall be for a unit of one cubic meter.

4.0.0.3.(D): Extra for additional depth more than 5.0 M. for excavation for foundation including sorting out and stacking of useful materials disposing of excavated stuff up to 50 M. lead in soft rock not requiring blasting.

1.0. Workmanship

1.1. The relevant specifications of Item No. 4.0.0.(D) shall be followed except that the excavation work shall be carried out from more than 5.0 M. lift in soft rock not requiring blasting.

2.0. Mode of Measurement & Payment

2.1. The relevant specifications of item No. 4.0.0.(A) shall be followed.

35

2.2. The rate shall be paid extra over and above the rate of item No. 4.0.0.2.(D) for carrying out excavation work for additional depth from 5 0.(M) and above.

2.3. The rates shall be for a unit of one cubic meter per meter

4.0.0.3.(E): Extra for additional depth more than 5.0 M. for excavation for foundation including sorting out and stacking of useful material disposing of excavated stuff up to 50 M. lead in hard rock.

1.0. Workmanship

1.1. The relevant specification of item No 4.0.0(E) shall be followed except that the excavation work shall be carried out from more than 50 m. lift in hard rock

2.0. Mode of Measurement & Payment

2.1. The relevant specifications of item No.4.0 O.(A) shall be followed.

2.2. The rates shall be paid extra over and above the rate of item No. 4.0.0 2.(E) for carrying out excavation work for additional depth from 5.0. M. and above.

2.3. The rate shall be unit of one cubic meter per meter

4.12. Filling available excavated earth (excluding rock) in trenches, plinth sides of foundations, etc., in layers not exceeding 20 CM. depth, consolidating each deposited layer by ramming and watering.

1.0. Workmanship

1.1. The earth to be used for filling shall be free from salts, organic or other foreign matter. All clods of earth shall be broken.

1.2. As soon as the work in foundation has been completed and measured the site of foundation shall be cleared of all debris, brick bats: mortar dropping etc., and filled with earth in layers not exceeding 20 cms. Each layer shall be adequately watered, rammed and consolidated before the succeeding layer is laid The earth shall be rammed with iron rammers where feasible and with the but ends of crow-bars, where rammer cannot be used.

1.3. The plinth shall be similarly filled with earth in layers not exceeding 20 cms. adequately watered and consolidated by ramming with iron or wooden rammers. When filling reaches finished level the surface shall be flooded with water for at least 24 hours and allowed to dry and then rammed and consolidated.

1.4. The finished level of filling shall be kept to shape intended to be given to floor.

1.5. In case off large heavy duty flooring like factory flooring, the consolidation may be done by power rollers, where so specified. The extent of consolidation required, shall also be as specified.

1.6. The excavated stuff of the selected type shall be allowed to be used in filling the trenches and plinth. Under no circumstances black cotton soil be used for filling the plinth.

2.0. Mode of Measurements & Payment

2.1. The payment shall be made for filling in plinth and trenches. No deduction shall be made for shrinkage or voids, if consolidated as instructed above.

2.2. The rate shall be for a unit of one cubic meter.

4.24. Filling in plinth with sand under floors including watering, ramming consolidating and dressing etc. complete.

1.0. Materials

1.1. Sand shall conform to M 6

2.0. Workmanship

The relevant specifications of item No. 4.12 shall be followed except that sand shall be filled in under floors, including watering, ramming, consolidating and dressing etc , complete.

3.0. Mode of Measurements & Payment

3.1. The relevant specifications of item No. 4.12 shall be followed.

3.2. The rate includes cost of collecting, carting sand with all lead and labour for filling the same in plinth under floors.

3.3. The rate shall be for a unit of one cubic meter.

4.0.0.4. Filling in foundation arid plinth with murrum or selected soil in layers of 20 cm. thickness including watering, ramming and consolidating etc., complete.

1.0. Materials

1.1. Murrum shall be clean, of good binding quality and of approved quality obtained from approved pots/ quarries of disintegrated rocks which contain silicon material and natural mixture of clay of clarions origin. The size of murrum shall not be more than 20 mm

36

2.0. Workmanship

2.1. The relevant specifications of item No. 4.12 shall be followed except that the murrum or selected soil shall be filled in foundations and plinth in 20 cms layer including consolidating, ramming, watering, dressing etc. complete

3.0. Mode of Measurements & Payment

3.1. The relevant specifications of item No. 4.12 shall be followed-

3.2. The rate includes cost of collecting and carting murrum / or selected earth of approved quality with all lead and labour required for filling in trenches and plinth.

3.3. Rate shall be for a unit of one cubic meter.

4.0.0.5. Filling in foundation and plinth with brick-bats / chhara in layers of 20 cms. thickness including watering, ramming and consolidating etc. complete.

1.0. Materials

Brick bats shall conform to M.14

2.0. Workmanship

The relevant specification of item No. 4.12 shall be followed except that brick bats of-burnt bricks shall be filled in foundation and plinth in 20 cms layer including watering, ramming, consolidating etc.,*complete.

3.0. Mode of Measurements & Payment

3.1. The relevant specification item No. 4 12 shall be followed.

3.2. The rate includes cost of collecting and carting brick bats/chhara with all lead and labour required filling in trenches and plinth.

3.3. The rate shall be for a unit of one cubic meter

4.27. Boring holes 3.5 M. deep in ordinary soil (for cast in situ piles) and getting out the soil disposal of the surplus excavated soil as directed within a lead of 50 M. for following diameter for piles, (i) 200 mm. (ii) 250 mm, (iii) 300 mm.

1.0. Workmanship

1.0. The ground shall be roughly leveled and after making the position of piles, the holes shall be bored with a spiral angle to the 3.5 M. depth and specified diameter using boring guide.

2.0. The bore holes shall be truly vertical and uniform bore through out of specified diameter, After boring to the required depth, the bore shall be cleared off the loose soil and disposal of surplus excavated stuff as directed within a lead of 50 M. . 2.0? Mode of Measurement & Payment

2.1. The rate for boring holes shall include :

(a) roughly leveling the ground in positions where piles are to be provided (b) Making the position of piles by pegs and boring guide and also for shifting of boring guide. (c) Bailing out water, if any met with during boring, (d) Disposal or surplus excavated soil within a lead of 50 M and (e) All tools, plants, equipments and labour required for satisfactory completion or. work.

2.2. The rate shall be for a unit of one Number.

4.28. Extra for under ramming inside the bore holes for under rammed piles of following nominal diameter :(i) 200 mm. (ii) 250, (iii) 300 mm.

1.0. Workmanship

The relevant specifications of item No. 4.27 shall be followed except that after boring to the required depth, the bore shall be enlarged at the bottom by an under rammer 2 to 2 1/2 times the diameter of the bore as directed It shall be ensured that the bore for the pile shall be enlarged to the correct diameter.

2.0. Mode of Measurement & Payment

2.1. The relevant specification of item No. 4.27 for under reaming the piles.

2.2. The rate shall be paid extra over and above the rate of item No. 4.27 for under ramming the piles.

2.3. The rate shall be for a unit of one number.

37

SECTION 5

Plain & RCC Work

5.1.6. Providing and laying in foundation and plinth/under floors lime concrete with hard broken aggregate 40 mm. nominal size and 40% mortar comprising of 1 Lime putty : 2 fine sand and curing complete excluding cost of form work.

1.0. Materials

Water shall conform to M-1. Sand shall conform to M-6 Lime shall conform to M-2. Graded aggregate 40 mm. nominal size shall conform to M-12

2.1. General

2.1.1. Before starting the concrete the bed of the foundation trenches shall be cleared of all loose materials and watered and rammed as directed.

2.2. Proportion of Mix

2.2.1. The proportion of lime, sand and aggregate shall be specified in the item of the work and shall be measured by volume.

2.2.2. The lime mortar shaft consist of proportion of 1 lime putty : 2 sand by volume. The lime mortar shall be prepared by wet process. Power driven mill shall be used for preparation of lime mortar. The slaked lime shall be placed in the mill in even layer and ground for 180 revolutions with sufficient water. The water shall be added as required during grinding and care shall be taken not to add more water so that it will bring the mixed materials to a consistency of stiff paste, thoroughly wetted sand shall then be added evenly and the mixture ground for another 180 revolutions.

2.2.3. Lime mortar shall be kept, protected from sun and rain till used-up, covering it by tarpaulin or open sheds.

2.2.4. All the lime mortar shall be used as soon as possible after grinding. It should be used on the day on which it is prepared but in no case mortar- made earlier than 36 hours shall be permitted for use.

2.3. Mixing:

2.3.1. The concrete shall be mixed in mechanical mixer. Mixing shall be continued until there is uniform distribution of the materials and the mass is uniform in colour and consistency but in no case mixing shall be done for less than 2 to 3 minutes.

2.4. Laying & Compacting:

2.4.1. The concrete shall always be used while quite fresh It shall be laid (not thrown) in layers not exceeding 150 mm. in thickness and shall be well and quickly rammed with wooden or iron rammers, till the required compaction is achieved. The concrete laid shall not be of too fluid consistency. After it has been mixed no more water shall be added, but the surface during and after compaction shall be kept damp. In laying consecutive layers, the layer cast shall be well watered and made rough before the upper layer is laid. The concrete shall be kept continuously wet for period of 7 days from the date of placing of until it- is built over whichever is more.

2.5. Mode of Measurement & Payment :

2.5.1. The concrete work shall be measured in length, breadth and depth as specified on drawing or as directed, correct up to nearest centimeter and cubical content shall be worked out nearest up to two places of decimals.

2.5.2. The rate shall be for unit of one cubic meter.

5.1.8. Providing and laying in foundation and plinth/under floors lime concrete with graded bricks aggregate 40 mm. nominal size and 40% mortar comprising of 1 lime putty : 2 fine sand and curing complete, excluding cost of form work.

1.0. Materials

1.1. Water shall conform to M-1. Lime mortar shall conform to M-10. Brick bats aggregate 40 mm. nominal sizes shall conform to M-14.

2.0. Workmanship

2.1. The relevant specification of item No. 5.1.6. shall be followed except that brick aggregate shall be used instead of graded stone aggregate.

3.0. Mode of Measurements & Payment

3.1. The concrete work shall be measured in length, breadth and depth as specified in drawing or as directed. Correct up to nearest centimeter and cubical content shall be worked out up to two places of decimals.

3.2. The rate shall be for a unit of cubic meter.

38

5.3.2.(A) Providing and laying cement concrete 1.3.6. (1 cement : 3 coarse sand : 6 graded stone aggregate 40 mm. nominal size) and curing complete excluding the cost of form work in foundations and plinth.

1.0. Materials

1.1. Water shall conform to M-1. Cement shall conform to M-3 Sand shall conform to M-6. Stones aggregate 40 mm. nominal size shall conform to M-12.

2.0. Workmanship

2.1. General

2.1.1. Before stating concrete the bed of foundation trenches shall be cleared of all loose materials, leveled, watered and rammed as directed

2.2. Proportion of Mix:

2.2.1. The proportion of cement, sand and coarse aggregate shall be one part of cement. 3 parts of sand and 6 parts of stone aggregates and shall be measured by volume.

2.3. Mixing:

2.3.1. The concrete shall be mixed in a mechanical mixer at the site of work. Hand mixing may however be allowed for smaller quantity of work if approved by the Engineer-in-charge. When hand mixing is permitted by the Engineer-incharge

in case "of break-down of machineries and in the interest of the work, it shall be carried out on a water tight platform and care shall be taken to ensure that mixing is continued until the mass is uniform in colour and consistency, However in such case 10% more cement than otherwise period 1 1/2 to 2 minutes. The quantity of water shall be just sufficient to produce a dense concrete of required workability for the purpose.

2.4. Transporting & Placing the Concrete:

2.4.1. The concrete shall be handed from the place, of mixing to the final position in not more than 15 minutes by the method as directed and shall be placed into its final-position, compacted and finished within 30 minutes of mixing with water i.e. before the setting commences.

2.4.2. The concrete shall be laid in layers of 15 cms. to 20 cms.

2.5.1. The concrete shall be rammed with heavy iron rammers and rapidly to get the required compaction and to allow all the interstices to be filled with mortar.

2.6. Curing:

2.6.1. After the final set, the concrete shall be kept continuously wet if required by ponding for a period of not less than 7 days from the date of placement.

2.7. Mode of Measurement & Payment:

2.7.1. The concrete shall be measured for its length, breadth and depth, limiting dimensions to those specified on plan or as directed.

2.7.2. The rate shall be for a unit of one cubic meter.

5.3.3.(A) Providing and laying cement concrete 1:4:8 (1 cement: 4 coarse sand : 8 graded stone aggregate 40 mm. nominal size) and curing complete, excluding cost of form work in foundations and plinth.

1.0. Materials

1.1. Water shall conform to M-1. Cement shall conform to M-3. Sand shall conform to M-6 stone aggregate 40 mm. nominal size shall conform to M-12.

2.0. Workmanship

2.1. Relevant Specifications of item No. 5.3.2. shall be followed except that cement concrete shall be mixed in the preparation of 1:4:8 instead of 1:3.6 by volume.

3.0. Mode of measurement and payment

3.1. The concrete shall be measured for its length, breadth and depth, limiting dimensions to those specified on plans or as directed

3.2. The rate shall be for a unit of one cubic meter

5.3.14.(A) Providing and laying cement concrete 1.3.6 (1 cement : 3 coarse sand : 6 crushed stone aggregate 20 mm. nominal size) and curing complete including cost of form work in wall caps/coping.

1.0. Material & Workmanship

1.1. The relevant specification of item No. 5.3.2. (A) shall be followed except that the work shall be carried out for coping and wall caps, except the stone aggregate 20 mm. nominal size shall be used. The concrete work of wall caps/coping.

2.0. Mode of measurements and payment

2.1. The relevant specification of item No. 5.3.2. (A) shall be followed except that the rate includes cost of necessary form work.

39

2.2. The rate shall be for a unit of one cubic meter.

5.3.3. Providing and laying brick bats cement 1:4:8 (1 cement : 4 coarse sand : 8 graded bricks bats), and curing complete excluding the cost of form work in foundation and plinth.

1.0. Materials

1.1. Water shall conform to M-1 Cement shall conform to M-3. Sand shall conform to M-6 Brick bat shall conform to M-14

2.0. Workmanship

2.1. The specification of this item shall be followed as per item No 5.3.14 (A) except that the proportion of brick bat cement concrete shall be 1 4:8 i e 1 part of cements 4 part of coarse sand and 8 parts of graded brick bat by volume, using graded brick bat as coarse aggregate instead of stone aggregates

3.0. Mode of Measurements & Payment

3.1. The concrete work shall be measured in length, breadth and depth as specified on drawing limiting dimensions to those specified on drawings or as directed.

3.2. The rate shall be for a unit of one cubic meter.

5.3.4.(A) Providing and laying cement concrete 1:5:10 (1 cement : 5 coarse sand : 10 graded stone aggregate 40 mm. nominal size) and curing complete, excluding the cost of form work, for foundation and plinth.

1.0. Materials

1.1. Water shall conform to M-1. Cement shall conform to M-3 Sand shall conform to M-6 Stone aggregate 40 mm nominal size shall conform to M-12.

2.0. Workmanship

2.1. The relevant specification of item No. 5.3.2. (A) shall be followed for the work except that the work is to be carried out in cement concrete 1:5:10

3.0. Mode of Measurement & Payment

3.1. The concrete shall be measured for its length, breadth and depth, limiting dimensions to those specified on plans or as directed.

3.2. The rate shall be for a unit of one cubic meter.

5.3.8.(A) Providing and laying cement concrete 1:5:10 (1 cement : 5 coarse sand : 10 graded brick bats 10 mm. nominal size) and curing complete excluding, cost of form work in foundation and plinth.

1.0. Materials

1.1. Water shall conform to M-1 Sand shall conform to M-6 Cement shall conform to M-3. Brick bats shall conform to M-14.

2.0. Workmanship

2.1. The relevant specification of item No 5.3.4 shall followed except that brick bats aggregate shall be used instead of stone aggregate.

3.0. Mode of Measurement & Payment

3.1. The relevant specification of item No 5.3.4 shall be followed

3.2. The rate shall be for a unit of one cubic meter

5.3.2.(B) Providing and laying brick bat cement concrete 1:3:6 (1 cement : 3 coarse sand : 6 graded brick bats) and curing complete excluding cost of form work in foundation and plinth.

1.0. The specification of item No 5.3.2 (A) shall be followed except that the brick bats shall be used as coarse aggregate instead of stone aggregates.

2.0. Mode of Measurement & Payment

2.1. The relevant specification of item No 5.3.5 (A) shall be followed for mode of measurements and payment except that it excludes the cost of form work.

2.2. The rate shall be for a unit or one cubic meter.

5.4.18. Providing throating or plaster drip and molding to R.C.C. Chhajas.

1.0. Materials

Water shall conform to M-1. Cement shall conform to M-3. Sand shall conform to M-6 Cement mortar shall conform to M-11

2.0. Workmanship

2.1. The work shall be carried out as directed. The proportion of mix for finishing shall be in C.M. 1:2 by volume. Curing shall be done for not less than 7 days. The work shall be carried out in best workman like manner. The throating or plaster drip and mounding shall be one centimeter in thickness.

40

5.7.5. Extra for providing and mixing Water Proofing material in cement concrete in mix proportions recommended by the manufacturers.

2.0. Workmanship

2.1. The proportions of materials for the cement concrete shall be mentioned with the specifications of that item. The quantity of water proofing materials to be added and the method of addition shall be as specified by manufacturers.

2.2. Mixing:

2.2.1. The mixing of the water proofing materials in cement, water or concrete shall be done according to the specifications of the manufacture.

3.0. Mode of Measurements and Payment

3.1. The payment is extra over and above the rate of concrete for mixing water proofing proper.

3.2. The rate shall be for a unit of one lithe or kg. per quintal of cement in which water proofing material is added.

5.7.1. Providing and laying damp proof course 25 mm. thick cement concrete 1:2:4 (1 cement : coarse sand :4 stone aggregate 10 mm. nominal size) and curing complete.

1.0. The specifications of item No. 5.3.13. (A) of ordinary concrete with or without reinforcement shall be followed except that the size of the stone aggregate shall be 10 mm nominal size and the concrete work shall be carried out in 25 mm. thick damp proof course

2.0. Mode of measurements & payment

2.1. The rate includes cost of all materials and labour required to complete the item

2.2. The rate shall be for a unit one sq. meter.

5.3.13. Providing and laying cement concrete 1:2:4 (1 cement : 2 coarse sand : 4 graded stone aggregate 20 mm. nominal size) and curing complete excluding cost of form work in (A) foundation and plinth, (B) Independent piers, columns and pillars up to floor two level.

1.0. Materials

Water shall conform to M-1. Cement shall conform to M-3. Sand shall conform to M-6. Grit shall conform to M-8. Graded stone aggregate 20 mm nominal size shall conform to M-12.

2.0. General

2.1. The concrete mix is not required to be designed by preliminary testes. The proportion of the concrete mix shall be 1:2:4 (1 cement : 2 coarse sand : 4 graded stone aggregate 20 mm. nominal size) by volume concrete work shall have exposed concrete surface or as specified in the item

2.2. The designation ordinary M-100, M-150m M-200, M-250 specified as per I.S. correspond approximately to 1:3:6, 1:2:4, 1:1:1/2:3 and 1:1:2 nominal mix of ordinary concrete by volume respectively

2.3. The ingredients required for ordinary concrete containing one beg of cement of 50 kg. by weight (0.0342 Cu M.) for different proportions of mix shall be as under:

Grade of concrete Total quantity of dry aggregate

by volume per 50 kgs. of cement

to be taken as the sum of

individual volume of fine and coarse aggregates, maximum

Proportion of fine aggregate to

coarse aggregate

Quantity of water per

50 Kgs. of cement

maximum

1 2 3 4

M-100 (1:3:6)

M-150 (1:2:4)

M-200 (1:1. 1/2:3)

M-250 (1:1:2)

300 Liters

220 Liters

100 Liters

Generally 1:2 for line aggregate

to coarse aggregate by volume

160 but subject to an upper limit

of 1:1. 1/2 and lower limit

34 Liters

32 Liters

30 Liters

1:3 27 Liters

2.4. The water cement ratios shall not be more than specified in the above table. The cement content of the mix specified in the table shall be increased if the quantity of water in mix has to be met eased to overcome the difficulties of placements and compaction so that the water-cement ratio specified in the table is not exceeded.

2.5. Workability of the concrete shall be controlled by maintaining a water -cement-ratio that is found to give a concrete mix which is just sufficient wet to be placed and compacted without difficulty with the means available.

2.6. The maximum size of course aggregate shall be as large as possible within the limits specified but in no case greater than one forth of the minimum thickness of the member provided that the concrete can be placed without difficulty so as to surround all reinforcement thoroughly and to fill the corners of the form.

41

2.7. For reinforced concrete work; coarse aggregates having a nominal size of 20 mm. are generally considered satisfactory.

2.8. For heavily reinforced concrete members as in the case of ribs of main beams, the nominal maximum size of coarse aggregate should usually be restricted to 5 mm. less than the minimum clear distance between the main bar or 5 mm. less than the minimum cover to the reinforcement whichever is smaller.

2.9. Where the reinforcement is widely spaced as in solid slabs, limitations of size of the aggregate may not be so important, and the nominal maximum size may some times be as great as or greater than the minimum cover.

2.10. Admixture maybe used in concrete only with approval of Engineer-in-charge based upon the evidence that with the passage of time neither the compressive strength of concrete is reduced not are other requisite qualities of

concrete and steel impaired by the use of such admixtures.

3.0. Workmanship

3.1. Proportioning : Proportioning shall be done by volume, except which shall be measured in terms of bags of 50 kg. weight, the volume of one such bag being taken as 0.0342 cu. meter Boxes of suitable size shall be used for measuring sand aggregate. The size of boxes (internal) shall be 35 x 25 cms. and 40 cms deep while measuring the aggregate and sand the boxes shall be filled without shaking ramming or hammering. The proportioning of sand shall be on the basis of its dry volume and in case of damp saner, allowances for bulk age shall be made.

3.2. Mixing :

3.2.1. For all work, concrete shall be mixed in a mechanical mixed which along with other accessories shall be kept in first class working condition and so maintained throughout the construction Measured quantity of aggregate, sand and cement required for each batch shall be poured into the claim of the mechanical mixer while it is continuously running. After half a minute of dry mixing measured quantity of water required for each batch of concrete mix shall be added gradually and mixing continued for another one and a half minute Mixing shall be continued till materials are uniformly distributed and uniform colour of the entire mass is obtained and each individual particle of the coarse aggregate shows complete coating of mortar containing its proportionate amount of cement. In no case shall the mixing be done for less than 2 minutes after-oil ingredients have been put into the mixer.

3.2.2. When hand mixing is permitted by the Engineer-in-charge for small jobs or for certain other reasons, it shall be done on the smooth watertight platform large enough to allow efficient tuning over the ingredients of concrete before and after adding water Mixing platform shall be so arranged that no foreign material gets mixed with concrete nor does the mixing water flow out. Cement in required number of bags shall be spread in a layer of uniform thickness on the mixing platform. Dry coarse and fine aggregate and cement shall then be mixed thoroughly by turning over to get a mixture to uniform colour. Specified quantity water shall then be added gradually through a rose can and the mass turned over till a mix of required consistency is obtained. In hand mixing quantity of cement shall be increased by 10 percent above that specified

3.2.3. Mixers which have been out of use for more than 30 minutes shall be thoroughly cleaned before putting in a new batch. Unless otherwise agreed to by the Engineer in-charge the first batch of concrete from the mixture shall contain only two thirds of normal quantity of coarse aggregate Mixing plant shall be thoroughly cleaned before changing from one type of cement to another

3.3. Consistency:

3.3.1. The degree of consistency which shall depend upon the nature of the work and methods of vibration of concrete, shall be determined by regular slump tests in accordance with I.S. 1199-193. The slump of 10 mm. to 25 mm shall be adopted when vibrators are used and 80 mm. when vibrators are not used.

3.4. Inspection:

3.4.1. Contractor shall give the Engineer-in-charge due notice before placing any concrete in the forms to permit him to inspect and accept the false work and forms as to their strength, alignment and general fitness but such inspection shall not relieve the contractor of his responsibility for the safety of men machinery materials and for results obtained immediately before concreting all forms shall be thoroughly cleaned.

3.4.2. Centering design and its erection shall be got approved from the engineer-in-charge. One carpenter with helper shall invariably be kept present throughout the period of concreting. Movement of labour and other persons shall be totally prohibited for reinforcement laid in position. For access to different parts suitable mobile platforms shall be provided so that steel reinforcement in position is not disturbed. For ensuring proper cover, mortar blocks of suitable size shall be cast and tied to the reinforcement. Timber kapachi or metal pieces shall not be used for this purpose.

3.5. Transporting and laying:

3.5.1. The method of transporting and placing concrete shall be as approved. Concrete shall be so transported and placed that no contamination, segregation or loss of its constituent material takes place. All form work shall be cleaned and made free from standing water dust, snow or ice immediately before placing of concrete. No concrete

42

shall be placed in any part of the structure until the approval of the engineer-in-charge has been obtained.

3.5.2. Concreting shall proceed continuously over the area between construction joints. Fresh concrete proper contraction joint is formed. Concrete shall be compacted in its final position within 30 minutes of its discharge from the mixer. Except where otherwise agreed to by the engineer-in-charge, concrete shall be deposited in horizontal layers to a compacted depth of not more than 0.45 meter when internal vibrators are used and not exceeding 0.30 meter in all other cases.

3.5.3. Unless otherwise agreed to by the Engineer-in-charge concrete shall be dropped in to place from a height exceeding 2 meters. When trucking or chutes are used they shall be kept close and used in such a way as to avoid segregation. When concreting has to be resumed on a surface which has hardened, it shall be roughened, swept clean, thoroughly wetted and covered with a 13 mm. thick layer of mortar composed of cement and sand in the same ratio as in the concrete mix itself. This 13 mm. layer of mortar shall be freshly mixed and placed immediately before placing of new concrete. Where concrete has not fully hardened, all laitance shall be removed by scrubbing the wet surface with wire or bristle brushes, care being taken to avoid dislodgement of any particles of coarse aggregate. The surface shall then be thoroughly wetted, all free water removed and then coated with neat cement grout. The first layer of concrete to be placed on this surface shall not exceed 150 mm. in thickness and shall be well rammed against old work, particular attention being given to corners and close spots.

3.5.4. All concrete shall be compacted to produce a dense homogeneous mass with the assistance of vibrators, unless otherwise permitted by the Engineer-in-charge for exceptional cases, such as concreting under water, where vibrators cannot be used. Sufficient vibrators in serviceable condition shall be kept at site so that spare equipment is

always available in the even of breakdowns. Concrete shall be judged to be compacted when the mortar fills the spaces between the coarse aggregate and begins to cream up to form an even surface. Compaction shall be completed before the initial setting starts i.e. within 30 minutes of addition of water to dry mixture. During compaction, it shall be observed that needle vibrators are not applied on reinforcement which is likely to destroy the bond between concrete and reinforcement.

3.6. Curing:

Immediately after compaction, concrete weather including rain, running water, shocks, vibration, traffic, rapid temperature changes, frost and drying out process. It shall be covered with wet sacking or other similar absorbent material approved, soon after the initial set, and shall be kept continuously wet for a period of not less than 14 days from the date of placement. Masonry work over foundation concrete may be started after 48 hours of its laying but curing of concrete shall be continued for a minimum period of 14 days.

3.7. Sampling and testing of concrete:

3.7.1. Samples from fresh concrete shall be taken as per I.S. 1199-1959 and cubes shall be made, cured and tested at 7 days and 28 days as per requirements in accordance with I.S. 526-1959. A random sampling procedure shall be adopted to ensure that each concrete batch shall have a reasonable chance of being tested i.e. the sampling should be spread over the entire period of concreting and cover all mixing units. The minimum frequency of sampling of concrete of each grade shall be in accordance with following:

Quantity of concrete in the work. No of samples

1-5 cmt. 1

6-15 cmt. 2

16-30 cmt. 3

31-50 cmt. 4

51 and above 4+

one additional for each additional 50 mm. or part thereof.

Note : At least one sample shall be taken from each shift, Ten test specimens shall be made from each sample, five for testing at 7 days and the remaining five at 28 days. The samples of concrete shall be taken on each day of concreting as per above frequency. The number of specimens may be suitably increased as deemed necessary by the Engineer-in-charge when procedure of tests given above reveals a poor quality of concrete and in other special cases.

3.7.2. The average of the group of cubes cast for each day shall not be less than the specified cube strength of 150 K/g Cm² at 28 days. 20% of the cubes cast for each day may have value less than the specified strength provided the lowest value is not less than 85% of the specified strength. If the concrete made in accordance with the proportions given for a particular grade does not yield the specified strength, such concrete shall be classified as belonging to the appropriate lower grade. Concrete made in accordance with the Proportions given for a particular grade shall not, however be placed in a higher grade on the ground that the test strength are higher than the minimum specified.

3.8. Stripping:

3.8.1. The Engineer-in-charge shall be informed in advance by the contractor of his intention to strike the form work. While fixing the time of removal of form work, due consideration shall be given to local conditions, 43

character of the structure, the weather and other conditions that influence the setting of concrete and of the materials used in the mix. In normal circumstances (generally where temperatures are above 20°C) and where ordinary concrete is used, forms may be struck after periods specified in item No.9.1 (A) for respective item of form work.

3.8.2. All form work shall be removed without causing any shock or vibration as would damage the concrete. Before the soft and struts are removed, the concrete surface shall be gradually exposed, where necessary in order to ascertain that concrete has sufficiently hardened. Centering shall be gradually and uniformly lowered in such a manner as to permit the concrete to take stresses due to its own weight uniformly and gradually. Where internal metal tiles are permitted, they or their removable parts shall be extracted without causing any damage to the concrete and remaining holes filled with mortar. No permanently embedded metal part shall have less than 25 mm. cover to the finished concrete surface. Where it is intended to re-use the form work, it shall be cleaned and made good to the satisfaction of the Engineer-in-charge. After removal of form work and shutting, the Executive Engineer shall inspect the work and satisfy by random checks that concrete produced is of good quality.

3.8.3. Immediately after the removal of forms, all exposed bolts etc. passing through the cement concrete member and used for shuttering or any other purpose shall be cut inside the cement concrete member to a depth of at least 25 mm. below the surface of the concrete and the resulting holes be filled by cement mortar, all fins, caused by form joints, all cavities produced by the removal of form tiles and all other holes and depressions, honeycomb spots, broken edges or corners and other defects, shall be thoroughly cleaned, saturated with water and carefully pointed and rendered true with mortar of cement and fine aggregate mixed in proportions used in the grade of concrete that is being furnished and of as dry consistency as is possible to use. Considerable pressure shall be applied in filling and pointing to ensure thorough filling in all voids. Surface which are pointed shall be kept moist for a period of 24 hours. If rock pockets/honeycombs in the opinion of the Engineer-in-charge are of such an extent or character as to effect the strength of the structure materially or to endanger the life of the steel reinforcement, he may declare the concrete defective and require the removal and replacement of the portions of structure affected.

4.0. Mode of Measurement & Payment

4.1. The consolidated cubical contents of concrete work as specified in item shall be measured. No deduction shall be made for

(a) Ends of dissimilar materials such as joints, beams, posts, girders, gables, purling trusses, corbels and steps etc., up to 500 Sq. Cm. in section.

4.2. The rate includes cost of all materials labour, tools and plant required for mixing, placing in position, vibrating

and compacting, finishing, as directed, curing and all other incidental expenses for producing centre of specified strength. The rate excludes the cost of form work.

4.3. The rate shall be for a unit of one cubic meter.

5.4.1. Providing and laying cement concrete 1:2:4 (1 cement : 2 coarse sand : 4 graded stone aggregate 20 mm. nominal size) and curing complete excluding cost of form work and reinforcement for reinforced work in : (A) Foundations, footing base of columns and mass concrete. (C) Slabs, landings, shelves, balconies, lintels, beams, girders and cantilever up to floor two level. (D) Columns, pillars, pots, and struts up to floor up to floor two level (E) Staircase up to floor two level (K) Vertical and horizontal fins up to floor two level.

1.0. Materials & Workmanship

1.1. The relevant specifications of item No. 5.3.13 shall be followed except that the work shall be carried out for reinforced concrete work for work as specified in item 1.2. In addition, the following stipulations shall be followed for:

(a) The bars shall be kept in position by the following methods :

(i) In case of beam and slab construction, sufficient number of precast cover blocks in cement mortar 1:2 (1 cement : 2 coarse sand) about 4 cms. x 4 cms. section and of thickness equal to the specified cover shall be placed between the bars and shuttering as to secure and maintain the requisite cover of concrete over the reinforcement. In case of cantilevered or doubly reinforced beams or slabs, the main reinforcing bars shall be held in position by introducing chain spacers or supports bars at 1.0 to 1.2 meter centers.

(ii) In case of columns and walls, the vertical bars shall be kept in position by means of timber templates with slots accurately cut in them, the templates shall be removed after concreting has been done below it. The bars may also be suitably tied by means of annealed steel wires to the shuttering to maintain their position during concreting.

1.2. AH bars projecting from pillars, columns, beams, slabs etc, to which other bars and concrete are to be attached or bounded to later on, shall be protected with a coat of thin neat cement grout, if the bars are not likely to be incorporated with succeeding mass of concrete within the following 10 days. This coat of thin neat cement shall be removed before concreting.

2.0. Mode of Measurement & Payment

2.1. The relevant specifications of item No. 5.3.13 shall be followed.

44

2.2. The volume occupied by reinforcement shall not be deducted from R.C.C. work.

2.3. The rate shall be for a unit of one cubic meter.

5.4.4. Providing and laying cement concrete 1:2:4 (1 cement : 2 coarse sand : 4 graded stone aggregate 20 mm. nominal size) for reinforced concrete chhajjas not exceeding 10cms. thickness up to floor two level including finishing the exposed surface with cement mortar 1:3 (1 cement : 3 fine sand) to give a smooth and even surface, centering and form work and curing complete excluding cost of reinforcement.

1.0. Materials & Workmanship

1.1. The cement mortar shall conform to m-11.

1.2. The relevant specification of item No. 5.3.13 and 5.4.1 shall be followed except that the work shall be carried out for reinforced concrete chhajjas not exceeding 10 cms. in thickness.

1.3. The specifications for form work and centering shall be as per item No. 9.1.

1.4. The finishing work in cement mortar 1:3 (1 cement : 3 fine sand) shall be carried out as per specifications of item No. 17.49 (l), Before the plastering is done, the surface of the concrete shall be raked for proper bond.

2.0. Mode of measurements & payment

2.1. The relevant specification of item No. 5.3.13 and 5.4.1 shall be followed except that the work of chhajjas up to 10 cms. shall be earned out including centering form work and finishing the surface with cement mortar 1:3 (1 cement : 3 fine sand).

2.2. The rate shall be for a unit of one cubic meter,

5.4.10. Providing an Mild Steel reinforcement for R.C.C. work including bending binding and placing in position etc. complete up to floor two level.

1.0. Materials

1.1. Mild Steel bars shall conform to M-18. Mild steel binding wires shall conform to M-21.

2.0. Workmanship

2.1. The work shall consist of furnishing and placing reinforcement to the shape and dimensions shown as on the drawings or as directed

2.2. Steel shall be clean and free from rust and loose mill scale at the time of fixing in position and subsequent concreting.

2.3. Reinforcing steel shall conform accurate to the dimensions given in the bar bending schedules shown on relevant drawings. Bars shall be bent cold to specified shape and dimensions or as directed, using a proper bar bender, operated by hand or power to attain proper radius of bends. Bars shall not be bent or straightened in a manner that will injure the material. Bars bent during transport or handling shall be straightened before being used on the work. They shall not be heated to facilitate bending Unless otherwise specified a "U" type hook at the end of each bar shall invariably be provided to main reinforcement. The radius of the bend shall not be less than twice the diameter of the round bar and the length of the straight part of the bar beyond the end of the curve shall be at least four times the diameter of the round bar. In case of bars which are not round and in case of deformed bars, the diameter shall be taken as the diameter of circle having an equivalent effective area. The hooks shall be suitably encased to prevent any splitting of the concrete.

2.4. All the reinforcement bars shall lie accurately placed in exact position shown on the drawings, and shall be

securely held in position miring placing of concrete by annealed binding wire not less than 1 mm in size, and by using stay blocks or metal chair spacers, metal hangers supporting wires or other approved devices at sufficiently close intervals, Bars shall not be allowed to sag between supports nor displaced during concreting or any other operations of the work. All devices used for positioning shall be of non-corrodible material. Wooden and metal supports shall not extend to the surface of concrete, except where shown on drawings. Placing bars on layers of freshly laid concrete as the work progresses for adjusting bar spacing shall not be allowed Pieces of broken stone of brick and wooden blocks shall not be used Layers of bars snail be separated by spacer bars, precast mortar blocks or other approved devices Reinforcement after being placed in position shall be maintained in a clean condition until completely embedded in concrete. Special care shall be exercised to prevent any displacement of reinforcement in concrete already placed. To prevent reinforcement form corrosion, concrete cover shall be provided as indicated on drawings. All the bars protruding from concrete and to which other bars are to be sliced and which are likely to be exposed for a period exceeding 10 days shall be protected by a thick coat of neat cement grout.

2.5. Bars crossing each other where required shall be secured by binding wire (annealed) of size not less than 1 mm. in such a manner that they do not slip over each other at the time of fixing and concreting.

2.6. As far possible, bars of full length shall be used. In case this is not possible. Over lapping of bars shall be done as directed When practicable, overlapping bars shall not touch each other, but be kept apart by 25 them. Where not feasible, overlapping bars shall be bound with annealed wires not less than 1 mm. thick

45

twisted tight. The overlaps shall be staggered for different bars and located at points, along the span where neither shear non bending moment is maximum.

2.7. Whenever indicated on the drawings or desired by the Engineer-in-charge, bars shall be jointed by couplings which shall have a cross-section sufficient to transmit the full stresses of bars. The ends of the bars that are joined by coupling shall be upset for sufficient length so that the effective cross section at the base of threads is not less than the normal cross-section of the bar. Threads shall be standard threads Steel for coupling shall conform to I.S. 226.

2.8. When permitted or specified on the drawings, joints of reinforcement bars shall bull- welded so as to transmit their full stresses. Welded joints shall preferably be located at points when steel will not be subject to more than 75 percent of the maximum permissible stresses and welds so staggered that at any one section not more than 20 percent of the rods are welded. Only electric arc welding using a pieces which excludes air from the molten metal and conforms to any or all other special provisions for the work shall be accepted. Suitable means shall be provided for holding bars securely in position during welding. It shall be ensured that no voids are left in welding and when welding is done in tow or three stages, previous surface shall be cleaned properly. Ends of the bars shall be cleaned of all loose scale, rust, stages, paint and other foreign matter before welding. Only competent welders shall be employed on the work. The M.S. electrodes used for welding shall conform to I.S. 814. Welded pieces of reinforcement shall be tested. Specimen shall be taken from the actual site and their number and frequency of test shall be as directed.

3.0. Mode of Measurements & Payment

3.1. For the purpose of calculating consumption, wastage shall not be permitted beyond 5 percent Excess consumption over 5% will be charged at penal rate.

3.2. Reinforcement shall be measured in length including overlaps, separately for different diameters as actually used in the work. Where welding or coupling is resorted to in place lap joints, such joints shall be measured for payment as equivalent length of overlap as per design requirement. From the length so measured, the weight of reinforcement shall be calculated in tones on the same basis of as per M-18 even though steel is supplied to the contractor by the department on actual weight. Length shall include hooks at the ends Wastage and annealed steel wire for binding shall not be measured and the cost of these items shall be deemed to be included in the rate for reinforcement.

3.3. The rate for reinforcement includes cost of steel binding wires. its carting from Department store to work site, cutting, bending, placing, binding and fixing in position as shown on the drawings and as directed It shall also include all devices for keeping reinforcement in approved position, cost of joining as per approved method and all wastage and spacer bars.

3.4. The rate shall be for a unit of One Kg.

5.4.11. High yield deform bars steel reinforcement for R.C.C. work including bending, binding and placing in position complete up to floor two level.

1.0. Materials

1.1. Cold twisted steel bars (high yield strength deformed bars) shall conform to M.19 Mild steel binding wires shall conform to M-21.

2.0. Workmanship

2.1. The specifications of item No. 5.4.10 shall he followed except that the cold twisted steel bars shrill be used with or without hooks at the ends. Deformed .bars without hooks shall, however, comply with relevant anchorage requirements

3.0. Mode of Measurement & Payment

3.1. The relevant specifications of item No. 5.4.10 shall be followed

3.2. The rate shall be for a unit of One kg

5.4.13. Extra for additional lift of concrete for all R.C.C. work above floor two level excluding cost of reinforcement.

1.0. Materials & Workmanship

The relevant specifications for item No. 5.4.1 shall be followed for the work except that the R.C.C. work shall be done for ground floor i.e. above plinth level to first floor level.

2.0. Mode of Measurement & Payment

2.1. The relevant specifications of item No. 5.4 1 shall be followed except that rate shall be for extra lift above plinth to floor two level over and above the rate of concrete at floor two level.

2.2. The rate shall be for a unit of one cubic meter per floor.

5.4.13.(A) Extra for additional lift of reinforcement steel for all R.C.C. work above floor two level.

1.0. Materials & Workmanship

1.1. The relevant specifications of item No. 5.4.10 as may be applicable, shall be followed except that the work shall be carried out above floor two level for each floor

2.0. Mode of measurement & payment

2.1. The relevant specifications of item No. 5.4.10 o4 5.4.11 as may be applicable shall be followed except 46

that the work shall be carried out above floor tow level.

2.2. The rate shall be for a unit of one kg. per floor.

5.6.2. Providing up to floor two level precast cement concrete or grill 1:2:4 (1 cement : 2 coarse sand : 4 graded stone aggregate 6 mm: nominal size) reinforced with 1.6 mm. dia mild steel size wire including roughening, cleaning fixing and finishing in cement mortar 1:3 and curing complete.

(A) 50 mm. thick (B) 40. mm. thick (C) 25. mm. thick (E) 100 mm. thick.

1.0. Materials

1.1. Water shall conform to M-1. Cement shall conform to M-3. Sand shall conform to M-6. Mortar shall conform to M-11. Aggregates shall conform to M-12. Mild steel wire shall conform to M-21. Shattering shall conform to M-26.

2.0. Workmanship

It shall be cement concrete 1:2:4 (1 cement : 2 coarse sand : 4 graded stone aggregate 6 mm. nominal size), reinforced with 1.6. mm. dia mild steel wire unless otherwise specified. The thickness of the jali shall be as specified in the item. The jali shall be set in position true to line and level before the jambs sills and soffits to the opening are plastered. It shall then be properly cemented with cement mortar 1:3 (1 cement : 3 sand) and rechecked for levels. Finally the jambs, sills and soffits shall be plastered gripping the jali uniformly on all sides.

3.0. Mode of measurement of payment

3.1. The item shall be measured in square meter.

3.2. The rate shall be for a unit of one square meter,

5.8.1. Providing and laying controlled concrete M-150 and curing complete excluding the cost of form work and reinforcement for reinforced concrete work in:

(A) Foundation, footings, base of columns, and mass concrete, (B) Walls from top of foundation/level up to floor two level. (C) Slabs, pillars, posts and struts, up to floor two level (E) Staircase up to floor two level. (F) Vertical and horizontal fins up to floor two level.

1.0. Materials

1.1. Water shall conform to M-1. Cement shall conform to M-3. Sand shall conform to M-6. Grit shall conform to M-8 Course aggregate shall conform M-12.

2.0. General

2.1. The relevant specification of item No. 5.4.1. of ordinary concrete shall be followed except that the concrete mix shall be designed form preliminary tests. The proportioning of cement and aggregates shall be done by weight and necessary precautions shall be taken in the production to ensure that the required work cube strength is attained and maintained. The controlled concrete shall be in grades of M-100, M-150, M-200, M-250, M-300, M-350 & M-400 with prefix controlled added to it. The letter M refers to mix and the numbers specify 28 days works cube compressive strength of 150 mm. cubes of the mix expressed in Kg./Crnt.

2.2. The proportion of cement, sand and coarse aggregate shall be determined of weight. The weight batch machine shall be used for maintaining proper control over the proportion of aggregates as per mix design. The strength requirements of different grades of concrete shall be as under:

Grade

Concrete

Compressive strength of 15 cms. cubes in Kg./Cmt. at 28 days, conducted in accordance with I.S. 516-1959.

Preliminary test Min.

Work test Min.

M-1 50 200 150

M-200 260 200

M-250 320 250

M-300 380 300

M-350 440 350

M-400 500 400

In all cases, the 28 days compressive strength specified in above be the criteria for acceptance or rejection of the concrete. Where the strength of a concrete mix as indicated by tests, lies in between the strength of any two grades specified in the above table, such concrete shall be classified in for purpose as concrete belonging to the lower of the grades between which its strength lies.

3.0. Workmanship

3.1. The proportions for ingredients chosen shall be such that concrete has adequate workability for conditions prevailing on the work question and can be property compacted with means available except where ft can be shown to the satisfaction of the Engineer-in-charge, that supply of properly graded aggregate of uniform quality can be

maintained till the completion of work, grading of aggregate shall be controlled by obtaining the coarse aggregates in different sizes and bending them in the right proportions as required. Aggregates of different sizes shall be

47

stocked in separate stock piles. The required quantity of material shall be stock piled several hours, preferably a day before use. The grading of coarse and fine aggregate shall be checked as frequently as possible, the frequency for a given job being determined by Engineer-in-charge to ensure that the suppliers are maintaining the uniform grading as approved for samples used in the preliminary tests..

3.2. In proportioning concrete, the quantity of both cement and aggregate shall be determined by weight. Where the weight of cement is determined by accepting the maker's weight per bag, a reasonable number of bags shall be weighted separately to check the net weight. Where cement is weighted from bulk stocks at site and not by bags, it shall be weighed separately from the aggregate. Water, shall either be measured by volume in calibrated tanks or weighed. All measuring equipment shall be maintained in clean, and serviceable condition. Their accuracy shall be periodically checked.

3.3. It is most important to keep the specified water cement ratio constant and at its correct value. To this end, moisture content in both fine and coarse aggregates shall be determined by the Engineer-in-charge according to the weather conditions. The amount of mixing water shall then be adjusted to compensate for variations in the moisture content. For the determination of moisture content in the aggregates. I.S. 2386 (Part-III) shall be referred to. Suitable adjustments shall also be made in the weights of aggregates due to variation in their moisture content. Minimum quantity of cement to be used in controlled concrete shall not be less than 220 kg./M-3 in plain concrete and not less than 250 kg/M-3 in reinforced concrete.

4.0. Mode of measurement & payment

4.1. The relevant specifications of item No.5.4.1 shall be followed, except that the controlled concrete R.C.C. work as specified in item shall be measured under this item. The rate excludes cost of form work.

5.8.2. Providing and laying controlled cement concrete M-200 and curing complete, excluding the cost of form work and reinforcement for reinforced concrete work in :

(A) Foundations, footings base of columns, and mass concrete. (B) walls from top of foundation up to floor two level (C) Slabs, landings, shelves, balconies lintels, beams, girders and cantilever up to floor two level, (D) Columns, pillars, posts and struts upto floor two level (E) Stair cases up to floor two level (K) Vertical and horizontal fins upto floor two level.

1.0. Materials & Workmanship

The relevant specifications of item No. 5.8.1 shall be followed except that the grading of concrete shall be controlled concrete M-200 grades for works 35 specified in item.

2.0. Mode of measurement and payment

2.1. The relevant specifications of item No, 5.8.1. shall be followed.

2.2. The rate shall be for one cubic meter.

5.8.3. Providing and laying controlled cement concrete M-250 and curing complete excluding the cost of reinforcement of reinforced concrete work in:

(A) Foundations, footings, bases of columns, and the like and mass concrete (B) Walls from, top of foundation level up to floor two level (C) Slabs, landing, shelves, balconies, beams, girders and cantilever up to floor two level (D) Columns, pillars, struts up to floor two level.

1.0. Materials & Workmanship

1.1. The relevant specifications of item No. 5.8.1. shall be followed except the grading of concrete shall be controlled concrete M-250 grades for the works as specified in the item.

2.0. Mode of measurements & payment

2.1. The relevant specifications of item No. 5.8.1. shall be followed.

2.2. The rate shall be for a unit of one cubic meter.

5.00.1. Providing and laying ordinary concrete 1:2:4 (1 cement : 2 coarse sand :4 graded stone aggregates 20 mm. nominal size) and finishing smooth with curing etc., complete including the cost of form work but excluding the cost of reinforcement for R.C.C. work in: (I) Slabs up to 8 cms. thickness (II) Slabs having more than 8 cms. and up to (III) Slabs having more than 10 cms. and up to 13 cms. thickness (IV) Slabs having more than 13 cms. and up to 15 cms. thickness.

48

1.0. Materials & Workmanship

1.1. The relevant specifications for item No. 5.4.1. shall be followed for concrete work and relevant specifications of item No. 9.1. shall be followed for form work and centering. The concrete surface shall be smooth finished with cement mortar 1:3 (1 cement: 3 fine sand) as per item No. 17.59 (I) The thickness shall be as specified in the item.

2.0. Mode of measurement & payment

2.1. The relevant specification for item No. 5.4.1 shall be followed except that item shall include the item providing from work and centering work as directed.

2.2. The rate shall be for a unit of one cubic meter.

5.00.2. Providing and laying controlled cement M-150 and finishing smooth with curing etc. complete including the cost of form work but excluding the cost of reinforcement for R.C.C. work in :

(I) slabs up to 8 cms. thickness (II) Slabs more than 8 cms. 10 cms. (III) Slabs more the 10 cms. and up to 13 cms. (IV) Slabs more than 13 cms. and up to 15 cms.

1.0. Materials & Workmanship

1.1. The relevant specifications of item No. 5.8.1. shall be followed for concrete work and item No. 9.1. shall be

followed for form work and centering. The concrete surface shall be smooth finished with cement mortar 1:3 (1 cement : 3 fine sand) as per No. 17.59 (I) The thickness shall be as specified in the item.

2.0. Mode of Measurement & Payment

2.1. The relevant of item No. 5.8.1. shall be followed except that the item shall include the cost and from work and centering.

2.2. The rate shall be for a unit of one cubic meter.

5.00.3. Providing and laying ordinary cement concrete 1:2:4 (1 cement: 2 coarse sand : 4 graded stone aggregates 20 mm. nominal size) exposed work with curing etc. complete. including the cost of work but excluding the cost of reinforcement for R.C.C. work in : (I) Slabs up to 8 cms. thickness (II) Slabs having more than 8 cms.-and up to 10 cms. thickness (HI) Slabs having more than 10 cms. and up to 13 cms. thickness. (IV) Slabs having more than 13 cms. and up to 15 cms. thickness.

1.0. Materials & Workmanship

1.1. There relevant specifications of item No. 5.4.1. shall be followed for concrete work and that of form work and centering work shall be followed as per item No. 9.1. and 9.7. the thickness of the slab shall be as specified in the item.

2.0. Mode of Measurement & Payment

2.1. The relevant specifications of item No. 5.4.1. shall be followed except that form work and centering work shall be included in the item.

2.2. The rate shall be for a unit of one cubic meter.

5.00.4. Providing any laying controlled cement concrete M-150 exposed work with curing ere., complete including the cost of form work but excluding the cost of reinforcement for R.C.C. work in : (I) Slabs up to 8 cms. thickness (II) Slabs having more than 8 cms. and up to 10 cms. thickness (III) Slabs having more than 10 cms. and up to 13 cms. thickness. (IV) Slabs having more than 13cms. and up to 15 cms. thickness.

1.0. Materials & Workmanship

1.1. The relevant specification of item No 5.4.1. shall be followed for controlled concrete and the relevant specifications of item No. 9.7. and 9.1. shall be followed for exposed concrete form work and centering work. The thickness of the slab shall be as specified in the item.

2.0. Mode of Measurement & Payment

2.1. The relevant specifications of item No. 5.8.1. shall be followed except that the form work and centering work shall be included in the item.

2.2. The rate shall be for a unit of one cubic meter.

5.00.5. Providing and laying ordinary cement concrete 1:2:4 (1 cement : 2 coarse sand : 4 grades stone aggregate 20 mm. nominal size) for R.C.C. lintel including finishing smooth with curing etc. complete including the cost of form work but excluding the cost of reinforcement.

1.0. Materials & Workmanship

1.1. The relevant specifications of item No. 581. shall be followed for concrete work, relevant specifications of item No. 17.59.(I) for finishing work and relevant specifications of item No. 9.1. shall be followed form work and centering work The concrete work shall be followed for the form work and centering work for exposed concrete work.

2.0. Mode of measurement & payment

2.1. The relevant specification of item No. 5.3.1. shah be followed except that the item includes the cost form work for exposed concrete work

49

2.2. The rate shall be for a unit of one cubic meter.

5.00.6. Providing and laying cement concrete 1:2:4 (1 cement : 2 coarse sand : 4 graded stone aggregate 20 mm. nominal size) and finishing smooth with curing etc., compete, including the cost of form work but excluding reinforcement for R.C.C. work in : (A) Beams : (I) Having cross sectional areas 0.05 to 0.08 Sq. meter. (II) Having cross sectional area more than 0.08 Sq. up to 0.12 Sq. mt (III) Having cross sectional area more than 0.12 Sq. Mt. and up to 0.18 Sq. Mt (B) Column; (I) Having cross sectional area 0.05. to 0.08 Sq. mt. (III) Having cross sectional area more than 0.12 Sq.Mt. and up to 0.18 Sq.mt.

1.0. Materials & Workmanship

1.1. The relevant specifications of item No. 5.4.1. shall be followed for concrete work and item No. 9.1. shall be followed for form work and centering work. The finishing shall be done in cement mortar 1:3 (1 cement: 3 fine sand) as per item No. 17.59(1). The cross sectional area of beam shall be specified in item.

2.0. Mode of measurement & payment

2.1. The relevant specification of item No. 5.4.1. shall be followed but the from work and centering work shall be included in the item.

2.2. The rate shall be for a unit of one cubic meter.

5.00.7. Providing and laying controlled cement concrete M-150 exposed work with curing etc. complete, including the cost of form work but excluding the cost of reinforcement for R.C.C. work in : (A) Beams : (I) Having cross sectional area 0.05 to 0.08 Sq. mt. (II) Having cross sectional area more than 0.08 Sq. mt. up to 0.12 Sq.mt (III) Having cross sectional area more than 0.12 Sq. mt. and up to 0.18 Sq.mt.: (B) Columns; (I) Having cross sectional area of 0.05 to 0.08 Sq.mt (II) Having cross sectional area more than 0.08 sq.mt. and up to 0.12 sq.mt. (III) Having cross sectional area more than 0.12 Sq.Mt and up to 0.18 Sq.mt.

1.0. Materials & Workmanship

1.1. The relevant specifications of item No. 5.8.1. shall be followed for controlled concrete work as specified in item for M-150 and relevant specifications of item 9.1 shall be followed for the form work centering work for exposed cement work.

2.0. Mode of measurement & payment

2.1. The relevant specifications of item No. 5.8.1 shall be followed except that the form work and centering work shall be included in the item.

2.2. The rate shall be for a unit of one cubic meter.

5.00.8. Providing and laying controlled cement concrete M-200 exposed work with curing etc. complete, including the cost of form work but excluding the cost of reinforcement for R.C.C. work in (A) Beams : (I) Having cross section area 0.05 to 0.08 Sq. mt (II) Having cross sectional area 0.08 Sq.mt and up to 0.12 Sq. mt. (III) Having cross sectional area 0.12 Sq, and up to 0.18 Sq. Mt. (B) Columns : (I) Having cross sectional area 0.05 to 0.08 Sq.Mt. (II) Having cross sectional area more than 0.08 Sq.Mt and up to 0.12 Sq.Mt. (III) Having cross sectional area more than 0.12 Sq. mt. and up to 0.18 Sq.Mt.

1.0. Materials & Workmanship

1.1. The relevant specifications of item No. 5.8.1. shall be followed for controlled concrete work for work as specified in item for M-200 and relevant specifications of item 9.7 and 9.1 shall be followed for the form work and centering work for exposed cement work.

2.0. Mode of measurements & payment

2.1. The relevant specification of item No. 5.8.1. shall be followed except that the item includes the cost of form work and centering work for exposed work.

2.2. The rate shall be for a unit one cubic meter.

5.00.9. Providing and laying controlled cement concrete M-250 exposed work with curing etc. complete including the cost of from work but excluding the cost of reinforcement for R.C.C. work in : (A) Beams : (I) Having cross sectional area 0.05 to 0.08 Sq.mt.(II) Having cross sectional areas more than 0.08 Sq.mt. and up to 0.12 Sq. mt (III) Having cross sectional area more than 0.12 Sq.mt. and up to 0.18 Sq. Mt. (5) Columns :(I) Having cross sectional area 0.05 to 0.08. Sq.Mt (II) Having cross sectional area more than 0.08 Sq. mt. and up to 0.12 Sq. mt. (III) Having cross sectional area more than 0.12 Sq.mt. and up to 0.18 Sq.mt.

1.0. Materials & Workmanship

1.1. The relevant specifications of item No. 5.8.1. shall be followed for controlled concrete work for the work as specified in the item for M-250 and the relevant R.C.C. lintels shall be carried out.

2.0. Mode of measurement & payment

2.1. The relevant specifications of item No. 5.4.1 shall be followed except that the cost of form work finishing and centering shall be included in the item.

2.2. The rate shall be for a unit of one cubic meter.

50

SECTION – 6

Masonry Work

6.12 (A) Brick work using common burnt clay building bricks having crushing strength not less than 35 Kg/Sq. Cm. in foundations and plinth in cement mortar 1:5 (1 cement :5 fine sand) modular bricks.

1.0. Materials

Water shall conform to M-1. Cement shall conform to M-3. Sand shall conform to M-6. Brick shall conform to M-15. Cement mortar shall conform to M-11.

2.0. Workmanship

2.1. Proportion:

2.1.1. The proportion of the cement mortar shall be 1:5 (1 cement: 5 fine sand) by volume.

2.2. Wetting of bricks:

2.2.1. The bricks required for masonry shall be thoroughly wetted with clean water for about two hours before use or as directed. The cessation of bubbles, when the bricks are wetted with water is as indication of through wetting of bricks.

2.3. Laying:

2.3.1. Bricks shall be laid in English bond unless directed otherwise. Half or cut bricks shall not be used except when necessary to complete to bond; closures in such case shall be cut to required size and used near the ends of walls.

2.3.2. A layer of mortar shall be spread on full width for suitable length of the lower course. Each brick shall first be properly bedded and set home by gently tapping with handle of trowel or wooden mallet. Its inside face shall be flushed with mortar before the next brick is laid and pressed against it. On completion of course, the vertical joints shall be fully filled from the top with mortar.

2.3.3. The walls shall be taken up truly in plumb. All courses shall be laid truly horizontal and all vertical joint shall be truly vertical. Vertical joints in alternate course shall generally be directly one over the other. The thickness of brick course shall be kept uniform.

2.3.4. The brick shall be laid with frog up wards. A set of tools comprising of wooden straight edges, man son's spirit level, square half meter rub, and pins, string and plumb shall be kept on the site of work for frequent checking during

the progress of work.

2.3.5. Both the faces of walls of thickness greater than 23 cms. shall be kept in proper place. All the connected brick work shall be kept not more than one meter over the rest of the work. Where this is not possible, the work shall be raked back according to bond (and not left toothed) at an angle not steeper than 45 degrees.

2.3.6. All futures, pipes, outlets of water, hold fasts of doors and windows etc. which are required to be built in wall shall be embedded in cement mortar

2.4. Joints:

2.4.1. Bricks shall be so laid that all joints are quite flush with mortar. Thickness of joints shall not exposed 12 mm. The face joints shall be raked out as directed by raking tools daily during the progress of work, when the mortar is still green so as to provide key for plaster or pointing to done.

2.4.2. The face of brick shall be cleaned the very day on which the work is laid and all mortar dropping removed.

2.5. Curing:

2.5.1. Green work shall be protected from rain suitably. Masonry work shall be kept moist on all the faces for a period of seven days. The top of masonry work shall be kept well wetted at the close of the day.

2.6. Preparation of foundation bed:

2.6.1. If the foundation is to be laid directly on the excavated bed, the shall be leveled, cleared of all loose materials, cleaned and wetted before stating masonry, If masonry is to be laid on concrete footing, the top of concrete shall be cleaned and moistened. The contractor shall obtain the engineer's approval for the foundation bed before foundation masonry is started. When pucca flooring is to be provided flush with the top to plinth, the inside plinth offset shall be kept lower than the outside plinth top by the thickness of the flooring.

3.0. Mode measurements & payment

3.1. The measurements of this item shall be taken for the brick masonry fully completed in foundation up to plinth. The limiting dimensions not exceeding those shown on the plinths or as directed shall be final. Battered tapered and curved portions shall be measured net.

51

3.2. No deduction shall be made from the quantity of brick work, for any extra payment made for embedding in masonry or making holes in respect of following items:

(1) Ends of joists, beams, posts, girders, purlins, trusses, corbel, steps etc. where cross sectional area does not exceed 500 Sq.Cm.

(2) Openings not exceeding 1000 Sq.Cm.

(3) Wall plates and bed plates, bearing of slabs, chajjas and the like whose thickness does not exceed 10 Cms. and the bearing does not extend to the full thickness of wall.

(4) Drainage holes, and recesses for cement concrete blocks to embed hold fasts for doors, windows etc.

(5) Iron fixtures, pipes up to 300 mm. dia hold fasts, and doors and windows built into masonry and pipes etc. for concealed wiring.

(6) Forming chases of section not exceeding 350 -Sq. Cm. in masonry.

3.3. Apertures for fire places shall not be deducted nor shall be paid for separately.

3.4. The rate shall be for a unit of one cubic meter.

6.12. (B) Brick work using common burnt clay building bricks having crushing strength not less than 35 Kg/Sq. Cm. in foundations and plinth in cement mortar 1:5 (1 cement : 5 fine sand) conventional bricks.

1.0. Materials

Cement mortar of proportion 1:5 shall conform to M-11. Conventional bricks shall conform to M-15.

2.0. Workmanship

The relevant specification of item No. 6.12 (A) shall be followed except that the bricks to be used shall be modular bricks and the proportion of cement mortar is 1:6.

3.0. Mode of measurements & payment

3.1. The relevant specifications of item No. 6.12(A) shall be followed.

3.2. The rate shall be a unit of one cubic meter.

6.13.(A) Bricks work using common burnt clay building bricks having crushing strength not less than 35 Kg/Sq. Cm in foundation and plinth in cement mortar 1:6 (1 cement : 6 find sand) with conventional bricks.

1.0. Materials

Water shall conform to M-1. Cement mortar shall conform to M-11. Bricks shall conform to M-15.

2.0. Workmanship

2.1. The relevant specification of item No. 6.12 (A) shall be followed except that the bricks to be used shall be conventional bricks and proportion of cement mortar shall in C.M. 1:6.

3.0. Mode of measurements & payment

3.1. The relevant specification of item No. 6.12(A) shall be followed.

3.2. The rate shall be for a unit of one cubic meter.

6.0.0.1(A) Brick work using common burnt clay building bricks having crushing strength not less than 35 Kg/Sq, Cm. in foundation and plinth in cement mortar 1:8 (1 cement :8 find sand), with Modular bricks.

1.0. Materials

Water shall conform to M-1. Brick shall conform to M-15. Cement mortar shall be conform to M-11.

2.0. Workmanship

2.1. The relevant specification of item No. 6.12(A) shall be followed except that the proportion of cement mortar

shall be cement mortar 1:8 and bricks used shall be conventional bricks.

3.0. Mode of measurements & payment

3.1. The relevant specification of item No. 6.12(A) shall be followed.

3.2. The rate shall be for a unit of one cubic meter.

6.00.1.(B) Brick work using common burnt clay building bricks having crushing strength not less than 35 Kg/Sq. Cm. in foundation and plinth in cement mortar 1:8 (1 cement : 8 fine sand), with conventional bricks.

1.0. Materials

Water shall conform to M-1. Brick shall conform to M-15, cement mortar shall be conform to M-11.

2.0. Workmanship

2.1. There relevant specifications of item No. 6.12(A) shall be followed except that the proportion of cement mortar shall be cement mortar 1:8.

3.0. Mode of measurement & payment

3.1. The relevant specifications of item No. 6.12(A) shall be followed.

3.2. The rate shall be for a unit of one cubic meter.

6.0.0.1.(A) Brick work using common burnt clay building bricks having crushing strength not less than 35 Kg./Sq. Cm. in foundation and plinth in lime mortar 1:1.5 (1 Lime putty : 1.5 fine sand) modular bricks.

1.0. Materials

Lime mortar of proportion (1:1.5) shall conform to M-10. Bricks shall conform to M-15.

52

2.0. Workmanship

2.1. The relevant specification of item No. 6.12(A) shall be followed except that the proportion of cement mortar shall be cement mortar 1:8 and bricks used shall be conventional bricks.

3.0. Mode of measurements & payment

3.1. The relevant specification of item No. 6.12(A) shall be followed.

3.2. The rate shall be for a unit of one cubic meter.

6.001.(B) Brick work using common burnt clay building having crushing strength not less than 35 Kg/Sq. Cm. in foundation and plinth in cement mortar 1:8 (1 cement: 8 fine sand), with conventional bricks.

1.0. Materials

Water shall conform to M-1. Brick shall conform to M-15, Cement mortar shall be conform to M-11.

2.0. Workmanship

2.1. The relevant specifications of item No. 6.12. (A) shall be followed except that the proportion of cement mortar shall be cement mortar 1:8.

3.0. Mode of measurements & payment

3.1. The relevant specifications of item No. 6.12. (A) shall be followed.

3.2. The rate shall be for a unit of one cubic meter.

6.0.0.2.(A) Brick work using common burnt clay building bricks having crushing strength not less than 35 Kg./Sq. Cm. in foundation and plinth in lime mortar 1:1.5 (1 Lime putty: 1.5 fine sand) modular bricks.

1.0. Materials

Lime mortar of proportion (1:1.5) shall conform to M-10. Bricks shall conform to M-15.

2.0. Workmanship

The relevant specification of item No. 6.12. (A) shall be followed except the masonry work shall be carried out in lime mortar 1:1.5 (1 lime putty 1.5 fine sand) in foundation and plinth.

3.0. Mode of measurements & payment

3.1. The relevant specification of item No. 6.12. (A) shall be followed.

3.2. The rate shall be for a unit of one cubic meter.

6.0.0.2.(B) Brick work using common burnt clay building bricks having crushing strength not less than 35 Kg/Sq. Cm. in foundation and plinth in lime mortar 1:1.5 (1 Lime putty : 1.5 fine sand) conventional bricks.

1.0. Materials & Workmanship

The relevant specification of item No. 6.12(A) and 6.0.2(A) shall be followed except that the masonry work shall be carried out by using conventional bricks in lime mortar 1:1.5 (1 Lime putty: 1.5 fine sand) in foundation and plinth.

2.0. Mode of measurements & payment

2.1. The relevant specification of item No. 6.12(A) shall be followed.

2.2. The rate shall be for a unit of one cubic meter.

6.0.0.3.(A) Brick work using common burnt clay building brick having crushing strength not less than 35 Kg. Sq. Cm. in foundation and plinth in lime mortar 1:2 (1 lime putty :2 fine sand) modular bricks.

1.0. Materials & workmanship

The relevant specification of item No. 6.12(A) and 6.0.0.(A) shall be followed except that the masonry work shall be carried out in lime mortar 1:2 (1 Lime putty : fine sand) in foundation and plinth,

2.0. Mode of measurements & payment

2.1. The relevant specification of item No. 6.12 (A) shall be followed.

2.2. The rate shall be for a one cubic meter.

6.0.0.3(3) Brick work using burnt clay building bricks having crushing strength not less than 35 Kg/Sq.

Cm. in foundation and plinth in lime mortar 1:2 (1 Lime Putty : 2 find sand) modular bricks.

53

1.0. Materials & Workmanship

The relevant specifications of item No. 6.12 A and 6.0.03 shall be followed except that the masonry work shall be carried out in lime mortar 1:2 (1 lime : 2 find sand) using conventional bricks in foundation and plinth.

6.19.(A) Brick work using common burnt clay building brick having crushing strength not less than 35 kg/sq.cm. for super structure above plinth level up to floor two level in cement mortar 1:5 (1 cement: 5 find sand) modular bricks.

1.0. Materials

Bricks shall conform to M-15. Cement mortar shall conform to M-11.

2.0. Workmanship

2.1. The relevant specification of item No. 6.12 (A) shall be followed except that the masonry work shall be carried out above plinth level to floor two level i.e. for ground floor.

2.2. The frames of doors, windows, cupboards etc. shall be housed into the brick work at the correct location and level as directed. The heavy steel doors, window frames etc. shall be built in with work, but for ordinary steel doors and windows required opening for frames, hold-fasts, etc., shall be in the wall and frame embedded later on in order to avoid damage to the frames.

2.3. Necessary scaffolding shall be provided. The supports of the scaffolding shall be sound and strong tied, together with horizontal pieces over which the scaffolding plunks shall be fixed. Simple scaffolding shall be allowed normally. In this case scaffolding hole shall rest in hole header horizontal coarse only. Minimum number of holes be left in brick work for supporting horizontal scaffolding poles. The contractor is responsible for providing and maintaining sufficiently strong scaffolding so as to withstand all loads likely to come upon it.

2.4. For the face of brick work, where plastering is to be done, joints shall be racked out to a depth not less than thickness of joints. The face of brick work shall be cleaned and mortar dropping removed on very same day that brick work is laid.

3.0. Mode of measurements & payment

3.1. The masonry work of G.F. i.e. above plinth level to floor two level shall be measured and paid under this item.

3.2. Brick work in parapet shall be included in the corresponding masonry item of store immediately below the floor above which the parapet is built.

3.3. No deduction shall be made from quantity of brick work nor any extra payment made for embedding in masonry of marking holes in respect of following item.

(1) Ends of joints, beams, posts, girders, rafters, purlins trusses corbel, steps, etc. where cross sectional area does not exceed 500 sq.cm.

(2) Opening not exceed in 1000 sq.cm.

(3) Wall plate sand bed plates bearing of slab, chhajjas, and like whose thickness does not exceed 10 cms. and the bearing does not extend the full thickness of wall.

(4) Drainage holes and recesses for cement concrete blocks to embed hold fasts for doors, window etc.

(5) Iron fixtures, pipes up to 300 mm. dia. hold fasts of doors, and window built into masonry and pipes etc. for concealed wiring.

(6) Forming charges of section not exceeding 350 sq.cm. in masonry.

(7) Apparatuses for fire places, shall not be deducted nor shall extra labour required to make splaying of jumps, throating and making trenches over the aperture be paid for separately.

3.4. The rate shall be for a unit of one cubic meter.

6.19.(B) Brick work using common burnt clay building bricks having crushing strength not less than 35 kg/sq. cm. for super structure above plinth up to floor two level in cement mortar 1:5 (1 cement: 5 fine sand) conventional bricks.

1.0. Materials & Workmanship

The relevant specification of item No. 6.19(A) shall be followed except that brick masonry work shall be carried out with conventional bricks.

2.0. Mode measurement and payment

2.1. The relevant specification of item No. 6.19 (A) Shall be followed.

2.2. The rate shall be for a unit of one cubic meter per meter.

54

6.20 Extra for brick in super structure above floor two level.

1.0. Materials and workmanship

The relevant specifications of item masonry work to be earned out shall be followed except that this work is for additional lift of one floor above two level.

2.0. Mode of measurements and payment

2.1. The relevant specification of item No. 6.19 (A) masonry work shall be followed.

2.2. The extra payment shall be made for additional lift above floor two level to each additional floor over and above the rate of masonry work.

2.3. The rate shall be for a unit of cubic meter per floor.

6.30.I(A) Half brick masonry in common burnt clay building having crushing strength not less than 35 kg/sq.cm. in cement mortar 1:4 {1 cement : 4 coarse sand} for super-structure above plinth level up to floor two level with conventional bricks.

1.0. Materials

Bricks shall conform to M-15. Water shall conform to M-1. Cement shall conform to M-3. Sand shall conform to M-6.

Cement mortar shall conform to M-11.

2.0. Workmanship

2.1. Relevant specifications of bricks, wetting and laying of bricks, joints, curing etc shall conform to item no. 6.19.(A) except that the brick work of half shall be carried out.

2.2. Cement mortar used in masonry work shall be in proportion of 1 part of cement and 4 parts of sand by volume.

2.3. AH bricks shall be laid stretcher wise, breaking joints with those in the upper and lower courses. The wall shall be taken truly plumb. All courses shall be said truly horizontal and all vertical joints shall be truly vertical. The bricks shall be laid with frogs upwards. A set of masons tools shall be maintained on work as required for frequent checking.

3.0. Mode of measurement and payment

3.1. The half brick masonry work in foundation and plinth shall be measured under this item the limiting dimensions shall not exceed those shown in the plan or as directed. Any work done extra over the specified dimensions shall be ignored.

3.2. The relevant specifications of item no. 6.12. shall be followed. The length shall be measured nearest to one cm.

3.3. The rate shall be for a unit of one sq. meter.

6.30.I.(B) Half brick masonry in common burnt clay building bricks crushing strength not less than 35 kg/sq. cm. in cement mortar 1:4 (1 cement :4 coarse sand) for super-structure above plinth level up to floor two level with conventional bricks.

1.0. Materials and Workmanship

1.1. The relevant specifications of Item No. 6.30.1 (A) shall be followed for bricks, wetting, laying of bricks, joints, curing, curing, except that the bricks to be used shall be conventional bricks instead of modular bricks.

2.0. Mode of measurement and payment

2.1. The limiting dimensions shall not exceed those shown in the plan or as directed. Any work done extra over specified dimensions shall be ignored.

6.30.II.(A) Half brick masonry in common burnt clay building bricks having crushing strength not less than 35 kg/sq.cm. in cement mortar 1:5 (1 cement : 5 coarse sand) with modular bricks in foundations and plinth.

1.0. Materials & workmanship

The relevant specifications of item No. 6.30.I (A) shall be followed except the half brick masonry work shall be carried out in cement mortar 1:5 (1 cement : 5 coarse sand) with modular bricks in foundation and plinth.

2.0. Mode of measurement and payment

2.1. The relevant specifications of item no. f, 30. I (A) shall be followed.

2.2. The rate shall be for a unit of one cubic meter.

6.30.II.(B) Half brick masonry on common clay building bricks having crushing strength not less than 35 kg/sq. cm. in cement mortar 1:5 (1 cement : 5 coarse sand) in foundation and plinth using conventional bricks.

1.0. Materials & workmanship

1.1. The relevant specifications of item No. 6.30.I (A) shall be followed for bricks, wetting, laying of bricks, joints, curing, except that the bricks to be used shall be conventional bricks instead of modular bricks.

2.0. Mode of measurement and payment

2.1. The relevant specifications of item No. 6.30.I (A) shall be followed.

2.2. The rate shall be for a unit of one sq. meter.

6.30.III.(A) Half brick masonry in common burnt clay building having crushing strength not less than 35 kg/sq. cm. in lime mortar 1:1.5 (1 lime putty : 1.5 coarse sand) in foundation and plinth with modular bricks.

55

1.0. Materials & workmanship

The relevant specifications of item No. 6.30 (I)-A shall be followed except that the half bricks work shall be carried out in cement 1:5 (1 cement: 5 coarse sand) in foundation and plinth using conventional bricks.

2.0. Mode of measurements & payment

2.1. The relevant specifications of item no. 6.30 (I)-A shall be followed.

2.2. The rate shall for a unit of one sq. meter.

6.30.III(A) Half brick masonry in common burnt clay building having crushing strength not less than 35 kg/sq. cm. in lime mortar 1 :1.5 (1 lime putty : 1.5 coarse sand) in foundation and plinth with modular bricks.

1.0. Materials

Modular bricks shall conform to M-15 water shall conform to M-1. Lime mortar or proportion L.M. 1:1.5 (1 Lime putty : 1.5 coarse sand) shall conform to M-10.

2.0. Workmanship

The relevant specifications of item No. 6.30 (I) (A) shall be followed except that the half brick masonry work shall be carried out in lime mortar 1:1.5 (1 Lime putty : 1:1.5 coarse sand) in foundation and plinth using modular bricks.

3.0. Mode of measurements & payment

3.1. The relevant specification of item No. 6.30 (I) A shall be followed.

3.2. The rate shall be for a unit of one sq. meter.

6.30.111(8) Half brick masonry in common burnt clay building bricks having crushing strength not less

than 35 kg/sq. cm. in mortar 1: 1.5 (1 Lime putty : 1.5 coarse sand) in foundation and plinth with conventional bricks.

1.0. Materials

Conventional bricks shall conform to M-15, water shall conform to M.1. Lime mortar or proportion L.M. 1:1.5 (1 Lime putty : 1.5 coarse sand) shall conform to M-10.

2.0. Workmanship

The relevant specifications of item No. 6.30 (I)-A shall be followed except that half brick masonry work shall be carried out in Lime Mortar 1:1.5 (1 Lime putty : 1.5 coarse sand) in foundation and plinth using conventional bricks.

3.0. Mode of measurements and payment

3.1. The relevant specifications of item No. 6.30 (I)-A shall be followed.

3.2. The rate shall be for a unit of one sq. meter.

6.30 II(A) Half brick masonry in common burnt clay building bricks having crushing strength not less than 35 kg/sq. cm. in cement 1:5 (1 cement : coarse sand) with hoop iron 25 mm. x 1.6 mm. or equivalent reinforcement at every third coarse embedded in cement mortar in foundation and plinth with modular bricks.

1.0. Materials

Bricks shall conform to M-15. Water shall conform to M-1. Cement shall conform to M-3. Sand shall conform to M-6. Cement mortar shall conform to M-11. M.S. reinforcement shall conform to M-18.

2.0. Workmanship

2.1. Relevant specifications of bricks, wetting and laying of bricks, joints, curing, scaffolding etc. shall conform to item No. 6.30 (I)-A except the following :

2.2. Cement mortar used in masonry work shall be in proportion to 1 part of cement and 5 parts of sand by volume and shall conform to M-11, and this work is for half brick thickness for partitions walls.

2.3. The hoop iron 25 mm x 1.6 or equivalent reinforcement shall be provided at every third course. The ends of reinforcement shall be fully embedded in main walls on both sides as directed. Reinforcement shall be placed on the top of the bottom most course. Laps shall be of 15 cms. of mild steel bars or hoop iron.

2.4. The joints in the course where reinforcement is placed shall admit of mortar cover to the reinforcement.

56

3.0. Mode of measurements and payment

3.1. The rate shall be for half brick masonry work providing specified reinforcement, the limiting dimensions not exceeding those in the plan or as directed. The length shall be measured nearest to one cm.

3.2. Any work done extra over specified dimensions shall be ignored.

3.3. The rate shall be for a unit one sq. meter.

6.30.II(B) Half brick masonry in common burnt clay building having crushing strength not less than 35 kg/sq.cm. in cement mortar 1:5 (1 cement : 5 coarse sand) with hoop iron 25 mm. x 1.6 mm. or equivalent reinforcement at every third course embedded in cement mortar in foundation and pith, with conventional bricks.

1.0. Materials & Workmanship

1.1. The relevant specifications of item No. 6.30 I (A) shall be followed except that the work is to be carried out with conventional bricks instead of Modular bricks.

2.0. Mode of measurements and payment

2.1. The rate shall be for half brick work, including providing specified reinforcement, the limiting dimensions out with conventional bricks instead of Modular bricks.

2.2. The work done extra over specified dimensions shall be ignored.

2.3. The rate shall be for a unit of one sq. meter.

6.33.(A) Extra for half brick masonry in superstructure above floor two level. Modular bricks.

1.0. Materials & Workmanship

1.1. The relevant specifications for item No. 6.30 A & 6.30. B shall be followed except that this work is for additional lift over and above the payment of work up to floor two level.

1.2. The rate shall be for a unit of one sq. meter per floor.

6.33.(B) Extra for half brick masonry work in superstructure above floor two level. Conventional bricks.

1.0. Materials & Workmanship

1.1. The relevant specifications for item No. 6.30 A & 6.30. B shall be followed except that this work is for additional lift of each floor two level using conventional bricks.

2.0. Mode of measurements and payment

2.1. The relevant specification of item No. 6.33 (A) shall be followed.

2.2. The rate shall be for a unit of one sq. meter per floor

6.55 (1) Half brick thick Honey-comb brick work with burnt work with burnt clay building bricks having crushing strengths not less than 35 kg/sq.cm. in C.M. 1:4 (1 cement : 4 coarse sand)

1.0. Materials

Bricks shall conform to M-15 Cement mortar of proportion shall conform to M-11.

2.0. Workmanship

The relevant specifications of item No. 6.32(A) shall be followed except that the masonry work shall be carried out Honey-comb in thickness of half bricks in cement mortar 1:4 (1 cement: 4 coarse sand) and as and where directed with all lifts.

3.0. Mode of measurements and payment

3.1. The honey-comb work shall be measured in sq. meters. The full area of honey comb work shall be measured without with all lifts.

3.2. The rate shall be for a unit of one square meter of wall surface.

57

SECTION-7

Rubble Masonry Work

7.6(1) Uncoarsed rubble masonry with hard stone approved quality in foundations and plinth in cement mortar 1:6 (1 cement : 6 coarse sand) including leveling etc. complete.

1.0. Materials:

The cement mortar shall conform to M-11. Stone shall conform to M-16.

2.0. Workmanship

2.1. Dressing of stones:

Stone used for uncoarsed rubble masonry work shall be hammer dressed on the sides, and beds in which such a way as to close with the adjacent stone in the masonry work as strongly as possible. The face stones shall be dressed in such a manner as to give a specified pattern such as polygonal facing etc. The face of the stones shall be so dressed that bushing on the exposed face shall not project by more than 40 mm. from the general wall surface and on the face to be plastered, it shall not project by more than 19 mm., not shall have depressions more than 10 mm. from the average wall surface.

2.2. Laying:

All the stone shall be sufficiently wetted before laying to prevent absorption of water from mortar. The wall shall be built true to plumb (of true to required batter when so specified). All connected walls in a structure shall be raised up informally and regularly. However if for any specific reason, one part of masonry is required to be left behind the wall shall be racked back at an angle not steeper than 45. Vertical toothed joints in masonry shall not be allowed. The work shall be carried out regularly and masonry of any day wall not be raised by more than 1 meter in height.

2.3. The stone shall be laid in an uncoarsed fashion, or random facing etc. However the masonry is required to be brought to level at various stages viz. plinth level window still level, roof level and any other level specifically shown in the drawings. This may be done first by adjusting the laying of stone to one level and then by providing leveling course of cement concrete 1:6:12 (1 cement: sand : 12 graded stone aggregate 20 mm. nominal size) or as otherwise specified.

2.4. Proper bonding shall be achieved by closely filling in adjacent stones as well as by using bond stones or through stones as described herein below. Face stones shall extend back sufficiently, and bond well with the masonry. The stone shall be carefully set so as to break joints and avoid formation of vertical joints. The depth of stone from the face of wall inwards shall not be less than weight or breadth at the face. The hearing or interior filling of the wall shall consist of rubble stones which may be of nay shape. Neither the face stone nor the hearing stone shall be so small to pass through circular ring of 150 mm. internal diameter in any direction nor shall any of them shall have minimum thickness 100 mm.

2.5. All stone shall be carefully laid, hammered down by a wooden mallet into position and solidly embedded in mortar, chips and spawns of stone may be used wherever necessary to avoid thick mortar bends or joints at the same time ensuring that no hollow space is left any where in the masonry. The chips used shall not be more than 20% by volume of masonry. The hearting shall be laid nearly level with face stones except that at about one meter intervals vertical bond stone or plumes projecting about 150 to 200 mm. shall be firmly embedded to from vertical bounding in masonry.

2.6. Bond stone:

Bond stones or through stones running right across the thickness of the wall shall be provided in wall up to 600 mm. thick. In thicker walls two stones overlapping each other by at least 150 mm. shall be provided across the thickness of the wall to form bond stones. There shall be at least one bond stone for every 0.5 sq. mt of wall surface. The bond stone shall be marked by a distinguishing letter during construction for subsequent verification and shall be laid staggered in sub sequent layers.

2.7. Quoins:

The quoins or corners stones shall be selected stone neatly dressed with hammer and/or chisel to form the required corner angle and laid header and stretcher alternatively, The bed top surface of quoins shall be chiseled dressed to give horizontal joints. The quoins shall have a uniform chisel draft of at least 25 mm. width at four edges of each exposed face, all the edges of the same face being in one plane. No quoins stone shall be smaller than 0.025 cum. in volume.

2.8. Jamb Stones:

The jamb stone shall be made with stone specified for quoins, that the stone provided on the jambs shall have their length equal to thickness of wall up to 600 mm. and a line of headers shall be provided for walls thicker than 600 mm. as specified for bond.

58

2.9. Joints:

All the joints shall be completely filled with mortar and width shall not exceed 25 mm. when plastering of pointing is not required to be done, the joints shall be struck flush and finished simultaneously while laying the stone. Otherwise the joints shall be racked to a minimum depth of 20 mm. by a racking tools, during progress of laying while the mortar is still green.

2.10. Scaffolding:

Single or double scaffolding shall be used. The scaffolding shall be strong and sound. The holes left in masonry for

supporting scaffolding shall be filled and made good before plastering.

2.11. Curing:

Green work shall be protected from rains by covering the same. Masonry shall be kept constantly moist on all the faces for a period of at least 7 days. The top of masonry shall be flooded at close of the day.

3.0. Mode of measurements and payment

3.1. All work shall be measured on the basis of finished dimensions and measured net except where otherwise specified. Only specified dimensions shall be allowed. Anything extra shall be ignored. The masonry work in foundation and plinth shall be measured under this item. No deduction shall be made, not extra payment made for the following:

- (a) Ends of joints, beams, spots, girders, rafters, purlins, trusses, corbels, etc. each up to 500 sq. cm. in section.
- (b) Opening each up to 0.1 sq.m.
- (c) Wall plates and bed plates, bearing of chhaja and like up to 10 cm. depth (bearing of floor and roof slabs shall be deducted from masonry).
- (d) Drain holes and recesses for cement concrete blocks to embed hold fasts for doors windows.
- (e) Building in the masonry iron fixtures pipes up to 300 mm. dia. hole fasts of doors and windows.
- (f) Forming theses in masonry up to section of 350 sq.cm.

3.2. The rate shall be for a unit of one cubic meter.

7.6.(II) Uncoursed rubble masonry with hard stone of approved quality in foundation and plinth in cement mortar 1:5 (1 cement : 5 coarse sand) including leveling up etc. complete.

1.0. Materials and workmanship

The relevant specification of item No. 7.6(1) shall be followed except that the proportion of cement mortar shall be in C.M. 1:5 (1 cement : 5 coarse sand)

2.0. Mode of measurements and payments

2.1. The relevant specifications of item No. 7.6(1) shall followed.

2.2. The rate shall be a unit of one cubic meter.

7.6.(III) Uncoursed rubble masonry with hard stone of approved quality in foundation and plinth in lime mortar 1:1.5 (1 lime putty : 1.5 coarse sand) including leveling etc. complete.

1.0. Materials:

Lime mortar shall conform to M-10. The rubble shall conform to M-16.

2.0. Workmanship

The relevant specifications of item No. 7.6 (I) shall be followed.

3.0. Mode of measurement and payment

3.1. The relevant specifications of item No. 7.6 (I) shall be followed.

3.2. The rate shall be for a unit of one cubic meter.

7.17(A) Coursed rubble masonry with hard stone of approved quality in foundation and plinth in cement mortar 1:6 (1 cement : 6 coarse sand) etc. complete.

1.0. Materials

Cement mortar shall conform to M-11. The stone shall conform to M-16.

2.0. Workmanship

2.1. Dressing of stones:

The face stone shall be hammer dressed so as to give approximately rectangular blocks. They shall be squared on bed and side joints. The bed joints shall be rough chisel dressed for a depth of at least 50 mm. back from the faces and the side joints shall be so dressed to a depth of at least 40 mm. back from the face, such that no portion of the dressed surface is more than 10 mm. from a straight edge held against the surface. The remaining portions of surface shall not project above the chisel dressed bed and side joints. The bushing on the face shall not project by more than 40 mm. on an exposed face and 10 mm. on a face to be plastered. The hammer dressed stone shall also have a rough tooling for a minimum width of 25 mm. along the four edges of the face of the stone.

59

2.2. Laying:

2.2.1. All stones shall be wetted before laying. The wall shall be built up truly plumb (or to required better where so specified.)

All connected masonry in a structure shall normally be raised up uniformly and regularly. However, if for any specific reasons one part of wall is required to be left behind, such wall shall be raked back at an angle not steeper than 45°. vertical toothed joints in masonry shall not be allowed. The work shall be carried up regularly and masonry on any day shall not be raised by more than 1 meter in height.

2.2.2. All the courses shall be laid truly horizontal. The height of course shall not be less than 150 mm. nor more than 300 mm. Face stone shall be laid in alternate header and stretcher fashion. They shall be so arranged as to break joints by at least 75 mm. Stones shall be laid with grains horizontal so that the load is transmitted along the direction of their maximum crushing strength. The depth of stone shall not be less than the height or breadth. The breadth of a face stone shall also be not less than the breadth. The breadth of a face stone shall also be not less than 150 mm. Each face stone shall be of the same height in any give course. The courses shall be not less than 150 mm. Each face stone shall be of the same height in any give course. The courses shall be built in perpendicular to the pressure which the masonry will bear. In case of battered walls (such as retaining walls) the beds of the stone and the plate of courses shall be laid with their bed perpendicular to the battered face.

2.2.3. The hearting or the interior filling of the wall shall consist of flat bedded stones carefully laid on their proper beds in mortar, chips and spawns of stone being used where necessary to avoid excessive use of mortar, care being taken to see that no hollow space is left anywhere in the masonry. Chips shall not be used below the hearting stone to

bring these up to the level of stones. The use of chips shall be restricted to be filling of interstices between the hear tiling stone but the volume of chips shall be limited to 15% of the total volume of the masonry.

2.3. Bond Stones:

The relevant specification of item No. 7.6 (I) Para 2.6 shall be followed except that the bond stone shall be provided for at least 1.8. m. length of every courses.

2.2.4. Quoins:

The quoins, which shall be of the same height as the course to which it belongs shall be formed from selected stone of at least 400 mm. length. They shall be laid square or beds on stretchers and headers alternatively. The beds shall be rough, chisel dressed to a depth of at least 100 mm. These stones shall have a minimum uniform chisel draft of 25 mm. width at four edges being in the same plane, quoin stone shall not be smaller than 0.025 cum. in volume and it shall also be not less than 300 mm. in length, 25 % of them being not less 500 mm. in length.

2.5. Joints:

All the bed joints shall be horizontal and all shall be vertical. Face joints shall not be more than 10 mm. thick. All joints shall be properly and completely filled with mortar. On faces where no plastering not pointing is required to be done the joint shall be flush and finished simultaneously while laying stones. In other cases the joints shall be raked to a minimum depth of 20 mm. by raking tools during the progress of work while the mortar is still green.

2.6. Curing:

The relevant specification of item No. 7.6 (I) area Para 2.9 shall be followed

3.0. Mode of measurements & payment

3.1. The relevant specification of item No. 7.6 (I) shall be followed.

3.2. The rate shall be for a unit of one cubic meter.

7.17.(B) Coursed rubble masonry with stone of approved quality in foundation and plinth in cement mortar 1:5 (1 cement : 5 coarse sand) etc. complete.

1.0. Materials & Workmanship

The relevant specifications of item No. 1.17 (A) shall be followed except that the proportion of cement mortar shall be C.M. 1:4 (1 cement : 5 coarse sand)

2.0. Mode of measurement & payment

2.1. The relevant specification of item No. 7.17 (A) shall be followed.

2.2. The rate shall be for a unit of one cubic meter. t

7.17 (C) Coursed rubble masonry with stone of approved quality in foundation and plinth in C.M. 1:4 (1 cement : 4 coarse sand) etc. complete)

1.0. Materials & workmanship

The relevant specifications of item No. 7.17 (A) shall be followed except that the proportion of mortar shall be C.M. 1:4 (1 cement : 4 coarse sand)

2.0. Mode of measurements & payment

2.1. The relevant specifications of item No. 7.17 (A) shall be followed.

60

2.2. The rate shall be for a unit of one cubic meter.

7.17(D) Coarsed rubble masonry with stone of approved quality in foundation and plinth in c.m. 1:3 (1 cement : 3 coarse sand) etc. complete.

1.0. Materials and Workmanship

1.1. The relevant specification of item No. 7.17 (A) shall be followed except that the proportion of mortar shall be C.M. 1:3 (1 cement : 3 coarse sand)

2.0. Mode of measurement & payment

2.1. The relevant specification of item No. 7.17 (A) shall be followed.

2.2. The rate shall be for a unit of one cubic meter.

7.19(A) Coarsed rubble masonry with stone of approved quality for structure above plinth level up to floor two level in C.M. 1:6 (1 cement : 6 coarse sand) etc. complete.

1.0. Materials & Workmanship

1.1. The relevant specification of item No. 7.17 (A) shall be followed except that the coursed rubble masonry work shall be carried out for superstructure above plinth level up to floor two level.

1.2. Single or double scaffolding may be used. The scaffolding shall be strong and sound. In case single scaffolding is used, the holes shall be carefully made good as directed.

2.0 Mode of measurement & payment

2.1. The relevant specifications of item No. 7.17 (A) shall be followed.

2.2. The rate shall be for a unit of one cubic meter.

7.75. Precast concrete block masonry (including quoin block, jamb blocks, closer etc.) with solid concrete blocks of approved size made of cement concrete 1:3:6 Mix. (1 cement : 3 coarse sand : 6 granted stone aggregate of 20 mm. and down gauge) in foundation and plinth in cement mortar 1:6.

1.0. Materials

(a) Aggregate shall conform to M-12. (b) Sand shall conform to M-6. (c) Cement shall conform to M-3.

1.1. The solid cement concrete blocks shall be precast with concrete of 1:3:6 mix (1 cement: 3 coarse sand : 6 graded stone aggregate)

1.2. A block shall be deemed to be solid if the solid materials is not less than 75% of the total volume of the blocks calculated form overall dimensions.

1.3. The concrete mix used for block shall be one of the following:

1.4. The actual size of the block shall be one of the following:

Size : A. 39 x 30 x 19 cms. Size-B 39 x 20 x 19 cms. Size C 39 x 10 2 19 cms.

The size other than those specified above may be used with the approval of Engineer-in-charge.

1.5. The blocks may be either machine made or hand made. The concrete mix, the mixing of concrete the manufacture of blocks, curing and drying shall be in accordance with para-6 to 10 under I.S. : 2185-1967.

1.6. Faces of blocks shall be flat and rectangular Surface finish shall be rendered smooth or plastered with cement mortar 1:3 coarse sand)

1.7. The average compressive strength of eight blocks when determined in the manner described-in I.S. 2185 - 1967 shall not be less than 50 Kg/Sq. Cm. of gross area. The strength of lowest individual block shall not be less than 75 percent of average compressive strength of eight blocks.

1.8. Concrete blocks shall be stored and stacked properly in such a way as to avoid any contact with moisture at site. They shall be stock plied on planks or other supports free from contact with ground and covered to protect against wetting. Cement mortar of proportion 1:6 shall conform to M-11.

2.0. Workmanship

2.1. The blocks need not wetted before of during laying in the walls. In case climatic conditions so required, the top and the sides of block may only be slightly moistures so as to prevent absorption of water from the mortar and ensure the development of required bond with mortar.

2.2. Operations of laying precast concrete block masonry shall be carried out in accordance with instructions detailed in I.S. : 6042 -1952. The mortar shall not be spread so much ahead of the actual laying of the units that it tends to stiffen and loose, its plasticity, thereby resulting in poor bond. For most of the work, the joints, both horizontal and vertical shall be 10 mm. thick except in the case of extended joint, construction, the mortar joints shall be struck off flush with wall surface and when the mortar has stated stiffening, it shall be compressed with rounded or U-shaped tool. The mortar shall be pressed against the units with a jointing tool after the mortar has stiffened in effect intimate contact between the mortar and the masonry unit and obtained a weather tight joint.

61

2.3. Quoins and closures:

Special quoins blocks (with a return face equal to half the length of normal face) shall be cast for all building blocks and slabs for external work. Proper half closures shall be cast and not cut form full size blocks. The returned ends of blocks for door windows reveals and quoins shall be finished with a fair face in the mould.

2.4. Only double scaffolding shall be used. The scaffolding be strong and sound. No holes in the masonry for supporting shall be allowed.

2.5. **Curing** : The curing of concrete block masonry shall be carried our for 7 days.

3.0. Mode of measurements & payment

3.1. The relevant specifications of item No. 7.6 (I) shall be followed.

3.2. The work of concrete block masonry in foundation and plinth shall be measured under this item.

3.3. The rate shall be for a unit of one cubic meter.

7.82 (A) Precast concrete block masonry in partition walls 10 cms. thick with solid block of approved size (including quoins, blocks, jamb blocks closer etc) made of C.C. 1:3:6 (1 cement : 3 coarse sand : 6 graded stone aggregates 20 mm. and down gauge) in C.M. 1:4.

1.0. Materials:

1.1. The relevant specification of item No. 7.75 shall be followed except that the precast concrete blocks shall be of size suitable for 10 cms. size partition wall i.e. size c and the proportions of cement mortar shall be in cement mortar 1:4 (1 cement : 4 coarse sand).

2.0. Workmanship

The relevant specifications of item No. 7.75 shall be followed except that the work shall be for precast concrete block partition walls of 10 cms. thickness.

3.0. Mode of measurement & payment

3.1. The relevant specifications of item No. 7.75 shall be followed.

3.2. The rate shall be for a unit of one cubic meter.

7.0.0.1. White stone masonry block in coarse in superstructure with stone of approved quality in lime mortar 1:1.5 (1 Lime putty 1:5 find sand) including raking out joints etc. complete.

1.0. Materials:

1.1. The stone or bela shall be white hard sand stone or block. The stone shall be sound hard rough and durable. It shall be free from skin. The thickness of bela or block shall not be less than 15 cms. or as directed. The mortar used shall consist. One part of lime putty and 1.50 parts of fine sand. Lime mortar shall conform to M-10.

2.0. Workmanship

2.1. Dressing of stone:

Stone shall be chiseled on all the sides so that all six sides shall be in a rectangular shape and all the stones shall be so dressed that the bushing of the exposed face shall not project nor depressions for the general wall surfaces. The size of bela or block shall be as per thickness of the wall to be constructed or as directed.

2.3. Laying:

All the stone shall be sufficiently wetted before laying to prevent absorption of water from mortar. All connected Walls in a structure shall normally be raised up uniformly and regularly. The vertical joint shall not be allowed and also it shall not be more than 12 mm. in thickness.

2.3. Proper bonding shall be made by laying bela or block side by side each other with lime mortar on bed as well as in between two bela or block vertically.

2.4. Bond stones:

Bond stones or through stones running right across the thickness of the wall shall be provided in walls up to 450 mm. thick. In thicker walls two bela or blocks or laying each other by at least 150 mm. each other shall be provided across the thickness of the wall to bond stone. Such bond stone shall be at least one for every 1.0 sq. mt. area of the wall surface.

2.5. Joints:

All the joints shall be completely filled up with mortar and their thickness shall not exceed by 12 mm. When plastering or pointing is not required to be done, the joints shall be struck flush and finished, simultaneously while laying the stone. Otherwise the joints shall be raked to a minimum depth of 20 mm. during process of laying while mortar is still green.

2.6. Scaffolding:

Single or double scaffolding shall be used. It shall be strong and sound. The holes left in masonry for supporting shall be made good before plastering.

2.7. Curing:

Green work shall be cured for a period of 7 days continuously.

62

3.0. Mode of measurements & payment

3.1. The work shall be measured on the basis of finished dimensions. No deduction shall be made nor extra payment shall be made for the following:

(a) Ends of joint, beams, posts, girders, rafters, purlins, corbels etc., each up to 500 sq.cms. in section (b) Opening each up to 0.10 Sq.m.(c) Small plates and bed plates, bearing of chhajjas and like up to 10 cms. depth (bearing or floor and roof shall be deducted from masonry), (d) Drain holes and recesses for cement concrete blocks to embedded hold fasts of one cubic meter.

7.0.0.2. White stone bela masonry work in partition walls up to 15 cms. thickness in C.M. 1:4 (1 cement : 4 coarse sand.)

1.0. Materials and workmanship

The relevant specifications of item No. 7.0.0.1 as above shall be followed except that the proportion of mortar shall be in C.M. 1:4 (1 cement : 4 coarse sand.)

2.0. Mode of measurement & payment

2.1. The relevant specifications of item No. 7.6 (I) shall be followed.

2.2. The rate shall be for a unit of one cubic meter.

7.0.0.3. White stone bela masonry block in coarse in superstructure with stone of approved quality in C.M. 1:5 (1 cement: 5 coarse sand) including raking the joints etc. complete.

1.0. Materials and Workmanship

The relevant specifications of item No. 7.0.0 1. as above, except that the proportion of cement mortar shall be in C.M. 1:5 (1 cement : 5 coarse sand)

2.0. Mode of measurement & payment

2.1. The relevant specifications of item No. 7:6 (I) shall be followed

2.2. The rate shall be for a unit of one cubic meter.

7.0.0.4. White stone bela masonry block in coarse in superstructure with stone of approved quality in C.M. 1:6 (1 cement : 6 coarse sand) including raking the joints etc. complete.

1.0. Materials and Workmanship

The relevant specifications of item No. 7.0.0.1 shall be followed except that the proportion of cement mortar shall be 1:6 (1 cement : 6 coarse sand)

2.0. Mode of measurement & payment

2.1. The relevant specifications of item No. 7.6. (I) shall be followed.

2.2. The rate shall be for a unit of one cubic meter.

63

SECTION -9

Centering & Form Work

9.1.(A) Providing form work of ordinary timber planking so as to give a rough finish including centering strutting and propping etc. height of propping and centering below supporting floor to ceiling not exceeding 4 m. and removal of the same for in situ reinforced concrete and plain concrete work in foundation, footings, bases of columns, and mass concrete.

1.0. Materials

1.1. The shuttering to be provided shall be of ordinary timber plank and shall conform to M-26.

1.2. The dimensions of scantlings and battens shall conform to the design. The strength of the wood shall not be less than that assumed in the design.

2.0. Workmanship

2.1. The form work shall conform to the shape lines and dimensions as shown on the plans and be constructed as to remain sufficiently rigid during the placing and compacting of the concrete. Adequate arrangements shall be made by the contractor to safe-guard against any settlement of the form-work during the course of concreting and after concreting. The form work of shuttering, centering, scaffolding, bracing etc. shall be as per design.

2.2. Clearing and Treatment of forms:

2.2.1. All rubbish, particularly chipping shaving and saw dust shall be removed from the interior of the form before the concrete work is placed and the-form in contact with concrete shall be cleaned and thoroughly wetted or treated. The surface shall be then coated with soap solution applied before concreting is done. Soap

solution for the purpose shaft prepared by dissolving yellow soap in water to get consistency of paint. Alternatively a coat of raw linseed oil shall be applied after thoroughly cleaning the surface. Care shall be taken that the coating does not get on construction joint surface and reinforced bars.

2.3. Stripping time:

2.3.1. In normal circumstances and where ordinary cement is used forms may be struck after expire of following periods.

- (a) Sides of walls columns and vertical faces of beams.....24 to 48 hours.
- (b) Beam soffits, (props, left under).....7 days.
- (c) Removal of props slabs:
 - (i) Slabs spanning up to 4.5. m..... 7 days.
 - (ii) Spanning over 4.5 mm..... 14 days.
- (d) Removal of props t beams and Arches:
 - (i) Spanning up to 6 mm..... 14 days.
 - (ii) Spanning over 6 m.....21 days.

2.4. Procedure when removing the form work:

2.4.1. All form work shall be removed without such shock or vibrations as would damage the reinforced concrete surface. Before the soffits form work and struts are removed, the soffits and the concrete surface shall be exposed where necessary in order to ascertain that the concrete has sufficiently hardened

2.5. Centering:

2.5.1. The centering to be provided shall be got approved. It shall be sufficiently strong to ensure absolute safety of the form work and concrete work before, during and after pouring concrete. Watch should be kept to see that behavior or centering and form work is satisfactory during concreting. Erection should also he such that it would allow removal of forms in proper sequence without damaging either the concrete or the forms to be removed.

2.5.2. The props of centering shall be provided on firm foundation or base of sufficient strength to carry the loads without any settlement.

2.5.3. The centering and form work shall, be inspected and approved by the Engineer-in-charge before concreting. But this will not relieve the contractor of his responsibility for strength,-adequacy and safety of form work and centering. If there is a failure of form work or centering, contractor shall be responsible for the damages to property.

2.6. Scaffolding:

2.6.1. All scaffolding, hoisting arrangements and ladders etc., required for the facilitating of conceding shall be provided and removed on completion of work by contractor at his own expense. The scaffolding, hoisting

64
arrangements and ladders etc. shall be strong enough to with sand all live, dead and impact loads expected to act and shall be subject to the approval of the Engineer-in-charge. However contractor shall be solely responsible for the safety of the scaffolding, hoisting arrangement, ladders, work and workman etc. 2.6.2. The scaffolding, hoisting arrangements and ladder shall allow easy approach to the work spot and afford easy inspection.

2.6.3. The rate is applicable to all condition of working and height up to 4 mts. The rate shall include the cost of materials and labour for various operations involved such as:

- (a) Splayed edges, notching, allowance for overlaps and passing at angles, battens centering, shuttering propping, bolting, wedging easing, striking and removal.
- (b) Filleting to form stop chamfered edges or splayed external angles not exceeding 20 mm: width to beams, columns and the like.
- (c) Temporary openings in the forms for pouring concrete, if required removing rubbish etc.
- (d) Dressing with oil to prevent adhesion of concrete with shuttering and.
- (e) Raking or circular cutting.

2.7. Re-Use:

2.7.1. Before re-use, all from shall be inspected by Engineer-in-charge and their suitability ascertained. The forms shall be scarred, cleaned and joints are gone over, repaired where required. Inside surface shall be retreated to prevent adhesion of concrete.

3.0. Mode of Measurements & Payment

3.1. From work shall be measured as the area in square meters to shuttering in contract with concrete except in the case of inclined member and portion of curved profile and upper side in which case on area of underside shall be measured for payment.

3.4. From work to secondary beams shall be measured up to the sides of main beams but no deduction shall be made form the form work of the main beam at the inter section point. No deduction shall be made form the form work of a column at inter section of beams.

3.5. The rate is for the completed item

3.6. The rate shall be for a unit of one sq. meter.

9.1.(A) (i) Extra for providing from work of ordinary timber planking so as to give a rough finish including centering, shuttering and propping etc., height of propping and centering below supporting floor to ceiling is between 4 to 5 m. and removal of the same for in situ reinforce or plain concrete work in foundations, footings, bases of columns etc. and mass concrete.

1.0. Materials workmanship

1.1. The relevant specification of item No. 9.1. (A) shall be followed except they the height of propping and centering below supporting floor to ceiling exceeding 4 m. but not exceeding 5 m.

2.0. Mode of measurements and payment

2.1. The payment shall be made extra over and above the payment made up to 4 m. height. The relevant

specifications of item No. 9.1.(A) shall be followed. The rate shall be for a unit of one sq. meter.

9.1.(B)(i) Providing form work of ordinary timber planking so as to give a rough finish including centering, below supporting floor to ceiling not exceeding 4 m. and removal of the same for in situ reinforced and plain concrete work in flat surface such as soffits of slabs, landing and the like floors etc. up to 200 mm. in thickness.

1.0. Materials & Workmanship

1.1. Relevant specifications of item 9.1. (A) shall be followed except that work is to be carried out for flat surfaces such as soffits of slabs, landings, and the like for floors etc. up to 200 mm, in thickness.

2.0. Mode of measurement and payment

2.1. The relevant specifications of item No. 9.1 (A) shall be followed.

2.2. The rate shall be for a unit of one sq. meter.

9.1.(B)(ii) Providing form work of ordinary timber planking so as to give a rough finish including centering shuttering, strutting and propping etc. height of propping and centering below supporting floor to ceiling not exceeding 4 m. and removal of the same for in situ reinforced and plain concrete work in flat surface such as soffits of slabs, landings, and the like floors etc. above 200 mm. in thickness.

1.0. Materials and Workmanship

1.1. Relevant specifications of item No. 9.1 (A) shall be followed except that the work is to be carried out for flat surfaces such as soffits of slabs, landings, and the like for floors etc. up to 200 mm. in thickness.

65

2.0. Mode of measurement and payment

2.1. The relevant specifications of item No. 9.1 (A) shall be followed.

2.2. The rate shall be for a unit of sq. meter.

9.1.(C) Providing form work of ordinary timber planking so as to give a rough finish including centering shuttering, strutting and propping etc. height of propping and centering below supporting floor to ceiling not exceeding 4 m. and removal of the same for in situ reinforced concrete and plain concrete work in vertical surface such as walls (any thickness) partitions.

1.0. Materials and Workmanship

The relevant specifications of item 9.1 (A) shall be followed except that the form work shall be carried out for vertical surfaces such as walls of any thickness, partitions etc.

2.0. Mode of measurement and payment

2.1. The relevant specifications of item No. 9.1 (A) shall be followed"

2.2. The rate shall be for a unit of sq. meter.

1.0. Materials and Workmanship

1.1. The relevant specifications of item No.9.1 .(A) shall be followed.

1.2. The rate shall be for a unit on one sq. meter.

9.1.(G)(i) Providing form work of ordinary timber planking so as to give a rough finish including centering, shuttering and propping etc. height of propping and centering below supporting floor to ceiling not exceeding 4 m. and removal of the same for in situ reinforced and plain concrete work columns, pillars, posts, and struts, square rectangular, polygonal in plan.

1.0. Materials and Workmanship

1.1. The relevant specification of item No. 9.1. (A) shall be followed except that the work is for columns, pillars, posts and struts, square, rectangular, polygonal in plan.

2.0. Mode of measurement and payment

2.1. The relevant specification of item No. 9.1. (A) shall be followed.

2.2. The rate shall be for a unit of one sq. meter.

9.1.(H)(i) Providing form work of ordinary planking so as to give a rough finish including centering, shuttering, strutting and propping etc. height of propping and centering below supporting floor to ceiling not exceeding 4 m. and removal of the same for in situ reinforced and plain concrete work in side and soffits of beam haunchings, cantilevers, girders, bressumers, and lintels not exceeding 1 m. depth.

1.0. Materials and Workmanship

1.1. The relevant specification of item No. 9.1 (A) shall be followed except that the work is for sides and soffits of beams, haunching cantilevers girders, bressumers and lintels not exceeding 1 M. in depth.

2.0. Mode of measurement and payment

2.1. The relevant specifications of item No. 9.1 (A) shall be followed.

2.2. The rate shall be for a unit of one sq. meter.

9.1.(H)(2) Providing form work of ordinary timber Planking so as to give a rough finish including centering, shuttering, strutting and propping etc. height of propping and centering below supporting floor to ceiling not exceeding 4 m. and removal of the same for in situ reinforced and plain concrete work in sides and soffits of beams, haunchings, cantilevers, girders, bressumers and lintels exceeding 1 m. in depth.

1.0. Materials and Workmanship

1.1. The relevant specifications of item No. 9.1.(A) shall be followed except that the work is for side and soffits of beam haunchings, girders, bressumers and lintels, exceeding 1 m. in depth.

2.0. Mode of measurement and payment

2.1. The relevant specifications of item No 9.1.(A) shall be followed except that the work is for side and soffits of

beams haunching cantilevers, girder bressumers and lintels, exceeding 1 m. in depth.

2.2. The rate shall for a unit of one sq. meter.

9.1.(I) Providing form work of ordinary timber planking so as to give a rough finish including centering, shuttering and propping etc. height of propping and centering below supporting floor to ceiling not exceeding 4 m. and removal of the same for situ reinforced and plain concrete work in edges of slabs and breaks in floor and walls.

66

1.0. Materials and Workmanship

1.1. The relevant specifications of item No. 9.1. (A) shall be followed except that the work is for edges of breaks in floors and walls.

2.0. Mode of measurements and payment

2.1. The length and breadth shall be measured nearest to one Cm.

2.2. The. rate shall be for a unit of one Sq. meter.

9.1.(K) Providing form work of ordinary timber planking so as to give a rough finish including centering shuttering, strutting and propping etc. height of propping and centering below supporting floor to ceiling not exceeding 4 m. and removal of the same in situ reinforced and plain concrete in small surface such as cantilevers ends, brackets and ends of the steps., caps and bases to pilasters and columns and the like.

1.0. Materials and Workmanship

1.1. The relevant specifications of item No. 9.1.(A) shall be followed except that work is for small as cantilever ends, brackets and ends of steps, caps and bases to pilasters and columns and the like.

2.0. Mode of measurement and payment

2.1. The relevant specification of item No. 9.1.(A) shall be followed.

2.2. The rate shall be unit of one sq. meter.

9.1.(I) Providing form work of ordinary timber planking so as to give a rough finish including centering, shuttering, strutting and propping .etc. height of propping and centering below supporting floor to ceiling not exceeding 4 m. and removal of the same for in situ reinforced and plain concrete in chullah hoods, weather sheds, chhajas, corbels etc. including edges.

1.0. Materials and Workmanship

1.1. The relevant specifications of item No. 9.1 (A) shall be followed except that the work is for chullah hoods, weather-sheds, chhajas, corbels, etc. including edges of the same.

2.0. Mode of measurements and payment

2.1. The relevant specification of item No. 9.1. (A) shall be followed.

2.2. The rate shall be for a unit of one square meter.

9.1.(M) Providing form work of ordinary timber planking so as to give a rough finish including centering, shuttering and propping etc. height of propping and centering below supporting floor to ceiling not exceeding 4 m. and removal of the same for in situ reinforced and plain concrete work in staircase with slopping or stepped soffits including risers and stringers excluding landing.

1.0. Materials and Workmanship

1.1. The relevant specifications of item No. 9.1.(A) shall be followed except that the work is for staircases, with slopping or stepped including risers and stringers excluding landing.

2.0. Mode of measurements and payment

2.1. The relevant specifications of item No. 9.1. (A) shall be followed.

2.2. The rate shall be for a unit of one sq. meter.

9.1.(Q) Providing form work of ordinary timber planking so as to give a rough finish including centering shuttering, strutting and propping etc. height of propping and centering below supporting floor to ceiling not exceeding 4 m. and removal of the same for In situ reinforced and plain concrete work in vertical fins and vertical sun-breakers.

1.0. Materials and Workmanship

1.1. The relevant specifications of item No. 9.1. (A) shall be followed except that the work is for vertical fins and vertical sun breakers.

1.2. The rate shall be for a unit of one sq. meter.

9.7. Extra for providing form work with sweating of steel sheets so as to give a fair finish in :

(A) Foundation, footings, base of columns etc. mass concrete.

(B) Flat surfaces such as soffits, of slab landing and the like.

(i) Floors etc. up to 200 mm. in thickness.

(ii) Floors etc. above 200 mm. in thickness.

(C) Vertical surfaces such as walls (Any thickness) partitions.

(D) Columns, pillars posts and struts.

67

1. Square, rectangular, bressumers, and lintels not exceeding 1 mm. depth.

2. Sides and soffits and beams, beam haunchings, cantilevers, girders, breassumers and lintels exceeding 1 mm. in depth.

(I) Edges of slabs, and breaks in floors and walls.

(K) Small surfaces such as cantilever ends, brackets, and ends of steps, caps and bases to pillars and columns including edges.

(L) Chollar woods, weather sheds, chhajjas, corrodes etc. and the like.

(M) Stair cases sloping or stepped soffits, including risers, skidders excluding landing.

(O) Vertical fine and vertical sun breakers.

1.0. Materials and Workmanship

1.1. The relevant specification of item No. 9.1 (A) to (Q) shall be followed except that the extra rate shall be paid for using sheathing of steel sheets, and plates of steel or plywood instead of ordinary timber plank, to obtain a desired smooth exposed finish of surface. The surface shall be presentable without further treatment.

2.0. Mode of measurements and payment

2.1. The measurement of form work shall be taken for the work done with steel sheathing, extra over and above the rate of form work of respective item ' from work done. The relevant specification of respective item No. 9.1. (A) to (Q) shall be followed.

2.2. The rate shall be for a unit of one sq. meter.

68

SECTION 10

Wood Work, Doors & Windows

10.1.(A) Providing wood work in frames of doors, windows, clerestory windows and other similar work, Wright, framed and fixed in position, Indian Teak wood.

1.0. Materials

Wooded in frames shall conform to M-29.

2.0. Workmanship

2.1. The item covers the requirement of frames for doors, windows, clerestory windows, their supply and fixing.

2.2. Frames:

2.2.1. All members of frames shall be exactly at right angles. The right angle shall be checked from inside surfaces of the-frames of the respective members.

2.2.2. All members of frames shall be straight without any warp of bow and shall have smooth surfaces well planed on the three sides exposed at right angles to each other. The surfaces touching the wall may not be planed unless it is required in order to straighten up the member or to obtain the overall sizes within the tolerances as specified.

2.2.3. Frame shall have dovetail joints. When clerestory windows in included, it shall be provided by having full length one piece post for door or windows and clerestory window extending the frame on top at the head to the required extent. Horns shall not be provided in the head of the frame. When no sills are provided, the vertical posts of the frame in the ground floor shall be embedded in the sill masonry for 10 cm. on upper floors, the vertical posts shall be fixed in the floor or masonry by forming notches 10 mm. deep. Slight adjustment of spacing as necessary shall be done to have the hold fasts in the joints of masonry; course. The frame shall be erected in position and held plumb with strong support form north sides and built in masonry as it is being built. The transom shall be through tenoned into the mortises of the jamb pot to the full width of the jamb post and the thickness of the tenon shall be not less than 15 mm.

2.3. Tolerance:

Unless specially mentioned otherwise tolerance of + 1.5. mm shall be allowed for each wrought face.

2.4. The tenons shall be closely fitting into the mortises and suitably pinned with wood dowels not less than 10 mm. dia. meter. The depth of rebates for housing the shutter shall be as shown in the detailed drawing or as directed.

2.5. The concrete surface of tenon and mortise shall be treated before putting together with an adhesive of approved make.

2.6. Minimum number of three hold-fasts shall be fixed on each side of door and windows frames, one at the center point and the other two at 30 mm. from the top and bottom of the frames. In case of windows and ventilators frames. The size c. each hold-fast shall be 300 x 25 x 6 mm. and of mild-steel with split end. The hold fasts shall be fixed with screws to frames.

2.7. Mild steel hold fasts shall be protected with a coating of coal asphalt tar. The surface of frame abutting the masonry or concrete faces shall be properly treated by applying a coat of approved coating.

3.0. Mode of Measurements and payment

3.1. The linear dimensions shall be measured correct up to 1 cm. The quantity shall be worked out correct to places of decimals of cu. m.

3.2. The rate shall be for a unit of 10 cu. diameter.

10.4.(A) Providing work in trusses, purloins, falters, posts, post plates, wall plates, and like wrought, framed, hoisted and fixed in position, Indian teak wood.

1.0. Materials

The teak wood shall conform M-29.

2.0. Workmanship

2.1. The relevant specifications of item No. 10.1.(A) shall be followed except that wood work shall be carried mi* in trusses, purloins, falters, posts, plates, wall plates and like wrought framed.

2.2. The work shall be carried out as per detailed drawings supplied by the Department as directed;

2.3. The length of the each member shall be in one piece or as directed.

3.0. Mode of measurement and payment

The length, breadth and depth shall be measured nearest to 1 cm. of unfinished member. The rate shall be for a unit of 10 cubic Decimeter.

69

10.5. (A) Providing wood work in frames of false ceiling partition etc. swan and put up in position,

Indian teak wood.

1.0. Materials

The teak wood shall conform to M-29.

2.0. Workmanship

The relevant specification of item No. 10.1.(A) shall be followed except that the wood work shall be for false, ceiling, partitions, etc. swan and put in position.

3.0. Mode of measurement and payment

3.1. The relevant specifications of item No. 10.1.(A) shall be followed.

3.2. The rate shall be for a unit of Ten cubic Decimeter.

10.12.(A)(i) Providing and fixing 35 mm. thick fully paneled shutters for doors, windows and clerestory windows including anodised aluminum butt hinges with necessary screws. Indian Teak Wood.

1.0. Materials.

1.1. Wood for shutter shall conform to M-29. 2. Glass shall conform to M-38. 3. Anodised aluminum butt hinges shall conform to M-43.

2.0. Workmanship

2.1. The item covers the requirement of preparation of shutters for doors, windows, clerestory windows, their supply and fixing.

2.2. Shutters:

2.2.1. Paneled shutters shall be constructed in the form of timber frame work of styles and rails with panel inserted of type as specified in the detailed drawings. Panel shall be fixed by providing grooves in the style and rails. The styles and rails shall be joined to each other by mortise and tenon joints at right angles.

2.2.2. All members of the shutters shall be straight without any warp or bow and shall have smooth, well planed faces at right angles to each other.

2.2.3. The size of styles and rails shall be as per drawings or as directed. Styles and rails of shutters shall be made of one piece only.

2.3. Timber paneling:

2.3.1. Thickness of the panel shall be as specified in the item as shown in the drawing or as directed. If the panel is made from more than one piece the pieces shall be finished as shown in the detailed drawings and shall be joined with continuous groove with specified size. The end pieces of the panel and the top and bottom of the panel shall be provided with continuous tongue to frame into groove of the frame shutter. An air space of 1.5 mm. shall be left in the groove of frame of shutter while framing the panels in it.

2.3.2. The faces of the panel as well as various pieces of the panel shall be- closely fitted to the sizes of the grooves.

2.3.3. Finishing of the corners of raised panel edges shall be done as shown in drawings or as directed.

2.3.4. The thickness specified shall be finished thickness and no tolerance will be permitted.

2.5. Fixtures and Fastenings:

2.5.1. The rate shall include anodised butt hinges including fixing with iron screws. The size and number of hinges shall be as per table given in annexure-1.

3.0. Mode of measurement and payment

3.1. The rate for shutter includes cost of providing block and cleat for keeping the shutter in open position if directed.

3.2. The dimension of the shutter shall be measured clear size of the shutter in close position between the grooves of the frame.

3.3. The rate shall be for a unit of one sq. meter.

19.12.(A)(II) Providing and fixing 35 mm. thick fully shutters for doors, windows and clear story windows including anodised aluminum butt hinges with necessary screws, Indian teak wood.

1.0. Materials

Teak wood shall conform to M-29 Glass shall conform to M-38. Anodised aluminum butt hinges shall conform to M-43.

2.0. Workmanship

2.1. The relevant specifications of item No. 10.12 (A) I shall be followed except that the 35 mm. thick shutters full glazed for doors, windows and clear story windows including anodised aluminum butt hinges with necessary screws.

70

2.2. Glazing:

2.2.1. The glass panels shall be embedded in putty and secured to the rebate by wooden beads, or moulding shape and size as approved with counter sunk screws of suitable size.

2.2.2. The glass panels shall be properly cut to fit the rebates of the frames and sashes fully with a slight minus margin of about 1.5. mm. on all sides. Before blazing, the frame shall be primed and prepared for painting so that wood may not draw oil out of putty. The rebate shall be putted to an extent to provide bedding all round the glass.

2.2.3. The glass shall then be bedded in putty and fitted to frames with wooden heads or moulding as directed and secured with counter sunk screws. The screws shall be spaced not more than 100 mm. from each corner and not more than 200 mm. apart.

2.2.4. The size of the rebate in the frame and size and shape of beads of moulding shall be as per detailed drawings or as directed. The beads or mouldings shall have mitered corners.

3.0. Mode of measurement and payment

3.1. The relevant specifications of item No. 10.12 (A) (I) shall be followed.

3.2. The rate shall be for a unit of one sq. meter.

10.12(A)(III) Providing and fixing 35 mm. thick partly paneled and partly glazed shutters, or doors,

windows, including anodized aluminum butt hinges with necessary screws, Indian teak wood.

1.0. Materials

Teak wood shall conform to M-29. Glass shall conform to M-38. Anodised aluminum but hinges shall conform to M-43.

2.0. Workmanship

The relevant specifications of item No. 10.12.(A) (II) shall be followed except that the 35 mm. thick shutter shall be partly paneled and partly glazed for doors, windows, clear story windows etc. as per drawings.

3.0. Mode of measurement and payment

3.1. The relevant specifications of item No. 10.12 (A) (I) shall be followed.

3.2. The rate shall be for a unit of one sq. meter,

10.13.(A)(I) Providing and fixing 35 mm. thick full paneled, shutters for doors, windows and clear story windows including black enameled M.S. Butt, hinges with necessary screws, Indian Teak Wood.

1.0. Materials & Workmanship

1.1. The relevant specifications of item No. 10.12 (A) (II) shall be followed except that the hinges shall be of black enameled M.S. Butt hinges. The hinges, bolts and other items of iron mongery with moving parts shall be properly oiled by the contractor before handing over the building.

2.0. Mode of measurement and payment

2.1. The relevant specifications of item No. 10.12 (A) (I) shall be followed.

2.2. The rate shall be for a unit of one sq. meter.

10.13.(A)(II) Providing and fixing 35 mm. thick full glazed shutters for doors, windows and clear story windows including black enameled M.S. Butt, hinges with necessary screws, Indian Teak Wood.

1.0. Materials & Workmanship

1.1. The relevant specifications of item No. 10.12 (A) (II) shall be followed except that the hinges shall be of black enameled M.S. Butt hinges. The hinges bolts and other items of iron mongery with moving parts shall be properly oiled by the contractor before handing over the building.

2.0. Mode of measurement and payment

2.1. The relevant specifications of item No. 10.12 (A) (I) shall be followed:

2.2. The rate shall be for a unit of one sq. meter.

10.13(A)(III) Providing and fixing 35 mm. thick partly paneled and partly glassed shutters for doors, windows, and clearstory windows including black enameled M.S. Butt hinges with necessary screws, Indian Teak Wood.

1.0. Materials & Workmanship

The relevant specification of item No. 10.12 (A) (III) shall be followed except that the hinges shall be of black enameled M.S. butt hinges, bolts and other items of ironmongery with moving parts shall be properly oiled by the contractor before handing over the building.

2.0. Mode of measurements & payment

2.1. The relevant specifications of item No. 10.12. (A) (I) shall be followed.

2.2. The rate shall be for a unit of one sq. meter.

71

10.15.(A)(I) Providing and fixing 25 mm. thick paneled, shutters for cup-boards etc. including anodised aluminum butt hinges with necessary screws, Indian Teak Wood.

1.0. Materials

First class Indian teak wood for shutters shall conform to M-29. Glass shall conform to M-38. Anodised aluminum butt hinges shall conform to M.43.

2.0. Workmanship

2.1. The relevant specification of item No. 10.12. (A) (I) shall apply except that the thickness of shutter shall be 25 mm. for cup-boards.

3.0. Mode of measurement & payment

3.1. The relevant specifications of item No. 10.12 (A) (I) shall be followed.

3.2. The rate shall be for a unit of one sq. meter.

10.15.(A)(H) Providing and fixing 25 mm. thick fully glazed shutters for cup-boards etc. including anodised aluminum butt hinges with necessary screws, Indian teak wood.

1.0. Materials & Workmanship

The relevant specifications of item No. 10.12.(A) (I) and 10.12 (A) (II) shall be followed except that the thickness of shutters shall be 25 mm. thick and partly paneled and partly glazed shutters as per drawings for cup-boards.

2.0. Mode of measurements and payment

2.1. The relevant specifications of item No. 10.12 (A)(I) shall be followed.

2.2. The rate shall be for a unit of one sq. meter.

10.15.(A)(IH) Providing and fixing 25 mm. thick partly paneled and partly shutters for cub-boards etc. including anodised aluminum butt hinges with necessary screws, Indian teak wood.

1.0. Materials & Workmanship

The relevant specifications of item No. 10.12.(A) (I) and 10.12 (A) (II) shall be followed except that the thickness of shutters shall be 25 mm. thick and partly paneled and partly glazed shutters as per drawings for cupboards.

2.0. Mode of measurements and payment

2.1. The relevant specifications of item No. 10.12 (A)(I) shall be followed.

2.2. The rate shall be for a unit of one sq. meter.

10.16.(A)(I) Providing and fixing 25 mm. thick fully paneled, shutters for cup-boards etc., including black enameled M.S. butt hinges with necessary screws, Indian Teak Wood.

1.0. Materials & workmanship

1.1. The relevant specifications of item No. 10.12 (A) (I) shall apply except that the wood for shutters shall be Indian teak wood and black enameled M.S. Butt hinges are to be used instead of anodised aluminum butt hinges and thickness of shutter shall be 25 mm.

2.0. Mode of measurements & payment

2.1. The relevant specifications of item No. 10.12. (A) (I) shall be followed.

2.2. The rate shall be for a unit of one sq. meter.

10.16.(A)(H) Providing and fixing 25 mm. thick fully glazed shutters for a cup-boards etc., including black enameled M.S. Butt hinges with necessary screws, Indian Teak Wood.

1.0. Materials & Workmanship

The relevant specifications of item No. 10.15.(A) (I) shall be followed except that the fully glazed shutters of 25 mm. thickness shall be of India Teak Wood fixed in position with black enameled butt hinges for cup-boards.

2.0. Mode of measurements & payment

2.1. The relevant specifications of item No. 10.12 (A) (I) shall followed.

2.2. The rate shall be for a unit of one sq. meter.

10.16.(A)(II) Providing and fixing 25 mm. thick partly paneled and partly glazed shutters for cupboards etc., including black enameled M.S. butt hangs with -necessary screws. Indian Teak Wood.

1.0. Materials

The relevant specifications of item No. 10.15 (A) (I) & 10.15 (A) (II) shall be followed except that the shutters shall partly paneled and partly glazed of 25 mm. thickness of Indian Teak Wood fixed with black enameled butt hinges for cup-boards.

2.0. Mode of measurement & payment

2.1. The relevant specifications of item No. 10.12 (A) -shall be followed. 12. The rate shall be for a unit of one sq. meter.

72

10.23. Providing and fixing 35 mm. thick paneled glazed or paneled and glazed shutters for doors, windows, and clearstory windows including anodised aluminum butt hinges with necessary screws. Indian Teak Wood shutters with (A) Plywood,(B) Particle, (C) Hard Board, (D)

Asbestos Sheet panels.

1.0. Materials

Indian teak wood for shutters shall conform to M-29. Glass shall conform to M-38.

(A) Plywood shall conform to M-37.

(B) Particle board shall conform to M-40. Anodised aluminum butt hinges shall conform to M-43.

(C) Hard board shall of best quality and shall be as approved by Engineer-in charge.

(D) A.C. sheet shall conform to M-24.

2.0. Workmanship

2.1. The relevant specifications of item No. 10.12 (A) (I) shall apply to this item except that the work is shuttered with (A) plywood (B) particle board (C) hard board panels (D) A.C. sheets panels as specified in item.

2.2. The shutter shall be prepared by fittings styles and rails (top, bottom, lock and frieze) as for paneled leaves with simple chamfer on edge only. The styles and rails shall be grooved with just sufficient width for receiving panels and plain panels of specified type panels shall be fitted into the grooves.

3.0. Mode of measurements & payment

3.1. The relevant specifications of item No. 10.12 (A) (I) shall be followed.

3.2. The rate shall be for a unit of one sq. meter.

10.24. Providing and fixing 35 mm. thick paneled, glazed or paneled and glazed shutters for doors, windows and clearstory windows including black enameled M.S., butt hinges with necessary screws. Indian Teak Wood shutters with (A) Plywood (B) Particle board (C) Hard Board (D)

Asbestos panels.

1.0. Materials & Workmanship

1.1. The relevant specifications of item No. 10.23 shall be followed except that the hinges shall be of black enameled M.S. Butt hinges instead of anodised aluminum butt hinges and shutter with (A) Plywood (B) Particle board (D) Hard Board (D) Asbestos sheet panels as specified in item.

2.0. Mode of measurement & payment

2.1. The relevant specifications of item No. 10.12 (A) (I) shall-be followed.

2.2. The rate shall be for a unit of one sq. meter.

10.30. Providing & fixing flush door shutters, solid core construction with frame of 1st class hard wood with cross band and face veneer or plywood face panels including anodised aluminum butt hinges with necessary screws (B) Non-decorative type and block board core. (2) 35 mm. thick.

1.0. Materials

Flush door shall conform to M-30. Plywood shall conform to M-37. Anodised aluminum butt hinges shall conform to M-43.

2.0. Workmanship

2.1. The relevant specifications of item No. 10.23 shall be followed except that the shutters be non decorative type and block board core with face veneer or plywood with 35 mm. thickness.

2.2. Ready made shutters shall be of correct size and shall fit into the door or other openings without excessive scraping of edges. Adding of battens etc., to make up to the size shall not be allowed.

3.0. Mode of measurement & payment

3.1. The relevant specification of item No. 10.12 A (I) shall be followed.

3.2. The rate shall be for a unit of one sq. meter.

10.37. Extra for using bright finished M.S. Piano hinges instead of anodised aluminum butt hinges in flush door shutter (A) Nickel Plated Piano hinges.

1.0. Materials and workmanship

1.1. The relevant specification of item No. 10.30 shall be followed except that the nickel plated piano hinges shall be provided and fixed. It shall conform to the latest Indian Standards and shall be got approved by the Engineer-in-charge.

2.0. Mode of measurement & payment

2.1. The extra payment shall be made on sq. M. basis of door over and above item No. 10.30 for providing finish M.S. planed hinges instead of anodised aluminum butt hangs.

2.2. The rate shall be for a unit of one sq. meter.

73

10.39. Extra for providing vision panel not exceeding 0.1 sq. m. in all types of flush doors. (A) Rectangular square.

1.0. Materials and workmanship

1.1. The relevant specification of item No. 10.30 shall be followed except that the vision panel not exceeding 0.1 sq. m. shall be provided.

1.2. The glass panels shall conform to M-38 and this item is extra work of providing vision panel rectangular or square not exceeding 0.1 sq. in all types of flush doors.

2.0. Mode of measurements & payment

2.1. The payment shall be made over of item No. 10.30 for this extra work on shutter in which visions panels are provided.

2.2. The rate shall be for a unit of one sq. meter of door area.

10.51. Providing and fixing 30 mm. thick wire gauze shutters using galvanised M.S. Wire of I.S. gauze designation 85-G with wire of 0.56 mm. dia butt hinges with necessary screws : Indian Teak Wood.

1.0. Materials

Wire gauze ail shall conform to M-36. The teak shall conform to M-29. Anodised aluminum butt hinges shall conform to M-43.

2.0. Workmanship

2.1. Specification for item No. 10.12 A(I) shall be adopted for shutter and fixtures and fastenings except thru 30. mm. thick wire gauze shutter shall be provided.

2.2. Wire gauze shuttering:

2.2.1. The finished sizes of the wooden components like styles, rails, mountings, shall be as per the paneled doors. Each leaf shall have 2 panels of wire gauze as per drawings or as directed.

2.2.2. The styles, rails etc. shall be rebated 12 mm. along the side where they receive the gauze The galvanised iron webbing of 0.56 mm. dia mesh shall be used unless otherwise specified. The webbing shall be at 90 to 12 mm. along both sides of the rebate and fixed securely to the styles and rails and fillets of the size 10 mm x 10 mm, shall be securely and neatly fixed with small screws, spaced about 7.5. cm. centers round the rebate for each panel of webbing,- After the fillets are pressed well into the angle io hole the gauze hi two faces, the exposed edge of fillets shall be neatly rounded. The gauze shall be tightly stretched during fixing The space between the fillet and the rebate where the webbing is bent shall be neatly finished with putty, so that cut end of webbing may not be visible. Each shutter shall be fitted with a pair of anodised aluminum but! hinges with necessary iron screws.

3.0. Mode of measurement & payment

3.1. The relevant specifications of item No. 10.12 shall be followed.

3.2. The rate shall be for a unit of one sq. meter.

10.53. Providing and fixing 30 mm. thick wire gauze shutters using galvanised M.S. wire of wire gauze designation 85 G with wire of 0.56 mm. dia. for doors, windows, and clerestory windows including bright finished or/and black enameled M.S. butt hinges with necessary screws. Mango wood or equivalent quality.

1.0. Materials & workmanship

The relevant specification of item No. 10.51 shall be followed except that the hinges to be used shall be bright finish or/and black enameled M.S. butt hinges with screws and the wood shall be used of Mango wood or equivalent quality of non teak wood.

2.0. Mode of measurement and payment

2.1. The relevant specification of item No. 10.12 shall be followed.

2.2. The rate shall be for a unit of one sq. meter.

10.54. Extra for providing and fixing galvanised M.S. gauze of I.S. gauge designation 140 G. to doors windows and clerestory windows with wire of dia 0.71 mm. instead of I.S. gauge designation 85 G. with wire of dia. 0.56 mm.

1.0. Materials & workmanship

1.1. The relevant specification for item no. 10,51 & 10.53 shall be followed for this item except that the diameter of wire shall be 0.71 mm. of I.S. gauge designation 140 G. instead of 596 G. diameter I.S. gauge designation 85 G.

2.0. Mode of measurements and payment

2.1. The payment shall be made extra over and above the payment for galvanised M S wire gauge.

2.2. The rate I.S. gauge designation 85 G. shall of one sq. mt of size of doors and windows shuttles
74

10.74. Providing and fixing 12 mm. thick and 100 mm. wide pellet of flat pressed 3 layer veneered particle board solid core with 25 mm. diameter aluminum curtain rod brackets including fixing with 25 mm. x 3 m. M.S. flat 10 long and plug etc. comp.

1.0. Materials

(1) 3 layers veneered particle board solid core snail-conform to M-40 25. mm. diameter aluminum curtain rod and 25 mm. x 3 mm. x 10 cms. long M.S. flat and plugs shall of best approved quality as directed.

2.0. Workmanship

The work shall be done as per drawing and description given in the item of work. The wooden planks shall be planed smooth and oven on the exposed surface.

The pellet shall be fixed Jo level by means of 10 cms. long x 25 mm. x 3 mm. M.S. flat brackets lent in the form of angle and wooden plug fixed in the walls using wood screws. For pelmet up to 1.5 meter long two such brackets shall be used and additional bracket provided for longer pelmet at the rate of one per meter length extra. The curtain rods be fixed by suitable brackets at the ends to the pelmet as directed.

3.0. Mode of measurement and payment

3.1. Pelmet shall be measured in running meters along the sides and face.

3.2. The rate shall be for a unit of one running meter.

10.84. Providing and fixing 40 mm. paneled, glazed or paneled and glazed partitions fixed to frames with iron screws etc., complete with India teak wood (Frames to be paid separately)

1.0. Materials

Indian Teak wood shall conform to M-29. Glass shall conform to M-38. Iron screws on shall of best approved quality. Plywood asbestos shall conform to relevant specification of materials.

2.0. Workmanship

The work shall be done as per detailed drawing or as directed. The wooden frames shall be of sizes as indicated in the drawing and description of item. They shall be planed and finished smooth and even. The vertical styles and rails shall be framed by tenon and mortise joints.

The panels which may be of planks, asbestos, plywood, glass or any other materials specified shall be fixed in the grooves made in styles and rails or by means of rebate and beading fixed by suitable screws. When glazing is used as panels the glass shall be fixed by using putty in addition to beading, (he putty shall be used before applying material.

3.0. Mode of measurement and payment

Partitions shall be measured in square meters of the net area of the tiller materials provided. The rate shad be for a unit of one sq. meter.

10.85. Providing and fixing decorative plywood 4 mm. thick in portions including fixing to frames with screws etc., complete with 50 mm. x 12 mm. teak wood beading (Frames to be paid separately)

1.0. Materials

4 mm. thick decorative plywood shall be of best approved quality. Teakwood beading and screws shall of best approved quality as directed.

2.0. Workmanship

The relevant specifications shall be same, as per that of item No. 10.84 expect that partitions shall be with 4 mm. thick decorative plywood and with teakwood beading.

3.0. Mode of measurements and payment

The specifications shall be same as that of item No. 10.84. The rate shall be for a unit of one square meter.

10.86. Providing an fixing plain Asbestos cement sheet 6 mm. thick in partition including fixing to frames with screws etc., complete with 50 mm. x 12 mm. deodar wood beading (Frames to be paid separate)

1.0. Materials

Plain A.C. Sheets shall conform to M-24. Deodar wood beading shall conform to M-29. A.

2.0. Workmanship

The relevant specification of item No. 10.84 shall be followed same except that plain asbestos cement sheet 6 mm. thick shall be used in partition and Deodar wood beading of size 50 x 12 mm. size shall be used.

3.0. Mode of measurement and payment

3.1. The relevant specifications of item No. 10.84 shrill pp followed except that the rate excludes cost of frame work.

3.2. The rate shall be for a unit of one square meter.

75

10.88. Providing and fixing in partition 4 mm. thick medium hard board approved quality including fixing to frames with screws etc., complete with 50 x 12 mm. Teak wood beading (Frame to paid separated)

1.0. Materials

The hard board shall be 4 mm. thick and of best quality and made as approved. Teak wood beading shall conform to M-29.

2.0. Workmanship

The relevant specifications of item No. 18.84 shall he followed except that the hard board of 4 mm. thickness shall be used in partition and teak wood beading 50 x 12 mm. size shall be used.

3.0. Mode of measurements and payment

3.1. The relevant specifications of item No. 10.84 shall be followed except that the rate excludes cost of frame work.

3.2. The rate shall be for a unit of one square meter.

10.96. 26 mm. thick wooden shelves supported on 40 x 40 x 6 mm. T or Iron brackets fixed at suitable distances not exceeding 75 cms. apart with Mango wood or equivalent quality.

1.0. Materials

The mango wood shall conform to M-29-A. Structural steel shall conform to M-22

2.0. Workmanship

The mango wood or equivalent quality (not teak wood shelves shall be prepared from 25 mm. thick planks. The planks shall be planed smooth. The planks shall be used in single piece up to 30 cms. width. The shelves shall be fitted in position by fixing 40 x 40 x 6 mm. T or L Iron brackets. The spacing of brackets shall not be more than 75 cms. The 40 x 40 x 6 mm. T or L from brackets shall be fixed firmly in position by imbedding the same in concrete. The shelves shall be fixed as directed. The season teak wood buttons of size 35 x 12 mm. shall be fixed on open side as directed.

3.0. Mode of measurements and payment

3.1. The shelves shall be measured in Sq. meter. The length and breadth of shelves shall be measured net.

3.2. The rate is inclusive of button provided:

3.3. The rate shall be for a unit of one sq. meter.

10.97. 40 mm. thick wood shelves supported on 40 x 40 x 6 mm. T or L Iron brackets fixed at suitable distance but not exceeding 75 cms. apart with mango wood or equivalent quality.

1.0. Materials & Workmanship

The relevant specifications of item No. 10.96 shall be followed except that the thickness of shelves shall be 40 mm Thick teak wood buttons shall be provided of 50 x 12 mm. on all open sides.

2.0. Mode of measurements & payment

2.1. The relevant specifications of item NO. 10.96 shall be followed.

2.2. The rate shall be for a unit of one square meter.

10.99. Providing and fixing M.S. round or square bars with M.S. flats at required spacing in wooden frames of windows and clerestory windows.

1.0. Materials

M.S. bars and flats shall conform to M-18 and M-22 respectively.

2.0. Workmanship

2.1. The M.S. bars shall be fabricated as shown in the drawing or as directed. It shall conform to I.S. 226-1975 and I.S. 96 and I.S. 1977-1975. The M.S. bars shall be fixed at the required spacing in mild steel flats, after drilling holes in the latter. The diameter and spacing of these bars shall be as mentioned in the drawing or as directed. The bars shall be passed through drill holes drilled into the mild steel flats, fixed in the recess in frames. The flats shall be fixed with iron screws.

3.0. Mode of measurements & payment

3.1. The rate shall be for the M.S. round or square bars with M.S. flats provided and fixed in position as per the specifications for the completed item.

3.2. The rate shall be for a unit of one Kg

10.100. (A) Providing and fixing M.S. Grills of required pattern to wooden frames of windows etc., with M.S. flats at required spacing and frame around, square, or round bars with round headed bolts and nuts or by screws : plain Grill.

1.0. Materials

The structural steel shall conform to M-22

76

2.0. Workmanship

2.1. The M.S. Grill shall be prepared as per the drawing or as directed for fixing to wooden frames of windows etc.

2.2. The grill shall be fabricated to the designs and patterns shown in the drawings and the weight shall be as directed, and the joints shall be reverted or welded as shown in the plan or as directed. The grill so formed shall be fixed into the frames of the windows etc. before they are erected in position. The outside strip frame of the grill shall be housed to its full thickness into the recess cut into the frame of the windows etc. The grill shall be fixed to the frame with number of bolts and nuts or screws viz. bolt nut/screw per 30 cm. of the length of outer strip subject to minimum of 2 Nos. on each side of the frame or as indicated in the drawing or as directed.

2.3. The bolts and nuts or screws shall be counter sunk and shall be fixed with the top of their heads flush with the face of the frame strips.

3.0. Mode of measurements & payment

3.1. No payment shall be made for weight of screws, bolts nuts etc. only weight of grill shall be paid.

3.2. The rate shall be for a unit of one kg.

10.100. (B) Providing and fixing M.S. Grill of required pattern to wooden frames of windows etc. with M.S. plates, at required spacing and frame around, square or round bars with round headed bolts and nuts or by screws and with ornamental grill.

1.0. Materials & Workmanship

1.1. The relevant specification of item no. 10.100 (A) shall be followed except that the work is for ornamental grill.

2.0. Mode of measurements & payment

2.1. The relevant specifications of item No. 10.100 (A) shall be followed.

2.2. The rate shall be for a unit of one Kg.

10.102. Providing and fixing hard drawn steel wire fabric 75 x 25 mm. mesh of weight not less than 7.75 kg. per sq.M to window frames etc, including 60 x 20 mm. beading of teak wood.

1.0. Materials

Hard drawn steel wire of 75 x 25 mm. mesh shall conform to M-34. Teak wood beading shall conform to M-29.

2.0. The steel wire fabric 75 x 25 mm. mesh of weight of not less than 7.75 kg per Sq.M. to windows frames etc. shall be fabricated as per detail drawings. The wire fabric shall be fixed to windows frame by teak wood beading of 60 x 20 mm. size be by means of screws.

3.0. Mode of measurements & payment

3.1. The wire mesh (Hard drawn) shall be measured net clear opening of frame of windows in which mesh is fitted. Nothing shall be paid extra for fixing mesh in groove below teak woods-beading.

3.2. The rate shall be for a unit of one sq. meter.

10.103. Providing and fixing fly proof galvanised M.S. Wire gauge of I.S, Gauge designation 85 G. with wire of dia. 0.56 mm. to windows and clerestory windows including 60 x 20 mm. beading of Indian Teak Wood.

1.0. Materials

The fly proof galvanised M.S. wire gauge shall conform to M-36. Teak wood .beading shall conform to M-29. 2.0. Workmanship

The relevant specifications of item No. 10.102 Shall be followed except that fly proof galvanised M.S. wire gauge of I.S. gauge designation 85-G with wire of 0.56 mm. shall be provided.

3.0. Mode of measurement & payment

3.1. The relevant specifications of item No. 10.102 shall be followed.

3.2. The rate shall be for a unit of one square meter.

10.120. Providing and fixing first class Indian teak wood, 75 x 60 mm. moulded hand rails in , straight lengths completed.

1.0. Materials

First class Indian teak wood shall conform to M-29.

77

2.0. Workmanship

The teak wood hand rail shall be of size 75 x 60 mm. The hand rail shall be prepared from first class Indian teak wood. The hand rail shall be moulded as per detail drawings. The hand rail shall be fixed in straight length as per detail drawings with screws. The relevant specifications of item No. 10.4 shall be followed except that the teak wood work shall be for a railing of specified size.

3.0. Mode of measurements & payment

3.1. The hand rail shall be measured in running meter.

3.2. The rate shall be for a unit of one running meter.

10.0.0.(I) Providing and fixing glazed louvered Glass windows and ventilators with teak wood frame 10 x 75 mm. size including 3 coats of oil painting to wood work etc. complete,

1.0. Materials

Indian teak wood shall conform to M-29. Glass shall conform to M-38.

2.0. Workmanship

The relevant specifications of item No. 10.1 (A) shall be followed for frame work except that the frame work of 10 x7 cms. size of required size ventilators shall be provided with glazed glass louvers. The glass louvers shall be provided as directed. In the groove of 1.25 cms. depth made in frames, the thickness of glass shall be 5 mm. and glass shall be glass of best quality. The ventilation blades shall slope done towards the outside at an angle of 450.

3.0. Mode of measurements and payment

3.1. The area of opening within the frame in which louvers are fixed shall be measured in sq. meters.

3.2. The rate included painting 3 coats to wood work with ready mix paint.

3.3. The rate shall be far a unit of one square meter.

10.0.0.(II) Providing & fixing with wooden louvers plank 12 mm. thick windows and ventilators with teak wood frame 10x7 cms. size including 3 coats of oil painting to wood etc complete.

1.0. Materials & Workmanship

The relevant specifications of item No. 10.00 (I) shall be followed except that the teak wood planks 12.00 thick louvers shall be provided.

2.0. Mode of measurements & payment

2.1. The relevant specifications of item No. 10.00 (I) shall be followed.

2.2. The rate shall be for a unit of one square meter

78

SECTION-11

Steel Shutters, Windows, Ventilators

11.2. (A) Steel work riveted, in built up sections, framed work including cutting, hosting fixing in position and applying a priming coat of red lead paint. In beam and joints, channels, angles tees, flats, with connecting plates or Angle cleats as in main & cross beams, Hop and jack falters, pralines connected to common rafters and the like.

1.0. Materials

The structured steel work shall conform to M-22. Red lead paint shall conform to I.S : 102-1962.

2.0. Workmanship

2.1. The steel sections as specified or required, shall be cut, square and to correct lengths, as per drawings and design. The cut ends exposed to view shall be finished smooth. No two pieces shall be welded or otherwise jointed to make up the required length of member, except as indicated in the drawing or as directed. All straightening and shaping to form shall be done by application of pressure and not by hammering. Any bending or cutting shall be carried out in such a manner as not to impair the strength of the metal. All operations shall be done in cold state unless otherwise directed/permitted.

2.2. Steel riveted or bolted in built up sections, frame work.

2.2.1. The steel structure as shown in the drawings or as per direction of the Engineer-in-charge shall be laid out on a level platform to full scale and to full size in parts. A steel tape shall be used for measurements to ensure maximum accuracy.

2.2.2. Wooden templates 12 mm. to 19 mm. thick or metal sheet template shall be made to correspond to each connecting gussets plate and rivet holes shall be accurately marked on them and drilled. The templates shall be laid on the steel members and holes of the steel members shall also be marked for cutting. The base of steel column and the position of Anchor bolts shall be carefully set out

2.2.3. All stiffeners shall be formed by pressure and where practicable the metal shall not to be cut and welded in making these. In major work, or where so specified, shop drawings giving complete details and information for the fabrication of the component parts of the structure including location, type, size, (origin and details of rivets, bolts or weld shall be prepared in advance of the actual fabrication and as distinctly marked or stenciled with paint with the identification mark as given in the shop drawings. The bars shall be thickened at the ends, so as to provide for screwed threads and gradually tapered off to meet their normal section.

Great accuracy shall be observed in fabrication of various member, so that these can be assembled without being unduly packed, stained, or forced into position and when built up, shall be true and free from twists, brinks, buckles, or open joints.

Before making holes in individual members for fabrication the steel work intended to be riveted or bolted together shall be assembled or clamped properly and tightly so as to ensure close abutting or lapping of the surfaces of the different members. All stiffeners shall bear tightly both at top and bottom without being drawn or caulked. The abutting joints shall be cut or crossed true and straight and fitted close together. Web splice plates and tillers under stiffened shall be cut to fit within 3 mm. or flange Angles Web plates of Girders shall have no cover. Plates, shall have their ends flush with the top of angles forming the flanges unless otherwise required. The web plates when spliced shall have clearance of not more than 6 mm. The erection clearance for created ends of members connecting steel shall preferably be not greater than 1.5 mm. The erection clearance at the ends of beams without web cleats shall not be more than 3 mm. at each end but where for a practical reason greater clearance is necessary, suitably designed seating shall be provided.

Rollers shall be accurately tuned to gauge. These shall be straight and smooth and free from flaws. The roller bearing shall be provided with adequate arrangements for holding the girders or truss resting on it. In columns caps and bases, the ends of shifts together with the attached gussets Angles, channels etc after riveting together shall be accurately mechanized so that the parts connected butt against each other over the entire surfaces of contact connecting angles or channels shall be fabricated and placed in position with greater accuracy so that they are not unduly reduced in thickness by machining. The ends of bearing stiffeners shall be mechanized or ground to fit tightly both at the top and bottom. All holes shall generally be drilled to the required size and as required, position. Sub punching shall be permitted provided it is done 3 mm. or less in diameter and reamer thereafter to the required size. The holes for rivets and bolts shall be larger by 0.4 to 6 mm. than the nominal diameter of rivets or bolts depending upon the diameter of rivets.

Holes shall have their axis perpendicular to the surface bored through. The drilling or reaming shall be free from burrs, and the holes should be clean and accurate holes for counter sunk bolts shall be made in such a manner that their heads fit flush with the surface after fixing.

79

The fabrication work shall be completed in workshop as far as it is practicable to do so. Site joints shall be done with rivets and fitted bolts or black bolts, as shown in the drawings or as directed. Generally the following principles shall govern the use of rivets turned and fitted bolts, and black bolts.

(i) Rivets and turned and fitted bolts shall be used where the connections is such that slip under load has to be avoided.

(ii) Black bolts may be used very sparingly where a force is carried through a connection without impact, vibration or reversal or stresses.

2.2.4. Riveting:

The parts assembled for riveting shall be in close contact with each other and the bearing stiffeners shall bear tightly both at top and bottom without being drawn or caulked. Members to be riveted shall be properly pinned or bolted and rigidly held to gather while riveting. Drifting of holes shall not be permitted Except to draw the parts together and the drifting tools so used shall have maximum diameter not exceeding, the nominal diameter of rivets or bolts. Drifting done during assembling shall not distort the metal or enlarge the holes.

The shanks of rivets shall project beyond the plate-surface sufficiently so as to fill hole thoroughly and form the required head after riveting.

The riveting shall be done by hydraulic or pneumatic process. However, where such facilities are not available, hand riveting may be permitted. The rivet shall be heated red hot, care being taken to control the temperature of heating so as not to burn the steel. Rivets of diameter less than 10 mm. may be fitted cold. Rivets shall be of heat finish with heads full and of equal size. All loose, burnt or badly formed rivets with concentric or deficient heads shall be cut out and replaced. The heads of rivets shall be central to shanks and shall grip the assembled member firmly. In

cutting out rivets, care shall be taken so as not to injure assembled members, caulking or reequipping shall not be permitted.

For testing rivets, a hammer weighing approximately 0.25 kg shall be used. Both heads of the rivets shall be tapped, slack rivets will give a hollow sound and a jar.

All rivet heads shall be painted with red lead paint within a week of their fixing.

2.2.5. All bolt heads and nuts shall be hexagonal and of equal size unless specified otherwise. The screwed heads shall conform to I.S. 1363-1960 and the threaded surface shall not be tapered. The bolts shall be of such length so as to project two clear threads beyond the nuts when fixed in position and these shall fit in the holes without any shakes. The nut shall be fit in the threaded ends of bolts properly.

Where turned and fitted bolts are required to be used in place of rivets shall be provided with washers not less than 6 mm. thick so that the nut when tightened shall not bear on the unthreaded body of the bolt. Tapered washers shall be provided for all heads and nuts bearing on leveled surfaces. The threaded portion of the bolt shall not be within the thickness of the parts bolted together, the faces of the bolt heads and nuts abutting against steel members shall be machine finished. Where there is a risk of the nut being removed or becoming loose due to vibrations or reversal of stresses, these shall be secured from slackening by the use of locknuts, spring washers, cross-cutting or hammering down of threads as directed.

Bolts, nuts, and washers shall be thoroughly cleaned and dipped in double boiled linseed oil before use. The whole steel work shall be painted with a coat of priming coat of red lead, as per relevant specification of painting.

3.0 Mode of measurements & payment

3.1. The steel work shall be measured in general as under:

(a) All work shall be measured on the basis of finished dimensions as fixed at site and measured net unless specified otherwise.

(b) The weight of steel sections, steel rods, and steel strips in finished work shall be calculated on standard weight on the same basis on which steel is supplied to Contractor by department or those given in relevant I.S.: if steel is arranged by the contractor.

(c) The weight of steel plates and strips shall be taken from relevant I.S. based on 7.35 kg./sq. meter for every millimeter sheet thickness if steel is supplied to the contractor by department.

(d) Unless otherwise specified, weight of cleats, brackets, packing pieces, bolts, nuts, washer, distance pieces, separators, diaphragm gusset (taking overall square dimensions) fish plates etc. shall be added to the weight of respective items.

(e) In riveted work allowance is to be made for weight of rivet heads. No deductions shall be made for rivet or bolt holes excluding holes for anchor or holding down bolts.

(f) For forged steel and steel castings, weight shall be calculated on the basis of 7850 kg./cum.

(g) Unless otherwise specified, no allowance shall be made for the weld metal in case of welded steel structure.

80

(i) Dimensions other than cross sections and thickness of plates shall be measured to nearest 0.001m

(j) Mill tolerance shall be ignored when weight is determined by calculation.

3.2. The rate includes cost of all material, labour, erection, hoisting scaffolding, protective measure, required for proper completion of the item of work. This shall also include conveyance and delivery handling, loading, unloading and storing etc. required for completing the item described above including necessary wastage involved.

3.3. The rate shall be for a unit of one quintal.

11.2.(D) Steel work riveted in built up section, framed work including cutting, hoisting, fixing in position and applying a priming coat of red lead paint in trusses, and trussed, purlins, upto 25 m. span and 15 m. overall height.

1.0. Materials & Workmanship

The relevant specifications of item No. 11.2 (A) shall be followed except that the work shall be for trusses and trussed purlins up to 25 m. span and 15 m. overall height.

2.0. Mode of measurement & payment

2.1. The relevant specifications of item No. 11.2. (A) shall be followed.

2.2. The rate shall be for a unit of one quintal.

14.4.(A) Steel work welded, in built up sections frame work including, cutting, hoisting, fixing in position and applying a priming coat of red lead paint. In beams and joints, channels, angles, tees, flats, with connecting plates or angle cleats as in main and cross beams. Hip and jack rafters, purlins, connected to common rafters and the like.

1.0 Materials & Workmanship

1.1. The relevant specification of item No. 11.2 (A) shall be followed except that the steel work shall be done by welding.

1.2. Welding shall generally be done by electric process. Gas welding shall be resorted to, using oxyacetylene flame with specific prior approval. Gas welding shall not be permitted for structural steel work.

1.3. The work shall be done as shown in the shop drawings which should clearly indicate various details of the joints to be welded, shop and site welded as well as type of electrodes to be used, symbol for welding on plans and shop drawings shall be according to I.S. 813-1961. As far as possible every effort shall be made to limit the welding that must be done after improper welding that is likely to be done due to heights and difficult positions on scaffoldings etc. The welding work shall conform to I.S. 816-1969.

1.4. Preparation of surfaces : Surfaces which are to be welded together shall be free from loose mill scale, rust, paint, grease or other foreign matter. A coating of boiled linseed oil shall be permitted.

1.5. Assembly for welding : Before welding is commenced, the plates shall first be brought together and firmly clamped or spot welded at specified distance. This temporary connection has to be strong enough to hold the plates accurately in place without displacement.

1.6. Precautions : All operations connected with welding and cutting equipment shall conform to safety requirement given in I.S. 818-1968.

The following points shall be borne in mind during the process of welding:

(b) Are length voltage and amperage shall be suited to the thickness of material type of groove and other circumstances of the work.

(c) The segments of welding shall be such that where possible the members which offer the greatest resistance to compression are welded first.

1.7. The defective welds which shall be considered harmful to the structural strength shall cut out and reworked.

1.8. Finished welds and adjacent parts shall be protected with clean boiled linseed oil and after all slag has been removed. Welds and adjacent parts shall be painted after the same are approved.

1.9. All the members shall be thoroughly cleaned of rust-scales, dust etc. and given a priming coat of red lead paint before fixing them in position.

Testing of welding to be added in the specification I.N. 12.2.2.12-(i) to (viii)

2.0. Mode of measurements & payment

2.1. The relevant, specification of item No. 11.2 (I) shall be followed.

2.2. The rate shall be for unit of one quintal.

11.4.(D) Steel work welded in built up section framed work, cutting, hoisting, fixing in position and applying a priming coat a red lead paint in trusses and trusses purlins up to 25 m. span and 15 m. overall height.

1.0. Materials & Workmanship

The relevant specification of item No. 11.4.(A) shall be followed except that the work shall be for trusses and trussed purlins up to 25 m. span and 15 m. overall height.

81

2.0. Mode of measurement & payment

2.1. The relevant specifications of item No. 11.4 (A) shall be followed.

2.2. The rate shall be for unit for one quintal.

11.6. Providing and fixing in position collapsible steel shutters with vertical channels 20 x 10x2 mm. braced with flat iron diagonals 20 x 5 mm. size with top and bottom rails of T Iron 40 x 40 x 6 mm. with 38 mm. dia steel pulleys complete with bolts, nuts, locking arrangements, stoppers, handles, including applying a priming coat red lead paint.

1.0. Materials

The collapsible steel gate shall conform to M-33.

2.0. Workmanship

J-rails shall be fixed to the floor and to the lintel at top by means of Anchor bolts, embedded in cement concrete-of floor and lintel. The anchor bolts shall be placed approximately at 45 mm. centers alternatively in groove shall be formed along the runner for the purpose. The collapsible gate shall fixed at the sites by fixing the double channels in the T-iron rail and also by hold fasts bolted to the end double channel and fixed in the masonry of the side walls or the otherwise.

In case where the collapsible gate is not required to the lintel beams or slop above, a toe iron suitably designed may be fixed at the top embedded in masonry and provided with necessary clamps and roller arrangement at the top.

All the adjoining work damaged while fixing of gate shall be made good to match the existing work without any extra payment.

All the members of the collapsible gate including T-iron shall be thoroughly cleaned of rust, scales dust etc., and given a priming coat of red lead, before fixing them in position.

3.0. Mode of measurement and payment

3.1. The collapsible gate shall be measured in sq. meter. The height of the gate shall be measured as the length of double channels and breadth from outside to outside of the end fixed double channels in open position of the gate. The rate includes providing handles, arrangements stoppers etc.

3.2. The rate shall be for a unit of one sq. meter.

11.7. Providing and fixing 1 mm. thick M.S. sheet sliding shutters both frame and diagonal braces of 40 x 40 x 6 mm. Angle iron 3.15. M.S.S. gusset plates at junctions and comers, 25 mm. dia. pulley 40 x 40 x 6 mm. angle and T-iron guide rail at top and bottom respectively with handles, stoppers and locking arrangements etc. including applying priming coat of red lead paint.

1.0. Materials

M.S. sliding shutters shall be fabricated of M.S. component as given in the description of item M.S. sheets 1 mm. thick shall be fixed to the frame with rivets of weld as approved. The shutters shall be provided with top and bottom guide rails of Angles or T-iron as specified and 25 mm. dia. steel pulleys at the-bottom guide black with steel pulleys at the top. The frame shall be riveted and /or welded and wherever riveting shall be done 3.15 mm. gussets plates shall be provided at the junctions.

2.0. Workmanship

2.1. The shutters shall be single or double leaf shutters as specified. The guide rails shall be sufficiently long and continued along the wall on the both ends so that the sliding shutters can rest against walls, living full opening

when so required.

2.2. The guide rails shall be fixed to the floor by means of anchor bolts embed in the cement concrete floor. The steel section at the top shall be suitably supported from the walls. Two channel section shall suitably fixed vertically below the extreme clamps in the wall and floor to avoid the shutters from going out of the supports at the top and bottom. A suitable clamping arrangement will be provided at either end of the opening to avoid the shutters from rolling back into opening.

2.3. All the adjoining work damaged while fixing shall be made good to match the existing work.

2.4. All members of the sliding shutter including T-iron shall be thoroughly cleaned of rust scales dust etc. and given a priming coat of red lead before fixing them in position

3.0. Mode of measurements & payment

3.1. The sliding doors shall be measured on sq. meter. The height of the shutters shall be measured from outside to outside of the guide, rail and width outside of shutters including vertical channels in sides. The rate includes providing handles stopped and locking arrangement etc. complete.

3.2. The rate shall be for a unit of one sq. meter.

82

SECTION-12

Labour for fixing fixtures & fastening

12.4. Fixing metallic tower bolts of sizes with necessary screws etc. complete (tower bolts and screws to be paid under separate items):

1.0. Workmanship

1.1. This item provides for labour for fixing metallic tower bolts of any size with screws, nuts etc,

1.2. The tower bolts shall be fixed in proper position as shown in the drawings or as directed. There shall be fixed truly vertical or horizontal as the case may be.

1.3. The screws shall be driven home with screw driver. In no case the screws shall be hammered in.

1.4. All recesses and seats shall be cut to the exact size for counter sinking etc. where so required.

1.5. Care shall be taken to see that no gaps are left between the fitting and the surface meant to receive the fittings.

1.6. The fittings shall be properly cleaned and left in original finish after fixing.

2.1. Mode of measurements & payment

(1) Cutting of holes, recesses, and seats involved in process of fixing.

(2) Cost of filling and cushioning materials where so required for proper seating of new fittings.

(3) Cost of nails etc. for temporary positioning of fitting.

(4) Cost of cleaning materials like old washed dhobi stain remover etc.

(5) Cost of making good the over cut recesses or holes if any.

(6) Cost of making hole of required size on the wooden frame for housing the bolt for locking.

2.2. The rate includes cost of labour involved in all operations required for proper completion of the items including carriage, handling, fixing etc. complete.

2.3. The rate shall be of unit of one number.

12.5. Fixing metallic flush bolts of size with necessary screws etc., complete (flush bolts and screws shall be paid under separate items):

1.0. Workmanship

1.1. The relevant specifications shall be followed as per item No. 12.4. except for fixing metallic flush bolts instead of tower bolts.

2.0. Mode of measurements and payment

2.1. The relevant specifications of item No. 12.4. shall be followed.

2.2. The rate shall be for a unit of one number.

12.8. Fixing metallic or plastic door handles of sizes with necessary screws etc. complete (door handles and screws to be paid under separate items)

1.0. Workmanship

1.1. The relevant specifications of item No. 12.4. shall be followed except fixing door handles instead of tower bolts.

2.0. Mode of measurements and payment

2.1. The relevant specifications of item No. 12.4. shall be followed.

2.2. The rate shall be for a unit of one number

12.10. Fixing metallic gate and shutter hooks and eyes of sizes (hooks and eyes to be paid under separate items)

1.0. Workmanship

1.1. The relevant specifications shall be followed as per item No. 12.4 except that fixing of eye and hooks instead of tower bolts.

2.0. Mode of measurements and payment

2.1. The relevant specifications of item No. 12.4 shall be followed.

2.2. The rate shall be for a unit of one number (Hook & Eye)

83

12.11. Fixing metallic door latches of size with necessary screws (door latches and screws to be paid under separate items) :

1.0. Workmanship

1.1. The relevant specifications of item No. 12.4 shall be followed except that fixing metallic door latches instead

of tower bolts.

2.0. Mode of measurements & payment

2.1. The relevant specifications of item No. 12.4 shall be followed.

2.2. The rate shall be for a unit of one Number.

12.12. Fixing metallic mortise night latches with necessary screws including making necessary crews holes in wooden door shutters etc., complete (mortise night latches and screws to be paid under separate items):

1.0. Workmanship

1.1. The relevant specifications of item No. 12.4 above shall be followed except that the fixing of mortise night latches instead of tower bolts.

2.0. Mode of measurements & payment

2.1. The relevant specifications of item No. 12.4 shall be followed.

2.2. The rate shall be for a unit of one number.

12.18. Fixing metallic ball catchers 100 mm. dia. (Ball catches to be paid under separate item):

1.0. Workmanship

1.1. The relevant specifications of item No. 12.4 shall be followed same except fixing of ball catchers 100 mm dia.

2.0. Mode of measurements and payment

2.1. The relevant specification of item No. 12.4 shall be followed.

2.2. The rate shall be for a unit of one number.

12.20. Fixing metallic casement window fasteners with necessary etc. complete. (Casement window fasteners and screws to be paid under separate items):

1.0. Workmanship

1.1. The relevant specifications of item No. 12.4. shall be followed except fixing metallic casement windows fasteners.

2.0. Mode of measurements & payment

2.1. The relevant specifications of item No. 12.4 shall be followed.

2.2: The rate shall be for a unit of one number.

12.21. Fixing metallic casement stays of sizes with necessary screws etc., complete. (Casement stays and screws to be paid under separate items)

1.0. Workmanship

1.1. The relevant specifications of item No. 12.4 shall be followed except fixing of metallic casement stays.

2.0. Mode of measurements & payment

2.1. The relevant specifications of item No. 12.4 shall be followed.

2.2. The shall be for unit of one number.

12.24. Fixing metallic cupboard of ward robe locks of sizes with necessary screws etc. complete (Locks and screws to be paid separately) :

1.0. Workmanship

1.1. The relevant specifications of item No. 12.4 shall be followed except that fixing metallic cupboard or ward robe locks of size with necessary screws etc. complete.

2.0. Mode of measurements & payment

2.1 The relevant specifications of item No. 12.4 shall be followed.

2.2. The shall be for a unit of one number

12.25. Fixing metallic or plastic cupboard or ward robe knobs of size with necessary screws/ bolts etc., (knobs and screws/bolts to be paid separately) :

84

1.0. Workmanship

1.1. The relevant specifications of item No. 12.4 shall be followed except that fixing metallic or plastic cupboard or ward robe knobs of sizes with necessary screws/bolts etc. complete.

2.0. Mode of measurements & payment

2.1. The relevant specifications of item No. 12.4 shall be followed.

2.2. The shall be for a unit of one number.

12.26. Fixing metallic floor stoppers of sizes with rubber cushion, screws etc., to suit shutter thickness complete, (floor door stopper with rubber cushion and screws to be paid under separate items) :

1.0. Workmanship

1.1. The relevant specifications of item No. 12.4 shall be followed except that fixing metallic floor stoppers.

2.0. Mode of measurements & payment

2.1. The relevant specifications of item No. 12.4 shall be followed.

2.2. The shall be for a unit of one number.

12.28. Fixing metallic door handles or knobs for mortise jocks with necessary screws etc. complete (doors, handles/knobs and screws to be paid separately) :

1.0. Workmanship

The relevant specifications of item No. 12.4 shall be followed except that fixing metallic door handles or knobs for mortise with necessary screws etc. complete.

2.0. Mode of measurements & payment

2.1. The relevant specifications of item No. 12.4 shall be followed.

2.2. The rate shall be for a unit of one number.

85

SECTION-13

Glazing

13.1.(I) Providing and fixing sheet glass, selected quality (type-C) bedded in putty and fixed with wooden beading including cost of wooden beading of first class teak wood and necessary cutting of glass 5 mm. thick.

1.0. Materials

The glass shall conform to M-38. The wood beading shall conform to M-29, Putty shall conform to I.S. 419-1967.

2.0. Workmanship

The glass shall be sheet glass of selected quality of 5 mm. thick.

2.1. The size of glass for glazing shall allow a clearance of 2.5 mm. between the edges of glass and the wood or metal surrounds. The clearance may be increased, provided the depth of the rebate of groove is sufficient to provide not less than 1.5 m. cover to the glass. The detailed process of glazing shall be as specified in I.S. 3548-1966.

2.2. All stains from the surface of glass shall be removed and cleaned with thinner or spirit without any extra payment.

2.3. Wooden beading :

2.3.1. The size of the wood beads for glass panes shall be 1.5 cms. x 3 cms unless otherwise specified. Beads shall be secured to wooden frames with either panels pins or screws and to metal frames in the way provided for in the frame.

2.3.2. Sufficient putty compound shall be applied to the rebate so that when the glass has been pressed into the rebate, a bed of compound not less than 1.5 mm. thick will remain between the glass and the rebate. There should also be surplus of compound squeezed out above the rebate which should be stripped at an angle not under cut to prevent water accumulating. Beads should be bedded with compound against the glass and wood beads should also be bedded against the rebate. Care should be taken to see that no voids are left between the glass and the bead.

3.0. Mode of measurement & payment

3.1. All measurements of cutting shall, unless otherwise stated, be held to include the consequent waste.

3.2. Each pane' of glass shall be measured to the nearest 0.5 cms. both in width and height/length.

3.3. Irregular shaped or circular panes shall be measured as the smallest rectangular area from which the irregular or circular pane can be cut.

3.4. The rate includes cost of materials, labour required for completion of the item including hoisting, carriage, temporary erections like scaffolding etc.

3.5. The rate also includes :

(i) The wastages and breakage involved in the process.

(ii) Straight cutting on glass and glazing sheets.

(iii) Cost of subsidiary materials required for proper fixing and functioning of glass i.e. nails, spirit, putty, teak wood beading glass, pins, etc. complete.

3.6. The rate shall be for a unit of sq. meter.

13.1.(M) Providing and fixing sheet glass selected quality (Type-C) bedded in putty and fixed with wooden beading including cost of wooden beddings of first class teak wood, and necessary cutting of glass 6 mm. thick.

1.0. Materials and workmanship

1.1. The relevant specifications of item No. 13.1 (I) shall be followed except that the sheet glass of selected quality shall be 6 mm. thick.

86

2.0. Mode of measurements and payment

2.1. The relevant specifications of item No. 13.1.(I) shall be followed.

2.2. The rate shall be for a unit of one sq. meter.

13.3.(C) Providing and fixing rough cast wired glass 6 mm. thick bedded in putty and fixed with wooden beading including the cost of wooden beadings of Indian teak wood and necessary cutting of glass wired figures glass.

1.0. Materials :

Wire figure glass shall conform to M-38. Wooden beading shall conform to M-29, Putty shall conform to I.S. 419-1967.

2:0. Workmanship

The relevant specification of item No. 13.1(1) shall be followed except that the wired figured glass of 6 mm. thick shall be used.

3.0. Mode of measurements and payment

3.1. The relevant specifications of item No. 13.1(1) shall be followed.

3.2. The rate shall be for a unit of one sq. nit.

3.5.(3) Providing and fixing sheet glass ordinary quality bedded in putty and fixed with wooden beading including the cost of wooden beadings of first class teak wood and necessary cutting of glass 3 mm. thick.

1.0. Materials

Glass shall conform to M-38. Wooden beading shall conform to M-29. Putty shall conform to I.S. 419-1967. **2.0 Workmanship**

The relevant specification of item No. 13.1 (I) shall be followed except that the wired figured glass of 6 mm. thick shall be used.

3.0. Mode of measurements and payment

3.1. The relevant specifications of item No. 13.1 (I) shall be followed.

3.2. The rate shall be for a unit of one sq. mt.

13.5.(3) Providing and fixing sheet glass ordinary quality bedded in putty and fixed with wooden beading including the cost of wooden beadings of first class teak wood and necessary cutting of glass 3 mm. thick.

1.0. Materials

Glass shall conform to M-38. Wooden beading shall conform to M-29. Putty shall conform to I.S. 419-1967.

2.0. Workmanship

2.1. The specification of this item shall be followed as per item No. 13.1(1) except that the sheet glass of ordinary quality shall be used and thickness of sheet glass shall be 3 mm. thick.

3.0. Mode of measurements and payment

3.1. The relevant specifications of item No. 13.1(1) shall be followed.

3.2. The rate shall be for a unit of one sq. meter.

13.5.(4) Providing and fixing sheet glass ordinary quality, bedded in putty and fixed with wooden beadings including the cost of wooden beadings of first class teak wood and necessary cutting of glass 4 mm. thick.

1.0. Materials and Workmanship

The relevant specifications of item No. 135 (3) shall be followed, except that the thickness of ordinary sheet glass shall be 4 mm.

2.0. Mode of measurements and payment

2.1. The relevant specification of item No. 13.1(1) shall be followed.

2.2. The rate shall be for a unit of one sq. meter,

13.7. Extra for using ground glass (Frosted or obscured on one side) instead of plain glass.

1.0. Materials

Glass shall conform to M-38. Wooden beading shall conform to M-29. Putty shall conform to I.S. 419-1967.

2.0. Workmanship

The specifications of this item shall be followed as per item No. 13.1 except that ground glass (Frosted or obscured on one side) shall be used.

3.0. Mode of measurements and payment

3.1. The payment shall be made on sq. mt. basis extra over and above the payment for plain glass for using ground glass [Routed or obscured).

87

3.2. The relevant specifications of item No. 13.5 (III) shall be followed.

3.3. The rate shall be for a unit of one sq. meter.

13.11.(A) Difference in cost of material and labour involved in method of glazings if changed in item No. 13.1 to front and back puttied and sprigged 01 fixed with glazing pins :

1.0. Materials and Workmanship

1.1. The relevant specification of item No. 13.1 shall be followed except that the glazing is to be done by front and back puttied and sprigged or fixed with glazing pins.

2.0. Mode of measurements and payment

2.1. The relevant specifications of item No. 13.1 (I) and 13.1 (II) shall be followed.

2.2. The extra rate for extra cost involved shall be paid over and above item No. 13.1(1) & 13.1 (II).

2.3. The rate shall be for a unit of one sq. meter.

13.12. Grinding, polishing and round of edges or glazing sheets.

1.0. Materials

The glass shall conform to M-38.

2.0. Workmanship

The edges of glass or glazing sheets shall be grained, polished and rounded of such that it renders uniform look throughout the length and shall be neatly finished. The work shall be carried out in best workman's like manner.

3.0. Mode of measurements & payment

3.1. The edges of glass round, polished and rounded off shall be measured in meter.

3.2. The rate shall be for a unit of one running meter.

88

SECTION-14

Paving & Floor Finishing

14.2.(A) 40 mm. thick marble chips flooring rubbed and polished (i.e. Terrazzo) to granolithic-finish with under layer 30 mm. thick cement concrete (1:2:4) (1 cement :2 coarse sand : 4 graded stone aggregate 10 mm. and down gauge) and top layer, 10 mm. thick with white, black or white and black marble chips of required sizes from 1 mm. to 4 mm. nominal size laid in cement marble powder mix 3 : 1 (3 cement : 1 marble powder by weight, in proportion of 4: 7 (4 cement marble powder mix : 7 marble chips by volume): Dark shade pigment with ordinary cement (in top layer only).

1.0. Materials

Water shall conform to M-1. Cement shall conform to M-3. Sand shall conform to M-G. Stone grit shall conform to M-8.

The pigment incorporated in terrazzo shall be of permanent colour and shall conform to requirement mentioned in Appendix-A in IS: 2114-1962. Marble chips shall conform to M-46. The marble powder shall pass through I.S. Sieve Terrazzo-30.

2.0. Workmanship

2.1. Terrazzo finish shall be laid over a layer of base concrete in case of ground floor. When the terrazzo floor is laid over R.C.C. slabs a cushioning layer consisting of 75 mm. thick lime concrete shall be provided below the terrazzo floor. The terrazzo flooring shall consist of an under layer of cement concrete and layer of terrazzo which shall be laid monolithically.

2.2. Under Layer :

2.2.1. The under layer shall be of cement concrete mix 1:2:4. The maximum size of aggregate used shall not exceed 10 mm. Specification for cement concrete shall be followed as per item No. 5.4.1.

2.3. Terrazzo Topping :

2.3.1. The topping shall have mix of ordinary cement, and marble powder in proportion 3:1 (3 cement : 1 marble powder by weight) and marble aggregate shall be mixed in proportion 4:7 (4 cement marble powder : 7 marble chips by volume). The thickness of concrete and cushioning layer shall not be less than 10 cms. and 7.5 cms. respectively. The minimum thickness of under layer and topping shall be 40 mm.

2.4. Panels :

2.4.1. The floor both while laying the under layer and topping shall be divided into panels not exceeding 2 sq. m. in area so as to reduce the risk of cracking due to differential shrinkage or expansion of terrazzo and sub-floor. The joints be so located that the layer dimensions of any panel do not exceed 2 M. The panels shall preferably be separately. However where the butt joint are provided, the bays shall be laid alternatively allowing for an interval of at least 24 hours between the laying of adjacent bays.

2.5. Mixing of materials :

2.5.1. With a view to avoid variation in colour, mixing shall be done in trough or tub, and the complete quantities of cement and pigment required for one unit shall be mixed at the beginning of the work. Colour cement or cement and pigment mix shall be dry mixed with marble powder. The mix thus obtained shall be mixed with aggregate. Care shall be taken not to get the materials into a heap as this would result in coarser aggregates moving on the sides and cement to the centre. To the dry mix thus prepared, water shall be added in small quantities while materials are being worked to get a mix of proper consistency. The mixture shall be plastic but not so wet as to flow. The wet mix shall be used within half an hour mix of addition of water during preparation laying.

2.6. Laying :

2.6.1. The base shall be divided into panels with the help of dividing strips including the strips required for decorative design up to the finished surface level of the floor. Screeds strips shall be used where the dividing strips are not used. The base shall be cleaned of all dust, dirt laitance and any loose materials. It shall be then wetted with water mopped and smeared with cement slurry at 2.75 kg./sq.mt. Under layer shall be then be spread and leveled with a screening board. The top surface shall be left rough to provide a good bond to the terrazzo.

89

2.6.2. The terrazzo topping shall be laid while the under layer is still plastic but has hardened enough to prevent cement from rising to the surface. This is normally achieved between 18 to 24 hours after laying of under layer. A cement slurry preferably of the same colour as the topping shall be brushed on the surface immediately before laying the topping. The terrazzo mix shall be laid to a uniform thickness on the screed bed and be completed thoroughly by taping or rolling and trowel led smooth. Excessive troweling or rolling in early stages shall be avoided as it results in working up cement to the surface which will produce a surface liable to cracking and will require more grinding to expose marble chips. The terrazzo surface shall be tamped, trowel led, and brought true to required level by a straight edge and steel floats in such a manner that the maximum amount of marble chips come up and are spread uniform over the surface and no part of the surface is left without chips.

2.7. Curing :

2.7.1. The surface shall be left dry for air curing for a period of 12 to 18 hours. Thereafter water shall be allowed to stand overnight in pools for period of minimum of four days. The floor shall be prevented from being subjected to extreme temperature.

2.8. Grinding and finishing :

2.8.1. Grinding and finishing shall be done either by hand or by machine. In case of manual grinding, the process of grinding shall begin after two days, while in case of machine grinding, the process shall be started after seven days, after completion of laying.

2.8.2 First grinding shall be done by carborundum stones of 60-grit size. The surface shall then be washed clean and grouted with a grout of cement or /and coloring matter in the same mix and proportion as the topping in order to fill any pin holes that appear. It shall be allowed to dry for 24 hours and wet cured for four days in the same manner as mentioned in Para 2.7 above.

2.8.3. The second grinding shall be done with carborundum stone of 80 grit size. The surface shall then be prepared as after first grinding. The third grinding shall be done with carborundum stone of 120 to 150 grit size. The surface shall then be washed again and allowed to dry for 12 hours, and wet cured for four days as before. The fourth grinding shall be done with carborundum stone of 320 to 400 grit size. The surface shall again be washed clean and rubbed hard with felt and slightly moistened Oxalic acid powder @ 5 gms. per sq. meter of floor surface. After the finishing work is over, the surface shall be washed with dilute oxalic acid solution and dried for floor

polishing, machine fitted with felt or Hessian bobs shall then be run over it until floor shines. In case wax-polished surface is required, wax-polished shall be applied on the surface with the help of soft linen over a clean and dry surface. The polishing machine fitted with bobs shall be run over it, clean saw dust shall be spread over the floor surface and polishing machine again operated which will remove excess wax and leave glossy surface. Floor shall not be left slippery.

3.0. Mode of measurements and payment

3.1. Terrazzo flooring shall be measured as laid in sq. meters. Length and breadth shall be measured for visible area of work done. No deduction shall be made for nor extra for any opening in floor or area up to 0.10 sq. meter. The rate shall cover laying the floor at different levels in the same room or court-yard and nothing extra shall be paid on that account.

3.2. The rate includes the cost of all materials and labour involved in all operations described above. The rate shall also not include diving strip.

3.3. The rate shall be for a unit of one sq. meter.

14.2.(B) 40 mm. thick marble chips, flooring rubbed and polished (i.e. Terrazzo) to granolithic finish with under layer 30 mm. thick cement concrete 1:2:4 (1 cement : 2 coarse sand : 4 graded stone aggregate 10 mm. and down gauge) and top layer 10 mm. thick with white, black or white and black marble chips of required sizes form 1 mm. 4 mm. nominal size laid in cement marble powder mix 3 : 1 (3 cement : 1 marble powder by weight) in proportion of 4: 7 (4 cement : marble powder mix : 7 marble chips by volume) light shade pigment with white cement (in top layer only).

1.0. Materials & Workmanship

1.1. The relevant specifications of item No. 14.2 (A) shall be followed except that light shade pigment with white cement shall be used in top layer

2.0. Mode of measurements & payment

2.1. The relevant specifications of item No. 14.2 (A) shall be followed.

2.2. The rate shall be for a unit of one sq. meter.

90

14.2.(C) 40 mm. thick marble chips, flooring rubbed and polished (i.e. Terrazzo) to granolithic finish with under layer 30 mm. thick cement concrete 1:2:4 (1 cement : 2 coarse sand : 4 graded stone aggregate 10 mm. and down gauge) and top layer 10 mm. thick with white, black or white and black marble chips of required sizes from 1 mm. to 4 mm. nominal size laid in cement marble powder mix 3:1 (3 cement : 1 marble power by weight) in proportion of 4:7 (4 cement : marble powder mix : 7 marble chips by volume). Medium shade pigment with approx. 50% white cement and 50% ordinary cement (In top layer only).

1.0. Materials & Workmanship

1.1. The relevant specifications of item No. 14.2. (A) shall be followed except that medium shade pigment with approximately 50% white cement and 50% ordinary cement in top layer only shall be used.

2.0. Mode of measurements & payment

2.1. The relevant specifications of item No. 14.2. (A) shall be followed.

2.2. The rate shall be for a unit of one sq. meter.

14.2.(D) 40 mm. thick marble chips, flooring rubbed and polished (i.e. Terrazzo) to granolithic finish with under layer 30 mm. thick cement concrete 1:2:4 (1 cement : 2 coarse sand : 4 graded stone aggregate 10 mm. and down gauge) and top layer 10 mm, thick with white, black or white and black marble chips of required sizes from 1 mm. to 4 mm. nominal size laid in cement marble powder mix 3:1 (3 cement : 1 marble power by weight) in proportion of 4:7 (4 cement : marble powder mix : 7 marble chips by volume). White cement without any pigment (in top layer only).

1.0. Materials & Workmanship

1.1. The relevant specifications of item No. 14.2.(A) shall be followed except that white cement without any pigment in top layer only shall be used.

2.0. Mode of measurements & payment

2.1. The relevant specifications of item No. 14.2.(A) shall be followed.

2.2. The rate shall be for a unit of one sq. meter.

14.2.(E) 40 mm. thick marble chips, flooring rubbed and polished (i.e. Terrazzo) to granolithic finish with under layer 30 mm. thick cement concrete 1:2:4 (1 cement : 2 coarse sand : 4 graded stone aggregate 10 mm. and down gauge) and top layer 10 mm. thick with white, black or white and black marble chips of required sizes from 1 mm. to 4 mm. nominal size laid in cement marble powder mix 3:1 (3 cement :1 marble power by weight) in proportion of 4:7 (4 cement : marble powder mix : 7 marble chips by volume), light < de pigment with ordinary cement (in top layer only).

1.0. Materials & Workmanship

1.1. The relevant specifications of item No. 14.2(A) shall be followed except that the light shade pigment with ordinary cement (in top layer only) shall be used.

2.0. Mode of measurements & payment

2.1. The relevant specifications of item No. 14.2 (A) shall be followed.

2.2. The rate shall be for a unit of one sq. meter.

14.4.(A) Marble chips skirting (Terrazzo) or dodo rubbed and polished to granolithic finish top layer

6 mm. thick with white black or white and black marble chips of sizes from smallest to 4 mm. nominal size laid in cement marble powder mix 3:1 (3 cement : 1 marble by weight) in proportion of 4:7 (4 cement : 7 marble chips by volume) 20 mm. thick with under layer 14 mm. thick in cement plaster 1:3 (1 cement : 3 coarse sand) : Dark shade pigment with ordinary cement (in top layer only).

1.0. Materials

1.1. The relevant specifications of item No. 14.2 (A) shall be followed.

2.0. Workmanship

2.1. Under layer: The under layer for terrazzo on vertical surfaces like skirting and dedos shall be of stiff cement mortar 1:3 (1 cement : 3 coarse sand) finished rough so as to give a good bond to the topping.

2.2. Terrazzo topping shall not be less than 6 mm. thick and the combined thickness of under layer and topping shall be less than 20 mm. The other details shall be followed same as per specifications of item No. C 24 except that the light shade pigment with white cement in top layers shall be used.

91

3.0. Mode of measurements & payment

3.1. The skirting and dedo shall be measured in square meters correct to two places of decimals. The height shall be measured from the finished level of floor.

3.2. The rate shall be for a unit of one sq. meter.

14.4.(B) Marble chips skirting (Terrazzo) or dedo rubbed and polished to granolithic finish top layer

6 mm. thick with white black or white and black marble chips of sizes from smallest to 4 mm. nominal size laid in cement marble powder mix 3:1 (3 cement : 1 marble by weight) in proportion of 4:7 (4 cement : 7 marble chips by volume) 20 mm. thick with under layer 14 mm. thick in cement plaster 1:3 (1 cement : 3 coarse sand) : light shade pigment with white cement (In top layer only).

1.0. Materials & Workmanship

1.1. The relevant specifications of item No. 14.4 (A) shall be followed except that the light shade pigment with white cement in top layers only shall be used.

2.0. Mode of measurements & payment

2.1. The relevant specifications of item No. 14.4(A) shall be followed.

2.2. The rate shall be for a unit of one sq. meter.

14.4.(C) Marble chips skirting (Terrazzo) or dedo rubbed and polished to granolithic finish top layer

6 mm. thick with white black or white and black marble chips of sizes from smallest to 4 mm. nominal size laid in cement marble powder mix 3:1 (3 cement : 1 marble by weight) in proportion of 4:7 (4 cement : marble powder mix 7 marble chips by volume) 20 mm. thick with under layer 14 mm. thick in cement plaster 1:3 (1 cement : 3 coarse sand) : medium shade pigment with approximate 50% white cement and 50% ordinary cement (In top layer only).

1.0. Materials and workmanship

1.1. The relevant specifications of item No. 14.4(A) shall be followed except that the medium shade pigment with approximate 50% white cement and 50% ordinary cement in top layers only shall be used.

2.0. Mode of measurement & payment

2.1. The relevant specifications of item No. 14.4 (A) shall be followed.

2.2. The rate shall be for a unit for one sq. meter.

14.4.(D) Marble chips skirting (Terrazzo) or dodo rubbed and polished to granolithic finish top layer

6 mm. thick with white black or white and black marble chips of sizes from smallest to 4 mm. nominal size laid in cement marble powder mix 3:1 (3 cement : 1 marble by weight) in proportion of 4:7 (4 cement : marble powder mix 7 marble chips by volume) 20 mm. thick with under layer 14 mm. thick in cement plaster 1:3 (1 cement : 3 coarse sand) : White cement without any pigment (In top layer only).

1.0. Materials & Workmanship

1.1. The relevant specifications of item No. 14.4 (A) shall be followed except that the white cement without any pigment in top layers shall be used.

2.0. Mode of measurements & payment

2.1. The relevant specifications of item No. 14.4 (A) shall be followed.

2.2. The rate shall be for a unit of one sq. meter.

14.4.(E) Marble chips skirting (Terrazzo) or dedo rubbed and polished to granolithic finish top layer

6 mm. thick with white black or white and black marble chips of sizes from smallest to 4 mm. nominal size laid in cement marble powder mix 3:1 (3 cement : 1 marble by weight) in proportion of 4:7 (4 cement : marble powder mix 7 marble chips by volume) 20 mm. thick with under layer 14 mm. thick in cement plaster 1:3 (1 cement : 3 coarse sand) : light shade pigment with ordinary cement (In top layer only).

1.0. Materials & workmanship

1.1. The relevant specifications of item No. 14.4 (A) shall be followed and except that the light shade pigment with ordinary cement in top layers only shall be used.

2.0. Mode of measurements & payment

2.1. The relevant specifications of item No. 14.4 (A) shall be followed and except that the light shade pigment with ordinary cement in top layers only shall be used.

2.2. The rate shall be for a unit of one sq. meter.

92

4.16 Providing and laying cushioning layer on R.C.C. slab consisting of 75 mm. thick lime concrete using brick aggregate of 20 mm. nominal size 50% mortar comprising of 1 lime : 2 fine sand.

1.0. Materials

1.1. Water shall conform to M-1. Lime mortar or proportion 1:2 shall conform to M-10. Brick aggregate 20 mm. nominal size shall conform to M-14.

2.0. Workmanship

2.1. The relevant specifications of item No. 1.8 shall be followed except that the proportion of mix shall be 50% mortar comprising of 1 lime : 2 coarse sand and the size of brick aggregate shall be 20 mm. nominal size. The lime concrete work shall be carried out in 7.5 Cms. average thickness as a cushioning layer on R.C.C. slab.

3.0. Mode of measurements and payment

3.1. The lime concrete work shall be measured for visible area of work done.

3.2. The rate shall be for a unit of one sq. meter.

14.19.(A) Precast terrazzo (Mosaic) tiles 20 mm. thick with white, black or white and black marble chips of sizes up to 6 mm. laid in floors, treads of steps and landings on a bed of 25 mm. average thickness of lime mortar 1:1.5 (1 lime putty : 1.5 fine sand) or C.M. 1:6 jointed with neat cement slurry mixed with pigment to match the shade of the tiles including rubbing and polishing complete with precast files of light shades, using white cement.

1.0. Materials

1.1. Water shall conform to M-1. Cement shall conform to M-3. Lime Mortar shall conform to M-10 cement mortar shall conform to M-1. The precast terrazzo tiles of 20 mm. thick shall be light shade using white cement and conform to M-47.

2.0. Workmanship

2.1. The work shall be carried out as per I.S. 1443-1972.

2.2. Bedding :

2.2.1. Before spreading the mortar, the sub-base of the floor shall be cleaned of all dirt, scum and loose materials and then well wetted without forming any pools of water on the surface.

2.2.2. In case of R.C.C. floors, the top shall be left a little rough, all points of level for the finished surface shall be marked out. The lime mortar of proportion 1:1.5 (1 lime putty : 1.5 fine sand) or cement mortar of proportion C.M. 1 : as directed shall be then evenly and smoothly spread over the base. Bedding layer of mortar shall be not less than 10 mm. and average thickness of bedding shall be 25 mm.

2.3. Laying :

2.3.1 Before laying the terrazzo (Marble/Mosaic) tiles, the tiles shall be thoroughly wetted with water. Neat cement grout of required-consistency at 4.4. Kg. cement/sq. mt. shall be spread on the mortar bed. The tiles shall be laid on the neat cement float and shall be evenly and firmly bedded to the required level and slope, There shall be no hollows left. The joints shall be uniform thickness and in straight line as per the pattern.

2.3.2 The surface of flooring shall be checked frequently with a straight edge at least two meters long so as to obtain a true surface with required slope.

2.3.3. The tiles which are fixed in the floor adjoining the wall shall go about 10 mm. under plaster. Skirting or dedo shall be left unfinished for about 50 mm. above finished floor level and unfinished strip then left earlier shall be finished.

2.3.4. In places where full tiles cannot be fixed, the tiles shall be cut to the size and smoothed at edges to give straight and true joints.

2.3.5. After the tiles have been laid, the surplus cement slurry and the joints shall be cleaned and washed fairly deep before cement hardens.

2.3.6. The day after tiles have been laid, the joints shall be cleaned or gray cement grout with a wire brush to a depth of about 5 mm. and then grouted with white cement with or without pigment to match the shade of the topping of tiles. The same cement slurry shall then be spread over the whole surface in a thin coat to protect the surface from abrasive damage and to fill pin holes that may exist on the surface.

2.4. Curing :

2.4.1. The flooring shall be kept wet with damp sand or water for seven days. It shall be kept undisturbed at least for 14 days. The grinding shall normally be commenced after 14 days.

93

2.5. Polishing :

2.5.1. After the tiles are properly cured, first grinding shall be done with carborundum stone of 48. to 60 grade grit fitted in machine. Water shall be properly used during grinding. When the chips show up and the floor has been uniformly rubbed, it shall be cleaned with water, baring all pin holes. It shall then be covered with a thin coat of white cement mixed with or without pigments to match the colour of the topping of the tiles. Pin holes if any shall thus be filled. This grout shall be kept moist for a week. Thereafter second grinding shall be done when other works are finished. The machine shall be fitted with carborundum of grit 220 to 350 using water in abundance. The floor shall then be washed clean with water. Oxalic acid powder shall then be dusted at 33 grams per square meter on the surface and the surface rubbed with machine fitted with Hessian bobs or rubbed hard with pad of woolen rags. The floor shall then be washed clean and dried with a soft cloth or linen. The finished floor shall not sound hollow when tapped with mallet.

2.5.2. If any tile is disturbed or damaged it shall be refitted or replaced properly jointed and polished.

2.5.3. Testing of the tiles shall be carried out by the contractor at his own cost as per I.S. requirement for required test.

3.0. Mode of measurements & payment

3.1. The terrazzo tiles flooring shall be measured in sq. meters for visible area of work done.

3.2. No deductions shall be made nor extra paid for any opening in the floor area up to 0.1 sq. mt. Nothing extra shall be paid for use of cut tiles or for laying the floors at different levels in the same room or court yard. Mosaic tiles laid in floor boarders and bands etc.-shall be measured in the same item and nothing extra shall be payable on account of these or similar bonds formed of half or multiples of half size, standard tiles or other uncut tiles.

3.3. The treads of stairs and steps paved with tiles without nosing shall also be measured under this item.

3.4. Extra rate shall however be paid for such area where width of treads does not exceed 30 cms.

3.5. The rate shall be include the cost of all materials, labour involved in all the operations as described above.

3.6. The rate shall be for a unit of one sq. meter.

14.19.(B) Precast Terrazzo (Marble/Mosaic) tiles 20 mm. thick with white, black or white and black marble chips of size up to 6 mm. laid in floors treads of steps and landing on a bed of 25 mm. average thickness of lime mortar 1:1.5 (1 lime putty :1.5 fine sand) or C.M. 1:6 jointed with neat cement slurry mixed with pigment to match the shade of the tiles, including rubbing and polishing complete with precast tiles of medium shades using approximately 50% white cement and 50% ordinary cement.

1.0. Materials & Workmanship

1.1. The relevant specifications of item No. 14.19(A) shall be followed except that the precast terrazzo (marble mosaic) tiles shall be of medium shades using approximately 50% white cement and 50% ordinary cement.

2.0. Mode of measurement and payment

2.1. The rate shall be for a unit of one sq. meter.

14.19.(B) Precast Terrazzo (Marble/Mosaic) tiles 20 mm. thick with white, black or white and black marble chips of size up to 6 mm. laid in floors treads of steps and landing on a bed of 25 mm. average thickness of lime mortar 1:1.5 (1 lime putty :1.5 fine sand) or C.M. 1:6 jointed with neat cement slurry mixed with neat cement slurry mixed with pigment to match the shade of tiles including rubbing and polishing complete with precast tiles of dark shade using ordinary cement.

1.0. Materials and Workmanship

1.1. The relevant specifications of item No. 14,19 (A) shall be followed except that the precast tiles shall be of Dark shade using ordinary Portland cement.

2.0. Mode of measurements & payment

2.1. The mode of measurement and payment shall be same as item No. 14.19 (A)

2.2. The rate shall be for a unit of one sq, meter,

14.21.(A) Precast terrazzo (Marble Mosaic) tiles 20 mm. thick with marble chips of sizes up to 6 mm. in skirting and risers of steps not exceeding 30 cms. in height on 10 mm. thick cement plaster 1:3 C1 cement :3 coarse sand) jointed with neat cement slurry rubbing and polishing complete with tiles of light shades using white cement.

94

1.0. Materials

Water shall conform to M-1. Cement Mortar shall conform to M-11. The precast terrazzo (Marble/Mosaic) tiles of light shades using white cement tiles 20 mm. thick shall conform to M-47.

2.0. Workmanship

2.1. Laying :

The work shall be carried out for skirting or dedo. Before fixing precast Terrazzo (Mosaic marble) tiles of shade and size as specified, the surface shall be prepared by heavy scraping, making joints etc, to the required line, level and plumb. The surface shall be thoroughly wetted before commencing the laying work. Thereafter about 10 mm. thick backing of cement mortar in specified proportion shall be applied on the surface in true line and level generally as per specifications of plaster item.

2.2. Fixing :

The back of each tile to be fixed shall be smeared with cement paste of matching colour and the mosaic tiles shall then be gently tapped against the surface, with a wooden mallet. The skirting shall be done only after the flooring is completed. Any pipes coming out of the wall through the dedo or skirting shall only be at the intersection of the horizontal and vertical joints. The tiles shall not have staggered joints. The joints shall be true to entire line both ways and vertical joints shall be in line with joints or flooring. Tiles shall be fixed as close as possible to the adjoining tiles and any difference in the thickness of the mosaic tiles shall be evened out in the cement paste so that all the tiles faces are set in conformity with one another. The skirting shall project uniformly and not more than 6 mm, thickness beyond the finished surface above. Top of skirting or dedo shall be truly horizontal. The risers of steps, skirting or dedo shall rest on top of treads of flooring. Wherever required the tiles shall be cut (sawn) and thin edges smoothed before use.

2.3. Curing :

Curing shall be done for 7 days continuously.

2.4. Finishing:

Skirting and dedo shall be hand polished to have an even smooth and shining surface. In case of skirting only 10 mm. x 10 mm. groove shall be provided at the junction of cement plaster and cement tiles.

3.0. Mode of measurements & payment

3.1. The terrazzo tiles with light shade using white cement base shall be paid under this item. The length shall be measured along finished surface of the riser, skirting or dedo, correct to a centimeter height measured from finished level of treads, or floor to the top (under side of treads in case of steps).

3.2. The rate shall include all materials and labour required for all the operations involved and described above.

3.3. The rate shall be for a unit of one sq. meter.

14.21.(B) Precast terrazzo tiles 20 mm. thick with marble chips of sizes up to 6 mm. in skirting and risers of strips not exceeding 30 cms. in height on 10 mm. thick cement plaster C.M. 1:3 (1 cement :3 coarse sand) jointing with neat cement slurry including rubbing and polishing complete with tiles of : medium shades using approximately 50% white cement and 50% ordinary cement.

1.0. Materials and workmanship

1.1. The relevant specifications of item No, 1*1 21 (A) shall be followed except that the work is for using tiles of medium shades using approximately 50% white cement and 50% ordinary cement.

2.0. Mode of measurements & payment

2.1. The mode of measurements and payment shall be followed same as item No. 14.21 (A).

2.2. The rate shall be for a unit of one sq. meter.

14.21.(C) Precast terrazzo tiles 20 mm. thick with marble chips of sizes up to 6 mm. in skirting and risers of steps not exceeding 30 cms. in height on 10 mm. thick cement plaster in C.M. 1:3 (1 cement :3 coarse sand) jointing with neat cement slurry including and polishing complete, with tiles of Dark shade using ordinary cement.

1.0. Materials & Workmanship

1.1. The relevant specifications of item No. 14.21 (A) shall be followed except that the tiles of dark shade using Portland cement shall be used.

2.0. Mode of measurements and payment

2.1. The mode of measurements and payment shall be followed as per item No. 14.21 (A).

2.2. The rate shall be for a unit of one sq. meter.

95

14.25.(A) Chequered terrazzo tiles 22 mm. thick with marble chips of size up to 6 mm. in floor on 25 mm. thick bed of lime mortar 1:1.5 (1 lime putty : 1.5 coarse sand) or C.M. 1:6 jointed with neat cement slurry mixed with pigment to match the shade of the tiles including rubbing and polishing etc. complete, light shade using white cement.

1.0. Materials

Water shall conform to M-1. White cement shall conform to M-4. Lime mortar of proportion 1:1.5 shall conform to M-10. Cement mortar shall conform to M-11. Chequered tiles shall conform to M-47 D.

2.0. Workmanship

2.1. The relevant specifications of Item No. 14.21 (A) shall be followed except that chequered tiles of light shade using white cement shall be used.

3.0. Mode of measurement & payment

3.1. The relevant specifications of item No. 14.21 (A) shall be followed.

3.2. The rate shall be for a unit of one sq. meter.

14.25.(B) Chequered terrazzo tiles 22 mm. thick with marble chips of size up to 6 mm. in floor on 25 mm. thick bed of lime mortar 1:1.5 (1 lime putty : 1.5 coarse sand) or C.M. 1:6 painted with neat cement slurry mixed with pigment to match the shade of the tiles including rubbing and polishing etc. complete, medium shade using approximate 50% the cement and 50% ordinary cement.

1.0. Materials and workmanship

1.1. The relevant specification of item No. 14.25 (A) shall be followed except that chequered tiles of medium shade approximate 50% white cement and 50% ordinary cement shall be used.

2.0. Mode of measurements & payment

2.1. The relevant specifications of item No. 14.25 (A) shall be followed.

2.2. The rate shall be for a unit of one sq. meter.

14.25.(C) Chequered terrazzo tiles 25 mm. thick with marble chips of size up to 6 mm. in floor on 25 mm. thick bed of lime mortar 1:1.5 (1 lime putty : 1.5 coarse sand) or C.M. 1:6 jointed with neat cement slurry mixed with pigment to match the shade of the tiles including rubbing and polishing etc, complete, : Dark shade using ordinary cement.

1.0. Materials and workmanship

1.1. The relevant specification of item No. 14.25 (A) shall be followed except that chequered tiles of dark shade using ordinary cement shall be used.

2.0. Mode of measurements & payment

2.1. The relevant specifications of item No. 14.25 (A) shall be followed.

2.2. The rate shall be for a unit of one sq. meter.

14.27.(A) Chequered terrazzo tiles 28 mm. thick with marble chips of size up to 6 mm. in treads of stairs and staircases in 12 mm. thick bed of lime mortar 1:5 coarse sand) to C.M. 1:6 jointed with neat cement slurry mixed with pigment to match the shade of the tiles including rubbing and polishing etc. complete, Dark shade using ordinary cement.

1.0. Materials and workmanship

1.1. The relevant specification of item No. 14.25 (A) shall be followed except that chequered tiles 28 mm. thick

of light shade using white cement shall be used in trades, stair cases etc.

2.0. Mode of measurements & payment

2.1. The relevant specifications of item No. 14.25 (A) shall be followed.

2.2. The rate shall be for a unit of one sq. meter.

14.27 (B) Chequered terrazzo tiles 22 mm. thick with marble chips of size up to 6 mm. in floor in on 25 mm. thick bed of lime mortar 1:1.5 (1 lime putty : 1.5 coarse sand) or C.M. 1:6 jointed with neat cement slurry mixed with pigment to match the shade of the tiles including rubbing and polishing etc. complete : Medium shade of using approximately 50% white cement and 50% ordinary cement.

1.0. Materials and Workmanship

1.1. The relevant specifications of item No. 14.25(A) shall be followed except that the chequered tiles 28 mm. thick of medium shade using approximately 50% white cement and 50% ordinary cement shall be used in treads of stair, staircases etc.

96

2.0. Mode of measurement and payment

2.1. The relevant specifications of item No. 14.25 (A) shall be followed.

2.2. The rate shall be for a unit of one sq. meter.

14.27.(C) Chequered terrazzo tiles 28 mm. thick with marble chips of sizes up to 6 mm. in treads of stairs and staircases in 12 mm. thick bed of lime mortar 1:1.5 (1 Lime putty: 1.5 coarse sand) or c.m. 1:6 jointed with neat cement slurry mixed with pigment to match the shade of tiles including rubbing and polishing complete : Dark shade using ordinary cement.

1.0. Materials and Workmanship

1.1. The relevant specifications of item No. 14.25 (A) shall be followed except that chequered tiles 28 mm. thick of dark shade using ordinary cement shall be used in treads of stair, staircase etc.

2.0. Mode of measurements and payment

2.1. The relevant specifications of item No. 14.25 (A) shall be followed.

2.2. The rate shall be for a unit of one sq. meter,

14.29 White glazed tiles 6 mm. thick in flooring, treads of steps and landings laid on a bed of 12 mm. thick cement mortar 1:3 (1 cement : 3 coarse sand) finished with flush pointing in white cement.

1.0. Materials

Water shall conform to M-1 Cement mortar shall conform to M-11 White glazed tiles shall conform to M-55

2.0. Workmanship

2.1. Bedding :

2.1.1. The sub grade shall be cleaned, wetted and mopped. The bedding shall then be laid evenly over the surface tamped and corrected to desired level and allowed to harden enough to offer a rigid cushion to tiles and to enable the monsoon to place wooden planks across and squat on it.

2.1.2. The white glazed tiles shall be laid on cement mortar bedding of 12 mm. thick in C.M. 1:3. The mortar shall have sufficient plasticity for laying and there shall be no hard lumps that would interfere with the evenness of bedding. The base shall be cleared and well wetted. The mortar shall then be spread in thickness not less than 10 mm. at any place and average 12 mm. thickness. The proportion of the cement mortar shall be as specified in the item.

2.2. Fixing tiles :

2.2.1. The tiles before laying shall be soaked in water for at least tow hours. Neat gray cement grout at 33 kg/Cement/Sq. mt. of honey like consistency shall be spread over the mortar bedding as directed. The edges of the tiles shall be smeared with neat cement slurry. The tiles shall be well pressed and gently tapped with a wooden mallet till they are properly bedded and in level with the adjoining tiles. There shall be. no hollows in bed or joints. The joints between the tiles shall be as thin as possible in straight line or as per pattern.

2.2.2. The tiles shall not have staggered joints. The joints shall be true to centre line both ways. The Nahni trap coming in the flooring shall be so positioned that its grating shall replace only one tile as far as possible. Where full size tiles cannot be fixed they shall be cut (Swan) to the required size and the edges rubbed smooth to ensure straight and true joints. The joints shall be filled with grey cement grout with wire brush or trowel to a depth of 5 mm. and loose material removed. White cement shall be used for pointing the joints. After fixing the tiles finally in an even plane the flooring shall be kept wet and allowed to nature undisturbed for 7 days.

2.3. Cleaning :

2.3.1. The surplus cement grout that may have come out of the joints shall be cleaned off before it sets. Once the floor has set, it shall be carefully washed, cleared by dilute acid and dried. Proper precautions and measures shall be taken to ensure that the tiles are not damaged in any way till the completion of the .construction.

3.0. Mode of measurements & payment

3.1. The work done shall be measured in sq. mt. for visible area of work done. The length and width of the flooring shall be measured not between the faces of skirting or dedos or plastered face of wall as the case may be. The paving under dedo or skirting shall not be measured. No deduction shall be made not extra paid for any opening in the floor of area-up to 0.1 sq.mt. Nothing extra shall be paid for laying the floors at different levels in the same rooms.

97

3.2. The rate shall be for a unit of one sq. meter.

14.32. White glazed tiles 6 mm. thick in skirting, risers of steps and dedo on 10 mm. thick cement

plaster 1:3 (1 cement :3 coarse sand) and jointed with white cement slurry.

1.0. Materials

Water shall conform to M-1 Cement mortar shall conform to.M-11 White glazed tiles shall conform to M-55

2.0. Workmanship

2.1. Preparation of Surface:

In case of brick masonry wall, the joints shall be raked out to a depth of least 15 mm. while the masonry is being laid. In case of concrete wall the surface shall be chiseled and roughed with wire brushes. The surface shall be cleaned and wetted thoroughly before commencing the laying work.

2.2. Laying ;

2.2.1. The wall surface shall be covered with 10 mm. thick plaster of cement mortar 1:3 mix and allowed to harden. The plaster shall be roughened with wire brushes both way. The back of tiles shall be floated with grey cement slurry set and edges with white cement slurry in bedding mortar. The tiles shall be gently tapped in position on after the other keeping the joints as thin as possible. Top of skirting or dedo shall be truly horizontal and the joints vertical or as per required pattern.

2.2.2. Risers of steps, skirting and dedo shall rest on top of treads or flooring. Where full size tiles cannot be fixed, They shall be cut to the required size and the edges be smoothed.

2.2.3. The joints shall be cleaned and flush pointed with white cement. The surface shall be kept wet for seven days. After curing the surface shall be washed clean.

3.0. Mode of measurements and payment

3.1. The rate shall include the cost of all materials and labour required for various operations described above. Risers of steps, skirting and dedo shall be measured in square meters, length and height shall be measured along the finished face of the skirting or dedo including curves, where special such as covers, internal and external angles, etc., used. The length and height shall be measured correct to the centimeter except in case of risers and skirting where height shall be measured correct to 3 mm

3.2. The rate shall be for a unit of one sq. meter.

14.34. Providing and fixing 50 mm. internal or external -angles of white glazed tiles.

1.0. Materials

Water shall conform to M-1. Cement mortar shall conform M-11. Glazed tiles shall conform to M-55.

2.0. Workmanship

2.1. The relevant specifications of item No. 14.32 shall be followed except that the internal or external angles of glazed tiles shall be of thickness not less than the tiles with which they are used. The fixing shall be done as per directions.

3.0. Mode of measurements and payment

3.1. Rate shall be including the cost of materials and labour involved in all the operation described above.

Internal or external angles of glazed tiles shall be measured in running meters correct tip to a centimeter. length being measured on the exposed face of the special at its centre line. No extra payment shall be made for corner places at angles junctions of cover beads and cornices for using cut length of special.

3.2. The rate shall be for a unit on one running meter.

14.36.(A) Providing and laying marble stone slab flooring over 20 mm. (Average) base of cement mortar 1:6 (1 cement : 6 coarse sand) or L. M. 1:1.5 laid and jointed with gray cement slurry including rubbing and polishing compete : Marbles slab 25 mm. thick.

1.0. Materials

Water shall conform to M-1. Lime mortar shall conform to M-10. Cement mortar shall conform to M-1). Marble stone slab 25 mm. thick shall conform to M-51.

2.0. Workmanship

2.1. Dressing of slabs :

Every stone shall be cut to required size and fine chisel dressed to give a smooth and even surface on all sides to full depth. A straight edge laid along the sides of the stone shall be fully in contact with it Chisel dressing shall also be done on top surface to remove any waviness. The sides and top surface of marble

98
slabs shall be machine rubbed or table rubbed with coarse sand before using. All angles and edges or slabs shall be true, square and free from chipping.

2.2 The thickness of stone shall be 25 mm. The allowable tolerance shall be 2 mm. allowable. The 'tolerance shall + 5 mm. in length and breadth.

2.3. Bedding:

Bedding of marble slabs shall either be lime mortar 1:1.5 (1 lime putty : 1.5 coarse sand) or cement mortar 1:6 (1 cement : 6 coarse sand) of average thickness 20 mm. thick as given in description of item. Minimum thickness at any place shall not be less than 10 mm.

2.4. Laying

The surface of sub-grade shall be cleared, wetted and mopped. Mortar of specified mix and thickness shall then be spread on an area sufficient to receive one marble slab. The slab be washed clean before laying. It tie laid on top pressed and tapped gently to bring it in level with other slabs. It shall then be lifted and a side. The top surface of the mortar shall then be corrected by adding fresh mortar at hollows, or depressions. The mortar shall then be allowed to harden it over this surface cement slurry or honey like consistency at 4.4 Kg. of cement per sq. meter. The edges of slabs already paved shall be buttered with gray cement. The slab shall then be gently placed in position and tapped with wooden mallet till it is properly bedded in level with and close to the adjoining slab. The joints shall be as fine as possible. Surplus cement on the surface of the slab shall be removed. The slab fixed in the

floor adjoining the walls shall enter not less than 10 mm. under the plaster skirting or dedo. The junction between the walls and floors shall be finished neatly. The finished surface shall be true to level and slopes as directed.

2.5. Curing : The floor shall be cured for a minimum period of seven days.

2.6. Polishing and finishing:

Unevenness at the meting edges of slab shall be removed by fine chiseling. Finishing etc. shall be done as per relevant specifications of item No. 14.21 (A) or terrazzo tiles flooring except that cement slurry with/ or without pigments shall not be applied on the surface before each polishing.

3.0. Mode of measurements and payment

3.1. Marbles stone flooring with various kinds of marble shall be measured in sq. meter. The length and breadth shall be measured between-the finished face of skirting or dedo or wall plaster No deduction shall fie made nor extra shall be paid for nay opening in the floor or area up to 0.05 sq. mt. Nothing extra shall be paid for laying stone at different levels in the same room. Treads and steps of stairs paved with marble stone slabs shall be also be measured under flooring.

3.2. The rate shall be for a unit of one sq. meter.

14 43.(A) Kota stone slab (Polished, Green colour) flooring over 20 mm. (avage) thick base of cement mortar 1:6 (1 cement : 6 coarse sand, or lime mortar 1:1.5 laid over and jointed with gray cement slurry including rubbing and polishing complete 25 mm. thick.

1.0. Materials

1.1. Water shall conform to M-1. Lime mortar shall conform to M-10. Cement mortar shall conform to M-11 Polished kota stone shall conform to M-49,

2.0. Workmanship

2.1. Each slab shall be cut to the required size and shape and fine chisel dressed at all the edges. The sides trust dressed shall have a full contract if a straight edge is laid along. The sides shall be table rubbed with coarse sand before paving. All angles and edges of the slabs shall be true square and free from chippings and giving a plane surface. The thickness shall be 25 mm. (Average) as specified in the item but not less than 20 mm. at any place of the slab.

2.2. Bedding for the Kota stone slabs shall be of cement mortar 1:6 (1 cement : 6 coarse sand) or L.M. 1:1.5 of average thickness 20 mm given in the description of the item. Sub grade shall be cleaned, wetted and mopped Mortar of the specified mix and thickness shall then be spread on an area sufficient to receive one kota stone slab. The slab shall be washed clean before laying. It shall be laid on top, pressed, tapped gently to bring it in level with the other slabs. If shall then be lifted and laid aside. Top surface of the mortar shall then be corrected by adding fresh mortar at hollows or depressions. The mortar shall then be allowed to harden bit.

Over this surface, cement slurry of honey-like consistency shall be applied. The slab shall then be gently placed in position and tapped with wooden mallet till it is properly padded in level with and close to the adjoining slab. The joint shall be as fine as possible. The slabs fixed in the floor adjoining, the
99

walls shall enter not less than 10 mm. under the plaster, skirting or dedo. The junction between the wan and floor shall be finished neatly. The finished surface shall be true to levels and slopes as directed

2.3. The floor shall be kept wet for a minimum period of 7 days so that bedding and joints set properly

2.4. Polishing shall be normally commenced after 14 days of laying the stone slab. First polishing shah be done with carborundum stones of 120 grade grit fitted in the heavy machine and then second polishing shall be done with carborundum stone of 220 to 350 grade grit fitted in heavy machine. Water shall be properly used during polishing. The stone shall then be washed clean with water When directed by the Engineer-in-charge, wax polish of approved quality shall be applied on the surface with the help of soft cloth over a clean and dry surface. Then the polishing machine fitted with bobs shall be run over it.

2.5. The holes required for Nahni traps, pipes and any other fittings shall be made, without any extra cost.

3.0. Measurement & payment

3.1. The rate shall include the cost of all materials and labour involved in ail the operations described above.

The kota stone flooring shall be measured in square meters correct to two places decimal, length and breadth shall be measured correct to a centimeter and between the finished face of skirting dedo plaster and no deduction shall be made nor extra paid for any opening in floor of areas up to 0 1 sq

3.2. The rate shall be for a unit of one sq. meter

14.43.(B) Kota stone slab flooring over 20 mm. (average) thick base of cement mortar 1:6 (1 cement :6 coarse sand) or L.M. 1:1.5 laid over and jointed with gray cement slurry including and polishing complete : 30 mm. thick.

1.0. Materials and workmanship

1.1. The relevant specifications of item No 14 43 (A) shall be followed except that the thickness of stone shall be 30 mm.

2.0. Mode of measurements & payment

2.1. The relevant specifications of item No 14.43 (A) shall be followed.

2.2. The rate shall be for a unit of one sq. meter.

14.44. Kota stone slab 25 mm. thick in riser of steps dedo and pillars laid on 10 mm. thick cement mortar 1:3 (1 cement : 3 coarse sand) and jointed with gray cement slurry including rubbing and polishing etc. complete.

1.0. Materials

Water shall conform to M-1. Cement mortar shall conform to M-11. Kota stone slab 25 mm thick shall conform to M-

49.

2.0. Workmanship

2.1. The relevant specifications of item No. 14.43(A) shall be followed except that the kota stout-fixed for risers of steps, dedo or skirting in C.M. 1:3 and the polishing shall be done manually instead of machine polishing.

3.0. Mode of measurements and payment

3.1. The risers of steps, skirting or dedo shall be measured in sq. meter Length shall be measured along the finished faces of risers, skirting or dedo. Height shall be measured from finished level of treads of floor to top. Lining of pillars shall be measured under this item.

3.2. The rate shall be for a unit of one sq. meter.

14.46.(A) Rough chiseled dressed (Kota stone green) stone flooring over 20 mm. thick base of cement mortar 1:5 (1 cement :5 coarse sand), or L.M. 1:1.5 including pointing wit cement mortar 1:2 (1 cement : 2 stone dust) etc. complete 25 mm. thick.

1.0. Materials

Water shall conform to M-1. Lime mortar shall conform to M-10. Cement mortar shall conform to M-11 Rough chisel dressed stone shall conform to M-48.

2.0. Workmanship

2.1. The relevant specifications of item No. 14.43 (A) shall be followed except that the rough chisel dressed stone of 25 mm. thickness of approved quality are to be fixed on cement mortal bedding in CM 1:5 or L.M. 1:1.5 of 25 mm. average thickness.

2.2. Dressing of stone slab :

Every stone slab shall be cut to the required size and shape and rough chisel- dressed on top, if required, so that the dressed surface shall not be more than 6 mm, from straight edge placed on it. The sides shall

100
also he chisel-dressed to a minimum depth of 20 mm. so that the dressed edge shall at no place be more then 30 mm. from straight edge butted against it. Beyond this depth, the sides may be dressed slightly splayed so as to form an inverted V shaped joint with adjoining also. The surface shall be reasonable true and plane and all the angles and edges shall be square and free from chippings. Where the stone slabs are to be used for nosing, exposed edges shall be rough chisel-dressed to full depth and cut to the uniform thickness.

2.3. Thickness of the stone slab shall be 25 mm. with permissible tolerance of + 2 nun.

2.4. Laying :

The surface of the sub-grade concrete shall be cleaned, wetted and mopped. The bedding of specified mortar mix shall he spread under each slab to the specified thickness. The slab shall be washed clean before laying. It shall be than laid on top. pressed and so that all hollows underneath filled surplus mortar works up through the joints. The top shall be tapped and brought level to the adjoining slab. The thickness of the joints shall not exceed 5 mm. Subsequent slabs shall be laid in the same manner

2.5. Curing & Finishing :

Any surplus mortar on the surface of the slab shall be cleaned off and joints-finished flush. The joints shall be raked out uniformly to a minimum depth of 12 mm. under the plaster, skirting or dedo. The junctions between wall plasters and floor shall .be finished neatly and without wavirless. The pointing shall be done with C.M. 1:2. The pointing shall be cured for a minimum period of seven days. The finished floor shall not sound hollow when tapped with wooden mallet and the finished surface shall be true to level and slopes as directed.

3.0. Mode of measurements & payment

3.1. The relevant-specifications of item No. 14.43 (A) shall be followed.

3.2. The rate shall be for a unit of one sq. meter.

14.46.(B) Rough chisel dressed (Kota stone green) stone flooring over 20 mm. thick base of cement mortar 1:5 (1 cement : 5 coarse sand) or Lime Mortar 1:1.5 including pointing with cement 1:2 (1 cement : 2 stone dust) etc., complete-40 mm. thick.

1.0. Materials and Workmanship

1.1. The relevant specifications of item No. 14.46 (A) shall be followed except that the thickness of stone slabs shall be 40 mm. thick.

2.0. Mode of measurements & payment

2.1. The relevant specifications of item No 14.46(A) shall be followed.

2.2. The rates shall be for a unit of one sq. meter.

14.71.(A) Cement concrete flooring for I.P.S, 1:2:4 (for Indian Patent Stones) (1 cement : 2 coarse sand : 4 graded stone aggregate 20 mm. nominal size) laid in one layer finished with a floating coat of neat cement 40 mm. thick.

1.0. Materials

Water shall conform to M-1. Cement shall conform to M-3. Sand shall conform to M-6. Stone aggregate 20 mm. nominal size shall conform to M-12. Cement concrete of 1:2:4 proportion measured by volume shall conform to relevant specifications of ordinary grade 1:2:4 concrete.

2.0. Workmanship

2.1. The cement concrete flooring of 40 mm thick (Average) is to be laid as per the site condition. The concrete shall be mixed in a mechanical mixer at the work. Hand mixing may however be allowed for smaller quantities of work and in case of failure of machineries or as permitted by the Engineer-in-charge. It shall be carried out on a water tight platform and care shall be taken to ensure that mixing is continued until the mass is uniform in colour and consistency. However is such cases 10% more cement than otherwise required shall have to be used without any extra cost. The mechanical mixing shall be done for period of 1.1/2 to 2 minutes. The quantity of water shall be

just sufficient to produce a dense concrete of required workability for the purpose, Flooring or specified thickness shall be laid in accordance with approved pattern or as directed. Finishing operation shall depending upon the temperature

and atmospheric conditions. The surface shall be left for some time till moisture disappears from it.

Fresh quantity of cement shall be mixed with water to form a thick slurry and spread over the surface while the concrete is still green. Use of dry cement or cement and sand mixture sprinkled on this surface to stiffen the concrete or absorb excessive moisture shall not be permitted.

The cement slurry shall then be properly pressed twice by means of iron floats, once when the slurry is applied and the second time when cement setting and finished floated smooth

The surface shall be marked with string or B.R.C. fabric jali to make the surface non-slippery as and when directed. The junction of floors with wall plaster, dedo or skirting shall be rounded off where so

101 required up to 25 mm. radius. Flooring in lavatories and bath rooms shall be laid after fixing of water closet and squatting pans and floor traps which shall be plugged while laying the floors and opened after the floors are completed. Any damage done to water supply or sanitary fittings during execution of work shall be made good.

2.2. After the final set, the concrete shall be kept continuously wet. if required by ponding for a period of not less than 7 days from the date of placement.

2.3. The form work shall be provided if necessary as directed by Engineer-in-charge. Concreting shall be done as per alternate bay method with necessary centering either by mastic or cement mortar as directed

3.0. Mode of measurements & payment

3.1. The rate shall include the cost of all materials and labour involved in all the operations described above. No deduction shall be made or extra paid for any opening up to 0.1 sq. mt. In area in the floor, nothing extra shall be paid for laying the floor at different levels in the same room or the counter yard.

3.2. The rate shall be for a unit of one sq. meter.

14.71.(B) Cement concrete flooring (Indian patent stone) 1:2:4 coarse sand 4: graded stone aggregate 20 mm. nominal size) laid in one layer finished with floating coat of neat cement : 50 mm. thick.

1.0. Materials & Workmanship

1.1. The relevant specifications of item No. 14.71 (A) shall be followed except that the thickness of concrete flooring shall be 50 mm.

2.0. Mode of measurements & payment

2.1. The relevant specifications of item No. 14.71. (A) shall be followed.

2.2. The rate shall be for a unit of one sq. meter.

14.74. Cement concrete payment (25 mm. to 50 mm. thick) with 1:2:4 (1 cement : 2 coarse sand : 4 stone aggregate 20 mm. nominal size) including finishing with a floating coat of neat cement complete.

1.0. Materials and workmanship

1.1. The relevant specifications of item No. 14.71 (A) shall be followed except that the thickness of concrete flooring vary from 25 mm. to 50 mm.

2.0. Mode of measurements & payment

2.1. The relevant specifications of item No.14.71 (A) shall be followed except that thickness shall be measured correct up to 1 mm. flooring laid in borders, margins and treads of steps, shall be measured under item of flooring in respective of width.

2.2. The rate shall be for a unit of one cubic meter.

14.81.(C) 20 mm. thick precast concrete tile with aggregate of sizes up to 6 mm. laid in floors, treads of steps and landings on 20 mm. thick bed of cement mortar 1:6 (1 cement : 6 coarse sand) or L.M. 1:1.5 jointed with neat cement slurry with pigment to match the shade of the tiles complete with precast tiles of Dark Shades ordinary cement.

1.0. Materials

Water shall conform to M-1. Cement shall conform to M-2. Sand shall conform to M-6. Lime mortar 1:1.5 shall conform to M-10. Cement shall conform to M-11. Tiles shall conform to M-47 (A) cement concrete tiles shall conform to I.S. 1237-1959 and pigments to be admixed with mortar or for grouting shall conform to I.S. 2114-1962

2.0. Workmanship

2.1. The tiles shall be laid on the sub-grade of concrete of the R.C.C. slab. Bedding shall be in the mortar 1:1.5 or cement mortar (1:6). The amount of water added shall be minimum required for sufficient plasticity and workability C.M. or lime mortar where the ingredients shall be thoroughly mixed dry hard lumps removed and water added to give a good workability.

102

2.2. The base shall be cleaned of all dust, dirt and scum and properly wetted without allowing water pools. For a bedding of cement mortar shall be then spread evenly over the base of two rows of tiles and three to five meters in length. The top shall be kept rough so that cement slurry can be absorbed. The thickness of the bedding shall be not less than 10 mm. at any place. The laying of tiles shall be commenced with neat cement slurry of honey-like consistency and shall be spread over the mortar bed over an area sufficient to receive about 20 tiles. The tiles shall then be fixed in this grout one after the other, each tile being gently tapped and properly bedded in line and level with the adjoining tiles. The joints shall be as narrow as possible and normally shall not exceed 1.5 mm. After the day's work the excess cement slurry on top shall be cleaned as also the joints with a broom struck and washed before the slurry sets hard. Next day the joints shall be filled with the cement grout of the same shade as the matrix

of the tiles. Tiles which are fixed in the floor adjoining the wall shall go a minimum of 10 mm. under the wall plaster, skirting or dedo. For the purpose, plaster etc. may be left unfinished by about 50 mm. above the proposed finished level of the floor. The unfinished strip shall be plastered after laying the floor tiles. Where full tile cannot be used, tile shall be cut to the size to be used.

2.3. The flooring shall be cured for 7 days.

3.0. Mode of measurements and payment

3.1. The rate shall include the cost of all materials and labour involved in all the operations described above.

3.2. The rate shall be for unit of one sq. meter.

14.86. Chequered precast cement concrete tiles 22 mm. thick with aggregate of sizes up to 6 mm. in floors, treads of steps and landings on 20 mm. thick bed of C.M. of 1:6 (1 cement : 6 sand) or lime mortar 1:1.5 (1 Lime putty : 1.5 coarse sand) jointed with cement slurry with pigment to match the shade of tiles.

1.0. Materials

1.1. The relevant specifications of item No. 14.25 (A) shall be followed.

2.0. Workmanship

2.1. The relevant specifications of item No 14.21 (A) shall be followed except that chequered precast cement concrete tiles 22 mm. thick shall be used in floors, treads of steps and landings on average 20 mm. thick bed of C.M. 1:6 or L.M. 1:1.5.

3.0. Mode of measurements and payment

3.1. The relevant specifications of item No. 14.21 (A) shall be followed.

3.2. The rate shall be for unit of one sq. meter.

14.87. Extra for polishing and polishing the precast cement concrete tiles in flooring, skirting or dedo.

1.0. Workmanship

1.1. Grinding and rubbing shall normally be commenced after 14 days of laying the tiles, except for skirting or small areas, machine shall be used for the purpose.

1.2. First grinding shall be done with carborundum stones of 48 to 60 grade grit fitted in machine. Water shall be properly used during grinding. When the chips show up and the floor has been uniformly rubbed, it shall be cleaned with water baring all pin holes It shall then be covered with a thin coat of gray or white cement mixed with or without pigments to match the colour of the topping of the tiles Pin holes if any shall thus be filled. This grout shall be kept moist for sufficient period as directed. Thereafter, second grinding shall be started with carborundum of 120 grit. Grouting and curing shall be followed again. Final grinding shall be done when other works are finished. The machine shall be fitted with carborundum of grit 220 to 350 using water in abundance. The floor shall then be washed clean with water Oxalic acid powder shall then be dusters as needed on the surface and the surface rubbed with machine fitted with Hessian bobs 01 rubbed hard with pad of woolen rags. The floor shall then be washed, cleaned and dried with a soft cloth of linen. The finished floor shall not sound hollow when tapped with a mallet.

1.3. If any tile is disturbed or damaged it shall be refitted or replaced properly jointed and polished. 1.4. For skirting, dedo or small areas where it is not possible to do machine polishing all the above operations are to be done manually.

2.0. Mode of measurements and payment

2.1. The rate shall include the cost of all materials and labour involved to all the operations as described above.

2.2. The rate shall be for a unit of one sq, meter.

103

14.90. Providing and laying brick on edge flooring laid dry, grouted with C.M. 1:6 (1 cement : 6 coarse sand) including finishing the joints flush, curing etc. complete.

1.0. Materials

Water shall conform to M-1. Cement mortar shall conform to M-11. Burnt bricks shall conform to M-15.

2.0. Workmanship

2.1. The flooring shall be laid on concrete sub grade where so provided. The slope in the floor shall be provided in the sub-grade. Where sub-grade is not provided, the earth below shall be properly sloped, watered, rammed and consolidated. Before laying the flooring it shall be moisture. Plinth masonry off-eta shall be depressed so as to allow the sub grade concrete to rest on it.

2.2. Laying :

The brick shall be laid in plain, diagonal herring bond, or other pattern as directed. The bricks shall be dry laid properly and set home by gently tapping. On completion of the portion of flooring the vertical joints shall be grouted with C.M. 1:6 and all joints shall be finished flush. The joints shall be as fine as possible and not exceeding 5 mm. These points shall be filled with cement mortar 1:6.

2.3. Curing :

The brick paving shall be cured for 7 days.

3.0. Mode of measurements and payment

3.1. The length and breadth shall be measured correct to a centimeter between skirting dedo or wail plaster.

No deductions shall be made nor extra paid for any opening up to 0.1 sq.mt. in area in the floor Nothing extra shall be paid for laying the floors at different levels in the same room or courtyard.

3.2. The rate shall be for unit of one sq. meter.

104

SECTION-15

Roof Covering

15.1. Providing corrugated G.I. sheets roofing fixed with galvanized iron 1J' or 1L' hook bolts and nuts 8 mm. dia. with bitumen and G.I. limpet washers filled with white lead complete excluding the cost of purline, rafters and trusses (1) 0.8 mm. thick sheet.

1.0. Materials :

Corrugated G.I. sheets shall conform to M-23.

2.0. Workmanship

2.1. Spacing of purlines : One purline shall be provided at the ridge and one at the eaves. The spacing of other purlines for 0.8 mm. thick G.I. sheets shall not exceed 1.80 meters. The purline shall coincide with the centre line of the end lap. The ridge purlines shall be placed in such a way that the ridges can be fixed properly. The portion overhanging the wall support shall not be more than one fourth of the 'spacing of purlins.

2.2. The top surfaces of the purlines shall be painted before the sheets are fixed over them. Embedded portions of purlins shall be finished with tow coats of coal-tar.

2.3. Laying of sheets :

2.3.1. The sheets shall be laid in purlins to a true plane with the line of corrugations truly parallel or normal to the sides of area to be covered. The sheets shall not generally be built into gables and parapets. They shall be bent up along their side edges close to the wall, and the junction shall be protected by suitable flushing or by projecting drip course.

2.3.2 The laps at end shall be provided 150 mm. minimum for roof slopes 1 in 2 (1 vertical : two horizontal) and steeper but 200 mm. shall be provided for flatter slopes than those above. The side lap shall be provided two ridges of corrugations at each side.

2.3.3. The sheets shall be cut to the dimensions or the shape of the roof either along their lengths or their width or in slant across the line of corrugations at hips and valleys. The sheets shall be cut carefully with a straight edge and chisel to give straight finish. The sheets shall be laid such that the laps are turned away from the usual direction of local heavy rain.

2.3.4. Fixing of sheets :

2.3.4.1. Sheets shall be fixed to the purlins or other roof members such as hips or valley rafter etc. with 1J' or 1L' galvanized hook bolts, and galvanized nuts 8 mm. dia. with bitumen limpet washers and G.I. washers. Limpet washers with white lead shall be used. Length of hook bolt shall be varied to suit the site requirement. Bolts shall be sufficiently long so that after fixing the project above the top of their nuts by not less than 12 mm the grip of 1J' or 1L' hook bolts on the sides of purlins shall not be less than 25 mm. There shall be minimum of three hooks bolts placed at the ridge of corrugations in each sheet in every purlin and their spacing shall not exceed 300 mm. Coach screw shall not be used for fixing the sheets to purlin, where the slopes of roof are not less than 2.1/2 degree (1 vertical and 2.1/2 horizontal). Sheets shall be jointed together at the side laps by galvanized iron bolts and nuts 25 mm. x 6 mm. size each bolt with a bitumen and G.I. limpet washer filled with white lead. Where the overlaps at the sides extend to two corrugations, these bolts shall be placed zigzag over lapping corrugations, so that the ends of the overlapping sheets are drawn tightly towards each other. The spacing of same bolts shall not exceed 600 mm. along each of the staggered rows.

2.3.5. Holes for all bolts shall be drilled and not punched in the ridges of the corrugations from the under side, while the sheets are on the ground. The holes in the sheets shall be at least 50 mm. from the edge. ' Sheets drilled wrongly shall be rejected. The holes in the washers shall be of the exact diameter of the hook bolts or the beam bolts. The nuts shall be tightened from above to give a leak-proof roof

3.0. Mode of measurements and payment

3.1. The measurements of the C.G.I sheet roof shall be taken for finished work in superficial area in general plane (not girthed on the roof). The laps between the C.G.I. Sheets both at their ends and along the side edges shall not be measured. The overlaps of C.G.I. sheets over the valley piece and their under lap under the ridge, hip and flashing piece shall be included in the measurements.

105

3.2. No deductions in measurements shall be made for openings for chimney stacks, sky light etc., of area up to 0.40 sq. mt. nor extra be paid for labour in cutting and for wastage etc. in forming such openings.

3.3. The rate of roof shall include the cost of all materials and labour involved in all operations described above. The rate also includes the cost of provision, erection and removal of the .scaffolding, benching, ladders, templates and tools required for the proper execution and erection of the work. The rate includes the cost of purlins, rafters and trusses.

3.4. The rate shall be for a unit of one sq. meter.

15.7. Providing ridges of hips 600 mm. overall in plain G.I. sheets fixed with G.I. 'J' or 'L' hooks bolts and nuts 8 mm. dia. G.I. limpet and bitumen washer etc. complete. 0.80 mm. thick sheet.

1.0. Material

The G.I. valley gutters and ridges shall conform M-23 A.

2.0. Workmanship

2.1. The relevant specification of item No. 15.1 shall be followed except that the work shall be carried out for ridges or hips. The overlaps for ridges and hips or either side over the C.G.I. sheets and end legs shall be minimum 225 width of the ridges and hips shall be as described in the item.

2.2. Ridges shall be fixed to the purlins with same 8 mm. dia. G.I. hook bolts and nuts and bitumen and G.I. limpet washers, which fix the sheets for the purline. Hips shall be fixed to the roof members with the same 8 mm.

dia G.I. hook bolts and nuts and bitumen and G.I. limpet washers which fixed the sheets. At least one of the fixing bolts shall pass through the end laps of the ridges and hips on other sides. If this is not possible, extra hook bolt shall be provided. End laps of ridges and lips shall be jointed together by galvanized iron seam bolts and G.I. Washers. There shall be at least two such bolts in each end lap.

2.3. Ridges and hips shall fit in squarely on the sheets.

3.0. Mode of measurements and payment

3.1. The measurements of ridges or hips shall be taken for finished work in length along their centre lines.

3.2. No laps shall be measured.

3.3. The payment for ridges and hips shall be made in a similar way as in case of C.G.I, sheet roofing.

3.4. The rate shall be for a unit of one running meter.

15.8. Providing valleys 900 mm. overall in plain 1.6 mm. thick G.I. Class-3 fixed with 'J' or 'L' hook bolts and nuts galvanized from 'J' or 'L' hook bolts and 8 mm. dia. G.I. limpet and bitumen washers complete.

1.0. Materials

1.1. The G.I. valleys 900 mm. overall in galvanized plain sheet of 1.6 mm. thickness shall be of class-3. The valleys shall be 900 mm. wide overall and flashing shall be 380 mm. wide overall. There shall be bent to the required shape without damage to the sheets in the process of bending.

2.0. Workmanship

2.1. The relevant specifications of item NO. 15.1. shall be followed except that the work shall be carried out for G.I. valleys 900 mm. overall with G.I. sheets 1.6 mm. thickness.

2.2. Wherever the edge of a roof sheeting or valley gutter is turned up against a wall, the edge shall be weather proofed with a flashing. Flashing shall be bent to shape and fixed. Lap over the sheet shall be not less than 150 mm. over the roofing sheets. The end between the flashing sheets shall not less than 225 mm.

2.3. The flashing shall be inserted into brick work or masonry joints to a depth of 50 mm. These joints shall be filled with cement mortar (1:3). The flashing shall be well secured to the masonry. Whenever flashing has to be laid at a slope, it shall be stepped at each course of masonry, the step being out back at angle or not less than 30 degrees to the vertical.

2.4. Valleys shall be bent to shape and shall have end lap projection on either side under C.G.I, sheet not less than 225 mm. Valleys shall be fixed to the roof member below, with same 8 mm. dia. G.I. hook, bolts and nuts and bitumen and G.I. limpet washer which fix the sheets to these members. At least one of the fixing bolts shall pass through the end laps of the valley piece. If necessary extra bolts shall be provided for this purpose.

3.0. Mode of measurements and payment

3.1. The measurements for valley shall be taken for finished work in length along their centre lines.

106

3.2. No laps shall be measured.

3.3. The rate excludes the cost of boarding underneath which shall be paid separately.

3.4. The rate of flashing includes the cost of mortar for fixing in wall and other labour and materials required for it.

3.5. The rate shall be for a unit of one running meter.

15.10.(I) Providing and fixing 150 mm. wide 450 mm. overall semicircular plain, G.I. sheets clas-3 Gutter with iron brakes 40 mm. x 3 mm. size bolts nuts, washers etc. including making necessary connections with rain water pipes : 0.80 mm. thick.

1.0. Materials

1.1. These shall be of plain galvanized sheets Class-3 of 0.80 mm. thickness. The gutter shall be designed to carry the maximum discharge from the roof without flowing over and shall be constructed wherever possible with sunk channel or gutter.

2.0. Workmanship

2.1. The longitudinal edges shall be turned back to the extent of 12 mm. and beaten to form a rounded edge. The ends of the sheets at junctions of pieces shall be hooked into each other and beaten flush to avoid leakages.

2.2. The size of gutters shall be as specified in the item.

2.3. The gutter shall be laid with a minimum fall in 120. Gutter shall be true to line and slope and shall be supported on fixed M.S. Flat iron brackets bent to shape or any other suitable bracket.

3.0. Mode of measurements and payment

3.1. The measurements of gutters shall be taken for finished work in length along their centre lines. No. laps shall be measured.

3.2. The rate gutter shall include the cost of all labour and materials specified above including all specials such as angles, junctions, drop ends or funnel shaped connecting pieces, stop ends etc. flat iron brackets and bolts and nuts required for fixing the latter to the roof members.

3.3. The rate shall be for a unit of one running meter.

15.20.(A)(I) Providing asbestos cement sheets, roofing fixed with G.I. plain and bitumen washers complete excluding cost of purlins, fakers and trusses : 7 mm. thick, corrugated sheet.

1.0. Materials :

1.1. Asbestos cement sheets shall conform to M-24.

2.0. Workmanship

2.1. The maximum spacing of purlins shall be 1.6 meters in case of 7 mm. thick A.C. sheets and 1.4 meters for 6 mm. thick A.C. sheets.

2.2. Laying & fixing of Sheets

The sheets shall be laid on the purlins and other roof members as per cods practice. The top bearing surfaces of all purlins and other roof members shall be in one plane so that the sheets when being fixed shall not be required to be forced down to rest on the purlins. The finished roof shall present uniform slope and the line of corrugation shall be straight and true. The sheets shall be laid with smooth side upwards. Corrugated sheets shall be valid starting at the eaves either from left to right or right to left depending upon the direction of wind. Before actual laying of the sheets is started, the purlins spacing and the size of sheets shall be checked to ensure that the arrangements shall provide the laps required and the specified overhang at the eaves. In case the sheets are laid from right to left, the first sheet shall be laid uncut but the remaining sheets in the bottom row shall have the top left hand corners cut or mitered. The sheets in the second and other immediate rows shall have bottom right hand corner of the first sheet cut. All other sheets except the last sheets shall have both bottom right hand corner of the first sheet cut. All other last sheet shall have only top left hand corner cut. The last of the top row sheets shall have the bottom right hand corner cut with exception of the last sheet which shall be left uncut. If the sheets are laid from left to right, the first sheet shall be laid and cut and the remaining procedure shall be reversed.

2.3. The free overhang of the sheets at the eaves shall not exceed 400 mm. in case of 7 mm. thick sheets and 300 mm. in case of 6 mm. thick sheets.

2.4. The meter described above is necessary to provide snug fit. Where 4 sheets meet at a lap the length of meter shall be 150 mm. and the width of miter shall be equal the width of the side lap. The cutting may be done with ordinary wood-saw at site.

107

2.5. Laps :

The sheets shall be laid with an end lap of 150mm. minimum. In case of roof with a pitch flatter than 1 vertical to 2.1/2 horizontal (Approx. 22) or in the case of very exposed situations appropriate larger Taps may be provided. The sheets shall be laid with side lap of half a corrugation.

2.6. Fixing Accessories : The sheets shall be secured to the purlins and other roof members by means of 8 mm. dia galvanized iron bolts (J) type hook bolts in case of angle iron purlins and 'L' type bolts in case of R.S. joints, precast concrete, or timber purlin, and nuts bearing on galvanized iron washers and bitumen washers. The grip of 'J' or 'L' bolts on the side of purlins shall not be less than 25 mm, Each galvanised iron 'J' or 'L' hook bolts shall have bitumen washer and galvanised iron washer placed over the sheets before the nuts is screwed down from above. On each purlin there shall be one hook bolt on the crown adjacent to the side lap on either side bitumen washer shall be of approved quality. The G.I. flat washer shall be 25 mm. in diameter and 1.60 mm. thick and bitumen washer shall be 35 mm. in dia. and 1.5 mm. thick with hole to suit the required size of fixing accessory. Each nut shall be screwed lightly at first. After a dozen or more sheets are laid, the nuts shall be tightened to ensure a leak proof joint and also nuts tightened only to extent so as to prevent damage to the sheets. The length of the 'J' bolts or crank bolts shall be 75 mm. more than the depth of purlins for single sheet fixing and 90 mm. more where two sheets overlap or where ridges or other accessories are to be fixed. The minimum length of coach screw for timber purlins shall be 110 mm.

2.7. Holes :

The holes for fixing the sheet shall be drilled in the centre of end lap to sheets to suit the purlins i.e. on the centre line of the purline, if these are of timber and square head coach screws are used, or as close as possible to the back of purlins if 'J' or 'L' bolts are used as with steel angles or precast concrete or timber purlins. Holes for hook bolts etc. shall be 2 mm. more than diameter of the fixing bolts. No holes shall be nearer than 40 mm. to any edge of sheet or accessory.

3.0. Mode of measurement & payment

3.1. The relevant specifications of item 15.1 shall be followed, except that the over lap of the corrugated sheets over valley gutters, roof lights, caves, filler piece and underlay of the corrugated sheets below ridges, hips north light curves, flashing pieces, roof light sheets and large board shall be included in the measurement. No deduction shall be made for holes cut for extractor or cowl type ventilators. Deductions shall be made for roof light sheets.

3.2. The rate shall be for a unit of one sq. meter.

15.20.(A)(II) Providing asbestos cement sheets roofing fixed with G.I. plain and bitumen washers complete excluding the cost of purlins, rafters and trusses: 6 mm. thick corrugated sheets.

1.0. Materials and Workmanship

The relevant specifications of item No. 15.20 (A)(I) shall be followed except that the thickness of A.C. sheets shall be 6 mm.

2.0. Mode of measurements and payment

2.1. The relevant specifications of item No. 15.20 (A)(I) shall be followed.

2.2. The rate shall be for a unit of one sq. meter.

15.25.(D) Providing and fixing ridges and hips in asbestos cement sheets roofing with G.I. 'J' or 'L' hook, bolts and nuts 8 mm. dia. G.I. plain and bitumen washers complete. North tight adjustable ridges.

1.0. Materials

1.1. The ridges and hips of Asbestos cement sheets roofing shall conform to M-24.

2.0. Workmanship

2.1. The relevant specifications of item 15.20 (A) (I) shall be followed except that the work is to be carried out for ridges and hips in A.C. sheet roofing.

2.2. The ridges shall be laid as per manufacturer's instructions with rolls of the two wings in case of adjustable ridges, fitting closely and with a separation of serrated ridges registering correctly with the sheet underneath. The staggered lapping of two wings of adjustable ridge section and the lap between the adjustment pieces on the same

wing of ridges shall be as per manufacturer's instructions. The end portion of the wing of the adjustable ridges which project beyond the verges of the roof shall be cut and trimmed off neatly.

108

2.3. Hips :

In laying hip pieces, serrations to suit the corrugations in the sheets below should be cut in them so that they shall be snug fit over the sheets. The wings of ridges shall be fixed to the sheet below with seam bolts and nuts 8 mm. dia. G.I. 'J' or 'L' hook bolts and bitumen and G.I. washers which fix the sheets to the purlins. In addition, in north light adjustable ridges, the roll of the two wings shall be jointed together at their crown, with 8 mm. dia G.I. seam bolts and nuts at the rate of two numbers per pair wings. Each seam bolt shall be provided with one bitumen and a pair of G.I. washers. Where the plain wing angular or plain C.C. (1.2:4) up to a full length of the overlaps. The exposed face shall be finished perpendicular to the sheeting. Wings of hips shall be fixed to the roof members below with the same 8 mm. dia. G.I. 'J' or 'L' bolts end nuts which fix the sheets to the member. In addition, they shall be secured to the sheet below with 8 mm. dia G.I. seam bolts, nuts and washers so that taken together with hook bolts, there shall be bolt on each wing at least at every fifth Corrugation of the sheets below in case of corrugated and at least every second corrugation of the sheet below in case of semi corrugated sheets. Each seam bolt shall be provided with one bitumen and pair of G.I. washers.

3.0. Mode of measurements & payment

3.1. Measurements of ridges, hips and other accessories shall be for finished work and the length shall be taken along the centre line. The lap shall not be measured. The under lap of ridges under expansion joint pieces shall be measured.

3.2. The rate of ridges and hips shall not include the cost of expansion joint pieces, closing of gap, between plain ridge and the sheet corrugation with concrete.

3.3. The rate shall be for a unit of one running meter.

15.26. Filling cement concrete 1:2:4 (1 cement : 2 coarse sand : 4 graded stone aggregate 12.5 mm.

nominal size) in gaps of A.C. sheet corrugation and wing of ridges.

1.0. Materials

Water shall conform to M-1. Cement shall conform to M-3. Coarse sand shall conform to M-6. Stone grit shall conform to M-8.

2.0. Workmanship

2.1. The relevant specifications of item No. 5.4.1 of C.C. shall be followed except that the work shall be for filling gaps of A.C. sheet corrugation and wings of ridges.

3.0. Mode of measurements & payment

3.1. The measurements of filling gaps in ridges, hips of A.C. sheet corrugation and wings of ridges shall be for finished work. The length shall be measured along the centre line.

3.2. The rate shall be for a unit of one running meter.

15.27 (II) Providing and fixing asbestos cement roofing accessories with galvanised iron 'J' or 'L'

hook bolts and nuts, G.I. plain and bitumen washer etc. complete : North light and ventilator curves.

1.0. Materials and Workmanship

1.1. The relevant specifications of item No. 15.10 (I) shall be followed except that the work is carried out for accessories for asbestos cement roofing north light and ventilator curves.

1.2. The accessories such as north light and ventilator curves shall be laid and secured with same G.I. hook bolt to secure the sheets to the roof, or with separate G.I. hook bolts to the roof members below and/ or with 8 mm. dia. G.I. bolts nuts and washers to the sheeting, generally as per manufacturer's written instructions.

2.0. Mode of measurements & payment

2.1. The relevant specifications of item No. 15.25 (D) shall be followed.

2.2. The rate shall be for a unit of one running meter.

15.29.(I) Providing and fixing asbestos cement socketed half eaves gutter with bolts, nuts, bitumen washer etc. and flat iron brackets 40' mm. x 3 mm. size including asbestos rope and plastic roofing compound in joints complete : 150 mm. nominal size.

1.0. Materials & Workmanship

1.1. The relevant specifications of item No. 15.10(f) shall be followed except that the asbestos cement socketed half round eaves gutter shall be provided. The size of gutter shall be 150 mm. nominal.

109

1.2. Gutters shall be laid with a minimum fall of 1 in 120 which should be increased where possible. Gutters shall be true to line and slope and shall be laid with requisite accessories such as drop ends, stop ends, nozzles, m angles and union slips, as directed. The size of outlet of drop ends and nozzles shall be the same as the size of rain water pipe into which they discharge water. Gutters and their accessories shall be supported by m.s. flat/ iron bracket. Where these are required to be fixed to the side of rafter they shall be fixed with 40 mm. by 3 mm. section bent to shape and fixed rigidly to the sides of the rafter with 3 Nos. of 10 mm. dia. bolts, nuts and washers. The brackets shall overlap the rafter not less than 300 mm. and connecting bolts be 115 mm. centers.

1.3. Where the brackets are to be fixed with purlins, these shall consist of 40 x 3 mm. M.S. flat iron bent to shape with one/and turned at a right angle and fixed to the purlins face with a 10 mm. dia bolt, nut and washer. The perpendicular overhang portion of 40 mm. x 3 mm. bracket shall be stiffened by another 40 x 3 mm. flat bent to right angle shape with its longer leg connected to the bracket with two numbers of 6 mm. dia. M.S. Bolts nuts and washers and its shorter legs fixed to the face of purlins with one number 10 mm. dia bolt nuts and washers. The overhang of the vertical portion of the flat iron bracket from the face of the purlin shall not exceed 225 mm.

1.4. Requisite slope in the gutter shall be given in the line of bracket. The brackets shall be placed at not more than 900 mm. centers.

1.5. The gutters shall be fixed to the brackets with 2 Nos. 8 mm. G.I. seam bolts and nuts, each bolt and nut being equipped with a pair of bitumen and G.I. washers. These connection bolts shall normally be above the water line of the gutter..

1.6. Spigot and socket end of gutters of socketed half round gutter and their accessories shall be connected together at their laps with one row of 8 mm. dia. G.I. bolts and nuts. Each of the bolts and nuts shall be provided with a pair of bitumen and a pair of G.I. washers. The gap between socket and spigot shall be packed with approved plastic roofing compound and flanked on the both sides with 6.35 mm. dia asbestos rope. The connecting G.I. Bolt shall be then tightened so that the lapped joint becomes leak-proof. The outer face of packed asbestos rope shall not be further than 6 mm. from the edges of the spigot and socketed ends. Where both ends of gutters and / or their accessories to be connected together are spigot ends, they shall be laid as butt jointed with 1.5 mm. gap in between over union clips. The union clips connected to the two butt ends of the gutter or other sections with two rows. The gap between union clips and ends of gutter sections or accessories shall be packed with plastic roofing compound flanked with edges of 6.35 mm. dia asbestos ropes as before. The whole joint shall be made leak-proof by tightening the bolts.

2.0. Mode of measurements & payment

2.1. The asbestos socketed half round eaves gutter shall be measured for finished work and the length shall be measured along the centre line. -

2.2. The rate of gutters shall include the cost of providing and fixing accessories such as drops ends, stop ends, nozzles, and fixing union clips together with bolts, nuts and washers.

2.3. The rate shall be for a unit of one running meter.

15.29.(I) Providing and fixing Asbestos cement socketed half round eaves gutters with bolts, nuts, bitumen washers etc. and flat iron brackets 40 mm x 3 mm. size including Asbestos rope and plastic roofing compound in joint etc. complete. 300 mm. nominal size.

1.0. Materials & Workmanship

1.1. The relevant specifications of item No. 15.29 (I) shall be followed except that the size of the Asbestos socketed eaves half round gutter shall be 300 mm. nominal size.

2.0. Mode of measurements & payment

2.1. The relevant specifications of item No. 15.29(1) shall be followed.

2.2. The rate shall be for a unit of one running meter.

15.51. Tiled roofing with Mangalore pattern roof tiles including teak reefers of size 50 mm. x 25 mm.

1.0. Materials

(1) Mangalore pattern roof tiles shall conform to M-25, (2) Teak wood batten shall conform to M-29.

2.0. Workmanship

2.1. Laying

The maximum distance between centre to centre of rafters shall be not more than 500 mm. Teak wood reapers 50 mm. x 25 mm. be nailed to each rafter at central distances suited to the size of the tiles by

110 means of nails 50 mm. long. The reapers shall be of well seasoned teak wood and shall be straight pieces of uniform size and colour and not shorter than the length necessary to cover at least four rafter. The under face and sides of the reapers shall be planned before fitting up. Joints shall come over the rafter. The joints of two adjacent rows of reapers shall not come over the same rafter. At the eaves, there shall be two reapers of such thickness and shape that the uniformity of the top slope of the roof shall be preserved.

2.2. The work of valleys shall be executed as under :

Galvanized iron sheet 1200 mm. wide and 1.25 mm. thick shall be used for valleys. The sheet shall be extended by about 450 mm. under the tiles on either side in a depth of 100 mm. at centre. The sheet shall be carried 75 mm. into the wall and set with cement mortar unless flushing is specified. The laps, if any, on the slope shall be 300 mm. The sheets shall be laid over the reapers and nailed. Two reapers 50 mm x 25 mm. each shall be fixed over the galvanized iron sheet 150 mm. away from the centre line of the valley, on either side to keep the tiles and mortar from falling into the gutter of the valley.

2.3. Laying :

The tiles shall be laid from the eaves towards the fudges after fitting of the reapers, the rebate of the tiles resting fully against the reapers. The joints of the hips and ridges tiles and also those between them and the plain tiles shall be set in and well grouted with lime mortar and the mortar surface painted and finished off with a mixture of red paint and port land cement or preserve informality of colour. The finished slope of roof shall be uniform from ridges to eaves. The eaves line shall be perfectly straight, horizontal and parallel to each other. The end over gales shall be protected by lime borders and neatly finished.

2.4. At the side of valleys and for 230 mm. on either side of the roof at valleys cement plastering 12 mm. thick shall be done to prevent the rain water from the gutter leaking by the sides of valleys.

2.5. At the eaves, wide tie shall be placed over the ends of the last tiles and secured by means of galvanized iron washers and screws 25 mm. into the rafter to prevent tiles from being blow up. Care shall be taken to put the screws in the, ridges and not in the gutter or the tiles, Where full tiles are not necessary, half tiles manufactured for the purpose shall be used.

3.0. Mode of measurements and payment

3.1. The measurement of the roof shall be taken for finished work for superficial area flat in the plane, of the roof

and not girthed. Laps shall not be measured.

3.2. No deduction in measurements of roofed shall be made for openings of area up to 0.40 sq. mt. nor shall any extra be paid for labour and wastage in forming such openings.

3.3. The rate includes the cost of all materials and labour including ridges, hips, eaves and bottoms.

3.4. The rate shall be for a unit of one square meter.

15.75 Providing and fixing five courses water proofing treatment with bitumen felt consisting/ of second and fourth course of blown bitumen or/and residual bitumen applied hot 1.20 kg./sq. mt. of area for each course and first course with fiber base bitumen saturated underlay type and third course with fiber base self finished felt type 2 Grade-I, fifth and final course of stone grit 6 mm. and down size or pea sized gravel spreaded at 0.008 cum/sq.mt. including preparation of surface, excluding grading complete.

1.0. Materials

The tar felt shall conform to M-76. The bitumen primer shall conform to I.S. 3388-1965. The bitumen shall conform to I.S. 702-1961. The grit or gravel shall conform to M-8.

2.0. Workmanship

2.1. Preparation of surface :

2.1.1. Well defined cracks other than hair cracks in the roof structure shall be cut to V section cleaned and filled up flush with cement sand slurry or with bitumen conforming to I.S. 702-1961. The surface to be treated shall have minimum slope of 1 in 120. The grading shall be carried out prior to the application of water proofing treatment by cement mortar or line surkhi mortar or as specified in description of item.

2.1.2. The surface or room, part of parapet and gutters, drain mouths etc. over which the water proofing treatment is to be applied shall be cleaned or all foreign matter such as funguses, moss and dust by wire brushing and dusting.

2.1.3. Drain outlet shall suitably placed with respect to the roof gradient to ensure rapid drainage and prevent local accumulation of water on the roof, surface, masonry drain mouth shall be widen sufficiently and rounded with cement mortar.

2.1.4. For cast iron drain outlets, a groove shall be cut all round to touch the treatment.

111

2.1.5. When a pipe passes through a roof on which water proofing treatment is to be laid a cement concrete angle fillet shall be built round it and the water proofing treatment taken over the fillet.

2.1.6. In case of parapet wall over 450 mm. in height for trucking in the water proofing treatment a horizontal groove 75 mm. wide and 65 mm. deep at minimum height of 150 mm. above roof level shall be left in the vertical face at the time of construction. The horizontal face of the groove shall be shaped with cement mortar 1:4.

2.1.7. In case of low parapet where the height does not exceed 450 mm. no groove shall be provided and the water proofing treatment shall be carried right over the top.

2.1.8. In case of existing R.C.C. and stone and vertical face of the parapet wall, a fillet 75 mm. in radius shall be constructed.

2.1.10. At the drain mouths the fillet shall be suitably cut back and rounded off for easy application of water proofing treatment and easy flow of water.

2.1.11. Outlet at every low dividing wall about less than 300 mm. in height cut open to full depth and the bottom and the sides shall be rounded smooth and corners rounded off for easy application of water proofing treatment.

2.2. Priming coat:

2.2.1. Bitumen primer shall conform to I.S. 3335-1965. A priming coat consisting of bituminous solution of low viscosity shall be applied with brush on the roof and wall surface at specified weight per unit area to assist adhesion to bonding materials as specified in the description of the item..

2.2.2. Where a floating treatment to water proofing with self finished bitumen felt is required i.e. where water proofing treatment is required to be isolated from the roof structure, a layer of bitumen saturated felt (under lay) shall be spread over the roof surface and tucked into the flashing grooves. To keep the underlay free from the structure nonbonding materials shall be used below underlay. Overlapping to the adjoining strip of underlay shall be minimum of 75 mm. as sides and 10 mm. at ends, and shall be sealed with the same bonding materials, m as used for self finished felt treatment. The underlay shall be of type I saturated felt conforming to I.S. 1322-1970.

2.3. Laying of Felt :

2.3.1. The self finished tar felt shall be cut to the required lengths, brushed clean to dusting materials, laid out flat on the roof to eliminate curls and subsequent sketching. The felt shall be laid in lengths running at right angles to the direction of run off gradient commencing at the lowest level and working up to crest, so that the lower laps of the adjacent felt layer offer minimum obstruction to the flow of water. The felt shall not be laid in a single piece of very long lengths as it is likely to shrink. 6 to 8 meters are suitable length. The roof shall be cleaned and dried before the felt treatment is begun. Each length shall be laid in position and rolled up for a distance of half its lengths. The hot bonding materials heated to correct working temperature as specified by manufacturer shall be poured on the roof across the full width of the felt as the letter is steadily unfolded and pressed down. The excess of bonding materials which squeezes out at the ends shall be removed as the laying proceeds. The pouring shall be so regulated that the correct weight of the bonding materials as per unit area is spread uniformly over the surface. When the first half of the tar felt has been bonded to the roof, the other half shall be rolled up and then unrolled on the hot bonding materials in the same way. Subsequent strips shall also be laid in the same manner. Each strip shall overlap the proceeding one by at least 75 mm. at the longitudinal edges and 100 mm. at the ends. All overlaps shall be firmly bonded with hot bitumen. Streaks and trailing of bitumen near edges or laps shall be leveled by heating the overlaps with blow lamp and leveling down unevenness.

2.3.2. Third layer of bonding materials in four course treatment shall be carried out in similar out in manner after the flashing has been complete.

2.3.3. Water proofing treatment shall be carried out in the drain pipe or out-lets by at least 100 mm. The Water proofing treatment laid on the surface shall over-lap the upper edge of water proofing treatment in the drain outlets by latest 100 mm. Flashing felts shall be laid as flashing. Wherever junction of vertical horizontal surfaces occurs longitudinal laps shall be 100 mm. The lower layer of flashing felt shall overlap the roofing felt by 100 mm on vertical and sloping faces. Last course of flashing should not be of stone grit or pea sized gravel but it shall be replaced by providing two coats of bitumen solution of approved quality.

112

2.3.4. The lower edge of flashing shall overlap the flat portion for the roof and the upper edge of the flashing shall be trucked into the horizontal groove 75 mm. thick wide, 65 mm. deep provided at minimum height of 150 mm. from top of the roof surface. The flashing treatment shall be firmly held in place in the grooves with wooden wedges at intervals and the grooves shall be filled with cement mortar 1:4 (1 cement : 4 coarse sand) or cement concrete (1:2:4) (1 cement : 2 coarse sand : 4 graded stone aggregate 6 mm. nominal size) and surface finished smooth with the rest of wall. The cement work shall be cured of bituminous solution shall be applied on the vertical and sloping surface of flashing.

2.3.5. After the top flashing felt layer has been laid, the penultimate layer of bonding material shall be applied over the roofing felt and horizontal overlap, and vertical and sloping surfaces of flashing shall be spread uniformly over the hot bonding materials on the horizontal roof surface and pressed into it with wooden roller.

2.3.6. The material for surface finish shall be spread as described in the item over top layer.

2.3.7. If ballooning occurs the defects may be rectified as under.

2.3.8. Remove the gravel on the ballooned surface. The cut open and squeeze out the trap vapor by firm pressure applied by hand, seal the bitumen felt so lifted back on the surface by applying additional bitumen, finally seal the cut with piece of bitumen felt with bitumen application.

3.0. Mode of measurements & payment

3.1. The measurements for this item shall be taken as under:

(a) Water proofing of roof with bitumen shall be measured in sq. mt. length and breadth shall be measured correct to centimeter.

(b) Measurement shall be taken for the superficial area of roofing and flashing treatment including flashing over the parapet wall, low dividing walls and expansion joints and at the pipe projection etc. Overlapping and tucking into flashing grooves shall not be measured.

(c) Slopping and vertical surface of water proofing treatment shall be measured under the four or five course treatment as the case may be irrespective of the fact that the final course of grit or grave! is replaced by bitumen primer.

(d) In measurements, no deductions shall be made for either openings or recesses for chimney stacks, roof lights etc. for areas up to 0.40 sq. mt. not anything extra shall be paid for extra labour and materials in forming such openings. For similar area exceeding 0.04 sq. mt. deduction shall be made in measurements for full opening but nothing extra shall be paid for extra labour and materials in forming such openings.

(e) The grading (coba bedding) shall be paid separately but cleaning of surface and treatment shall not be measured or paid separately.

3.2. The rate includes cost of all materials and labour.

3.3. The rate shall be for a unit of one sq. meter.

15.87(A) Providing and fixing on wall face C.I rain water pipe including filling the joints with spun yarn soaked in neat cement slurry and cement mortar 1:2 (1 cement : 2 fine sand) 75 mm. dia.

1.0. Materials

Water shall conform to M-1. The C.I. rain water pipes and fittings shall conform to M-68. Cement mortar shall conform to M-11.

2.0. Workmanship

2.1. C.I. rain water pipes shall be of the specified diameter and shall be in full lengths of 1.8 meters including socket ends of the pipes unless shorter lengths are required at junction with fittings.

2.2. Fixing :

The pipe and fittings shall be fixed in vertical alignment unless otherwise specified and shall be secured to the walls at joints with M.S. clamps. The clamps shall be M.S. sheet 30 mm. bent to required shape and size so as to fit tightly on the socket of pipe when tightened with screw bolts. It shall be formed out of two semi-circular pieces, hinged with 6 mm. dia M.S. pin on one side and provided flanged ends on the other side with holes to fit in the screw bolt and nut 40 mm. long. The clamps shall be provided with hook made out of 275 mm. long, 10 mm. dia M.S. bar invested to the ring at the centre of one semicircular piece. The clamps shall be fixed to the walls. The clamps shall be kept above 25 mm. clear of finished face of wall so as to facilitate cleaning and painting the pipes.

113

2.3. The pipe shall be fixed vertically. The spigot of the upper pipe shall be properly fitted in the socket of the lower pipe such that there is uniform annular space filling with the jointing material. The annular space between the spigot and socket shall be filled with, a few turns of spun yam soaked in cement slurry or with stiff cement mortar 2:1 (1 cement : 2 fine sand) well pressed with caulking tools and finished smooth at top at an angle of 45°, shopping up. The joint shall be kept we at least for 7 days by tying four fold of gunny bag to pipe and keeping it moist constantly.

3.0. Mode of measurements & payment

3.1. The relevant specifications of item No. 15.93(B) of A.C. rain water pipes shall be followed except that the C.I. rain water pipe shall be fixed.

3.2. The rate shall be for a unit of one running meter.

15.88.(A) Providing and fixing M.S. Holder bat clamps of approved design to C.I. or S.C.I. pipes embedded and including cement concrete blocks (108 mm. x 100 mm. size) in 1:2:4 (1 cement : 2 coarse sand : 4 graded stone aggregate 20 mm. nominal size) and cost of cutting holes and making good the wall etc. complete : 75 mm. dia.

1.0. Materials of Workmanship

1.1. The relevant specifications of item no. 15.94(6) shall be followed except that the M.S. holder bat clamps of approved design shall be C.I. rain water pipe-75 dia.

1.2. The bat clamps shall be fixed as directed with C.C. blocks of 100 mm. x 100 mm. The relevant specification of item No. 5.4.1 shall be followed for concrete work.

2.0. Mode of measurements and payment

2.1. The bat clamps of M.S. holder suitable for 75 mm. dia shall be measured for finished item.

2.2. The rate includes cost of all materials and labour etc. required for satisfactory completion of this item.

2.3. The rate shall be for a unit of one number.

15.90(A) Providing and fixing and embedding sand C.I. rain water pipe in the mason surrounded with 12 mm. thick cement mortar of the same mix as that of masonry : 75 mm. dia. pipe.

1.0. Materials

Water shall conform to M-1. Cement mortar shall conform to M-11. The C.I. pipe and fittings shall conform to M-68.

2.0. Workmanship

2.1. The relevant specifications of item No. 15.87 (A) shall be followed except that C.I. pipe 75 mm. dia shall be embedded in masonry surrounded with 12 mm. thick cement mortar.

2.2. The pipes shall be fixed in the masonry work as it proceeds. The pipe shall be kept vertical or to the line as directed. The pipe shall have minimum surroundings of 12 mm. thick cement mortar at every portion of external surface. The length shall be caulked with spun yarn and cement mortar as soon as the next length of pipe is placed in position. The socket end of the pipe shall be kept closed till the next length of pipe is fitted and jointed to prevent any brick-bats or concrete or pieces of wood falling in and cocking the pipes.

3.0. Mode of measurements and payment

3.1. The relevant specifications of item No. 15.87 (A) shall be followed.

3.2. The rate shall be for a unit of one running meter.

15.93(6) Providing and fixing on wall face asbestos cement rain water pipe including jointing with spun yarn soaked in bitumen and cement mortar 1:2 (1 cement : 2 coarse sand) complete : 80 mm. dia.

1.0. Materials

1.1. Asbestos cement pipes of 80 mm. dia shall conform to I.S. 1626-1960 for pipes fixed on wall face. AC. pipe shall conform to M-74.

2.0. Workmanship

2.1. Asbestos cement rain water pipes and fittings shall be of the diameter, size and type specified in the item. The pipe shall be full lengths of 2 meter as far as possible. All the pipes shall be fixed on wall face at locations indicated on drawings or as ordered by the Engineer-in-charge. Pipe shall be secured to face of wall below all joints by M.S. clamps with wooden gut ties.

2.2. The spigot of the upper pipe shall be properly fitted into the socket of the lower pipe such that there is uniform annular space for fitting with the jointing materials. One third depth of annular space between the

114
item. The pipe shall be full lengths of 2 meter as far as possible. All the pipes shall be fixed on wall face at locations indicated on drawings or as ordered by the Engineer-in-charge. Pipe shall be secured to face of wall below all joints by M.S. clamps with wooden gut ties.

2.2. The spigot of the upper pipe shall be properly fitted into the socket of the lower pipe such that there is uniform annular space for fitting with the jointing materials. One third depth of annular space between the socket and the spigot shall be filled with spun-yarn soaked in bitumatic jointing compound and shall be pressed home by means of caulking tool. The remaining 2/3 depth of the joints shall be filled in with stiff cement mortar 1:2 and shall be pressed with caulking tool and finished smooth at top at an angle of 45 sloping up.

3.0. Mode of measurements and payment

3.1. The pipe shall be measured including all fittings along its length in running meter. No allowance shall be made for the portion of pipe length entering the sockets of the adjacent pipe or fittings.

3.2. The rate includes the cost of all materials and labour involved in all the operations including jointing.

3.3. The rate shall be for a unit of one running meter.

15.93.(C) Providing and fixing on wall face asbestos cement rain water pipe including jointing with spun yarn soaked in bitumen and cement mortar 1:2 (1 cement : 2 coarse sand) complete : 100 mm. dia.

1.0. Materials and Workmanship

1.1. The relevant specifications of item No. 15.93 (B) shall be followed except that the diameter of pipes shall be 100 mm.

2.0. Mode of measurements & payment

2.1. The pipe shall be measured including all fittings along its length in running meter. No allowance shall be

made for the portion of pipe length entered into the sockets of the adjacent pipe or fittings.

2.2. The rate includes the cost of all materials and labour involved in all the operations including jointing.

2.3. The rate shall be for a unit of one running meter.

15.94.(B) Providing and fixing for A.C. pipe on wall plugs and standard holder bat clamps comprising of two semi circular halves of flat iron and cast iron base screwed on wooden plugs : 80 mm. dia.

1.0. Materials and workmanship

1.1. The bat clamps shall consist of a iron base with a projecting 1 shaped lay, teeth web of which the semicircular halves of the flat iron clamps are bolted. The base on the holder bat clamp shall be screwed on a pair of wooden plugs fixed in the wall with screw slotted driven through the holes in the base. The ' screws shall be not less than 75 mm. long-for 80 mm. diameter pipes and 100 mm. diameter pipes. The plugs shall be fixed in the wall to a depth of 150 mm. in cement mortar, 1:2 centrally to the holes in the base of the bat clamps and with their front face projecting to such a length' from the brick face that when the bat clamps is fixed, the outer base of its base shall be flush with the plaster face of the wall. The plugs shall be 110 mm. x 50 mm. wide at face increasing to 160 mm. x 70 mm. width at rear and shall be 70 mm. deep through out.

2.0. Mode of measurement & payment

2.1. The work shall be measured on number basis of clamps prescribed with accessories including cost of all materials and labour involved in all the operation including jointing etc. complete fixing in position etc. complete.

2.2. The rate shall be for a unit of one number.

15.94 (C) Providing and fixing for A.C. pipe on wall plugs and standard holder bat clamps comprising of two semi circular halves of flat iron and cast iron base screwed on wooden plugs : 100 mm. dia.

1.0. Materials and workmanship

1.1. The relevant specifications of item No. 15.94 (B) shall be followed except that the standard holder bat clamps shall be for A.C. pipe of 100 mm. dia.

2.0. Mode of measurements and payment

2.1. The work shall be measured on number basis of clamps including cost of all materials and labour involved in all the operation including jointing, fixing in position etc. complete.

2.2. The rate shall be for a unit of One Number.

15.95.(A) Providing and fixing on wall face asbestos cement fittings for rain water pipe including jointing with spun yarn socked in bitumen and cement mortar 1:2 {1 cement : 2 coarse sand). Bend of required degree. 80 mm. dia without door. 100 mm. dia. without door.

115

1.0. Materials

1.1. The bend of required degree and size as specified in item shall be of best quality and made as approved by the Engineer-in-charge. The fittings shall conform to I.S, 1626-1960.

2.0. Workmanship

2.1. The fitting (bend of required degree) shall be fixed as per relevant specifications of item No. 15.93 (B), except that the A.C. bends of required degree shall be provided instead of pipe.

3.0. Mode of measurements and payment.

3.1. The rate shall be for a unit of One Number.

15.95.(B) Providing and fixing on wall face asbestos cement fittings for rain water pipe including jointing with spun yarn soaked in bitumen and cement mortar 1:2 (1 cement : 2 coarse sand) off set 50 mm. (2) 80 mm. dia. (3) 100 mm. dia.

1.0. Materials & Workmanship

1.1. The relevant specification of item No. 15.95 (A) shall be followed except the off set 50 mm. of specified size of A.C. pipe shall be used instead of bends.

2.0. Mode of measurements & payment

2.1. The rate shall be for a unit of One Number

15.95.(C) Providing and fixing on wall face asbestos cement fittings for rain water pipe including jointing with spun yarn soaked in bitumen and cement mortar 1:2 (1 cement : 2 coarse sand) off set 75 mm. (2) 80 mm. dia (3) 100 mm. dia.

1.0. Materials & Workmanship

1.1. The relevant specifications of item No. 15.95 (A) shall be followed except that off-set 75 mm. of specified size of A.C. Pipe shall be provided instead of bends.

2.0. Mode of measurements & payment

2.1. The rate shall be for a unit of One Number.

15.95.(J) Providing and fixing on wall face Asbestos cement fittings for rain water pipe including jointing with spun yarn soaked in bitumen and cement mortar 1:2 (1 cement : 2 coarse sand) junction equal angle. (3) 80 mm. dia without door (5) 100 mm. dia. without-door.

1.0. Materials and workmanship

The relevant specifications of item 15.95 (A) shall be followed that junction of equal of angle of specified size of A.C. pipe shall be provided instead of bends.

2.0. Mode of measurements & payment

2.1. The rate shall be for a unit of One Number.

15.95.(K) Providing and fixing on wall face Asbestos cement fittings for rain water pipe including jointing with spun yarn soaked in bitumen and cement mortar 1:2 (1 cement : 2 coarse

sand) : junction of equal double angle. (3) 80 mm. dia. without door (5) 100 mm. dia. without door.

1.0. Materials and workmanship

1.1. The relevant specification of item 15.95 (A) shall be followed except that junction of equal double angles of A.C. rain water pipe of specified size shall be provided instead of A.C. Bend.

2.0. Mode of measurement & payment

2.1. The rate shall be for a unit of One Number.

15.95.(L) Providing and fixing on wall face Asbestos cement fittings for rain water pipe including jointing with spun yarn soaked in bitumen and cement mortar 1:2 (1 cement : 2 coarse sand) : Standard shoe. (2) 80 mm. dia. (3) 100 mm. dia.

1.0. Materials and workmanship

1.1. The relevant specification of item No. 15.95 (A) shall be followed except that the standard shoe of A.C. pipe of specified size shall be provided instead of bend.

2.0. Mode of measurement & payment

2.1. The rate shall be for a unit of One number.

116

SECTION-16

Ceiling Lining

16.3.(A) Providing and fixing wooden planks ceiling with long Lied and grooved jointing and Wood screws (Frame work and cover fillets to be measured and paid separately) : Indian Teak Wood (i) 12 mm. thick (ii) 20 mm. thick (iii) 25 mm. thick.

1.0. Materials

1.1. The Indian Teak wood shall conform to M-29.

2.0. Workmanship

2.1. General

The planks shall be clean sawn in the direction of the grain, cut square and straight. Each plank shall have tongued and grooved jointing. On exposed faces, it shall be planed for full face.

2.2. The frame for supporting the ceiling may be wooden or metal and the size and the other details of frame work shall be as directed, Suspenders of M.S. angles or other sections may be used for suspending the frame. Use of wooden suspenders shall be permitted. The bottom surface of the frame shall be checked and corrected to true surface and slope.

2.3. Fixing :

Planks of a specified timber and thickness shall be used. The width of the planks shall not be more than 100 mm. up to 20 mm. thick planks and 150 mm. for planks above 20 mm. thick and length shall not exceed 3 meters. The planks shall be of uniform width except in the first and last lines of planks adjacent to the two walls where remaining additional odd width shall be adjusted equally on both sides. The minimum, length of planks in finished work shall be such that it will span at least two spacing of the supporting frame work except where shorten lengths are unavoidable. The planks shall be planed true on the exposed sides.

2.4. The longitudinal edges of the planks shall be jointed with tongued and grooved type joints as described in the item.

2.5. The outer lines of planks shall be accurately fixed parallel and close to be wall. Each subsequent plank shall be carefully jointed up. The plank shall be fixed to the frame above with two screws at each and joints of frame and one at every intermediate joint. (The screws shall not be thinner than designations 8 and of a length not less than twice the thickness of the boards). The screws shall be counter sunk and the screw holes filled with putty or-sloping out way. The unexposed face of planks shall be treated with wood preservative before the board is fixed.

3.0. Mode of measurement & payment

3.1. The supporting frame, cover fillets, and suspenders shall not be included in rate of ceiling.

3.2. No deductions in measurements shall be made for opening not exceeding 0.46 sq. m. and no extra payment shall be made for forming such openings.

3.3. Each type of work in ceiling shall be measured separately.

3.4. The rate shall be for a unit of One sq. meter.

16.4. Providing and fixing Fiber insulation board lining with butt jointing and nails (Frame work and cover fillets to be measured and paid separately) (i) 12 mm. thick (ii) 18 mm. thick (iii) 25 mm. thick.

1.0. Materials

1.1. The fiber insulation board of specified thickness shall conform to I.S. 3348-1965.

2.1. Fixing :

The work shall be carried out as per detailed drawings for panel arrangements.

2.2. All boards are subject to slight movements due to moisture and temperature changes, and this shall be allowed for in fixing. Preferably the board shall be stored up for at least 24 hours before use in the same environment as the one in which they are to be fixed.

117

2.3. Frame work :

The studs and grounds for fixing the boards shall be spaced at 300 mm. to 450 mm. centers both ways the actual spacing selected depending on the width of the cut board in the panel arrangements. All edges of the boards shall be supported. Intermediate supports shall be provided at dado heights for picture rails and cornices etc.

2.4. Planked battens 40 mm. x 20 mm. shall toe used for grounds on solid walls. The batten shall be plugged to

wall as described-under. The batten shall be fixed on tapering plugs with 50 mm. long wood screws. The tapering plug shall be trapezoidal in shape having base 50 x 50 mm. at bottom 38 x 38 mm. at top with depth of 50 mm. Plugs shall be embedded in C.M. 1 : 3 and shall be placed at 450 x 500 mm. centers. The plugs shall be treated with coal tar and battens shall be treated with wood preservative before use. On uneven wall faces the battens shall be plugged and fitted with packing pieces at the back where necessary. The frame shall be treated with wood preservative before boards are nailed on.

Nailing shall be done by nails having a shank diameter of 2.5 mm. and head diameter of about 8 mm. Nails shall have length as per requirements. The nails shall be placed at supports at 100 mm. to 150 mm centre to centre and at edges 75 mm. centers. Minimum clearance for nails from edges shall be 10 mm. The nails shall be rustles where the nail heads are exposed. Where the joints are to be covered with beading, felt headed (clout) nails shall be used instead of lost head nails.

3.0. Mode of measurements and payment

3.1. The relevant specifications of item No. 16.3.(A) shall be followed.

3.2. The rate shall be for a unit of One sq. meter.

16.13(1) Providing and fixing plywood lining with butt jointing and nails (frame work and cover fillets to be measured and paid for separately) 6 mm. thick ply.

1.0. Materials :

6 mm. thick plywood shall conform to M-37.

2.0. Workmanship

The relevant specifications of item 16.4 shall be followed except that 6 mm. thick plywood shall be fixed in lining.

3.0. Mode of measurements and payment

3.1. The relevant specifications of item 16.4 shall be followed.

3.2. The rate shall be for a unit of One sq. meter,

16.13(11) Providing and fixing plywood lining with butt jointing and nails (frame work and cover fillets to be measured and paid for separately) 9 mm. thick ply.

1.0. Materials & Workmanship

1.1. The relevant specifications of item No. 16.13 (I) shall be followed except that the thickness of plywood to be fixed shall be 9 mm.

2.0. Mode of measurements & payment

2.1. The relevant specifications of item No. 16.4 (I) shall be followed.

2.2. The rate shall be for a unit of One sq. meter.

16.21(1) Providing and fixing plain asbestos sheet lining with butt jointing and wood screws (frame work and cover fillets to be paid for separately), Class-A-6.5 mm. thick.

1.0. Materials

1.1. Plain A.C. Sheets 6.5. mm. thick shall be conform to M-24.

2.0. Workmanship

2.1. The relevant specifications of item No. 16.4. shall be followed except that the plain A.C. sheets class A of 6.5 mm. thickness shall be fixed in lining.

2.2. In fixing asbestos cement sheets, care shall be taken to avoid rigid fixing as this may cause cracking if the supporting structure expands or shrinks. The sheet shall be fixed with wood screws to wooden ground

118

and the screw holes shall be drilled slightly longer than the screws. Asbestos sheet may also be advantageously fixed on to walls with cement plaster backing. The screws shall be fixed at 150 mm. to 200 mm. at supports. The boards shall be fitted either with wooden cover fillets or asbestos strips as described in item.

3.0. Mode of measurement and payment

3.1. The relevant specifications of item No. 16.4 shall be followed.

3.2. The rate shall be for a unit One sq. meter.

18.21 (II) Providing and fixing plain asbestos sheet lining with butt jointing to wood screws (frame work and cover fillets to be paid for separately), Class-B-5 mm. thick.

1.0. Materials & Workmanship

1.1. The relevant specifications of item No. 16.21 (I) shall be followed except that the plain A.C. sheet of Class-B 5 mm. thick shall be fixing in lining.

2.0. Mode of measurements & payment

2.1. The relevant specifications of item No. 16.21 (I) shall be followed.

2.2. The rate shall be for a unit of One sq. meter.

119

SECTION-17

Plastering and Paints

17.58 (I) 10 mm. thick cement plaster in single coat on fair side of brick concrete walls for interior plastering up to floor two level and finished even and smooth in (i) C. M. 1:3.

1.0. Materials

1.1. Water shall conform to M-1. The cement mortar of proportion 1:3 shall conform to M-13.

2.0. Workmanship

2.1. Scaffolding:

Wooden bullies, bamboos, planks, trestles and other scaffolding shall be sound. These shall be properly examined before erection and use. Stage scaffolding shall be provided for ceiling plaster which shall be independent of the

walls.

2.2. Preparation of back-ground :

2.2.1. The surface shall be cleaned of all dust, loose mortar droppings, traces of algae, efflorescence and other foreign matter by water or by brushing. Smooth surface shall be toughened by wire brushing if it is not hard and by hacking if it is hard. In case of concrete surface, if a chemical retarded has been applied to the form work, the surface shall be roughened by wire brushing and all the resulting dust and loose particles cleaned off and care shall be taken that none of the readers if left on the surface. Trimming of projections on brick/concrete surfaces where necessary shall be carried out to get an even surface.

2.2.2. Raking of joints in case of masonry where necessary shall be allowed to dry out for sufficient period before carrying out the plaster work.

2.2.3. The work shall not be soaked but only damped evenly before applying the plaster. If the surface becomes dry, such area shall be moistened again.

2.2.4. For external plaster, the plastering operation shall be started from top floor and carried downwards. For internal plaster, the plastering operations may be started wherever the building frame and cladding work are ready and the temporary supports of the ceiling resting on the wall of the floor have been removed. Ceiling plaster shall be completed before starting plaster to walls.

2.3. Application of plaster:

2.3.1. The plaster about 15x15 cms. shall be first applied horizontally and vertically at not more than 2 meters intervals over the entire surface to serve as gauge. The surfaces of these gauges shall be truly in plane of the finished plastered surface. The mortar shall then be applied in uniform surface slightly more than the specified thickness, then brought to a true surface by working a wooden straight edge reaching across the gauges with small upward and sideways movements at a time. Finally, the surface shall be finished off true with a trowel or wooden float according as a smooth or a smooth or a sandy granular texture is required Excessive troweling or overworking the float shall be avoided. All corners, arises, angles and junctions shall be truly vertical or horizontal as the case may be and shall be carefully finished. Hounding or chamfering, corners, arises junctions etc. shall be carried out with proper templates to be size required.

2.3.2. Cement plaster shall be used within half an hour after addition of water. And mortar or plaster which is partially set shall be rejected and removed forthwith from the site.

2.3.3. In suspending the work at the end of the day, the plaster shall be left out clean to the line both horizontally and vertically, when recommencing the plaster, the edges of the old work shall be scraped clean and wetted with cement putty before plaster is applied to the adjacent areas to enable the two to properly join together. Plastering work shall be closed at the end of the day on the body of the wall and nearer than 15 cm. to any corners or arises. It shall not be closed on the body of features such as plaster bands and cornices not at the corners or arises. Horizontal joints in plaster work shall not also occur on parapet tops and copings as these invariably lead to leakage. No portion of the surface shall be left out initially to be packed up later on.

2.3.4. Each coat shall be kept damp continuously till the next coat is applied or for a minimum period of 7 days. Moistening shall commence as soon as plaster is hardened sufficiently. Soaking of walls shall be avoided and only as much water as can be readily absorbed shall be used, excessive evaporation on the sunny or windward side of building in hot air or dry weather shall be prevented by hanging matting or gunny bags on the outside of the plaster and keeping them wet.

3.0. Mode of measurements & payment

3.1. The rate shall include the cost of all materials, labour and scaffolding etc. involved in the operations described under workmanship.

3.2. All plastering shall be measured in square meters unless otherwise specified. Length breadth or height shall be measured correct to a centimeter.

120

3.3. Thickness of the plaster shall be exclusive of the thickness of the key i.e. grooves or open joints in brick work, stone work etc. or space between laths. Thickness of plaster shall be average thickness with minimum 10 mm. at any point on this surface.

3.4. This item includes plastering up to floor two level.

3.5. The measurement of wall plastering shall be taken between the walls or partition (dimensions before plastering being taken) for length and from the top of floor or skirting to ceiling for height. Depth of cover of cornices if any shall be deducted.

3.6. Soffits of stairs shall be measured as plastering on ceilings, following soffits shall be measured separately.

3.7. For jambs, soffits, sills etc. for openings not exceeding 0.5 sq. met each in area for ends of joints beams, posts, girders, steps etc. not exceeding 0.5 sq. mt each in area and for openings exceeding 0.5. sq. mt and not exceeding 3.00 sq. mt. in each area deductions and additions shall be made in the following manners.

(a) No deductions shall be made for ends of joints, beams, posts etc. and openings not exceeding 0.5 sq. mt each and no addition shall be made for reveals, jambs, soffits, sills etc. of these openings, for finish to plaster around ends of joints, beams posts etc.

(b) Deduction for openings exceeding 0.5 sq. mt but not exceeding 3 sq.mt. each shall be made as follows and no addition shall be made for reveals, jambs, soffits, sills etc. of these openings, (i) When both faces of all wall are plastered with same plaster, deduction shall be made for one face only, (ii) When two faces of wall are plastered with different types of plasters or if one face is plastered and the other pointed, deductions shall be made from the plaster or pointing on the side of frame for door, window etc. on which width of reveals is less than that on the other side but no deductions shall be made on the other side. Where width of reveals on both faces of all are equal, deductions of 50% of area of opening on each face shall be made from areas of plaster and / or pointing as the

case may be.

3.8. For openings having door frames equal to or projecting beyond the thickness of wall, full deduction for opening shall be made from each plastered face of the wall.

3.9. In case of openings of area above 3 sq. mt. each, deduction shall be made for openings but jambs, soffits and sills shall be measured.

3.10. The rate shall be for a unit of One sq. meter.

17.58 (II) 10 mm. cement plaster in single coat on fair side of brick/concrete walls for interior plastering up to floor two level and finished even and smooth in C.M. 1:4.

1.0. Materials & workmanship

1.1. The relevant specifications of item No. 17.58 (I) shall be followed except that the proportion of mortar is C.M. 1 :4 instead of C.M. 1:3.

2.0. Mode of measurements & payment

2.1. The mode of measurements and payment shall be the same as for item No. 17.58 (I)

2.2. The rate shall be for a unit of One sq. meter.

17.58 (III) 10 mm. cement plaster in single coat on fair side of brick/concrete walls for interior plastering up to floor two level and finished even and smooth in C.M. 1:6.

1.0. Materials & Workmanship

1.1. The relevant specifications of item No. 17.58 (I) shall be followed except that the proportion of mortar is cement mortar 1:6.

2.0. Mode of measurements & payment

2.1. The mode of measurement and payment shall be followed same as item No. 17.58(1)

2.2. The rate shall be for a unit of one square meter.

17.61.(I) 20 mm. thick cement plaster in single coat on rough side of single or half brick wall for interior plastering up to floor two level, finished even and smooth in cement mortar 1:3 (1 cement : 3 sand).

1.0. Materials & workmanship

1.1. The relevant specifications of item No. 17.59 (I) shall be followed except that the thickness of cement plaster shall be 20 mm. The plastering work shall be in single coat on rough side of half brick wall for interior plastering up to floor two level, finished even and smooth in C.M. 1:3.

2.0. Mode of measurements & payment

2.1. The relevant specifications of item No. 17.59(1) shall be followed.

2.2. The rate shall be for a unit of One sq. meter.

121

17.61.(II) 20 mm. thick cement plaster in single coat on rough side of single or half brick wall for interior plastering up to floor two level, finished even and smooth in cement mortar 1:4 (1 cement : 4 sand).

1.0. Materials & Workmanship

1.1. The relevant specifications of item No. 17.59. (II) shall be followed except that the thickness of plastering shall be 20 mm. in C.M 1:4.

2.0. Mode of measurements & payment

2.1. The relevant specifications of item No. 17.59 (I) shall be followed.

2.2. The rate shall be for a unit of one sq. meter

17.61 (III) 20 mm. thick cement plaster in single coat on rough side of single or half brick wall for interior plastering up to floor two level, finished even and smooth in C.M. 1:6 (1 cement : 6 sand).

1.0. Materials & Workmanship

1.1. The relevant specifications of item No. 17.59 (III) shall be followed except that thickness of plaster shall be 20 mm. C.M 1:6.

2.0. Mode of measurements & payment

2.1. The relevant specifications of item No. 17.59 (I) shall be followed.

2.2. The rate shall be for a unit of One sq. meter.

17.69 Extra over items 51 to 65 for finishing with a floating coat of neat cement slurry.

1.0. Materials & workmanship

1.1. The relevant specification of item No. 17.58 and 1761 shall be followed for materials and workmanship except that this work is only providing smooth cement finish with floating coat of neat cement slurry

1.2. The coat of cement and fine sand mortar of proportion V1 (1 5 mm thick about) shall be applied to the plastered surface with a trowel to provide uniform texture while the base coat is still plastic.

1.3. In any continuous face of wall the finishing treatment should be carried out continuously and day to day breaks made to coincide with architectural breaks in order to avoid unsightly Junctions

1.4. Curing : All the plaster work shall be kept damp continuously for a period 7 days

2.0. Mode of measurements and payment

2.1. The payment shall be made for a unit of 1.0 sq. mt of work done over and above the finishing of work of base coat.

2.2. The relevant specifications of item of base coat shall be followed for measurements and payment.

2.3. The rate shall be for a unit of One sq. meter.

17.70. Extra over item 17.58 to 17.61 for providing and mixing water proofing materials in cement mortar in proportion recommended by the manufacturers.

1.0. Materials and Workmanship

The relevant specification of item No 17.58 to 1761 shall be followed except that the water proofing materials of approved make shall be added to the cement at the rate specified or as directed by The Engineer-in-charge. The proportion of water to be mixed with 50 kg bags shall be as recommended by the manufacturers of the water proofing material

2.0. Mode of measurements & payment

2.1. The payment shall be made extra for this work over and above the plaster work

2.2. The rate shall be for a unit or 1 Kg of water proofing materials used in 1 bag of weighing 50 Kg cement used extra over the rate of plastering work

17.91. Extra over item No. 17.59 to 17.61 for plastering on ceiling and soffits of stair up to floor two level instead of plastering on walls.

1.0. Materials and Workmanship

1.1. The relevant specifications of item No 17.59 (1) shall be followed except that this work is for ceiling, soffits of stairs up to two floors

1.2. The smooth concrete surface shall be suitably roughened to provide bond before plastering.

2.0. Mode of measurement and payment

2.1. The payment shall be made for a unit of One sq meter of work done extra over and above the payment of plaster work on wall surfaces.

2.2. The rate shall be for a unit of one sq. meter.

17.94(1) Extra over item No. 1 to 69, 71 to 87 and 90 for interior plastering above floor two level for every additional storey height (i) Single coat plaster.

1.0 Materials and Workmanship

1.1 The relevant specification of Item No. 17.59 (1) shall be followed except that the whole work is to be carried out above floor two level.

122

2.0. Mode of measurements and payment

1.2. The mode of measurement and payment shall be same as item No. 17.59(1).

2.2. The extra payment shall be made over and above the floor two level rate for every additional floor height.

17.94 (II) Extra over item 1 to 69, 71 to 87 and 90 for interior plastering above floor two level for every additional storey height. Two coat plaster.

1.0. Materials & workmanship

1.1. The relevant specifications of item No. 17.94 (I) shall be followed except that extra payment for work shall be for a two coat plaster.

2.0. Mode of measurements & payment

2.1. The relevant specifications of item No. 17.94(1) shall be followed.

2.2. The rate shall be for a unit of one sq. meter.

17.94(111) Extra over item 1 to 69, 71 to 87 and 90 for interior plastering above floor two level for every additional storey height. Floating coat of neat cement.

1.0. Materials & Workmanship

1.1. The relevant specifications of item No. 17.94 (I) shall be followed except that the extra payment shall be made for work of floating coat of neat cement slurry.

2.0. Mode of measurements & payment

2.1. The relevant specifications of item No. 17.59 (I) shall be followed.

2.2. The rate shall be for a unit of One sq. meter.

17.95. 20 mm. thick sand face cement plaster on walls up to height of 10 mm. and above ground level consisting of 12 mm. thick backing coating of C.M. 1:3 (1 cement : 3 sand) and 8 mm.

thick finishing coat in C.M. 1:1 (1 cement : 1 sand) etc. complete.

1.0. Materials

1.1. Water shall conform to M-1. Cement mortar shall conform to M-11.

2.0. Workmanship

2.1. The work shall be carried out in the coats. The backing coat (base coat) shall be 12 mm. thick in C.M. 1:3. The relevant specifications of item No. 17.58(I) shall be followed except that the thickness of back coat shall be 12 mm. average. Before the first coat hardens its surface shall be beaten up by edges of wooden tapers and close dents shall be made on the surface. The subsequent coat shall be applied after this coat has been allowed to set for 3 to 5 days, depending upon the weather conditions. The surface shall not be allowed to dry during this period.

2.2. The second coat shall be completed to 8 mm. thickness in C.M. 1:1 as described above, including raising sand facing by bushing. The sample of sand face shall be got approved before the work is started. The whole work shall be carried out uniformly as per sample approved.

2.3. Curing :

The curing shall be started overnight after finishing of plaster. The plaster shall be kept wet for a period of 7 days. During this period, it shall be protected from all damages.

3.0. Mode of measurement & payment

3.1. The relevant specifications of item No. 17.58 shall be followed except that the sand face plaster on outside up to 10 m. above ground level shall be measured under this item.

3.2. The rate shall be for a unit of One sq. meter.

17.116(A) Pointing on brick work with cement mortar 1:3 (1 cement : 3 coarse sand) flush pointing.

1.0. Materials

1.1. Water shall conform to M-1. Cement mortar shall conform to M-11.

2.0. Workmanship

2.1. The flush pointing work shall be carried out with cement mortar of proportion 1:3(1 part of cement and 3 part of coarse sand) by volume.

2.2. Preparation of surface.

2.2.1. The joints shall be raked to such a depth that the average of new mortar measured from either the sunk surface to finished pointing or from the -edge of the brick shall be average 10 mm.

2.3. Application of Mortar and Finishing :

2.3.1. The mortar shall, be pressed in to the raked out joints with a pointing trowel according to the types of pointing specified in item. The mortar shall not spread over the corner edges or surface of the masonry. The pointing shall then be finished with the pointed tools.

123

2.4. Curing :

2.4.1. The pointing shall be kept wet for 7 days. During this period, it shall be suitably protected from all damages.

3.0. Mode of measurements & payment

3.1. No deductions shall be made end of joints, beams and posts etc. and openings not exceeding 0.5 s. mt. each and no addition shall be made for reveals, jambs, soffits, sills etc. of these openings.

3.2. Deductions for openings exceeding 0.5 sq. mt. but not exceeding 3 sq. mt. each shall be paid as follows and no addition shall be made for reveals, jambs, soffits, sills etc. of these openings : (i) When both faces of walls are pointed with same type of pointing, deduction shall be made for one face only, (ii) When two faces of walls are pointed with different type of pointing or if one face is plastered and the other is pointed, deduction shall be made in the plaster or pointing on the side of frame for door, windows etc. on which the width of reveals is less than that on the other side but no deduction shall be made from plaster or pointing on the other side.

(iii) When only one face is treated and the other face is not rested, full deduction shall be made, if the width of the reveals on the treated side is less than on the untreated side, but if the width of the reveal is more then no deduction shall be made nor any addition shall be made for reveals/jambs, soffits, sills etc. **3.3.** In case of openings of area above 3 sq. mt each deduction shall be made for opening but jambs, sills, and soffits, shall be measured.

3.4. The rate shall be for a unit of One sq. meter.

17.116(8) Pointing on brick work with cement mortar 1:3 (1 cement : coarse sand) Ruled pointing.

1.0. Materials & Workmanship

1.1. The relevant specifications of item No. 17.116 (A) shall be followed except that the pointing to be done ruled pointing as under:

1.2. The joints shall be initially formed as for flush pointing and then while the mortar is still green, a groove of specified shape shall be formed by running forming tool straight along the centre line of joints till a smooth and hard surface is obtained. The vertical joints shall also be finished in a similar way. The pointing lines shall be uniform in width and truly horizontal and parallel in case of floor and ceiling.

2.0. Mode of measurements & payment

2.1. The mode of measurements and payment shall be the same as per item No. 17.116(A).

2.2. The rate shall be for a unit of One sq. meter.

17.117(A) Pointing on brick work with cement mortar 1:4 (1 cement : 4 sand) Flush pointing.

1.0. Materials & Workmanship

1.1. The relevant specifications of item No. 17.116 (A) shall be followed.

2.0. Mode of measurements & payment

2.1. The relevant specifications of item-No. 17.116 (A) shall be followed.

2.2. The rate shall be for a unit of One sq. meter.

17.117(6) Pointing on brick work with cement mortar 1:4 (1 cement : 4 sand) Ruled pointing.

1.0. Materials & Workmanship

1.1. The relevant specifications of item No. 17.116(6) shall be followed except that the proportion of C.M. 1:4 shall used for ruled pointing.

2.0. Mode of measurements and payment

2.1. The relevant specifications of item No. 17.115 (A) shall be followed.

2.2. The rate shall be for a unit of One sq. meter.

17.140.(A) Pointing on coursed stone masonry with cement mortar 1:3 (1 cement : 3 sand) flush pointing.

1.0. Materials and workmanship

1.1. The relevant specifications of item No. 17.116 (A) shall be followed except that the pointing shall be done on coursed stone masonry with C.M. 1:3 and the mortar shall be simply struck off with a trowel and the work left showing the natural irregularities in line and the surface of the stones themselves.

2.0. Mode of measurement and payment

2.1. The relevant specifications of item No.17.116 (A) shall be followed.

2.2. The rate shall be favor a unit of One sq. meter.

17.140(B) Pointing on course stone masonry with cement mortar 1:3 (1 cement ; 3 sand) Ruled pointing.

1.0. Materials and Workmanship

1.1. The relevant specifications of item No. 17.140 (A) and 17.116 (B) shall be followed.

124

2.0. Mode of measurements & payment

2.1. The relevant specifications of item No. 17.116(A) shall be followed.

2.2. The rate shall be for a unit of One sq. meter.

17.44.(A) Pointing on uncoarsed stone masonry with cement mortar 1:3 (1 cement : 3 sand) Flushing pointing.

1.0. Materials & Workmanship

1.1. The relevant specifications of item No 17 116(A) shall be followed except that the flush pointing shall be done on uncoarsed rubble masonry work if C.M 1 3 and the mortar shall be simply Struck off with a trowel and the work left showing the natural irregularities in line and the surface of the stone themselves.

2.0. Mode of measurements and payment

2.1. The relevant specifications of item No. 17.116(A) shall be followed.

2.2. The rate shall be for a unit of One sq. meter.

17.144.(B) Pointing on uncoarsed stone masonry with cement mortar 1:3 (1 cement : sand) Ruled pointing.

1.0. Materials & Workmanship

1.1. The relevant specification of item No 17 116 (Aj and 17 144 (A) shall be followed except that the ruled pointing work -shall be carried out on uncoarsed rubble masonry work in CM 1.3.

2.0. Mode of measurements and payment

2.1. The relevant specifications of item No. 17.116(A) shall be followed.

2.2. The rate shall be for a unit of One sq. meter

17.0.0.1 Providing cement vata (10 cms x 10 cms) size quarter round in cement mortar 1:1 including neat cement finishing, watering, etc. complete.

1.0. Materials

1.1. Water shall conform to M-1 .Cement mortar shall conform to M-11.

2.0. Workmanship

2.1. The work of cement vata of 10 cms x 10 cms. size shall be earned out at Functions of parapets and terraces as directed. The vata shall be finished in quarter round shape. The work shall be earned out in the neat workman like manner. The inter portion of rain water pipe shall be rounded off properly during constructing the vata. The work shall be cured for 7 days.

3.0. Mode of measurements and payment

3.1. The work shall be measured for finished item in running meter.

3.2. The rate shall be for a One running meter.

125

SECTION-18

White Washing & Distempering

18.11. White washing with lime on undecorated wall surfaces (two coats) to give an even shade including thoroughly brooming the surface to remove all dirt, dust, mortar drops and other foreign matter.

1.1. Materials

1.1. The clear Cole shall be made from glue and boiling water by mixing 1 Kg. mixture shall be suitably tinted where required for use under coloured distemper it directed. Glue shall conform to I.S. 352-1959 (Specifications for animal glue)

1.2. Lime used shall be Freshly burnt class 'C' Lime (fat lime) and white in colour conforming to I.S. 712-1973. Water shall conform to M-1. Best quality of gum shall be used in (the preparations of white wash. Ultramarine blue or Indigo : This shall conform to I.S. 55-1970 for points, and shall be used for preparation of white was, Pigments. Mineral colours, not affected by lime shall be used in preparing colour wash.

2.0. Workmanship

2.1. Preparation of white wash solution Surface already white or colour. The fat lime shall be slaked as site and shall be mixed and stirred with about five liters of water for 1 kg. of unslaked lime to made a trim cream This shall be allowed to stand for d period of 24 hours and then shall be screened through a clean coarse cloth, 4 Kg. of gum dissolves in hot water shall be added to each cubic meter of lime cream Small quantity of ultramarine blue (Up to 3 gins, per kg. of lime) shall also-be added to the last two coats of white wash solution and the whole solution shall be stirred thoroughly before use.

2.2. Preparation of surface:

2.2.1. The surface shall be thoroughly cleaned of all dust, dirt, mortar cropping and other foreign matter before white wash is to be applied.

2.2.2. The surface spoiled by smoke soot shall be scrapped with steel wire brushes or steel scrapers 01 shall be rubbed with over-burnt surkhi or brick bats. The surface shall be then broomed to remove all dust dirt and shall be washed with clean water.

2.2.3. Oil or grease spots shall be removed by suitable chemical and smooth surface shall be rubbed with wire Crushes.

2.2.4. All unsound portion of the surface plaster shall be removed to full depth of plaster in rectangular patches and plastered again after raking the masonry joints properly. Such portion shall be wetted and allowed to dry. They shall then be given one coat of white wash

2.2.5. All unnecessary nails shall be removed the holes, cracks, patches etc. shall be made good with material similar in composition to the surface to be prepared

2.3. Scaffolding :

Wherever scaffolding is necessary it shall be erected in such a way that as far as possible on part of scaffolding shall rest against the surface to be white or colour washed. A properly secured strong and well tied suspended platform (Zoola) may be used for white washing. Where ladders are used pieces of old gunny bags shall be tied at top and bottom to prevent scratches to the floors and walls. For white washing of ceilings, proper stage scaffolding shall be erected where necessary.

2.4. Application of white wash :

2.4.1. On the surface so prepared the white wash shall be applied with 'Moon' brush. The first stroke of the brush shall be from top downwards, another from bottom upwards over the first stroke and similarly one stroke from the right another from the left, over the first stroke brush before it dries. This will form one coat each coat shall be allowed to dry before and uniform finish free from brush marks and it should not come off easily when rubbed with finger

2.4.2. Splashing and dropping if any on the doors and windows, ventilators etc shall be removed and the surface cleaned.

2.4.3. Priming and Alkali resistant treatments, scraping of surface washing etc. surface spoiled by smoke soot removed of oil and grease spots, treatment for infection with efflorescence moulds moss, fungi, algae and lichen and patch repairs to plaster wherever done shall not be paid extra.

126

3.0. Mode of measurement & payment

3.1. All the work shall be measured in the decimal system as under:

- (a) Dimensions shall be measured to the nearest 0.01 m.
- (b) Area in individual item shall be worked out to the nearest 0.01 sq.m.

All the work shall be measured in sq. mt. Deductions for jambs, soffits, sills etc. for openings not exceeding 0.5 sq. mt. each in area, for ends of joists, posts, beams, girders, steps etc. not exceeding 0.5 sq mt. each in area and for openings exceeding 0.5 sq. mt. and not exceeding 3.0. sq. mt. each in area, deductions and additions shall be made as under.

3.2. No deductions shall be made for ends of joists, beams, posts, etc. and openings not exceeding 0.5 sq mt. each. No addition shall be made for reveals, jambs, soffits, sills etc. of these openings not for finish around ends of joints, beams, posts etc.

3.3. No deductions for openings exceeding 0.5 sq.mt. but not exceeding 3 sq. mt. each shall be made as follows and no addition will be made for reveals, jambs, soffits etc. of these openings :

- (a) When both the faces of walls are provided with finish, deduction shall be made for one face only.
- (b) When each face of wall is provided with different finish, deduction shall be made for that side of frame for door, windows, etc. on which width of reveals is less than that of the other side. Where width of reveals on both faces of wall are equal, deduction of .50% of area of opening on each face shall be made from total area of finish.
- (c) When only one face of wall is treated and the other face is not treated, full deduction shall be made if the width of reveal on the treated side is less than that on the untreated side, but if the width of the reveal is equal or more than on the untreated side neither deductions nor additions to be made for reveals, jambs, soffits, sills etc.

3.4 In case of area of openings exceeding 3 sq. mt. each, deductions shall be made for openings but jambs, soffits, sills shall be measured.

3.5. No deductions shall be made for attachment such as casing, conducts, pipe, electric wiring and the like.

3.6. Corrugated surfaces shall be measured flat as fixed and not girth. The quantities so measured shall be increased by the following percentage and the resultant shall be included with the general areas:

- (a) Corrugated steel sheets..... 14%
- (b) Corrugated A.C. sheets..... 20%
- (c) Semi corrugated A.C. Sheets..... 10%
- (d) Nainital pattern roof (Plain sheeting sheets)..... 10%
- (e) Nainital pattern roof (with corrugated sheets)..... 25%

3.7. Cornices and other wall features, when they are not picked out in a different finish/colour shall be girthed and included in the general area.

3.8. The rate shall include the cost of all materials, labour, scaffolding, protective measures etc. involved in all the operations described above.

3.9. The rate shall be for a unit of One sq. meter.

18.12. White washing with lime on decorated wall surface (One coat) to give an even shade including thoroughly brooming in the surface to remove dust, mortar, drops and loose scales of lime wash and other foreign matter.

1.0. Materials and Workmanship

1.1. The relevant specifications of item No. 18.11 shall be followed except that the white washing work shall be carried out on decorated wall surface single coat.

2.0. Mode of measurements & payment

2.1. The relevant specifications of item No. 18.11 shall be followed.

2.2. The rate shall be for a unit of One sq. meter

18.13 Extra over items 18.11 and 18.12 for every subsequent coat of white washing with lime on wall surfaces.

1.0. Materials and Workmanship

1.1. The relevant specifications of item No. 18.11 shall be followed except that this work is for extra coat over and above two coats on wall surface.

127

2.0. Mode of measurements and payment

2.1. The relevant specifications of item No. 18.11 shall be followed except that the payment of subsequent coat shall be made extra over and above the item No. 18.11 for every subsequent coat applied.

2.2. The rate shall be for a unit of One sq. meter.

18.14. Extra over item 18.11 for white washing with the lime on ceiling and / or sloping roof.

1.0. Materials and Workmanship

1.1. The relevant specifications of item No. 18.11 above shall be followed except that this work is for ceiling and / or sloping roof.

2.0. Mode of measurements and payment

2.1. The relevant specifications of item No. 18.11 shall be followed except that extra payment for white washing on ceiling and/or sloping roof shall be made over and above the payment of item No. 18.11

2.2. The rate shall be for a unit of One sq. meter.

18.15 Extra over 18.12 for white washing with lime on decorated dealings and sloping roofs.

1.0. Materials and Workmanship

1.1. The relevant specifications of item No. 18.12 shall be followed except that the white washing work shall be carried out on decorated ceilings and/or sloping roofs.

2.0. Mode of measurements and payment

2.1. The relevant specifications of item No. 18.12 shall be followed except that extra payment for white washing on ceiling and/or sloping roof shall be made over and above the payment of item No. 18.12.

2.2. The rate shall be for a unit of one sq. meter.

18.16. Extra over the item No. 18.13 for every subsequent coat of white washing with lime on ceiling and /or sloping roofs.

1.0. Materials and Workmanship

1.1. The relevant specifications of item No. 18.11 and 18.13 shall be followed except that this work is for extra coat over and above two coats of ceiling and / or sloping roofs.

2.0. Mode of measurements and payment

2.1. The relevant specifications of item No. 18.11 and 18.13 shall be followed except that the extra payment for white washing shall be made for sloping roof or/and ceiling for every subsequent coat applied over and above item 18.11 and 18.13.

2.2. The rate shall be for a unit of one sq. meter.

18.17. Colour washing with lime on undecorated wall surfaces (Two coats) over and including priming coat of white washing to give even shade including thoroughly brooming the surface to remove all dirt, dust, mortar drops and other foreign matter. The relevant specifications for the materials and workmanship 18.11 shall be followed except that it shall be for colour wash.

1.0. Materials

1.1. Clear-Cole : This shall be made from glue and boiling water by mixing 1 kg. of glue to every 15 liters of water. The mixing shall be suitably tinted to match with colour of colour washing as directed. Glue shall conform to I.S. 852-1969.

1.2. Lime : Lime used shall be freshly burnt class 'C' lime (Fat lime) and white in colour conforming to I.S. 712-1973.

1.3. Water : Water shall conform to M-1.

1.4. Gum ; Best quality of gum shall be used in the preparation of white or colour wash. The colour pigment of required tint and shade shall be mixed in lime cream. The mineral colour not affected by lime shall be used in preparing the colour wash.

2.0. Workmanship

2.1. Sufficient quantity of colour wash enough for the complete job shall be prepared in one operation to avoid any difference in shade. The basic white wash solution shall be prepared in accordance with item 18.11 Mineral colours not affected by lime shall be added to the white wash solution. No colour wash shall be done until a sample of the colour has been approved. It shall be noted that small samples of colour appears lighter in shade than when the same shades are applied precisely to large surface. The colour shall

be of even tint, over the colour shall be of even tint, over the whole surface. If it is patchy or otherwise badly applied, it shall be rejected. Preparation of the colour wash with pigment shall be as under:

(a) With Yellow and Red Ocher :

Solid lumps if any in the powder shall be crushed to powder and solution in water prepared and then added to white wash sieving it through a coarse cloth, mixed evenly and thoroughly to white wash in-small quantities till required shade is obtained.

(b) With Blue Vitriol :

Fresh crystals of hydrous copper sulfate (i.e. vitriol) shall be ground to fine power and dissolved in small quantity of water. Sufficient quantity of solution enough to produce the colour wash of required shade shall be strained through a clean cloth, the filtrate being mixed evenly and thoroughly to the white wash.

(c) Colour wash from other colouring pigment shall be prepared in accordance with the instructions of the manufacturer.

2.2. Preparation of Surface :

128

The surface shall be prepared by removing mortar dropping and foreign matter and thoroughly cleaned with wire of fiber brush or any other suitable means as directed by the Engineer-in-charge. All loose pieces and scales shall be scrapped off and holes filled with mortar.

2.2.1. For scaffoldings and application of colour wash, relevant specification of item No. 18.11. above shall be followed. The colour wash shall be applied as under:

The colour wash shall be applied in accordance with the procedure given in item No. 18.11. "Application of white wash for colour washing on undercoated surface after the surface has been prepared. The first primary coat shall be of white wash and subsequent coats (minimum two) shall be colour wash and the entire surface shall represent a smooth and uniform finish. To start with, patch of 0.1 sq. mt. on prepared surface shall be colour washed with first coat of white wash and subsequent coats of colour wash solution entire work of colour washing is taken up in hand, it shall be noted that small areas of colour wash will appear lighter than when the same shade is applied to the large surface.

2.2.2. For colour washing on decorated surfaces, after (the surface has been prepared, a coat of white wash shall be applied for the patches and repairs. Then one coat or more of colour wash shall be applied over the entire surface, such that the colour washed surface shall present a uniform colour shade. No primary coat is needed for a decorated surface bearing colour of same shade on surface required change of colour after the surface has been prepared as described above. Two coats of white wash shall be applied before application of specified number (minimum two) of coats of colour wash of the new shade.

2.3. Protective measure :

The surface of doors, windows, floors, articles, of furniture etc. and such other parts of the building not to be white washed shall be protected from being splashed upon. Such surfaces shall be cleaned of white wash splashed if any.

3.0. Mode of measurements and payment

3.1. The relevant specifications of item No. 18.11 shall be followed.

3.2. The rate shall be for a unit of One sq. meter.

18.18. Colour washing with lime on decorated wall surfaces (one coat) to give even shade including thoroughly brooming the surface to remove all dirt, dust, mortar drops and loose scales of lime wash and other foreign matter.

1.0. Materials and Workmanship

The relevant specifications item No 18.17 shall be followed except that the colour washing shall be carried out on decorated wall surface in one coat

2.0. Mode of measurements and payment

2.1. The relevant specifications of item No 18.7 shall be followed.

2.2. The rate shall be for a unit of One sq. meter.

18.19. Extra over item No 13.17 and 18.18 for every subsequent coat of colour wash with lime on wall surfaces.

1.0 Materials and Workmanship

1.1 The relevant specifications item No. 18.17 shall be followed except that this work is for extra coat of colour wash over and above two coats on wall surface.

129

2.0. Mode of measurement and payment

2.1. The relevant specifications of item No. 18.17 shall be followed except that the extra payment for every subsequent coat of white wash shall be made over and above the rate of item. 18.17 and 18.18.

2.2. The rate shall be for a unit of one sq. meter.

18.20. Extra over item 18.17 for colour washing on ceilings and /or sloping roofs.

1.0. Materials and workmanship

1.1. The relevant specifications of item No. 18.17 shall be followed except that this work is for colour washing on ceiling and/or sloping roofs.

2.0. Mode of measurements and payment

2.1. The relevant specifications of item No. 18.17 shall be followed except that the rate shall be paid extra over and above the rate of item No. 18.17 for providing colour washing on ceiling and /or sloping roof.

2.2. The rate shall be for a unit of One sq. meter.

18.29. Cement washing with port land cement slurry on undecorated wall surfaces, (one coat) to give a smooth finish including thoroughly brooming the surface to remove all dirt, dust, mortar drops and other foreign matter.

1.0. Materials

1.1. Water shall conform to M-1. Part land cement shall conform to M-3.

2.0. Workmanship

2.1. The relevant specification of item No. 18.11 for preparation of surface, scaffolding, application of wash etc. shall be followed except that the cement wash shall be applied, instead of white wash. Cement applied with brushes to form a smooth bodied opaque surface.

3.0. Mode of measurements and payment

3.1. The relevant specifications of item No. 18.11 shall be followed.

3.2. The rate shall be for a unit of one sq. meter.

18.30. Extra over item No. 18.29 for every subsequent coat of cement washing with port land cement slurry.

1.0. Materials Workmanship

1.1. The relevant specifications of item No. 18.29 shall be followed except that the work of cement slurry wash

shall be provided for every subsequent coat above item No. 18.29 to be applied.

2.0. Mode of measurements and payment

2.1. The relevant specification of item No. 18.29 shall be followed except that the extra rate shall be paid for every subsequent coat and above the rate of item No. 18.29.

2.2. The rate shall for a unit of One sq. meter.

18.33. Removing dry or oil bound distemper by washing scraping and sand papering the wall surface smooth including necessary repairs to scratches complete.

1.0. Materials and Workmanship

1.1. All loose places and scaled shall be removed by sand papering and surface shall be cleared of all greasycay, dust, dirt, etc. on decorated wall surfaces. Where heavy scaling has taken place, the entire surface shall be scrapped by means of steel scrappers so as to remove all accumulated distemper, leaving clean surfaces. Necessary repairs to the scratches shall be made as directed.

2.0. Mode of measurements and payment

2.1. The relevant specifications of item No. 18.11. shall be followed.

2.2. The rate shall be for a unit of One sq. meter,

13.34. Extra over item No. 18.33. for removing dry oil bound distemper on ceiling and sloping and roofs.

1.0. Workmanship

1.1. The relevant specifications of item No. 18.33 shall be followed except that removing dry/oil bound distemper from sloping roof/ceiling is to be carried out.

130

2.0. Mode of measurements and payment

2.1. The relevant specifications of item No. 18.33 shall be followed except that the payment shall be made for removing dry/oil bound distemper from ceiling/sloping roof over and above the rate of item No. 18.33.

2.2. The rate shall be for unit of one Sq. meter.

18.38. Distemping with dry (water bound) Distemper of approved brand and manufacture (two coats) and of required shade on undecorated wall surfaces to give an even shade, over and including a priming coat of white washing after thoroughly brooming the surface free from mortar droppings and other foreign matters.

1.0. Materials

1.1. The dry distemper and primer shall be of approved brand and manufacture. The dry distemper shall be of required colour and shade and the same shall conform to I.S. 427-1965. Writing shall conform to I.S. 63-1964.

2.0. Workmanship

2.1. Scaffolding : Where scaffolding is required it shall be erected in such a way that as far as possible no part of scaffolding shall rest against the surface to be distempored. A properly secured strong and well tied suspended platform (Joolas) may be used for distemporing. Where ladders are used- pieces of old gunny bags shall be tied at top and bottom to prevent scratches to the walls and floors. \For distemporing to ceiling, proper stage scaffolding shall be erected where necessary.

2.2. Preparation of Surface.

2.2.1. The undecorated surface to be distempored shall be thoroughly brushed free from dust, dirt, grease, mortar, droppings and other foreign matter and sand papered smooth. New plaster surface shall be allowed to dry at least 2 months before application of distemper.

2.2.2. All unnecessary nails shall be removed. Pitting in plaster shall be made good with plaster of Paris mixed with dry distemper of the colour to be used. The surface shall then be rubbed down again with a fine grades and paper and made smooth. The surface affected by moulds, moss, fang, algae lichens, efflorescence etc. shall be treated in accordance with I.S. 2395 (Part-I) 1966 before applying distemper. Any unevenness shall be made good by applying putty made of plaster of Paris mixed with water on entire surface including filling up the undulations and then sand papering the same after it is dry.

2.3. Priming coat :

2.3.1. A priming coat of whiting shall be applied as per item No. 18.11 over the prepared surface in case of new work on undecorated surface. No coat of white washing with lime shall be used as a priming coat for distemper.

2.3.2. Application of plaster shall be done as under:

The primer shall be applied with a brush on the clean dry and smooth surface. Horizontal strokes shall be given first and vertical stokes shall be applied immediately afterwards. This entire operation will constitute one coat. The surface shall be finished as uniformly as possible leaving no brush marks. It shall be allowed to one coat. The surface shall be finished as uniformly as possible leaving no brush marks. It shall be allowed to dry for at least 48 hours before oil bound distemper or paint is applied.

2.3.3. Distemper is not recommended to be applied within six months of the completion of wall plaster.

2.4. **Proportion of Distemper :** The distemper shall be diluted with water or any other prescribed thinner in a manner recommended by the manufacturers only. Sufficient quantity of distemper required for one day's work shall be prepared.

2.5. Application of Distemper coat :

2.5.1. For undecorated surfaces after the primer coat is dried for at least 48 hours, the surfaces shall be lightly sand papered to make them smooth for receiving the distemper, taking care not to rub out the priming coat. All loose particles shall be dusted off after rubbing. Minimum two coats of distemper shall be applied with brushes in horizontal strokes followed immediately by vertical strokes which together shall constitute one coat. The subsequent coats shall be applied after a time interval strokes which together shall constitute one coat. The

subsequent coats shall be applied after a time interval of at least 24 hours between consecutive coats to permit proper drying of the preceding coat. The finished surface shall be even and uniform without patches, brush marks, distemper drops etc.

2.5.2. Sufficient quantity of distemper shall be mixed to finish on room at a time. The application of a coat in each room shall be finished in one operation and no work shall be started in any room which cannot be completed, on the same day.

131

2.5.3. 15 cm. double bristle distemper brush shall be used. After the day's work, brushes shall be thoroughly washed in hot water with soap solution and hang down to dry. Old brushes which are dirty and caked with distemper shall not be used on the work.

2.6. Protective Measures : The surfaces of doors, windows, floors, articles of furniture etc. and such other parts of the building as are not to be distempered shall be protected from being splashed upon. Such surfaces shall be cleaned of distemper splashes if any.

3.0. Mode of measurements and payment

3.1. Pruning coat of distemper primer, scraping of surface spoiled by smoke soot, removal of oil and grease spots, treatment for infestation of effloresces, mould moss, fungi, algae and lichens and patch repairs to plaster shall be included in this item for which nothing extra shall be paid.

3.2. All the work shall be measured net in the decimal system as in places subject to the following limits unless otherwise stated hereinafter:

(a) Dimensions shall be measured to the nearest 0.01 m.

(b) Area in individual items shall be worked out to the nearest 0.01 sq. m. All work shall be measured in sq. meter. No deductions shall be made for ends of joints, beams, posts, etc. of these openings nor for finish around the ends of joints, beams, posts etc.

3.3. Deductions of openings exceeding 0.5 sq.m. but not exceeding 3 sq. m. each shall be made as follows and no addition shall be made for reveals, jambs, soffits etc. of these openings:

(a) When both the faces of walls are provided with the same finish deductions shall be made for one face only.

(b) When each face of wall is provided with different finish, deduction shall be made for that of frame for door, windows etc. on which width of reveal is less than that of the other side but no deductions shall be made on the other side. Where the width of reveals on the both the faces of wall are equal, deduction of 50% of area of opening on each face shall be made from area of finish.

(c) When only one face of wall is treated and the other face is not treated, full deductions shall be made if the width of the reveal on treated side is less than that on untreated side but if the width of the reveals is equal or more than that of untreated side neither deductions nor additions to be made for reveals, jambs, sills and soffits shall be measured

3.4. In case of openings of area exceeding 3 sq.m. each, deduction shall be made for openings, but jambs, sills and soffits shall be measured.

3.5. No deductions shall be made for attachments such as casing, conduits, pipes, electric wiring and the like.

3.6. Item includes removing nails, making good holes, cracks, patches with materials similar in composition to the distemper.

3.7. The rate includes cost of all materials, labour, scaffolding, protective measures etc. involved in all the operations described above This shall also include conveyance, delivery, bundling, unloading storing etc.

3.8. The rate shall be for a unit of One sq. meter.

18.39. Distemping with dry (wafer bound) distemper of approved brand and manufacture (one coat) and of required shade, on decorative wall surface to give an even shade after thoroughly brushing the surface clean of all grease dirt, loose pieces of scales including preparing the surfaces and even sand papered smooth.

1.0. Materials and workmanship

The relevant specifications of Kern No. 18.38 shall be followed except that the dry distemper shall be applied on decorative wall surface in one coat.

2.0. Mode of measurements and payment

2.2. The rate shall be for a unit of One sq. meter.

18.40. Extra over item 38 and 39 for every subsequent coat of distemper with dry distemper of approved brand and manufacture.

1.0. Materials and Workmanship

1.1. The relevant specifications of item No. 18.38 shall be followed except that the extra work for applying subsequent coat of dry distemper is to be carried out over and above the work of item No. 18.38 and 18.39.

132

2.0. Mode of measurements and payment

2.1. The relevant specifications of item No. 18.38 shall be followed except that extra rate shall be paid for every subsequent coat applied over and above the rate of item No. 18.38 and 18.39.

2.2. The rate shall be for a unit of One sq. meter.

18.41. Extra over item 38 for distemping with dry distemper on ceiling and sloping roofs.

1.0. Materials and workmanship

1.1. The relevant specifications of item No. 18.38 shall be followed except that the dry distemping shall be carried out on ceiling and sloping roofs of undercoats surface.

2.0. Mode of measurements & payment

2.1. The relevant specifications of item No. 18.38 shall be followed except that extra rate shall be paid for

carrying outwork on ceiling/sloping roof on undecorated surface over and above the rate of item 18.38.

2.2. The rate shall be for a unit of One sq. meter.

18.42. Extra over item 39 and 40 for distempering with dry distemper on ceiling/sloping roofs.

1.0. Materials and Workmanship

1.1. The relevant specifications of item No. 18.39 shall be followed except that the work shall be carried out on ceiling/sloping roofs on decorated surfaces.

2.0. Mode of measurements and payment

2.1. The relevant specifications of item No. 18.39 shall be followed except that the extra rate shall be paid for the distempering work carried out by dry distempered on ceiling/sloping roofs with decorated surfaces over and above the raw of item N. 18.39.

2.2. The rate shall be for a unit of One sq. meter.

18.44. Distempering (two coats) with oil bound distemper of approved brand and manufacture and of required shade on undecorated wall surfaces to give an even shade, over and including a priming coat with distemper primer of approved brand and manufacture after thoroughly brushing the surface free from mortar droppings and other foreign matter and also including preparing the surface even and sand papered smooth.

1.0. Materials

1.1. Oil bound washable distemper and primer shall be of approved brand and manufacture. The distemper shall be of required colour and shade and the same shall conform to I.S. : 428-1969.

2.0. Workmanship

2.1. Scaffolding

Where scaffolding is required, it shall be erected in such a way that as far as possible no pail of scaffolding shall rest against the surface to be distempered. A properly secured and well tied suspended platform (Joola) may be used for distempering. Where ladders are used, pieces of old gunny bags shall be tied at top and bottom to prevent scratches to the walls and floors. For distempering to ceiling, proper stage scaffolding shall be erected where necessary.

2.2. Preparation of surface :

2.2.1. The undecorated surface to be distempered shall be thoroughly brushed from dust, dirt, grease, mortar dropping and other foreign matter and sand papered smooth. New plaster surface shall be allowed to dry for at least 2 months before applications of distemper.

2.2.2. All unnecessary nails shall be removed. Pitting in plaster shall be made good with plaster again with a fine grade sand paper and made smooth. A coat of distemper shall be applied over the patches. The surface shall be allowed to dry thoroughly before the regular coat of distemper is allowed. The surface affected by moulds, moss, fungi, algae lichens, efflorescence etc. shall be treated in accordance with I.S: 2395 (Part 01) 1966. Before applying distempering, any unevenness shall be made good by applying putty made of plaster of paris mixed with water on entire surface including filling up the undulation and then sand papering the same after it is dry.

2.3. Priming coat :

2.3.1. A priming coat of distemper primer of approved manufacture and shade shall be applied over the papered surface in case of new work on undecorated surface. If the distemper priming is done after the wall surface dries completely, the distemper primer shall be applied.

133

2.3.2. Application of primer shall be done as under: The primer shall be applied with a brush on the clean dry and smooth surface. Horizontal strokes shall be given first and vertical strokes shall be applied immediately afterwards. This entire operation will constitute on coat. The surface shall be finished as uniformly as possible leaving no brush marks. It shall be allowed to dry for at least 48 hours before oil bound distemper or paint is applied.

2.3.3. Oil bound distemper is not recommended to be applied within six months of the completion of wall plaster.

2.4. Preparation of oil bound distemper :

2.4.1. The distemper shall be diluted with water or any other prescribed thinner in a manner recommended by the manufacturer only. Sufficient quantity of distemper required for a days work shall be prepared.

2.5. Application of Distemper coat:

2.5.1. For undecorated surfaces, after the primer coat is dried for at least 48 hours, the surface shall be lightly sand papered to make it smooth for receiving the distemper, taking care not to rub out priming coat. All loose particles shall be dusted of after rubbing. Minimum tow coats of distemper shall be applied with brushes in horizontal strokes followed immediately by vertical strokes which together shall constitute one coat. The subsequent coats shall be applied after a time interval of at least 24 hours between consecutive coats to permit proper drying of the proceeding coat. The finished surface shall be even and inform without patches, brush marks, distemper drops etc.

2.5.2. Sufficient quantity of distemper shall be mixed to finish one room at a time. The application of a coat in each room shall be finished in one operation and no work shall be striated in any room which cannot be completed on the same day.

2.5.3. 15 cm. double bristled distemper brush shall be used. After day's work brushes shall be thoroughly washed in hot water with soap solution and hung down to dry. Old brushes which are dirty and caked with distemper shall not be used on the work.

2.6. Protective measurements : The surfaces of doors, windows, floors, articles of furniture etc. and such other parts of the buildings as are not to be distempered shall be protected form being splashed upon. Such surfaces shall be cleaned of distemper splashes if any.

3.0. Mode of measurements and payment

3.1. Priming coat of distemper primer, scraping of surface spoiled by struck roots, removal of oil and grease spots, treatment for infraction of effloresces., mould moss, fungi, algae and lichen and patch repairs to plaster shall be included in this item for which nothing extra shall be paid.

3.2. All the work shall be measured net in the decimal system as in place subject to the following limits unless otherwise stated hereinafter:

(a) Dimensions shall be measured to the nearest 0.01 m.

(b) Area in individual items shall be worked out to the nearest 0.01 sq. m. All work shall be made for ends of joints, beams, posts etc., and openings, not exceeding 0.5 sq.mt. each and no addition shall be made for reveals, jambs, soffits, sills etc. of these openings not for finish around ends of joints, beams, posts etc.

3.3. Deductions of opening exceeding 0.5 sq.m. but not exceeding 3 sq. m. each shall be made as follows and net addition shall be made for reveals, jambs, soffits etc. of these openings :

(a) When both the faces of wall are provided with same finish, deductions shall be made for one face only.

(b) When each face of wall is provided with different finish, deduction shall be made for that side of frame for doors, windows etc. on which width of reveals is less than that of the other side but no deduction shall be made on the other side. Where the width of reveals on the both the faces of wall are equal, deduction of 50% of area of opening on each face shall be made from area of finish.

(c) When only one face of wall is treated and the other face is not treated, full deductions shall be made if the width of the reveal on treated side is less than that on untreated side but if the width of the reveal is equal or more than that on untreated side neither deductions nor additions to be made for reveals, jambs, soffits, sills etc.

3.4. In case of opening of area exceeding 3 sq. m. each deduction shall be made for openings but jambs, sills and soffits shall be measured.

134

3.5. No deductions shall be made for attachments such as casings, conduits, pipes, electric wiring and the like.

3.6. Item includes removing nails, making good holes, patches with materials similar in composition of distemper.

3.7. The rate includes cost of ail materials, labours, scaffolding, protective measures etc. involved in all the operations described above. This shall also include conveyance, delivery, handing , unloading, storing work etc

2.8. The rate shall be for a unit of one sq. meter

18.45. Distempering (two coats) with oil bound washable distemper of approved brand and manufacture and of shade required on undecorated wall surfaces to give an even shade, over and including a priming coat with alkali resistance primer of approved brand and manufacture after thoroughly brushing the surface free from mortar droppings and other foreign matter and also including preparing the surface even and sand papered smooth.

1.0. Materials and Workmanship

1.1. The relevant specifications of item No. 13.44 shall be followed except that the primer of alkali resistance primer of approved brand and manufacture shall be used instead of distemper primer.

2.0. Mode of measurements and payment

2.1. The mode of measurements and payment shall be the same as for item No. 18.44 above.

2.2. The rate shall be for a unit of One sq. meter.

18.46. Distempering (one coat) with oil bound washable distemper of approved brand of required shade on decorated wall surfaces to give an even shade after thoroughly brushing the surfaces clean of all grease, dirt, loose pieces of scales and also including distempering with oil bound washable distemper of preparing the surface even and smooth.

1.0. Materials and Workmanship

The relevant specifications of item No. 18.44 shall be followed except that the distempering with oil bound washable distemper shall be carried out on decorated wall surfaces in on coat.

2.0. Mode of measurement and payment

2.1. The relevant specification of item No. 18.44 shall be followed.

2.2. The rate shall be for a unit of one sq meter.

18.47. Extra over item 18.44 to 18.46 for every subsequent coat of distempering with oil bound washable distemper of approved brand and manufacture.

1.0. Materials and Workmanship

1.1. The relevant specifications of item No. 18 44 shall be followed except that this work is for providing extra coat of oil bound distempering over and above two coats of distempering.

2.0. Mode of measurements and payment

2.1. The relevant specification of item No, IS K shall be followed except that the extra rate shall be paid over and above the rate for every subsequent coats over two coats of item 18.44 and 18.46.

2.2. The rate shall be for a unit of one sq. meter.

18.48. Extra over item 18.44. and 18.45 for distempering with oil bound washable distemper on ceiling and sloping roofs.

1.0. Materials and Workmanship

The relevant specifications of item No. 18.44 shall be followed except that the distempering shall be carried out on ceiling/sloping roofs.

2.0. Mode of measurements and payment

2.1.1. The relevant specifications of item No. 18.44 shall be followed except that the extra rate shall be paid for carrying our distempering work on ceiling/sloping roofs over and above the rate of item No. 18.44 and 18.45.

2.2. The rate shall be for a unit of one sq. meter.

18.49. Extra over item 18.46 and 18.47 for every subsequent coat of distemping on ceiling and sloping roofs.

135

1.0. Materials and Workmanship

1.1. The relevant specifications of item No. 18.44 shall be followed except that the distemping work shall be carried out for subsequent coats over item No. 18.46 and 18.47.

2.0. Mode of measurements and payments

2.1. The relevant specifications of item No. 18.46 shall be followed except that the extra rate shall be paid for every subsequent coat of distemper applied over and above the rate of item No. 18.46 and 18.47.

18.51. Finishing wall with water proofing cement paint of an undecorated wall surfaces (two coats) to give an approved brand and manufacture and of required shape, even shade after thoroughly brushing the surface to remove.

1.0. Materials

1.1. The water shall conform to M-1. Cement water proofing paint shall conform to I.S. 5410-1969.

2.0. Workmanship

2.1. **Scaffolding** : The relevant, specifications of item No. 18.11 shall be followed.

2.2. Preparation of surface :

The relevant specifications of item No. 18.11 shall be followed except that the word white wash colour wash shall be substituted with water proofing cement paint. The surface shall be thoroughly wetted with clean water before cement water proofing paint is applied.

2.3. **Preparation of paint:** Portland cement paint shall be prepared by adding paint powder to water and stirring to obtain a thick paste, which shall then be diluted to a brush able consistency. Generally, equal volumes of paint powder and water make a satisfactory paint. In all cases, The manufacture's instructions shall Site followed. The paint shall be mixed in such quantities as can used up within an hour of mixing as otherwise the mixture will set and thickness, affecting flowing and finish. The lids of cement paint drums shall be kept tightly when not in use.

2.4. Application of Paint:

2.4.1. No painting shall be done when the paint is-likely to be exposed to a temperature of below 7°C within 48 hours after application.

2.4.2. When weather conditions are such as to cause be carried out in the shadow as far as possible. This helps the proper hardening of the paint film by keeping the surface moist for a longer period.

2.4.3. To maintain the uniform mixture and to prevent segregation, the paint shall be stirred frequently in the bucket.

2.4.4. For undecorated surfaces, the surface shall be treated with minimum two coats of water proof cement paint. Not less than 24 hours shall be allowed between two coats. Next coat shall not be started until the proceeding coat has become sufficiently hard to resist marking by the brush being used. In hot dry weather, the proceeding coat shall be slightly moistened before applying the subsequent coat.

2.4.5. The finished surface shall be even and uniform in shade, without patches, brush marks, paint drops etc.

2.4.6. The cement paint shall be applied with a brush with relatively short stiff hog or fiber bristles. The paint shall be brushed in uniform thickness and shall be free from excessively heavy brush marks. The lamps shall be brushed out.

2.4.7. Water proof cement paint shall not be applied on surface already treated with white wash, colour wash, distemper dry or oil bound varnishes, paint etc. It shall not be applied on gypsum, wood and metal surfaces.

2.5. **Curing** : Painted surfaces shall be sprinkled with water two or three times a day. This shall be done between coats and for at least two days following the final coat. The curing shall be started as soon as the point has hardened so as not be damaged by the sprinkling of water say about 12 hours after the application.

2.6. Protection measures shall be taken as per item No. 18.11 Para 2.6.

3.0. Mode of measurements and payment

3.1. The relevant specifications of item No. 18.11. shall be followed.

3.2. The rate shall be for a unit of One sq. meter.

136

18.53. Extra over item 18.51 for every subsequent coat of water proofing cement paint of approved brand and manufacture.

1.0. Materials and Workmanship

1.1. The relevant specifications of item No. 18.51 shall be followed except that the work is for applying subsequent coat of cement water proofing paint.

2.0. Mode of measurements and payment

2.1. The relevant specifications of item No. 18.51 shall be followed except that the extra rate shall be paid for applying every subsequent coat of cement water proofing paint over and above the rate of item No. 18.51.

2.2. The rate shall be for a unit of One Sq. meter.

18.54. Extra over item 18.51 for finishing with cement paint on ceiling/sloping roofs.

1.0. Materials and Workmanship

1.1. The relevant specifications of item No. 18.51 shall be followed except that the cement water proofing paint shall applied on ceiling and sloping roofs.

2.0. Mode of measurements and payment

2.1. The relevant specifications of item No. 18.51 shall be followed except the extra shall be paid for applying cement water proofing paint on ceiling and sloping roofs, over and above the rate of item No. 18.51.

2.2. The rate shall be for a unit of One sq. Meter.

18.56. Extra over 18.53 for every subsequent coat of finishing with cement paint on ceiling and sloping roofs.

1.0. Materials and Workmanship

1.1. The relevant specification of item No. 18.51 shall be followed except that the work shall be carried out for subsequent coat on ceiling and sloping roofs.

2.0. Mode of measurements and payment

2.1. The relevant specifications of item No. 18.53. shall be followed except that extra rate shall be paid for every subsequent coat applied with cement water proofing paint over and above the rate of item No. 18.53.

18.57. Wall painting (two coats) with plastic emulsion paint of approved brand of manufacture on undecorated wall surfaces to give an even shade including thoroughly brushing the surface free from mortar droppings and other foreign matter and sand paper smooth.

1.0. Materials

Water shall be conform M-1. The plastic emulsion shall conform to I.S.: 5411-1969 (part-I).

2.0. Workmanship

2.1. **Scaffolding** : The relevant specifications of item-No. 18.11 Para 2.1 shall be followed.

2.2. **Preparation of surface** : The relevant specification of item No. 18.44 Para 2.2 shall be followed.

2.3. Preparation of Mix :

This shall be done as per manufacture's instructions. The thinning of emulsion is to be done with water and not with turpentine. The quantity of thinner to be added shall be as per manufacturer instructions.

2.4. Application :

2.4.1. Before pouring into small containers for use, the paint shall be stirred thoroughly in item container. When applying also, the paint shall be continuously stirred in the smaller container, so that its consistency is kept uniform.

2.4.2. The paint shall be laid on evenly and smoothly by means of crossing and laying off the crossing and consist of covering the area over with paint, brushing the surface hard for the first time over and then, brushing alternately in opposite direction two or three times and then finally brushing lightly in direction at right angles to the same. In this process, no brush Marks shall be left after the laying off is finished. No hair marks from the brush or clogging of paint puddles in the corners of panels, angles of moldings, etc. shall be left on the work. The full process of crossing and laying off will constitute one coat.

2.4.3. The paint shall be applied with brush or rollers. For undecorated surfaces, the surface shall be treated with minimum two coats of cement water proofing paint. The second or subsequent coat shall not

137

be started until the proceeding coat as become sufficiently hard to resist marking by brushing being used.

2.4.4. The surface on finishing shall present a flat velvety smooth finish. It shall be even and uniform in shade without patches, brush marks, paint drops etc.

2.5. Precautions :

(a) Old brushes if they are to be used with emulsion paints, shall be completely dried of turpentine or oil paint by washing in warm soap water. Brushes shall be quickly washed in water immediately after use and kept immersed in water fusing break periods to prevent the paint from hardening on the brush.

(b) In the preparation of wall for plastic emulsion painting, no oil base petals shall be used in filling cracks, holes etc.

(c) Splashes on floors etc. shall be cleaned out without delay as they will be difficult to remove after hardening.

(d) Washing or surfaces treated with emulsion paint shall not be done within 3 to 4 weeks of application

2.6. **Protective payment** : The relevant specifications of item No. 18.11 shall be followed.

3.0. Mode of measurements and payment

3.1. The relevant specifications of item No. 18.11 shall be followed.

3.2. The rate shall be for a unit of One sq. meter.

18.59. Extra over item No. 18.57 for every subsequent coat of wall painting with plastic emulsion paint of approved brand.

1.0. Materials and Workmanship

1.1. The relevant specifications of item No. 18.57 shall be followed except that the painting work shall be for subsequent coat of plastic emulsion paint.

2.0. Mode of measurements and payment

2.1. The relevant specifications of item No. 18.57 shall be followed except that the extra payment shall be done on ceiling and sloping roofs.

2.2. The rate shall be for a unit of One sq. meter.

18.60. Extra over item 18.57 for painting with plastic emulsion paint of approved brand on ceiling and sloping roofs.

1.0. Materials and Workmanship

1.1. The relevant specifications of item No. 18.57 shall be followed except that the painting shall be done on ceiling and sloping roofs.

2.0. Mode of measurements and payment

2.1. The relevant specifications of item No. 18.57 shall be followed except that the extra payment shall be made for applying plastic emulsion paint on ceiling and sloping roofs over and the rate of item No. 18.57.

2.2. The rate shall be for a unit of One sq. meter.

18.62. Extra over item 18.59 for paint ceiling and sloping roofs.

1.0. Materials and Workmanship

1.1. The relevant specifications of item No. 18.57 shall be followed except that the work for subsequent coat of plastic emulsion paint shall be carried out on ceiling and sloping roofs.

2.0. Mode of measurements and payment

2.1. The relevant specifications of item No. 18.57 shall be followed except that the extra rate shall be paid for carrying out painting on sloping roofs and ceiling with plastic emulsion paint over and above the rate of item No. 18.59

2.2. The rate shall be a unit of One sq. meter.

138

SECTION-19

Paintings & Polishing

19.7. Painting two coats (excluding priming coat) on new steel and other metal surfaces with enamel paint, brushing, interior to give an even shade including cleaning the surface of all dirt, dust and other foreign matter.

1.0. Materials

The enamel pain shall conform to M-44 B.

2.0. Workmanship

2.1. General : The materials required for work of painting work shall be obtained directly from approved manufactures or approved dealer and brought to the site in maker's drums; kegs. etc. with seal unbroken.

2.1.2. All materials not in actual use shall be kept properly protected, lids of containers shall be kept closed and surface of paint in open or partially open containers covered with a thin layer of turpentine to prevent formation of skin. The materials which have become state or flat due to improper and long storage shall not be used. The paint shall be stirred thoroughly in its container before pouring into small containers. While applying also, the paint shall be continuously stirred in smaller container. No left over paint shall be put back into stock tins. When not in use the containers shall be kept properly closed.

2.1.3. If for any reasons, things is necessary, the brand of thinner recommended by the manufacturer shall be used.

2.1.4. The surface to be painted shall be thoroughly cleaned and dusted. All rust, dirt and grease shall be thoroughly removed before painting is started. No painting on exterior or other exposed part o the work shall be carried out in wet, damp or otherwise unfavorable weather and all the surfaces shall be thoroughly dry before painting work is started.

2.2. Application of paint:

2.2.1. Brushing operations are to be adjusted to the spreading capacity advised by the manufacture of particular paint. The paint shall be applied evenly and smoothly by means of crossing and laying off. The crossing and laying off consists of covering the area over with paint, brushing the surface hard for the first time over and then brushing alternately in opposite directions two or three times and then finally brushing lightly in a direction at right angles to the same. In this process, no brush marks shall be left after the -laying off is finished. The full process of crossing and laying off will constitute one coat.

2.2.2. Each coat shall be allowed to dry completely and lightly rubbed with very fine grade of sand-paper and loose particles brushed off before next coat is applied. Each coat shall vary slightly in shade and shall be got approved from Engineer-in-charge before next coat is started.

2.2.3. Each coat the last shall be lightly rubbed down with sand paper of fine pumice stone and cleaned of dust before the next coat is applied. No hair marks from the brush of clogging of paint puddles in the corners of panels, angles of moldings etc. shall be left on the work.

2.2.4. Special care shall be taken while painting over bolts, nuts, rivets, overlaps etc. Approved best quality brushes shall be used.

3.0. Mode of measurements and payment

3.1. The relevant specifications of item No. 19.12 shall be followed for mode of measurements and payment. The rate is excluding priming coat.

3.4. The rate shall be for a unit of One sq. meter.

19.15. Extra over item No. 19.7 and 19.11 for every subsequent coat of paint.

1.0. Materials and Workmanship

1.1. The relevant specifications of item No. 19.7 shall be followed except that the work of painting shall be carried out for subsequent coat.

2.0. Mode of measurements and payment

2.1. The relevant specifications of item No. 19.7 shall be followed except that the extra rate shall be paid for every subsequent coat of paints applied over and above the rate of item No. 19.7 and 19.11.

2.2. The rate shall be for a unit of One sq. meter.

139

19.11. Painting one coats Excluding priming coat) on previously painted steel and other metal surface with enamel paint, brushing to give an even shade including cleaning the surface of all dirt, dust and other foreign matter.

1.0. Materials and Workmanship'

1.1. The relevant specification of item No 19.7 shall be followed except that painting shall be carried out in one coat with enamel paint on previously painted steel and metal surface.

2.0. Mode of measurements and payment

2.1. The relevant specifications of item No, 19.7 shall be followed.

2.2. The rate shall be for a unit of one sq. meter.

19.12. Applying priming coat over new steel and other metal surfaces after and including preparing the surface by thoroughly cleaning oil, grease, dirt and other foreign matter and secured with brushes, fine steel, wool scrapers and sand paper, with ready mixed priming paint, brushing red lead.

1.0. Materials

1.1. The ready mixed primer, brushing red shall conform to I.S. 102-1962.

1.2. The thinner (linseed oil) shall conform to I.S. 75-1973. If for any reason, thinning is necessary in case of ready mix paint the brand of thinner recommended by manufacture shall be used.

2.0. Workmanship

2.1. Preparation of surfaces : The surfaces painting shall be cleaned of all rust, scale, dirt and other foreign matter sticking to it with wire brushes, steel wool, scrapers, sand paper etc. This surface shall then be wiped finally with mineral turpentine which shall also remove grease and perspiration of hand marks. The surface shall then be allowed to dry.

2.2. Application of primer :

2.2.1. After the preparation of the surface, the priming coat shall be applied immediately. The brushing operations are to be adjusted to the spreading capacity advised by the manufacturer of the particular primer. The paint shall be applied evenly and smoothly by means of crossing and laying off. The crossing and laying off consists of covering the area over with paint, brushing alternately in opposite directions, two or three times and then finally brushing lightly in a direction at right angles to the same. In this process, no brush marks shall be left after the laying off is finished. The full process of crossing and laying off wall constitute one coat.

2.2.2. During painting, every time, after the priming coat has been worked out of the brush bristles or after the brush has been unloaded, the bristles of the brush shall be opened up by striking the brush against portion of the unpainted surface with the end of the bristles, held at right angles to the surface, so that bristles thereafter will collect the correct amount of paint when dipped again in to a paint container. The prima/y coat shall be allowed to dry completely before painting is started.

2.2.3. No hair marks from the brush or clogging at pain puddles in the corner of panels angles of molding etc. shall be left on the work

2.2.4. Special care shall be taken while painting over bolts, nuts, rivets, overlaps etc.

2.2.5. The container when not in use shall be kept close and free from air so that paint does not thickness and also shall be kept guarded from dust.

3.0. Mode of measurements & payment

3.1. The new steel and other metal surface shall be measured under this item.

3.2. All the work shall be measured net in the decimal system, as executed subject to the following limits unless otherwise stated hereinafter.

(a) Dimensions shall be measured to the nearest 0.01 meter.

(b) Areas shall be worked out to the nearest 0.01 sq. meter.

3.3. No deductions shall be made for openings not exceeding 0.5 sq. mt. each and no addition shall be made for painting to beddings, moldings, edges, jambs, soffits, sills etc. of such opening.

3.4. In case of fabricated structural steel and iron work, priming coat of paint shall be included with

140
frabation. In case of trusses if measured in sq. m. compound girders, stanchions, lattices, grader and similar work, actual area shall be measured in sq. m. and no extra shall be paid for painting on bolts heads, nuts, washers etc. No addition shall be made to the weight calculated for the purpose of measurements of steel and iron works for paint applied on shop or at site.

3.5. The different surfaces shall be grouped into one general item, areas of uneven surfaces being converted into equivalent plain areas in accordance with the table given as per Annexure-II for payment.

3.6. The rate shall be for a unit of One sq, meter.

19.19. Painting two coats (excluding priming coat) on new steel and other metal surfaces with synthetic enamel paints, brushing to give an even shade including cleaning the surface of all dirt, dust and other foreign matter.

1.0. Materials

Synthetic enamel paint shall conform to I.S. 1932-1964.

2.0. Workmanship

2.1. The relevant specifications of item No. 19.7 shall be followed except that the painting shall be carried out with synthetic enamel paint.

3.0. Mode of measurements & payment

3.1. The relevant specifications of item No. 19.7 shall be followed.

3.2. The rate shall be for a unit of One sq. meter.

19.21. Painting one coat (excluding priming coat) on previously painted steel and other metal surfaces with synthetic enamel paint brushing to give an even shade including cleaning the surface of all dirt, dust and other foreign matter.

1.0. Materials and Workmanship

2.1. The relevant specifications of item No. 19.19 shall be followed except that the painting shall be carried out on previously painted steel and other metal surfaces using synthetic enamel paint in one coat.

2.0. Mode of measurements and payment

2.1. The relevant specifications of item No. 19.19 shall be followed.

2.2. The rate shall be for a unit of One sq. meter.

19.13. Extra over item No. 19.19 and 19.21 for every subsequent coat of paint.

1.0. Materials and Workmanship

1.1. The relevant specifications of item No. 19.19 shall be followed except that the extra rate shall be paid for out for subsequent coat of point.

2.0. Mode of measurements & payment

2.1. The relevant specifications of item No. 19.19 shall be followed except-that the work shall be paid for applying subsequent coat of oil paint over and above the item No. 19.19 and 19.21.

19.50.(B) Painting two coat (excluding priming coat) on external of new rain water, soil, waste and vent pipe and fittings with ready mixed bituminous paint, brushing, black anticorrosive to give an even shade including cleaning of all dirt, dust and other foreign matter (75 mm. dia.)

1.0. Materials

1.1. Ready mixed bituminous pain shall conform to I.S. 158 : 1968.

2.0. Workmanship

2.1. The relevant specifications of item No. 19.7 shall be followed except that the paining work of external surfaces of 75 mm. dia rain water pipe, soil, waste, and vent pipe and fittings with ready mixed bituminous paint snail be earned out.

3.0. Mode of measurements and payment

3.1. The rate is excluding the cost o priming coat but including painting of all fittings coming in line.

3.2. The rate shall be for a unit of one running meter,

19.50.(C) Painting two coats (excluding priming coat) on external of rain water, soil, waste and vent pipe and fittings with ready mixed bituminous paint brushing black anticorrosive to give an even shade including cleaning off all dirt, dust and other foreign matter : 100 mm. dia.

141

1.0. Materials & Workmanship

1.1. The relevant specifications of item No. 19.50 (B) shall be followed except that the pipes to be painted on is 100 mm. dia. meter.

2.0. Mode of measurements & payment

2.1. The relevant specifications of item No. 19.50(B) shall be followed. The rate is excluding the cost of priming coat but including cost of painting all fittings coming in line.

2.2. The rate shall be for a unit of one running meter.

19.59.(B) Applying priming coat over wood and wood based surfaces after and including preparing the surface by thoroughly oil, grease, dirt and other foreign matter, sand papering and knotting : Ready mixed paint, brushing wood primer pink.

1.0. Materials

1.1. The ready mixed paint, brushing, wood primer pink shall conform to I.S. 3536-1966

2.0. Workmanship

2.1. Preparation of Surfaces :

2.2.1. AH wood work shall be dry and free from any foreign matter incidental to building operations. Nails shall be punched well below the surface to provide a film key for stopping. Moldings shall be carefully smoothed with abrasive paper and projecting fibers shall be removed. Flat portions shall be smoothed off with abrasive paper used across the grain prior to painting prior to painting and with the grain prior to staining or if the wood is to be left in its natural colour, wood work which is to be stained may be smoothed by scraping instead of by glass papering if so required.

2.2.2. Any knots, resinous, streaks or bluefish sap wood that are not large enough to justify cutting out shall be treated with two coats of pure shellac knotting applied thinly and extended about 25 mm. beyond the actual area requiring treatment.

2.2. Application of primer :

2.2.1. The relevant specifications of item No. 19.12(A) shall be followed for application of primer.

3.0. Mode of measurements & payment

3.1. The relevant specifications of item No. 19.12 shall be followed except that work done on wood and wood based surfaces shall be paid under this item.

3.2. The rate shall be for a unit of One sq. meter.

19.59.(D) Applying priming coat over new wood and wood based surface after and including preparing the surface by thoroughly cleaning oil, grease, dirt and other forging matter sand papering and knotting : Ready mixed paint brushing priming, for enamel.

1.0. Materials

1.1. The ready mixed paint for brushing priming for enamels wood shall conform to I.S. 106-1962.

2.0. Workmanship

2.1. The relevant specifications of item No. 19.59 (B) shall be followed except that ready mixed paint brushing priming for enamel shall be used instead of ready mixed paint brushing wood primer pink.

3.0. Mode of measurements and payment

3.1. The relevant specifications of item No. 19.12 shall be followed.

3.2. The rate shall be for a unit of One sq. meter.

19.62.(B) Extra over item 59.59 (B) for every subsequent coat of priming coat. Ready mix paint,

brushing wood primer work.

1.0. Materials and workmanship

1.1. The relevant specifications of item No. 19.59 (B) shall be followed except that the painting work shall be carried out with ready mix paint instead of wood primer pink for subsequent coat.

2.0. Mode of measurements and payment

2.1. The relevant specifications of item No. 19.59 (B) shall be followed except that the extra rate shall be paid for every subsequent coat applied with Ready mix paint, brushing wood primer pink over and above the rate of item No. 19.59 (B).

142

19.62.(D) Extra over item No. 19.59 for every subsequent coat of priming coat ready mix paint

brushing priming for enamel.

1.0. Materials & Workmanship

1.1. The relevant specifications of item No. 19.59(D) shall be followed except that the painting work shall be carried out with ready mix paint brushing priming for enamel.

2.0. Mode of measurements and payment

2.1. The relevant specifications of item No. 19.59(D) shall be followed except that the extra rate shall be paid for every subsequent coats of priming coat with ready mixed paint, brushing priming for enamel.

2.2. The rate shall be for a unit of One sq. meter.

19.71. Painting two coats (excluding priming coat) on new wood and wood based surfaces with enamel paint interior to give an even shade including the surface off all dirt, dust and other foreign matter and papering and stopping.

1.0. Materials

1.1. The enamel paint shall conform to I.S. 133-1975.

2.0. Workmanship

2.1. The relevant specifications of 19.7 shall be followed for general and application of paint, except that the enamel paint shall be used for painting on new wood/wood based surfaces.

2.2. In painting doors and windows, the putty, round the glass panes also be painted but care shall be taken to see that no paint, stain etc. are left on the glass. Top of shutters and surfaces in similar hidden locations shall not be left out in painting.

3.0. Mode of measurements and payment

3.1. The relevant specifications of item No. 19.12 shall be followed, for mode of measurements and payments. The rate excludes cost of priming coat.

3.2. The rate shall be for a unit One sq. meter.

19.73. Painting one coat (excluding priming coat) on previously painted wood and wood based surfaces with enamel paint to give even shade including cleaning of all dirt, dust and other foreign matter.

1.0. Materials and Workmanship

1.1. The relevant specifications of item No. 19.71 shall be followed except that the painting work shall be carried out on previously painted wood and wood based surfaces with enamel paint to give even shade in one coat.

2.0. Mode of measurements and payment

2.1. The relevant specifications of item No. 19.71 shall be followed

2.2. The rate shall be for a unit of One sq meter.

19.75. Extra over item 19.71 and 19.73 for every subsequent coat of paint.

1.0. Materials and Workmanship

1.1. The relevant specifications of item 19.71 shall be followed except that painting work shall be for subsequent coat with paint.

2.0. Mode of measurements and payment

2.1. The relevant specifications of item No. 13.71 shall be followed except that the extra rate shall be paid.

2.2. The rate shall be for a unit of One sq. meter.

19.77. Painting two coats (excluding priming coat) on new wood and wood based surfaces with ready mixed paint brushing, oil gloss, semi-gloss, to give an even shade including cleaning of all dust, dirt and other foreign matter sand papering and stopping.

1.0. Materials

The ready mixed paint shall conform to M-44. The ready mixed paint brushing gloss, semi-gloss shall conform to KS. 129-1962 and I.S. 117-1364.

2.0. Workmanship

2.1. The relevant specification of item 19.71 shall be followed for general and application of paint, except that ready mixed paint brushing, oil gloss and semi-gloss shall be used of approved colour and shade instead of enamel paint.

143

3.0. Mode of measurements and payment

3.1. The relevant specifications of item 19.12 shall be followed for measurements and payment. The rate excludes cost of priming coat.

3.2. The rate shall be for a unit of One sq. meter.

19.84. Varnishing two coats (excluding priming coat) on new wood and wood based surfaces undercoating with flattening varnish and finishing coat with varnish to give an even surface cleared of all dirt, dust and sand papering so as to produce a smooth dry surface.

1.0. Materials

The varnish shall conform to I.S. 338-1962.

2.0. Mode of measurements & payment

2.1.1. The surface to be varnished shall be prepared to produce a smooth, dry neat surface. The previous coat of paint, if any shall be allowed to dry and rubbed down slightly whipped off and allowed to dry.

2.1.2. The operation of varnishing calls for careful attention to cleanliness. All dust and dirt shall be removed from the surface to be varnished and also from the neighborhood. If surfaces are dampened to avoid razing of dust, they shall be allowed to dry thoroughly before varnishing is commenced. Damp Exposure to extreme of heat or cold, or to a damp atmosphere will spoil the work.

2.1.3. In handling and applying varnish care should be taken to avoid forming forth or air bubbles. Brushes and containers shall be kept scrupulously clean.

2.2. Application

2.2.1. The varnish shall be applied liberally with a brush and spread evenly over a portion of the surface with a short light strokes to avoid froth in. It shall be allowed to flow out while the next section is being laid in. Excess varnish then be scrapped out of the brush and the first section be crossed, re crossed and the laid of lightly. Too much or too little varnish left on the surface will mar the appearance of the finish. The varnish, once it has begun to set, shall not be retouched. If a mistake is made, the varnish shall be removed and the work started afresh.

2.2.2. In case of two coats of varnish work, the first shall be hard drying, under coating or flattening varnish, this shall be allowed to dry hard and then be flatted down before applying the finishing coat. If two coats are applied, sufficient time shall be allowed between two coats.

2.2.3. When flat varnish is used for finishing a preparatory coat of hard drying under coating or flattening varnish shall be first applied and shall be allowed to harden thoroughly, It shall then be lightly rubbed down before the flat varnish is applied. Section of the work such as panels, shall be cut in clearly, so as to avoid any overlapping during applications, as this is likely to impart some measure, of gloss to partially dried area, worked up in lapping. On larger area the flat varnish shall be applied rapidly and the edges of each patch applied shall not be allowed to set but shall be followed up whilst in free working conditions-

3.0. Mode of measurements & payment

3.1. The relevant specifications of item 19.71 shall be followed.

3.2. The rate shall be for a unit of One sq. meter.

13.86. Extra over item No. 19.84 for every subsequent coat of varnish.

1.0. Materials and Workmanship

1.1. The relevant specifications of item No. 19.84 shall be followed except that the work shall be for subsequent coat of varnishing.

2.0. Mode of measurements & payment

2.1. The relevant specifications of item 19.84 shall be followed except that the extra rate shall be paid for every subsequent coat of varnishing done over and above the rate of item No. 19.84.

2.2. The rate shall be for a unit of One sq. meter.

19.87. Polishing with polish on new wood and wood based surface to give an even surface including cleaning the surface of all dirt, dust and sand papered smooth and including a coat of wood filler

1.0. Materials

1.1. The French polish required tint and shade shall be prepared with the below mentioned ingredients and other necessary materials : (i) Chandra (ii) Shellac (ic) Pigment. The French polish so prepared shall conform to I.S. 348-1968.

144

2.0. Workmanship

2.1. Preparation of surface :

2.1.1. All unevenness shall be rubbed down to smoothness with sand paper and the surface shall be well dusted. The proper in the wood shall be filled up with a filler made of a paste of whiting in water or methylated spirit (with a suitable pigment like burnt sienna or umber if required) : otherwise the French polish will get absorbed and a good gloss will be difficult to obtain.

2.2. Application

2.2.1. A pad of wooden cloth covered by a fine cloth shall be used to apply the polish. The pad shall be moistened with polish and rubbed hard on the surface in a series of overlapping circles applying the polish sparingly but uniformly over the entire area to give an even surface. A trace of linseed oil on the face of the pad may be added which shall facilitate this operation. The surface shall be allowed to dry and the remaining coats applied in the same way. To finish off, the pad shall be covered with a fresh pieces of clean fine cloth, slightly dampened with methylated spirit and rubbed lightly and quickly with circular motions. The finished surface shall present a uniform texture and high gloss.

3.0. Mode of measurements and payment

3.1. The relevant specification of item 19.12 shall be followed for mode of measurements and payment.

3.2. The rate includes cost of wood filler etc. complete.

3.3. The rate shall be for a unit of One sq. meter.

19.88. Polishing with French polish on previously polished wood and wood based surface to give an even surface including cleaning the surface of all dirt, dust and sand papered smooth including a coat of wood filler.

1.0. Materials & Workmanship

1.1. The relevant specifications of item No. 19.87 shall be followed that the French polish shall be applied on previously polished wood and wood based surface.

2.0. Mode of measurements and payment

2.1. The relevant specifications of item No. 19.87 shall be followed.

2.2. The rate shall be for a unit of One sq. meter.

19.91. Applying wax polish on new Wood work and wood based surfaces with bees wax polish in proportion 2 : 1.5 : 1 : 0.5 (2 Bees Wax : 1.5 linseed oil: 1 Turpentine oil : 0.5 Varnish by weight) by give an surface including cleaning the surface of all dist, dust and sand papered smooth.

1.0. Materials

Bee's Wax shall conform to I.S. : 1504-1968. Linseed oil shall conform to I.S. : 75-1967. Turpentine shall conform to I.S. 83-1950. Varnish shall conform in I.S. 337-1952.

2.0. Workmanship

2.1. Preparation of bees wax :

2.1.1. In case of, bees wax it shall be prepared locally with following specification.

2.1.2. Pure bees wax free from paraffin on strain adulterants shall be used. The polish shall be prepared from mixture of bees wax, linseed oil, turpentine, and varnish in proportion 2:1:5:1:0.5 by weight. The bees wax and boiled linseed oil shall be heated of a slow fire, when the wax is completely dissolved the mixture shall be cooled till it is just warm and turpentine and varnish added to it in the required proportions and entire mixture shall be well stirred.

2.2. Preparation of surfaces .

2.2.1. The surface to be waxed shall he prepared to produce a smooth, dry, matt surface. Previous coat of paint of stain if any shall be allowed to dry and be rubbed down lightly wiped off and allowed to dry ail dust and dirt shall be removed from the surface to waxed and also from the neighborhood. Damp atmosphere and draughts shall be avoided, for waxing, normal dry day snail be chosen.

2.3. Application :

2.3.1. The polish shall be applied evenly with clean soft pad of cotton cloth in such a way that the surface is completely and fully covered. The surface shall then be rubbed continuously for half an hour After well rubbing in one coat of wax polish, the work shall be covered with dust proof sheet. (Cloth for preventing dust falling on the work). Subsequent coat shall be applied after the surface is quite dry arid shall be rubbed off with soft flannel until the surface has assumed a uniform gloss and in dry showing no sign of Stickiness.

145

2.3.2. The final polish depends on the amount of rubbing which shall be continuous and with uniform pressure with frequent changes in the direction.

3.0. Mode of measurements & payment

3.1. The relevant specifications of item No. 19.12 shall be followed.

3.2. The rate shall be for a unit of One sq. meter.

19.92. Applying wax polish on previous wax polished wood and wood based surfaces with bees wax polish in proportion of 2:1.5:1:0.5 (2 Bees wax 1.5 linseed oil : 1 Turpentine : 0.5 Varnish by weight) to give an even surface including cleaning the surface of all dirt, dust and sand papered smooth.

1.0. Materials and workmanship

1.1. The relevant specifications of item No. 19.91 shall be followed except that the wax polishing shall be carried out on previously wax polished wood and owed based surfaces with bees wax polish.

2.0. Mode of measurements and payment

2.1. The relevant specifications of item No. 19.91 shall be followed.

2.2. The rate shall be for a unit of One sq. meter.

19.98. Coat tarring two coats on new wood and wood based surfaces using 0.15 and 0.12 liters of coal tar per sq. m. in the first and second coat respectively to give an even shade including cleaning of all dirt, dust and other foreign matter ;

1.0. Material : The coal tar shall conform to I.S. 290-1961.

2.0. Workmanship

2.1. 200 cms. of unslaked lime shall be added to every liter of coat tar and heated till it begins to boil. It shall then be taken off the fire and kerosene oil added to it slowly the rate of 1 part kerosene old and 6 parts or more parts of coal tar by volume and stirred thoroughly. The addition of lime is for preventing the tar from running.

2.2. Preparation of Surface :

2.2.1. The surface to be painted shall be allowed to dry sufficiently. Any existing fungus or mould growth shall be completely removed. All major cracks or defects in the plaster shall be cut out and made good. Before primer is applied holes and undulations shall be filled up with plaster of parish and rubbed smooth.

2.3. Application of paint:

2.3.1. The coat tar shall be applied as per relevant specifications of applying mixed paint item No. 19.7 except coat tarring is used instead of enamel paint.

3.0. Mode of measurements & payment

3.1. The relevant specifications of item No. 19.12 shall be followed.

3.2. The rate shall be for a unit of One sq. meter.

19.119.(I) Writing letter of figures on any surface with black Japan paint (stops, comas, hyphens and the like not to be measured and paid for separately) : block (Letters/figures).

1.0. Materials

1.1. Ready mixed the black Japan paint shall conform to I.S. 341-1952.

2.0. Workmanship

2.1. The letters and figures shall be to the heights and widths as per approved drawings or as directed. These shall be stenciled or drawn in pencil and got approved before painting. They shall be of uniform size and finished neatly. The edges shall be straight or in pleasant smooth curves,

3.0. Mode of measurements and payment

3.1. Letters, figures and similar items etc. stops, commas, hyphens and the like shall be deemed to be included in the item. 9

3.2. The rate per cm. height of letter shall hold good irrespective of width of the letters of figures or the thickness of the lettering.

3.3. The rate shall be for a unit of per letter cm. height.

19.119(II) Writing letter of figure? on any surface with black Japan pain (stops, commas, hypes and the like not to be measured and paid for separately ; Indian (Letters/figures).

146

1.0. Materials and Workmanship

The relevant specifications of item No. 19.119 (I) shall be followed except the writing of letter shall be Indian letters/figures.

2.0. Mode of measurements and payment

2.1. The relevant specifications of item No. 19.119 (I) shall be followed.

2.2. The rate shall be for a unit of per letter per cm. height.

19.126(1) Painting lines, dashes, arrows, letters etc. on roads, airfields and like in two coats with road marking paint, brushing including cleaning the surface of all dirt, dust and other foreign matter : Over 10 cms. in width.

1.0. Materials

1.1. The road marking paint shall conform to. I.S. 164-1951.

2.0. Workmanship

2.1. The relevant specifications item No. 19.119(1) shall be followed except that the painting lines, dashes, arrows and letters on roads, air fields and like shall be carried out with road marking paint in two coats : over 10 cms. in width.

3.0. Mode of measurements and payment

3.1. The relevant specifications of item No. 19.119 (I) shall be followed.

3.2. The rate shall be for a unit of One sq. meter.

19.126.(II) Painting lines, dashes, arrows, letters etc. on roads, fields and like in two coats with road marking paint brushing including cleaning the surface of all dirt, dust and other foreign matter: Up to 10 cms. in width.

1.0. Materials and Workmanship

1.1. The relevant specifications of item No. 19.126 (I) shall be followed except that painting work shall be up to 10 cms. width.

2.0. Mode of measurements and payment

2.1. The relevant specifications of item No. 19.119 (I) shall be followed.

2.2. The rate shall be for a unit of one running meter.

19.127.(A) Painting lines, dashes, arrows letters etc. on roads, airfields, and like in one coat with road marking paint, brushing including cleaning the surface of all dirt, dust and other foreign matter : over 10 cms. in width.

1.0. Materials and workmanship

The relevant specifications of item No. 19.126(1) shall be followed except that the painting shall be done in one coat over 10 cms. in width.

2.0. Mode of measurement and payment

2.1. The relevant specifications of item No. 19.126 (I) shall be followed.

2.2. The rate shall be for a unit of One Sq. meter.

19.127. (B) Painting lines, dashes, arrows, letters etc. on roads, air fields and like in one coat with road marking paint, brushing including cleaning the surface of all dirt, dust and other foreign matter : Up to 10 cms. in width.

1.0. Materials and Workmanship

1.1. The relevant specifications of item No. 19.126 (I) shall be followed except that the painting shall be done in one coat upon 10 cms. in width.

2.0. Mode of measurements and payment

2.1. The relevant specifications of item No. 19.126 (I) shall be followed.

2.2. The rate shall be for a unit of one running meter.

SECTION-20

Demolition & Dismantling

20.1.(i) Demolition and disposal of unserviceable materials with all leads and lifts : Lime Concrete.

1.0. Workmanship

1.1. The demolition shall consist of demolition of one or more parts of the building as specified or shown in the drawings. Demolition implies taking up or down or breaking up. This shall consist of demolishing whole or part of work including all relevant items as specified or shown in the drawings.

1.2. The demolition shall always be planned before hand shall be done in reverse order to the one in which the

structure was constructed. This scheme shall be got approved from the Engineer-in-charge before starting the work. This however will not absolve the contractor from the responsibility of proper and safe demolition.

1.3. Necessary propping, shoring and under pinning shall be provided for the safety of the adjoining work or property, which is to be left intact, before dismantling and demolishing is taken up and the work shall be carried out in such a way that no damage is caused to the adjoining property.

1.4. Wherever required, temporary enclosures or partitions shall also be provided. Necessary precautions shall be taken to keep the dust nuisance down as and where necessary.

1.5. Dismantling shall be commenced in a systematic manner. All materials which are likely to be damaged by dropping from a height or demolishing roof, masonry etc. shall be carefully dismantled first. The dismantled articles shall be properly stacked as directed.

1.6. All materials obtained from demolition shall be the property of Government unless otherwise specified and shall be kept in safe custody until handed over to the Engineer-in-charge.

1.7. Any serviceable materials, obtained during dismantling or demolition shall be separated out and stacked properly as directed with all lead and lift. All unserviceable materials, rubbish etc., shall be stacked as directed' by the Engineer-in-charge.

1.8. On completion of work, the site shall be cleared of all debris rubbish and cleaned as directed.

2.0. Mode of measurements and payment

2.1. Measurements of all work except hidden work shall be taken before demolition or dismantling and no allowance for increase in bulk shall be allowed. The demolition of lime concrete shall be measured under this item. Specification for deduction for voids, openings etc. shall be on same basis as that employed for construction of work.

2.2. All work shall be measured in decimal system as fixed in its place subject to the following limits; unless otherwise stated hereinafter : (a) Dimensions shall be measured to the nearest 0.01 mt. (b) Area shall be worked out to the nearest 0.01 sq. mt.(c) Cubical contents shall be worked out to the nearest 0.01 Cu.m.

2.3. The rate shall include cost of all labour involved and tools used in demolishing and dismantling including scaffolding. The rate shall also include the charges for separating out and stacking the serviceable materials properly and disposing the unserviceable materials with all lead and lift. The rate also includes for temporary shoring for the safety of the portion not required to be pulled down or of adjoining property and providing temporary enclosures or portions where considered necessary.

2.4. The rate shall be for a unit of one cubic meter.

20.1.(i) Demolition and disposal of unserviceable materials with all leads and lifts : Un reinforced cement concrete.

1.0. Workmanship

The relevant specifications of item 20.1.(i) shall be followed except that the un reinforced cement concrete work is to be demolished instead of lime concrete.

2.0. Mode of measurements and payment

2.1. The relevant specifications of item 20.1(i) shall be followed.

2.2. The rate shall be for a unit of one cubic meter.

20.3. Demolition including of serviceable materials and disposal of unserviceable materials with all leads and lifts : R.C.C. work.

1.0. Workmanship

1.1. The relevant specifications of item 20.1 (i) shall be followed except that demolition of R.C.C. work is to be done.

148

2.0. Mode of measurements and payment

2.1. The relevant specifications of item 20.(i) shall be followed except that the demolition of reinforced concrete structure is to be done. The unserviceable materials shall be disposed of at all leads and lifts. The rate excludes scraping straightening of reinforcement but includes cutting of reinforcement.

2.2. The rate shall be for a unit of one cubic meter.

20.11 (ii) Demolition of brick work and stone masonry including stacking of serviceable materials and disposal of unserviceable materials with all leads and lift : in lime mortar.

1.0. Workmanship

1.1. The relevant specifications of item No. 20.1.(i) shall be followed except that demolition of brick or stone masonry in lime mortar is to be done.

2.0. Mode of measurements and payment

2.1. The relevant specifications of item No. 20.1(i) shall be followed except that the wall and independent piers or columns of brick or stone masonry shall be measured in cubic meters. All copings, corbels, combs and other projections shall be included with the wall measurements.

2.2. In measuring thickness of plastered walls, the thickness of plaster shall be included. The unserviceable materials shall be disposed off with all lead and lift. Ashlars face stones dressed stone etc., if required to be taken down intact shall be dismantled and measured separately in cubic meters.

2.3. The rate is exclusive of cleaning of bricks or stones. Honey comb works or hollow block walling shall be measured as solid.

2.4. The rate shall be for a unit of one cubic meter.

20.11. (iii) Demolition of brick work and stone masonry including stacking of serviceable materials and disposal of unserviceable materials with all leads and lift : in cement mortar.

1.0. Workmanship

1.1. The relevant specifications of item 20.1.(i) shall be followed except demolition of brick or stone masonry in

cement mortar is to be done.

2.0. Mode measurements and payment

2.1. The relevant specifications of item 20.11 (ii) shall be followed. The unserviceable materials shall be stacked as directed by Engineer-in-charge with all leads and lifts.

20.22. Demolition in terrace including stacking or serviceable materials and disposal of unserviceable materials with all lead and lift : Brick tiles covering.

1.0. Materials

1.1. The relevant specifications of item No. 20.1 (i) shall be followed except that the demolition of terrace brick tiles is to be done.

2.0. Mode of measurements and payment

2.1. The relevant specifications of item No'. 20.1(i) shall be followed except that the brick tiles covering of terrace shall be measured in sq. mt. The unserviceable materials shall be stacked as directed at all leads and lifts.

2.2. The rate shall be for a unit of one sq. meter.

20.23. Dismantling tiled or stone floors laid in mortar including stacking of serviceable materials and disposal of unserviceable materials with all lead and lifts.

1.0. Workmanship

1.1. The relevant specification of item 20.1 (i) shall be followed except the dismantling of tiled or stone floors laid on mortar shall be done. Dismantling implies carefully taking up or down or removing without ^ damage. The articles shall be passed by hand where necessary and lowered and where these are fixed by nail, screws, bolts etc., these shall be taken out with proper tools.

2.0. Mode of measurements and payment

2.1. The supporting materials such as joints, beams if any etc. shall be measured separately. The relevant specifications of item No. 20.1 (i) shall be followed, The rate shall include staking the unserviceable materials as directed with all lead and lift.

2.2. The late shall be for a unit of one sq. meter.

20.25. Dismantling of wooden floors, including, stacking of serviceable materials and disposal of unserviceable materials with all lead and lifts.

149

1.0. Materials

1.1. The specifications of item 20.1(i) shall be followed except that wooden floors shall be dismantled.

2.0. Mode of measurements and payment

2.1. The relevant specifications of item 20.1 (i) same shall be followed. The supporting members such as joints, beams etc. shall be measured separately. The rate shall include disposal of unserviceable materials as directed for and with all lead and lift.

2.2. The rate shall be for a unit of one sq. meter.

20.27.(i) Dismantling of sheet including ridges, hips, valleys gutters etc. stacking of serviceable materials and disposal of unserviceable materials with leads with lifts : G.I. sheet roofing.

1.0. Materials

1.1. The relevant specifications of item 20.1.(i) shall be followed except that G.I. sheet roofing shall be dismantled instead of concrete work.

2.0. Mode of measurements and payment

2.1. The area of G.I. sheets roofing shall be measured in sq. meter. Ridges, hips and valleys shall be girded and included with roof area. Corrugated and semi-corrugated surfaces shall be measured flat and not girthed.

2.2. Supporting members such as rafters, purlins, beams, joints, trusses etc. shall be measured separately.

2.3. The rate shall include disposal of unserviceable materials with all leads and lifts and stacking the serviceable materials as directed.

2.4. The rate shall be for a unit of one sq. meter.

20.27 (ii) Dismantling of sheet roofing including ridges, hips, valleys gutters etc. stacking of serviceable materials and disposal of unserviceable materials with all leads and lifts : A.C. Sheet roofing.

1.0. Workmanship

1.1. The relevant specifications of item 20.27 (i) shall be followed except that dismantling work of A.C. sheet roofing is to be done.

2.0. Mode of measurements & payment

2.1. The relevant specifications of item 20.27 (i) shall be followed except that the A.C. sheets .roofing shall be measured in this item.

2.2. The rate shall be for a unit of one sq. meter.

20.28. Dismantling Manglore or country tile roofing with battens, boarding etc. including stacking of serviceable materials and disposal of unserviceable materials with all lead and lifts.

1.0. Workmanship

1.1. The relevant specifications of item 20.1 (i) shall be followed except that the country tile roof or Mangalore roof shall be dismantled.

2.0. Mode of measurements and payment

2.1. The relevant specifications of item 20.1 (1) shall be followed.

2.2. The supporting members shall be measured separate item.

2.3. The rate includes labour required for disposal of unserviceable item with ail leads and lifts.

2.4. The rate shall be for a unit of one sq. meter.

20.30. Dismantling cement asbestos/hard board in ceiling or partition walls, wooden trellis work including frames, stacking of to serviceable material and disposal of unserviceable materials with all leads and lifts.

1.0. Workmanship

1.1. The relevant specifications of item 20.1 (i) shall be followed except that the cement asbestos hard board in ceiling or partition walls, wooden trellis, work etc. shall be dismantled.

2.0. Mode of measurements and payment

2.1. The relevant specifications of item 20.1 (i) shall be followed. The serviceable materials shall be stacked as and where directed and the unserviceable materials shall be disposed off with leads and lifts.

2.2. The rate shall be for a unit of one sq. meter.

20.35 Dismantling wood wrought, framed and fixed in frames, trusses including stacking the materials with all lead and lift.

150

1.0. Workmanship

1.1. The relevant specifications of item No. 20.1 (i) shall be followed except that the wood work, wrought framed and fixed in frames, trusses etc. shall be dismantled.

2.0. Mode of measurements and payment

2.1. The relevant specifications of item No. 20.1 (i) shall be followed.

2.2. The materials shall be stacked as and where directed with all leads and lifts.

2.3. The rate shall be for a unit of one cubic meter.

20.39. Dismantling expanded metal or I.R.C. fabric with necessary battens and beading including frame work and stacking the serviceable materials with all lead and lift.

1.0. Workmanship

The relevant specifications of item No. 20.1 (i) shall be followed except that the dismantling of expanded metal or I.R.C. fabric shall be done

2.0. Mode of measurements & payment

2.1. The relevant specifications of in item No. 20.1 (i) shall be followed.

2.2. The rate shall be for a unit of one sq. meter.

20.43. Dismantling steel work including dismembering and stacking the materials with air leads and lifts.

1.0. Materials

1.1. The relevant specifications of item No. 20.1 (i) shall be followed except that the dismantling of steel work shall be carried out.

2.0. Mode of measurements and payment

2.1. The relevant specifications of item No. 20.1 (i) shall be followed.

2.2. The weight of the member shall be computed from standard table unless the actual weight can be readily determined.

2.3. Riveted works where rivets are required to be cut. the same shall be carried out under this item and nothing extra shall be paid.

2.4. In framed still gate, the weight of any covering material or filling such as iron sheets and expanded metal shall be added to the weight of the main articles if such covering is not ordered to be taken out separately.

2.5. The rate includes stacking the materials as and where directed with all leads and lifts.

2.6. The rate shall be for a unit of one Kg.

20.49.(i) Dismantling doors, windows, ventilators etc. (wood or steel) shutters including chowkhats, Architraves, hold fasts and other attachments etc. complete and stacking them within all leads & lift. No exceeding 3 sq. meters in area.

1.0. Workmanship

The relevant specifications of item No. 20.1 (i) shall be followed except that the door, windows, ventilators etc. (wood or steel) shutters including chowkhats, architraves, hold fasts and other attachments etc. are to be dismantled.

2.0. Mode of measurements & payment

2.1. The relevant specifications of item No. 20.1 (i) shall be followed.

2.2. The doors, windows, ventilator etc. not exceeding 3 sq. mt. in area (each) including shutters and chowkhats. Architraves, hold fasts and other attachments to frames etc. will be dismantled and measured under this item.

2.3. The rate includes stacking the serviceable materials as and where directed with all leads and lifts.

2.4. The rate shall be for a unit of One number.

20.49.(II) Dismantling doors, windows, ventilators etc. (wood or steel) shutters including chowkhats. Architraves, hold fasts and other attachments etc. complete and stacking them within all leads and lift : Exceeding 3 sq. meters in area.

1.0. Workmanship

The relevant specifications of item No. 20.49(I) shall be followed except that the area of doors, windows, ventilators, exceeding 3 sq. meters are to be dismantled under this item.

151

2.0. Mode of measurements of payment

2.1. The relevant specifications of item No. 20.49 (I) above shall be followed.

2.2. The rate shall be for a unit of One number.

20.51. Dismantling barber wire fencing including making rolls and also including dismantling facing posts including all earth work, concrete in the base and making good the disturbed ground

stacking useful materials as directed and disposing all the unserviceable materials with all leads and lifts.

1.0. Workmanship

The relevant specifications of item No. 20.1 (i) shall be followed, except that the dismantling of barbed wire fencing shall be carried out.

2.0. Mode of measurements & payment

2.1. The relevant specifications of item No. 20.1. (i) shall be followed.

2.2. The rate includes making rolls of dismantled wires and including dismantling fencing posts, concrete work, in base and making good the disturbed ground etc. complete.

2.3. The serviceable materials shall be stacked as and where directed and end unserviceable materials shall be disposed with all leads and lifts.

2.4. The rate shall be for a unit of One running meter.

20.56. Dismantling (C.I. Pipes, G.S.W. Pipes and A.C. rain water pipes with fittings and clamps, including stacking the materials with all lead and lift, (for any dia. of pipe).

1.0. Workmanship

The relevant specifications of item No. 20.23 shall be followed except that the dismantling work of pipes lines of C.I., G.S.W. & A.C. Pipes with fitting shall be carried out.

2.0. Mode of measurements and payment

2.1. The relevant specifications of No. 20.1 (i) shall be followed.

2.2. Water pipe lines, including rain water pipes, with clamps and specials, swear pipe lines, (Salt glazed ware or concrete) etc. shall be measured in running meter inclusive of joints. (The measurements shall be taken along the centre line of pipe and fittings).

2.3. The rate shall be for a unit of One running meter.

20.00.I. Dismantling sanitary fittings like wash basin, W.C. Pan, Indian & European Type flushing tank, etc. including stacking the materials with all lead lift.

1.0. Workmanship

The relevant specifications of item No. 23.23 shall be followed except that the dismantling work of sanitary fittings such as wash basin, W.C. Pan (all type of pans), Flushing tanks etc. shall be carried out.

2.0. Mode of measurements & payment

2.1. The relevant specifications of item No. 20.1 (i) shall be followed.

2.2. The rate shall be for a unit of one number.

20.00.2. Scraping oil paint steel and other metal surfaces and making the surface even (with hand scraping).

1.0. Workmanship

The old paint from steel and other surface shall be scraped thoroughly with hand scraper followed by wire brushing (first with coarse and then with fine brushes) and finally sand papering with coarse and paper (No.3) steel wood (No.2) or emery paper (No.3) or with emery clothes. This shall then be wiped finally with mineral turpentine to remove grease and perspiration of hand marks etc. and allowed to dry. The surface shall be made even and smooth.

2.0. Mode of measurements and payment

2.1. The work shall be measured in actual area of work done.

2.2. The rate shall be for a unit of one sq. meter.

152

SECTION-21

Repairs to Buildings

21.8. Providing and fixing M.S. fan clamps of shape and size as specified in existing R.C.C. slab including cutting chase and making good.

1.0. Materials

1.1. M.S. Bar shall conform to M-18.

2.0. Workmanship

2.1. The shape and size of fan clamp shall be directed!

2.2. The fixing M.S. fan clamp in existing R.C.C. slab a chase of size 150 mm. x 75 mm. shall be cut from the ceiling so as to expose the reinforcement and up to 25 mm. clear round the reinforcement bar. This shall be done without any damage to adjoining portion of ceiling. The two arms of the ends of the clamp shall be passed through the space over reinforcement bar from the bottom of the slab. Then the two arms shall be bent down about 15 mm. by means of crow bar. The clamp shall be held in position and the chase in ceiling filled with cement concrete 1:2:4 (1 cement : 2 coarse sand : 4 graded stone aggregate 20 mm. nominal size). The ceiling shall be then finished to match the existing surface and properly cured.

3.0. Mode of measurements and payment

3.1. The rate includes cost of all materials and labour required for satisfactory completion of this item as described above.

3.2. The rate shall be for a unit of One number.

21.23. Cutting our cracks, of roof terrace to V. section, Cleaning out, wetting, grouting with cement and sand slurry 1:3 (1 cement : 3 sand)

1.0. Materials

(1) Water shall conform to M-1. (2) Cement shall conform to M-3. (3) Sand shall conform to M-6.

2.0. Workmanship

2.1. The cracks shall be cleaned out and trimmed to V shaped cuts at least 6 mm wide on top. The cracks shall be cleaned off and then cracks shall be thoroughly flooded with water, water allowed to a soak in cracks, and then grouted with cement and sand slurry in proportion 1:3. The required cracks shall be cured at least 7 days.

3.0. Mode of measurements and payment

3.1. The rate shall include cost of all materials and labour required for satisfactory completion of item as described above.

3.2. The rate shall be for a unit of One running meter.

21.24. Cutting out cracks of roof terrace to V-Section out, and filling solidly with a hot mixtures of bitumen and clean dry sand (1:1 weight).

1.0. Materials

(1) Bitumen shall be 85/25 penetration (2) Sand shall conform to M-6.

2.0. Workmanship

2.1. The relevant specifications of item No. 21.23 shall be followed for opening cracks and cleaning.

2.2. The cracks shall be absolutely dried and cleaned and filled solidly with a hot mixtures of 85/25 penetration and sand in ratio of 1; 1 by weight. The filler shall be well filled into cracks with the edges of a trowel and left flush with surface of roof. Repaired cracks shall cause no ridges the direction of the slope of roof.

3.0. Mode of measurements & payment

3.1. The relevant specifications of item No. 21.23 shall be followed.

3.2. The rate shall be for a unit of One running meter.

153

SECTION-22

Misc. Building Items

22.20. Providing and fixing 1.20 meter fencing with 2 meter long M.S. angle posts 40 mm. x 40 mm. x 6 mm. and oil painting 3 coats fixed at 2.5 M C/C with five horizontal lines, and two diagonals of galvanised steel barbed wire weighing 9.38 Kg. per 100 meter. (Min.) stained and fixed to posts with G.I. staples including fixing the posts in ground with 0.5 x 0.5 x 0.5 M block in C.C. 1:5:10 (cement : 5 sand : 10 graded brick aggregate 40 mm. nominal size) etc. complete.

1.0. Materials

(1) Water shall conform to M-1. (2) Cement shall conform to M-3. (3) Sand shall conform to M-6. (4) Brick bats aggregate shall conform to M-14, (5) Oil paint shall conform to M-44. (6) Barbed wire shall conform to M-78.

2.0. Workmanship

2.1. The pits of the size 0.5 x 0.5 m. x 0.5 shall first be excavated, true to line and level to receive the post at 2.5 C/ C. The relevant specifications of item 4.00.1 shall be followed for excavation work.

2.2. The pits shall be filled with a layer 0.15 m. thick with lean concrete 1:5:10 (1 cement: 5 sand : 10 graded brick bat aggregate 40 mm. nominal size). The M.S. angles 40 mm. x 40 mm. x 6 mm shall be filled in with lean concrete 1:5:10 and rammed properly so as to form total 0.5 m. x 0.5 m. x 0.5 m, concrete block. The concrete shall be cured for 7 days to allow it to set.

2.3. The barbed wire shall be stretched and fixed in 5 horizontal rows and two diagonals. The bottom row shall be 140 mm. above ground and the rest at 125 mm. centre to centre. The diagonal shall be stretched between adjacent post from top wire of one post to the bottom wire of 2nd post. The wires shall be fixed to posts by means of staples. The M.S. Angle posts shall be painted with 3 coats of old paint of approved tint and shade.

3.0. Mode of measurements and payment

3.1. The work shall be measured for the finished work from centre to centre of the posts.

3.2. The rate shall include the cost of labour and materials involved in the operations described above.

3.3. The rate shall be for a unit of One running meter.

22.00.1. Construction of B.B. masonry paniara 23 cm x 75 mm wall including fixing pre cast R.C.C. marble Mosaic (Terrazzo) slab of 75 mm. thickness on top and smooth finishing to walls in cement plaster in C.M. 1:3 curing etc. complete including drainage out, waste water arrangements.

1.0. Materials

(1) Water shall conform to M-1. (2) Cement shall conform to M-3. (3) Sand shall conform to M-6. (4) Brunt bricks shall conform to M-15. (5) Pre cast marble mosaic terrazzo paniara of 75 mm thickness shall be of best quality. The width of paniara shall be directed. .

2.0. Workmanship

2.1. The brick masonry shall be constructed for paniara for the size as directed in C.M. 1 :6. The thickness of wall shall be 23 cms. thick and height shall be 75 cms. The relevant specifications of B.B. masonry at item 6.13 (b) shall be followed for B.B. masonry work.

2.2. The B.B. masonry shall be covered with pre cast marble terrazzo paniara at top, of width and length as specified or as directed. The terrazzo mosaic paniara shall be 75 mm, thickness.

2.3. The whole masonry work shall be finished smooth with C.M. 1:3 on both sides the relevant specifications of item No. 1.7.59 (l) shall be followed.

2.4. The drainage outlet and water arrangement shall be made as directed.

3.0. Mod& of measurements and payment

3.1. The work shall be measured for the finished work.

3.2. The rate shall be include the cost of labour and materials involved in the operations described above.

3.3. The rate shall be for a unit of One Running meter.

22.00.2. Constructing a chowkadi with C.Q. over 12 cm. thick B.B. masonry in front and dwarf wall 1 M high and 23 cms. thick cement plaster to masonry in C.M. (1:3) and cement concrete flooring in 1:2:4 with 5 cm. dia. A.C. Drain pipe etc. complete

1.0. Materials

1.1. Water shall conform to M-1. Cement shall conform to M-3. Sand shall conform to M-6. Burnt bricks shall conform to M-15. Stone aggregate 20 mm. nominal size shall conform to M-2. (a) A.C. Drain pipe of 5 cms. dia shall conform to M-74.

154

2.0. Workmanship

2.1. The chowkadi shall be constructed of specified size and as directed. The slab shall be cast on B.B. masonry wall 12 cms. thick and dwarf wall 1 M high and 23 cms, thick shall be constructed in proportion of C.M. 1:6. The relevant specifications of item 6.3. (I) shall be followed for masonry partition work and 5.4.1. (c) shall be followed for reinforced concrete work.

2.2. The whole masonry work shall be finished with cement mortar 1:3 and finished smooth. The relevant specifications of item No. 17.59 (I) shall be followed for plastering work,.

2.3. The A.C. pipe of 5 cms. dia shall be fixed as drainage pipe. The bottom shall be finished with C.C. 1:2:4 finished with cement slurry.

3.0. Mode of measurements and payment

3.1. The work shall be measured for finished work.

3.2. The rate includes cost of all materials, labour etc. required for carrying out satisfactory completion of work.

3.3. The rate shall be for a unit of one square meter.

22.00.3.(I) Constructing cooking platform 60 cm. width and 70 cm. height resting on B.B. Masonry wall 23 cms. thick in C.M. 1:6 with fixing of pre cast 1:2:4. R.C.C. 0.0 M. thick slab with marble mosaic chips set in GM. (Terrazzo) with plastering on exposed faces to wall in C.M. 1:4 etc. complete.

1.0. Materials

Water shall conform to M-1. Cement shall conform to M-3. Sand shall conform to M-6. Burnt brick shall conform to M-15. Marble Mosaic chips shall conform to M-46. Stone aggregate 20 mm. nominal size shall conform to M-12. (a) M.S. Bars shall conform to M-18.

2.0. Workmanship

2.1. The cooking platform of size as directed shall be constructed in 60 cms. width and 70 cms. height. The brick masonry wall, in C.M. 1 :6 shall be constructed in 23 cms. thickness up to full depth. The relevant specifications of item 6.13 (B) shall be followed for masonry work.

2.2. The R.C.C. slab of 8 cms. thickness and of adequate design and size shall be precast and the same shall be put up on the B.B. masonry work.

2.3. The top and exposed sides of the R.C.C. slab shall be finished with marble mosaic terrazzo 8 mm. thick with required colour pigment. The work of terrazzo shall be carried out as per relevant specifications of item 14.4 (E).

2.4. The whole masonry work shall be finished with cement mortar in C.M. 1 :4. The relevant specification of item 17.59 (II) shall be followed.

3.0. Mode of measurements and payments

3.1. The work of cooking platform shall be measured for finished work.

3.2. The rate includes cost of all labour and materials, etc. required for satisfactory completion of this item as described above.

3.3. The rate shall be for a unit of One running meter.

22.00.3.(II) Constructing cooking platform of 60 cm. width and 70 cms. height resting on B.B. masonry walls 23 cm thick in C.M. 1:1 with fixing black kadapa stone surface laid on pre cast R.C.C. slab 1:2:4 with plastering on exposed faces to wall in C.M. 1:4 etc. complete.

1.0. Materials and Workmanship

1.1. The relevant specification of item No. 22.00.3 (I) shall be followed except that the cooking platform shall be constructed by providing black kadapa stone of 25 mm. to 30 mm. thickness on pre cast R.C.C. 1:2:4 slab 8 cms. thick. The black stone shall be provided in single piece up to 1.8 M in length and specified width. All the exposed edges of stone shall be machine cut.

2.0. Mode of measurement and payment

2.1. The relevant specifications of item 22.00.3.(I) shall be followed.

2.2. The rate includes providing machine cut edges on exposed face of kadapa stone.

2.3. The rate shall be for a unit of One running meter.

22.00.4. Providing and fixing Rajula stone 75 mm. thick 60 cm x 45 cms. size including fixing in cement mortar as directed.

1.0. Materials

Water shall conform to M-1. Cement mortar shall conform to M-11. Rajula stone of specified, size shall be of best quality and free from any defects. The stone shall not be less than 75 mm in thickness.

155

2.0. Workmanship

2.1. The Rajula stone of size 60 x 45 cms. size shall be fixed as and where directed in cement mortar in 1:3. All the edges of the stone shall be fixed with cement mortar in C.M. 1:3 and sloped at 45° and finished smooth. The work shall be cured for 7 days after fixing.

3.0. Mode of measurements and payment

3.1. The work shall be measured for finished work.

3.2. The rate includes cost of all labour and materials required for satisfactory completion of this item.

3.3. The rate shall be for a unit of one number.

22.00.5. Providing and laying Bilimora type brick facing in C.M. 1:1 laid over bedding of cement mortar 1:3 (13 mm. thickness) including cleaning, watering, scaffolding etc. complete.

1.0. Materials

1.1. Water shall conform to M-1. Cement mortar of specified proportion shall conform to M-11. Bilimora type bricks shall be approved before collection the same on site.

2.0. Workmanship

2.1. The surface on which the Bilimora type bricks is to be provided shall be cleaned of all dust, dirt, etc. and finished with CM 1:3 in 13 mm, thickness. The relevant specifications of item 17.59 (l) shall be followed except that the thickness of finishing shall be 13 mm. The top surface shall be roughened by wire brushes to give proper grip to the tiles to be fixed.

2.2. The Bilimora type bricks shall be fixed with CM 1:1. The tiles shall be properly wetted before fixing. The horizontal and vertical joints shall be maintained in true line and level by providing 12 mm or 20 mm. sq. bars as directed. The tiles shall be tamped by trowel so that there shall not be any hollows left behind the tiles.

2.3. The tiles shall be cut to the required size on ends of at top bottom of beams in best workman like manner.

2.4. The whole work shall be cured for 7 days.

3.0. Mode of measurements and payment

3.1. The work shall be measured as per relevant specification of item No. 17.58(1)

3.2. The rate includes cost of all materials, wastage etc. occurring due to cutting of tiles and ends as top and bottom of beams etc. including base coat.

3.3. The rate shall be for unit of One sq. meter.

22.00.6. Providing and fixing teakwood rail of 60 mm. x 20 mm. size and 50 cms. length incl. 3 coats of oil paint to wood work with set of 3 pegs.

1.0. **Materials** : Teak wood battens of specified size shall conform to M-29. Oil paint shall conform to M-44. Wall pegs of aluminum 3 Nos. of approved quality and make shall be provided.

2.0. Workmanship

2.1. The teakwood battens of size 60 mm. x 20 mm. and 50 cms. long be planed on all sides. The anodized aluminum wall pegs of approved 'make shall be fixed on wooden batten prepared with screws as directed. The wall pegs unit shall be fixed on wall with wooden gut ties and screws as directed. The wooden battens shall be painted with 3 coats of ready mix paint of approved colour and shade.

3.0. Mode of measurements and payment

3.1. The work shall be measured for finished work.

3.2. The rate shall be for a unit of one number.

22.00.7. Treating the bottom and sides (up to a height of 300 mm.) of the excavations made for the masonry foundations and basement with chemical emulsion at the rate of 5 liters per Sq. meter of the surface area.

1.0. **Materials** : The chemicals used for the soil treatment shall be only one of the following with concentration shown against each in aqueous emulsion.

Chemicals Concentration

1. Aldrin 0.50% (by weight)
2. Heptachlor 0.50% (by weight)
3. Chlordane 1.00% (by weight)

156

2.0. Workmanship

2.1. The chemicals barrier shall be complete and continuous under whole of the structure to be protected.

2.2. The bottom and the sides of foundations up to a height of 30 cms. from the bottom of excavation made for masonry foundation and for basement column pits shall be treated with the chemical emulsion at the rate 5 liters/ sq. meter of the surface area. .

2.3. The chemical treatment shall be-carried out when the surfaces is quite dry. Chemical treatment shall not be carried out when it is raining or when the soil wet with rain or sub soil water.

2.4. Once formed, treated soil barriers shall be not disturbed. If by chance, treated soil barriers are disturbed, immediate steps shall be taken to restore the continuing and compactness of the barrier system

2.5. The treatment against termite infection shall remain fully effective for a period not less than 10 years from date of issue of the final certificate to completion of work. If at any time during this period, any defects in treatment are revealed or any evidence of infection in any part of the building or structure is noticed, the contractor shall be rectify the concerned defects within 14 days on receipt of notice from Engineer-in-charge. On contractor's failure to do so, the Engineer-in-charge may get the same rectified through any other agency at contractor's risk and cost, and decision of Engineer-in-charge as to the cost payable by contractor for the same shall be final and binding to the contractor.

2.6. A guarantee bond on appropriately stamped paper shall be given by the contractor to the department in the manner and form prescribed below:

FORM OF GUARANTEE BOND

I/We..... (Contractor) hereby guarantee that work will remain unaffected and will not be any way damaged by termite or any other germs of similar types, for a period for 10 years after completion of the work of anti-termite as per the terms and conditions of the contract and or damage

that might be caused on account of termite and or other similar type of germs and hereby Guarantees to make good any loss of damages suffered by the Government of Gujarat and further guarantee to redo effective work without claiming any extra cost.

2.7. This guarantee shall remain in force for the period of 10 years from the completion of the work under the contract and it shall remain binding to the contractor for period of 10 years.

2.8. The deposit at the rate of 50% of the cost of this item from the running and final bills shall be recovered and retained for the first one year after completion of the work and 10% shall be retained for the balance of guarantee period and shall be refunded only after the completion of the guarantee period.

3.0. Mode of measurements & payment

3.1. The length and breadth shall be measured correct to a cm. as per the dimensions of sanctioned plans. No deduction shall be made nor extra paid for any opening for pipes etc. up to 0.1 sq. mt. The rate shall include the cost of all labour and materials required for the operation involved for satisfactory completion of this item. The sides of the trenches 30 cms, each side and bottom shall be measured under this item.

3.2. The rate shall be for a unit of One sq. meter.

22.00.8. Treating the backfill immediately in contact with foundation structure with chemical emulsion at the rate 7.5 liters per sq. mt. of vertical surface of the sub structure of each side (In case of R.C.C. columns, beams and R.C.C. basement walls, treating the sides of 50 cms. from ground level with chemical emulsion at the rate of 7.5 Liters/sq. meter).

1.0. Materials

1.1. The specifications of the item 22.00.7. shall be followed.

2.0. Workmanship

2.1. After masonry foundations and retaining walls of basement come up , the backfill immediate in contact with foundation shall be treated with the chemical emulsion at the rate of 7.5 liters per sq. m. of the vertical surface of the sub structure for each side. The filling of earth is usually carried out in layers and the treatment shall be directed towards the concrete or masonry surfaces of the columns and walls so that the earth contact with these surfaces is well treated with chemical.

2.2. In case of R.C.C. framed structure with columns and plinth beams and R.C.C. basements the treatments shall start at the depth of 50 cms. below ground level from this depth backfill around the columns, beams, and R.C.C. basement walls shall be treated at 7.5 lit/sq. m. of vertical surface. The relevant specifications shall be followed same as item 22.00.7.

3.0. Mode of measurements and payment

3.1. The area of substructure in contact with backfill to be measured. The length and breadth shall be measured correct to a cm. dimension of sanctioned plans for the surfaces in contact with backfill.

157

3.2. No deduction shall be made nor extra paid for any opening for pipes, etc. up to 0.1 sq. m.

3.3. The rate includes cost of all labour, materials required for satisfactory completion of this item.

3.4. The rate shall be for a unit of One sq. meter.,

22.00.9. Treating the top surface of the plinth filling with chemical emulsion at rate of 5 liters sq. meter, before the sand bed or sub grade is laid.

1.0. Materials : The relevant specifications of item 22.00.7. shall be followed.

2.0. Workmanship

2.1. The relevant specifications of item 22.00.7 shall be followed that the top surface of the consolidated earth within the walls, shall be treated with the chemical emulsion at the rate of 5 liters/sq. metre of the surface before the sand bed or sub-grade is laid. If the filled earth has been well rammed and the surface does not allow the emulsion to seep through, holes up to 50 to 75 mm. deep at 150 mm. centers both ways may be made with 12 mm. dia. M.S. rod on the surface to facilitate absorption of the emulsion.

3.0. Mode of measurements & payment

3.1. The length and breadth shall be measured clean for the area actually treated.

3.2. No deduction shall be made nor extra paid for any opening for pipes, etc. up to 0.1 sq. m.

3.2. The rate shall be for a unit of One sq. meter.

22.00.10. Treating the junctions of wall and floor area with chemical emulsion at the rate of 7.5 liter/sq. mt. by making holes at junction of walls, and columns, with the floor before laying sub grade to a depth to 15 cms. by making holes.

1.0. Materials : The relevant specifications of item 22.00.7 shall be followed,

2.0. Workmanship

2.1. The relevant specifications of item 22.00.7 shall be followed except that the junction of walls columns with floor shall be treated with the chemical emulsion at the rate 7.5 liters/sq. meter. Special care shall be taken to establish continuity of the vertical chemical barrier on inner wall surface from the ground level be taken to establish continuity of the vertical chemical berries on inner wall surfaces from the ground level up to the level of filled earth surface. To achieve this, a small channel 3x3 cm. shall be made at the junctions of the wall and columns with floor (before laying the sub 2 grade) and road holes made in the channels up to the ground level 15 cms. apart and the rod moved backwards and forward to breakup the earth a chemical emulsion poured along the channel at the rate of 7.5 liters per sq. m, of the vertical wall or column surfaces of sub-structures so as to soak the soil right to the bottom. The soil should be tamped back into place after this operation.

3.0. Mode of measurements and payment

3.1. The relevant specifications of the item 22,00.7. shall be followed.

3.2. The vertical area of sub-structure in contact with filled up earth above ground level to top filled up earth shall

be measured for payment.

3.3. The rate shall be for a unit of One sq. meter.

22.00.11. Treating the earth along the external perimeter of the building by making holes 15 cms., apart up to a depth of 30 cms. with chemical emulsion at the rate of 7.5 liters per sq. meter along the wall.

1.0. Materials : The relevant specification of item 22.00.7 shall be followed.

2.0. Workmanship

2.1. The relevant specifications of the item 22.00.7. shall be followed except that the external perimeter of the building shall be treated with chemical emulsions. After building is complete, the earth along the . external perimeter of the building should be treated at intervals of 15 cms. and to a depth of 30 cms. The rods shall be moved backward and forward parallel to the wall to breakup the earth and chemical emulsion poured along the wall at the rate of 7.5 liters per sq. meter of vertical surfaces. After the treatment the earth shall be tamped back into place the earth out side of the building should be graded on compaction of building, this treatment shall be carried out on the completion of such grading. In event of filling being more than 30 cms. the external perimeter and treatment shall be extended to the full depth of filling up to ground level so as to ensure continuity of the chemical barrier.

3.0. Mode of measurements and payment

3.1. The relevant specifications of item No. 22.00.7 shall be followed.

3.2. The vertical surfaces area so sub-structure 30 cms. in depth from finished ground level in external periphery only shall be measured and paid under this item. The depth of wall treated under back filled shall not be included in this item.

158

3.3. The rate shall be for a unit of One sq. meter.

22.0.12. Providing treatment along outside of foundation using chemical emulsion at 7.5 liters per sq. m. of vertical surface (for each side) of sub-structure.

1.0. Materials : The chemical used for the soil treatment shall be any one of the following with concentration shown against each in aqueous emulsion :

Chemicals Concentration

1. Aldrin 0.50% (by weight)
2. Heptachlor 0.50% (by weight)
3. Chlordane 1.00% (by weight)

2.0. Workmanship

2.1. The surface of consolidated earth around the existing building shall be treated with chemical emulsion at the rate 7.5 liters/sq. m. of vertical surface of sub-structure. The minimum height to substructure shall be considered 60 cms. for treatment. If the earth along the perimeter does not allow emulsion to seep through, holes up to 300 mm. deep at 150 mm. centers both ways be made by 12 mm. dia. mild steel rod on the surface to facilitate saturation of the soil with chemical emulsion.

2.2. The chemical barrier shall be complete and continuous under whole on the structure to be protected.

2.3. The chemical treatment shall be carried out when the surface quite dry. Chemical treatment shall not be carried out when it is raining or when the soil is wet with rain or sub soil water.

3.0. Mode of measurements and payment

3.1. The length shall be measured along the periphery of the sub-structure. The depth shall be taken 0.60 m.

3.2. No deduction shall be made not extra paid for any opening for pipes etc. up to 0.1 sq. m.

3.3. The rate includes cost of all labour and material required for the operations involved for satisfactory completion of this item.

3.4. The rate shall be for a unit of One sq. meter.

22.0.13. Providing treatment along external wall perimeter below concrete or masonry apron using chemical at 5. lit/linear including drilling and plugging etc.

1.0. Materials : The relevant specifications of item No. 22.0.12 shall be followed.

2.0. Workmanship

2.1. The relevant specification of item No. 22.0.12 shall be followed except that the treatment shall be carried out along external wall perimeter below concrete or masonry apron, using chemical at rate of 5 lit/ running meter.

3.0. Mode of measurements and payment

3.1. The relevant specifications of item No. 22.0,12 shall be followed.

3.2. The rate including drilling and plugging holes in apron etc. complete.

3.3. The rate shall be for a unit of One running meter.

22.0.14. Treatment of soil below existing floor using chemical at 1 liter per hole at 300 mm. a part including drilling plugging holes etc.

1.0. Materials : The relevant specifications of item No. 22.0.12. shall be followed.

2.0. Workmanship

2.1. The relevant specifications of item No. 22.00.9. shall be followed except that the termite control treatment shall be carried out in soil below existing floors.

2.2. The holes of 12 mm. dia rod shall be drilled in floor up to 150 mm. depth at 300 mm. part both ways. The chemical shall be then injected with pressure at the rate of 1 liters/hole of the surface area.

3.0. Mode of measurements & payment

3.1. The relevant specifications of item 22.0.9 shall be followed.

3.2. The rate shall includes cost of drilling holes and plugging.

3.3. The rate shall be for a unit of One sq. meter.

22.0.15. Treatment of voids in masonry using chemical at 1 Lit./hole at 300 mm. apart including drilling holes and plugging.

1.0. Materials : The relevant specifications of item 22.0.12 shall be followed.

159

2.0. Workmanship

2.1. The walls affected by termite shall be cleaned off all live forms binding inside and the holes of voids in masonry wall surface shall be treated by chemical emulsion at rat 1 Lit. hole. The holes in cracks in surface of wall shall be drilled at 300 mm. apart.

3.0. Mode of measurement & payment

3.1. The rate shall be for a unit of One number of voids treated.

22.0.16. Treatment to wood work by chemical emulsion in oil or kerosene based including 6 mm. dia downward slanted holes 150 mm. C/C. and plugging the same with cement mortar.

1.0. Materials : The relevant specifications of item No. 22. 00.7 shall be followed.

2.0. Workmanship

2.1. The wood work effected by Ants shall be cleaned of lives form hiding inside. The whole wood surface shall be then treated with oil or kerosene based chemical emulsion. The holes in 6 mm. dia. shall be drilled slanted downwards at 150 mm. centers to centers and chemical emulsion shall be poured into holes by means of funnels specifically prepared for the same and allowed to seep. After finales become emptily, another dose of chemicals shall be poured in them. This process shall be done repeatedly till the whole wood work is fully saturated with chemical.

2.2. The holes drilled in wood work shall be filled in with putty and other similar materials as directed and the whole wooden surface shall be made good as before.

3.0. Mode of measurements & payment

3.1. The work shall be measured for the finished work in sq. meter, including frame.

3.2. The out of frame shall be measured as width ad form top of flooring to top of frame shall be as height. This area includes for treating frame and shutters both.

3.3. The rate includes cost of all labours and materials, required for satisfactory completion of this item.

3.4. The rate includes drilling holes plugging the same after treatment completed and making good as before.

3.5. The rate shall be for a unit One sq. meter.

160

SECTION-23

Water Supply, Plumbing and Sanitary Fittings

23.2. Providing and fixing to wall, ceiling ad floor galvanised mild steel tube (Medium grade) of the following nominal bore, tube fittings and clamps including making good the wall ceiling and floor (A) 15 mm. dia (B) 20 mm. dia (C) 25 mm. (D) 32 mm. (E) 40mm. (F) 50 mm.

1.0. Materials

1.1. Galvanised mild steel tubes of specified dia nominal bore shall conform to I.S. 1239-1968.

1.2. The galvanised fittings, clamps, etc. required for specified dia. bore pipes shall be of best quality and makes as approved by the Engineer-in-charge.

2.0. Workmanship

2.1. Cutting, Laying & Jointing

2.1.1. When the tubes are to be cut or rethreaded, the ends shall be carefully filed out so that no obstruction to bore in offered. The ends of the tubes shall then be threaded conforming to the requirements of I.S. 554-1955 with pipe dies and taps carefully in such a manner that it will not result in slackness of joints when the two pieces are screwed together.

2.1.2. The taps and dies shall be used only for straightening screw threads which have becoming bent or damaged and shall not be used for turning of the threads so as to make them slack as the latter procedure may not result in the watertight joint. The screw threads for tube and fitting shall be protected form edge until they are fitted.

2.1.3. In jointing the tubes, the inside of the socket and the screwed end of the tubes shall be oiled and smeared with white or red lead and wrapping around with a few turns of fine spun yarn round the screwed end of the tube. The end shall then be tightly screwed in the socket, tees, etc. with a pipe wrench. Care shall be taken that all times free from dust, and dirt during fixing. Burr from the joints shall be removed after screwing. After laying the open ends of the pipes shall be temperately plugged to prevent access of water, soil, or any other foreign matter.

2.1.4. Any threads exposed after jointing shall be painted or in the case of underground piping thickly coated with approved anti-corrosive paint to prevent corrosion.

2.2. Fixing of tube fittings to wall ceiling & floors.

2.2.1. In case of fixing of tubes and fittings to the walls or ceilings, these shall run on the surface of the wall, or ceiling (not in chase) unless otherwise specified. The fixing shall be done by means of standard pattern, holder clamps keeping the pipes about 15 mm. clear of the wall. When it is found necessary to pattern, holder clamps keeping the pipes about 15 mm. clear of the .wall. When it is found necessary to conceal the pipes and when specified so, chasing may be adopted or pipe fixed inducts or recesses etc. provided that there is sufficient space to work on the pipe with usual tools. The pipe shall not ordinarily be buried in walls or solid floors, where unavoidable, pipe may be buried for short distances provided that adequate protection is given against damage and where so required joints are not buried. Where required M.S. tube sleeve shall be fixed at a place a pipe is peasant through a wall or floor for expansion and contraction and other movements. In case the pipe is embedded in walls or floors, it should be painted with anti-corrosive bitumastic paint of approved quality. The pipe should not come in contact with lime mortar or lime concrete as the pipe is affected by lime. Under the floors, the pipe shall be laid in layer of sand filling.

2.2.2. All pipes and fittings shall be fixed truly vertical and horizontal unless unavoidable. The pipes shall be fixed to walls with standard pattern clamps of required size and shape, one end of which shall be properly plugged or cemented into walls with cement mortar 1:3 (1 cement : 3 coarse sand) and the other tightened round the pipes to hold it securely. These clamps shall be spaced at regular intervals in straight lengths at 2 MC/C interval in horizontal run and 2.5 m. interval in vertical run. For pipe of 15 mm. dia. up to 25 mm. dia the holes in the walls and floors shall be made by drilling with chisel or jumper and not by dismantling the brick work or concrete. However for bigger diameter pipes the holes shall be carefully made cement : 3 coarse sand), and properly finished to match the adjacent surface.

2.3. Testing of joints :

2.3.1. After laying and jointing, the pipes and fillings shall be inspected under working conditions of pressure and flow. Any joints found liken shall be redone, and ail leaking pipes removed and replaced without extra cost.

161

2.3.2. The pipes and fittings after they are laid shall be tested to hydraulic pressure of 6 Kg./Sq cm. The pipe shall be slowly and carefully charged with water allowing all air to escape and avoiding all shocks and water hammer. The draw off takes and stop cock shall then be closed and specified hydraulic pressure shall be applied gradually The pressure gauge must be accurate. The pipes and fittings shall be tested in sections as the work laying proceeds, keeping, the joints exposed for inspection during the testing.

3.0. Mode of measurements and payment

3.1. The description of e, item shall, unless otherwise stated be held to include where necessary. conveyance, and delivery, handling, unloading, storing fabrication, hoisting, all labour for finishing to required shape and size, setting, fitting in position straight, cutting and waste return of packing etc.

3.2. The length shall be measured on running meter basis of finished work. The length shall be taken along the centre line of the pipe and fittings. The pipes fixed to wall, ceiling, floors etc shall be measured and paid under this item.

3.3. All the work shall be measured in decimal system as fixed in its place, subject to tolerance given below unless otherwise stated.

(i) Dimension shall be measured to the nearest 0 01 meter. (ii) Area shall be worked out to the nearest 0.01 sq. meter.

3.4. All measurements of cutting shall unless otherwise stated by held to include the consequent waste

3.5. In case of fitting of unequal bore, the targets bore shall be measured for the test.

3.6. Testing of pipe lines fittings, and joints include for providing all plant appliances necessary for obtaining access to the work to be tested an carrying out the tests

3.7. The rate includes galvanised steel tubing with .screwed socket joints. to gather with all fittings (such as bends, sockets springs, elbows, test, crosses, short pieces, clamps and plugs, unions etc.) and fixing complete with clamping wall hooks, wooden plug etc. and also curing, screwing and waste and for making forged (or hand made) bends on piping as required. Connector shall be inserted where required or directed. The rate also includes cutting through walls, floors etc. and their making good and painting exposed threads with anti-corrosive paint as above and testing where tubes are to be fixed to wall ceiling and flooring, the rates shall not include painting of pipes, providing sleeves and sand filling under floor for which separate payment shall be made.

3.8. The rate shall be for a unit of one running meter.

23.4. Providing and laying in trenches galvanised mild steel tubes (Medium grade) of the following nominal bore and tube fittings-earth work in trenches to be measured and paid for separately ; (A) 15 mm. dia. (B) 20 mm. (C) 25 mm. (D) 40 mm. (E) 60 mm. (F) 80 mm.

1.0. Materials

1.1. Galvanised mild steel lube of specified dia. nominal bore and fittings shall conform to I.S. 1239-1968

2.0. Workmanship

2.1. The relevant specifications of Hem 23.2 (A) shall be followed for cutting laying an j jointing testing of joints except that the fixing of tube shall be done in trenches,

2.2. The width and depth of the trenches for different diameters of tht, tubes shall he is under, For 15 to 80 mm. dia tube width of trenches shall be 30 cms. and depth of trenches 60 cms,

2.3. All joints, the trench width, shall be widened where necessary. The work of excavation and refilling shall be done true to line, and gradient in accordance with general specifications of earth work in trenches

2.4. The pipes shall *be* painted with two coats of anti-corrosive bitumastic paint of approved quality. The pipe shall be laid on a layer of 75 mm. sand filled upto 150 mm. above the pipe of so specified. The remaining portion of trench shall be then filled with excavated earth. The surplus shall be disposed off as directed.

2.5. When the excavation is done in rock the bottom shall be cut deep enough to permit the pipe to be laid and cushion of sand 75 mm. in case of bigger diameter of tube where the pressure is very high thrust block of cement concrete 1:2:4 (1 cement : 2 coarse sand : 4 grade stone aggregates of 20 mm nominal size) shall be constructed on all bends to transmit the hydraulic thrust without impairing the ground and spreading it over a sufficient area if so specified.

3.0. Mode of measurement

3.1. The relevant specifications of item No. 23.2 (A) shall be followed. The authorised quantities shall be

162

3.2. For purpose of calculating cubic content cross section shall normally be taken at suitable intervals i.e. at manhole of wall chamber intervals except in abnormal cases like sudden change in strata or undulating ground etc., when they may be taken at closer intervals as approved by the Engineer-in charge whose decision shall be final, conclusive and binding.

3.3. Authorised width :

- (a) Up to the meter depth, the width of the trenches for the purpose of measurements of excavation shall be arrived at by adding 40 cms. to the external diameter of the tube (not the socket) where a pipe is laid on concrete bed/ Cushioning layer, the authorised width shall be the external diameter of tube plus 40 cms. or the width of the concrete bed cushioning layer whichever is more.
- (b) For depths exceeding one meter an allowance of 5 cms. per meter of depth for each side of the trench shall be added to the authorised width (i.e. external diameter of pipe of plus 40 cms) This allowance shall apply to the entire depth of the trench. The authorised width in such cases shall therefore be, equal to the depth of trench, plus external diameter or tube plus 40 cms.
- (c) Where more than one tube is laid, the diameter shall be reckoned as the horizontal distance of outside to outside of the outermost pipes.
- (d) Where sheeting etc. has been provided the authorised width of the trenches at bottom shall be increased to accommodate for sheeting etc. so that the clear width available between faces of sheeting is as per previous ness of (a), (b) & (c) above.
- (e) If the sides of the trench are not vertical, the tones of side slopes shall end at the top of the pipe and vertical sided trench of authorised width as per (a), (b), (c) and (d) above shall be excavated from these down to the bed of trenches.

3.4. Where the tubes are laid in trenches, the work of excavation and refilling and round tubes for which separate payment shall be made, the length shall be measured on running meter, basis.

3.5. The rate shall be-for a unit of One running meter.

23.6. Marking connection of galvanised M/S. distribution branch with galvanised mild steel main 80 mm. nominal bore by providing and fixing tee including, cutting and threading the pipes etc. complete.

1.0. Materials The fittings required of specified dia. of pipe shall conform to I.S. 1237-1986.

2.0. Workmanship

2.1. A pit of suitable dimensions shall be dug at the point where the connection is to be made with the main and earth removed up to 150 mm. below the main. The flow of water in water main shall also be disconnected by closing the sluice or wheel valves on the main. The main shall first be cut. Water if any, collected in the pit shall be bailed out and ends of the pipe threaded.

2.2. The connections of distribution pipe shall be made by fixing malleable galvanised mild steel tee of the required size and fitting such as jam nut, socket, connecting piece etc,

2.3. The testing of the joints shall be done as per relevant specifications of item No. 23.2 (A).

3.0. Mode of measurements and payment

3.1. The rate includes cost of all labour, materials, tool and plant required for satisfactory completion of 'this item.

3.2. The rate shall be for a unit of One number.

23.8. Providing and fixing to wall ceiling and floor 6 Kgs/Sq. Cm. working pressure polythene pipes of the following outside diameter, low density complete with special flag compression type fittings wall clips etc. including making good the wall/ceiling and floor. (A) 20 mm. dia. (B) 25 mm. dia (C) 32 mm. dia. (D) 40 mm. dia. (E) 50 mm. dia.

1.0. Materials

1.1. The low density polythene pipe of specified diameter with 6 Kg/Sq. Cm, working pressure shall conform to I.S. 3076-1968. The specials and fittings required shall be of best quality.

2.0. Workmanship

2.1. The P.V.C. pipes of specified diameter shall be fixed as directed. Due to thermal expansion of rigid ' P.V.D. pipes, due allowance shall be made particularly in over ground pipe lines for any change in length of pipe line which may occur during installation or when pipe line which may occur during installation or when pipe line is in service.

2.2. Above ground installation of rigid P.V.C. pipe should be under taken after preparations are observed for their protection against direct sun rays and mechanical damage.

2.3. The rigid P.V.C. pipe lines should not be kept exposed above ground when it passes through public places, railway lines, road side and foot paths.

163

2.4. P.V.C. pipes shall be supported at the following intervals :

-20 mm. dia 500 mm. -25 mm. dia 750.mm. -32 mm. dia.900 mm.

2.5. Closer support spacing shall be provided if recommended by the manufacture.

2.6. The guide lines indicated by the manufacturer regarding handling, transportation, storing, laying and jointing pf pipes shall be kept in view during execution.

2.7. P.V.C. pipes shall be fixed on wall with wooden plugs and suitable plastic clamps.

2.8. Jointing the pipes :

2.8.1. The pipes and sockets shall be accurately cut. The ends of the pipes and fittings should be absolutely free from dirt and dust. The outside surface of the pipes and the inside of the fittings shall then be roughened with emery paper, and then solvent cement joint. Since solvent cement is aggressive to P.V.C. care must be taken to avoid applying excessive cement to the inside of pipe sockets as any surplus cement cannot be wiped of after jointing. Empty solvent cement tins, brushes, rags, or paper impregnated with cement should not be buried in the trenches. They should be gathered not left scattered about, as-they can prove to be a hazard to animals, which may chew them.

2.8.2. If any manufacturer recommends its own methods of jointing the same shall be adopted after necessary approval from the Engineer-in-charge.

2.9. Laying pipes in Trenches :

2.9.1. The pipes shall be laid over uniform relatively soft fine trained soil found to be free of presence of hard object

such as large flints, rocky projections, large tree roots etc. The width of the trenches shall be minimum width required for working.

2.9.2. The pipes laid underground shall not be less than one meter from the ground level. The pipe shall be positioned in the trenches so as to avoid any induced stresses due to deflection. Any deviation required shall be obtained by using proper type of rubber ring joints.

3.0. Mode of measurements & payment

3.1. The relevant specifications of item 23.2. (A) shall be followed except that the P.V.C. pipes of specified dia. shall be paid under this item.

3.2. The unit rate shall be for a unit of One running meter.

23.111.(A)(I) Providing and fixing water closet squatting pan (Indian type W.C. Pan) size 580 mm. (Earth work, bed concrete, foot-rests and trap to be measured and paid for separately). Vitreous china. Long pattern white colour.

1.0. Materials

1.1. Water closet squatting pan (Indian type W.C. Pan) shall conform to M-62. Cement mortar shall conform to M-11

2.0. Workmanship

2.1. The pan shall be sunk into the floor and embedded in a cushion of average 15 cm. cement concrete 1:5:10 (1 cement : 10 graded stone aggregate or brick aggregate 40 mm. nominal size) or and its bed concrete, the floor should be left 115 mm.-below the top level of the pan so as to allow for flooring and its bed concrete. The floor should be suitably stopped so that the waste water is drained into the pan. The shall be provided with 100 mm. 'P' or 'S' trap as specified in the item No. 23.113 with approximately 50 mm seal-The joints between the pan and the trap shall be made leak-proof with cement mortar 1:1 (1 cement : 1 fine sand).

3.0. Mode of measurements and payment

3.1. The rate shall include the cost of all materials and labours involved in the operations described under workmanship.

3.2. The rate shall be for a unit of One number.

3.3. The 'P' or S₁ trap unit of One number.

23.79. Providing and fixing cast spigot and sockets soil, waste, and ventilating pipes of the following normal size (B) 75 mm. dia. (C) 100 mm. dia.

1.0. Materials

1.1. The specified dia. C.I. Spigot and socket soil or waste pipe shall conform M-68.
164

2.0. Workmanship

2.1. The fixing of C.f. spigot and sockets soil, waste and ventilating pipe shall be carried out as per relevant specifications of item 15.93 (B) except the C.I. spigot and socket shall be fixed. The joints shall be filled with cement mortar 1:2 (1 cement : 2 sand) span spun yarn. The joints shall be filled with cement mortar 1:2 (1 cement : 2 sand) and spurn yarn. The pipes without care shall be fixed to wall with M.S. clamps The pipes will earn shall be secured with 40 mm before steel or iron barrel distance pieces or boils and stout galvanised iron nails 10 cms long into hand wool plug fixed in walls. Access doors to fittings shall be provided with 3 mm. rubber insertion packing and secured without screws to made air and water tight

2.2. All soil pipes shall be earned up above the roof and shall have a wire ball on guarded or a cowl.

2.3. The ventilating pipe or shaft shall be carried out to a height of at least one meter above the outer covering of the roof of the building or in the case of windows in a gable wall or a dormer windows, it shall t carried up to a ridge of the roof or at least tow meters above the top of the windows. In case of flat roof to which access for use is provided, it shall be carried out up to a height of at least on meter above the parapet or two meters measured vertically from the top of any windows or opening which any exist up to a horizontal distance of five meters from the vent pipe into such building and in no case shall be carried out to a height less then three meters.

2.4. Where ventilating pipes are carried in pipe shafts, the shaft shall be of a minimum size of one meter. If !he shells are also used to give fight and air to rooms, the ventilating pipes must be carried out to a horizontal distance at root level not loss than five meter from the site of the shaft.

2.5. The sand cast iron pipes above parapet shall be fixed with M.S. clamps and stays. The clamps shall be made from 1.5 mm. thick MS flat or 3 mm. width band to the required shape and size to fit tightly one the sockets when tightened with screw bolts. It shall be formed of two semi circular pieces with flanged ends on both sides, with holes to fit in the screw bolts and nuts 40 mm. dia. M.S. Bars, One end of the stay shall be bent to form a hook to be fixed with clamps by means of bolts and the other end shall be bent for embedding in wall in cement concrete block of size 200 mm. x 100 mm. x 100 mm. in 1:2:4 mix. The concrete shall be finished to match the surrounding surfaces.

2.6. The connection between the main pipe and branch pipes shall be made by using branches and bends with access doors for cleaning

2.7. The waste from lavatories, kitchens basins, sinks, baths and other floor traps shall be separately connected to respective stacks of upper floor. The waste stack of lavatories shall be connected directly to main hole while the waste stack of other shall be separately discharged over gulley trap.

3.0. Mode of measurements and payment

3.1. The length of pipe shall be measured including all fittings along its length in running meters correct to a centimeter. No allowance shall be made for the portion of pipe length entered in the sockets of the adjacent pipe of fittings.

3.2. The rate includes all labour, and materials, tools and plant etc. required for satisfactory completion of this item.

3.3. The rate shall be for a unit of One running meter.

23.87. Providing and fixing cast iron (spun) Nahni trap of the following nominal diameter of self cleaning design with C.I. Screwed down or hinged grating including cost of cutting and making good the waifs and floors : 100 mm. Inlet and 50 mm. outlet.

1.0. Materials

1.1. The cast iron (spun) Nahni trap shall conform to M-69. The C.I. hinged or screwed down cover shall be of best quality

2.0. Workmanship

2.1. The Nahni trap with 100 mm. dia inlet and 50 mm. dia. outlet shall be fixed as per drawing or as directed.

2.2. The Nahni trap shall be jointed with C.I. Pipe, 75 mm. dia. with lead joints. The lead joints shall be done in conformation with I.S. 782.-1976.

3.0. Mode of measurements and payment

3.1. The rate includes cost of all labour, materials, tools and plants etc. required for satisfactory completion of this item including lead, jointing and testing.

3.2. The rate shall be for a unit of one number.

165

23.112. (A)(I) Providing and fixing wash down water closet (European type W.C. Pan) with integral 'P' or 'S' trap including jointing the trap with soil pipe in C.M. 1:1 (1 cement : < fine sand) (seat and cover to be measured and paid for separately) ; Vitreous china pattern : In white colour,.

1.0. Materials

Wash down water closet (European type W.C. Pan) shall conform to M-60. Cement mortar shall conform to M-11.

2.0. Workmanship

2.1. The closet shall be fixed to the floor by means of 75 mm. long 6.5 mm. diameter counter sunk bolts and nuts embedded in the floor concrete using rubber or before washers so as not to allow any lateral displacement The joint between the trap of W.C. and soil pipe shall be made with C.M. 1:1 (1 cement : 1 fine sand).

3.0. Mode of measurements and payment

3.1. The rate shall include the cost of all materials and labour involved in all the operations described under workmanship.

3.2. The rate includes cost of all labour for fixing pans and seat and cover, inlet, connections etc. complete including testing the same. The payment of seat and cover shall be made separately.

3.3. The rate shall be for a unit of One number.

23.113. (A) Providing and fixing 100 mm. size 'P' or 'S' trap for water closet squatting pan including jointing the trap with the pan and soil pipe in cement mortar 1:1 (1 cement : 1 fine sand) Vitreous China.

1.0. Materials : The 100 mm. size 'P' or 'S' trap for water closet shall conform to M-62. Cement mortar shall conform to M-11.

2.0. Workmanship

2.1. The 'P' or 'S' trap shall be fixed with pan cast iron pipe with C.M. 1:1. The pan shall be provided with a 100 mm. 'P' or 'S' trap as specified in the item with an approximately 50 mm. seal The joint between the pan and the trap shall be made leak-proof with cement mortar 1:1(1 cement : 1 fine sand).

3.0. Mode of measurements and payment

3.1. The rate shall include the cost of all materials and labour involved in the operations described under workmanship including testing.

3.2. The rate shall be for a unit of one number.

23.114. Providing and fixing in C.M. 1:3 (1 cement : coarse sand) a pair of white vitreous china 250 mm. x 130 mm. 30 mm. foot rest for long pattern squatting pan water closet.

1.0. Materials

1.1. The pair of white vitreous china foot-rests shall conform to M-62 Cement mortar shall conform to M-11.

2.0. Workmanship

2.1. After laying the floor, the floor shall be suitably sloped so that the waste water is drained into the pan A pair of foot-rests of size 250 mm. x 130 mm. x 30 mm. of white vitreous china shall be set in cement mortar 1:3 (1 cement ; 3 coarse sand). The foot-rests shall be fixed at a distance of 175 mm. from the inner edge of the back side of the pan and shall be fixed at convenient angle.

3.0. Mode of measurements & payment

3.1. The rate shall include the cost of all materials and labours involved in all the operations described under workmanship.

3.2. The rate shall be for a unit of One pair.

23.115. (A)(I) Providing and fixing 12.5 liters low level flushing cistern with a pair of C.I. or mild steel brackets complete with fittings such as lead valve less syphon, 15 mm. nominal size brass ball valve with polythene float, C.P. brass ball handle, unions and couplings for connections with inlet, outlet and overflow pipes, 40 mm. dia. porcelain enameled flush bend including cutting holes in walls and making good the same and connecting the flush bend with cistern and closet (overflow pipe to be measured and paid for separately) : Vitreous China. In white colour.

1.0. Materials

1.1. The low level vitreous china (Enamel) flushing tank shall conform to M-65 except that the flushing cistern shall be 12.5 liters low level type as mentioned in the item.

166

2.0. Workmanship

2.1. The low level cistern shall be firmly fixed on two C.I. or mild steel, brackets which shall be firmly embedded in the wall in C.M. 1:4 (1 cement : 4 fine sand).

2.2. The height of the bottom of the cistern from the top of the pan shall be 30 cms of low level flushing cistern shall be connected to the closet by means of 40 mm. dia, white porcelain enameled flush bend using Indian rubber adapts joints. The flush pipe shall be securely connected to the cistern outlet by means of coupling nut made of any non-corrosive materials, non-ferrous metal or galvanised steel. The flush pipe from the cistern shall be connected to the closet by means of cement of red-lead.

3.0. Mode of measurements & payment

3.1. The rate shall include the cost of all materials fitting and labour involved in all the operations described under workmanship including testing.

3.2. The rate shall be for a unit of One number.

23.116. Providing and fixing 12.5 liters level C.I. flushing with a pair C.I. or mild steel brackets, complete with fittings such as syphonic arrangement, 15 mm. nominal size brass ball valve with polythene flat, lever. G.I. China (60 cms.) and pull unions and couplings for connections with inlet, outlet and overflow pipes etc. including cutting holes in walls and making good the same (overflow pipe to be measured and paid for separately).

1.0. Materials

1.1. The high level C.I. flushing cistern shall conform to M-66, except that the flushing cistern shall be of 12.5 liters high level C.I. cistern as mentioned in the item.

2.0. Workmanship

2.1. The cistern shall be fixed on two C.I. or mild steel brackets which shall be firmly embedded in the wall in cement mortar 1:4 (1 cement : 4 fine sand).

2.2. The height of the bottom of the cistern from the top of the pan shall be two meters.

2.3. The W.C. Pan shall be connected to the cistern by galvanised steel flush pipes of 32 mm. nominal internal diameter. The flush pipe shall be fixed to wall by using clamps. The flush pipe from the cistern shall be connected to the closet by means of cement of red-lead. The flush pipe shall be securely connected to the cistern outlet by means of coupling nut made of any non-corrosive materials non-ferrous metal or galvanised steel.

2.4. The chain and the pull union shall be fixed to the protruding level arm of the flushing cistern.

2.5. The whole installation shall be tested for leak-proof joints and satisfactory functioning.

3.0. Mode of measurements & payment

3.1. The rate shall include the cost of all materials, fittings, and labour involved in all the operations described under workmanship including testing.

3.2. The rate shall be for a unit of One number.

23.117. Providing and fixing in position with clamps etc. 32 mm. nominal internal dia. galvanised steel tube flush pipe for high level flushing cistern including connecting the flush pipe with cistern and closet and making good the walls and floors.

1.0. Materials

1.1. The 32 mm. nominal internal dia, galvanised steel tube flush pipe shall conform to M-56.

2.0. Workmanship

2.1. The W.C. pan shall be connected to the cistern by galvanised steel flush pipe of 32 mm nominal internal diameter. The flush pipe shall be fixed to wall by using clamps.

2.2. The flush pipe from the cistern shall be connected to the closet by means of cement or red-lead.

2.3. The flush pipe shall be securely connected to the cistern outlet by means of coupling nut made of any noncorrosive materials, non-ferrous metal or galvanised steel.

3.0. Mode of measurements and payment

3.1. The rate shall include the cost of all materials, fittings and labour involved in all the operations described under workmanship including testing.

3.2. The rate shall be for a unit of One running meter.

23.120. Providing and fixing G.I. inlet connection for flush pipe with W.C. Pan.

167

1.0. Materials

1.1. The G.I. inlet connection for flush pipe shall conform to M-56.

2.0. Workmanship

2.1. The flush pipe from the cistern shall be connected to the closet by means of cement or red-lead.

3.0. Mode of measurements & payment

3.1. The rate shall include the cost of all materials, fittings and labour involved in all the operations described under workmanship including testing.

3.2. The rate shall be for a unit of One number.

23.127. Providing and fixing wash basin with single hole for pillar top white C.I. or M.S, brackets painted white including cutting holes, and making good the same but excluding fittings, vitreous china flat back wash basin 550 mm. x 400 mm. in white colour.

1.0. Materials

1.1. The white glazed earthenware wash basin shall be 550 mm. x 400mm. of 1st quality and make as approved by the Engineer-in-charge. The wash basin shall-conform to M-59.

2.0. Workmanship

2.1. The washbasin shall be fixed on the wall as and where directed. The wash basin shall be supported on a pair of M.S. or C.I. brackets fixed in C.M. 1:3 (1 cement : 3 sand). The bracket shall conform to I.S. : 775-1962. The wall plaster on the rear shall be cut to rest the top edge of the washbasin. After fixing the basing, plaster shall be made good and surface finished to match the existing one.

2.2. The brackets shall be painted white with ready-mixed paint.

2.3. The C.I. brass trap and union shall be connected to 32 mm. dia. waste pipe which shall be suitably bent towards the wall and which shall discharge into an open drain leading to a gully trap or direct in to gully-trap on the ground floor and shall be connected to a waste pipe through a floor trap on the upper floors. C.P. brass trap and union may not be provided where the surface drain or a floor trap is placed directly under the basin and the waste is discharged in to vertically.

2.4. The height of the front edge to the wash basin from the floor level shall be 80 cms.

2.5. The necessary inlet, outlet connections and fittings such as pillar cocks, CP dress waste trap waste pipe, stop cock, chain wish rubber plug etc. shall be fixed.

2.6. The payment of fittings shall be made separately under separate items.

3.0. Mode of measurements & payment

3.1. The rate includes cost of all labour, materials, tool3 and plant etc. required for satisfactory completion of this item as specified in workmanship.

3.2. The rate shall be for a unit of One number.

23.130.(C) Providing and fixing kitchen sink with C.I. or M.S. brackets painted white including cutting holes in walls and making good the same of but excluding fittings. Vitreous china sink 600 mm. x 450 mm. x 150 mm. size.

1.0. Materials

1.1. White glazed vitreous china sink 600 mm. x 450 mm. x 150 mm. size shall conform to M-63.

2.0. Workmanship

2.1. The kitchen sink shall be supported on a pair of M.S. or C.I. brackets fixed in cement mortar 1:3 (1 cement : 3 coarse sand). The M.S. or C.I. brackets shall conform to I.S. 775-1962. The wall plaster on the rear shall be cut to rest over the top edge of the sink. After fixing the sink, plaster shall be made good and he surface finished to match with the existing one.

2.2. The C.P. brass trap and union shall be connected to 40 mm. nominal bore galvanised mild steel waste pipe which shall be suitably bent towards the wall and which shall discharge into an open drain leading to gully-trap or direct into the gully-trap on the ground on floor and shall be connected to a waste pipe through a floor trap on the upper floors. C.P. brass trap and union may not be provided where surface drain or a floor trap is placed directly under the sink and the waste is discharged to it vertically.

2.3. The height of front edge of the wash basin from the floor, level shall be 80 cms.

3.0. Mode of measurements & payment

3.1. The rate includes cost of all labour, materials, tools and plant and other equipment required for satisfactory completion of this item as described in workmanship.

168

3.2. The rate shall be for a unit of One number.

23.135 (A) Providing and fixing 32 mm, dia. C.P. brass waste for wash basin or sink.

1.0. Materials

1.1. The C.P. brass trap and unions shall be of 32 mm. dia. and of best quality and make as approved by the Engineer-in-charge

2.0. Workmanship

2.1. C.P. brass waste trap and union shall be connected to 32 mm dia waste pipe which shall be suitably bent towards the wail which shall discharge into drain through a floor trap The C.P brass waste trap shall be provided for wash basin or sink as the case may be.

3.0. Mode of measurement & payment

3.1. The rate includes all labours and providing C.P. brass waste trap and union including waste couplings of 32 nun fin. The rate excludes the cost of waste pipe of 32 mm. dia.

3.2. The idle shall be for a unit of One number.

23.135.(B) Providing and fixing 40 mm dia. C.P. Brass waste for wash basin or sink.

1.0. Materials & Workmanship

1.1. The relevant specifications of item 23.135 (A) shall be followed except that the diameter of C.P. brass waste is 40 mm dia.

2.0. Mode of measurements & payment

2.1. Thu rate shall be for a unit of One number.

23.136.(A) Providing and fixing 32 mm. dia. M.I. union for wash basin or sink.

1.0. Materials

1.1. Tho 32 mm dia M.I. Fisher union shall be of best quality and made as approved by the Engineer-in-charge.

2.0. **Workmanship** 2.1. The 32mm dia M I. Fisher union shall be fixed to wash basin or sink in best workman like manner.

3.0. Mode of measurements and payment

3.1. The rate includes all labours .and materials, tools and plants etc. required for satisfactory completion of the item.

23.136.(B) Providing and fixing 40 mm, dia. M.I. fisher union for wash basin or sink.

1.0. Materials and Workmanship

1.1. The relevant specifications of item No. 23, 136 (A) shall be followed except that the diameter of M I fisher union shall be 40 mm. dia.

2.0. Mode of measurements of payment

2.1. The rate shall be for a unit of One number

23.139. Providing and fixing 100 mm. dia, sand cast iron grating for gulley floor or Nahni tarp.

1.0. Materials

1.1. The- 100 mm. dia. sand cast iron gratings for gulley, floor or Nahni trap shall be of best quality and make as approved.

2.0. Workmanship

2.1. The CAST IRON grating shall be provided to gulley trap floor or Nahni trap as the case may be in best workmen like manner.

3.0. Mode of measurements and payment

3.1. The rate shall includes cost of all labour, materials, tools and plants, etc. required for satisfactory completion of this item.

3.2. The rate shall be for a unit of One number.

23 :141.(A) Providing and fixing 100 mm. dia, C.P, brass shower rose with 15 mm or 20 mm. inlet.

1.0. Materials

1.1. 100 mm. dia C P. brass shower lose shall confirm to I S. 2556-1972 part - XI and of best quality and makes as approved by engineer-in-charge. The inlet of shower rose shall be 15 mm dia. or 20 mm dia. as directed.

169

2.0. Workmanship

2.1. The C.P. brass shower rose shall be fixed as directed with 15 mm. dia. or 20 mm. dia. G.I. inlet pipe as the case may be.

3.0. Mode of measurements and payment

3.1. The rate includes all labours and materials, tools and plant etc. required for satisfactory completion of this item

3.2. The rate shall be for a one number.

23.143. Providing and fixing 600 mm. x 450 mm. beveled edge mirror of superior glass mounted on 6 mm. thick A.C. Sheet or plywood sheet and fixed to wooden plugs with C.P brass screws and washers,

1.0. Materials

1.1. The 600 mm. x 450 mm. size mirror shall be of superior glass with edge rounded offer beveled as specified. It shall be free from flaws specks, or bubbles and its thickness shall not be less than 6 mm. The glass for the mirror shall be uniformly silver plated at the back and shall be free from silvering defects Silvering shall have a protective uniform covering of red lead paint. The 6 mm thick ply wood shall conform to M-37. The 6 mm. thick A.C. sheets shall conform to M-24.

2.0. Workmanship

2.1. The mirror of 600 mm. x 450 mm. size mounted on A.C. Sheet or plywood 6 mm thick with C.P. brass clips shall be fixed as directed, by fixing wooden plugs in wall and C.P brass screws and washers. The work shall be carried out in best workman like manner.

3.0. Mode of measurements & payment

3.1. The rate includes cost of all labour and materials, tools and plant etc. required for satisfactory completion of this item. The rate shall be for a .unit of One number.

23.144.(B) Providing and fixing 600 x 20 mm. C.P. brass towel rail complete with C.P. brass brackets fixed to wooden plugs with and C.P. brass screws.

1.0. Materials

1.1. The C.P. brass towel rail shall be 600 x 20 mm. of best quality as approved by the Engineer-in-charge The brackets shall be of C.P. brass. The rail shall conform to I.S. 1068-1958.

2.0. Workmanship

2.1. The brackets of the towel rail shall be fixed by means of C.P. brass screws to wooden firmly embedded in the wall with C.M. 1:3 (1 cement : 3 coarse sand). The towel rail shall be fixed as and where directed.

3.0. Mode of measurements and payment

3.1. The rate includes cost of all labour and materials, tools and plant etc. required for satisfactory completion of this item.

3.2. The rate shall be for a unit of One number.

23.145. Providing and fixing 600 mm. x 120 mm. glass shelf with C.P. brass brackets and guard rail complete, fixed to wooden plugs with C.P. brass screws.

1.0. Materials : The glass shelf of 600 mm. x 120 mm. size shall be of 5 mm. thick plate glass. The edge of the glass shall be grounded. The C.P. over brass guard rail shall be best quality and make.

2.0. Workmanship

2.1. The C.P. brass brackets of the glass shelf shall be fixed with C.P. screws to wooden plug firmly embedded in the wall C.M. 1:3 (1 cement : 3 coarse sand). The C.P. guard rail shall be fixed to glass shelf as directed.

3.0. Mode of measurement and payment

3.1. The rate includes all labour and materials tools and plant etc. required for satisfactory completion of this item,

3.2. The rate shall be for a unit of One number.

23.146.(A) Providing and fixing C.P. brass toilet paper holder.

1.0. Materials : The toilet paper holder shall be of best quality and make, chromium plating shall be of grade 'B'

type conforming to I.S. 1068-2958.

2.0. Workmanship

2.1. The toilet paper holder shall be fixed in position by means of screws and wooden plugs embedded in wall with cement 1:3 (1 cement : 3 coarse sand).

170

3.0. Mode of measurements and payment

3.1. The rate includes cost of all labour and material, tools and plant etc. required for satisfactory completion of this item.

3.2. The rate shall be for a unit of One number.

23.92.(A)(I) Providing and fixing brass screw down bib taps of following size. Polished bright : 14 mm. dia.

1.0. Materials : 15 mm. dia. brass screw down with bright polished finished shall conform to I.S. 781-1977. The bib cock shall be best Indian make and quality.

2.0. Workmanship

2.1. The screw down bib cock 15 mm. as specified above shall be fixed as directed. The threaded portion shall be smeared with white or red lead and around with a few turns of fine spun yarn round the screwed end of the pipe. The bib cock shall be then screwed and fixed to water tight position.

3.0. Mode of measurements and payment

3.1. The rate includes cost of all labour, materials, tools and plant etc. required for satisfactory completion of this item.

3.2. The rate shall be for a unit of One Number.

23.92.(A)(II) Providing and fixing brass screw down bib taps of following size : Polished bright: 20 mm. dia.

1.0. Materials and Workmanship

The relevant specifications of item 23.92 (A) (i) shall be followed except that the bib taps of 20 mm. dia shall be fixed.

2.0. Mode of measurements & payment

2.1. The relevant specifications of item 23.92 A(i) shall be followed.

2.2. The rate shall be for a unit of One number.

23.92.(B)(I) Providing and fixing chromium plated brass screw down bib taps of the following size : 15 mm. dia.

1.0. Materials and workmanship

The relevant specification of item No. 23.92 (A) (I) shall be followed except that the brass chromium plated screw down tap of 20 mm. dia. shall be fixed.

2.0. Mode of measurements & payment

2.1. The rate shall be for a unit of One number.

23.92.(B)(II) Providing and laying chromium plated brass screw down bib taps of following size : 20 mm. dia.

1.0. Materials and workmanship

The relevant specifications of item No. 23.92 (A) shall be followed except that the brass chromium plated screw down tap of 20 mm. dia. shall be fixed.

2.0. Mode of measurements & payment

2.1. The rate shall be for a unit of One number

23.92.(C)(I) Providing and fixing gun metal screw down bib taps of the following size : 15 mm. dia.

1.0. Materials and workmanship

1.1. The relevant specification of item No. 23.9*3 (A) (I) shall be followed except that the 15 mm. dia. gun metal screw down bib tap shall be fixed.

2.0. Mode of measurements & payment

2.1. The rate shall be for a unit of One number,

23.92.(C)(II) Providing and fixing gun metal screw down bib taps of following size : 20 mm. dia.

1.0. Materials & Workmanship

1.1. The relevant specifications of item 23.92 (A) (i) shall be followed except that the 20 mm. dia. gun screw down bib tap shall be fixed.

2.0. Mode of measurements & payment

2.1. The rate shall be for a unit of One number.

23.95(A) Providing and fixing pillar tap capstan head screw down high pressure with screw shank and back nuts : (A) 14 mm. dia. (B) 20 mm. dia.

1.0. Materials : The capstan head pillar tap of specified dia. of C.R over brass shall be best quality and shall conform to I.S. : 1975 - 1961. The pillar taps shall be tested quality.

171

2.0. Workmanship

2.1. The capstan head pillar tap of specified dia. shall be fixed as directed with required washers of selected leather or rubber asbestos composition or of plastic as directed. The cock shall fixed with pipe line white Zink end spun yarn, to make joint water tight. The work shall be carried out in best workman like manner.

3.0. Mode of measurements and payment

3.1. The rate shall be for a unit of one number.

23.96(A) Providing and fixing brass screw down stop cock (A) 15 mm. dia. (B) 20 mm. dia. (C) 25 mm. dia.

1.0. Materials : The brass screw down stop cock of specified dia shall conform to IS. : 781 -1977 The stop cock shall be of tested quality.

2.0 Workmanship

The stop cock shall be fixed in position by means of Jam nut and socket. The stop cock shall be fixed near the inlet of the water meter or as directed. The joints shall be done with white zinc and spun yarn. The joint shall be tested for leak proofing.

3.0. Mode of measurements and payment

3.1. The rate includes cost of all labours, materials, tools and plant etc. required for satisfactory completion of this item.

23.99. Providing and fixing gunmetal check or non-return valve. (A) 15 mm. dia. (B) 20 mm. dia. (C) 25 mm. dia. (D) 32 mm. dia. (E) 40 mm. dia.

1.0. Materials : The gun metal check or not return full way wheel valve or specified dial, shall conform to I.S. : 778-1964. The non-return valve shall be of tested quality.

2.0. Workmanship

2.1. The gun metal check or non return valve shall be fully cleared of all foreign matter before fixing. The fixing of shall be done by means of bolts nuts and 3 mm. rubber insertions with flags of spigot and socketed tail pieces, drilled to the same specifications as in case of socket and spigot flanges in case of flanged pipes. The joining shall be done leak proof.

3.0. Mode of measurements and payment

3.1. The rate includes all labours, materials, tools and plant etc. required for satisfactory completion of this item.

3.2. The rate shall be for a unit of **One number.**

23.00. Providing and fixing chromium plated brass half turn flush cock of approved quality including fixing in pipe line etc. complete (I) 20 mm. dia. (II) 25 mm. dia. (III) 32 mm. dia.

1.0. Materials : Chromium plated brass half turn flush cock shall conform to M-67.

2.0. Workmanship

The half turn flush cock of specified diameter shall be fixed as directed. The flush cock shall be fixed in G.I. pipe line with necessary fittings. The joints shall be made leak proof by using spun yarn and white Zink. The fixing work shall be carried out as per relevant specifications of item No. 23.2(4).

3.0. Mode of measurements and payment

3.1. The rate includes cost of all materials and labour required for satisfactory completion of this item including fittings.

3.2. The rate shall be for a unit of One number.

23.00.4. Providing and fixing chromium plated bottle trap with necessary coupling of approved quality for wash basin.

1.0. Materials : The chromium plated bottle trap shall be approved make and of best quality. The bottle trap shall be provided with coupling.

2.0. Workmanship

The bottle trap shall be fixed on wash hand basin with wooden gullies and screws as directed. The work shall be carried out in best workman like manner.

172

3.0. Mode of measurements and payment

3.1. The rate includes cost of all materials and labour involved for satisfactory completion of this item.

3.2. The rate shall be for a unit of One number.

23.122. (A) Providing and fixing urinal of approved quality including connecting the urinal with waste pipe trap etc. complete : white earthenware flat back or corner type size 430 mm. x 260 mm. x 350 mm.

1.0. Materials: The white earthenware flat back or corner type urinal of size 430 mm. x 260 mm. x 350 mm. shall conform to M-64.

2.0. Workmanship

2.1. The urinals shall be fixed in position by using wooden plugs and screws and shall be at a height 65 cms. from the Moor level to the top of the lip of urinal, unless otherwise directed. The wooden plugs shall be of 50 mm. x 50 mm. at base tapering to 38 mm. x 38 mm. at top 50 mm. in length shall be fixed in wall in steel waste pipe which shall discharge in the channel or floor a trap. The connection between the urinal and flush or waste pipe shall be made by means of putty or white lead mixed with chopped hemp.

3.0. Mode of measurements and payment

3.1. The rate shall includes cost all labours, materials, tools and plants etc. required for satisfactory completion of this item.

3.2. The rate shall be for a unit of One number.

23.124. (A) Providing and fixing urinal of approved quality including connection with trap and with integral longitudinal flush pipe squatting plate pattern white earthenware 550 mm. x 300 mm.

1.0. Materials : The squatting plate pattern, white glazed earthenware urinal of 550 mm x 300 mm shall conform to I.S. 771-1063. It shall be test India make.

2.0. Workmanship

2.1. The squatting plate urinal shall be fixed as directed.

2.2. The top edge of the squatting plate shall be flush with the finished floor level adjacent to it. It shall be embedded on a layer of 25 mm. thick cement mortar 1:8 (1 cement: 8 fine sand) laid over a bed of burnt brickbat

cement 1:5 :10(1 cement: 5 fine sand, 10 graded brick aggregate 20 mm. nominal size). There shall be 100 mm. dia. glazed earthenware or vitreous china channel as specified with stop and outlet pieces suitably fixed in floor in cement mortar 1:3 (1 cement: 3 coarse sand) and joint finished with white cement. The earthenware vitreous china shall discharge into 65 mm. C.P. brass outlet grating. The trap and fitting shall be fixed as directed.

3.0. Mode or measurements and payment

3.1. The rate includes .cost of all materials, tools and plants and labour required for satisfactory completion of this item.

3.2. The rate shall be for a unit of One number

23.134 Providing and fixing rubber plug for sink or wash basin.

1.0. **Material:** The rubber plug for sink or wash hand, basin shall be best quality and make as approved by the Engineer-in-charge.

2.0. Workmanship -

2.1. The rubber plug with plain shall be fixed in wash basin or sink as directed.

3.0. Mode of measurements and payment

3.1. The rate shall be for a unit of One number.

23.00.5.(A) Providing and fixing ball cock of approved quality as directed {Copper metal} : (I) 25 'mm. dia.

(II) 50 mm. dia;

1.0. Materials :

The ball cock of specified diameter shall conform to M-75

2.0. Workmanship

The ball cock of specified diameter shall be fixed as directed. The fixing of ball cock shall be carried out as per relevant specification of item No. 23 (A) for joints etc.

173

3.0. Mode of measurement & payment

3.1. The rate includes-cost of all materials and labour involved for carrying out satisfactory work.

3.2. The rate shall be for a unit of One number.

23.00.5.(B) Providing and fixing ball cock of approved quality as directed : Ebonite. (I) 25 mm. dia. (II) 50 mm. dia.)

1.0. **Materials & Workmanship :** The relevant specifications of item No. 23.00.5 (A) shall be followed except that the ball cock of specified dia of Ebonite shall be fixed.

2.0. Mode of measurements & payment

2.1. The relevant specifications of item NO. 23.00.5 (A) shall be followed.

2.2. The rate shall be for a unit of One number.

23.00.6. Providing and fixing C.I. Manhole cover 0.60 C.M. x 0.45 C.M. size having weight not less than 35 kg.

1.0. Materials

C. I. Manhole cover of 0.60 x 0.45 Cms. size shall be of best quality. The eight of C.I. cover and frame shall into be less than 35 Kg. The C.I. manhole cover shall be of light duty and conform relevant I.S.

2.0. Workmanship

2.1. The C.I. Manhole cover shall be fixed as per relevant specifications of item No. 24.44 except that the C.I. cover shall be fixed ad and where directed.

3.0. Mode of measurements and payment

3.1. The rate includes cost of all laobur and materials required for satisfactory completion of this item.

3.2. The rate shall be for a unit of One number.

23.00.7. Providing and fixing G.I. water spout of 50 mm. dia. and 30 cms length.

1.0. **Materials :** G.I.M.S. type of 50 mm. dia. shall conform to M-56.

2.0. Workmanship

2.1. The G.I. pipe of 30 cms. fixed as rain water pipe as directed. The pipe shall be fixed about 1/4 dia. below the floor level so as to make approach of water easy. The inlet of pipe shall be rounded off for easy entry of rain water pipe. The pipe shall be fixed in C.M. 1:3.

3.0. Mode of measurements & payment

3.1. The rate includes of all labour and materials required for satisfactory completion of this item.

3.2. The rate shall be for a unit of One number.

23.8. Providing and fixing to wall ceiling and floor 6 Kg/ Sq. cm, working pressure outside diameter, low density completion with special flange compression type fittings wall clips etc. including making good the wall, ceiling and floor. (A) 20 mm. dia. (B) 25 mm. dia. (C) 32 mm. dia. (D) 40 mm. dia. (E) 50 mm. dia.

1.0. **Materials :** The low .density polythene pipe of specified diameter with 56 Kg/f. Sq. Cm. working pressure shall conform to I.S. 3076-1968. The specials and fittings required shall be of best quality.

2.0. Workmanship

2.1. The P.V.C Pipes of specified diameter shall be fixed as directed. Due to thermal expansion of rigid P-V.C. Pipes, due allowances shall be made particularly in over-ground pipe line for any change in length of pipe line which may occur during installation or when pipe fine is in service.

2.2. Above ground installation of rigid P.V.C. pipe should be undertaking after precautions are observed for their protection again dirt, sun rays and mechanical damage.

2.3. The rigid P.V.C. tines should not be kept exposed above ground when it passes through public places, railway lines, roads, road side and foot paths.

2.4. P.V.C. pipe shall be supported at the following intervals ;

-20 mm dia 500 mm. -25 mm. dia. 750 mm. -32 mm. dia. 900 mm.

2.5. Close support spacing shall be provided if recommended by the manufacturer.

2.6. The guide lines indicated by the manufacturer regarding handling, transportation, storing, laying and jointing of pipes shall be kept in view during execution.

174

2.7. P.V.C. pipes shall be fixed on wall with wooden plugs suitable plastic clamps.

2.8. Jointing the pipes :

2.8.1. The pipes and socket s shall be accurately cut. The ends of the pipes and fittings should be absolutely free from dirt and dust. The outside surface of the pipes and the inside of the fittings shall then be roughened with emery paper, and then solvent cement shall be applied to the matching surface and pushed home and joint. Since solvent cement is aggressive to P.V.C. care must be taken to avoid applying excessive cement to the inside of pipe sockets as any surplus cement cannot be wiped off after jointing. Empty solvent cement tins, brushes, rags of paper impregnated with cement should not be buried in the trenches. They should be gathered, not left scattered about, as they can prove to be a hazard to animals, which may chew them.

2.8.2. If any manufacturer recommends its own methods of jointing the same shall be adopted after necessary approval from the Engineer-in-charge.

2.9. Laying pipes in trenches:

2.9.1. The pipes shall be laid over uniform relatively soft fine grained solid found to be free of presence of hard object such as large feints, rocky projections, large tree roots etc. The width of the trenches shall be minimum width required for working.

2.9.2. The pipes laid underground shall not be less than one meter from the ground level. The pipe shall be positioned in the trenches so as to avoid any inducted stresses due to retraction. Any deviation required shall be obtained by using proper type of rubber ring joints.

3.0. Mode of measurements & payment

3.1. The relevant specifications of item No. 23.2. (A) shall be followed except that the P.V.C. pipes of specified dia. shall be paid under this item.

3.2. The unit rate shall be for a unit of One running meter.

175

SECTION-24

24.1.(A) Providing any laying (two level or slopes) and jointing with stiff mixture of cement mortar in proportion 1:1 salt glazed stone-ware pipes, following nominal internal diameters including testing of pipes and joints complete : 100 mm. dia.

1.0. Materials

(I) Water shall conform to M-1(2) Cement mortar of proportion 1:1 shall conform to M-11. (3) 100 mm. dia. glazed stoneware pipe shall conform to M-71.

2.0. Workmanship

2.1. The trenches for stoneware pipe drains shall be carried out as per relevant specifications of item No. 23.4 (A) except that the work is for stoneware pipes of 100 mm. dia.

2.2. Laying:

2.2.1. The pipes shall be laid accurately and perfectly true to line, levels and gradients, Great care shall be taken to prevent sand etc. from entering the pipes. The pipes between two manholes shall be laid truly in a straight line without vertical or horizontal undulation. All junctions and changes in direction and diameter shall be made inside manholes by means of curved tapered channels formed in Cement concrete finished smooth and benched on both sides. The body of the pipe shall rest for its entire length, on a even level bed grips being made or left on the bed to receive the sockets of the pipes.

2.3. Jointing:

2.3.1. Tarrd gask in or yarn soaked in neat cement slurry shall first be placed around the spigot to each pipe and the spigot shall then be placed well home into the socket of the pipe previously laid. The pipe shall then be adjusted and fixed in the correct position and gaskin caulked home so as to fill not more than 1/4th of the total depth or (13 mm. in depth) of the socket.

2.3.2. The remainder of the sockets shall be filled with stiff mixture of cement mortar in proportion of one part of cement and one part of sharp sand. When the socket is fillet, a filled shall be formed round the joints with a trowel, forming an angle of 450 with the barrel of the pipe.

2.3.3. The mortar shall be mixed as necessary for immediate use.

2.3.4. After the joint is made, any extraneous materials shall be removed form the inside of the joints with a suitable scraper or "badger". The newly made joints shall be protected, until set, from the sun, dry winds, rain or frost, sacking or other suitable materials which shall be used for the purpose.

2.3.5. The mortar shall be cured for 10 days.

2.4. Testing of Joints:

2.4.1. If nay leakage is visible the defective part of the work shall be made good at no extra cost. The pipe line shall be tested as directed.

2.4.2. A slight amount of sweating which is uniform may be overlooked, but excessive sweating from a particular pipe or joints shall be watched for and taken as indicating a defect to be made good.

3.0. Mode of measurements and payment

3.1. Pounding or buttering of the fit trenches bed to the lower part of the pipe and "Grips" dug to take socket,

collars etc. are included in the rate of laying the pipes.

3.2. The measurements shall be net without any allowance for cutting, and waste. The length of bends, junctions, and other connections shall be included in the total length of the drain pipes. Nothing extra shall be paid for the same. The rate includes necessary excavation refilling trenches etc. complete,

3.3. The rate shall be for a unit of One running meter.

24.1.(B) Providing and laying and jointing salt glazed stoneware pipes with lime concrete 1:2:4 (1 lime :2 fine sand : 4 graded brick aggregate 40 mm, nominal size) bedding with necessary form work and curing etc. complete : 150 mm. dia.

176

1.0. Materials & Workmanship : The relevant specifications of item 24.1.(A) shall be followed except that the diameter of pipe shall be 150 mm. dia.

2.0. Mode of measurements and payment

2.1. The relevant specifications of item No, 24.1. (A) shall be followed.

2.2. The rate shall be for a unit of One running meter.

24.2.(A) Providing and laying cement concrete 1:5:10 (1 cement : 5 fine sand : 10 graded stone : aggregate 40 mm. nominal size) bedding for stoneware pipe of following internal diameter with necessary form work and curing complete : 100 mm. dia. 300 mm. width (112 mm. average bed thickness).

1.0. Materials : (1) Water shall conform to M-1 (2) Cement shall conform to M-3. (3) Sand shall conform to M-6 (4) Stone aggregate 40 run nominal size shall conform to M-12.

2.0. Workmanship

2.1. The relevant specifications of item 5.3.4. shall be followed except that the concrete work shall be carried out in trenches as bedding for stoneware pipes. The width of concrete shall be 300 mm. and average thickness of bedding shall be 112 mm The concrete shall be brought up at least to the invert level of the pipe to form a cradle and to avoid line contact between the pipe and the bed.

3.0. Mode of measurements & payment

3.1. The rate includes cost of all labour and materials required for satisfactory completion of this item.

3.2. The rate includes cost of necessary form work required if any

3.3. The rate shall be for a unit of One running meter.

24.2.(B) Providing and laying cement concrete 1:5:10 (1 cement : 5 fine sand : 10 graded stone aggregate 40 mm. nominal size) bedding for stoneware pipe of following internal diameter with necessary form work and curing complete : 150 mm. dia. 450 mm. width (166 mm. average bed thickness),

1.1. Materials & Workmanship : The relevant specifications of item 24.2 (A) shall be followed except that the cement concrete work shall be carried out for bedding of stoneware pipe of 150 mm. dia. The average thickness of bedding shall be- 166 mm. and width shall be 450 mm.

2.0. Mode of measurements & payment

2.1. The relevant specifications of item 24.2 (A) shall be followed.

2.2. The rate shall be for a unit of One running meter.

24.19(1) Providing and fixing S.W. gully trap with C.I. grating brick masonry chamber and watertight C.I. cover with frame of 300 mm. x 300 mm. size (inside) with standard weight : (A) square mount taps 100 mm. x 100 mm. size P. type

1.0. Materials : (1) Water shall conform to M-1. (2) Cement mortar of proportion 1:5 shall conform to M-11. (3) Burnt brick shall conform to M-15. (4) The S.W. Gully trap of 100 mm. x 100 mm. size shall conform to M-70.

2.0. Workmanship

2.1. Excavation for gully trap shall be done true to dimensions and levels as indicated on plans or as directed. The excavation work shall generally be done as per relevant specifications of item 4.0.0. of earth work.

2.2. Fixing:

2.2.1. The gully trap shall be fixed over cement concrete 1:5:10 (1 cement : 5 sand : 10 graded brick aggregate 40 mm nominal size) foundation. 650 square and 100 mm. thick The depth of top of concrete below the ground level shall be 675 mm. The jointing of gully outlet to the branch drain shall be done similar to jointing of S.W. pipe as described in item No. 24.1 (A).

2.3. Brick masonry chamber : After fixing and testing gully and branch drain, a brick masonry 300 x 330 mm. inside with bricks in CM 1:5 (1 cement : 5 sand) shall be built with a 100 mm. brick work round on; gully trap from the top of bed concrete up to ground level. The space between the chamber walls and

177
the trap shall be filled with cement concrete 1:5:10. The upper portion of the chamber i.e. above the top level of the trap shall be plastered inside with cement mortar 1:3 (1 cement: 3 sand) finished with floating coat of neat cement. The corners and bottom of the chamber shall be rounded off so as to slope towards the grating.

2.4. C.I. cover with frame 300 mm, x 300 mm. (inside) size shall then be fixed on the top of the brick masonry with C.c. 1:2:4 (1 cement : 2 coarse sand : 4 graded aggregate 20 mm. nominal size) 40 mm. thick and rendered smooth. The finished top of the cover shall be left about 40 mm. above the adjoining ground level so as to exclude the surface water from entering the gully trap.

3.0. Mode of measurements & payment

3.1. The rate includes cost of all labour, materials, tools and plant etc. required for satisfactory completion of this item as described above.

3.2. The rate shall be for a unit of one number basis.

24.22. Providing and laying (to level or slopes) and jointing reinforced concrete light duty non-pressure pipes I.S. class N.P. 2 of the following internal diameters with collars and butt ends prepared for collar joints including testing of joints etc. complete. (B) 150mm. (C) 250 mm. (D) 300 mm. (E) 450 mm. (F) 500 mm. (G) 600 mm. (H) 900 mm.(K) 1000mm. (M) 1200 mm.

1.0. Materials : The reinforced concrete light duty non-pressure pipes of specified diameter shall conform to I.S. 458-1971.

2.0. Workmanship

2.1. The relevant specifications of item No. 24.1. A shall be followed for work of trenches except that the excavation in trenches shall be for. reinforced concrete pipes of specified diameter.

2.2. Laying

2.2.1. The pipes shall be lowered into the trenches carefully. Mechanical appliances may be used. Where necessary pipe shall be laid in straight lines or with easy curves and true to line and gradient as specified. The laying of pipe shall proceed upgrade of a slope. In the pipe spigot and socket joints, the socket ends shall face upstream. In case of pipes with joints to be made with loose collars, the collars shall be slipped on before the next pipe is laid.

2.2.2. In case where the foundation conditions are unusual such as the proximity of trees or holes, under existing or proposed all round in 150 mm. thick cement concrete 1:5; 10 (1 cement: 5 fine sand : 10 graded stone aggregate 40 mm. nominal size) or compacted sand or gravel:

2.2.3. In case where the natural foundation is inadequate the pipes shall be laid either in concrete cradle, supported on proper foundations or on any other suitably designed structure. If concrete bedding is used, the depth of concrete below bottom of the pipe shall be at least 1/4th of the internal diameter of the pipe subject to a minimum of 100 mm. and a maximum 300 mm. The concrete shall be extended up the sides of the pipe at least to a distance of 1/4th of the outside diameter for pipes 300 mm. and over in diameter.

2.2.4. The pipes shall be laid in the concrete bedding before the concrete has set. Pipes laid in trenches in earth shall be bedded evenly and firmly and as far as up to the haunches of the pipe as to safely transmit the load expected from the back fill through the pipe to the bed. This shall be done either by excavating the bottom of the trenches to fit the curve of the pipe or by compacting the earth under a round curve of the pipe to form an even bed, Necessary provision shall be made for joints wherever required.

2.3. Jointing

2.3.1. The joints shall be done by slipping the collar over and clear of the end of the pipe. The recess of the end of the pipe shall be filled with jute braiding in hot bitumen. The new pipe shall then be brought forward until the bitumen ring in recess of first pipe is set into the recess of the second pipe. The process shall be repeated for two or three pipes which shall then jacked up so as to thoroughly compress the bitumen. The quantity of jute and bitumen shall be just enough to fill the recess when pressed hard by jacking, care being taken that no offset of the jute braiding shall be visible either outside or inside of pipe. The collar shall then be set up over the joints covering equally both the pipe and leaving, an even caulking space all round. Cement and sand mortar: 1: 1.1/2 shall then be well punched or pressed home with a caulking tool within this caulking space. Care shall be taken that the underside of the joints is properly filled with mortar.

2.4. Curing

2.4.1. Every joints shall be kept wet for about 10 days for maturing. The section of the pipe line laid and jointed shall be covered immediately to protect from weather effects. Minimum bore of 100 mm. is considered adequate.

178

2.4.2. The joints shall be left exposed for observation.

2.5. Testing of Joints :

2.5.1. The testing of joints shall be done as per relevant specifications of item No. 24.1 (A) **except that** the testing of reinforced concrete pipes shall be done.

3.0. Mode of measurements & payment

3.1. The relevant specifications of item 24.1 (A) shall be followed except that the rate includes for laying to level or slope in trenches etc. (measured separately), making the joints a; Seated and testing to stand the water test.

3.2. The measurements shall be net without any allowance for cutting and waste. The length of bends, junctions and other connections (measured along the centre line) shall be included in the total length of the pipes, the connections being numbered afterwards and paid for extra over pipes.

3.3. The size of bend, junctions, etc, shall suit the size of pipe. The bore (internal diameter of pipe) shall be the criterion for payment.)(

3.4. Nothing extra shall be paid separately for the use of mechanical appliances, where necessary, as described above.

3.5. The rate shall be for a unit of One running meter.

2.4.27. Costing Manhole with R.C.C. Top slab in 1:2:4 mix (1 cement: 2 coarse sand : 4 graded stone aggregate 20 mm. nominal size) foundation concrete 1:3:6 (1 cement : 3 coarse sand : 6 bricks bats 40 to 50 mm. size) inside plastering 15 mm. thick with C.M. 1:5 (1 cement : 5 coarse sand) finished with floating coat of neat cement and making channels in C.C. 1:2:4 mix (1 cement : 2 coarse sand : 4 stone aggregate 20 mm. nominal size) finished smooth complete including curing and testing (I) inside size 900 mm. x 120 mm. and 1.5 mm. deep, including C1 cover with frame size 560 mm. diameter, total weight of cover and frame to be not less than 128 Kgs. (Wt. of cover 64 Kg. and Wt. of frame 64 Kg.) (A) With 230 mm. thick walls of brick masonry using bricks having crushing strength not less than 35 kg/sq. cm. in C.M. 1:5 (1 cement : 5 coarse sand)

i. A type depth 0.90 meter for 150 mm. sewer

- ii. B type depth 1.50 meter for 150 mm. sewer
- iii. C type depth 2.25 meter for 150 mm. sewer
- iv. D type depth 3.15 meter for 150 mm. sewer

1.0. Materials : Water shall conform to M-1. Cement shall conform to M-6. Burnt bricks shall conform to M-15. Brick bats of 40 to 50 mm. size shall conform to M-14. Stone coarse aggregate of 20 mm. nominal size shall conform to M-12. Grit shall conform to M-8. Cement mortar of specified proportion shall conform to M-11. The cast iron manhole cover of 560 mm. dia. with frame shall conform to I.S. 1726-1966.

2.0. Workmanship

2.1. The manholes of different types and sizes as specified shall be constructed in sewer line at such places and to such levels and dimension as shown in drawings of as directed.

2.2. The manholes shall be built on a bed of cement concrete 1:3:6 (1 cement : 3 coarse sand : 6 brick bats) (40 to 50 mm. nominal size) to the thickness of the bed concrete shall be 15 cms. for manhole up to 1. M. depth and 20 cms. for manholes over meter and up to over meter and up to 2 meters, depth and 30 cms. for manholes o greater depth.

2.2.2. Projection of bed concrete beyond the masonry wall shall be 15 cms.

2.3. Walls

2.3.1. The walls of manhole shall be carried out with burnt bricks using having bricks. crushing strength not less than 35 Kg/Cms in C.M. 2 in C.M. 1:5 (1 cement : 5 coarse sand). The thickness of brick masonry wall shall be 230 mm. The jointing face of such .brick shall be well buttered with cement mortar before laying so as to ensure a full joints.

2.4. Plaster

2.4.1. The inside of waits shall be plastered 15 mm. thick with C.M. 1:5 (1 cement : 5 coarse sand) and finished with floating coat of neat cement. All angles shall be rounded to 7.50 cms. radius and all rendered internal surfaces shall have hard impervious finish obtained by using a steel trowel. The external joints of masonry shall be finished smooth.

179

2.5. Channels & Benching :

2.5.1. Channels shall be semicircular in the bottom half and of diameter equal to the sewer. Above the horizontal diameter, the sides shall be extended vertically to the same level as the crown of the out going pipe and the top edge shall be suitably rounded off. The branch channels snail also be similarly constructed with respect to the benching but at their junction with the main channel an appropriate fall suitably rounded off in the direction of flow the main channel shall be given.

2.5.2. The channel and benching shall be done in C.C. 1:2:4 (1 cement : 2 coarse sand : 4 graded stone aggregate 20 mm. nominal size) rising at a slop in line from edges of channel. The channels of the bottom of the chamber shall be plastered with C.M. 1:2 (1 cement : 2 coarse sand) and steel troweled smooth.

2.6. Cover slab:

2.6.1. The cover slab of R.C.G. 1:2:4 (1 cement: 2 coarse sand: 4 graded stone aggregate 20 mm. nominal size) 15 cms. thick reinforced with 10 mm. bars at 15 cms. C/C both ways, surface and edges finished fair. Full bearing equal to the width to the width of wall shall be given to the slab on all sides. The frame of manhole cover shall be embedded firmly in R.C.C. slab so that the top of the frame remains flush with the top of R.C.C. slab.

2.7. Testing:

2.7.1. Manhole shall be tested by filling with water to a depth not exceeding 1.2 M. as directed.

2.7.2. After completion of work, manhole cover shall be sealed by means of thick grease.

3.0. Mode of measurements and payment

3.1. The depth of manholes shall be distance between the top of the manhole cover and the invert level of the main drain. The rate includes all labours, materials, tools, and plant etc. required for satisfactory completion of this item as directed above.

3.2. The rate shall be for a unit of the One number.

24.28.(I) Extra rate for constructing B.B. masonry for every additional depth of 0.1 M. or part thereof over item 24.47 (I) for depth from 0.90 to 1.5 M.

1.0. Materials and Workmanship

The relevant specifications of item No. 24.27 (I) shall be followed for excavation same, except that the depth of manhole shall be done 0.1 M. or part there of more then 0.90 meter up to 1.5 M. The extra payment shall be made for additional depth of 0.1 M. or part thereof manhole done over and above the depth 0.90 meter.

2.0. Mode of measurements and payment

2.1. The relevant specifications of item No. 24.27 (I) shall be followed except that the extra rate shall be paid for every additional depth of 0.1. M. and part there of shall be paid over and above the rate of item No. 24.27 (I)

2.2. The rate shall be for a unit of One number.

24.28.(II) Extra rate for constructing B.B. masonry for every additional depth of 0.1 M. and Part thereof over item 24.27 (II) for depth from 1.5 M. to 2.25 M.

1.0. Materials and Workmanship : The relevant specifications of item No. 24.27 (II) shall be followed except that the depth of manhole shall be done 0.1 M. or part thereof more than 1.5 M. up to 2.25 M. The extra payment shall be made for additional depth of 0.1 M. or part thereof manhole done over and above the depth 1.50 M. up to 2.25 M.

2.0. Mode of measurements & payment

2.1. The relevant specifications of item No. 24.27 (II) shall be followed except that the extra rate shall be paid for 0.1 M. or part thereof additional depth of manhole provided over and above item \4.27 (II).

2.2. The rate shall be for a unit of One number.

24.28.(II) Extra rate for constructing B.B. masonry for every additional depth of 0.1 M. or part thereof

over item 24.27 (III) for depth from 2.25 to 3.15 M.

180

1.0. Materials and Workmanship : The relevant specifications of item No. 24.27 (III) shall be followed except that the depth of manhole shall be done 0.1 M. or part thereof more than 2.25 M. up to 3.15 M. Extra payment shall be made for additional depth of 0.1. M. or part thereof manhole done over and above depth 2.25 M. up to 3.15 M.

2.0. Mode of measurements & payment

2.1. The relevant specifications of item No. 24.27 (III) shall be followed except that the extra rate shall be paid for every addition 0.1 M. or part thereof depth provided over and above it -m 24.27 (III).

2.2. The rate shall be for a unit of One number.

24.28.(IV) Extra rate for constructing B.B. masonry for every additional depth of 0.1 M. or part thereof over item 24.27 (IV) for depth above 3.15 M.

1.0. Materials and Workmanship : The relevant specifications of item No. 24. 27 (IV) shall be followed except that the depth of manhole shall be done 0.1 M. or part thereof more than 3.15 M above. 1.2. Extra payment shall be made for additional depth of manhole 0.1 M. or part thereof done above 3.15 M. and above depth.

2.0. Mode of measurements and payment

2.1. The relevant specifications of item 24.27 (IV) shall be followed except that extra rate shall be paid for every additional 0.1 M. or part thereof depth provided for an above item 24.27 (IV).

2.2. The rate shall be for a unit of One number.

24.33. Providing and fixing C.I. steps of sizes 500 x 150 mm. 22.5 mm. and painting with two coats of anti-corrosive paint etc. complete.

1.0. Materials : The C.I. steps of size 500 x 150 x 22.5 mm. size shall conform J.S. 5455-1969. Paint shall conform to M-44.

2.0. Workmanship

2.1. The C.I. steps of size 500 x 150 x 22.5 mm. size shall be fixed in manhole as and where directed. The steps shall be staggered in vertical runs 380 mm. apart horizontally. The top step shall be 450 mm. below the manhole cover and lowest not more than 300 mm. above the benching. The steps shall be embedded in wall of manhole with C.C. : 1:3:6 up to 200 m. depth and the surface finished with cement plaster 15 mm. thick in C.M. 1:5. The steps shall be painted with two coats of anti-corrosive paint.

3.0. Mode of measurements & payment

3.1. The rate includes all labour, materials, tools and plants etc. required for satisfactory completion of this item.

3.2. The rate shall be for a unit of One number.

24.39. Providing and erecting at the site of work steel ventilating column of 150 mm. internal dia. and 12.20 M. high from G.L. to bottom of top grill, including C.I. grill and base plate, bolts and nuts etc. and excavation in foundation of size 120 x 120 x 165 cms. and filling the pit with 1st layer of cement concrete 1:3:6 mix (1 cement: 3 coarse sand : 6 graded stone aggregate 20 mm. nominal size) of size 120 x 120 x 90 cm. and remaining pit with B.B.C.C. 1:3:6 mix (1 cement : 3 coarse sand : 6 brick bats 40 to 50 mm. size) and providing filled in cement concrete : 1:2:4 mix (1 cement : 2 coarse sand : 4 graded stone aggregate 20 mm. nominal size) at G.L. and 3 coats of silver paint etc. complete.

1.0. Materials :

The steel ventilating column internal dia. 150 mm. 12.20 m. high shall be of standard many and best quality as approved. Stone aggregate of 20 mm. nominal size shall conform to M-12. Brick-bats-40 to 50 mm. nominal size shall conform to M-4. Cement shall conform to M-3. Water shall conform to M-1. Silver (Aluminum) paint shall conform to I.S. 2339-1963.

2.0. Workmanship

2.1. The vent shaft shall be provided at the starting point of main sewer and at such points where the flow of sewerage is disturbed i.e. at falls, siphons etc. As far as possible, the location shall be at such a place where it receive Sundays for the maximum period of the day.

2.2. A pit of 120 x 120 x 165 ms. size shall be dug The cement concrete of 1:3:6 (1 cement : 3 coarse sand : 6 graded stone aggregate 20 mm. nominal size) shall be first laid in the pit to form 90 cms. thick

181

concrete foundation which shall be allowed to set for 24 hours. The vent shaft shall then be erected at the centre of the pit truly in plumb by means of such as shear legs, pullies, backless and rope etc.

2.3. The connection with sewer man-hole shall be made using 150 mm. diameter cement concrete pipe. After the connection is completed, the pit shall be filled with cement concrete : 1:3:6 (1 cement: 3 coarse sand : 6 brick bats 40 to 50 mm. nominal size) round the vent shaft up to ground level except top 150 mm. which shall be filled with C.C. 1:2:4 (1 cement : 2 coarse sand : 4 graded stone aggregate 20 mm. nominal size) and rendered smooth. The junction of vent shaft with cement concrete shall be grouted with cement mortar 1:1 (1 cement : 1 sand). The concrete work shall be cured for 7 days.

2.4. The steel shaft shall be painted with silver paint (aluminum paint) 3 coats. The relevant specifications of item of painting shall be followed for painting.

3.0. Mode of measurements and payment

3.1. The rate shall include the cost of all labours and materials, tools and plant etc. required for satisfactory completion of this item as directed above.

3.2. The rate shall be for a unit of One number.

24.00.1.(A) Providing and laying lime concrete 1:2:4 (1 Lime Putty : 2 fine sand : 4 graded brick aggregate 40 mm. nominal size) bedding for stoneware pipes of following internal diameters with

necessary form work and curing complete : 100 mm. dia (112 mm. average, bed thickness).

1.0. Materials : Water shall conform M-1. Lime mortar shall conform to M-10. Brick aggregate 40 mm. nominal size shall conform to M-14.

2.0. Workmanship

The relevant specifications of item No 5.1.8 shall be followed except that the proportion of mix shall be 1:2:4 (1 Lime Putty : 2 fine sand : 4 graded brick bats aggregate 40 mm. nominal size) and the concrete work shall be done in trenches for bedding of stoneware pipes of 100 mm. dia. The width of concrete shall be 300 mm. and the thickness of bedding shall be 112 mm. average.

3.0. Mode of measurements and payment

3.1. The relevant specifications of item 24.2 (A) shall be followed.

3.2. The rate shall be for a unit of One running meter.

24.00.1(B) Providing and laying lime concrete 1:2:4 (1 Lime Putty : 2 fine sand : 4 graded brick aggregate 40 mm. nominal size) bedding for stoneware pipes of following internal diameters with necessary form work and curing complete :150 mm. dia. (166 mm. average bed thickness).

1.0. Materials and workmanship : The relevant specifications of 24.00.1 (A) shall be followed except that the concrete bedding shall be carried out for 150 mm. dia. stoneware pipe. The width of concrete bedding shall be 450 mm. and the average thickness shall be 166 mm.

2.0. Mode of measurements and payment

2.1. The relevant specifications of item No. 24.2 (A) shall be followed.

2.2. The rate shall be for a unit of One running meter.

24.27(1) Extra over item 24.1 for providing salt glazed stoneware fittings : Bends of required degree (Any Radius) of following internal diameters : A-100 mm. dia. B-150 mm. dia.

1.0. Materials & Workmanship

The relevant specifications of item 24.1 (A) shall be followed that the salt glazed stoneware bends of any degree of specified diameter shall be provided.

2.0. Mode of measurement & payment

2.1. The relevant specifications of item No. 24.1 (A) shall be followed except that extra payment shall be made for providing salt glazed stoneware bend of specified diameter or required degree of any radius over above the of item No. 24.1.

2.2. The rate shall be for a unit of One number.

182

24.17.(I)(A) Extra over item 24.1 for providing salt glazed stoneware fittings : Taper bend of required degree of following internal diameter. 100 mm. x 150 mm.

1.0. Materials & Workmanship : The relevant specifications of item 24.1 (A) shall be followed except that the salt glazed stoneware taper bend of required degree of 100 mm. x 150 mm. shall be fixed.

2.0. Mode of measurements & payment

2.1. The relevant specifications of item No, 24.1 (A) shall be followed except that extra payment shall be made for providing salt stoneware taper bend of required degree of 100 mm. x 150 mm. size over and above the rate of item No. 24.1.

2.2. The rate shall be for a unit of One number.

24.17.(II) Extra over item 24.1 for providing salt glazed stoneware fittings : Single junction of required angle of following internal diameter (A) 100 mm. dia. (B) 150 mm. dia.

1.0. Materials & Workmanship

The relevant specification of item 24.1 (A) shall be followed except that the salt glazed stoneware single of junction required angle of specified diameter shall be fixed.

2.0. Mode of measurements & payment

2.1. The relevant specifications of item 24.1 (A) shall be followed except that the extra rate shall be paid for providing salt glazed stoneware single junction of required angle for specified diameters over and above the rate of item 24.1.

2.2. The rate shall be for a unit of One number.

24.18. Providing and laying, jointing and pointing with stiff mixture of C.M. 1 : 1 (1 cement : 1 fine sand) 150 mm. internal diameter salt glazed stoneware half round channels.

1.0. Materials and Workmanship : The relevant specifications of item 24.1 shall be followed except that the half round channels of 150 mm. internal diameters shall be fixed in cement mortar 1:1.

2.0. Mode of measurements and payment

2.1. The relevant specifications of item 24.1 (A) shall be followed.

2.2. The rate shall be for a unit of One running meter.

24.35. Supplying and fixing C.I. cover 300 x 300 mm. without frame for gully trap (Standard pattern), weight of cover shall not be less than 4.53 Kg.

2.0. Workmanship

The C.I. cover 300 x 300 mm. size without frame shall be fixed on top of the brick masonry with cement concrete : 1:2:4 (1 cement : 2 sand : 4 graded stone aggregate 20 mm. nominal size) 40 mm. thick and rendered smooth. The finished top of the cover shall be left about 40 mm. above the adjoining ground level so as to exclude the surface water from entering the gully trap.

3.0. Mode of measurements and payment

3.1. The relevant specifications of item No, 24.19 shall be followed.

3.2. The rate shall be for a unit of One number.

24.40. Constructing brick masonry road gully chamber 500 mm. x 450 mm. x 600 mm. including 500 mm. x 450 mm C.I. horizontal grating with frame complete.

1.0. Materials : Water shall conform to M-1. Cement shall conform to M-3. Sand shall conform to M-6. Brick shall conform to M-15. C.I. Grating of 500 x 450 mm. size of standard make shall be of approved quality. Stone aggregate 40 mm. nominal size shall conform to M-12. coal tar shall conform to relevant M-5.

2.0. Workmanship

2.1. The chamber shall be of size 500 mm. x 450 mm. internal clear dimensions between the masonry wall faces. The height of 500 mm. shall be measured from the top of the bed concrete to the top of the C.I.

183

frame. The size of grating indicate the clear internal dimensions of the C.I. frame of the grating.

2.2. The excavation shall be done to true dimensions and levels.

2.3. The foundation concrete shall consist of 150 Cms x 100 Cms x 15 cms thick C.C. 1:5:10(1 cement : 5 sand : 10 graded stone aggregate 40 mm. nominal size).

2.4. The wall of the chamber shall be constructed in brick work C.M. 1:5 and 23 Cms. thick as per relevant specifications of item 6.12(8).

2.5. The walls and the bed concrete of chamber shall be plastered inside with 12 mm. thick cement plaster 1 : 3 (1 cement : 3 coarse sand) finished smooth.

2.6. The gully grating cover shall be hinged to frame to facilitate its opening for cleaning and repairs. The frames of the gully grating shall be fixed on the top of masonry wall of the chamber in 15 cms. thick C.C. 1:2:4 (1 cement : 2 coarse sand : 4 graded stone aggregate 20 mm. nominal size) laid over the full thickness of walls..

2.7. The chamber shall have connection pipe, the length of which in meter between the road gully chamber and the manhole of the drain shall not be less than 1/40 times the nominal diameter of the pipe in MM. i.e. for 150 mm* connection pipe the length shall not be cement plaster on the bed concrete.

2.8. Painting : After the completion of the work of exposed surface of the grating of the frame shall be painted with a thick coat of coal tar.

3.0. Mode of measurements and payment

3.1. The cost of connection pipes is not included in the item and shall be paid separately. However, fixing the connection pipes in the walls of gully chamber is included in the rate for gully chambers and nothing extra shall be paid for this separately.

3.2. The rate shall be for a unit of One number.

24.41. Constructing brick masonry road gully chamber 450 mm. x 450 mm. x 775 mm. with vertical grating complete.

1.0. Materials and Workmanship : The relevant specifications of item 24.40 shall be followed except size of road gully chamber is 450 mm x 775 mm. with vertical grating complete.

2.0. Mode of measurements and payment

2.1. The relevant specifications of item 24.40 shall be followed.

2.2. The rate shall be for a unit of one number.

24.42. Constructing brick masonry road gully chamber 1100 mm. x 500 mm. x 775 mm. including 500 mm. x 450 mm. C.I. horizontal grating with frame and vertical grating complete.

1.0. Materials and Workmanship : The relevant specifications of item 24.40 shall be followed except that the size of road gully chamber shall be 1100 mm. x 500 mm. x 775 mm. including 500 mm. x 450 mm. C.I. horizontal grating with frame and vertical grating complete.

2.0. Mode of measurements and payment

2.1. The relevant specifications of item No. 24.40 shall be followed.

2.2. The rate shall be for a unit of one sq. meter.

24.44(1) Constructing brick masonry chamber for underground C.I. inspection chamber and bends with brick having crushing strength not less than 35 Kg/ Cm. 2 in C.M/ 1:5 C.I. cover with frame (light duty) 455 x 610 mm. internal dimensions, total weight of cover with frame to be not less than 38 Kg. (Wt of cover 23 Kg. and Wt of frame 15 Kg.) R.C.C. top slab C.C. 1:2:4 mix (1 cement : 2 coarse sand : 4 graded aggregate 20 mm. size) foundation concrete 1:5:10, inside plaster 15 mm. thick with C.M. 1:3 finished smooth with a finishing coat of neat cement on walls and bed concrete etc. complete : Inside dimensions 455 mm. x 610 mm. and 450 mm. deep for single pipe-line.

184

1.0. Materials : Water shall conform to M-1. Cement shall conform to M-3. Coarse sand shall conform to M-5. Brick shall conform to M-15. Stone aggregate shall conform to M-12. Brick bat shall conform to M-14 M.S. bar shall conform to M-18.

2.0. Workmanship

2.1. C.I. inspection chamber with provision of C.I. bends of specified size with bolts, nuts and felt washers for underground drain shall be enclosed in masonry chamber which shall be constructed as under:

2.2. The excavation shall be done true to dimensions and level shown in one the plans or as directed.

2.3. Bed concrete shall be 15. Cms, thick C.C. 1:5:10 (1 cement : 5 coarse sand : 10 graded brick bat aggregates. The projection of bed concrete beyond the masonry walls shall be 7.5 cms.

2.4. Masonry walls and plaster work shall be carried out as per relevant specifications of item 24.40.

2.5. The cover slab shall be constructed as per relevant specifications of 24.27 (I).

3.0. Mode of measurements and payment

3.1. The earth work in excavation, providing and laying C.I. inspection chamber and bends shall be measured and

paid for separately.

3.2. The rate shall be for a unit of One number.

24.44.(I) Constructing brick masonry chamber for underground C.I. inspection chamber and bends with brick having crushing strength not less than 35 Kg/ Cm. 2 in C.M/ 1:5 C. cover with frame (light duty) 455 x 610 mm. internal dimensions, total weight of cover with frame to be not less than 38 Kg. (Wt of cover 23 Kg. and Wt of frame 15 Kg.) R.C.C. top slab with 1:2:4 mix (1 cement : 2 coarse sand : 4 graded stone aggregate 20 mm size) foundation concrete 1:5:10, inside plaster 15 mm. thick with C.M. 1:3 finished smooth with a floating coat of neat cement on walls and bed concrete etc. complete : Inside dimensions 500 mm. x 700 mm. and 450 mm. deep for pipe the with one or two inlets.

1.0. Materials and Workmanship : The relevant specifications of item 24.44 (I) shall be followed except that the inside dimension of brick masonry chamber shall be 500 mm. x 700 mm. and 450 mm. deep for pipe the with on two inlets.

2.0. Mode of measurement and payment

2.1. The relevant specifications of item 24.44 (I) shall be followed. 2.2 The rate shall be for a unit of one number.

24.44.(II) Constructing brick masonry chamber for underground C.I. inspection chamber and bends with brick having crushing strength not less than 35 Kg/ Cm. 2 in C.M/ 1:5 C.I. cover with frame (light duty) 455 x 610 mm. internal dimensions, total weight of cover with frame to be not less than 38 Kg. (Wt of cover 23 Kg. and Wt of frame 15 Kg.) R.C.C. top slab with 1:2:4 mix (1 cement : 2 coarse sand : 4 graded stone aggregate 20 mm. size) foundation concrete 1:5:10, inside plaster 15 mm. thick with C.M. 1:3 finished smooth with a floating coat of neat cement on walls and bed concrete etc. complete : Inside dimensions 600 mm. x 850 mm. and 450 mm. deep for pipes line with three or more inlets.

1.0. Materials and workmanship : The relevant specifications of item No. 24 .44 (I) shall be followed except that the inside dimensions of chamber shall be 600 mm, x 850 mm. and depth 450 mm. for pipe lines with three or more inlets.

2.0. Mode of measurements & payments

2.1. The relevant specifications of item 24.44(1) shall be followed.

2.2. The rate shall be for a unit One number.

185

24.46. Extra over item 24.44 for every additional depth of 1 M. or part thereof beyond 450 mm. depth for brick masonry chamber, (i) For 455 mm. x 610 mm. size (ii) For 500 mm. x 700 mm. size (iii) For 600 mm. x 850 mm. size.

1.0. Materials & Workmanship : The relevant specifications of item 24.44 (i),(ii) (iii) shall be followed same except that extra depth of 0.1 M. or part thereof shall be constructed over and above the depth of respective items.

2.0. Mode of measurements & payment

2.1. The relevant specifications of item 24.44 (I) shall be followed except that the extra shall be paid for, providing additional depth of 0.1 M. or M. or part thereof over and above the item No 24.44. (I) 24.44 (II) 24.44 (III) as the case may be.

2.2. The rate shall be for a unit of One number.

24.00.2.(A) Providing soak pit of 2 cum. volume including excavating and filling brick bats with dry masonry work at top for 450 cms. height including covering, the top with stone including providing Vatas in C.M. 1:3 with finishing curing etc. complete as directed.

1.0. Materials : Water shall conform to M-1. Cement mortar con form to M-11. Burnt Bricks shall conform to M-15. Rough stone slab 40 x 50 mm. thick shall conform to M-48. Brick bat shall conform to M-14.

2.0. Workmanship

2.1. The excavation for soak pit shall be carried out as. per relevant specifications of item. 4.G0.1 (A) except that the size of soak pit such that the cleat volume 'Shall* remain 2 cum. The diameter and depth shall be as directed.

2.2. The periphery of the sock pit shall be provided with dry masonry wall with burnt bricks in 23 cms. thick. The masonry wall shall be done with best workman like manner in true line and plumb.

2.3. The soak pit shall be filled in with brick bats of burn brick 40 mm. nominal size in 45 cms. height. The work of filling brick-bats shall be done in such a way that no dry masonry shall be damaged during filling of brick bats.

2.4. The top of the soak pit shall be covered with rough kotah stone slab 40 to 50 mm. thickness. The length of the stone shall be in single piece in length.

2.5. The cement mortar 1:3 shall be used to fill up the joints and preparing vata as directed.

2.6. The cement work shall be cured for 4 days.

3.0. Mode of measurements and payment

3.1. The rate includes costs of all labour and material required for satisfactory completion o this item as described above.

24.00.2.(B) Providing soak-pit of 5 cum. Volume inc. excavating and filling brick bats with dry masonry work at top for 45 cms. height including covering the top with stone including providing vatas in C.M. 1:3 with finishing curing etc. complete as directed.

1.0. Materials and workmanship : The relevant specifications of item 24.00.2 (A) shall be followed except that the volume of soak pit shall be 5 cum. clear.

2.0. Mode of measurements and payment

2.1. The relevant specifications of item 24.00.2 (A) shall be followed.

2.2. The rate shall be for a unit of One number.

186

EQUIVALENT PLAIN AREAS OF UNEVEN SURFACES

(Vide specifications for items relating to : Painting & Polishing)

Sr.

No.

Description of work How measured Multiplying Factor

1. Paneled or framed and braced on

ledged and battened or ledged

and braced joinery.

Measured flat (not girthed) including chowkhat

or frame edges, chocks clients etc. shall be

deemed to be included in item.

1.30 (For each said)

2. Flush joinery Measured flat (not girthed) including chowkhat

or frame. Edges, Chocks, cleats, etc. shall be

deemed to be included in the item.

1.20 (For each side)

3. Fully glazed or gauzed joinery Measured flat (not girthed) including chowkhat

or frame. Edges, Chocks, cleats, etc. shall be

deemed to be included in the item.

0.80 (For each side)

4. Partly paneled and partly glazed

or gauzed joinery

Measured flat (not girthed) including chowkhat or

frame. Edges, Chocks, cleats, etc. shall be

deemed to be included in the item.

1.00 (For each side)

5. Fully venetioned or louvered

joinery.

Measured flat (not girthed) including chowkhat

or frame. Edges, Chocks, cleats, etc. shall be

deemed to be included in the item.

1.80 (For each side)

6. Weather boarding Measured flat (not girthed) supporting frame

work shall not be measured separately.

1.20.(For each side)

7. Wood single roofing Measured flat (not girthed) 1.10(For each side)

8. Boarding with cover fillets at

match boarding

Measured flat (not girthed) 1.05 (For each side)

9. Tile and Slate battening Measured flat, overall, no deduction shall be

made for open space over

0.80 (For painting all

over)

10. Trellis (or Jafri) work one way or

two way

Measured flat, over all, no deduction shall be

made for the open spaces supporting members

shall not be measured separately)

1.00 (For painting all

over)

187

11. Guard, bars, balustrades, gates,

graying, grills, expanded metal

and railings.

Measured flat over all, No deduction shall be

made for the open spaces, over) supporting

members shall not be measured separately.

1.00 (For painting all

over)

12. Gates and open palisade fencing

including standards

Measured flat over all No. deduction shall be

made of open spaces : supporting members

shall not be measured separately, (see note).

1.00 painting all over

13. Curved or enriched work Measured flat 2.0 (For each side)

14. Steel roller shutter Measured flat (size of opening)over all jamb, guides bottom rails and locking arrangement etc., shall be included in the item (top cover shall be measured separately).

1.10 (For each side)

15. Plain sheet door and windows Measured flat (not including) frame 1.10 (For each side)

16. Full glazed or gauze steel door and windows

Measured flat (not girthed) including Frame edges etc.

0.50 (For each side)

17. Partly paneled and partly glazed or gauzed steel doors

Measured flat (not girthed) including frame edges etc.

0.08 (For each side)

18. Collapsible gate Measured flat (size of opening) no separate measurements shall be taken for the top and bottom guide rails, rollers, fittings, etc.

1.50 (For painting all over

Note : The height shall be taken from the bottom of the lowest of rail if the palisades do not go below it (or from the lower end of palisades, if they protect below the lower rail) up to the top of palisades, but not upto the top of standards if they are higher then the palisades.

188

Sr. No.

Particulars of fixtures

& fastenings

Size in mm

Da. S.1:B-900-T-38

Da. S.1:B-900-T-38

Da. S.1:B-900-T-38

Da. S.1:B-900-T-38

Da. S.2:B-900-T-38

Da. S.2:B-900-T-38

Da. S.2:B-900-T-38

Da. S.2:B-900-T-38

1. Hold fast 300 x 40 x 3 6 6 6 6 6 6 6

2. Hold Fast 200 x 40 x 36 - - - - -

3. Coach \screws (Hexagonal Head) - - - - -

4. Butt Hinges 125 - - - 3 - - - 6

5. Bun Hinges 100 3 3 3 - 6 6 6 -

6. Butt Hinges 75 - - - - -

7. Butt Hinges 75-A - - - - -

8. Butt Hinges 50 - - - - -

9. Non projecting type Hinges (Box type) 22 - - - - -

10. Tee & Strap Hinges 300 - - - - -

11. Tee & Strap Hinges 200 - - - - -

12. Sliding Door Bolts 250 x 16 1 1 1 1 1 1 1 1

13. Tower Bolts (Barrel Type) 200 x 10 1 1 1 1 2 2 2 2

14. Tower Bolts (Barrel Type) 150 x 10 - - - - -

15. Tower Bolts (Barrel Type) 100 x 10 - - - - -

16. Tower Bolts (Barrel Type) 75 x 10 - - - - -

17. Tower Bolts (Barrel Type) 50 x 6 - - - - -

18. Door Latch 200 x 16 x 5 1 1 1 1 1 1 1 1

19. A Hooks and Eye 20 mm - - - - -

20. Bathroom Latches 60 x 12 - - - - -

21. Casement window fasteners - - - - -

22. Casement Stays (Straight Peg Stay O - - - - -

23. Ventilator Catch Lug. - - - - -

24. Handles 100 2 2 2 2 2 2 2 2

25. Handles 75 - - - - -

26. Doorstopper 75 1 1 1 1 2 2 2 2

27. Wooden Door Stop with Hinges - - - - -

28. Continuous Piano Hinges 30 width 30 width - - - - -

29. Haps and Staples (Safety types) 115 x 40 - - - - -

30. Haps and Staples (Safety types) 90 x 40 - - - - -

31. Cupboard Lock (6 Levers) -----

32. Cupboard Knob -----

189

Sr. No.

Db : S.1

Dc : S.1 : 900

Dc : S.1 : B : 900

Dd : S.1 : B : 900

Dd : S.1 : B : 900

De : S.1 : B : 900

De : S.1 : B : 900

Wa : S.1 : H : 1200

Wa : S.1 : B : 1200

Wa : S.2 : H : 1200

Wa : S.2 : H : 1200

Va : Ind.

S.W.

Sv-Ind

Wardrobe-S.2

Showcase : CC : S.2

General : CB : S.2

Kitchen : CB : S.2

Platform : CB : S.2

Countersunk Wood Screw

Size of Screws in mm

and No. of Screws per

Unit of fixture fastenings

1. 6 6 6 - 6 6 6 4 6 4 6 ----- 2 ----

2. ----- 4 --- 4 4 4 ----- 2 ----

3. ----- 8 8 8 8 8 4 -----

4. ----- 8 ---

5. 3 ----- 8 --

6. ----- 2 3 4 6 2 ----- 6 ---

7. ----- 4 4 8 --- 6 --

8. ----- 4 -- 4 --

9. ----- 2 2 -----

10. -- 3 - 3 - 3 ----- 8 ----

11. - 3 - 3 - 3 ----- 7 ----

12. - 1 1 1 1 1 1 ----- 16

12

--

13. ----- 8 --

14. - 1 1 1 1 1 1 ----- 6 --

15. ----- 2 2 3 3 ----- 6 --

16. ----- 1 ----- 6 --

17. ----- 2 2 2 4 ----- 6

18. -- 1 1 1 1 ----- 2 -

19. ----- 1 1 2 2 1 2 1 -----

20. ----- 6/4

21. ----- 1 -----

22. ----- 1 1 -----

23. ----- 1 -----

24. 2 2 2 2 2 2 ----- 2 -- 2 ---- 4 -

25. ----- 1 1 2 2 1 ----- 2 4 2 -- 4 -

26. ----- 8

4

-

27. - 1 1 1 1 1 1 ----- 6 -

28. ----- 2 - 2 ----- 2

Per 75 mm. length

29. ----- 1 1 1 ----- 7

30. ----- 1 ----- 1 --- 7

31. ----- 4

32. ----- 1 -----

190

CODE OF PRACTICE C-13 (B)

SCHEDULE OF FIXTURES AND

FASTENINGS FOR DOORS,

WINDOWS, VENTILATORS,
WARDROBES AND CUPBOARDS

NOTATIONS

- Da..... Teakwood doors
fully paneled or fully
glazed or partly
paneled : and
glazed
- Db..... Bathroom and W.C.
door with single
shutter
- Dc..... Doors plying
planked
- Dd..... Doors battened
framed and braced
- Wa..... Teakwood windows
fully paneled or fully
glazed or partly
paneled and glazed
- Va-Ind..... Teakwood ventilator
(independent)
- S.W..... Steel Windows
- SV-Ind..... Steel ventilators
(independent)
- CB..... Cupboard
- S.1..... Single shutter
- S.2..... Double shutter
- S.4..... Four shutter
- B..... Breadth of door
shutter
- T..... Thickness of door
shutter
- H..... Height of window
shutter.
- 900..... 900 mm & below
- 900..... above 900 mm
- 1200..... 1200 mm & below
- 1200..... above
- 191

NOTE : PLEASE READ CAREFULLY :

- (1) Where detailed specification of an item provides for specific size of any fixture or fastening that shall prevail over the provisions in this schedule.
- (2) Fixtures and fastenings (except hold fasts which shall be of M.S. plate only) shall be of Brass, copper, oxidised brass, chromium plated brass, Iron, copper oxidised iron, or chromium plated iron as specified in the item of the work or dallied specifications.
- (3) External door and door failing in staircase excepting the door in balcony shall have sliding door bolt of size 300 mm. x 18 mm. in place of 250 mm. x 16 mm- as shown in this schedule.
- (4) The length of tower old shown is for a door having shutter height up to 2100 mm. only. For door having shutter height more than 2100 mm. the length of tower bolts to be increased to the extend of increase of door shutter height beyond 2100 mm.
- (5) 150 mm. x 150 mm. size glass vision panel shall be provided in the doors of Officers chamber in addition to the scheduled provision if so directed by the Engineering in charge.
- (6) Diamond shape chromium plated brass peeping plate of approved quality shall be provided in one entrance door in residential building in addition to the scheduled provisions.
- (7) Drawer up a wardrobe shall be provided with one furniture handle and one drawer lock (4 levers) in addition to its scheduled provision.
- (8) For door and window with steel frame, 75 mm. size screws, shall be provided both in top bottom frame for fixity as shown below:
 - (a) For width up to 1200 mm.....2 Nos.
 - (b) For width above 1200 mm. and up to 1800 mm.....3 Nos.
 - (c) For every additional width of 500 mm. over and above 1800 mm.....1 No.
- (9) When the mortise lock (6 levers) and latch is specified to be provided to a door either in the item of work itself or by a separate amity, the requirement of providing sliding door bolt, door latch and handles as per his schedule shall be dispensed with.
- (10) For door/window with ventilator at top, fixtures and fastenings of door/window plus those of ventilator (excluding hold fasts) shall be used.

(11) Where the item of the work, or its specification provides for anodised aluminum fixtures, all the fixtures except hinges and screws will be of anodised aluminum and chromium plated iron hinges and screws shall be used.

(12) For door, window, or cupboard frame abutting concrete section, instead of hold fasts as shown in the schedule-, coach screws of size mentioned below shall be used:

(a) Teak wood frame..... 125 mm.

(b) Steel frame..... 75 mm.

(13) The locking etc. in the door latch shall be so positioned that the can be properly rocked even if part of the latch, when fully slided, remains in the frame or masonry.

(14) Showcase cupboards having single shutter shall be provided with all catcher instead of tower bolt (barrel type) as per schedule.

(15) The size of the handle shown in the schedule indicates grip length.

(16) Door stopper shall be shown in the schedule indicates grip length.

(17) Piano hinges shall be for the full height of the shutter.

(18) Shutter with pivot arrangements shall be pivot arrangement shall be provided with two pivots of approved size instead of hinges as per the schedule.

(19) For butt hinges, only lengths are indicated in the schedule. The width of each flap being 5 mm. less than the thickness of the shutter to which they are to be fixed and the thickness of the flap shall be as specified in the relevant I.S. for heavy, medium or light as specified in the detailed specifications of the item of work.

Schedule for Testing of Materials

For ensuring quality control and workmanship, various test prescribe below corresponding to the material concerned shall be taken as periodic intervals as stipulated below be taken.

The Material shall be got tested Govt. recognized Laboratory (R & B) or field Laboratory of GERI (R & 6) for which 1 % of the estimated amount to tender shall be recovered from the contractor from the R.A. Bill and Final Bills as the testing charges shall be paid by the Govt. to the GERI. However if the charges increase over 1 % no excess recovery shall be made from the contractor as per resolution of B&C department dated 10th May 1985, vide TNC/1085 (4) S. Item No.

as per

Sch. B

Brief Description of

Materials to be tested

Qty. of

Material

Prescription of test which shall
be carried out

Frequency @ which test
shall be carried out

Total No. of

Test to be

taken

1. Kapchi - Gradation test

-

- Impact Value

- Flakiness Index of aggregate

CMT 1 to 100 – 1 test

100 to 500 – 3 tests

500 to 1500 – 5 tests

1500 to 5000 – 7 tests

2. Grit - Stripping Value

3. Sand - Special gravity

- Water absorption

- Fineness Modulus

- Silt – Content

- Soundness

4. Tiles - Dimension Test

- Transverse strength

- Water Absorption

- Abrasion Test

5. Teakwood - Anatomy Test

- Density Test

- Moisture Content Test

6. Bricks - Water absorption

- Effluence

- Size

- Comprehensive Strength

1 Test @ 50,000 Bricks

7. Cement - Consistency

- Setting Time

- Compressive Strength

1 Test @ 10.0 M.T.

As per manual of Quality

Control

8. Steel - Tensile Strength

- Yield Stress

- Elongation

- Size

9. C.C. Cube test 1:2:4 - Compressive Strength 1 to 5 Cum. 1 No.

6 to 15 Cum. 2 Nos.

16 to 20 Cum. 3 Nos.

21 to 50 Cum. 4 Nos.

51 & Above Cum. 4 +

1 for each Cum or part

thereof

The contractor shall have to pay 1% of the estimate cost put to tender towards all testing of materials & same shall be deducted from their bills for the works. The testing of various materials shall be carried out in GERI and result received shall be binding to all. i.e. contractor and Govt.

Testing Charges of GERI shall be born by Govt. No refund be made or extra charge over 1 % shall be recoverable form the contractor.

SIGN OF CONTRACTOR

Signature of The Contractor

**Signature of EXECUTIVE ENGINEER
BUILDING DEPARTMENT**

**BHAVNAGAR MUNICIPAL CORPORATION
BHAVNAGAR**

SPECIFICATION FOR LANDSCAPING WORK

1. AREA CLEANING:

Clearing of the site and roughly dressing the same manually or mechanical devices, including cutting down all waste vegetation, removal of the existing roots of plants/trees, removing debris or previously executed civil work.

2. AREA DRESSING & LEVELING

(2"-3" spreading of existing soil & manual compaction as per drawing, design , specification and direction of EIC. Making the soil free from debris, weeds etc. (Minimum of 90% accuracy required).

3. SHRUBBERY /HEDGE PLANTATION

(To be planted on soil already area dressed or contoured. All shrubs to be as per specified in list attached. Development of bed, plantation of shrubbery including application of FYM (5.00 M3 in 100 M2). Average 7 plants in 1 M2.

4. GRASS PLANTATION

(To be planted on soil already area dressed or contoured. All grasses to be as specified

as per list. Development of bed, plantation of shrubbery including application of FYM (5.00 M3 in 100 M2). (*Vetiveria zizanioides*, *Saccharum munja* grass)

5. TREE PLANTATION (10' to 12' height)

(supply & plantation): To be planted on soil already area dressed or contoured.

Excavation of pit 1mt x 1mt x 1mt depth.

Mixing of FYM & existing soil in ratio 1:2 and planting of plants. Trees to be as er specified in the attached list. Tree plantation should be carried out neatly accurately and with perfection as per the design and drawing. Plastic bags or pots should be removed carefully and soil around the roots should not be dropped or disturbed. Water retaining basin should be made neatly around the each plantation.

6. Supply of Sweet Earth:

Supply and Spreading of Good earth at site including cost or royalty. As directed by site in charge. no void

LIST OF PLANTS

Sr.No. Name of plant M2 Minimum size from top of bag

- 1 *Bauhinia alba* 2.5'
- 2 *Bougainvillia* 2'
- 3 *Ficus long island* 2.5'
- 4 *Galphimia gracilis* 2'
- 5 *Hymenocallis speciosa* 2.5'
- 6 *Ixora Singaporensis (pink)* 2.5'
- 7 *Jasminum Sambac* 2.5'
- 8 *Leucothyllum frutescens* 2.5'
- 9 *Murraya exotica* 2.5'
- 10 *Nerium (dwarf)* 2.5'
- 11 *Nerium var.* 2.5'

LIST OF TREES

Sr.No. Name of Trees Minimum size from top of bag

- 1 *Azadirachta indica*
- 2 *Bauhinia blakena*
- 3 *Butea Monosperma*
- 4 *Couropita guianensis*
- 5 *Dalbergia sissoo*
- 6 *Engenia jambolana*
- 7 *Ficus Virens*
- 8 *Ficus religosa*
- 9 *Ficus bengalensis*
- 10 *Mangifera indica*
- 11 *Millingtonia hortensis*
- 12 *Polythea lonifolia*
- 13 *Plumeria*
- 14 *Terminalia arjuna*

Each having 10 to 12 feet height with girth of 3 inch

Sr.No. Name of Grass M2 Minimum size from top of bag

LIST OF GRASS

- 1 *Vetiveria zizanioides* 2'
- 2 *Saccharum munja* grass 2'

NOTE:- IF ANY CHANGES IN SELECTION OF PLANTS, TREES, GRASS, GROUND COVERAGES ETC WITH PRIOR APPROVAL OF ARCHITECT/AUTHORITY(EIC)

SIGN OF CONTRACTOR

Signature of The Contractor

Signature of
EXECUTIVE ENGINEER
BUILDING DEPARTMENT
BHAVNAGAR MUNICIPAL CORPORATION
BHAVNAGAR

**EXECUTIVE ENGINEER
BUILDING DEPARTMENT
BHAVNAGAR MUNICIPAL CORPORATION
BHAVNAGAR**

PROPOSED DEVELOPMENT OF NIGHT SHELTER AT FULSAR, FOR BHAVNAGAR MUNICIPAL CORPORATION(B.M.C), BHAVANAGAR

SECTION-III

SPECIAL TECHNICAL SPECIFICATION FOR BUILDING WORKS.

ARCHITECTS:-

CHINTAN SACHAPARA

ARCHITECTS

***3,SHAHIBAUG,ABOVE HOME DÉCOR,WAGHA WADI ROAD,
BHAVNAGAR***

PHONE : 9428401640

SPECIFICATION
CONCRETE

Applicable Codes

Materials

1. IS.269 Specification for 33 grade ordinary Portland cement.
2. IS.455 Specification for Portland slag cement.
3. IS.1489 Specification for Portland-Pozzolana cement (Part 1&2).
4. IS: 8112 Specification for 43 grade ordinary Portland cement.
5. IS: 12269 Specification for 53 grade ordinary Portland cement.

6. IS: 12330 Specification for sulphate resisting Portland cement.
7. IS: 383 Specification for coarse and fine aggregates from natural sources for concrete.
8. IS: 432 Specification for mild steel and medium (tensile steel bars and hard-drawn steel) wires for concrete reinforcement. (Part 1 and 2)
9. IS: 1786 Specification for high strength deformed steel bars and wires for concrete reinforcement.
10. IS: 1566 Specification for hard-drawn steel wire fabric for concrete reinforcement.
11. IS: 9103 Specification for admixtures for concrete.
12. IS: 2645 Specification for integral cement water- proofing compounds.
13. IS: 4990 Specification for plywood for concrete shuttering work.

Material Testing

- 1) IS.4031 Methods of physical tests for hydraulic cement (Parts 1 to 15)
- 2) IS: 4032 Method chemical analysis of hydraulic cement.
- 3) IS: 650 Specification for standard sand for testing of cement.
- 4) IS: 2430 Methods for sampling of aggregates for concrete.
- 5) IS.2386 Methods of test for aggregates for concrete (Parts 1 to 8)
- 6) IS: 3025 Methods of sampling and test (physical and chemical) for water used in industry.
- 7) IS: 6925 Methods of test for determination of water-soluble chlorides in concrete admixtures.

Material Storage

- 1) IS: 4082 Recommendations on stacking and storing of construction materials at site.

Concrete Mix Design

- 1) IS: 10262 Recommended guidelines for concrete mix design.
- 2) SP: 23 (S&T) Handbook on Concrete Mixes

Concrete Testing

- 1) IS.1199 Method of sampling and analysis of concrete.
- 2) IS: 516 Method of test for strength of concrete.
- 3) IS: 9013 Method of making, curing and determining compressive Strength of accelerated cured concrete test specimens.
- 4) IS: 8142 Method of test for determining setting time of concrete by penetration resistance.
- 5) IS: 9284 Method of test for abrasion resistance of concrete.
- 6) IS: 2770 Methods of testing bond in reinforced concrete.

Equipments

- 1) IS: 1791 Specification for batch type concrete mixers.
- 2) IS: 2438 Specification for roller pan mixer.
- 3) IS: 4925 Specification for concrete batching and mixing plant.
- 4) IS: 5892 Specification for concrete transit mixer and agitator.
- 5) IS: 7242 Specification for concrete spreaders.
- 6) IS: 2505 General Requirements for concrete vibrators: Immersion type.
- 7) IS: 2506 General Requirements for screed board concrete vibrators.
- 8) IS: 2514 Specification for concrete vibrating tables.
- 9) IS: 3366 Specification for pan vibrators.
- 10) IS: 4656 Specification for form vibrators for concrete.
- 11) IS: 11993 Code of practice for use of screed board concrete vibrators.
- 12) IS: 7251 Specification for concrete finishers.
- 13) IS: 2722 Specification for portable swing weighs batchers for concrete (single and double bucket type).
- 14) IS: 2750 Specification for steel scaffoldings.

Codes Of Practice

- 1) IS: 456 Code of practice for plain and reinforced concrete.
- 2) IS: 457 Code of practice for general construction of plain and reinforced concrete for dams and other massive structures.
- 3) IS: 3370 Code of practice for concrete structures for storage of liquids (Parts 1 to 4)
- 4) IS: 3935 Code of practice for composite construction.
- 5) IS: 2204 Code of practice for construction of reinforced concrete shell roof.
- 6) IS: 2210 Criteria for the design of reinforced concrete shell structures and folded plates.
- 7) IS: 2502 Code of practice for bending and fixing of bars for concrete reinforcement.
- 8) IS: 5525 Recommendation for detailing of reinforcement in reinforced concrete works.
- 9) IS: 2751 Code of practice for welding of mild steel plain and deformed bars used for reinforced concrete construction.
- 10) IS: 9417 Specification for welding cold worked bars for reinforced concrete construction.
- 11) IS: 3558 Code of practice for use of immersion vibrators for consolidating concrete.
- 12) IS: 3414 Code of practice for design and installation of joints in buildings.
- 13) IS: 4326 Code of practice for earthquake resistant design and construction of building.
- 14) IS: 4014 Code of practice for steel tubular scaffolding (Parts 1 & 2)
- 15) IS: 2571 Code of practice for laying inset cement concrete flooring.
- 16) IS: 7861 Code of practice for extreme weather concreting: Part 1

Recommended practice for hot weather concreting.

Construction Safety

- 1) IS.3696 Safety code for scaffolds and ladders. (Parts 1 &
- 2) IS: 7969 Safety code for handling and storage of building materials.
- 3) IS: 8989 Safety code for erection of concrete framed structures.

General

The ARCHITECT/OWNER shall have the right at all times to inspect all operations including the sources of materials, procurement, layout and storage of materials, the concrete batching and mixing equipment and the quality control system. Such an inspection shall be arranged and the ARCHITECT/OWNER's approval obtained, prior to starting of concrete work. This shall, however, not relieve the Contractor of any of his responsibilities. All materials, which do not conform to the Specifications, shall be rejected.

Materials should be selected so that they can satisfy the design requirements of strength, serviceability, safety, durability and finish with due regards to the functional requirements and the environmental conditions to which the structure will be subjected. Materials complying with codes/standards shall generally be used. Other materials may be used after approval of the ARCHITECT/OWNER and after establishing their performance suitability based on previous data, experience or tests.

Materials

Cement:

Unless otherwise called for by the ARCHITECT/OWNER, cement shall be ordinary Portland cement conforming to IS: 269, IS: 8112 or IS: 12269.

Where Portland pozzolana or slag cements are used, it shall be ensured that consistency of quality is maintained, there will be no adverse interactions between the materials and the finish specified is not marred.

Only one type of cement shall be used in any one mix. The source of supply, type or brand of cement within the same structure or portion thereof shall not be changed without approval from the ARCHITECT/OWNER.

Cement, which is not used within 90 days from its date of manufacture, shall be tested at a laboratory approved by the ARCHITECT/OWNER and until the results of such tests are found satisfactory, it shall not be used in any work.

Aggregates (General):

Aggregates shall consist of naturally occurring stones (crushed or uncrushed), gravel and sand. They shall be chemically inert, strong, hard, clean, durable against weathering, of limited porosity, free from dust/silt/ organic impurities/deleterious materials and conform to IS: 383. Aggregates such as slag, crushed over burnt bricks, bloated clay ash, sintered fly ash and tiles shall not be used.

Aggregates shall be washed and screened before use where necessary or if directed by the ARCHITECT/OWNER.

Aggregates containing reactive materials shall be used only after tests conclusively prove that there will be no adverse effect on strength, durability and finish, including long-term effects, on the concrete.

The fineness modulus of sand shall neither be less than 2.2 nor more than 3.2.

The maximum size of coarse aggregate shall be as stated on the drawings but in no case greater than 1/4 of the minimum thickness of the member.

Plums 160 mm and above of a reasonable size may be used in mass concrete fill where directed. Plums shall not constitute more than 20% by volume of the concrete.

Water

Water used for both mixing and curing shall conform to IS: 456. Potable waters are generally satisfactory. Water containing any excess of acid, alkali, sugar or salt shall not be used.

Reinforcement

All reinforcement steel shall be HYSD steel grade – Fe500 conforming to relevant I.S. 1786 for water retaining structure

All reinforcement shall be clean, free from pitting, oil, grease, paint, loose mill scales, rust, dirt, dust, or any other substance that will destroy or reduce bond.

Admixtures

Accelerating, retarding, water reducing and air entraining admixtures shall conform to IS: 9103 and integral water proofing admixtures to IS: 2645.

Admixtures may be used in concrete as per manufacturer's instructions only with the approval of the ARCHITECT/OWNER. An admixture's suitability and effectiveness shall be verified by trial mixes with the other materials used in the works. If two or more admixtures are to be used simultaneously in the same concrete mix, their interaction shall be checked and trial mixes done to ensure their compatibility. There should also be no increase in risk of corrosion of the reinforcement or other embedments.

Calcium chloride shall not be used for accelerating set of the cement for any concrete containing reinforcement or embedded steel parts. When calcium chloride is permitted such as in mass concrete works, it shall be dissolved in water and added to the mixing water by an amount not exceeding 1.5 percent of the weight of the cement in each batch of concrete. The designed concrete mix shall be corrected accordingly.

Wastage

Wastage allowance for cement and steel shall be considered in the item rate and no extra payment shall become payable to the Contractor on any account.

Samples and Tests

All materials used for the works shall be tested before use.

Manufacturer's test certificate shall be furnished for each batch of cement/steel and when directed by the ARCHITECT/OWNER samples shall also be got tested by the Contractor in a laboratory approved by the ARCHITECT/OWNER at no extra cost to Employer. ARCHITECT/OWNER may appoint separate third party inspection for the material testing to ensure the quality of the work. The Contractor shall replace the defective material as an outcome of these tests. Sampling and testing shall be as per IS: 2386 under the supervision of the ARCHITECT/OWNER.

Water to be used shall be tested to comply with requirements of IS: 456.

The Contractor shall furnish manufacturer's test certificates and technical literature for the admixture proposed to be used. If directed, the admixture shall be got tested at an approved laboratory at no extra cost.

Storing of Materials

All materials shall be stored in a manner so as to prevent its deterioration and contamination, which would preclude its use in the works. Requirements of IS: 4082 shall be complied with.

The Contractor will have to make his own arrangements for the storage of adequate quantity of cement. If such cement is not stored properly and has deteriorated, the material shall be rejected. Cement bags shall be stored in dry weatherproof shed with a raised floor, well away from the outer walls and insulated from the floor to avoid moisture from ground. Not more than 15 bags shall be stacked in any tier. Storage arrangement shall be approved by the ARCHITECT/OWNER. Storage under tarpaulins shall not be permitted. Each consignment of cement shall be stored separately and consumed in its order of receipt.

Each size of coarse and fine aggregates shall be stacked separately and shall be protected from leaves and contamination with foreign material. The stacks shall be on hard, clean, free draining bases, draining away from the concrete mixing area.

The Contractor shall make his own arrangements for storing water at site in tanks to prevent contamination.

The reinforcement shall be stacked on top of timber sleepers to avoid contact with ground/water. Each type and size shall be stacked separately.

Concrete

General

Concrete grade shall be as designated on drawings. In concrete grade M15, M20 etc. the number represents the specified characteristic compressive strength of 150 mm cube at 28 days, expressed in N/sq.mm as per IS: 456. Concrete in the works shall be "DESIGN MIX CONCRETE" or "NOMINAL MIX CONCRETE". All concrete works of grade M5, M7.5 and M10 shall be NOMINAL MIX CONCRETE whereas all other grades, M15 and above, shall be DESIGN MIX CONCRETE.

Design Mix Concrete

(a) Mix Design & Testing

For Design Mix Concrete, the mix shall be designed according to IS: 10262 and SP: 23 to provide the grade of concrete having the required workability and characteristic strength

not less than appropriate values given in IS: 456. The design mix shall be cohesive and does not segregate and should result in a dense and durable concrete and also capable of giving the finish as specified. For liquid retaining structures, the mix shall also result in watertight concrete. The Contractor shall exercise great care while designing the concrete mix and executing the works to achieve the desired result.

The minimum cement content for Design Mix Concrete shall be as per Appendix-A of IS: 456 or as given below, whichever is higher.

Grade of Concrete	Minimum Cement Content in Kg/Cu. m of Concrete
M15	260
M20	315
M25	360

The minimum cement content stipulated above should be adopted irrespective of whether the Contractor achieves the desired strength with less quantity of cement. The CONTRACTOR's quoted rates for concrete shall provide for the above eventuality and nothing extra shall become payable to the CONTRACTOR in this account. Even in the case where the quantity of cement required is higher than that specified above to achieve desired strength based on an approved mix design, nothing extra shall become payable to the CONTRACTOR.

It shall be the Contractor's sole responsibility to carry out the mix designs at his own cost. He shall furnish to the ARCHITECT/OWNER at least 30 days before concreting operations, a statement of proportions proposed to be used for the various concrete mixes and the strength results obtained. The strength requirements of the concrete mixes ascertained on 150 mm cubes as per IS: 516 shall comply with the requirements of IS: 456.

Grade of Concrete	Minimum Compressive Strength N/sq.mm at 7 days	Specified Characteristic Compressive Strength N/sq.mm at 28 days
M 15	10.0	15.0
M 20	13.5	20.0
M 25	17.0	25.0
M 30	20.0	30.0
M 35	23.5	35.0
M 40	27.0	40.0

A range of slumps which shall generally be used for various types of construction unless otherwise instructed by the ARCHITECT/OWNER is given below:

Structure/Member	Slump in millimeters	
	Maximum	Minimum

Reinforced foundation walls and footings	75	25
Plain footings, caissons and substructure walls	100	25
Slabs, Beams and reinforced walls	75	25
Pump & miscellaneous Equipment Foundations	100	25
Building columns	50	25
Pavements	50	25
Heavy mass construction	50	25

(b) Batching & Mixing of Concrete:

Proportions of aggregates and cement, as decided by the concrete mix design, shall be by weight. These proportions shall be maintained during subsequent concrete batching by means of weigh batchers capable of controlling the weights within one percent of the desired value.

Amount of water added shall be such as to produce dense concrete of required consistency, specified strength and satisfactory workability and shall be so adjusted to account for moisture content in the aggregates. Water- cement ratio specified for use by the ARCHITECT/OWNER shall be maintained. Each time the work stops, the mixer shall be cleaned out, and while recommencing; the first batch shall have 10% additional cement to allow for sticking in the drum.

Arrangement should be made by the Contractor to have the cubes tested in an approved laboratory or in field with prior consent of the ARCHITECT/OWNER. Sampling and testing of strength and workability of concrete shall be as per IS: 1199, IS: 516 and IS: 456, IS 3370.

Nominal Mix Concrete

(a) Mix Design & Testing

Mix design and preliminary tests are not necessary for Nominal Mix Concrete. However works tests shall be carried out as per IS: 456. Proportions for Nominal Mix Concrete and w/c ratio may be adopted as per Table 3 of IS: 456. However it will be the Contractor's sole responsibility to adopt appropriate nominal mix proportions to yield the specified strength.

(b) Batching & Mixing of Concrete

Based on the adopted nominal mixes, aggregates shall be measured by volume. However cement shall be by weight only.

Formwork

Formwork shall be all inclusive and shall consist of but not be limited to shores, bracings, sides of footings, walls, beams and columns, bottom of slabs etc. including ties, anchors, hangers, inserts, false work, wedges etc.

The design and engineering of the formwork as well as its construction shall be the

responsibility of the Contractor. However, if so desired by the ARCHITECT/OWNER, the drawings and calculations for the design of the formwork shall be submitted to the ARCHITECT/OWNER for approval.

Formwork shall be designed to fulfill the following requirements:

- (a) Sufficiently rigid and tight to prevent loss of grout or mortar from the concrete at all stages and appropriate to the methods of placing and compacting.**
- (b) Made of suitable materials.**
- (c) Capable of providing concrete of the correct shape and surface finishes within the specified tolerance limits.**
- (d) Capable of withstanding without deflection the worst combination of self weight, reinforcement and concrete weight, all loads and dynamic effects arising from construction and compacting activities, wind and weather forces.**
- (e) Capable of easy striking out without shock, disturbance or damage to the concrete.**
- (f) Soffit forms capable of imparting a camber if required.**
- (g) Soffit forms and supports capable of being left in position if required.**
- (h) Capable of being cleaned and/or coated if necessary immediately prior to casting the concrete; design temporary openings where necessary for these purposes and to facilitate the preparation of construction joints.**

The formwork may be of timber, plywood, steel, plastic or concrete depending upon the type of finish specified. Sliding forms and slip form may be used with the approval of the ARCHITECT/OWNER. Timber for formwork shall be well seasoned, free from sap, shakes, loose knots, worm holes, warps and other surface defects. Joints between formwork and formwork and between formwork and structures shall be sufficiently tight to prevent loss of slurry from concrete, using seals if necessary.

The faces of formwork coming in contact with concrete shall be cleaned and two coats of approved mould oil applied before fixing reinforcement. All rubbish, particularly chippings, shavings, sawdust, wire pieces dust etc. shall be removed from the interior of the forms before the concrete is placed. Where directed, cleaning of forms shall be done by blasting with a jet of compressed air at no extra cost.

Forms intended for reuse shall be treated with care. Forms that have deteriorated shall not be used. Before reuse, all forms shall be thoroughly scraped, cleaned, nails removed, holes suitably plugged, joints repaired and warped lumber replaced to the satisfaction of the ARCHITECT/OWNER. The Contractor shall equip himself with enough shuttering to allow for wastage so as to complete the job in time.

Permanent formwork shall be checked for its durability and compatibility with adjoining concrete before it is used in the structure. It shall be properly anchored to the concrete.

Wire ties passing through beams, columns and walls shall not be allowed. In their place bolts passing through sleeves shall be used. Formwork spacers left insitu shall not impair the desired appearance or durability of the structure by causing spalling, rust staining or allowing the passage of moisture.

For liquid retaining structures, sleeves shall not be provided for through bolts nor shall

through bolts be removed if provided. The bolts, in the latter case, shall be cut at 25 mm depth from the surface and the hole made good by cement mortar of the same proportion as the concrete just after striking the formwork.

Where specified all corners and angles exposed in the finished structure shall have chamfers or fillets of 20 mm x 20 mm size.

Forms for substructure may be omitted when, in the opinion of the ARCHITECT/OWNER, the open excavation is firm enough (in hard non-porous soils) to act as a form. Such excavations shall be larger, as approved by the ARCHITECT/OWNER, than that required as per drawing to compensate for irregularities in excavation.

The Contractor shall provide adequate props carried down to a firm bearing without overloading any of the structures.

The shuttering for beams and slabs shall be so erected that the side shuttering of beams can be removed without disturbing the bottom shuttering. If the shuttering for a column is erected for the full height of the column, one side shall be built up in sections as placing of concrete proceeds or windows left for placing concrete from the side to limit the drop of concrete to 1.0m or as approved by the ARCHITECT/OWNER. The Contractor shall temporarily and securely fix items to be cast (embedment/ inserts) in a manner that will not hinder the striking of forms or permit loss of grout.

Formwork showing excessive distortion, during any stage of construction, shall be repositioned and strengthened. Placed concrete affected by faulty formwork, shall be entirely removed and formwork corrected prior to placement of new concrete at Contractor's cost.

The striking time for formwork shall be determined based on the following requirements:

- (a) Development of adequate concrete strength;
- (b) Permissible deflection at time of striking form work;
- (c) Curing procedure employed - its efficiency and effectiveness;
- (d) Subsequent surface treatment to be done;
- (e) Prevention of thermal cracking at re-entrant angles;
- (f) Ambient temperatures; and
- (g) Aggressiveness of the environment (unless immediate adequate steps are taken to prevent damage to the concrete).

Under normal circumstances (generally where temperatures are above 20°C) forms may be struck after expiry of the time period given in IS: 456 unless approved otherwise by the ARCHITECT/OWNER. For Portland Pozzolana/slag cement the stripping time shall be suitably modified as approved by the ARCHITECT/OWNER. It is the Contractor's responsibility to ensure that forms are not struck until the concrete has developed sufficient strength to support itself, does not undergo excessive deformation and resist surface damage and any stresses arising during the construction period.

Reinforcement Workmanship

Reinforcing bars supplied bent or in coils shall be straightened cold without damage. No bending shall be done when ambient temperature is below 5°C. Local warming may be

permitted if steel is kept below 10° C.

All bars shall be accurately bent gradually and according to the sizes and shapes shown on the drawings/ schedules or as directed by ARCHITECT/OWNER.

Re-bending or straightening incorrectly bent bars shall not be done without the approval of the ARCHITECT/OWNER.

Reinforcement shall be accurately fixed and maintained firmly in the correct position by the use of blocks, spacers, chairs, binding wire etc. to prevent displacement during placing and compaction of concrete. The tied in place reinforcement shall be approved by the ARCHITECT/OWNER prior to concrete placement. Spacers shall be of such materials and designs as will be durable, not lead to corrosion of the reinforcement and not cause spalling of the concrete cover.

Binding wire shall be 16-gauge soft annealed wire. Ends of the binding wire shall be bent away from the concrete surface and in no case encroach into the concrete cover.

Substitution of reinforcement, laps/splices not shown on drawing shall be subject to ARCHITECT/OWNER's approval.

Tolerances

Tolerance for formwork and concrete dimensions shall be as per IS: 456 unless specified otherwise.

Tolerances specified for horizontal or vertical building lines or footings shall not be construed to permit encroachment beyond the legal boundaries.

The formwork shall be designed and constructed to the shapes, lines and dimensions shown on the drawings within the tolerances given below:

(a) Deviation from specified dimensions of cross section of columns and beams	- 6 mm + 12 mm
(b) Deviations from dimensions of footings (Tolerances apply to concrete dimensions only, not to positioning of vertical reinforcing steel or dowels)	
1) Dimension in plan	- 12 mm + 50 mm
2) Eccentricity	0.02 times the width of the footing in the direction of deviation but not more than 50 mm
3) Thickness	± 0.05 times the specified thickness

Preparation Prior to Concrete Placement

Before concrete is actually placed in position, the inside of the formwork shall be cleaned and mould oil applied, inserts and reinforcement shall be correctly positioned and securely held, necessary openings, pockets, etc. provided.

All arrangements-formwork, equipment and proposed procedure, shall be approved by the ARCHITECT/OWNER. Contractor shall maintain separate Pour Card for each pour

as per the format enclosed.

Transporting, Placing and Compacting Concrete

Concrete shall be transported from the mixing plant to the formwork with minimum time lapse by methods that shall maintain the required workability and will prevent segregation, loss of any ingredients or ingress of foreign matter or water.

In all cases concrete shall be deposited as nearly as practicable directly in its final position. To avoid segregation, concrete shall not be rehandled or caused to flow. For locations where direct placement is not possible and in narrow forms the Contractor shall provide suitable drops and "Elephant Trunks". Concrete shall not be dropped from a height of more than 1.0m.

Concrete shall not be placed in flowing water. Under water, concrete shall be placed in position by tremies or by pipeline from the mixer and shall never be allowed to fall freely through the water.

While placing concrete the Contractor shall proceed as specified below and also ensure the following:

- (a) Continuously between construction joints and pre-determined abutments.
- (b) Without disturbance to forms or reinforcement.
- (c) Without disturbance to pipes, ducts, fixings and the like to be cast in; ensure that such items are securely fixed. Ensure that concrete cannot enter open ends of pipes and conduits etc.
- (d) Without dropping in a manner that could cause segregation or shock.
- (e) In deep pours only when the concrete and formwork designed for this purpose and by using suitable chutes or pipes.
- (f) Do not place if the workability is such that full compaction cannot be achieved.
- (g) Without disturbing the unsupported sides of excavations; prevent contamination of concrete with earth. Provide sheeting if necessary. In supported excavations, withdraw the linings progressively as concrete is placed.
- (h) If placed directly onto hardcore or any other porous material, dampen the surface to reduce loss of water from the concrete.
- (i) Ensure that there is no damage or displacement to sheet membranes.
- (j) Record the time and location of placing structural concrete.

Concrete shall normally be compacted in its final position within thirty minutes of leaving the mixer. Concrete shall be compacted during placing with approved vibrating equipment without causing segregation until it forms a solid mass free from voids thoroughly worked around reinforcement and embedded fixtures and into all corners of the formwork. Immersion vibrators shall be inserted vertically at points not more than 450 mm apart and withdrawn slowly till air bubbles cease to come to the surface, leaving no voids. When placing concrete in layers advancing horizontally, care shall be taken to ensure adequate vibration, blending and melding of the concrete between successive layers. Vibrators shall not be allowed to come in contact with reinforcement, formwork and finished surfaces after start of initial set. Over-vibration shall be avoided.

Concrete may be conveyed and placed by mechanically operated equipment after getting

the complete procedure approved by the ARCHITECT/OWNER. The slump shall be held to the minimum necessary for conveying concrete by this method. When concrete is to be pumped, the concrete mix shall be specially designed to suit pumping. Care shall be taken to avoid stoppages in work once pumping has started.

Except when placing with slip forms, each placement of concrete in multiple lift work, shall be allowed to set for at least 24 hours after the final set of concrete before the start of subsequent placement. Placing shall stop when concrete reaches the top of the opening in walls or bottom surface of slab, in slab and beam construction, and it shall be resumed before concrete takes initial set but not until it has had time to settle as approved by the ARCHITECT/OWNER. Concrete shall be protected against damage until final acceptance.

Mass Concrete Works

Sequence of pouring for mass concrete works shall be as approved by the ARCHITECT/OWNER. The Contractor shall exercise great care to prevent shrinkage cracks and shall monitor the temperature of the placed concrete if directed.

Curing

Curing and protection shall start immediately after the compaction of the concrete to protect it from:

- (a) Premature drying out, particularly by solar radiation and wind;
- (b) Leaching out by rain and flowing water;
- (c) Rapid cooling during the first few days after placing;
- (d) High internal thermal gradients;
- (e) Low temperature or frost;
- (f) Vibration and impact which may disrupt the concrete and interfere with its bond to the reinforcement.

All concrete, unless approved otherwise by the ARCHITECT/OWNER, shall be cured by use of continuous sprays or ponded water or continuously saturated coverings of sacking, canvas, hessian or other absorbent material for the period of complete hydration with a minimum of 7 days. The quality of curing water shall be the same as that used for mixing.

Where a curing membrane is approved to be used by the ARCHITECT/OWNER, the same shall be of a non-wax base and shall not impair the concrete finish in any manner. The curing compound to be used shall be approved by the ARCHITECT/OWNER before use and shall be applied with spraying equipment capable of a smooth, even textured coat.

Curing may also be done by covering the surface with an impermeable material such as polyethylene, which shall be well sealed and fastened.

Construction Joints and Keys

Construction joints will be as shown on the drawing or as approved by the ARCHITECT/OWNER. Concrete shall be placed without interruption until completion of

work between construction joints. If stopping of concreting becomes unavoidable anywhere, a properly formed construction joint shall be made with the approval of the ARCHITECT/OWNER.

Dowels for concrete work, not likely to be taken up in the near future, shall be coated with cement slurry and encased in lean concrete as indicated on the drawings or as approved by the ARCHITECT/OWNER.

Before resuming concreting on a surface, which has hardened all laitance and loose stone, shall be thoroughly removed by wire brushing/hacking and surface washed with high pressure water jet and treated with thin layer of cement slurry for vertical joints and horizontal layers.

When concreting is to be resumed on a surface, which has not fully hardened, all laitance shall be removed by wire brushing, the surface wetted, free water removed and a coat of cement slurry applied. On this, a layer of concrete not exceeding 150 mm thickness shall be placed and well rammed against the old work. Thereafter work shall proceed in the normal way.

Foundation Bedding

All earth surfaces upon which or against which concrete is to be placed, shall be well compacted and free from standing water, mud or debris. Soft or spongy areas shall be cleaned out and back filled with either soil-cement mixture, lean concrete or clean sand compacted as approved by the ARCHITECT/OWNER. The surfaces of absorptive soils shall be moistened.

Concrete shall not be deposited on large sloping rock surfaces. The rock shall be cut to form rough steps or benches by picking, barring or wedging. The rock surface shall be kept wet for 2 to 4 hours before concreting.

Finishes

General

The formwork for concrete works shall be such as to give the finish as specified. The Contractor shall make good any unavoidable defects as approved consistent with the type of concrete and finish specified; defects due to bad workmanship (e.g. damaged or misaligned forms, defective or poorly compacted concrete) will not be accepted. The Contractor shall construct the formwork using the correct materials and to meet the requirements of the design and to produce finished concrete to required dimensions, plumbs, planes and finishes.

Surface Finish Type F1

The main requirement is that of dense, well-compacted concrete. No treatment is required except repair of defective areas, filling all form tie holes and cleaning up of loose or adhering debris. For surfaces below grade, which will receive waterproofing treatment, the concrete shall be free of surface irregularities, which would interfere with proper and effective application of waterproofing material specified for use.

Surface Finish Type F2

The appearance shall be that of a smooth dense, well-compacted concrete showing the slight marks of well fitted shuttering joints. The Contractor shall make good any blemishes.

Surface Finish Type F3

This finish shall give an appearance of smooth, dense, well-compacted concrete with no shutter marks, stain free and with no discolouration, blemishes, arises, airholes etc. Only lined or coated plywood with very tight joints shall be used to achieve this finish. The panel size shall be uniform and as large as practicable. Any minor blemishes that might occur shall be made good by the Contractor.

Integral Cement Finish on Concrete Floor

In all cases where integral cement finish on a concrete floor has been specified, the top layer of concrete shall be screeded off to proper level and tamped with tamper having conical projections so that the aggregate shall be forced below the surface. The surface shall be finished with a wooden float and a trowel with pressure. The finish shall be continued till the concrete reaches its initial set. No cement or cement mortar finish shall be provided on the surface. Where specified, a floor hardener as approved by the ARCHITECT/OWNER shall be supplied and used as recommended by the manufacturer.

Repair and Replacement of Unsatisfactory Concrete

Immediately after the shuttering is removed, all the defective areas such as honey-combed surfaces, rough patches, holes left by form bolts etc. shall be inspected by the ARCHITECT/OWNER who may permit patching of the defective areas or reject the concrete work.

All through holes for shuttering shall be filled for full depth and neatly plugged flush with surface.

Rejected concrete shall be removed and replaced by the Contractor at no additional cost to the Employer.

For patching of defective areas all loose materials shall be removed and the surface shall be prepared as approved by the ARCHITECT/OWNER.

Bonding between hardened and fresh concrete shall be done either by placing cement mortar or by applying epoxy. The decision of the ARCHITECT/OWNER as to the method of repairs to be adopted shall be final and binding on the Contractor. The surface shall be saturated with water for 24 hours before patching is done with 1:5 cement sand mortar. The use of epoxy for bonding fresh concrete shall be carried out as approved by the ARCHITECT/OWNER.

Vacuum Dewatering of Slabs

Where specified floor slabs, either grade or suspended, shall be finished by vacuum dewatering including all operations such as poker vibration, surface vibration, vacuum processing, floating and trowelling as per equipment manufacturers recommendation. The equipment to be used shall be subject to the ARCHITECT/OWNER's approval.

Hot Weather Requirements

Concreting during hot weather shall be carried out as per IS: 7861 (Part I).

Adequate provisions shall be made to lower concrete temperatures, which shall not exceed 40°C at the time of placement of fresh concrete.

Where directed by the ARCHITECT/OWNER, the Contractor shall spray non-wax based curing compound on unformed concrete surfaces at no extra costs.

Cold Weather Requirements

Concreting during cold weather shall be carried out as per is: 7861 (Part II).

The ambient temperature during placement and up to final set shall not fall below 5 Deg.C. Approved antifreeze/accelerating additives shall be used where directed.

For major and large scale concreting works the temperature of concrete at times of mixing and placing, the thermal conductivity of the formwork and its insulation and stripping period shall be closely monitored.

Liquid Retaining Structures

The Contractor shall take special care for concrete for liquid retaining structures, underground structures and those others specifically called for to guarantee the finish and water tightness.

The minimum level of surface finish for liquid retaining structures shall be Type F2. All such structures shall be hydro-tested.

The Contractor shall make all arrangements for hydro-testing of structure, all arrangements for testing such as temporary bulk heads, pressure gauges, pumps, pipe lines etc.

The Contractor shall also make all temporary arrangements that may have to be made to ensure stability of the structures during construction.

Any leakage that may occur during the hydro-test or subsequently during the defects liability period or the period for which the structure is guaranteed shall be effectively stopped either by cement/epoxy pressure grouting, guniting or such other methods as may be approved by the ARCHITECT/OWNER. All such rectification shall be done by the CONTRACTOR to the entire satisfaction of the ARCHITECT/OWNER at no extra cost to the EMPLOYER.

Testing Concrete Structures for Leakage

Hydrostatic test for water tightness shall be done at full storage level or soffit of cover slab, as may be directed by the ARCHITECT/OWNER, as described below:

In case of structures whose external faces are exposed, such as elevated tanks, the requirements of the test shall be deemed to be satisfied if the external faces show no sign of leakage or sweating and remain completely dry during the period of observation of seven days after allowing a seven day period for absorption after filling with water.

In the case of structures whose external faces are buried and are not accessible for inspection, such as underground tanks, the structures shall be filled with water and after the expiry of seven days after the filling, the level of the surface of the water shall be recorded. The level of water shall be recorded again at subsequent intervals of 24 hrs. Over a period of seven days. Backfilling shall be withheld till the tanks are tested. The total drop in surface level over a period for seven days shall be taken as an indication of the water tightness of the structure. The ARCHITECT/OWNER shall decide on the actual permissible nature of this drop in the surface level, taking into account whether the structures are open or closed and the corresponding effect it has on evaporation losses. Unless specified otherwise, a structure whose top is covered shall be deemed to be water tight if the total drop in the surface level over a period of seven days does not exceed 40 mm.

Each compartment/segment of the structure shall be tested individually and then all together.

For structures such as pipes, tunnels etc. the hydrostatic test shall be carried out by filling with water, after curing as specified, and subjecting to the specified test pressure for specified period. If during this period the loss of water does not exceed the equivalent of the specified rate, the structure shall be considered to have successfully passed the test.

Optional Tests

If the ARCHITECT/OWNER feels that the materials i.e. cement, sand, coarse aggregates, reinforcement and water are not in accordance with the Specifications or if specified concrete strengths are not obtained, he may order tests to be carried out on these materials in laboratory, to be approved by the ARCHITECT/OWNER, as per relevant IS Codes. Contractor shall have to pay for these tests.

In the event of any work being suspected of faulty material or workmanship requiring its removal or if the works cubes do not give the stipulated strengths, the ARCHITECT/OWNER reserves the right to order the Contractor to take out cores and conduct tests on them or do ultrasonic testing or load testing of structure, etc. The ARCHITECT/OWNER also reserves the right to ask the Contractor to dismantle and re-do such unacceptable work, at no cost to the Employer. Alternately ARCHITECT/OWNER also reserves the right to ask the CONTRACTOR to dismantle and re-do such unacceptable work at the cost of CONTRACTOR.

Grouting

Standard Grout

Grout shall be provided as specified on the drawings.

The proportion of Standard Grout shall be such as to produce a flowable mixture consistent with minimum water content and shrinkage. Surfaces to be grouted shall be thoroughly roughened and cleaned. All structural steel elements to be grouted, shall be cleaned of oil, grease, dirt etc. The use of hot, strong caustic solution for this purpose will be permitted. Prior to grouting, the hardened concrete shall be saturated with water and

just before grouting, water in all pockets shall be removed. Grouting once started shall be done quickly and continuously. Variation in grout mixes and procedures shall be permitted if approved by the ARCHITECT/OWNER. The grout proportions shall be limited as follows:

Use	Grout Thickness	Mix Proportions	W/C Ratio (max)
a) Fluid mix	Under 25mm	One part Portland Cement to one part sand	0.44
Use	Grout Thickness	Mix Proportions	W/C Ratio (max)
b) General mix	25mm and over but less than 50mm	One part Portland Cement to 2 parts of sand	0.53
c) Stiff mix	50mm and over	One part Portland Cement to 3 parts of sand	0.53

Non-Shrink Grout: **Non –shrink grout where required shall be provided in strict accordance with the manufacturer’s instructions / specifications on the drawings**

General

Inspection: All materials, workmanship and finished construction shall be subject to continuous inspection and approval of ARCHITECT/OWNER. Materials rejected by ARCHITECT/OWNER shall be expressly removed from site and shall be replaced by Contractor immediately.

Clean-Up: Upon the completion of concrete work, all forms, equipment, construction tools, protective coverings and any debris, scraps of wood, etc. resulting from the work shall be removed and the premises left clean.

Acceptance Criteria: Any concrete work shall satisfy the requirements given below individually and collectively for it to be acceptable.

- a) properties of constituent materials;
- b) characteristic compressive strength;
- c) specified mix proportions;
- d) minimum cement content;
- e) maximum free-water/cement ratio;
- f) workability;
- g) temperature of fresh concrete;
- h) density of fully compacted concrete;

- i) cover to embedded steel;
 - j) Curing;
 - k) tolerances in dimensions;
 - l) tolerances in levels;
 - m) durability;
 - n) surface finishes;
-
- o) special requirements such as;
 - i) water tightness
 - ii) resistance to aggressive chemicals
 - iii) resistance to freezing and thawing
 - iv) very high strength
 - v) improved fire resistance
 - vi) wear resistance
 - vii) resistance to early thermal cracking

The ARCHITECT/OWNER's decision as to the acceptability or otherwise of any concrete work shall be final and binding on the Contractor.

For work not accepted, the ARCHITECT/OWNER may review and decide whether remedial measures are feasible so as to render the work acceptable. The ARCHITECT/OWNER shall in that case direct the Contractor to undertake and execute the remedial measures. These shall be expeditiously and effectively implemented by the Contractor. Nothing extra shall become payable to the Contractor by the Employer for executing the remedial measures.

Water stops

Material: The material for the PVC waterstops shall be a plastic compound with the basic resin of polyvinyl chloride and additional resins, plasticizers, inhibitors, which satisfies the performance characteristics specified below as per IS:12200. Testing shall be in accordance with IS:8543.

- | | | | |
|-----|-------------------------|---|---------------------------------|
| a) | Tensile strength | : | 3.6 N/mm ² minimum |
| b) | Ultimate elongation | : | 300% minimum |
| c) | Tear resistance | : | 4.9 N/mm ² minimum |
| d) | Stiffness in flexure | : | 2.46 N/mm ² minimum |
| e) | Accelerated extraction | | |
| | i) Tensile strength | : | 10.50 N/mm ² minimum |
| | ii) Ultimate elongation | : | 250% minimum |
| (f) | Effect of Alkali | : | 7 days |
| | i) Weight increase | : | 0.10% maximum |
| | ii) Weight decrease | : | 0.10% maximum |

	iii)	Hardness change	:	± 5 points
(g)		Effect of Alkali	:	28 days
	i)	Weight increase	:	0.40% maximum
	ii)	Weight decrease	:	0.30% maximum
	iii)	Dimension change	:	±1%

PVC water stops shall be either of the bar type, serrated with centre bulb and end grips for use within the concrete elements or of the surface (kicker) type for external use.

PVC water stops shall be of approved manufacture. Samples and the test certificate shall be got approved by the ARCHITECT/OWNER before procurement for incorporation in the works. Alternatively G.I. sheet of 18 gage (1.3mm) thick and 200mm wide can be used by the contractor as construction joints.

Alternatively contractors can use G.I sheet 200mm wide and 18 gauge thick as constructions joints

Workmanship

Water stops shall be cleaned before placing them in position. Oil or grease shall be removed thoroughly using water and suitable detergents.

Water stops shall be procured in long lengths as manufactured to avoid joints as far as possible. Standard L or T type of intersection pieces shall be procured for use depending on their requirement. Any non-standard junctions shall be made by cutting the pieces to profile for jointing. Lapping of water stops shall not be permitted. All jointing shall be of fusion welded type as per manufacturer's instructions.

Water stops shall be placed at the correct location/level and suitably supported at intervals with the reinforcement to ensure that it does not deviate from its intended position during concreting and vibrating. Care shall also be taken to ensure that no honey-combing occurs because of the serrations/end grips, by placing concrete with smaller size aggregates in this region. Projecting portions of the waterstops embedded in concrete shall be thoroughly cleaned of all mortar/ concrete coating before resuming further concreting operations. The projecting waterstop shall also be suitably supported at intervals with the reinforcement to maintain its intended position during concreting so as to ensure that it does not bend leading to formation of pockets. In addition, smaller size aggregates shall be used for concreting in this region also.

Preformed Fillers and Joint Sealing Compound

Materials: Preformed filler for expansion/isolation joints shall be non-extruding and resilient type of bitumen impregnated fibres conforming to IS:1838 (Part I).

Bitumen coat to concrete/masonry surfaces for fixing the preformed bitumen filler strip shall conform to IS:702. Bitumen primer shall conform to IS:3384. Sealing compound for filling the joints above the preformed bitumen filler shall conform to Grade 'A' as per IS:1834.

Workmanship

The thickness of the preformed bitumen filler shall be 25mm for expansion joints and

50mm for isolation joints around foundation supporting rotatory equipment's. Contractor shall procure the strips of the desired thickness and width in lengths as manufactured. Assembly of small pieces/thicknesses of strips to make up the specified size shall not be permitted.

The concrete/masonry surface shall be cleaned free from dust and any loose particles. When the surface is dry, one coat of industrial blown type bitumen of grade 85/25 conforming to IS:702 shall be applied hot by brushing at the rate of 1.20 kg/sq.m. When the bitumen is still hot the preformed bitumen filler shall be pressed and held in position till it completely adheres. The surface of the filler against which further concreting/masonry work is to be done shall similarly be applied with one coat of hot bitumen at the rate of 1.20 kg/sq.m.

Sealing compound shall be heated to a pouring consistency for enabling it to run molten in a uniform manner into the joint. Before pouring the sealing compound, the vertical faces of the concrete joint shall be applied hot with a coat of bitumen primer conforming to IS: 3384 in order to improve the adhesive quality of the sealing compound.

Expansion joints between beams/slabs shall be provided with 100mm wide x 4mm thick mild steel plate at the soffit of RCC beams/slabs to support and prevent the preformed joint filler from dislodging. This plate shall be welded to an edge angle of ISA 50 x 50 x 6mm provided at the bottom corner, adjacent to the expansion joint of one of the beams/slabs, by intermittent fillet welding. Steel surfaces shall be provided with 2 coats of red oxide zinc chrome primer and 3 coats of synthetic enamel paint finish.

15 SAMPLING AND STRENGTH OF DESIGNED CONCRETE MIX

15.1 General

Samples from fresh concrete shall be taken as per IS 1199 and cubes shall be made, cured and tested at 28 days in accordance with IS 516.

15.1.1 In order to get a relatively quicker idea of the quality of concrete, optional tests on beams for modulus of rupture at 72 ± 2 h or at 7 days, or compressive strength tests at 7 days may be carried out in addition to 28 days compressive strength test. For this purpose the values should be arrived at based on actual testing. In all cases, the 28 days compressive strength specified in Table 2 shall alone be the criterion for acceptance or rejection of the concrete.

15.2 Frequency of Sampling

15.2.1 Sampling Procedure

A random sampling procedure shall be adopted to ensure that each concrete batch shall have a reasonable chance of being tested that is, the sampling should be spread over the entire period of concreting and cover all mixing units.

15.2.2 Frequency

The minimum frequency of sampling of concrete of each grade shall be in accordance with the following:

Quantity of Concrete in the Number of Samples

Work, m ³ 1-5	1
6-15	2
16 – 30	3
31- 50	4
51 and above	4 plus one

additional sample for each additional 50 m' or part thereof

NOT---At least one sample shall be taken from each shift. Where concrete is produced at continuous production unit, such as ready-mixed concrete plant, frequency of sampling may be agreed upon mutually by suppliers and purchasers.

153 Test Specimen

Three test specimens shall be made for each sample for testing at 28 days. Additional samples may be required for various purposes such as to determine the strength of concrete at 7 days or at the time of striking the formwork, or to

determine the duration of curing, or to check the testing error. Additional samples may

also be required for testing samples cured by accelerated methods as described in IS 9103. The specimen shall be tested as described in IS 516.

15.4 Test Results of Sample

The test results of the sample shall be the average of the strength of three specimens. The individual variation should not be more than ± 15 percent of the average. If more, the test results of the sample are invalid

16 ACCEPTANCE CRITERIA

16.1 Compressive Strength

The concrete shall be deemed to comply with the strength requirements when both the following condition are met:

- a) The mean strength determined from any group of four consecutive test results complies with the appropriate limits in col 2 of Table 11.
- b) Any individual test result complies with the appropriate limits in col 3 of Table 11.

16.2 Flexural Strength

When both the following conditions are met, the concrete complies with the specified flexural strength.

- a) The mean strength determined from any group of four consecutive test results exceeds the specified characteristic strength by at least 0.3 N/mm^2 .
- b) The strength determined from any test result is not less than the specified characteristic strength less 0.3 N/mm^2 .

16.3 Quantity of Concrete Represented by Strength Test Results

The quantity of concrete represented by a group of four consecutive test-results shall include the batches from which the first and last samples were taken together with all intervening batches. For the individual test result requirements given in col 2 of Table 11 or in item (b) of 16.2, only the particular batch from which the sample was taken shall be at risk.

Where the mean rate of sampling is not specified the maximum quantity of concrete that four consecutive test results represent shall be limited to 60 m^3 .

16.4 If the concrete is deemed not to comply pursuant to 16.3, the structural adequacy of the parts affected shall be investigated (see 17) and any consequential action as needed shall be taken.

GENERAL

1. Employer's Drawings

1.1. The drawings listed in the Tender document are the Employer's drawings and are provided by the Employer as illustrative of the Specification.

1.2. All data and information furnished in the drawings by the Employer is given in good faith but the Employer does not accept the responsibility for the completeness and accuracy thereof. The same shall be verified by the Contractor promptly pointing out errors or discrepancies thereof to the Engineer.

2. Drawing Sheet Format

- 2.1. All drawings provided by the Contractor shall be on standard size sheets, prepared on computer with AutoCAD 2011/13 and shall show the following particulars in a title block located in the lower right hand corner, in addition to the name of Contractor and equipment manufacturer, date, scale, drawing number, revision number (R0 for drawings submitted initially, R1, R2, etc. for drawings submitted subsequently) and title.

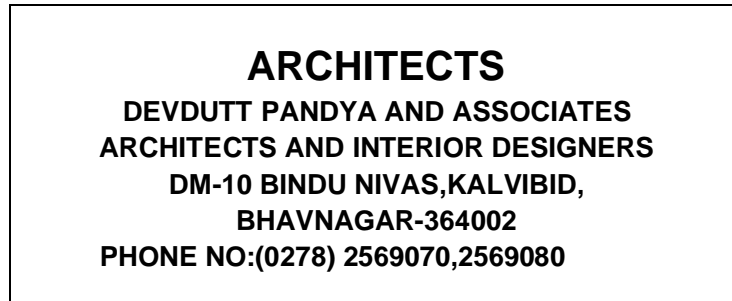

Name:- **PROPOSED DEVELOPMENT OF FIRE STATION AND FIRE STAFF
QUARTERS , AT PRABHUDAS TALAV, FOR BHAVNAGAR
MUNICIPAL CORPORATION, BHAVANAGAR.**

A blank space of 90 mm x 100 mm shall be provided for the Engineer's approval stamp and provision shall be made for details of revisions to be recorded.

- 2.2. All drawings submitted by the Tenderer/Contractor shall use the English language and preferably SI units. All drawings shall be clearly and fully cross-referenced to the other drawings as relevant.

3. Tender / Contract Drawings

- 3.1. Drawings submitted by the Tenderer shall show all the essential items of the Plant offered together with sufficient details to enable the general arrangement of the Plant to be determined.
- 3.2. The drawings and documents to be provided by the Tenderer / Contractor shall be as per the schedules of price but shall not be limited to those listed:

4. Submissions and Approval of Drawings

- 4.1. The following shall be the procedure for submission and approval of drawings:
- 4.1.1. The Contractor shall submit 4 copies of the drawings to the Employer. All the drawings are to be signed by the Contractor or his authorized representatives
- 4.1.2. The Engineer's Representative will review the drawings and, if found fit for approval, the Employer will return 2 copies to the Contractor duly approved.
- 4.1.3. In case the drawings/documents are not fit for approval but worth for review, the Engineer's Representative will mark the comments on the drawings and return 2 copies to the Contractor. In such case, the Contractor shall resubmit the revised drawings within two weeks as per sub-clause 5.1.1 above and the same shall be repeated till the drawings are finally approved as per sub-clause 5.1.2 above.
- 4.1.4. If the submitted drawings/documents are not worth for review, the Contractor will be informed accordingly.

- 4.1.5. On receipt of the approved drawings as per sub-clause 5.1.2 above, the Contractor shall submit floppy and documents to the employer.
- 4.1.6. After tests on completion, the Contractor shall submit, within 15 days of the conclusion of the tests, floppies of the "As Built Drawings" to the Employer.
- 4.2. When the drawings are received by the Engineer's Representative after revision by the Contractor, he will only review the revision made and hence the Contractor shall carefully identify all the revised details / dimensions and also describe the revisions in the revision block.
- 4.3. No drawings, with corrections made after taking the prints, will be accepted.
- 4.4. Approval of drawings by the Engineer shall not relieve the Contractor of his responsibility in terms of the Contract.

5. Delivery, Unloading and Storing at Site

- 5.1. The Contractor shall be responsible for checking all materials delivered to Site and shall keep the Engineer's Representative fully informed of the state of deliveries. The Contractor shall carry out, at his cost, all instructions of Engineer or his Representative for proper unloading, preservation, maintenance, storage and security of materials delivered to Site until he fulfills all his obligations under the Contract.
- 5.2. The Contractor shall erect and maintain on the Site any temporary storage facility as required and approved by the Engineer.
- 5.3. Multiple handling and movement of materials during storage and retrieval shall be avoided.

6. Spare Parts:

- 6.1. Spare Parts required after the taking over the Plant shall be filled up by the bidder in the price schedule.
- 6.2. Spares during pre-commissioning trials, commissioning tests/maintenance, guarantee etc. shall be provided by the Contractor. The necessary spares shall be brought by the Contractor prior to the pre-commissioning test so as to avoid the downtime of equipment due to non-availability of them. All these spares have to be provided as required, by Contractor free of cost.
- 6.3. All spare parts shall be new, unused and strictly interchangeable with the parts for which they are intended to be replacements and shall be treated and packed for long storage under the climatic conditions prevailing at the Site. Each spare part shall be clearly marked or labeled on the outside of its packing with its description, number and purpose. When more than one spare is packed in a single case or other container, a general description of its contents shall be shown on the outside of such case or container and a detailed list enclosed. All cases, containers and other packages shall be marked and numbered in an approved manner for the purpose of identification. Spares shall be delivered to Site after the completion of erection but before start of commissioning of Plant along with technical leaflets and details. Spare parts shall be indicated in the assembly drawing showing clearly the part numbers.

6.4. All cases, containers or other packages are liable to be opened for such examination as the Engineer's Representative may require and packing shall be designed to facilitate opening and thereafter re-packing. In the event of the some specific spares offered in the Contract being withdrawn from manufacture owing to changes in design of equipment or similar reasons viz., model being obsolete etc., the Contractor shall inform the Employer before such withdrawal so that the Employer can take timely alternative steps.

7. Tools:

7.1. Tools shall be delivered to site just prior to Tests on Completion.

7.2. The specified tools shall not be used for the erection of the Plant being supplied and except that the Engineer may call upon the Contractor to demonstrate their use or effectiveness, they must be handed over to the Employer in a completely new and unused condition. Should the Contractor require any such tools at site for erection, he shall provide his own.

The test equipment shall include special purpose items essential to the testing or re-calibration of related items of Facilities.

MATERIALS AND WORKMANSHIP

1. Introduction

1.1. This part of the Specification sets out the general standards of materials to be supplied and the workmanship required to be ensured by the Contractor. All component parts of the Works shall, unless otherwise specified, comply with the provisions of employer's requirement or be subject to the approval of the Employer. Particular attention shall be paid to a neat, orderly and well-arranged installation carried out in a methodical competent manner.

2. Reference Specifications and Standards

- 2.1. Where reference is made in the Specification to a British Standard Specification (hereinafter abbreviated to 'B.S') issued by the British Standards Institution of 2, Park street, London W.1., or to an Indian Standard Specification (I.S.) issued by the Bureau of Indian Standards, (earlier known as Indian Standard Institution), Manak Bhavan, 9 Bahadur shah Zafar Marg, New Delhi 110 002, or American Society for Testing and materials (ASTM) issued by ASTM 1916 Race Street, Philadelphia, P.A., 19103, U.S.A. or American national Standards Institute (ANSI) issued by ANSI 1430, Broadway, New York, N.Y., 10018, U.S.A. or Japanese Industrial Standards (JIS) issued by Japanese Standards Association, 4-1-24, Akasaka, Minato-Ku, Tokyo 107, Japan or to any other equivalent Standard it shall be to the latest revision of that Standard at the Tender opening date.
- 2.2. The Contractor may propose at no extra cost to the Employer, the use of any relevant authoritative Internationally recognised Reference Standard.
- 2.3. All details, materials and equipment supplied and workmanship performed shall comply with the specified Standards. If Tenderer offers equipment to other Standards, the equipment/material should be equal or superior to those specified and full details of the difference shall be supplied.
- 2.4. In the event of conflict between this Specification and the Codes for equipment, provisions of this Specification shall govern. Certain specifications issued by national or other widely recognised bodies are referred to in this Specification. In referring to the Standard Specifications the following abbreviations are used:

IS	:	Indian Standard
ANSI	:	American National Standards Institute
API	:	American Petroleum Institute
ASME	:	American Society of Mechanical Engineers
ASTM	:	American Society of Testing and Materials
AWS	:	American Welding Society
AWWA	:	American Water Works Association
ISO	:	International Organization for Standardization
DIN	:	Deutsches Institute fur Normung
BS	:	British Standard
IEC	:	International Electrotechnical Commission
IEE	:	Institution of Electrical Engineers
IEEE	:	Institute of Electrical and Electronic Engineers
NEMA	:	National Electrical Manufacturers Association
AGMA	:	American Gear Manufacturer's Association

3. Materials - General

- 3.1. All materials incorporated in the Works shall be the most suitable for the duty concerned and shall be new and of reputed make/approved quality, free from imperfections and selected for long life and minimum maintenance. Non-destructive tests, if called for in the Specification, shall be carried out. All submerged moving parts of the Plant, or shafts and spindles or faces etc. in contact with them shall be of corrosion resistant materials. All parts in direct contact with various chemicals, shall be completely resistant to corrosion, or abrasion by these chemicals, and shall maintain their properties without aging due to the passages of time, exposure to light or any other cause.

4. Workmanship – General

- 4.1. Workmanship and general finish shall be of first class quality and in accordance with best workshop practice.

- 4.2. All similar items of the Plant and their component parts shall be completely interchangeable. Spare parts shall be manufactured from the same materials as the originals and shall fit all similar items.
- 4.3. All parts, which can be worn or damaged by dust, shall be totally enclosed in dust proof housings. All materials incorporated in the Works shall be the most suitable for the duty concerned, free from imperfections and selected for long life and minimum maintenance. All necessary accessories required for satisfactory and safe operation of the Plant shall be supplied by the Contractor unless it is specifically excluded from his scope. Suitable provision by means of eyebolts or other means are to be provided to facilitate handling of all items that are too heavy or bulky for lifting and carrying by two men.

5. **Welding**

- 5.1. Welding shall comply with the latest revision of the BS 5135 Code.
- 5.2. Welders shall be qualified in accordance with the requirement of the appropriate section of BS 4871. The Engineer shall have the right to call for further qualification from time to time from any welder who in the opinion of the Engineer does not produce weld in accordance with the qualification. Each welder shall be assigned a number and letter. Each weldments shall clearly be identified as to its welder marking the welder's Code adjacent to the welds. A record chart shall be maintained for each welder showing the procedures for which he has qualified, the date of such qualification, the type of defects produced and their frequency. The Engineer shall disqualify the welder whose Work requires a disproportionate amount of repairs. All procedures where required shall be qualified as per BS EN 283-3.
- 5.3. Inspection and quality of surveillance shall not be limited to the examination of finished welds. The techniques employed shall be based on methods which are known to produce good results and which have been verified at Site by actual demonstration.
- 5.4. Haphazard striking of the electrodes for establishing an arc shall not be permitted. The arc shall be struck either on the joint or on a starting tag. The starting tag shall be of the same material or a material compatible with the base metal being welded. In case of any inadvertent strike on place other than the welding, the area affected shall be ground flushed and examined by liquid penetration method.
- 5.5. Generally, a stringer bead technique shall be used with a slight oscillation of necessary to avoid slag and to minimize the number of beads needed to fill exceed 3 times the wire diameter. Vertical welds shall be made in upward direction. For all pipes above 300 mm dia., welding shall be done whenever possible, by 2 welders working simultaneously along both sides of the pipe.
- 5.6. The root pass shall have less than 1.5 mm internal reinforcement. Defects like icicles, burn through and excessive "such back", etc. shall be cause for rejection of welds.
- 5.7. Final welds shall be suitable for appropriate fabrication of the non-destructive examination of the weld. If grinding is necessary, the weld shall be blended into the parent metal without gouging or thinning of the parent metal in any way. Uneven and excessive grinding may be a cause for rejection. Fillet weld shall preferably be convex and free from undercutting and overlap at the toe of weld. Convexity and concavity shall not exceed 1.5 mm. The leg lengths shall not exceed the specified size by more than 1.5 mm.
- 5.8. All attachments such as lugs, brackets and other non-pressure parts shall also be done by qualified welders in accordance with the design details and materials specifications. Temporary attachments shall be removed in a manner that will not damage the parent metal. Areas of temporary attachments shall be dressed smooth and examined by ultrasonic or liquid penetration methods.
- 5.9. All tack welds shall be made using qualified procedure and welders, the number of size of tack welds shall be kept as small as to consist of adequate strength and joint alignments. All tack welds shall be examined visually for defects and if found defective shall be completely removed. As welding proceeds, tack welds shall be either removed completely or shall be properly prepared by grinding or filling their starting ends so that they may be satisfactorily incorporated in the welds. Unacceptable defects shall be removed by grinding machine or chipping or gouging. Flame gouging may be permitted provided gouged surfaces are ground at least by 1.0 mm below the deepest indentation.

- 5.10. All weld repairs shall be carried out using the approved welding procedures and welders. Re-welded areas shall be re-examined by the methods specified for the original welds and the Engineer's Representative shall duly qualify repair procedures.

6. Pre-heating and Post-heating Treatment

- 6.1. Pre-heating and post heating treatment shall conform to the relevant application Codes. Pre-heating not exceeding 121 deg. C for all carbon steel construction above 25 mm thickness would be mandatory. Such pre-heating would be maintained during flame cutting, flame or arc gouging, welding and repairs and may be done by gas heating by gas torches/gas rings with neutral flame. The temperature shall be checked by temperature indicating crayons. However, such pre-heating will not be necessary for welds less than 6 mm size. In large diameter pipe fabricated out of plate materials, production control test plates in accordance with the BS 4870 part 1 Table 6 to represent 30% of the long seams and each welder's performance would be mandatory.

7. Electrodes

- 7.1. All electrodes shall be stored in their original sealed containers under dry conditions. Electrodes shall remain identified until consumed. All electrodes shall be dried before use. Drying ovens shall be provided in Work areas for drying purposes. Electrodes withdrawn from oven shall be promptly used and excess unused electrodes shall be promptly returned to oven.

8. Examination/NDT/Radiography

- 8.1. The various stages of examination and types shall be as stipulated in the respective fabrication Codes. Radiographic examination shall be carried out as per provisions of BS 2600 or BS 2910; Ultrasonic tests where called for shall be carried out as per provisions of BS 3926; magnetic particle tests shall be carried out as per BS 6072. Liquid penetration tests shall be carried out as per BS 6443.

9. Stainless Steel Welding

- 9.1. All welding consumable such as electrodes, filler weirs, argon gas for shielding and purging shall be of high quality and the proposed brand shall be furnished for approval of the Engineer. Weld deposits shall have similar or higher physical properties and similar chemical composition to the members joined.
- 9.2. All electrodes shall be purchased in sealed containers only and stored in their packing intact. The packets opened shall be consumed as early as possible. The electrodes removed from the containers shall be kept in holding ovens at temperatures recommended by electrode manufacturer. Special care shall be taken in avoiding mixing of electrodes in the oven. The electrodes and filling wires shall be free from rust, oil, grease, earth and other foreign matter.
- 9.3. Argon gas with purity 99.5% shall be used for shielding and purging. The purity of gas shall be certified by the gas manufacturers.
- 9.4. Non-destructive examination of the welds shall be carried out to ensure quality of weld.
- 9.5. The electric current for welding shall be direct current, straight polarity (electrode negative). The welding current shall be kept minimum possible to ensure minimum heat affected zone in the parent material. Other side of the weld joint shall be periodically flushed with argon gas.

10. Castings

- 10.1. Cast iron shall be of standard grey close-grained quality. The structure of the castings shall be homogeneous and free from non-metallic inclusions and other injurious defects. All surfaces of castings,

which are not machined, shall be smooth and shall be carefully fettled to remove all foundry irregularities.

- 10.2. Minor defects in depth not exceeding 12.5 percent of total metal thickness and which will not ultimately affect the strength and serviceability of the casting may be repaired by approved welding techniques. The Engineer shall be notified of large defects and no repair welding of such defects shall be carried out without prior approval of the Engineer. If the removal of metal for repair should reduce the stress resisting cross section of the casting by more than 25 percent, or to such an extent that the computed stress in the remaining metal exceeds the allowable stress by more than 25 percent, then casting shall be rejected. Test coupons cast simultaneously with the main castings shall be identified to check physical, chemical analysis of casting. Major defects on casting are not acceptable. Castings repaired by welding for minor defects shall be stress-relieved after such welding. Non-destructive tests as directed by the Engineer will be required for any casting containing defects whose extent cannot otherwise be judged, or to determine where repair welds have been properly made.

11. Forging

- 11.1. All major stress-bearing forging shall be made to a Standard Specification. Forging shall be subjected to magnetic particle testing or dye penetration test at the areas of fillets and change in section. The testing shall be conducted after rough machining (10 microns). Any defect, which will not machine out during the final machining, will be gouged out fully, inspected by dye penetration or magnetic particle inspection to ensure that the defect is fully removed and repaired using an approved repair procedure. Any indication, which proves to penetrate deeper than 2.5% of the finished thickness of the component, shall be reported to the Engineer giving the details like location, length, width and depth. For the magnetic particle inspection the choice of wet or dry particles shall be at the Contractor's discretion.
- 11.2. All forging shall be demagnetized after test and shall be heat-treated for the relief of residual stresses.

12. Design Life

- 12.1. The Works as a whole shall be new, of sound workmanship, robustly designed for a long reliable operating life and shall be capable of 24 hours per day continuous operation for prolonged period in the climatic and working conditions prevailing at the Site, and with the minimum of maintenance. Particular attention shall be given to temperature changes, the stability of paint finish for high temperatures, the rating of engines, electrical machinery, thermal overload services, cooling systems and the choice of lubricants for possible high and prolonged operating temperatures. The Contractor shall be called upon to demonstrate this for any component part either by service records, or evidence of similar equipment already installed elsewhere or relevant type tests. Routine maintenance and repair shall as far as possible not requires the services of highly skilled personnel.
- 12.2. The Plant shall be designed to provide easy access to and replacement of component parts, which are subject to wear, without the need to replace whole units. No parts in contact with water shall have a life from new to replacement or repair of less than five years.
- 12.3. Design features shall include the protection of Plant against damage caused by vermin, dirt, dust and dampness and to reduce risk of fire. Plant shall operate without undue vibration, and parts shall be designed to withstand the maximum stresses under the most severe condition of normal service. Materials shall have a high resistance to change in their properties due to the passage of time, exposure to light, temperature and any other cause, which may have a detrimental effect upon the performance or life of the Works.
- 12.4. Plant located outside lockable areas/building shall have additional features to prevent un-authorized operation.

13. Name Plate

- 13.1. Each item of the Plant shall have permanently attached to it in a conspicuous position, a nameplate and rating plate. Upon these shall be engraved or stamped, the manufacturer's name, type and serial number of Plant, details of the loading and duty at which the item of Plant has been designed to operate, and such diagrams as may be required by the Engineer. All indicating and operating devices shall have securely attached to them or marked upon them designations as to their function and proper manner of use.

- 13.2. Nameplates, rating plates and labels shall be of a non-flame propagating materials, either non-hygroscopic or transparent plastic with engraved lettering of a contrasting colour. Fixing shall be by means of non-corrosive screws; drive rivets or adhesives shall not be used.
- 13.3. Warning labels shall be provided where necessary to warn of dangerous circumstances or substances. Inscriptions or graphic symbols shall be black on a yellow background.
- 13.4. Instruction labels shall be provided where safety procedures such as wearing of protective clothing are essential to protect personnel from hazardous or potentially hazardous conditions. These labels shall have inscriptions or graphic symbols in white on a blue background.

14. Nuts, Bolts, Studs and Washers

- 14.1. Nuts, bolts, studs and washers for incorporation in the Plant shall conform to the requirements of the appropriate standard. Nuts and bolts shall be of the best quality of specified grade, machined on the shank and under the head and nut
- 14.2. Fitted bolts shall be a light driving fit in the reamed holes they occupy, shall have the screwed portion of such a diameter that it will not be damaged in driving and shall be marked in a conspicuous position to ensure correct assembly at Site.
- 14.3. Washers, locking devices and anti-vibration arrangements shall be provided where necessary. Jointing hardware for the entire Plant shall be provided with sufficient spares to cater for site losses.
- 14.4. Where bolts pass through structural members taper washers shall be fitted, where necessary, to ensure that no bending stress is caused in the bolt. Where there is a risk of corrosion, bolts, nuts and studs shall be designed so that the maximum stress does not exceed half the yield stress of the material under any conditions. All bolts, nuts and washers that are subject to frequent adjustment or removal in the course of maintenance and repair shall be made of nickel-bearing stainless steel.
- 14.5. The Contractor shall supply all holding down, alignment and leveling bolts complete with anchorages, nuts, washers and packing required to attach the Plant to its foundations, and all bed plates, frames and other structural parts necessary to spread the loads transmitted by the Plant to concrete foundations without exceeding the design stresses.

15. Allowances for Wastage

- 15.1. The Contractor shall supply reasonable excess quantities to cover wastage of those consumable, which will be normally subject to waste during erection, commissioning and setting to Work.

16. Painting – General

- 16.1. The Contractor shall be responsible for the cleaning, preparation for painting, and priming or otherwise protecting, as specified, all parts of the Plant at the place of manufacture prior to packing.
- 16.2. Parts may be cleaned but surface defects may not be filled in before testing at the manufacturer's works. Parts subject to hydraulic test shall be tested before any surface treatment. After test, all surfaces shall be thoroughly cleaned and dried out, if necessary by washing with an approved de-watering fluid prior to surface treatment. Except where the specification provides to the contrary all painting materials shall be applied in strict accordance with the paint manufacturer's instructions.
- 16.3. All protective coatings shall be suitable for use in warm humid climates. All primers, under coats and finishes shall be applied by brush or airless spray, except where otherwise specified. Consecutive coats shall be in distinct but appropriate shades. All paints shall be supplied from the store to the painters, ready for application, and addition of thinners or any other material shall be prohibited.

17. Painting at Place of Manufacture

- 17.1. Steel and cast iron parts shall be sand blasted to near white cleaning before painting. Edges, sharp corners etc. shall be ground to a curve before sand blasting. A primer coat of a zinc rich epoxy resin based coating with at least 75 microns dry film thickness is to be provided. In addition the parts are to be provided with

adequate number of coats of coal tar epoxy polyamine coating to a dry film thickness of 175 microns including primer coating.

18. Painting at Site

- 18.1. Immediately on arrival at the site, all items of Plant shall be examined for damage to the paint coat applied at the manufacturer's works, and any damaged portions shall be cleaned down to the bare metal, all rust removed, and the paint coat made good with similar paint.
- 18.2. After erection, such items, which are not finish painted, shall be done so and, items that have been finish painted at the manufacturer's works shall be touched up for any damaged paintwork. For finish painting, two coats of synthetic enamel conforming to IS: 2932 shall be applied. Dry film thickness of each coat shall be at least 25 microns.
- 18.3. The dry paint film thickness shall be measured by Electrometer or other instruments approved by the Employer. In order to obtain the dry film thickness specified the Contractor should ensure that the coverage rate given by the paint manufacturer would enable this thickness to be obtained. Strength of adhesion shall be measured with an adhesion tester and this value shall not be less than 10 kg/cm². Painted fabricated steel work which is to be stored prior to erection shall be kept clear of the ground and shall be laid out or stacked in an orderly manner that will ensure that no water or dirt can accumulate on the surface. Suitable packing shall be laid between the stacked materials. Where cover is provided, it shall be ventilated.

26.0 Mode of measurement and payments: **Payment will be as per payment schedule.**

EXECUTIVE ENGINEER,
BUILDING DEPARTMENT
BHAVNAGAR MUNICIPAL CORPORATION
BHAVNAGAR

**EXECUTIVE ENGINEER
BUILDING DEPARTMENT
BHAVNAGAR MUNICIPAL CORPORATION**

BHAVNAGAR

PROPOSED DEVELOPMENT OF FIRE STATION AND FIRE STAFF QUARTERS AT PRABHUDAS
TALAV, FOR BHAVNAGAR MUNICIPAL CORPORATION, BHAVANAGAR

.

SPECIFICATION FOR LANDSCAPING WORK

DEV DUTT PANDYA AND ASSOCIATES
ARCHITECT & INTERIOR DESIGNERS,
DM-10, NEAR BINDUNI WAS, KALVIBID MAIN ROAD,
BHAVNAGAR-364002
PHONE NO (0278) 2569070/80

SPECIFICATION FOR LANDSCAPING WORK

1. AREA CLEANING:

Clearing of the site and roughly dressing the same manually or mechanical devices, including cutting down all waste vegetation, removal of the existing roots of plants/trees, removing debris or previously executed civil work.

2. AREA DRESSING & LEVELING

(2"-3" spreading of existing soil & manual compaction as per drawing, design, specification and direction of EIC. Making the soil free from debris, weeds etc. (Minimum of 90% accuracy required).

3. SHRUBBERY /HEDGE PLANTATION

(To be planted on soil already area dressed or contoured. All shrubs to be as per specified in list attached. Development of bed, plantation of shrubbery including application of FYM (5.00 M3 in 100 M2). Average 7 TO 8 plants in1 M2.

4. GRASS PLANTATION

(To be planted on GARDEN soil already area dressed or contoured. All grasses to be as specified as per list. Development of bed, plantation of shrubbery including application of FYM9FARM YARD MANURE) (5.00 M3 in 100 M2). (Vetiveria zizanioides,Saccharum munja grass)

5. TREE PLANTATION (MINIMUM 10' to 12' height)

(supply & plantation): To be planted on soil already area dressed or contoured.

Excavation of pit 1mt x 1mt x 1mt depth.

Mixing of FYM(FARM YARD MANURE) & existing soil in ratio 1:2 and planting of plants. Trees to be as er specified in the attached list. Tree plantation should be carried out neatly accurately and with perfection as per the design and drawing. Plastic bags or pots should be removed carefully and soil around the roots should not be dropped or disturbed. Water retaining basin should be made neatly around the each plantation.

6. Supply of Sweet Earth:

Supply and Spreading of Good earth at site including cost or royalty. As directed by site in charge. no void

LIST OF PLANTS

Sr.No. Name of plant M2 Minimum size from top of bag

1 Nerium var.	2.5'
2 Bougainvella	2'
3 Ficus long island	2.5'
4 Galphimia gracilis	2'
5 Hymenocallis speciosa	2.5'
6 Ixora Singaporensis (pink)	2.5'
7 Jasminum Sambac	2.5'
8 Leucothylum frutescens	2.5'
9 Murraya exotica	2.5'
10 Nerium (dwarf)	2.5'
11 Bauhinia alba	2.5'

LIST OF TREES

Sr.No. Name of Trees Minimum size from top of bag

1 Azadirachta indica
2 Bauhinia blakena
3 Butea Monosperma
4 Couropita guianensis
5 Dalbergia sissoo
6 Engenia jambolana
7 Ficus Virens
8 Ficus religiosa
9 Ficus bengalensis
10 Terminalia arjuna
11 Millingtonia hortensis
12 Polythea lonifolia
13 Plumeria
14 Mangifera indica

Each having 10 to 12 feet height with girth of 3 inch

Sr.No. Name of Grass M2 Minimum size from top of bag

LIST OF GRASS

1 Vetiveria zizanioides	2'
2 Saccharum munja grass	2'

ANTI TERMITE TREATMENT

Anti termite treatment shall be done for various types of works as under and care should be taken that proportion of chemical containing active ingredient Chlorpyrifos and other materials is maintained throughout the work and thoroughly follow instructions as per company's manual. The contractor shall have to give guarantee of the same for ten years in writing and 10 % of the above bill amount shall be retained and the same shall be release after guarantee period.

STAGE : 1

Treat the bottom surface and sides (up to 30 cm height) of the excavations made for column pits, wall trenches and basements @ 5L per sq.m of surface area.

STAGE : 2

Treat the refill earth on both sides of all built up any vertical surfaces of masonry / R.C.C. work (approximate width 30 cm and depth 45 cm) @ 7.5 L per sq.m of vertical surface of substructure.

STAGE : 3

Drill 12 mm holes at the junction of floor and walls at 30 cm c/c to reach the soil below and squirt the emulsion @ 1 litre per hole or till refusal and seal the holes properly. Treat the entire surface (before laying the floor) @ 5 liter per sq.m.

STAGE : 4

Treat the lintel , sill and vertical jambs of all door and window frames by spraying them with chemical .

**EXECUTIVE ENGINEER
BUILDING DEPARTMENT
BHAVNAGAR MUNICIPAL CORPORATION
BHAVNAGAR**

**PROPOSED DEVELOPMENT OF FIRE STATION AND FIRE STAFF QUARTERS AT PRABHUDAS
TALAV, FOR BHAVNAGAR MUNICIPAL CORPORATION, BHAVANAGAR**

.

**SECTION- IV
ELECTRICAL SPECIFICATIONS**

**ARCHITECTS:
DEV DUTT PANDYA & ASSOCIATES
ARCHITECTS AND INTERIOR DESIGNERS
DM-10 BINDU NIWAS, KALVIBID,
BHAVNAGAR- 364002
PHONE: (0278) 2569070,2569080.**

SPECIFICATIONS FOR ELECTRICAL WORKS

**SUBJECT TO THE GENERAL CONDITIONS OF
CONTRACT IN FORCE
(1986)
GENERAL**

1. Wiring Rules :

The installation generally shall be carried out in conformity with relevant Indian Standard Specifications and code of practices prevalent. Indian Electricity Rules 1956 and Indian Electricity Act. 1910 as amended from the time to time.

2. Definition :

The definition of terms shall be in accordance with Indian Standard code of Practice for Electrical wiring Installation IS-732-1982 except for the definition of point in case of Internal Electrical Installation. For definition of point wiring and measurement of Electrical works IS-59008-1970 shall be referred to.

3. Voltage and Frequency of Supply :

All current consuming devices shall be suitable for frequency of 50 C/s and system of voltage meant for unless otherwise specified.

4. Layout of wiring and its description:

(i) The wiring shall be carried out as per Schedule "power" wiring must be in screwed conduit and shall be kept separate and distinct from lighting wiring. All wiring must be done on the distribution system with main and branch distribution boards at convenient centres and without isolated fuses. All conductors shall be run as far as possible along the walls and ceiling as to be easily accessible and capable of being thoroughly inspected. The balancing of circuits will be arranged before hand by the Executive Engineer C. P. Division No. 3.

(ii) Within one month of the taking over the installation, the Contractor shall supply to the Executive Engineer, C. P. Division No. 3 a complete set of wiring diagrams of the same on drawings to be supplied when available by the Executive Engineer, C. P. Division No. 3., and to the satisfaction of the Executive Engineer, C. P. Division No. 3. and these wiring plans shall be "Drawings" within the meaning of the term as used in the General Conditions of contract.

5. Conductors :

All conductors unless otherwise specified shall not be less than 1.5 Sq. mm. for point wiring and 2.5 Sq. mm. for mains. Conductors for power and lighting circuits shall be of adequate size to carry the designed circuit load without exceeding the permissible thermal limits for the installation, and such sizes will be stipulated in specifications and or drawings.

6. Cables :

6.1 All cables shall conform to relevant Indian Standards.

6.2 Conductors of all cable except the flexible cable shall be of aluminium. The smallest aluminium conductors for the final circuit shall have nominal cross sectional area of not less than 1.5 Sq. mm. The minimum size of the aluminium conductors for power wiring shall be 4 Sq. mm.

6.3.1 Conductors of flexible cables shall be of copper. The minimum cross sectional area of such a cables shall be 14.0193 mm. The flexible cable shall have uniform and adequate insulation.

6.3.2 Unless the flexible cables and conductors are protected by armour or tough rubber or PVC Sheath, these shall not be used in workshops and other places where they are liable to mechanical damage.

6.3.3 Core flexible cables shall be used for connecting single phase Appliances for phase, neutral & earth connections.

7. Fall of Potential :

The cross sectional area of all conductors inside buildings shall be so proportioned to their lengths that the drop in voltage between main fuses and the farthest point of any lump shall not exceed three percent of the voltage of the consumer's with all the consuming devices in use.

7.1 If the CABLE SIZE is increased to avoid the voltage drop in circuit current rating of the cable shall be more than that for which the circuit is designed. In each circuit or sub circuit every cable shall have a current rating not less than that of the fuse which protects the circuit or sub circuit respectively for current higher than the full load current.

8. Ratings of lamps and fans socket outlets : Points and exhaust fans

- 8.1** Incandescent lamps installed in residential and non-residential buildings shall be rated at 60 watts & 100 watts respectively.
- 8.2** Table fans and ceiling fans shall be rated at 60 watts, exhaust fan shall be rated according to their capacity.
- 8.3** 5 Amp. socket outlet points and 15 Amp. sockets outlet points shall be rated at 100 watts and 1000 watts respectively for the purpose of load assessment unless values of the load are known or specified.

9. Tests :

- 9.1** Before the installation is commissioned following tests shall be carried out :

- (1) Insulation Resistance test
- (2) Polarity Tests of Switches
- (3) Earth Continuity tests
- (4) Earth Electrodes Resistance test

9.2.1.1 The insulation resistance shall be measured between earth and the whole system of conductors or any section thereof with all fuses in place and all switches closed, and except in earthed concentric wiring all lamps in position or both poles of the installation otherwise electrically connected together direct current pressure of not less than twice the working pressure provided that it need not exceed 500 volts for medium voltage circuits where the supply is derived that it need not exceed 500 volts for medium voltage circuits where the supply is derived from the three wire D.C. or a poly phase. A.C. System, the neutral pole of which is connected to earth either direct or through added resistance, the working pressure shall be deemed to be that which is maintained between the phase conductor and the neutral.

9.2.1.2 The insulation resistance shall also be measured between all conductors to one pole or phase conductor of the supply and all the conductors connected to the neutral or to the other pole or phase conductors of the supply with all lamps in position and switches in 'OFF' position and its value shall be not less than in that specified in Sub-Clause 9.2.1.3.

9.2.1.3 The insulation resistance in Megohms measured as above shall not be less than 50 Megohms divided by the number of outlet or when PVC insulated cables are used for wiring 12.5 Megohms divided by number of outlets.

9.2.1.4 Where a whole installation is being tested, a lower value than that given by the formula, subject to a minimum of 1 Megohm is acceptable.

9.2.1.5 A preliminary and similar test be made before lamps, etc. are installed and in this event the insulation resistance to earth should be not less than 100 Megohms divided by the number of outlet or when PVC insulated cables are used for wiring 25 Megohms divided by number of outlets.

9.2.1.6 The term "Outlet" includes every switch except that a switch combined with a socket outlet, appliance or lighting fitting is regarded as one outlet.

9.2.1.7 Control rheostat heating and power appliance and electric sign may, if required, be disconnected from the circuit during the test, but in that event the insulation resistance between the case or frame work, and all live parts of each rheostat, appliance and sign, shall be not less than that specified in the relevant Indian Standard Specification or where there is no such specification shall be not less than half a Megohm.

9.2.2 Polarity Test :

9.2.2.1 In a two wire installation a test shall be made to verify that all switches in every circuit have been fitted in the same conductor throughout & such conductor shall be labeled or marked for connection to the phase conductor or to the non-earthed conductor of the supply.

9.2.2.2 In a three wire or a four wire installation a test shall be made to verify that every non-linked single pole switch is fitted in a conductor which is labeled or marked for connection to one of the phase conductor of the supply.

9.2.2.3 The installation shall be connected to the supply for testing. The terminals of all switches shall be tested by a test lamp one lead of which is connected to the earth. Glowing of test lamp to its full brilliance, when the switch is in 'on' position irrespective of appliance in position or not shall indicate that the switch is connected to the right polarity.

9.2.3 Earth Continuity Test :

The earth continuity conductor including metal conduits and metallic envelopes of cables in all cases shall be tested for electric continuity and the electrical resistance of the same along with the earthing lead but excluding any added resistance or earth leakage circuit breaker measured from the connection with the earth electrode to any point in the earth continuity conductor in the completed installation shall not exceed one ohm.

9.2.3.1 Earth Electrode Resistance Test :

Earth electrode Resistance test may be carried out by Megger Earth Testers containing a direct reading ohm-meter, a hand driven generator and auxiliary electrodes.

9.3 On completion an electric installation (addition and alteration) a certificate shall be furnished by the Contractor countersigned by the certified Supervisor under whose direct supervision the installation was carried out. This certificate shall be in the prescribed form as given in Appendix-'B' in addition to the test certificate required by Local Electrical Supply Authorities.

10. Joint and looping back :

Unless with the sanction of Executive Engineer Divisions all joints in conductor shall be made by means of approved mechanical connectors in suitable and approved junction boxes but looping back system shall be preferable. In wiring unless otherwise specified Phase and live conduct shall be looped at the switch box where a neutral conductor can be looped from light, fan or socket. In non-residential buildings, neutral and earth continuity wire shall be brought to each of the switch boards should be of adequate size to accommodate at least one number of 5 Amps. socket outlet and control switch in future.

11. Switches :

Main Switchgears, Switch Board and their location :

- 11.1 All main switches (other than those of iron clad pattern) carrying current of 10 Amp. and above shall be fitted for back connections and shall be suitably protected.
 - 11.2 All switches and circuit breakers shall be constructed in accordance with the I. S. 4237-1967. General requirement for switchgear and control gear for voltage not exceeding 1000 volts and other relevant I.S. provided also that spring shall be either of phosphor bronze or if steel shall be copper or Nickel plated and that handle shall be so fastened that they do not tend to unscrew or become loose.
 - 11.3 All main switches shall be either of metal clad enclosed pattern or of any insulated enclosed pattern which shall be fixed at close proximity to the point of entry of supply.
 - 11.4 Switch boards shall not be erected above gas, stoves, or sinks or within 2.5 m. of any washing unit in the washing rooms of laundries or in the bath rooms, lavatories, toilets or kitchens.
 - 11.5 Switch boards, if unavoidably fixed in places likely to be exposed to weather, to drip or to abnormal moist temperature the outlet casing shall be weather proof and shall be provided with glands or bushing of adopted to receive screwed conduit according to the manner in which cables are run PVC and double flanged bushes shall be fitted in the holes of the switches for entry and exit of wires.
 - 11.6 A switch board not be installed so that its bottom is within 1.25 m. above the floor unless the front of the switch board is completely enclosed by a door or the switch board is located in a position to which only authorized persons have access.
 - 11.7 Switch boards shall be recessed in the wall if so specified in the schedule of work or in the special specification. The front shall be fitted with hinged panel of other suitable material such as bakelite in wood frame with locking arrangement, the outer surface of door being flush with the walls. Ample room shall be provided at the back for connections and at the front between the switchgear mountings and the door.
 - 11.8 Equipments which are on the front of a switch board shall be so arranged that inadvertently personal contact with live parts is unlikely during the manipulation of switchgears, changing of fuses or like operations.
 - 11.9 No holes other than the holes by means of which the panel is fixed shall be drilled closer than 1.3 cms. from any edge of the panel.
 - 11.10 The various live parts, unless they are effectively screened by substantial barriers of non-hydroscopic, non-inflammable insulating material, shall be so spaced that space shall not be maintained between such parts and earth.
 - 11.11 The arrangement of gear shall be such that they shall be readily accessible and their connections to all instruments and apparatus shall also be traceable.
 - 11.12 In every case in which switches and fuses are fitted on the same pole, these fuses shall be so arranged that the fuses are not alive when their respective switches are in the off position.
 - 11.13 No fuses other than fuses in instrument circuit shall be fixed on the back of or behind a switch board panel or frame.
 - 11.14 All the metal switchgears and switch boards shall be painted, prior to erection with one coat of antirust primer. After erection they shall be painted with two coats of approved enamel or aluminium paint as required on all sides whenever accessible.
 - 11.15 All switch board connected to medium voltage and above shall be provided with 'Danger Notice Plate' conforming to relevant Indian Standards.
- 12. Control at Point of Commencement of Supply :**
- 12.1 There shall be a linked main switchgear with fuse on each live conductor of the supply mains at the point of entry. The wiring throughout the installation shall be such that there is no break in the neutral wire except in the form of a linked switchgear. The neutral shall also be distinctly marked. In this connection Rule 32 (2) of the Indian Electricity Rules, 1966 (See Appendix - 'A') shall also be referred.
 - 12.2 The main switchgear shall be situated as near as practicable to be termination of service line and shall be easily accessible without the use of any external aid.
 - 12.3 On the main switchgear, where the conductor of a two wire system or an earthen neutral conductor of a multi-wire system or a conductor which is to be connected thereto, an indication of a permanent nature shall be provided to identify the earthen neutral conductor. In this connection Rule 32 (1) of Indian Electricity Rules, 1956 (See Appendix 'S') shall be referred.
- 13.0 Switch Board & Distribution Boards :** Metal clad switch gear shall preferably be mounted on any of the following types of Board.
- 13.1 Hinged type Metal Boards :** These shall consist of a box made of sheet metal not less than 2 mm. thick and shall be provided with a hinged cover to enable the board to swing open for examination of the wiring at the back. The joints shall be welded. A teak wood board, thoroughly protected both inside and outside with good insulating conforming to IS-347-1952 specification for varnish shellac for general purpose, and of not less than 6.5 mm. thickness, shall be provided at the back for attachment of incoming and outgoing cables. There shall be a clear distance of not less than 2.9 cm. between the teak wood board and the cover, the teak wood board and the cover, the distance being increased for larger boards in order that on closing of the cover, the insulation of the cables is not subjected to damage and no short length of cables is subjected to excessive twisting or bending in any case. The board shall be security fixed to the wall by means of rag bolts, plugs of wooden Gutties and shall be provided with a locking arrangement and earthing

stud. All wires passing through the metal board shall be bunched. Alternatively, hinged type metal boards shall be made of sheet mounted on channel or angle iron frame.

Note : Such type of boards are particularly suitable for small switch-boards for mounting metal-clad switchgear connected to supply at low voltages.

13.2 Fixed type Metal Boards : These shall consist of an angle of channel of iron frame fixed on the wall or on floor and supported on the wall at the top if necessary. There shall be a clear distance of one meter in front of the switch board. If there are attachments of base connections at the back of the switch board Rules 51 (1) (c) of Indian Electricity Rules, 1956 shall apply.

NOTE : Such type of boards are particularly suitable for large switchboard for mounting large number or switchgears of higher capacity metal clad switchgears or both.

13.3 Teakwood Boards : for small installations connected to a single phase 230 volts supply teak wood boards may be caused as main boards or sub-board. These shall be of seasoned teak or other durable wood with solid back impregnated with varnish of approved quality with all joints dovetailed.

13.4 In large size medium voltage installations, before proceeding with actual construction of the boards, a proper drawing showing the detailed dimensions and design including the disposition of the mountings, which shall be symmetrically and neatly arranged for arriving at the overall dimensions, shall be prepared and approved by the Engineer-in-charge.

13.5 Recessing of Boards : Where so specified the switch boards shall be recessed in the wall. The front shall be fitted with hinged pannel of teak wood or other suitable materials such as bakelite, or with unbreakable glass doors in teak wood frame with locking arrangement, the other surface of the door being flush with the walls. Ample room shall be provided at the back for connection and at the front between the switchgear mountings.

13.6 Arrangement of Apparatus :

(a) Equipment which is on the front of switch board shall be so arranged that inadvertently personal contact with live parts is unlikely during the manipulation of switches, changing of fuses or like operation.

(b) No apparatus shall project beyond any edge of pannel. No fuse body shall be mounted within 2.5 cm. of any edge of the panel and no hole other than holes by means of which the panel is fixed shall be drilled closer than 1.3 cms from any edge of the pannel.

(c) The various live parts, unless they are effectively screened by substantial barriers of non-hyrosopic, non-inflammable insulating material, shall be so spaced that an arc cannot maintain between such parts and earth.

(d) The arrangement of the gear shall be such that they shall be readily accessible and their connections to all instruments and apparatus shall also be easily traceable.

(e) In every case in which switches and fuses are fitted on the same pole, these fuses shall be so arranged that the fuses are not alive when their respective switches are in the 'OFF' position.

(f) No fuses other than fuses instrument circuit shall be fixed on the back of or behind a switch board pannel or flame.

13.7 Marking of Apparatus :

(a) Where a board is connected to voltage higher than 250 volts, all the apparatus mounted on it shall be marked in the following colours to indicate the different poles or phases to which the apparatus of its different terminals may have been connected.

Alternating Current

Direct Current

Three-phase-red

Three wire system-2 outer wires

Yellow & Blue

Positive red & Negative Blue

Natural-Black

Natural-Black

Where fuse-wire three phase wiring is done, the neutral shall be in on colour and the other three wires in another colour.

(b) Where a board has more than one switch, each such switch shall be marked to indicate which section of the installation it controls.

(c) All markings required under the rule shall be clear permanent.

13.8 Main & Branch Distribution Board :

13.8.1 Main and branch distribution boards shall be of any type mentioned in 13.1

13.8.2 Main distribution boards shall be provided with a switch or air circuit breaker on each pole of each circuit a fuse on the phase or live conductor and a link on the neutral or earthed conductor of each circuit. The switches shall always be linked.

13.8.3 Branch Distribution Board :

13.8.3.1 Branch distribution boards shall be provided with a fuse or a miniature circuit breaker or both the adequate rating setting chosen on the live conductor of each circuit and the earthed neutral conductor shall be connected to a common link and be capable of being disconnected individually for testing purposes. At least one spare circuit of the same capacity shall be provided on each branch distribution board.

13.8.3.2 In residential installations, lights and fans any be wired on a common circuit, such sub, circuit shall not have more than total of ten points of lights, fans and socket outlets. The load of such circuit shall be restricted to 800 watts. If a

separate fan circuit is provided, the number of fans in the circuit shall not exceed ten. Power sub-circuits shall be designed according to the load but in no case shall there be more than two outlets on each sub-circuits.

13.8.3.3 In industrial and other similar installations requiring the use of group control of switching operation, circuits, for socket outlets any be kept separate form fans and lights. Normally fans and lights may be wired on a common circuit, however, if need sub-circuit shall not exceed 3000 Watts. In case of new installation, all circuits and sub-circuits shall be designed by making provision of 20 percent increase in load due to any future modification. Power sub-circuits shall be designed according to the due to any future modification Power sub-circuits shall be designed according to the load but in no case shall there be more than four outlets in each sub-circuits.

13.9 Installation of Distribution Boards :

13.9.1 The distribution fuse-boards shall be located as near as possible to be center of the load they are intended to control.

13.9.2 These shall be of either metal-clad type, or all insulated type. But, if exposed to weather or damp situations, they shall be of the weather proof type and, if installed where exposed to exposed to explosive dust, vapur or gas, they shall be of flame proof type.

13.9.4 Where two or more distribution fuse boards feed low voltage these distribution boards shall be :

(1) Fixed not less than 2 m. apart, or

(2) Arranged so that it is not possible to open two at a time, namely they are interlocked and the metal case is marked 'Danger 415 Volts', or

(3) Installed in a room or enclosure accessible to only authorized persons.

13.9.5 All distribution boards shall be marked 'Lighting', 'Power', as the case may be and also marked with the voltage and number of phases of the supply. each shall be provided with a circuit list giving details of each circuit which it controls and the current rating of the circuit and size of fuse-element.

13.9.6 Triple pole distribution boards shall not be generally used for final circuit distribution unless specific approval of Engineer-in-charge is obtained. In special cases where use of Triple pole distribution boards are inevitable they shall be of H.R.C. fuse type only.

13.10 Wiring and Distribution Board :

13.10.1 In wiring a branch board, total load of the consuming devices shall be divided, as far as possible, evenly between the number of ways of the boards leaving the spare circuit for future extension.

13.10.2 All connection between pieces of apparatus or between apparatus and terminals on a board shall be neatly arranged in a definite sequence following the arrangement of the apparatus mounted thereon, avoiding unnecessary crossing.

13.10.3 Cables shall be connected to a terminal only be soldered or welded or crimped lugs using suitable sleeve, lugs or ferrules unless the terminal is of such a form that it is possible to securely clamp them without the cutting away of cable stands.

13.10.4 All bare conductor shall be rigidly fixed in such a manner that clearance of at least 2.5 cms. is maintained between conductor of opposite polarity or phase and between the conductors and any martial other then insulating material.

13.10.5 If required a pilot lamp shall be fixed and connected through on independent single pole switch and fuse to the bus-bars of the board.

13.10.6 In a hinged type board, the incoming and outgoing cables shall be fixed at one or more points according to the number of cables on the back of the board leaving suitable space in between cables and shall also, if possible be fixed at the corresponding points on the switch board pannel. The cables between these points shall be arranged to on the switch board pannel. The cables between these points shall be arranged to form a "U" or "S" shaped loop which shall be of such length as to allow the switchboard pannel to swing through an angle of not less then 90⁰.

14.0 Capacity of Circuits :

14.1 Lights and fans may be issued on a common circuits and such a circuit shall not have more than a total of ten points of lights, fan and socket outlets, or a load of 800 watts whichever is less. The power circuits shall be designed with a maximum of two outlets per circuits generally when load is not known or specified. In non-residential buildings at important District centres however one outlet per circuit may be preferred. The circuit shall be designed based on the loading of the circuit where not specified, the load shall be taken as 1 KW per outlet, Where the load is more than 1 KW it should be controlled by a isolator switch or miniature circuit breaker.

15.0 Passing Through Walls and Floors :

15.1 Where conductors pass through walls one of the following methods shall be employed. Care shall be taken to see that wires pass very freely through protective pipe or box and that the wires pass through in a straight line without any twist or cross in wires, on either ends of such holes.

(a) A teak wood box entending through the whole thickness of the wall shall be buried in he wall and casings or conductors shall be carried so as to allow 1.3 cms. air space on three sides, of the casing conductor.

(b) The conductor shall be carried either in a rigid steel conduit conforming to "IS : 1653-1964 specification for Rigid Steel conduits of Electrical wiring (Revised) or a rigid non-metallic conduit conforming to *IS : 2509-1963 specification for Rigid Non Metallic conduits for Electrical Installations, or in a porcelain tube of such size which permits easy drawing in. The end of conduit shall be neatly bushed with porcelain, wood or other approved material.

(c) Insulated conductors while passing through floors shall be protected from mechanical injury by means of rigid steel conduit (see * IS 1653-1964) to height not less than 1.5 m. above the floors and flush with the ceiling below. This steel conduit shall be earthed and securely bushed.

15.2 Where a wall tube passes outside a building so as to be exposed to weather, the outer end shall be belt mounted and turned down wards, and properly bushed on the open end.

16.0 **Fixing to Walls and Ceilings :**

Plugs for ordinary walls or ceilings shall be of well seasoned teak or other approved hardwood not less than 5 cm long 2.5 c. square on the inner end and 2 cm. square on the outer end. They shall be cemented into walls to within 7.5 mm of the surface, the remaining being finished according to the nature of the surface plaster or lime punning.

16.1 Where owing to irregular crossing or other reasons the plugging of the walls or ceiling with wood plugs presents difficulties, the wood casing, wood batten, metal conduit or cleat (as the case may be) shall be attached to the wall or ceiling in an approved in the walls before they are plastered.

16.2 To achieve neatness, plugging of walls or ceiling may be done by an approved type of asbestos, metallic or a fiber fixing plug.

17.0 **Branch Switches :**

Where the supply is derived from a three-wire or four-wire source, and distribution is done on the two wire system, all branch switches shall be placed in the outer or live conductor of the circuit and no single-phase switch or fuse shall be inserted in the middle wire, earth or earthed neutral conductor of the circuit, Single-pole switches (other than for multiple control) caring not more than 15 amperes may be of tumbler type which shall be 'ON' when the handle known is down.

18.0 **Fittings :**

Where conductors are required to be threaded through tubes or channels formed in the metal work of fittings these must be free from sharp angles or projecting edges and such size that will enable them to be wired the conductors used for the final sub Circuits without removing the boarding, taping or outer covering. As far as possible, all tubes and channels should be of sufficient size to permit 'Looping back' of wires cables and flexible cords other than those designed for high temperature shall not be used for wiring fittings except for portable fittings. All fittings must have not less than a half inch male nipple. Fittings and lamp holders for gas filled lamps shall be adequately ventilated.

18.1 Where light fitting is supported by one or more flexible cords, the maximum weight to which the twin flexible cords may be subjected shall be as follows :

Nominal cross sectional Area cord. mm ²	No. & Dia in mm of wires.	Max Permissible weight Kg.
0.5	16/0.2	1.7
0.75	24/0.2	2.6
1.0	32/0.2	3.5
2.5	48/0.2	5.3
3.5	80/0.2	8.8
4	128/0.2	14.0

8.2 No inflammable shade shall form a part of light unless such shade is well protected against all risks of fire. Celluloid shade or light fitting shall not be used under any circumstances.

8.3 **Fitting of Wire :**

The use of fitting wire shall be restricted to the internal wiring and the lighting fittings. Where fitting wire is used for wiring, the sub-circuit loads shall be terminated in a ceiling zone or connector from which they shall be carried into the fitting.

9.0 **Lamp Holders :**

Lamp holders for use on brackets and the like shall be in accordance with "IS : 1258-1967, specification for Boyonet lamp holder and all those for use flexible panants shall be provided with cord grips. All lamp holders shall be provided with shade carriers. Where centre contact Edison screw lamp holders are used, the outer or screw contacts shall be connected to the middle wire, the natural, and the earthed conductor of the circuit.

20. **Outdoor Lamps :**

External and road lamps shall have weather proof fittings of approved design so as to effectively prevent the admission of moisture. An insulating distance piece of moisture proof materials shall be inserted in the fittings. Flexible cord and cord grip lamp holders shall not be used where exposed to weather. In verandahs and similar exposed situations where pendants are used, they shall be of fixed road type.

21.0 **Lamps :**

All incandescent lamps, unless otherwise required and suitably protected, shall be hung at a height of not less than 2.5 m above the floor level, They shall be in accordance with IS : 418 : 1957 specification for Tongster Filament General service electric lamps.

22.0 Fans, Regulators and Clamps :

22.1.0 Ceiling fans :

Ceiling fans including their suspension shall conform to * IS 374-1960 specification for electric ceiling fans and regulators (Revised) & to the following requirements :

- (a) All ceiling fans shall be wired to ceiling roses or to special connector boxes, to which fans rod wires shall be connected and suspended from hooks or shackles with insulators between hooks and suspension rods. There shall be no joint in the suspension rod, but if joints be unavoidable then such joints shall be screwed to special couplers of 5 cm minimum length and both ends of pipes shall touch together within couplers, and shall in addition be secured by means of split pins; alternatively, the two pipes any be welded.
- (b) Fans clamps shall be of suitable design according to the nature of construction of ceiling on which these clamps are fitted. In all cases fan clamps shall be fabricated from tested new metal of suitable sizes and they shall be as close fitting as possible. Fan clamps for reinforced concrete roots shall be buried with the casting end due care shall be taken that they shall serve the purpose. Fan clamps for wood beams shall be of suitable flat iron fixed on two sides of the beam and according to the size and section of the beam one or two mild steel bolts passing through the beam shall hold both flat irons together. Fan clamps for steel joint shall be fabricated from tested flat iron to fit in rigidly to the bottom flange of the beam. Care shall be taken during fabrication that the metal does not crack while hammering to shape. Other fan clamps shall be made to suit the position, but in all cases care shall be taken to see that they are rigid and safe.

NOTE : All fan clamps shall be so fabricated that fans revolve steadily.

- (c) Canopies on top and bottom of suspension rod shall effectively hide suspensions and connections to fan motors, respectively.
- (d) The lead-in-wire shall be nominal cross-sectional area not less than 1.0 mm² with copper and 1.5 mm² with aluminium and shall be protected from abrasion.
- (e) Unless otherwise specified, the clear distance between the ceiling fan and the floor shall not be less than 2.75 m.

22.2.0 Exhaust Fans :

For fixing of an exhaust fan, a circular hole shall be provided in the wall to suit the size of the frame which shall be fixed by means of rag-bolts embedded in the wall. The hole shall be neatly plastered with cement and brought to the original finish of the wall. The exhaust fan shall be connected to exhaust fan point which shall be wired as neat to the holes as possible by means of a flexible cord, care being taken that the blades rotate in the proper direction.

23.0 Attachment of fittings and accessories :

23.1 In other than conduit wiring, all ceiling crosses, brackets, pendants and accessories attached to walls or ceilings shall be mounted on substantial teak wood block twice varnished after all fixing holes are made in them. Blocks shall be not less than 4 cms. deep. Brass screws only shall be used only shall be used for attaching fittings and accessories to their base blocks.

24.0 Interchangeability :

Similar part of all switches, lamp holders, distribution fuse-boards ceiling roses, brackets, pendants, fans and all other fittings of the same type shall be interchangeable in each installation.

25.0 Conduit Wiring System :

25.1.1 Type and size of conduit - All conduit pipes shall be conforming to *Is : 1653-1964, furnished with galvanized or stove enameled surface. All conduit accessories shall be of threaded type and under no circumstances pin grip type or clamp type accessories be used. No steel conduit less than 16 mm. in diameter shall be used. The number of insulated conductors that can be drawn into rigid steel conduit are given in Table II

25.1.2 Bunching of cables - Unless otherwise specified, insulated conductors of AC supply and DC supply shall be bunched in separate conduits.

25.1.3 Conduit - joints : conduit pipes shall be joined by means of screwed couplers accessories only (*IS L 2667-1964).

Specification for Fittings for Rigid Steel Conduits for Electrical Wiring : In long distance stance straight runs of conduit, inspection type couplers at reasonable intervals shall be provided or running threads with couplers and jam-puts (in the latter case the bare threaded portion shall be treated with anti-corrosive preservative) shall be provided. Thread on conduit pipes in all cases shall be between 11 mm to 27 mm long sufficient to accommodate pipes of full threaded portion of couplers or accessories Cut ends of conduit pipes shall have no sharp edges nor any of buries left to avoid damage to the insulation of conductors while pulling them through such pipes :

TABLE - II
MAXIMUM PERMISSIBLE NUMBER OF 250-V
GRADE SINGLE CORE CABLES THAT CAN BE DRAWN INTO RIGID STEEL CONDUIT
(CLAUSE 6.5.1.1)

Size of cable			Size of conduit (mm.)													
Nominal	No. and		16	:	20	:	25	:	32	:	40	:	50	:	63	:
Crossect-	Dia. in		:		:	(No. of cables, Max)	:		:		:		:		:	
ional area.	mm of wires		:		:		:		:		:		:		:	
			S	B	S	B	S	B	S	B	S	B	S	B	S	B
1.0	1/1.12	5	4	7	5	13	10	20	14	-	-	-	-	-	-	-
1.5	1/1.40	4	3	7	5	12	10	20	14	-	-	-	-	-	-	-
2.5	1/1.80	3	2	6	5	10	8	18	12	-	-	-	-	-	-	-
4	1/2.24	3	2	4	3	7	6	12	10	-	-	-	-	-	-	-
		(3/1.06*)														
		(7/0.85)														
6	1/2.80	2	-	3	2	6	5	10	8							
		(7/1.06*)														
10	1/3.55+	-	-	2	5	4	8	7	-	-	-	-	-	-	-	-
		7/1.40*	-	-	2	-	4	3	6	5	8	6	-	-	-	-
16	7/1.70	-	-	-	-	2	-	4	3	7	6	-	-	-	-	-
25	7/2.24	-	-	-	-	-	-	3	2	5	4	7	6	9	7	
35	7/2.50	-	-	-	-	-	-	2	-	4	3	7	5	8	6	
50	7/3.00+	-	-	-	-	-	-	-	-	2	-	5	4	6	5	

*For Cu. Conductors only.

+ For Al. conductor only.

NOTE 1 The cable shows the maximum capacity of conditions for the simultaneous drawing-in of cables. The table applies to 250 volts grade cable. The columns headed 'S' apply to runs of conduit which have distance not exceeding 4.25 M between draw in boxes, and which do not deflect from the straight by angle of more than 15⁰. The columns headed 'B' apply to runs of conduit which deflect from the straight by an angle of more than 15⁰.

NOTE 2 In case of inspection type draw-in box has been provided and if the cables is first drawn through one straight conduit, then through the drawn box, and then through the second straight conduit, such systems may be considered as that of a straight conduit even if the conduit deflects through the straight by more than 15⁰.

25.1.4 Protection against dampness - In order to minimize condensation or sweating inside the tube, all outlets of conduit system shall be property drained and ventilated, but in such a manner as to prevent the entry of insects as far as possible.

25.1.5 Protection of conduit against rust : The outer surface of the conduit pipes, including all bends, unions, tees junction boxes, etc., forming part of the conduit system shall be adequately protected against rust particularly when such system is exposed to weather. In all cases, no bare threaded portion of conduit pipe shall be allowed unless such bare threaded portion is treated with anti-corrosive preservative or covered with approved plastic compound.

25.1.6 Fixing of conduit - Conduit pipes shall be fixed by heavy gauge saddles, secured to suitable wood plugs or any other approved plug with screws in an approved manner at an interval of not more than one metre but on either side of couplers bends or similar fittings. Saddles shall be fixed at a distance of 30 cm. from the centre of such fittings.

25.1.7 Bends in conduit - All necessary bends in the system including diversion shall be done by bending pipes. or inserting suitable solid or inspection type normal bends, elbows or similar fittings; or by fixing cast iron inspection boxes whichever is more suitable. Conduit fitting shall be avoided as far as possible. On conduit system exposed to weather, where necessary, solid type fitting shall be used. Radius of such bends in conduit pipes shall be not less than 7.5 cm. No length of conduit shall have more than the equivalent of four quarter bends from outlet, the bends at the outlets not being counted.

25.1.8 outlets - All outlets for fitting switches etc. shall be boxes of suitable metal or any other approved outlet boxes for other surface mounting or flush mounting system.

25.1.9 Conductor - All conductor used in conduits wiring shall preferably be stranded. No single-core cable or nominal Cross-sectional area greater than 130 mm² shall be enclosed in a conduit and used for alternating current.

25.1.10 Erection and earthing of conduit - The conduit of each circuit or section shall be completed before conductors are drawn in. The entire system of conduit after erection shall be tested for mechanical and electrical continuity throughout and permanently connected to earth conforming to the requirements specified under 7 by means of special approved tupe earthing clamp efficiently fastened to conduit pipe in a workman like manner for a perfect continuity between each wire and conduit Gas or water pipes shall not be used as earth medium. If conduit pipes are liable to mechanical damage they shall be adequately protected.

25.2 Recessed Conduit wiring system with Rigid Steel conduits - Recessed conduit wiring system shall comply with all the requirements for surface conduit wiring system specified in 6.5.1.1 to 6.5.1.10 and addition, conform to the requirements specified in 6.5.2.1 to 6.5.2.4.

25.2.1 Making of chase - The chase in the wall shall be neatly made and be of ample dimensions to permit the conduit to be fixed in the manner disired. In the case of buildings under construction, chases shall be provided in the wall, ceiling etc., at the time of their construction and shall be filled up neatly after erection of conduit and brought to the original finish or the wall.

25.2.2 Fixing of conduit in chase - The conduit pipe shall be fixed by means of staples or by means of saddles not more than 60 cm. apart. Fixing of standard bends or elbows shall be avoided as far as practicable and all curves maintained by bending the conduit pipe itself with a longe radius which will permit easy drawing in of conductors. All threaded joints of rigid steel conduit shall be treated with some approved preservative compound to secure protection against rust.

- 25.2.3 Inspection boxes** - Suitable inspection boxes shall be provided to permit periodical inspection and to facilitate removal of wires, if necessary. These shall be mounted flush with the wall. Suitable ventilating holes shall be provided in the inspection box covers.
- 25.2.4 Type of accessories to be used** - All outlets such as switches and wall sockets, may be either or flush mounting type or surface mounting type.
(a) Flush mounting type : All flush mounting outlets shall be of cast iron mild steel boxes with a cover of approved insulating material or shall be a box made of suitable insulating material. The switches and other outlets shall be mounted on such boxes as would be approved. The metal box shall be efficiently earthed with conduit by an approved means of earth attachment.
(b) Surface mounting type - If surface mounting type outlet box is specified, it shall be of any approved insulating material and outlet mounted in an approved manner.
- 25.2.5** When crossing through expansion joints in buildings, the conduit sections across the joint may be through flexible conduits of the same size as the rigid conduit.
- 25.3 Conduit Wiring system with Rigid Non-Metallic Conduits** : Rigid Non-Metallic conduits are used for surface, recessed and concealed conduit wiring.
- 25.3.1 Type and size** - All non metallic conduits used shall conform to IS : 2509-1963-The conduit may be either threaded type or plain type as specified in IS : 2509-6913* and shall be used with the corresponding accessories (See IS : 3419-1965) specification for Fittings for Rigid Non-Metallic Conduits).
- 25.3.2 Bunching off cables** - Conductors of AC supply and DC supply shall be bunched in separate conduits. The number of insulated cables that may be drawn into the conduits are given in Table III. In this table space factor does not exceed 40 percent.

TABLE - III
MAXIMUM PERMISSIBLE NUMBER OF 250 VOLTS GRADE SINGLE -
CORE CABLE THAT MAY BE DRAWN INTO RIGID NON-METALLIC CONDUITS

Size of cable		Size of conduit (mm.)					
Nominal	No. & Diameter	16	20	25	32	40	50
Cross Sectional Area	in mm. of wires	(Number of Cables, Max)					
mm ²							
1.0	1/1.12*	5	7	13	20	-	-
1.5	1/1.40	4	6	10	14	-	-
2.5	1/1.80	3	5	10	14	-	-
	3.1.06*						
4	1/2.24	2	3	6	10	14	-
	7/0.85*						
6	1/2.80	-	2	5	8	11	-
	7/1.06*						
10	1/3.55+	-	-	4	7	9	-
	7/1.40*						
16	7/1.70*	-	-	2	4	5	15
25	7/2.24	-	-	-	2	2	6
35	7/2.50	-	-	-	-	2	5
50	7/300+	-	-	-	-	2	3
	19/1.80						

* For copper conductors only.

+ For aluminium conductors only.

- 25.3.3 Conduit joints** - Conduit joints shall be jointed by means of screwed or plain couplers depending on whether the conduits are screwed or plain. Where there are long runs of straight conduit. Inspection type couplers shall be provided at intervals. For conduit fittings and accessories reference may be made to IS : 3419-1965.
- 25.3.4 Fixing of conduits** - The provision of 25.1.6 shall apply except that the spacing between saddles or supports is recommended to be 60 cms. for rigid non-metallic conduits.
- 25.3.5 Bends in conduit** - Wherever necessary, bends or diversions may be achieved by bending the conduits (See 6.5.3.9) or by employing normal bends, inspection bends, inspection boxes, elbows or similar fittings.
- 25.3.6** Conduit fittings shall be avoided, as far as possible on outdoor system.
- 25.3.7 Outlets** - All the outlets for fittings, switches, etc., shall be boxes of substantial construction. In order to minim use condensation or switching inside the conduit, all outlets of conduit system shall be properly drained and ventilated, but in such a manner as to prevent the entry of insects, etc. as far as possible.
- 25.3.8** For use with recessed conduit wiring system the provisions of 6.5.2.1 to 6.5.2.4 shall apply.
- 25.3.9** Heat may be used to soften conduit for bending and forming joints in case of plain conduits. As the material soften when heated, fitting of conduit in close proximity to hot surfaces should be avoided. Caution should be exercised in the use of the conduit in locations where the ambient temperature is 50 C or above. Use of such conduits in place where ambient temperature is 60 C or above is prohibited.

PVC INSULATED P.V.C. SHEATHED OR T.R.S. WIRING SYSTEM

26.0 GENERAL :

This system of wiring, is suitable for low pressure installation, and shall not be used in places exposed to sun and rain nor in damp places, provided they are sheathed in the special approved protective covering and well protected to withstand dampness.

26.1 Attachment to walls and ceiling :

26.1.1 All cables on brick walls, stone or plastered walls ceiling shall be run on well seasoned, perfectly straight and well varnished on four sides, teak wood or any approved hardwood battens not less than 10 mm finished thick, width of which shall be such as to suit total width of cables laid on the batten, prior correction, these shall be painted with one coat of varnish or approved paint of colour to match with surrounding. These battens shall be secured to wall and ceilings by flat head wood screws to rows plug or phill plug at an interval not exceeding 75 cm. Wood plug can be used only with special approval of the Engineer-in-charge. The flat head wood screws shall be counter within wood batten and smoothed down with file.

26.1.2 Where wiring is to be carried out along the face of the rolled steel joints, a wooden batten of adequate width shall first be laid on the same and dipped to it as inconspicuously as possible. The wiring should then be fixed to this backing in the ordinary way. Where wiring passes through structural steel work, the hole shall be suitably bushed to prevent the abrasion of the cables.

26.1.3 **Attachment to false ceiling :** In no case, the open wiring shall be run above the false ceiling without the approval of Engineer-in-charge.

26.2.0 **Link dips :** Only aluminium alloy clips/joint clips shall be used. The thickness shall be 0.32 mm (30 SWG) for lengths of 25 mm to 40 mm and 40 mm (28 SWG) for lengths of 50 mm to 80 mm. The width shall not be less than 8 mm in all these cases. Link clips/joint clips shall be so arranged that one single clip shall not hold more than two core or three single core TRS of PVC insulated and PVC sheathed upto 2.5 sw. mm. above while a single clip shall hold a single twin core or two single core cables. The clips shall be fixed on varnished wood batten switch iron pins and spaced at interval of 15 cm both in the case of horizontal and vertical runs.

26.3.0 **Bends in wiring :** The wiring shall not in any circumstances be bent so as to form an abrupt right angle but must be rounded off at the corners to radius not less than six times the overall diameter of the cable.

26.4.0 Protection of wiring form Mechanical Damage :

26.4.1 In cases where there are chances of any damage to wiring, such wiring shall be drawn complying with the all the requirements of conduit wiring system.

26.4.2 Such protective covering shall in all cases be fitted on all down drops within 1.5 m. from the floor or from floor level up to the switch board whichever is less.

26.5.0 **Passing through floors:** All cables taken trough floor shall be enclosed in heavy gauge steel conduit extending 1.5 m. above the floor or up to the switch board, whichever is less and flush with the ceiling below or by means of any approved type of metallic covering. The ends of all conduits or pipes shall be neatly bushed with porcelain wood or other approved material. The conduit pipes, shall be security earthed.

26.6.0 **Passing through walls:** When conductors pass through walls, any one of the following methods shall be employed. Care should be taken to see that wires pass very freely through protective pipe or box and that wires pass through in a straight line without any twist or cross in wires on either ends of such holes.

(a) A box of teak wood or approved hard wood extending through the hole thickness of the wall shall be buried in the wall and casings or conductors shall be carried so as to allow 1.3 cm air space on the three sides of the casing or conductor.

(b) The conductors shall be carried in an approved heavy gauge solid drawn or lap weld conduit or in a porcelain tube of such a size that it permits easy drawing in, the ends conduit shall be neatly bushed with porcelain, wood or other approved material.

26.6.1 Where a wall tube passes outside a building so as to be exposed to weather, the outer end shall be mounted and turned downwards and property bushed on the open end. The conduit shall be neatly arranged so that the cables enter them without bending.

26.7.0 **Buried cables:** The TRS or PVC sheathed cable shall not normally be buried directly in plaster. Where so specific in the special specification they may be taken in teak wood channeling of ample capacity or conduit pipe buried in the wall.

26.8.0 **Stripping of outer covering -** While cutting and stripping of the outer covering of the cable care shall be taken that the sharp edge of the cutting instrument does not touch the inner insulation of the conductors. The protective outer covering of the cables shall be stripped off near connecting terminal and this protective covering shall be maintained up to the close proximity of connecting terminals as far as practicable. Care shall be taken to avoid hammering on link clips with any metal instrument after the cables are laid. Where junction boxes are provided they shall be made moisture proof with a plastic compound.

27.0 PAINTING WORK IN GENERAL:

27.1 **Paints :** Paints, oils varnishes, etc., of approved make in original to the satisfaction of the Engineer-in-charge shall only be used.

27.2 **Preparation of surface :** The surface shall be thoroughly cleaned and dusted before painting is started. The proposed surface shall be inspected by Engineer-in-charge or his authorized agent and shall have received the approval before painting is commenced.

- 27.3 Application :** Paint shall be applied with brush. The paint shall be spread as smooth & even as possible. Particular care shall be paid to rivets, nuts, bolts and cover lapping. Before drawing cut, it shall be continuously stirred in the smaller containers with a smooth stick while it is being applied.
Each coat shall be allowed to dry out sufficiently before a subsequent coat is applied.
- 27.4 Scope :** Painting on old surface in indoor situations will not include primer coat except where specially mentioned in the schedule of work or special specification. However, where rust has formed on iron and steel surfaces the spots will be painted with one anti-rust primer coat.
- 27.5 Precautions :** All furniture fixtures glazing floors, etc., shall be protected by covering. All stains, smears, polishing, dropping of every kind shall be removed. While painting of wiring etc. it shall be ensured that painting of wall ceiling etc., is not spoiled in any way.
- 27.6 Painting of conduit and accessories:** After installation surface of conduit pipes, fittings switch and regulator boxes, etc. shall be painted with two coats of approved enamel paint or aluminium paint as required to match the finish of surrounding wall trusser, etc.
- 28 Link clip :**
The clip for batten wiring shall be of Aluminium conforming to I. S. specification No.2415-1975.

APPENDIX - 'A'

Important Clauses of Indian Electricity Rules, 1956 Following clauses of Indian Electricity Rules, 1956 shall in particular be taken care of in the execution of electrical works

Clause No

Subject

3. Authorisation.

- 29. Construction, installation, protection, operation and maintenance of electric supply lines and apparatuses.
- 31. Cut-out on consumer's premises.
- 32. Identification of earthed and earthed neutral conductors and position of switches and cut-out therein.
- 33. Earthed terminal on consumer's premises.
- 36. Handling of electric supply lines and apparatus.
- 41. Distinction of circuits of different voltages.
- 42. Accidental charge.
- 43. Provisions applicable to protective equipment.
- 44. Instructions for restoration of persons suffering from electric shock.
- 45. Precautions to be adopted by consumers, owners, electrical Contractors, Electrical workmen and suppliers.
- 46. Periodical inspection and testing of consumer's installation.
- 48. Precautions against leakage before connection.
- 50. Supply to consumers.
- 51. Provisions applicable to medium, high voltage installations.
- 58. Point of commencement of supply.
- 59. Precautions against failure of supply; Notice of failures.
- 61. Connection with earth, (Low and Medium Voltage system).
- 64. Use of energy of high and extra-high voltage system.
- 67. Connection with earth. (High & Extra-high voltage system).
- 68. General conditions as to transformation and control of energy.

All Clauses under Chapter VIII on Overhead Lines.

- 137. Mode of entry.
- 138. Penalty for braking seal.
- 139. Penalty for breach of rule 45.
- 140. Penalty for breach of rule 82.
- 141. Penalty for breach of rules.

APPENDIX - 'B'

Form of Completion Certificate

I/We certify that the installation detailed below has been installed by me/us and tested and that to the best of my/our knowledge and belief, it complies with Indian Electricity Rules 1956 as well as the C.P.W.D. General Specification for Electrical Works 1972.

Electrical Installation at Voltage and system of supply

(1) Particulars of Works :

(a)	Internal Electrical Installation	No. Total Load	Type of system of wiring.
	(i) Light point		
	(ii) Fan point		
	(iii) Plug point		
	(a) 3 pin 5 Amp.		
	(b) 3 pin 15 Amp.		

(b) Others :

Description	HP/KW
(a) Motor: (i)	
(ii)	
(iii)	

(c) Other Plants:

(d) if the work involves installation of overhead line/or underground cable :

- (a) (i) Type & Description of overhead line.
- (ii) Total length & No. of spans.
- (iii) No. of street light & its description
- (b) (i) Total length of under ground cable & its size.
- (ii) No. of joint.

End joint:
Tee joint:
St. through joint:

(2) Earthing :

- (i) Description of earthing electrode :
- (ii) No. of earth electrodes :
- (iii) Size of main earth lead :

(3) Test Results :

(a)	Insulation Resistance :	
	(i) Insulation resistance of the whole system of conductors to earth	Megohms
	(ii) Insulation resistance between the phase conductors and neutral	Megohms
	Between phase R and neutral	Megohms
	Between phase Y and neutral	Megohms
	Between phase B and neutral	Megohms
	(iii) Insulation resistance between the phase conductors in case of polyphase supply.	
	Between phase R & phase Y	Megohms
	Between phase Y & phase B	Megohms
	Between phase B & phase R	Megohms

(b) Polarity Test:

Polarity of non-linked single pole branch switches.

(c) Earth continuity Test:

Maximum resistance between any point in the earth continuity conductor including metal conduits & main earthing lead. ohms

(d) Earth Electrode Resistance:

Resistance of each electrode.

- (i) ohms
- (ii) ohms
- (iii) ohms
- (iv) ohms

(e) Lighting Protective System:

Resistance of the whole of lighting-protective system to earth before any bonding is effected with electrode and metal in/on the structure. ohms

Signature of Supervisor

Signature of Contractor

Name & Address

Name & Address

SPECIFICATION

All Specification, standard, publication etc. specified mean the latest standards, publication etc. pertaining to Electrical Installation and should conform to the following wherever applicable.

- (1) Indian Electricity Act. 1910 with its amendments.
- (2) Indian Electricity Rules, 1956 and its amendments.
- (3) Indian Electricity supply Act. 19948.
- (4) Regulation for Electrical Equipment in building by I.E.F. London.
- (5) The Factory Act, 1948 and its amendments.
- (6) I. S.-732-1982 Part-I, II & III code of practice for Electrical wiring and fittings in buildings for low and medium voltages.
- (7) I. S. 4064-1967 H. D. Air break switches and fuses for Voltages not exceeding 1100 volts.
- (8) I.S. 3043 - Earthing code of practice for
- (9) I.S. - 1554 Part-I 1970 PVC insulated (Heavy duty) Electrical Cables for working voltages upto and including 1100 volts.
- (10) I.S. : 694 - 1964 Part - II - PVC insulated cable with Aluminium conduits (revised) for voltages upto 1100 volts.
- (11) I.S. : 5908-1970 Electrical installations in buildings method of measurements of.
- (12) I.S. : 4237-1967 General requirement for switchgear and control for voltage not exceeding 1000 volts.
- (13) I.S. 1653-1964 - Rigid steel conduits for electrical wiring (revised)
- (14) I.S. : 2509-1973 - Rigid steel conduits for electrical installation. (First revision)
- (15) I.S. : 1258 - 1967 - Bayonet lamp holders (First revision)
- (16) I.S. : 418-1957 - Tungsten-Filament General service electric lamps (Third revision)
- (17) I.S. : 374-1966 - Fans and Regulators, ceiling type, electric (second revision)
- (18) I.S. : 2667-1964 Fittings for rigid steel conduits for electrical wiring.
- (19) I.S. : 3419-1976 - Fitting for rigid non-metallic conduits (First revision)
- (20) National Electric Code, 1986

ANNEXURE - I

Abstract of the Wiring Rules of the Institution of Electrical Engineer

(referred to in the specification)

DEFINITIONS (See Clause 2 of the Specification)

Systems :

All electrical system in which all the conductor and apparatus are electrically connected to a common source of supply.

- (1) **Earthed:** Effectually connected to the general mass of the earth, Solidly earthed means earthed without the intervention of a fuse, switch, circuit-breaker, resistor reactor or solenoid.
- (2) **Uninsulated Conductor:** A conductor without provision, by the interposition of a dielectric or otherwise, for its insulation from earth.
- (3) **Bare :** Not covered with insulating material.
- (4) **Dielectric :** Any material which offers high resistance to the passage of the an electric current.
- (5) **Bunch Conductor :** When more than one conductor is contained within a single duct or groove or when they are run enclosed and not spaced apart from each other.
- (6) **Points :** In wiring as per I.S. : 5908-1970-Method of measurements of electrical installation in buildings.
- (7) **Switch Board :** An assemblage of switchgear with or without instruments, but the term does not apply to a group of local switches in a final sub-circuit where each switch has its own insulating base.
NOTE : In the Electricity (Factories Act) special regulations, 1908 and 1944 the term "Switchboard" includes "Distribution board".
- (8) **Single pole switch :** A switch suitable for closing and or opening a circuit on one phase or pole only.
- (9) **Linked switches :** A switch the blades of which are so linked mechanically as to make or break all poles simultaneously or in a definite sequence.
- (10) **Fuse Switch :** A switch the moving part of which carries one or more fuses.
- (11) **Three Wire System :**
 - (a) **Outer Conductor:** Those between which there is the greatest difference of potential. This use of the word outer must not be confused with the use of the work when applied to the external conductor of a concentric main.
 - (b) **Neutral Conductors:** The term includes the neutral conductor of a 3 phase 4 wire system, the conductor of a single phase or d. c. installation which is earthed by the supply undertaking (or otherwise at the source of the supply) and the middle wire of common return conductor of a 3 wire D. C. or single phase A.C. system.
- (12) **Semi enclosed machine:** One in which the ventilating openings in the frame are covered with -
 - (a) Grids expanded metal or wire gauge, with openings of less than 1/4 inch so as to obstruct free ventilation.
 - (b) Wire gauge, in which the opening are less than 1/4 inch but not less than 3/32 inch (diameter or width) :
 - (c) Screens with smaller openings than the above.
- (13) **Totally - enclosed Machine:** One in which the enclosing case and bearings are dust proof and which does not allow circulation of air between the inside and outside of the case.
- (14) **Pipe Ventilated Machine:** An enclosed machine in which the frame is so arranged that the ventilating air may be conveyed to it through a pipe attached to the frame, the ventilation opening maintained by the fanning action produced by the machine - itself.
- (15) **Forced draught Machine:** An enclosed machine in which the ventilating air supply is maintained by an independent fan external to the machine itself.
- (16) **Protected Machine:** One having end shield bearings and in which there is free access to the interior without opening doors or removing covers.

SWITCHES AND CIRCUIT BREAKERS

(See clause II of Specifications)

(17) Switches and Circuit Breakers :

Switches and circuit breakers (rules 2b.36 and 37) whether fixed separately or combined with lamps, holders or fittings, must comply with the following requirements :

- (a) Overt heading must not take place at the point of contact or elsewhere, when the full current flows continuously.
- (b) They must be so constructed or arranged that the contacts cannot accidentally close when left open.
- (c) The basis must be of incombustible, non-conducting and moisture proof material.
- (d) Circuit breaker must be so arranged and placed that no combustible material is endangered by their action.

- (e) Unless placed in an engine room or in a compartment especially arranged for the purpose, they must have their live parts covered. The covers must be of incombustible material and must be either non-conduction or of rigid metal and clear of all internal mechanism. For more than 6 amperes, at pressures exceeding 125 Volts metal covers must be lined with insulating material.
- (f) In positions where they are liable to injury or come into contact with goods, they must be further protected by an open fronted box or other suitable guard.
- (g) Handles must be insulated and so arranged that the hand cannot touch live metal, or be injured through and adjacent fuse blowing.
- (h) Switches having a handle projecting through an open slot in the cover, must not be used.

Signature of Contractor

EXECUTIVE ENGINEER
BUILDING DEPARTMENT
BHAVNAGAR MUNICIPAL CORPORATION,
BHAVNAGAR

GENERAL REQUIREMENTS

1.1 **Scope of works :**

The work covered by electrical specification consists supplying and installing, electrical wiring system complete in strict accordance with this specification and the applicable drawing and subject to the terms and conditions of the contract. It includes -

- (a) Conduit and wiring system for fans, lighting points, clocks, sockets, etc., including fixing of lighting fixtures and fans etc., **and miscellaneous points.**
- (b) Conduit and wiring system for **exhaust fans sockets etc.**
- (c) Panel boards, distribution boards.
- (d) Complete power and lighting
- (e) Grounding system.
- (f) Conduits system.
- (g) Street lighting system
- (h) Other miscellaneous electrical

1.2 **Completeness of Contract:**

Any work fittings accessories or apparatus which may not have been specifically mentioned in the specification but which are necessary in the equipment for efficient working of the plant should be deemed to be included in the contract and should be executed and provided by the Contractors. All plant and apparatus should be complete in all the details, whether such details, are mentioned in the specifications or not.

Three prints and one permanent negative of each of the finally approved drawings incorporating all the modifications proposed by the Department should be submitted. No modifications should be made in a drawing already approved by the Engineer-in-charge without his prior consent.

Approval of the Contractor's drawing will not relieve the Contractor of any part of his obligation to meet all the requirements of the contract.

1.3 **Guarantee :**

The performance of all the equipment's and the installations should be guaranteed at least for a minimum period of one year from the date of taking over the installation by the Department. All equipments must comply with the relevant IS-BS specifications.

1.4 **Interchangeability:**

All corresponding parts of similar plant and equipment should be interchangeable in every way.

1.5 **Tools:**

All special tools required for dismantling and assembly of the equipment covered by the contract shall be supplied as obligation under the contract.

A list of items to be supplied by the Contractor should be submitted along with the tender.

SECTION F-2A

Specifications for Electrical Installation in Buildings

1 GENERAL :

1.1 These specifications relate to the electrical installations in the buildings of P.W.D. Electrical. The specifications cover general requirements to be fulfilled. These general specifications are supplemented by the specifications for the particular buildings separately attached.

1.2 These specifications are governed by the General conditions of the contract attached hereto.

1.3 APPLICABLE RULES AND REGULATIONS :

1.3.1 Installation shall be carried out in conformity with the regulations for electrical equipments of buildings, published by the institute of Electrical Engineers London (14th Edition 1966 and as amended up to date) hereinafter referred to as the I.E.E. wiring regulations. Where these specifications or the special specifications for the particular building attached hereto are at variance with the I.E.E. regulations these specifications or special specifications as the case may be, shall be followed. The installation shall also comply with the requirements of the Indian Electricity Act. 1910 as amended up to date and rules issued there under and also the regulations for the electrical equipments of buildings issued by the Bombay Regional Council of Engineer Association of India. Where not specified otherwise, the installation should generally follow the Indian standard codes of practice and in their absence the relevant British Standard of practices. All the materials shall comply with the relevant Indian Standard or British Standard specifications.

1.4 DEFINITIONS :

1.4.1 The definitions of terms in the I.E.E. Regulations shall apply in general.

1.5 DRAWINGS:

1.5.1 The preliminary drawings only indicate the general scheme of requirement. The exact position of all points, control switch boxes, runs of wiring and/or conduits joint boxes, inspection boxes, mains, and sub-distribution boards, mains etc., shall be got approved by the Engineer-in-charge. All circuits shall be clearly numbered in wiring diagrams and building plans. The detailed design of a switch-board, special fixture or any other part of the electrical installation as may be called for by the engineer-in-charge shall also be supplied by the Contractor and should be got approved by the Engineer-in-charge. Three sets of completion drawings and wiring diagrams showing the installations as executed shall be supplied by the Contractor along with the completion certificate.

1.6 MATERIALS :

All Materials shall be new and of the best quality conforming to the relevant I.S.B.S. specifications. They must be the products of reliable manufacturers of many years of standings. All like parts of materials shall be interchangeable. In case of equipments such as circuit breakers, switch fuses etc., a descriptive and illustrated literature shall accompany the tender. The names of manufacturers of various materials shall be furnished in proforma in Appendix-I Sample of materials wherever required should be approved by the application of suitable paints. The supply of all equipments, switchgears etc. shall be complete with accessories, fittings and mountings as may be required for their proper performance, and as specified in the relevant IS-BS Code of Practice and Standards.

1.7 WORKMANSHIP :

1.7.1 Good workmanship and neat finished appearance are the prerequisites for complying with the clauses of these specifications. With a view to ensure fine workmanship the tenderers shall employ licensed wiremen with an experience of not less than 5 years in the type of work they are engaged. The work should be done under supervision of licensed Electrical Supervisors with good educational qualifications and considerable experience.

1.7.2 Tenderers shall furnish the names of Supervision and their wiremen who will be engaged in this work with details of their experience.

1.8 CO-OPERATION WITH CIVIL AND OTHER WORKS CONTRACTORS :

1.8.1 The tenderer, after the award of the contract, shall co-operate with the civil and other Contractors and shall co-ordinate his work with the work of other Contractors with the least amount of dislocation and in reference to the other works. Tenderers shall go through the drawings carefully and shall furnish the Engineer-in-charge with all the details of openings in the walls etc. they may be required for concealing any of the electrical equipments or accessories. Where the Contractor fails to furnish such information as may be required for the purpose of concealing the equipments etc., they shall be made at his (Contractor) cost and expense. Any alteration to parts of the building shall be carried out with prior permission of the competent authority. All chases of the structural work shall be made good at the contractor's expense and brought to the original shape finish and colour.

1.9 TESTING :

The electrical Contractor shall be completely responsible for the testing and commissioning of those installations covered by these specifications in compliance with the standard procedure, in obtaining permission of the Government Electrical Inspector. Any modification which is demanded by Government Electrical Inspector shall have to be carried out within the scope of the contract. The contractor shall submit four copies of drawings of installations as per regulations for shall be provided by the Contractor for carrying out the installation work. All tests shall be carried out in the presence of the Engineer-in-charge or his authorized representative and his approval obtained for the test results.

1.10 COMPLETION CERTIFICATE AND MAINTENANCE GUARANTEE :

1.10.1 After the completion of the installation and testing, the Contractor should furnish a certificate in the proforma in Appendix-III, at the time of taking over the installation by the Department. The installation shall be guaranteed for period of 12 months from the date of taking over by the Department. During the period of guarantee all defects in material or in workmanship shall be rectified or replaced free of cost to the Department.

1.11 TENDERER'S ABILITY :

1.11.1 In order to enable the Department to assess the ability of the tenderer to execute the work, the tenderer shall furnish evidence of his experience and capacity to carry out the work of the magnitude and nature.

1.12 RATES :

1.12.1 The rates of items shall include all taxes, transport, loading and unloading charge and all such charges that may be required to be incurred for the supply and installation of the materials at site. The rates shall be firm and variations in the market are not entertained. Break up figures as required in the schedule of work shall also be furnished. As far as possible indigenous materials only shall be included for supply. Where it is unavoidable, imported items may be included and tenderer should clearly indicate materials, quantity, rate and amount of these items.

1.13 STORAGE SPACE :

No covered storage space will be provided by the Department. The Contractor has to make his own arrangement. However, the Department may give an open space near the place of execution where the Contractor can build his own stores for executing the work.

1.14 DEPARTURE FROM SPECIFICATIONS :

The tenderer should clearly indicate departure, if any, from the specifications with reasons for the same.

1.15 EXTRA ITEMS :

Rates for extra items shall generally be derived from the rates already available in the schedule. Where it is not possible, the rates shall be mutually agreed upon and the Contractor shall furnish a detailed analysis of the rates claimed by him.

2. TECHNICAL SPECIFICATIONS :

2.1 Supply System :

The wiring installations shall be suitable for 3 phase 4 wire, 400-400 v 50 cycles system of supply. Colour code of different phase shall be followed as per standard.

2.2 Wiring for Lights and Fans :

2.2.1 Looping system of wiring shall be adopted. No joints shall be made at intermediate runs of cables and where they are unavoidable, such joints shall be through approved mechanical connections.

2.2.2 Point Wiring :

Point wiring shall consist of the branch wiring from the switch board together with the controlling switch or push as far as and including the ceiling rose or any other approved connector or socket, outlets. In case of more than one light being controlled by one switch the wiring upto the ceiling rose of the first light including the switch shall be considered as primary, point, Loop wiring from light shall be considered as a 'Secondary' point and rates shall be quoted separately, including final connections to fixtures and plugs.

2.2.3 Conductors :

No conductor for final sub circuit wiring for light and socket outlets shall have a cross section less than that of 2.5 sq. m (aluminium).

2.2.4 Loading :

No final sub-circuit radiating from the fuse board of a sub-distribution board and wires with 25 sq. m. (At.) cable shall carry more than 10 lights, fans or socket outlets or a connected load of 800 watts whichever is greater. The following wattages may be assumed for estimating the load on each sub-circuit unless otherwise known or specified.

Incandescent Lamps	100	watts
Ceiling fans	60	watts
5-A Socket Outlets (lighting)	100	watts
4. ft. fluorescent tube	50	watts
5. ft. fluorescent tubes	100	watts

In each sub-distribution board at least one way preferably two ways shall be left spare for future requirement. A wiring diagram giving the details of the exact utilization of the ways shall be prepared and fixed in the sub-distribution board itself or any other easily accessible place. The ways of sub-distribution board shall accordingly numbered.

2.2.5 Local Control Switches (General) :

Local control switches for circuit carrying not less than 5-A shall be piano type and shall conform to relevant I.S. Standards. The switch shall be 'ON' when the knob is in the down position. All local control switches shall be connected in the phase or live conductor only and not in the neutral conductor, switch box is 1.3 mtr. from the finished floor level

unless otherwise stated. All switch boxes shall be provided with 1/8" thick Perspex cover fixed to the switch box with chromium plated counter sunk screws (brass).

2.2.5A Switches (Two way) :

- (a) Two way switches shall be piano type single pole, double throw, 250V, suitable for flush mounting and of 5A capacity as per the drawings. All switches shall be recessed in an embedded metal box.
- (b) Each box shall have suitable outlet for fixing conduits directly.
- (c) Each box shall have Perspex cover painted inside with the wall colour, if required.
- (d) Each switch shall be suitable for the position in a corridor stairway wiring.

2.2.5.B Switch Boxes (General) :

Electrical circuits shall be written suitably on the cover of all switch boxes, as approved by the Engineer-in-charge (Elect). Whenever different phase are terminated in a switch box bakelite partition shall be provided. Each case shall be provided with a G. I. Earth stud nut and washers for earth connectors.

2.2.6 Ceiling Rose :

Ceiling rose shall be used on circuits having a voltage normally exceeding 200V. Only one flexible cord shall be attached to a ceiling rose. Only 3-pin 5A socket outlet shall be provided in lighting circuits. All socket outlets shall be provided with control switch and they shall be mounted in switch boxes in an approved manner.

2.2.7 Fittings :

These shall be of approved type as specified in the tender schedule. The sub circuits leads should terminate in a ceiling rose or conductor in the fitting and internal connection made there from. Wherever these fitting are suspended they shall be done so through the conduits and ball and socket joints. All fittings shall be grounded by a G. I. conductor not less than 16 S. W. G.

2.2.8 Flexible wiring :

Flexible cords of not less than 23/0076 size shall be used. The weight of suspension shall be governed by I.E.E. Regulations.

2.2.9 Ceiling Fans :

All ceiling fans shall be wired to ceiling rose and suspended from a hook shackle or clamp and insulated from the same. All joints in the suspension rod shall be screwed and secured by means of split pins. The fan clamps supplied by the Contractor shall be suitable for the ceiling or roof member as the case may be. For concrete roofs, fan hooks shall be buried in concrete during construction in an approved manner and securely bound to the reinforcement.

2.2.10 Conduits and Earthing :

All conduits feeding lighting and fan circuits shall be provided with earth continuity G.I. conductor as specified for power wiring. All conduits shall be as specified for power wiring.

2.3.1 Point wiring :

Point wiring for power shall be as defined under section 2.2.2 and shall include the switches and sockets.

2.3.2 Loading :

All distribution board for power wiring shall be not less than 15A per way. Loading per way shall not exceed normally 100 watts. The following loads may be assumed if exact figures are not known :

3-Pin 15A Outlets	1000	Watts
3-Pin 5A	Outlets	100 Watts

2.3.3 Wiring for Motors :

2.3.3.1 Final sub-circuits loop in motors shall be connected to separate ways of the Distribution board even if the current in the sub-circuit is less than 15A. No looping is permissible.

2.3.3.2 All wiring shall be carried in H. G. conduit as specified in I. S. specification for gauge for different sizes of conduits. When the motor is resiliently mounted flexible conduit with approved adapters shall be used for the last few feet. Where cables are used sufficient loop shall be left.

2.3.3.3 All switch fuse units controlling circuits feeding motor shall be provided with H.R.C. fuses or as specified.

2.3.3.4 The frame of every motor and its association control gear shall be earthed by two separate and distinct connections to earth. Connector shall be capable of carrying 3 times the rating of fuse or 1.1/2 time the setting of the circuit breakers but in no case less than No. 8 S.W.G. or 7064 or equivalent cross section of copper. Where practicable, the earth connection shall be visible for periodical inspection. Gas or water pipes shall not be used for earth connections.

2.3.3.5 Socket Outlets and Control Switches 5A and 15A :

All socket outlets shall be of 3 pin type, the third pin being connected to the earth stud of nearest distribution board by separate earthing wire. The socket shall conform to I. S. : 1293/1938. single pole, piano type. Each socket outlets shall be provided with a control switch of appropriate rating and as specified. The switch and socket shall be mounted inside the iron clad box provided with 1/8" perspex cover as directed by the Engineer-in-charge or as specified in schedule of quantities. Inside switch box ample space shall be available around switches for connecting wires to switches. All socket outlets for power shall be mounted at the skirting level unless otherwise specified or as directed by the Engineer-in-charge.

The three phase plug receptacles shall have their earth terminals connected by independent earth wires to ring main earth strips on the building. In building where explosion proof fixtures are installed single phase plug receptacles as well as light points shall be connected to ring main ground bus installed in the building by separate earth wires of approved size.

Socket outlet shall have some provision not to receive the matching plug unless the grounding pin is in correct position. The grounding pin of the plug shall make the contact first and break the contact last at the time of inserting or removing the plug respectively.

The grounding terminal shall be connected to the enclosed metal body by providing G.I. stud. nut washers welded to the box

Each unit shall be suitable for flush mounting as required and indicated in the applicable drawings.

Combination unit of socket outlet and switch shall be complete with necessary internal wiring. The switch/socket shall be mounted on M. S. bracket enclosed in a box.

2.4 Conduit Wiring :

2.4.1 Where conduit wiring is adopted the type and size of the conduit shall be as indicated in the drawing. The minimum of the conduit shall be 19 mm.

2.4.2 The Contractor shall thoroughly study the structural arrangements of the buildings and wherever necessary, shall in consultation with Department's representatives at site, make suitable adjustments in the cable routings, earthing arrangements, and location boxes, fitting etc. with a view to avoid interference with any part of the building, structure, equipment or any other work in the building or to effect any improvement in the arrangement.

2.4.3 Protection of conduit against rust :

Conduit shall be given two coats of oxide paint before they are placed in position. All exposed conduit shall be painted after installation with the colour as approved by the Engineer-in-charge. This does not apply to galvanized conduit.

2.4.3.A Protection against insects and damp :

In order to minimize condensation or sweating inside the conduit, system shall be properly drained and ventilated in such a manner as to prevent the entry of insects.

2.4.4 Conduit shall first be installed as a complete system without cables and shall be continuous from outlet to outlet from fitting to fitting and mechanically and electrically connected to all boxes and fittings.

2.5 SPECIFICATION FOR POWER CONTROL AND TELEPHONE CABLES :

1. SCOPE :

- i. The specifications cover the supply and installation of medium voltage power and control cables either in ground or trench depending on the conditions at site including accessories for the same. The work in general, consists of supplying, laying terminating and connecting all. 1.1 KV APLSTS PVC power and control cables.
- ii. The Contractor shall supply all accessories including jointing and terminating materials, compound, tapes supporting materials, cleats cables lugs, concrete stabs, bricks sand, cables markers etc., as required to make the installation work including digging and back filling of the trenches as required.

II. SPECIFICATIONS :

- i. All power cables to be supplied mentioned as 'APLSTS' in the Schedule should be mass impregnated non-draining, paper insulated lead sheathed, double steel tape armoured and must comply with the latest IS BS specifications.
- ii. All cabling materials such as cable compound, cable lugs, tapes shall be of approved quality acceptable to the type recommended by the manufacturer of the cable for which it is used and approved by the Department.
- iii. Installation of all equipment shall also conform to the applicable Codes and practice as per the IS and shall be executed to comply with the latest Indian Electricity rules as regards the surety, earthing of equipments and other essential provision specified therein.
- iv. Only approved make of cable be used. ICC and CCI will be preferred.
- v. The cables shall generally be laid as per IS Code of Practice.

III. GENERAL RULES FOR CABLE LAYING :

- i. Installation shall be carried out in a neat, workmen like manner by skilled experienced and competent workmen in accordance with the standard practices.
- ii. Cables shall be laid preferably in one piece length to avoid joints. If straight joint are found necessary, these can be introduced with prior approval of the Engineer-in-charge. The cost of the straight joint however, shall not be borne by the Department. But in no case joint shall be within the conduit G.I. pipe and duct.
- iii. proper care should be exercised in handling the cable to avoid formation of kink etc. and should it become necessary a cable be bent to a radius not less than 20 times the overall diameter of the cable.
- iv. Method of installation, routing of cable etc., shall in every case be subject to the Department's approval and the Contractor shall modify and or certify at no extra cost to the Department any portions of the installation which do not meet with the Department's approval. All damages to the civil or other works on this account shall be made good by the Contractor at no extra cost to the Department.
The electrical Contractor while notifying the building Contractor for such work shall furnish the proper drawings, fully explaining the work involved or indicate at site actual work to be carried out as may be required by the building Contractor. The electrical Contractor shall also notify the building contractor in wiring, for finishing up as required, of any such work as soon as the electrical work with respect to the same has been completed.
- v. Where cables pass through Hume pipes, Contractor shall fix hard wood bushed round the cables at the ends of Hume pipes. Where the cables pass through the floors or chambers and in such other situations as the Engineer shall require, the Contractor shall seal cable holes in a manner approved by Engineer-in-charge. Where cables pass through roads nallahs, etc., cables must be protected by Class 'A' Hume pipe of diameter not less than 6" (15 cm)
- vi. The cable route shall be the shortest and there shall be minimum interference with built up areas, lawns etc.
- vii. Care shall be exercised for providing suitable props for supporting other service lines on earth at the time of excavation. Where cutting of a lawn become inevitable it should be with the approval of the Engineer-in-charge.
- viii. Excavation of the trenches shall be executed with vertical sides and the trenches shall be kept as straight as possible. The exact location of each trench shall be settled by the Engineer-in-charge on the site when the contractor is in a position to commence each portion of the work.

The trench shall be not less than 1/2 meter wide and 90 cms deep. If more cables are to be laid, the width should be suitably increased.

- ix. After the cables are laid, the trench shall be filled in layers, the earth in each layer being well rammed by spraying water and consolidated and sufficient allowance made for settlement. The extra earth over the trench should be removed from the place of trench to a place as decided by the Engineer-in-charge at site.
- x. Ends of cables shall be properly sealed to prevent entry of moisture prior to installation.
- xi. Where it is as specified as 1/2 core in multicore cables, the 1/2 core shall be a neutral conductor having reduced section.
- xii. For all multicore cables each core and tails shall be brought out, marked and or coloured in an approved manner.
- xiii. Cables termination shall be done with suitable compression brass glands in the case of PVC cables and cast iron trifurcating boxes in the case APLSTS cables. The armour should be connected to the right main earth in building with duplicate earth wires as per the relevant IS/BS specifications.
The core isolation over each conductor shall however be retained throughout the run of the conductor up to the end where lugs shall be fitted thereon for connections. The lugs shall be fitted by means of approved solder and flux as a lead, and Eyre No. 7 liberally used.
The joint shall be mechanically strong and pressure tested.

2.6 DISTRIBUTION BOARDS AND PANELS :

General Requirements :

- 2.6.1 All distribution panels shall comply with I.E.E. Rules 60-61. A clear distance of 0.91m meter in front of the switch board shall be kept. Where bare connections or attachments are provided at the back of the switch board the space behind the panel shall be either less than 0.299 meter or more than 0.762 main width. There shall be a passage way from the further outstanding part of any attachment or conductor. If the space behind the switch board exceeds 0.76 main width there shall be a passage way from either end of the switch board clear to height of 1.928 m width 0.299 m. All wiring connection shall be made neatly and securely.
- 2.6.2 For circuits carrying more than 10 Amps. tinned cable sockets shall be used. All connections shall be so made as to form their own diagram. Circuit shall be clearly numbered to correspond to wiring diagram. Names of the distribution boards shall be painted as directed by the Engineer-in-charge. All the switch fuse units and isolators D.Bs. shall be complete with earthing lugs neutral bar link. H.R.C. fuses and of approved make.
- 2.6.3 Skeleton type panels shall have rigid framework adequately braced and supported. The switch and distribution boards shall be neatly arranged in the frame. The details of the framework and the arrangement of switches shall be got approved by the Engineer-in-charge before the panel is fabricated.
- 2.6.4 All cubical type panels shall have rigid supporting frames adequately braced over which sheet metal shall be neatly secured. All switches, distribution boards etc. shall be neatly arranged on the panels and all connections made from the back of switches. The panels shall be rendered dust and vermin-proof. The interior of the panels shall not be accessible to unauthorized persons.
- 2.6.5 The recess type boards shall be embedded in wall in a cupboard with a metal hinged door with locking arrangement. In all recessed conduit work in distribution boards shall be recessed. Where recessing is not possible, free standing panel may be provided as approved by the Engineer-in-charge.
- 2.6.6 All individual components i.e. switch fuse units D. Bs. etc. shall be connected by earth continuity wire of appropriate size with the main earth bus of the panel D. B. etc. The panel switches or D.Bs. shall be earthed by not less than 2 distinctive paths to earth. Earthing of metallic parts of exposed metal shall not be effected through any structural metal work which houses the installation. Where metallic parts are not required to be earthed and are liable to become alive should the installation of the contractor become defective such metallic parts shall be separated by durable non-conducting material from any structural work.
 - (a) power panels shall be 3 phase, 4 wire, 400/230 volts for the distribution of 3 phase or single phase power loads. Lighting panels shall be 3 phase, 4 wire 400 230 volts for single phase lighting load distribution on all 3 phase.
 - (b) All panels shall be done or protected front type with no mechanical or electrical defects.
 - (c) Bus bars shall be of electrolytic copper or aluminium as specified and the properly tinned sizes as indicated on applicable drawings as required.
 - (d) All knockouts for branch circuits, conduit entries shall be drilled in and files as required. For lighting panels the top and bottom cover plates shall be removable type.
 - (e) Main disconnects device for all panel boards shall be of switches of disconnect type and of the size as indicated. It shall be mounted directly below the panel or through a short thread conduit of required size.
 - (f) The main disconnect for all panel boards shall have an entry suitable for PVC armoured cable from bottom.
 - (g) All panel boards shall be provided with an earthing terminal and plug for connection to the grounding system.
 - (h) Temperature rise of all electrical parts shall not be more than 300⁰ C with full load measured at room temperature.
 - (i) Buses shall be securely supported so that ordinary vibrations will not cause any of the parts to become loose.
 - (j) All barriers and supports of current carrying parts shall be of moisture resistant insulating material and shall not be adversely affected by arcing.

- (k) The locations of panels shown in the drawings are only tentative. Panels may be located at place approved by the Engineer-in-charge.
- (l) All civil works connected with fixing such as grouting chasing and making good shall be the tenderer's responsibility.
- (m) Wires adequate capacity with proper size of lugs shall be used for interconnections.
- (n) Panel should be self-supported on angle channel iron framework. It should be preferably of bolted construction in case of transportation and flexibility. The frame shall be of the required size for the mounting of the equipment on it. It shall be bolted or grouted rigidly after levelling and alignment.
- (o) The cupboard and D. B. should be of such size so as to be accommodated in the existing room as per I. S. rules and I. S. codes of practice for installations of medium voltage switchgear.
- (p) Fabrication drawing showing the detailed dimensions and panels and its components indicating the frame work earthing positioning of switches, D. Bs. cable boxes, adopter chambers etc. shall be furnished to the Engineer-in-charge. Panel should be guaranteed for satisfactory operations for a period of one year after handing over.
- (q) The panel should be painted with anticorrosive paint suitable for humid and salty atmosphere on two coats of primer.

Switch Gears, Powers Panels D. B. and S. F. Us.

2.6.8 The main bus bar shall have continuous current rating as specified with neutral bar having half of full load rating of the phase bus bar. The sizes of the bus bars shall be so selected that the current density in bar does not exceed 150 amps. per sq.mm. for copper. The length of bus-bar chamber should be as suitable length to fix all the switches etc. as per prevailing standards. Clear spacing of two adjacent buses shall be 1.1/2" Minimum bar should be taped all along with colour coated 11 KV grade PVC tape. The maximum internal support for each unsupported length shall exceed 600 mm. The bus bar shall be of copper/aluminium and fabricated to the relevant standards specification. In case aluminium bus bar is used special with high conductivity aluminium bus bar alloy E 91 C frame conforming to E. S. S. 2898 shall be used. The current density shall not exceed 800A per sq. inch. Hylam barriers will be provided over the joints to prevent any short circuit.

The bus bar enclosing shall be made out of not less than 16 gauge M. S. sheets construct on with angle iron support. All interconnections between bus bars S. F. Us. and D. Bs. shall be of adequate size and details of such interconnection shall be furnished to the Engineer-in-charge for his approval.

The bus bar shall be air insulated extensible type rectangular one. The bus bars chamber shall be dust tight by providing gaskets secured properly so as to tender it vermin proof.

The Combination Fuse-switch unit should comply with IS 4064 BS 861 and BBS 2510 wherever applicable. It should be suitable to accommodate High Reputing Capacity Cartridge Fuse links complying with IS 2208 or BS 88 and having certified returning capacity of not less than 35 MVA at 440 volts (AC5 duly). The switch gear (panels D. Bs. etc.) shall be installed generally as per IS-Part I 3072 and as specified and shown in drawings.

All fuse switch units shall be provided with non-deteriorating HRC fuse links complying with IS 2208-1962 and having rupturing capacity of 35 MVA at 415 volts or as specified.

All switches above 60 amps. rating shall be provided with suitable size adapter boxes. All switches mounted on the top of the busbars shall be provided with detachable type reverse entry adapter boxes. Suitably engraved lables shall be provided for each circuit as well as for the board.

A meter with sector switches and LMH metre shall be provided where specifically mentioned. Small wiring for the inter-connecting shall be colour coded and provided with numbered figures for easy identification of circuits.

- (a) The distribution boards should be totally enclosed metal clad complying with B. S. 214. The M. S. sheet steel enclosures for recessed D. Bs. shall be of not less than 14 gauge.
- (b) The D. B. shall be with hinged door and the locking arrangements as approved by the Engineer-in-charge.
- (c) All the components shall be enclosed in the enclosure. The mounting of D. B. shall be got approved by the Engineer-in-charge before carrying out the installation.
- (d) The D. Bs. shall have proper size cut outs for conduits entry or cable entry or cable entry as required and these shall be made on site.
- (e) Adequate spacing shall be provided inside the D. Bs. for easy removal of the fuses and carry out the interconnection.
- (f) A set of insulating barriers have to be provided between incoming breakers switches and fuses.

Switch fuse Units :

- (a) All the D.P.T.P. and T.P.N. switch fuse units shall be totally enclosed iton clad quick make, quick dreak type to best Indian make conforming to the I.S. or B.S. 3185 specifications. All the switch fuse units shall have mechanical interlock with a door so that the door cannot be opened when the switches are in 'ON' position. The switches should be of double break isolation type to ensure safely.
- (b) Each T.P. & T.P.N. switch fuse unit shall be earthed with two distinct earth connections.
- (c) Suitable insulator shall be provided between phase.
- (d) There shall be suitable natural link in the fuse box.

- (e) All T. P. & T.P.N. switch fuse units shall be rated for 500 volts and D.P. (required for single phase supply) and S.P.N. switches for 250-volts.
- (f) The H.R.C. cartridge fuse shall conform to H. S. 88 (1952).
The O.C. Bs. ACB shall be suitable for 400/440 volts 3 phase 50 cycle supply capable of interrupting a fault MVA. of not less than 31. The circuit breaker shall conform to the BSS-936-1940 BSS 3659 with such tripping arrangements as may as required under special specifications for the building. Efficient and fool-proof mechanical interlocking shall be provided for the safe operation and maintenance. The rate shall be inclusive of the first filling of oil.

2.7 Instrumentation :

The instruments and meters wherever shall be housed in special sheet steel box located between switch fuses units and bus bar chambers. The instruments etc. shall be mounted on the hinged cover with their dial flushed. All instruments shall have protective H. R. C. fuse links. All interconnections and small wiring shall be neatly dressed arranged and duly coloured for easy identification of circuits.

Meters shall be provided as required in the Schedule. Meters shall be dead head and be suitable for 400/440 volt 3 phase 4 wire 50 cycles (in balanced load) supply.

Each selector switch shall be 3 point and of minimum 250 volts grade with silver tippe contacts suitable for metering circuits. Current transformer shall be of 5VA burden and 250V grade. Every unit shall be prewired and interconnected to the system for its required indicating performance. Indicating Lamps shall have independent circuit fuse.

2.8 FIXING OF LIGHTING FIXTURES :

1. Location of fixtures their manner of fixing mounting height etc. indicated in relevant drawing. Actual location and levels shall however be arrived at site in co-ordination with other services etc. and prior approval of the Engineer-on-charge regarding the actual location, manner of fixing shall be obtained before the work is taken up in hand.
2. In all cases the Contractor shall provide necessary interconnection wiring earthing painting etc. all necessary for complete installation. The Contractor shall also test and commission the fixtures during completion of the work.
3. General arrangement of fixtures layout ins indicated in drawings. Care shall be taken to see that all light fixtures are in a row in a room or particular area, are in absolute line and plump and are symmetrically disposed with respect to finished surfaces of walls columns beams etc.
4. The inter-connections wiring from the light outlet point up to the fixture shall be carried out by means of flexible copper wire of section not less than 1.5 mm².
5. All fixtures suspended by means of conduits shall be done with all and socket joints or as per approved design.

2.9 Telephone System :

1. Empty conducting shall be done, reseed or exposed to surface along with pull boxes, junction boxes and telephone outlet boxes, in areas and location as indicated in the relevant drawing as per materials and methods as described in regard to conducting under section "Wiring in Conduits" except the G. I. pull wires of gauge not less than 20 SWG shall be kept pulled through conduits in all sections so that in future telephone wires can be pulled easily.
2. Location shown on the drawing are approximate and final location shall be decided in the field by the Engineer-in-charge.

SECTION - G SPECIFICATION FOR EARTHING

1. Installation of Earthing Plates :

All installation of earthing shall conform to Indian Electricity Rules, IS-3043 latest edition and I.E.E. The copper earth plates should be tinned before installation. The earth plates of copper 60 cm x 60 cm x 3.515 mm thick size as mentioned in the schedule should be in separate pits at least 150 cms to 300 cms. away from the building at a depth necessary to reach moist earth surface but with a minimum depth of 2.5 mtr from the finished ground level up to the top vertical dodge of earth electrode. The earth plate shall be thoroughly cleaned to remove all dirt from the surface and be tinned properly for electrical contact with the main ground. Each earth pit should be provided with 38 mm. dia. G.I. pipe 2.5 Mts. long or more depending upon the depth of pit over the vertical edge of earth plate (with top end of pipe provided with a closed to coupler). Alternative layers of salt and coke shall be provided surrounding the plate. The pits shall be filled when the plates are in position and with type approval of Engineer-in-charge.

To facilitate watering the pit, a concrete compartment should be made with funnel with mesh and cover plate as per rules provided in ISI regulations. The masonry enclosures shall be 25 cm x 25 cm (deep) with C. I. lid of 23 cm x 30 cm size. After installation, the earthing resistance of each earth plate should be measured by resistance meggar in the presence of Engineer-in-charge, three days after the completion of earthing work, and the value should conform to regulations.

Signature of
The Contractor

Signature of
EXECUTIVE ENGINEER
BUILDING DEPARTMENT
BHAVNAGAR MUNICIPAL CORPORATION
BHAVNAGAR

LIST OF APPROVED ELECTRICAL PRODUCTS

Sr. No.	Item	Make
1	P.V.C. Pipe and it's accessories	Vraj, Nihar, Precision
2	P.V.C. Wire	Finolex, R.R., Havells
3	Cables	Polycab, Avocab, RR cable
4	Switch & it's accessories	M.D.S., NW, MK "ivory", Opel
5	MCB & Switch Gear	L&T, Schneider, Seimens
6	TL Fixtures	Crompton, Bajaj, Havells
7	Ceilling Fan "Power Saver"	Crompton, Bajaj, Havells, Orient, Usha
8	Ex. Fan	Crompton, Bajaj, Havells
9	Cable Gland	HMI, Cable Grip
10	Lugs	Dowells
11	Data / Communication Cable	Finolex, R.R., Digilink
12	D.B's	L&T, Schneider, M,D.S.
13	L.E.D/C.F.L	Havells, Crompton, Bajaj, Philips

**EXECUTIVE ENGINEER
BUILDING DEPARTMENT
BHAVNAGAR MUNICIPAL CORPORATION
BHAVNAGAR**

**PROPOSED DEVELOPMENT OF FIRE STATION AND FIRE STAFF
QUARTERS , AT PRABHUDAS TALAV,
FOR
BHAVNAGAR MUNICIPAL CORPORATION,
BHAVANAGAR.**

.

**SECTION- V
LIST OF APPROVED MATERIALS**

**ARCHITECTS:
DEV DUTT PANDYA & ASSOCIATES
ARCHITECTS AND INTERIOR DESIGNERS
DM-10 BINDU NIWAS, KALVIBID,
BHAVNAGAR- 364002
PHONE: (0278) 2569070,2569080.**

**MUNICIPAL CORPORATION
BHAVNAGAR**

VENDOR LIST

(A) LIST OF APPROVED VENDORS FOR CIVIL WORKS

Sr. No.	ITEMS	Approved Brands / Quality
1	CEMENT PPC 53 Grade & SULPHATE RESISTANT CEMENT,S.R.C.	Ambuja, Hathi, Ultra Tech, Sanghi, Siddhi, Hi-bond
2	BRICKS	MBM, Arjun, PBM, 555, Kisan, ABM, TRD, Paresh, Dhara, B.R.C., Kiran, BMB, Kirit, Sonal
3	Steel TMT, CRS	TISCO, SAIL, VIZAG, Kamdhenu, NATIONAL, Electrotherm, JSW, Welspun steel, Pollad Steel, DIAMOUND TMT, M. G. Steel, Friends Steel, Crown next TMT, Briskon TMT
4	VITRIFIED TILES	Asian, Kajaria, Jonson, Varmora, Simpolo, OASIS
5	CERAMIC TILES	Asian, Kajaria, Johnson, Varmora, Simpolo, OASIS
6	GLAZED TILES	Asian, Kajaria, Johnson, Varmora, Simpolo
7	ACRYLIC PAINT	ICI, Asian, Nerolac, Burger
8	OIL BOUND DISTEMPER	ICI, Asian, Nerolac, Burger
9	EXTERIOR WEATHER PROOF EMULSION PAINT	ICI, Asian, Nerolac, Burger
10	Oil Paint	ICI, Asian, Nerolac, Burger
11	SANITARY WARE	Cera, Hindware, Parryware
12	CAST IRON PIPES AND FITTINGS.	NECO, Swayarhoo, Bengal, Oriental Castings, Electro steel Castings
13	P.V.C. PIPES AND FITTING (UPVC/CPVC)	Finolex, Supreme, Jain, Kisan, Astral, Dutron, Prince
14	CHROMIUM PLATED WATER SUPPLY FITTINGS	Jaquar, Ess Ess, Plumber ,ESSCO, Crown, Metro, Prince
15	GALVANIZED PIPE	Tata, Essco, Jaquar, Ess Ess, Plumber
16	GALVANIZED FITTINGS	'R' Brand, 'RV' Brand, Kranti
17	C.I. MANHOLE COVER	Manish, Sil, NECO
18	PLUMBING FIXTURES	Jaguar, Plumber, Essco
19	PVC WATER TANK (100% VIRGIN PVC)	SIntex, Aqua
20	ALUMINIUM SHEETS AND ACCESSORIES	Nalco, Jindal, Hindalco, Banko
21	ALUMINIUM EXTRUDED DOOR/ WINDOW SECTION	Jindal, Hindalco, Banko, Ajin India, Aldowin, Alumilite
22	ALUMINIUM HARDWARE	Rajdoot, Belu, Diamond, Glider, Ajin India, Aldowin, Alumilite
23	WATER PROOFING MATERIALS	Zycosil, Dr. Fixit, Kerakoll, Pidilite, Roff
24	DOOR CLOSER	Efficient Gadget, Everite, Hardwin, Aldowin, Ozone
25	DOOR FITTINGS	Godrej, Efficient Gadgets (E.G.) Dunex, Doorset, Suzu, Coral
26	HINGES	Suzu, Yama, E.P.P.W.
27	SCREW AND BOLTS	Nettle Folds, GKW, Stud
28	BOLTS & FASTENERS	Hilti, Fisher
29	LIFT	Top, Express, Omega, OTIS, Schander, TRIO, Aegis Elevator, Mitsubishi, Aditya, Siemens slider
30	ROOFING MATERIAL – Galvalume sheets	TATA, Essar, Jindal
31	Slag Cement	SANGHI CEMENT Sanghipuram

Sr. No.	ITEMS	Approved Brands / Quality
32	CPVC PIPES FOR AUTOMATIC SPRINKLER FIRE EXTINGUISHING SYSTEM	ASTRAL POLY TECHNIK LIMITED પાકિંગ એરિયા, બેઈઝમેન્ટ એરિયા જેવા વિસ્તારો સિવાય માત્ર કન્સીલ્ડ પાર્શીંગ માટે આ કંપનીના CPVC pipe નો ઉપયોગ fire sprinkler piping માટે કરવાની મંજૂરી આપવામાં આવે છે.
33	AAC Blocks	NXTBLOC
34	Jointing Mortar	NXTFIX Block
35	Ready Mix Plaster	NXTPLAST
36	Block joining Masonry Mortar	Unifix
37	Tile adhesive	Unifix
38	RCC bench	Sardar Pre cast
39	Rubber mould garden curbin	Sardar Pre cast
40	Rubber mould Paver block	Sardar Pre cast
41	Fencing Pole	Sardar Pre cast
42	RCC Masonry block	Sardar Pre cast
43	Pre cast wall	Sardar Pre cast

(B) LIST OF APPROVED VENDORS FOR MECHANICAL & ELECTRICAL WORKS

Sr. No.	Description	Name of Manufacturer
1	HSCF Pump	Crompton Greaves Ltd
		Kirloskar Brothers Limited (KBL)
		JASCO
		Mather & Platt Pumps Ltd.
		Jyoti Ltd.
2	Electric Motor	Lubi Industries LLP
		Bharat Bijlee Ltd.
		Jyoti Ltd.
		JSL Industries Ltd.
		Jeumont Electrical India Pvt. Ltd.
3	Electrical Panel	LHP
		Crompton Greaves Ltd
		Bhagyashree Power Control
		Dynamic Control System
		Elembica Services
		JSL Industries Ltd.
4	Kinetic Air Valve	Nutral Power Tech
		Kirloskar Brothers Limited (KBL)
		FOURESS Engineering (India) Limited.
		Durga Valves Pvt.Ltd
		Orbinox
5	Expansion Bellows	શ્રી કિશોર ઇન્જિનીયરિંગ
		Precise Engineers
6	Dewatering (Drain) Pump(Submersible/Horizontal)	KSB Pumps
		Kirloskar Brothers Limited (KBL)
		JASCO
		Crompton Greaves Ltd
		La Gajjar Machinery Pvt Ltd.
		Pullen Pumps Industries Pvt. Ltd.
7	Sluice Valves and Sluice Gate	MBH
		Kirloskar Brothers Limited (KBL)
		DURGA Valves Pvt.Ltd
		L & T Valves
		Jupiter
8	UPVC Pipe	SACHDEVA
		Supreme Industries Ltd.,Mumbai
		Dutron Polymers Ltd
		Parixit Industries Ltd., A'bad
9	HDPE Pipe	Jain Irrigation Systems Ltd., Jalgaon
		Parixit Industries Ltd., A'bad
		Jain Irrigation Systems Ltd., Jalgaon
		Dutron Polymers Ltd
		Jindal
10	C.I. Pipe	Essar Steel
		Electro Steel, Kejriwal, Oriental Castings, BIC, Jindal, Lanco Industries Ltd.,Chennai, Kesins
13	EOT Crane	Grip Engineering Pvt. Ltd., JAPS Project, Brady & Morris Engineering Co. Ltd., Techno Industries
14	Cable & Wires	KEI Industries Ltd.
		Polycab Wires Pvt. Ltd.
		Aerolex Cables Pvt. Ltd.
		Allwin Industries
		Finolex Cables
		L&T Cables
		ULTRA CAB (India) Limited
15	Transformer	Atlanta Electricals Pvt. Ltd.
		Powerlite Electricals

Sr. No.	Description	Name of Manufacturer
		Voltamp Transformers Ltd. SKP Transformers Arya Electronics
16	Components for MCC :	
	Switch	L&T, Siemens
	HRC Fuse	L&T, Siemens
	Timer	L&T, Siemens
	Relay	L&T, Siemens
	Push Button Stations	L&T, Siemens
	Indicating Lamp	L&T, Siemens
	Cable Jointing Kit	CCI, M. Seal
	MCB/DB's	MDS, Siemens, Indokupp
17	Capacitors	L&T, Crompton, Khatau Note: Capacitors shall be oil fill type
18	KWH Meter	Simco, Jaipur, GEC
19	Light Fittings: (Indoor & Outdoor Luminaries)	Philips, Crompton, Bajaj, NESSA Illumination
20	Exhaust Fans	Crompton, Bajaj,
21	Ceiling Fans	Crompton, Bajaj, Havells
22	Air Blowers	Everest Ltd. Swan Pneumatics (P) Ltd
23	Alum Dosing Pumps	Asia LMI VK Pumps Swelore
24	Pressure Gauges	General Instruments Bells Control H. Guru Marketing
25	Level Gauge / Indicator	R K Dutt Levecon S. B. Electromec
26	Clarifier Equipment	Enviro Control Associates Voltas Ltd Hindustan Dorr-Oliver Geomiller/Triveni
27	Chlorination System	Industrial Device (I) Pvt. Ltd Metito Chloroequip Pennwalt
28	Gear Box	Greaves Radicon Elecon Shanti
29	Level Switches	Level-Tech Revathi Electronics Levec
30	Refrigerator	LG, Samsung, Kelvinator
31	PVC Pipes for Fluid	Finolex, Jain Irrigation
32	PVC Conduits for Electricals	Precision, Shakti
33	Butterfly Valve	KIRLOSKAR Brothers Limited(KBL), DURGA valves Pvt Ltd, L & T valves, R&D MULTIPLE, Jupiter, श्री कृष्ण इन्वेंटरिज IVC, IVI, Audco, R & D multiple, Jupiter, Cair, Orbit Engineers
34	Check Valve (Dual Plate check Valve)	KIRLOSKAR Brothers Limited(KBL), DURGA valves Pvt Ltd, Orbinox, R&D MULTIPLE, Orbit Engineers
35	Metallic Expansion Bellow	Beloflex(B.D. Engineers), Stanfab Engineering Pvt. Ltd., D. Wren Engineering Pvt. Ltd., Sur Industries,
36	Centrifugal / Centrifugal Non Clog Pumps	Beacon Weir, KSB, Mather & Platt (Wilo), Worthington, WPIL, Xylem pumps , Grundfos Pumps Pvt. Ltd., MBH, JASCO
37	Submersible non Clog Pumps / Submersible Centrifugal Pumps	Kirlosker, KSB, ABS, ITT- Flyght, Xylem pumps, Grundfos Pumps Pvt. Ltd. , MBH, JASCO, AQUA, Jyoti, PULLEN PUMPS, Alpha, Het Pump

Sr. No.	Description	Name of Manufacturer
38	Screw Pump	Roto, Netzsch, Tushaco, Seepex
39	Metering / Dosing Pumps	Swellore, V.K. Pumps, Shapotools
40	Non Return Valves (Single / multi door) / Dual Plate Check Valves	Kirlosker, IVC, IVI, R & D multiple, Durga, Jupiter, Cair, Orbit Engineers
41	Knife Gate valves	Jash, Fouess, Vass (Dezurick), Vag, Orbinox, Orbit Engineers
42	Sluice gates / open Chanel Gates	Jash Engineering, IVC, R & D Multiple, Jupiter
43	Mechanical Fine Screens – Step (Mat) Type / Drum Type	Jash, Huber, Johnson, Savi, Italy, Apollo Screens
44	Mechanical Course bar Screen	Jash, Huber, Johnson, HDO, Triveni, Savi, Italy
45	Manual Bar Screen	Jash, Japs, HDO, Triveni, Auric
46	Grit mechanism	EIMCO – KCP, Hindustan Dorr – Oliver, Jash-Shivpad, Triveni, Voltas
47	Diffused Aeration System	EDI, OTT, Rehau
48	Air Blower	Kay, Swam, Everest, Usha Compressors, Gardner Denver
49	Agitator / mixer	Remi, Schurtek, Fibre & Fibre, Milton Roy
50	Gear Boxes	Greaves, Elecon, CPEC, PEPL, Bonfiglioli
51	Centrifuge	Humboldt, Alpha Laval, Hiller
52	HDPE Pipes	Astral, Dutron, Duraline, Narmada, RIL (PIL), Penwalt, Anjney, jain irrigation, Sangir
53	Air Compressor	Ingersoll – Rand, khosla, Kirlosker, CPE, Alpha
54	Bearing For All Equipments	SKF, FAG, Tata
55	Fasteners	Precision, Durakhanawala, Echjay, Tata, Sundaram
56	Mechanical Seals	Eagle Seals (Sealol), Durametalllic, Burgman
57	Electric Actuator	Auma ,Rotork, Emerson, Pentair
58	(1) CATEGORY III Indoor LED fittings, LED Panel light, LED down light, outdoor LED ligh (street light, LED flood light, LED Post top lantern, LED bollard) (2) Solar LED Light	NESSA ILLUMINATION TECHNOLOGIES PVT.LTD., Litsun, Nextray
59	STREET LIGHT POLES	AMBICA POLES (for octogonal poles,swage poles,street loght poles, high mast poles,decorative poles, conical poles, JETCOTECH Engineering LLP
60	Resilient Seated Slice Valve	Cair
61	Air Vale	Cair, Orbit Engineers
62	Flow Control valve	Cair
63	Altitude Control valve	Cair, Orbit Engineers
64	Pressure reducing valve	Orbit Engineers
65	Pressure relief valve	Orbit Engineers
66	Ball valve	Orbit Engineers
67	Mast pole	JETCOTECH Engineering LLP
68	Earthing material	JETCOTECH Engineering LLP
69	Hot dip galvanizing	JETCOTECH Engineering LLP
70	LED Highbay	Litsun

(C) LIST OF APPROVED VENDOR FOR INSTRUMENTATION SYSTEM

SR NO	DESCRIPTION	Name Of Manufacturer
1	Electromagnetic Flow Meter	E+H, Siemens, Abb, Fuji, Yokogawa, Krohne-Marshall, AAROHI Embedded System Pvt Ltd., Emerson, SBEM
2	Pressure Gauges	Wika, H.Guru, General Instruments Consortium Manometer (India) P. Ltd. , Baumer, Waaree
3	Pressure Switch	Danfoss , Indfoss , Switzer
4	Process Analyzers (pH, DO, Free / Residual Chlorine , BOD / COD)	E+H , Emerson , Hach , Chemitech , Polymetron, Wtw (Forbes Marshall),Yokogawa
5	Ultrasonic transmitter level / diff. level / flow	E+H, Siemens – Milltronics, Krohne, Vega
6	Hydraulic level transmitter	E+H,Siemens, ABB, Forbes- Marshall, Emerson, SBEM
7	Displacer/Float Switches	Levcon, Nivo, Toshbro, Pune Techtrol , SBEM
8	PP Float / Buoyancy switch	Pepprl + Fuchs, Baumer, Waaree, E+H , Pune Techtrol , SBEM
9	Float & Board Type Level Gauge	Levcon, Nivo, Toshbro, Pune Techtrol, SBEM
10	Electromagnetic Flow Meter	E+H, Siemens, ABB, Fuji, Yokogawa, Krohne-Marshall
11	Field Transmitter (P, DP,F, L , T)	ABB, Fuji, Yokogawa, Honeywell, Emerson
12	Pressure Gauges	Wika, H.Guru, General Instruments Consortium Manometer (India) P. Ltd., Baumer, Waaree
13	Panel Mounted Process Indicator & Flow Integrator	Masibus, Nishko, Nivam, Selectron, Radix, Yokogawa, ABB
14	Pressure Switch	Danfoss, Indfoss, Switzer
15	Programmable Logic Controllers	Rockwell (Allen Bradeley), Siemens, Schneider, Fuji, ABB, GE Fanuc
16	Control Panel Enclosure	Rittal, Enklotek, Bartakke, BCH, Eldon
17	Alarm Annunciator	Aplab Ltd., Minilec , IIC
18	Solenoid valves	Asco, Rotex, Schrader
19	Tube Fitting	Excel Hydropneumatic, Multimetal, Placka
20	Instrument Valves , Manifolds	Aptek, Anmol (Superlok), Excel Hydropneumatic, General
21	Fitting	Instrument Consortium , Multimetal, Technomatic, Placka
22	Pneum , Brass Fitting	Swagelok, Multimetal Industries, SMC, Festo
23	Control Panel Accessories / Components	
a.	Miniature Relay	Wago, Omron,Phoenix, Rockwell
b.	Indication Pilot Lamps (LED Type)	Teknic, Schneider, Siemens
c.	Push Button / Selector Switch (with NO/NC Elements)	Teknic, Schneider, Siemens
d.	DC Power Supplies (DIN Rail mounted)	Phoenix, Omron, Schneider, Rockwell
e.	Terminals	Elmex, Phoenix, Wago, Connectwell
f.	Panel Wires	Finolex , Havell's , R R Kabel
g.	Panel Illumination	Philips , Crompton , GE
24	Instrument Cables (Power , Signal , Control)	Associated Cables, Associated Flexible and Wires P.Ltd., Brooks Cables, Thermo Cables, Udey Pyro
25	Cable Glands	Ex- protecta, Braco, Sudhir, Comet, Connectwell
26	Junction Box	Ex- protecta, CEAG, Sudhir, Baliga, FCG

27	Cable Tray	M.M.Engineering, Globe, Jacinth, Equi. Reputed, JETCOTECH Engineering LLP
28	Computer System	HP-Compaq, Dell, IBM, Sony, Samsung
29	UPS	Hirel-Hitachi, Emerson, APC
30	<ol style="list-style-type: none">1. PLC (Programmable Logic Controller)2. SCADA (Supervisory Control and Data acquisition)3. VFD (Variable Frequency Drive Up to 500 KW)4. ACB (Air Circuit Breaker up to 6000A)5. MCCB (Moulded Case Circuit Breaker up to – 1600 A)6. MCB (Miniature Circuit Breaker up to – 63 A)7. ELCB (Earth Leakage Moulded Case Circuit Breaker up to 1600 A)8. Contractor up to – 800 A & OLR (Over load Relay) up to 630 A9. Multi Functional Meters10. MPCB (Motor Protection Circuit Breaker up to 32 A)	mitsubishi Electric India Private Limited, Emerald House, EL-3, J Block, M.I.D.C., Bhosari, Pune 411026

**(D) LIST OF APPROVED VENDORS FOR MATERIALS RELATED TO WATER
SUPPLY AND SEWERAGE NETWORK**

SR. NO.	ITEMS	NAME OF AGENCIES
1	A C Pressure pipe - 293 - MAZZA process	Lotus, Kirti
2	A C Pressure pipe MEGHNANI process	Lotus, Kirti, Hindustan
3	Sluice Valve	Durga, kartar, Kirloskar, Jupiter, SACHDEVA (C.I. & D.I.), શ્રી કિર્તી ઇન્જીનિયરિંગ, Cair, Orbit Engineers
4	DI Pipe	Electrotherm (I) Ltd.,Ahmedabad, Lanco Industries Ltd.,Chennai, Electrsteel, Jindal Saw Ltd.,Ahmedabad, Kesins, Welspun
5	R.C.C. PIPE (COLLAR JOINT & SOCKET SPIGOT JOINT) CLASS NP3 & NP4, & R.C.C. COLLARS	VIPUL SPUN PIPES (SIHOR & LATHIDAD,BOTAD), KATARIYA & CO. (DHASSA), OMKARESHVAR PIPES (NAVAGAAM), OMKAR PIPES (LATHIDAD, BOTAD), MARUTI PIPES (BAGODARA ,AHMEDABAD), KALATHIYA PIPES(BAGODARA ,AHMEDABAD), R. S. PIPES (BODELI), UMA HUME PIPES (KALOL, GANDHINAGAR), SIDHDHIVINAYAK (KARDEJ ,BHAVNAGAR)
6	R.C.C. MACHINEOLE FRAME & COVER, INLET FRAME COVER 10T.(600*450 MM.) , 20T.,35T., & 50T.	SONI CEMENT PRODUCT , VIPUL SPUN PIPES, KATARIYA & CO., OMKARESHVAR PIPES, OMKAR PIPES, MARUTI PIPES, KALATHIYA PIPES , R. S. PIPES, UMA HUME PIPES, SIDHDHIVINAYAK , S.K. Corporation, Laxmi Price Industries, S.J.Corporation, Sardar pre cast
7	Stone ware PipeManufacturer having BIS Certificate for ISI marking	Krishna Pipe, j.K. Pipe, Taya ceramic, Burn & co., perfect Potteries, Navroji Vakil, Kashmira
8	D.I. & C.I. FITTINGS	RG BRAND, ESSEM Engineering Industries, Bikaners Engineers works
9	CID Joints	ESSEM Engineering Industries
10	Valves & Graded Castings	ESSEM Engineering Industries
11	Pipe Fittings	ESSEM Engineering Industries,

Whenever the make of any item / component used in the construction of this project is not mentioned anywhere, the contractor shall get the same duly approved from the Architect / Employer/Executive Engineer Building Department, Bhavnagar Municipal Corporation prior its use / installation.

For any kind of material

Note:

- (A) Before starting of work contractor must get all samples/make approved from Architect/EIC before using at site.**
- (B) Consultants/EIC reserve the right to add or delete name of any manufacture as and when required.**
- (C) Consultants/EIC reserve rights to select any of the specified brands mentioned above.
- (D) In the case of discrepancy between descriptions of Bill of Quantities and / or the drawing, "Drawing" of preference shall be observed. All and above AUTHORITY/ AUTHORITY'S Architect/EIC decision shall be final.
- (E) All the works shall be executed in technically correct and in good workmanship like manner.
- (F) All the works shall be strictly executed in the manner as advised By The Architect/EIC OF BHAVNAGAR MUNICIPAL CORPORATION.**

SIGNATURE OF CONTRACTOR with seal

SPECIAL NOTES :

- The successful tenderer will have to supply the makes from above in consultation with the Client/Architect/Consultant/Engineer in charge without any extra cost.
- Tenderer should have to specify the list of makes considered in the tender while quoting the rates in the tender, in covering letter of separate letter enclosure. However, the final decision for accepting make specified by tenderer would be of client/Architect/Consultants/Engineer in charge.
- As far as possible, the successful tenderer will have to place order directly to the manufacturer OR it's authorized dealer.
- The Client/Architect/Consultants/Engineer in charge have right to check the challans of supplier.
- Make of components required to be used by contractor to complete the installation, if not mentioned any where, shall be required to GOT IT APPROVED by Client/Architect/Consultant/Engineer in charge before installation in writing manner.
- Within a week of work order, the contractor shall submit the sample of each item / component of above mentioned approved make for the approval of the Client/Architect/Consultant/Engineer in charge.

Sign & Seal of Contractor

FREQUENCY AND ACCEPTANCE CRITERIA'S FOR BUILDING MATERIALS USED FOR CONSTRUCTION

S. No.	Building Materials	Test to be carried out	Frequency of tests	Acceptance criteria	
1	Water	Chemical analysis	Once for approval of	TDS: (mg./litre) 2000	

S. No.	Building Materials	Test to be carried out	Frequency of tests	Acceptance criteria	
			source and subsequently in case of doubt.	Sulphate (as SO ₄ : (mg./litre) 400 P.H. value 6.5 to 8.5 Chloride: (mg./litre) 1000 for plain concrete, 500 for RCC work Organic matter : 2000 Inorganic Matter : 3000 Fluoride : (as F) mg/L 1.5 Magnesium : (as Mg) mg/L 100 Alkanity : (as CaCo ₃) mg/L 600	
2	Cement	(a) Consistency (b) Setting time (i) Initial (ii) Final (c) Finess by specific surface	One test for every 50 M.T. and on change of brand	(a) About 30 % (b) (i) Not less than 30 minutes (ii) Not More than 600 minutes. (c) 2250 Cm ² /g for O.P.C (d)	OR as per IS require ments.
		(d) Compressive Strength, N/mm ² not less than		IS 269-1989 Gr.33	
		i) 3 days ii) 7 days iii) 28 days		IS 8112-1983 Gr.43	
		(e) Soundness by le-chatelier		IS12269-1987 Gr.53	
3	Sand	a) Silt content b) Gradation, fineness Modulus c) Zoning tests d) Sp. Gravity e) Water absorption(%)	On test during working season. Minimum two tests. i.e. prior to Monsoon and after monsoon (Minimum one test for 150 m ³ of material used)	a) Upto 3% b) As per standard fixed under specification. Looking to the purpose of the use. For - Concrete – IS 383-1970 - Masnory Mortar – IS2116-1980 - Plaster – IS 1542-1992 c) Ordinary sand falling under zone (iv) shall not be used. d) As per IS 383 – 1970 e) As per IS 383 – 1970	
4	Kapchi and Metal (for RCC Work)	a) Specific gravity b) Absorption c) Impact value % d) Flaking Index e) Gradation percent passing of IS sieve	2 tests per season i.e. prior to and after monsoon / minimum one test for 150 m ³ of material used	a) Up to 3.00 generally b) Up to 1.5% c) Not more than 45% or as per IS 2386(part-I)-1986 d) Not more than 25% or as per IS 383-1970 e) As per IS 2386(part-I)-1986	
5	Bricks	a) Water absorption b) Efflorescence c) Compressive strength d) Dimension	One set of test every 50,000 bricks and on change of brand mark	a) Not more than 20 % b) Moderate c) Minimum range 35 Kg/Cm ² individual result may fall below upto 20% d) Length 452 to 468 cm Width 216 to 224 cm Depth 136 to 144 cm	Or require ment as per IS 1077-1992
6	Reinforcem ent	a) Ultimate tensile strength b) Yield stress (Proof stress) c) Elongation	Each set of test for each diameter of bars for every 20 M.T. or part thereof.	a) 42 Kg/mm ² for M.S. bars and 49.50 Kg/mm ² for twisted & TMT bars b) 26 Kg/mm ² for M.S. bars and 42.50 Kg/mm ² for twisted bars c) 23% of M.S. bars and 14.50% for twisted & TMT bars (CTD)	
7	C.C. Cubes		Ordinary & controlled concrete (IS 456/2000) quantity of concrete. Number in work of M ³ of sample.	Strength of cubes for different grade at 28 days. (1) Grade M100 100 Kg/cm ² (2) Grade M150 150 Kg/cm ² (3) Grade M200 200 Kg/cm ² (4) Grade M250 250 Kg/cm ² (5) Grade M300 300 Kg/cm ²	
			Quantity Cmt.	No of Samples	

S. No.	Building Materials	Test to be carried out	Frequency of tests	Acceptance criteria
			1 - 5 - 6 - 15 1 16 - 30 2 31 - 50 2 51 & above 2 One additional sample for each 50 M ³ or part thereof. (One sample consists of 3 cubes minimum)	
8	Flooring Tiles / Mosaic / Plain		One test for every 10,000 no. of tiles used and on change of brand mark	

- | | | |
|--------------------------|---------------------|---|
| a) Water Absorption | Six full size tests | a) Not more than 10 % |
| b) Transverse Strength " | " | b) 30 Kg/Cm ² |
| c) Abrasion | " | c) Average wear shall not exceed 3.5 mm wear on any individual specimen shall not excess 4 mm |
| d) Size | " | d) As per standard fixed under specification |

9	Bansi Pahadpur Stone	a) Water Absorption b) Crushing strength	2 sets of test per working seasons to i.e. prior and after monsoon.	a) Not More than 10 % b) Not less than 175 Kg/Cm ²
10	Teak Wood	a) Color b) Hardness c) Density d) Moisture e) Porosity f) Soft g) Identification	One test	As per I.S. specification
11	Seasoned & chemically treated wood	(a) Moisture content (IS 237 : 1973)		Moisture content

	Zone I	Zone II	Zone III	Zone IV
I. Doors & Windows	10	12	14	16
II. 50 mm and above in thickness	8	10	12	14
III. Thinner than 50 mm				

				Average moisture content of all the sample from a lot shall be within +3 percent. Samples with 45% of the maximum permissible moisture content for the particular and use and locality indicated above.																				
		(b) Absorption of the preservative windows (IS 401-1982)	One sample from lot.	(For zone refer Map given in IS 287 : 1973)																				
				<table border="1"> <thead> <tr> <th>Preservation</th> <th>Recommended Absorption Kg/m</th> </tr> </thead> <tbody> <tr> <td>a) CTC / LTC</td> <td>80</td> </tr> <tr> <td>b) CCA</td> <td>4</td> </tr> <tr> <td>c) RCC</td> <td>4</td> </tr> <tr> <td>d) CCE</td> <td>6.5</td> </tr> <tr> <td>e) CZC</td> <td>6.5</td> </tr> <tr> <td>f) Copper naphtenate abietate</td> <td>.4</td> </tr> <tr> <td>g) Zine naphtanate/ abitate</td> <td>0.6</td> </tr> <tr> <td>h) PCP</td> <td>5</td> </tr> <tr> <td>i) Boric Acid</td> <td>5</td> </tr> </tbody> </table>	Preservation	Recommended Absorption Kg/m	a) CTC / LTC	80	b) CCA	4	c) RCC	4	d) CCE	6.5	e) CZC	6.5	f) Copper naphtenate abietate	.4	g) Zine naphtanate/ abitate	0.6	h) PCP	5	i) Boric Acid	5
Preservation	Recommended Absorption Kg/m																							
a) CTC / LTC	80																							
b) CCA	4																							
c) RCC	4																							
d) CCE	6.5																							
e) CZC	6.5																							
f) Copper naphtenate abietate	.4																							
g) Zine naphtanate/ abitate	0.6																							
h) PCP	5																							
i) Boric Acid	5																							
12	Crushed Metal & Kapchi (for Road work)	1) Gradation 2) Flackiness 3) Impact value 4) Soundness 5) Specific garvity	1 test for 100 cu.m. 3 test for 101 to 500 cu.m. 5 test for 501 to 1500 cu.m. 7 tests for 1501 to 5000 cu.m.	1) As per IS 2386 (Part-I) – 1986 2) Not more than 15% for WBM Not more than 25% for RCC wearing surface Not more than 25% for																				

S. No.	Building Materials	Test to be carried out	Frequency of tests	Acceptance criteria	
		6) Water absorption		bituminous wearing surface 3) Not more than 35% for WBM Not more than 45% for RCC wearing surface Not more than 30% for bituminous wearing surface 4) Not more than 20% for WBM Not more than 12% for bituminous wearing surface 5) upto 3.00% 6) upto 1.5%	

Note: Tests as may be directed by Executive Engineer irrespective of provisions shown above shall have to be got conducted.

Sign & Seal of Contractor



Bhavnagar Municipal Corporation



- એજન્સી દ્વારા કામ શરૂ કરતા પહેલા સ્થળ સ્થિતિ મુજબના ફોટા ગ્રાફ રજૂ કરવાના રહેશે અને ત્યારબાદ જ કામગીરી શરૂ કરવાની રહેશે. વખતો વખત ટેન્ડર માં સમાવેશ થતી આઈટમો ની કામગીરી ના ફોટા ગ્રાફ રજૂ કરવાના રહેશે.
- આ તમામ ભાવમાં જી.એસ.ટી.નો સમાવેશ કરવામાં આવેલ નથી. સરકારશ્રીના નિયમાનુસાર અલગથી જી.એસ.ટી ચુકવવામાં આવશે. વધુમાં એજન્સીને સરકારશ્રીના નિયમનુસાર જી.એસ.ટી.નું ચુકવણું કરવાનું રહેશે.
- સ્થળે VFRPBL JLH , F. G 5; FZ Yતી હોય તો VF DF8[JLH 5|B\$XG VUJL TDFD jI J:YF Sllg8FS8Z[: JBR|SZJFGL ZCXP TDPH SM. VS:DFT S|HFGCFGL YFI TMT| VUJL TDFD HJFANEZL Sllg8FS8ZGL ZCXP
- હાલના વેન્ડર લીસ્ટ અને ભવિષ્યમાં જે તે સમયે જ્યારે ભાવનગર મહાનગરપાલિકા અને સક્ષમ સત્તા વેન્ડરમાં ફેરફાર કરશે તે અદ્યતન વેન્ડર લીસ્ટ માન્ય ગણીને કોન્ટ્રાક્ટરશ્રીએ સાઈટ પર માન્ય મટીરીયલ વપરાશમાં લેવાનું રહેશે તે બાબતે વધારાના ભાવ તફાવત ખર્ચ ચુકવવામાં નહિ આવે.
- SFD X- SZTF 5J|SFDGL IJUTMNXFJT|AMDSFD 56"YTF ; |ML Sllg8FS8Z[: JBR|, UFOL ZFBJFG|ZCXP|VgI YF SM. 56 ; DI| AM", FU|, |DF, |D GCL 50X|tI FZ|~|5I F 5 ___qV GL 5G<8L , FU|50XP
- ટેન્ડર/એજન્સીએ ટેન્ડર ડોક્યુમેન્ટ સાથે ESIC કોડ/રજીસ્ટ્રેશન ફરજિયાત રજૂ કરવાનું રહેશે, ESIC કોડ/રજીસ્ટ્રેશન સિવાયનું ટેન્ડર માન્ય ગણાશે નહીં.
- કોન્ટ્રાક્ટરશ્રીએ બાંધકામ માં OPC ૫૩ ગ્રેડ સિમેન્ટ વાપરવાની રહેશે.
- ❖ p5ZMST TDFD XZTM VDM V|JFRLL4JRFJL4; DHL4JRFZLG|8gOZDF EEFJM EZ|, K|H| DG|q VDG| SA|, DHIZ K|VG|T|DJHA VDM SFD SZJF AWF. V|KLVF

Sllg8FS8ZGL ; CL P

Sllg8FS8ZG|GFD P

Sllg8FS8ZGM I; SSM

TFZLB

રસ્તા, પુલો તથા મકાનોના બાંધકામની વિગતો તથા
સ્પેશીફિકેશન અંગેના કામના સ્થળ પર બોર્ડ મુકવા બાબત.

ગુજરાત સરકાર
જાહેર બાંધકામ વિભાગ
પરિપત્ર ક્રમાંક બીડીજી/૩૨૭૭/(૧૬૫૭)સ
સચિવાલય, ગાંધીનગર.
તા. ૨૬/૪/૧૯૭૮

પરિપત્ર:-

જાહેર બાંધકામ વિભાગ મારફત થતાં રસ્તા, પુલો તથા મકાનોના બાંધકામની વિગતો તથા સ્પેશીફિકેશનની માહિતી જાહેર જનતાને જે તે કામના સ્થળ ઉપર આ માટે મળી શકે તેથી જાહેર જનતા તે અંગે યોગ્ય સુચનો કરી શકે. તે માટે કામ સાઈટ ઉપર સરળ ભાષામાં બોર્ડ મુકવા અંગેની બાબત સરકારશ્રીની વિચારણામાં હતી. સરકારે આ અંગે યોગ્ય વિચારણા કરી ઠરાવેલ છે કે આ વિભાગ તરફથી કરવામાં આવતાં રસ્તા, પેલો તથા મકાનોના કામો માટેની નીચે જણાવ્યા મુજબની વિગતો દર્શાવતા બોર્ડ કામના સ્થળ ઉપર જાહેર જનતાની જાણ માટે મુકવા :-

જાહેર વિજ્ઞપ્તિ

આ રસ્તાનું / પુલનું મકાનનું કામ ગુજરાત રાજ્યના જાહેર
બાંધકામ વિભાગ હેઠળના વિભાગ હેઠળ
..... પેટાવિભાગ હસ્તક ચાલે છે.

આ કામના સામાન્ય સ્પેશીફિકેશન નીચે પ્રમાણે છે.

૧. રસ્તા અંગેના સ્પેશીફિકેશન :-

ઓવરસાઈઝ મેટલનું સે.મી. દર્શાવેલ જાડો થર

૨. મેટલ સે.મી. દર્શાવેલ જાડો થર.

૩. પેટીનું નામ સે.મી.નું ભરવામાં આવે છે.

(૨) પુલનું કામ :-

૧. પુલના ગાળા દરેક મીટર લંબાઈનો

૨. પીયર કેપનું કોફીટ ૧:૨:૪ ના પ્રમાણમાં.

૩. સ્લેબનું કોફીટ ૧:૨:૪ હાઈગ્રેડ કે વીલીટી કન્ટ્રોલ ૧૫૦ કે ૨૦૦ એમએમ.

૪. પુલના પાયાનો કોફીટ ૧:૩:૬ ના પ્રમાણમાં થાંભલા અને એબટમેન્ટનું કોફીટન ૧:૩:૬ ના પ્રમાણમાં.

(૩) મકાનો :-

૧. પાયાનું ક્રીકીટ પત્થરનું ૧:૩:૬ નું

૨. ઈંટોનું ચણતર અને ૧ અને ૬નું પ્રમાણ

૩. ભોંયતળીયુ ૧:૨:૩ નું ચુનાનું ક્રીકીટ કે ૧:૪:૭ સીમેન્ટનો ક્રીકીટ ઉપર ૧ ઈંચ સાઈઝની મોઝેક ટાઈલ્સ.

૪. બારી બારણા સાગી લાકડાના.

૫. આર.સી.સી.કામ ૧:૨:૪ કે ૧૫૦ એમ.કે. ૨૦૦૦ એમ.નું

આ કામની વિગતે સ્પેશીફિકેશન નાયબ ઈજનેરશ્રી પેટા વિભાગની કચેરીએ ઓફીસના સમય દરમ્યાન કોઈપણ સમયે જોઈ શકાશે.

તો માહિતી માટે તે અધિકારીનો સંપર્ક સાંધવો.

આ કામની માહિકી જાહેર જનતાની છે અને કામમાં જોઈ ક્ષતિ કે અનિયમિતતા જણાય તો તે બાબતમાં જાહેર બાંધકામ વિભાગના અધિક્ષક ઈજનેરશ્રી જેની કચેરી સ્થળે છે તેમનું ધ્યાન કરવા વિનંતી છે.

કાર્યપાલક ઈજનેર
માર્ગ અને મકાન વિભાગ

રસ્તા, પુલો તથા મકાનોના બાંધકામની વિગતો તથા
સ્પેશીફિકેશન અંગેના કામના સ્થળ પર બોર્ડ મુકવા બાબત.

ગુજરાત સરકાર
માર્ગ અને મકાન વિભાગ
ઠરાવ ક્રમાંક ટીએનસી/૧૦૯૨/૨૧/સ
સચિવાલય, ગાંધીનગર.
તા. ૧૮/૧૧/૧૯૯૧

સંદર્ભ: સરકારશ્રીની સરખા ક્રમાંકની તા. ૨૦/૧૨/૯૦ નો ઠરાવ.

આમુખ: રસ્તા, પુલો તથા મકાનોના બાંધકામની વિગતો તથા સ્પેશીફિકેશન અંગેના કામના સ્થળ પર બોર્ડ મુકવા અંગેની બાબત
સરકારશ્રીની વિચારણા હેઠળ હતી.

ઠ રા વ :-

પુખ્ત વિચારણાને અંતે આથી ઠરાવવામાં આવે છે કે, રસ્તા, પુલો મકાનો વર્કઓર્ડર મળ્યા પછી તુર્તજ કામના સ્થળે
કરવાના કામના સ્પેશીફિકેશન અંગેનું બોર્ડ કોન્ટ્રાક્ટરે પોતાના ખર્ચે મુકવાના રહેશે.

ઉપરોક્ત શરત ટેન્ડરના ભાગ તરીકે ગણવાની રહેશે અને ટેન્ડરમાં તેનો સમાવેશ કરવાનો રહેશે.

આ હુકમોનો અમલ હુકમો રવાના થયાના તારીખથી કરવાનો રહેશે.

આ હુકમો આ વિભાગના સરખા ક્રમાંકની ફાઈલ પર નાણાં સલાહકારશ્રીની તા. ૧૧/૯/૯૧ ના મળેલ સંમતિથી બહાર
પાડવામાં આવેલ છે. આ હુકમો માર્ગ અને મકાન વિભાગના બધા જ કામોને લાયુ પડશે.

ગુજરાતના રાજ્યપાલશ્રીના હુકમથી અને તેમના નામે,

(એ. જે. દોશી)
નાયબ સચિવ
માર્ગ અને મકાન વિભાગ

રસ્તા પુલો તથા મકાનો બાંધકામની વિગતો તથા સ્પેશીફીકેશન અંગેના કામના સ્થળ પર બોર્ડ મુકવા બાબત.

ગુજરાત સરકાર
માર્ગ અને મકાન વિભાગ
ઠરાવ ક્રમાંક ટીએનસી/૧૦૮૦/૨૪/સ
સચિવાલય, ગાંધીનગર.
તા. ૨૭/૧૧/૧૯૯૦

સંદર્ભ: જા.બાં.વિ.ના પરિપત્ર ક્રમાંક બીકે/૩૨૭૭/(૧૬૫)ન, તા. ૨૬/૪/૭૮

ઠ રા વ :-

રસ્તા, પુલો તથા મકાનોના બાંધકામની વિગતો તથા સ્પેશીફીકેશન અંગેના કામના સ્થળ ઉપર બોર્ડ મુકવા અંગેની સંદર્ભમાં દર્શાવેલ પરિપત્રથી જરૂરી સુચનાઓ આપવામાં આવેલ છે. આવા કામની વિગત દર્શાવતા બોર્ડ મુકવા અંગેનો ખર્ચ વિભાગ તરફથી કરવામાં આવતો હતો. કામ પુર્ણ થયા બાદ આવા બોર્ડ બીન જરૂરી પડી રહેતા હતા. આવો ખર્ચ નિવારવાની બાબત સરકારશ્રીની વિચારણામાં હતી. પુર્નવિચારણા અંગે આથી ઠરાવવામાં આવે છે કે જ્યારે રસ્તા / પુલ / મકાનનું કામ હાથ ધરવાનું નક્કી કરવામાં આવે ત્યારે આવું બોર્ડ કામ રાખનાર ઠેકેદારે તેમના ખર્ચે મુકવાનું રહેશે. કામ ચાલુ કરવાનો હુકમ આપવામાં આવે તે પહેલા આ બાબતની જરૂરી સંમતિ સંબંધીત ઈજારદાર પાસેથી લેખિતમાં મેળવી લેવી. તેમજ કોન્ટ્રાક્ટ ધ્વારા આવું બોર્ડ મુકવામાં આવે તે અંગે પુરતી કાળજી રાખવી.

આ હુકમો આ વિભાગની સરખા ક્રમાંકની ફાઈલ ઉપર નાણાંકીય સલાહકારશ્રીની તા. ૧૫/૨/૯૧ ની નોંધથી મળેલ સંમતિથી બહાર પાડવામાં આવેલ છે.

ગુજરાતના રાજ્યપાલશ્રીના હુકમથી અને તેમના નામે,

(પ્ર. ર. ચોકસી)
ખાસ ફરજ પરના અધિકારી
માર્ગ અને મકાન વિભાગ

ક્રમાંક : ૫૨૪-૬૧૦૪-૨૨૨ રેઈટ-ડીટીપી-૩૯૭૧-ન,

ગુજરાત સરકાર
માર્ગે અને મકાન વિભાગ,
બ્લોક નં. ૧૪/૨, સરદારભવન,
સચિવાલય, ગાંધીનગર
તા. ૨૯-૦૭-૨૦૦૪

પ્રતિ,
અધિક્ષક ઈજનેરશ્રી (સર્વે),
રાજ્ય વિભાગ,

વિષય :- ટેન્ડરમાં સ્ટાર રેઈટ તથા ડી.ટી.પી. મંજૂરીના માસ અને વર્ષે દર્શાવવા બાબત.

સંદર્ભ :- ઠરાવ ક્રમાંક ટીએનસી - ૧૦૮૯/૪-સી, તા. ૩૧-૦૮-૧૯૯૧.

જે ટેન્ડરમાં સીમેન્ટ / સ્ટીલ ઈજારદારે ખરીદવાનો હોય અને તેઓને આ માલસામાનના ભાવો તથા ટેન્ડરમાં દર્શાવેલ સ્ટાર રેઈટના ભાવોનો તફાવત સરભર કરી આપવાનો હોય તેવા ટેન્ડરમાં આ માલસામાનના સ્ટાર રેઈટની જોગવાઈ નીચે મુજબ કરવાની ટેન્ડરના કલોઝ પલ A માં જોગવાઈ છે.

૧. જે માસ તથા વર્ષમાં ડી.ટી.પી. મંજૂર થયા હોય તે માસ અને વર્ષે કોરા ટેન્ડર ઈસ્યુ કરતી વખતે તેમાં દર્શાવવાના રહેશે.
૨. સીમેન્ટ માટેના ભાવો જે માસમાં ડી.ટી.પી. માં મંજૂર થયું હોય તે માસના અધિકત વિક્રેતા પાસેથી મેળવી કોરા ટેન્ડર ઈસ્યુ કરતી વખતે તેમાં દર્શાવવાના રહેશે.
૩. સ્ટીલ તથા એચ.વાય.એસ.ડી.બાર માટે સેઈલ કંપની માંથી જે માસમાં ડી.ટી.પી. મંજૂર થયું હોય તે માસનો ભાવ મેળવી કોરા ટેન્ડર ઈસ્યુ કરતી વખતે તેમાં દર્શાવવાનો રહેશે.
- ૨/- એવું જણાય છે કે આ જોગવાઈનો યુક્ત પછે અમલ થતો નથી અને સ્ટાર રેઈટમાં વિવિધ વિભાગો ધ્વારા એક સુત્રતા જળવાતી નથી.
- ૩/- આથી સર્વેને આજ્ઞાનુસાર સુચના આપવામાં આવે છે કે કોરા ટેન્ડર પેપર્સ ઈસ્યુ કરતી વખતે આ જોગવાઈ મુજબના ભાવો અને ડી.ટી.પી. મંજૂર થયાનું માસ, વર્ષે અવશ્ય દર્શાવવા ટેન્ડરો મંજૂર કરવા દરખાસ્ત કરવામાં આવે ત્યારે આ દરખાસ્તમાં, દર્શાવેલ સ્ટાર રેઈટ અંગેના આધાર / પુરાવા રજૂ કરવા અને આ જોગવાઈ મુજબ જ ટેન્ડર પેપર્સમાં ભાવો દર્શાવેલ છે તે મતલબનું કા.ઈ.શ્રી.નું પ્રમાણપત્ર પણ રજૂ કરવું. વધુમાં આ સ્ટાર રેઈટ અને અંદાજી ભાવોના, ભાવ તફાવતને કારણે ટેન્ડરની અંદાજી રકમ સંબંધે ઈચા / નીચાની પરિસ્થિતિ પણ ટેન્ડર મંજૂરીની દરખાસ્તમાં અવશ્ય કરવી.
- ૪/- આ સુચનાઓનો યુક્તપછે અમલ કરવા વિનંતી છે અને આ અંગેની યુક્તની ગંભીર નોંધ લેવામાં આવશે તેની નોંધ લેવા વિનંતી છે.

(સં. મ. ભટ્ટ)
ઉપસચિવ (મકાનો)
માર્ગે અને મકાન વિભાગ.

નકલ રવાના :
સર્વે કાર્યપાલક ઈજનેરશ્રી,
રાજ્ય વિભાગ,

**રાજ્ય સરકારના બાંધકામ માટે વપરાતા ગૌણ
ખનીજની રોયલ્ટી ભરવા બાબત.**

ગુજરાત સરકાર
ઉદ્યોગ અને ખાણ વિભાગ.
ઠરાવ ક્રમાંક : એમએમઆર/૧૧૨૦૦૦/૨૦૧૩/છ
સચિવાલય, ગાંધીનગર
તારીખ :- ૧-૯-૨૦૦૪

વંચાણે લીધા :-

- (૧) ઉદ્યોગ ખાણ અને ઉર્જા વિભાગનો ઠરાવ ક્રમાંક : એમસીઆર- ૨૧૬૮-૭૩૮૦-છ તા.૧૨/૧૨/૧૯૬૯
- (૨) ઉદ્યોગ ખાણ અને ઉર્જા વિભાગનો ઠરાવ ક્રમાંક : એમસીઆર- ૨૧૬૮-૮-૬૬૮૫-છ તા.૧/૧/૧૯૮૭
- (૩) ઉદ્યોગ ખાણ અને ઉર્જા વિભાગનો ઠરાવ ક્રમાંક : એમસીઆર- ૨૧૮૮-(૮)૬૫-છ તા.૨૫/૧/૧૯૯૧
- (૪) ઉદ્યોગ અને ખાણ વિભાગનો ઠરાવ ક્રમાંક:એમસીઆર-૧૦૯૭-૨૮૫૬-છ, તા.૬/૧૧/૧૯૯૭
- (૫) માન.મુખ્યમંત્રીશ્રીના અધ્યક્ષપણા હેઠળ યોજાયેલ એમ્પ્રાવર્ડ કમીટીની તા.૧૮/૬/૨૦૦૪ ની બેઠકની કાર્યવાહી નોંધ.

ઠરાવ :-

ઉદ્યોગ, ખાણ અને ઉર્જા વિભાગના સંદર્ભ - (૩) હેઠળના ઠરાવથી એવી જોગવાઈ કરવામાં આવેલ કે રાજ્ય સરકારના , પંચાયતોના અને સરદાર સરોવર નમોદા નિગમના બાંધવામાં આવતાં રસ્તાઓના કે સિંચાઈ વગેરેના કામો માટે જ્યારે સાદી માટી (ઓર્ડીનરી ક્લે-અર્થ) અને (સોફ્ટ) મુરમ વાપરવામાં આવે ત્યારે ગુજરાત ગૌણ ખનિજ નિયમ , ૧૯૬૬ મુજબ રોયલ્ટી લેવાના નિયમો લાગુ પડશે નહીં. એટલે કે આ કામો માટે કોન્ટ્રાક્ટરો પાસે સાદી માટી (ઓર્ડીનરી ક્લે- અર્થ) અને (સોફ્ટ) મુરમ માટે રોયલ્ટી લેવાથી થશે નહીં તથા સંદર્ભ- (૪) હેઠળના વિભાગના તા.૬/૧૧/૯૭ ના ઠરાવથી ગુજરાત વિદ્યુતબોર્ડ દ્વારા હાથ ધરવામાં આવતાં કામો માટે પણ ઉપર મુજબ રોયલ્ટી મુક્તિનો લાભ આપવામાં આવેલ.

ઉપરોક્ત જોગવાઈના કારણે રાજ્યમાં ગેરકાયદેસર રીતે આ ખનીજોનો વપરાશ થતો હોવાનું જણાયેલ છે. જેના પરિણામે રાજ્ય સરકારે રોયલ્ટીની આવક ગુમાવવી પડે છે માટે ઉપરોક્ત હુકમોની જોગવાઈની સમીક્ષા કરી તે દૂર કરવાની બાબત સરકારશ્રીની વિચારણા હેઠળ હતી. તા.૧૮/૬/૨૦૦૪ ના રોજ માન.મુખ્યમંત્રીશ્રીના અધ્યક્ષપણા હેઠળ

યોજાયેલ એમ્પ્રાવર્ડ કમીટીની બેઠકમાં નક્કી થયા મુજબ સંદર્ભ-૩ તથા સંદર્ભ-૪ હેઠળના વિભાગના તા.૨૫/૧/૯૧ તથા તા.૬/૧૧/૯૭ ના ઠરાવો આથી રદ કરવામાં આવે છે.

ગુજરાતના રાજ્યપાલશ્રીના હુકમથી અને તેમના નામે.

(આર.બી.વ્યાસ)
નાય.બ સચિવ
ઉદ્યોગ અને ખાણ વિભાગ

ગુજરાત સરકાર
માર્ગ અને મકાન વિભાગ
પરિપત્ર ક્રમાંક : ટીએનસી-૧૦-૨૦૦૨-(૧૪)-સ,
સચિવાલય, ગાંધીનગર
તારીખ :- ૨૭-૪-૨૦૦૫

વિષય :- રાજ્ય સરકારના બાંધકામ માટે વપરાતા ગૌણ ખનિજની રોયલ્ટી ભરવા બાબત.
સંદર્ભ :- ઉદ્યોગ અને ખાણ વિભાગનો ઠરાવ ક્રમાંક : એમએમઆર-૧૧૨૦૦૦-૨૦૧૩-૧૭, તા.૧-૯-૨૦૦૪

પરિપત્ર :-

ઉદ્યોગ, ખાણ અને ઉજ્જૉ વિભાગના તા.૨૫-૧-૯૧ ના ઠરાવ ક્રમાંક : એમસીઆર-૨૧૮૮-(૮) -૬૫-૧૭ અન્વયે રાજ્ય સરકારના, પંચાયતના અને સરદાર સરોવર નમૅદા નિગમના બાંધવામાં આવતાં રસ્તાઓના કે સિંચાઈ વગેરેના કામો માટે જ્યારે સાદી માટી (ઓડીનરી કલે-અર્થ) અને (સોફ્ટ) મુરમ વાપરવામાં આવે ત્યારે ગુજરાત ગૌણ ખનિજ નિયમ-૧૯૬૬ મુજબ રોયલ્ટી લેવાનો નિયમ લાગુ પડશે નહીં. એટલે કે આ કામો માટે કોન્ટ્રાક્ટરો પાસે સાદી માટી (ઓડીનરી કલે -અર્થ) અને (સોફ્ટ)મુરમ માટે રોયલ્ટી લેવાની થશે નહીં તેવી જોગવાઈ કરવામાં આવેલ. હવે ઉપર સંદર્ભમાં દર્શાવેલ ઉદ્યોગ અને ખાણ વિભાગના તા.૧-૯-૨૦૦૪ ના ઠરાવથી તા. ૨૫-૧-૯૧ ના ઠરાવ રદ કરવામાં આવેલ છે.

આથી હવે બી-૧ ટેન્ડર ફોર્મ માં ખંડ - ૩૬ અને બી-૨ ટેન્ડર ફોર્મમાં ખંડ-૩૫ માં નીચે મુજબ સુધારો કરવામાં આવે છે.

રાજ્ય સરકારના બાંધકામ માટે વપરાતા ગૌણ ખનિજની રોયલ્ટી બાબત.

(૧) તા.૧-૩-૯૧ ના ઠરાવ મુજબ મુરમ સિવાયના

અન્ય સુધીના શબ્દો રદ કરી ફક્ત નીચે મુજબ જોગવાઈ અમલમાં રહેશે.

ગૌણ ખનિજ બાબતમાં રા.ગૌ.ખ.નિ.૧૯૬૬ અને તેના અનુસંધાનમાં વખતોવખત બહાર પાડવામાં આવેલ ઠરાવો લાગુ પડશે, અને તે મુજબ લીઝ કે પરમીટ લેવાનું અને રોયલ્ટી ભરવાની રહેશે.(ઉદ્યોગ અને ખાણ વિભાગ ઠરાવ ક્રમાંક એમએમઆર-૧૧-૨૦૦૦-૨૦૧૩-૧૭ તા.૧-૯-૦૪)

(અશોક પંડ્યા)
ઉપસચિવશ્રી,
માર્ગ અને મકાન વિભાગ

પ્રતિ,

સર્વે અધિક્ષક ઈજનેરશ્રી,

(મા.મ.વર્તુળો/ પંચાયત (મા.મ.)વર્તુળો/ એક્સપ્રેસ વે વર્તુળ / રાજ્ય માર્ગ યોજના વર્તુળ /
રાષ્ટ્રીય ધોરી માર્ગ વર્તુળો / પાટનગર યોજના વર્તુળ સહિત)

સર્વે કાર્યપાલક ઈજનેરશ્રીઓ (ઉપરોક્ત વર્તુળો હેઠળના તમામ વિભાગો સહિત)

નકલ રવાના :-

- ઉદ્યોગ અને ખાણ વિભાગ, સચિવાલય, ગાંધીનગર
- નમૅદા , જળસંપત્તિ , પાણી પુરવઠા અને કલ્પસર વિભાગ,સચિવાલય, ગાંધીનગર
- નિયામકશ્રી, ઈજનેરી સંશોધન સંસ્થા, વડોદરા
- નિયામકશ્રી, એન્જીનીયરીંગ સ્ટાફ કોલેજ, ગાંધીનગર
- મેનેજીંગ ડીરેક્ટરશ્રી, ગુજરાત રાજ્ય બાંધકામ નિગમ લી. ગાંધીનગર
- મેનેજીંગ ડીરેક્ટરશ્રી, ગુજરાત રાજ્ય માર્ગ વિકાસ નિગમ લી, ગાંધીનગર
- સર્વે તાંત્રિક અધિકારીશ્રીઓ (ના.કા.ઈ.સહિત) મા.મ.વિ.વિભાગ,સચિવાલય,
- સર્વે પ્રોજેક્ટ શાખાઓ, મા.મ.વિ.સચિવાલય,
- સીલેક્ટ કાઈલ.

મશીન ક્રશ્ડ સ્ટોન એગ્રીગેટના ફલેકીનેશ
અને ઈલોન્ગેશન ઈન્ડેક્સના સંયુક્ત ધોરણો
અપનાવવા બાબત.

ગુજરાત સરકાર
માર્ગ અને મકાન વિભાગ
પરિપત્ર ક્રમાંક - એસઓઆર. - ૧૦૨૦૦૬ / ૧૦૪ / સ. ૧
સચિવાલય, ગાંધીનગર.
તા. ૨૧/૧/૨૦૦૭

પ્રસ્તાવના :-

'મશીન ક્રશ્ડ સ્ટોન એગ્રીગેટ' એ બાંધકામમાં વપરાતું મુખ્ય મટીરીયલ્સ છે. આ 'મટીરીયલ્સ' માટેના ગુણવત્તાના વિવિધ ધોરણો પૈકીનો એક 'ફલેકીનેશ અને ઈલોન્ગેશન ઈન્ડેક્સ (સંયુક્ત)' છે જે મીનીસ્ટ્રી ઓફ રોડ ટ્રાન્સપોર્ટ એન્ડ હાઈવેઝ (MORT & H) દ્વારા પ્રકાશીત સ્પેશીફિકેશન ફોર રોડ એન્ડ બ્રીજ વર્કની ચોથી આવૃત્તિમાં દર્શાવ્યા અનુસાર ૩૦ % થી વધુ ન હોવો જોઈએ. જ્યારે અગાઉ મીનીસ્ટ્રી ઓફ સરકેઈસ ટ્રાન્સપોર્ટની બીજી આવૃત્તિમાં ફક્ત ફલેકીનેશ ઈન્ડેક્સનું ધોરણ વધુમાં વધુ ૩૫ % સુધીનું હતું. આમ સંશોધનો / અનુભવ તેમજ અર્થતંત્ર મશીનરીની ઉપલબ્ધીનો વ્યાપ / સરળતા તેમજ આર્થિક પાસાઓને ધ્યાને લઈને ગુણવત્તાનાં ધોરણોમાં પણ નવા સુધારા / વધારા કરવામાં આવે છે. અગાઉના ફલેકીનેશ ઈન્ડેક્સના ધોરણોમાં હવે ઈલોન્ગેશન ઈન્ડેક્સ પણ જોડી સંયુક્ત ધોરણ દાખલ કરવામાં આવેલ છે. પરંતુ હાલ ગુજરાત રાજ્યમાં આવેલ ક્રશર યુનિટો પૈકીના મોટા ભાગના યુનિટો પરંપરાગત પધ્ધતિથી કાર્યરત છે. તેમાંથી નવા સંયુક્ત ધોરણો પરિપુર્ણ કરે તેવો ઉત્પાદિત માલ મળી શકતો નથી. જે એક વ્યવહારીક મુશ્કેલી છે. પરંપરાગત પધ્ધતિનાં ક્રશરમાં આ પ્રકારની મુશ્કેલીઓ આવે છે. તે બાબતનો ઉલ્લેખ ટેકનીકલ જર્નલમાં પ્રસિધ્ધ થતા ટેકનીકલ પેપર્સમાં પણ થયેલ છે. આથી સંયુક્ત ધોરણો મેળવવા હાલના ક્રશર યુનિટોમાં સારા એવા પ્રમાણમાં સુધારા વધારા કરવા આવશ્યક બને તેમ છે. જેમાં વધારાનું નાણાંકીય રોકાણ પણ કરવું પડે તેમજ સમય પણ વ્યતિત થાય આથી ફલેકીનેશ તેમજ ઈલોન્ગેશન ઈન્ડેક્સના સંયુક્ત ધોરણોનો અમલ કરવા (ઈજારદારોને) પૂરતો સમય આપવો પણ જરૂરી છે. તે ધ્યાને લઈ નીચે મુજબની સૂચનાઓ આપવામાં આવે છે.

મીનીસ્ટ્રી ઓફ રોડ ટ્રાન્સપોર્ટ એન્ડ હાઈવે દ્વારા સ્પેશીફિકેશન ફોર રોડ એન્ડ બ્રીજ વર્કની સને ૨૦૦૧ ની ચોથી આવૃત્તિ અનુસાર મશીન ક્રશ્ડ સ્ટોન એગ્રીગેટ માટે ફલેકીનેશ તેમજ ઈલોન્ગેશન સંયુક્ત ઈન્ડેક્સની મહત્તમ ૩૦ % ની મર્યાદાનું ધોરણ અપનાવવાનું નક્કી કરવામાં આવેલ છે.

માર્ગ અને મકાન વિભાગ હસ્તક ચાલતા કામોમાં પ્રવર્તમાન સ્પેશીફિકેશન પ્રમાણે ફલેકીનેશ અને ઈલોન્ગેશનના સંયુક્ત ઈન્ડેક્સની મહત્તમ મર્યાદા ૩૦ % રાખવામાં આવે છે.

ગુજરાત રાજ્યમાં મોટા ભાગના ક્રશીંગ યુનિટો ખાનગી માલિકીના છે અને તેમાં જરૂરી યાંત્રિક ફેરફારો કરવામાં આવે તો સંયુક્ત ઈન્ડેક્સના ધારાધોરણો જળવાઈ રહે તેવાં માલ મળી શકે.

ગુજરાત રાજ્યમાં ચાલતા ખાનગી ક્રશીંગ મશીનોમાં જરૂરી યાંત્રિક સુધારા વધારા તા.૩૦/૯/૦૭ સુધીમાં કરવામાં આવે તો જ તા.૧/૧૦/૦૭ પછીથી માર્ગ અને મકાન વિભાગના રસ્તાઓમાં વપરાતા એગ્રીગેટની ગુણવત્તા ધારાધોરણ મુજબની મળી રહે. આથી નીચે મુજબની સુચનાઓ આપવામાં આવે છે.

- (અ) માર્ગ અને મકાન વિભાગમાં ચાલતા કામોના ઈજારદારોએ જે તે ક્રશીંગ યુનિટોમાં જરૂરી યાંત્રિક સુધારા વધારા થઈ ગયેલ છે અને ધારા ધોરણ મુજબની ગુણવત્તાનાં એગ્રીગેટ મળી રહે છે તેવું પ્રમાણપત્ર અધિક્ષક ઈજનેરશ્રી (યાંત્રિક) અમદાવાદ મા.મ. વર્તુળ, અમદાવાદનું હોય તેની પાસેથી જ માલસમાન ખરીદ કરવાનો રહેશે. આ પ્રમાણિત થયેલ ક્રશીંગ યુનિટ સિવાયના કોઈપણ ક્રશર પાસેથી માલસમાન સપ્લાય ન થાય તેની કાળજી લેવાની રહેશે. અધિક્ષક ઈજનેરશ્રી (યાંત્રિક) દ્વારા સર્ટીફાઈડ ન થયેલ ક્રશીંગ યુનિટ પાસેથી આવેલ ધારાધોરણ વગરનો માલસમાન આઉટરાઈટ રીજેક્ટ કરવામાં આવશે.
- (બ) માર્ગ અને મકાન વિભાગના એસ.ઓ.આર. માં તથા અંદાજોમાં એગ્રીગેટના ભાવમાં જરૂરી સુધારા વધારા કરીને તા.૧/૧૦/૦૭ થી અમલમાં લાવવાના રહેશે.
- (ક) દરેક વિભાગીય કચેરીઓએ તેઓના તાબામાં જે જે ઈજારદારોની નોંધણી થયેલ છે તેઓને સદરહુ સુચનાઓ અમલ કરવા માટે લેખિત જાણ કરવાની રહેશે તથા ખાનગી ક્રશીંગ યુનિટોને પણ આની લેખિત જાણ કરવાની રહેશે. સદરહુ સુચનાના અમલ માટે ખાનગી ક્રશર યુનિટો તેમજ ઈજારદારો સાથે દરેક વિભાગીય કચેરીએ એક સંયુક્ત બેઠક કરીને સમજ આપવાની રહેશે જેથી તા.૧/૧૦/૦૭ પછી માર્ગ અને મકાન વિભાગ હસ્તક ચાલતા કોઈપણ કામોમાં ધારા ધોરણ મુજબની ગુણવત્તા સિવાયનો માલસમાન વાપરવામાં ન આવે તેની તકેદારી રાખવાની રહેશે.

ઉપરોક્ત સુચનાઓનો અમલ યુસ્તપણે કરવાનો રહેશે.

(એસ.એ.ભટ્ટ)
ઉપસચિવ મુ.મ.
માર્ગ અને મકાન વિભાગ.

મશીન ક્રશ્ડ સ્ટોન એગ્રીગેટના ફલેક્રીનેશ
અને ઈલોન્ગેશન ઈન્ડેક્સના સંયુક્ત ધોરણો
અપનાવવા બાબત.

ગુજરાત સરકાર
માર્ગ અને મકાન વિભાગ
પરિપત્ર ક્રમાંક - આરજીએન - ૧૦૨૦૦૬ - ૧૦૪ - સ.૧,
સચિવાલય, ગાંધીનગર.
તા. ૧૭/૧૦/૨૦૦૭

સંદર્ભ :- સરખા ક્રમાંકના પરિપત્ર તા.૨૫/૧/૨૦૦૭.

પ્રસ્તાવના :-

ગુજરાત સરકારશ્રીના માર્ગ અને મકાન વિભાગ દ્વારા સંદર્ભીત પરિપત્ર ક્રમાંક : એસ.ઓ.આર. ૧૦૨૦૦૬ / ૧૦૪ / સ.૧, તા.૨૫/૧/૨૦૦૭ થી બાંધકામમાં વપરાતા મશીન ક્રશ્ડ સ્ટોન એગ્રીગેટ માટે ફલેક્રીનેશ તેમજ ઈલોન્ગેશન સંયુક્ત ઈન્ડેક્સની મહત્તમ ૩૦% મર્યાદાનું ધોરણ અપનાવવાનું નક્કી થયેલ હતું. જે માટે ગુજરાત રાજ્યમાં ચાલતા ખાનગી ક્રશીંગ યુનીટોમાં જરૂરી તાંત્રિક સુધારા વધારા તા.૩૦/૯/૨૦૦૭ સુધીમાં કરવા અને તા.૧/૧/૨૦૦૭ પછી થી માર્ગ અને મકાન વિભાગના રસ્તાઓના કામ વપરાતા એગ્રીગેટ ધારા ધોરણ મુજબની ગુણવત્તા વાળો વાપરવામાં આવે તેમ જણાવેલ હતું.

ક્રશર યુનીટોમાં જરૂરી સુધારા વધારા સુચવેલ સમયગાળામાં થઈ શકેલ ન હોવાથી વારંવાર સમય મર્યાદા વધારવા માટેની રજુઆતો થયેલ હતી.

ઉપરોક્ત બાબતે સરકારશ્રી દ્વારા પુખ્ત વિચારણાને અંતે ક્રશીંગ યુનીટોમાં જરૂરી સુધારા વધારા કરવા માટેની અંતિમ તા.૩૦/૯/૨૦૦૭ ને બદલે તા.૩૧/૧૨/૦૮ કરવામાં આવેલ છે.

ઉપરોક્ત સુચનાઓનો અમલ ચુસ્તપણે કરવાનો રહેશે.

(એસ.એ. ભટ્ટ)
ઉપસચિવશ્રી (મુ.મ.)
માર્ગ અને મકાન વિભાગ.

નકલ રવાના :-

- સચિવશ્રી (મા.મ) ના . અંગત સચિવશ્રી, મા.મ. વિભાગ, સચિવાલય, ગાંધીનગર.
- સર્વે મુખ્ય ઈજનેરશ્રીઓ અને અ.સ. શ્રીઓ, મા.મ. વિભાગ, સચિવાલય, ગાંધીનગર.
- સર્વે અધિક્ષક ઈજનેરશ્રીઓ
- સર્વે તાંત્રિક અધિકારીશ્રી, મા.મ. વિભાગ, સચિવાલય, ગાંધીનગર.
- ફાઈલ ક્રમાંક :- એસ.ઓ.આર. / ૧૦૨૦૦૬ / (૧૦૪) / સ.૧ માં રાખવા સારૂ.
- સિલેક્ટ ફાઈલ.

Instruction on implementation of
the building and other Construction
workers Act 1996
and building and other Construction
workers Welfare Cess Act, 1996.

Government of Gujarat
Labour & Employment Department
G.R. No. CWA-2004-841-M3
Sachivalaya, Gandhinagar,
Dated : 30 January 2006.

Read : Labour & Employment Department, Gandhinagar GR.No.CWA-2004-1831-M(3) Dated : 9-12-2005.

RESOLUTION

Building and other construction workers are one of the largest and most vulnerable segments of the unorganized labour. Their work is characterized by by inherent risk to life and limb of the work and also by the casual nature, temporary relationship between employer and employee, uncertain working hours, lack of basic amenities and inadequate welfare facilities.

Government of India has decided to constitute. Welfare boards for such workers in every state and accordingly, the Building and other Construction Workers (Regulation of Employment & conditions of Service) Act, 1996 was enacted by parliament and brought into force from 19th August, 1996. implementation of the Act. Including cess collection has already commenced in Karnataka, tamil nadu and dilhi. Under the side Act. Government of Gujarat has constituted a board under section 18. The stat Government has been powers to make rules for carrying out the provisions of this Act.

Accordingly, Government of Gujarat made Gujarat Building and other Construction Workers (Regulation of Employment and condition of Service) Rules, 2003 and published these Rules vide Notification No.GHR-2003-111-CWA-2000-1869-M(3), dated 18th August, 2003. Government of Gujarat has also constituted the Gujarat Building and other Construction workers Welfare Board vide Notification No. GHR/2004/163/CWA/2004/3743-M(3), dated 18th December, 2004. Secretary (Labour) has been appointed as Chairman.

Government of India has also enacted the Building and other construction workers welfare cess Act. (hereinafter called as cess Act) and brought it in force from 19th August, 1996. the cess Act provided for the levy and collection of cess on the cost of construction incurred by the employers, for increasing the resources of the welfare board. Section 3 of the Cess Act provides that cess shall be levied and collected at a rate not less than 1 % of the cost of construction incurred by an employer. Rule 5 of the Building and other construction worker welfare cess Rules, 1998 reads as fallows :-

- (1) The proceeds of the cess collected under Rule 4 shall be transferred by such Government office, public sector Undertaking, local authority. Or cess collector, to the Board along with the from of Challan prescribed (and in the head of account of the Board) under the accounting provedures of the state, by whatever name they are known.

- (2) Such Government office or public sector undertaking may deduct from the cess collected or claim from the Board, as the case may be, actual collection expenses not exceeding one per cent of the total amount collected.
- (3) The amount collected shall be transferred to the board within thirty days of its collection.

Moreover, under Rule 6, every employer, within thirty days of commencement of his work of payment of cess, as the case may be, has to furnish information in form 1 to the assessing Officer. Under Rule 12, the Assessing Officer, in cases where the employer has pay the cess or has paid less cess, can impose it penalty upto the amount of cess payable.

By Government of Gujarat Notification No. GHR/2005/04/CWA/2004/841/M3, dated 3rd January, 2005, all heads of the department of the Government of Gujarat, all Executive heads of public sector undertaking and all Executive head of local Authorities (except Gram panchayat and Nagar Panchayat) are declared as cess Collectors and Assessing Officers.

The Building and other Construction workers Welfare board has passed the necessary resolution to collect the cess with effect from 18th December, 2004.

According, the cess is payable by Government offices, public sector undertaking, local Authority or cess collector to the board in challan proscribed, in the following head / sub head :

Major Head :- 0230 – Labour and Employment

Minor Head :- 106-Fees under Contract Labour (Regulation and abolition) Rules

Sub Head :- (04)-Income from cess levied under Gujarat Building & other Construction worker's Welfare cess Act, 1996.

Approval of the Finance Department, Government of Gujarat has been taken for meeting the expenditure to be included for the various welfare activities by the Gujarat Building & other construction workers welfare board and the opening of the accounting Head / Sub –Head in file No 2004-1831-M3 on 1st December, 2005 (Copy of Resolution dated 9/12/2005 is enclosed)

All Government, public sector undertaking and local authorities are instruction to pay the above cess as per the Act. All Department Public sector Undertaking and local authorities are also advised to incorporate the 1 % cess in their estimates for all new works.

By order and in the name of Government of Gujarat.

(Vinod Babbar)
Principal Secretary Government
Labour & Employment Department

:: પરિપત્ર ::

“Demand Draft for E.M.D. & Tender fee shall be submitted in electronic format only through online (by Scanning) while uploading the bid. This submission shall mean that EMD & tender fee are received electronically. However for the purpose of realization of D.D. bidder shall send the D.D. in original through R.P.A.D. so as to reach to Executive Engineer, R&B Division, Porbandar within 7 days from the last date of uploading. Penaltrative action for not submitting D.D. in original to E.E. by bidder shall be initiated. D.D. for exemption Certificate is not necessary. However Exemption Certificate shall have to be submitted electronically through online.

Any documents in supporting of tender bid shall be submitted in electronic format only through online (by scanning etc.) & hard copy will not be accepted separately.”

“ટેન્ડર માટે બાનાની રકમ (ઈ.એમ.ડી.) તથા ટેન્ડર ફીના ડીમાન્ડ ડ્રાફ્ટ ઓન લાઈન સ્કેન કરી ઈલેક્ટ્રોનિક ફોરમેટમાં ટેન્ડર અપલોડ કરવાના રહેશે. આ પ્રકારે રજૂ થયેલ વિગતે બાનાની રકમ અને ટેન્ડર મળ.લ ગણવાની રહેશે અને તદઅનુસાર ટેન્ડર ખોલવામાં આવશે તે અનુસાર ઈલેક્ટ્રોનિક ફોરમેટમાં રજીસ્ટ્રેશન, બેંક સોલવંશી, બાનાની રકમ અને ટેન્ડર ફી મળેલ હોય તેની જ ઓફર ખોલવામાં આવશે. ખરેખર ચુકવણા માટે ટેન્ડર ભરનારે ડીમાન્ડ ડ્રાફ્ટ અસલમાં રજીસ્ટર્ડ પોસ્ટ એ.ડી. થી કાર્યપાલક ઈજનેરશ્રી, માર્ગ અને મકાન વિભાગ, પોરબંદર ને અપલોડીંગની છેલ્લી તારીખ થી દિવસ-૭ માં મળે તે અનુસાર રજૂ કરવાનો રહેશે. અસલમાં ડીમાન્ડ ડ્રાફ્ટ નહી મોકલનાર સામે શિક્ષાત્મક પગલા શરૂ કરવામાં આવશે. બાના મુકિત માટે ડીમાન્ડ ડ્રાફ્ટ જરૂરી બનશે નહિ, પરંતુ બાના મુકિત પ્રમાણપત્ર ઈલેક્ટ્રોનિકલી ઓન લાઈન રજૂ કરવાનું રહેશે.”

ટેન્ડર બીડનાં માટે જરૂરી આધાર માટેના કોઈપણ ડોક્યુમેન્ટ ઓન લાઈન ઈલેક્ટ્રોનિક ફોરમેટમાં સ્કેન કરી મોકલવાના રહેશે અને હાડ કોપી અલાયદી રીતે સ્વીકારવામાં આવશે નહિ.

ગુજરાત રાજ્યપાલશ્રીના હુકમથી અને તેમના નામે.

સહી/-
ઉપસચિવ
માર્ગ અને મકાન વિભાગ

ઇ-ટેન્ડરીંગમાં ટેન્ડર ફી અને અન્ય
ડોક્યુમેન્ટસ રજૂ કરવા અંગે.

ગુજરાત સરકાર
માર્ગ અને મકાન વિભાગ,
પરિપત્ર ક્રમાંક :- પરચ - ૧૦૨૦૦૮-૫-સ (પાર્ટફાઇલ)
સચિવાલય, ગાંધીનગર,
તા. ૨૭-૧૧-૨૦૦૮

વંચાણે લીધા :- તા. ૧૮/૧/૦૮ નો પરિપત્ર ક્રમાંક : પરચ - ૧૦૨૦૦૮-૫-સ

પરિપત્ર :-

માર્ગ અને મકાન વિભાગમાં હાલમાં ટેન્ડરો ઇ-ટેન્ડર પધ્ધતિથી સ્વીકારવામાં આવે છે. તે અન્વયે સમાન ક્રમાંકના તા. ૧૮/૧/૦૮ના પરિપત્રમાં ટેન્ડર ફી અને બાનાની રકમ જે તે કાર્યપાલક ઇજનેરને ખરેખર ચુકવવા માટે દિન-૭માં અસલમાં રજીસ્ટર્ડ પોસ્ટ એ.ડી.થી મોકલવાની તેમજ અસલમાં ડીમાન્ડ ડ્રાફ્ટ નહિ મોકલનાર સામે શિક્ષાત્મક પગલા લેવાની જોગવાઈ હતી.

ઉપરોક્ત પરિપત્રમાં નીચે મુજબ અંશતઃ સુધારો કરી આ શરતનો સમાવેશ ટેન્ડર નોટીસ / ટેન્ડરના મુસદ્દામાં Through R.P.A.D. so as to reach to E.E. Division - Within 7 days from the last date of uploading ને બદલે to S.E. at the time of tender opening or send the same through R.P.A.D. so as to reach to E.E. Division - Within 7 days from the last date of opening." સુધારો કરવામાં આવે છે. તેમજ ખરેખર ટેન્ડર ફી તેમજ બાનાની રકમ નિયત સમયમાં ઇજારદાર ન ભરે તો ઇજારદારની નોંધણી એક વર્ષ માટે એબેન્સમાં રાખવાની કાર્યવાહી કરી ઇ-ટેન્ડરીંગ નો કોડ એક વર્ષ માટે રદ કરાશે.

ગુજરાત રાજ્યપાલશ્રીના હુકમથી અને તેમના નામે.

(આર. કે. ચૌહાણ)
ખાસ ફરજ પરના અધિકારી
માર્ગ અને મકાન વિભાગ

ટેન્ડરમાં ભરેલ અસામાન્ય ઉંચા ભાવોના સંદર્ભે કામ પર પડતા ખર્ચ પર નિયંત્રણ રાખવા તથા કામની નાણાકીય પ્રગતિ ભૌતિક પ્રગતિ સાથે સુમેળમાં રહે તે માટે જરૂરી જોગવાઈ કરવા બાબત

ગુજરાત સરકાર
માર્ગ અને મકાન વિભાગ,
પરિપત્ર ક્રમાંક :- પરચ - ૧૦૨૦૦૮-(૬૧)-સ
તા. ૨૭-૧૧-૨૦૦૮

પરિપત્ર :-

ટેન્ડરમાં અસામાન્ય ઉંચા કે નીચા ભાવો ઇજારદારશ્રીઓ દ્વારા ઘણી વાર ભરાતા હોવાનું સરકારશ્રીના ધ્યાન પર આવેલ છે. આવા કિસ્સાઓમાં કામની નાણાકીય પ્રગતિ અને ભૌતિક પ્રગતિનો સુમેળ ન રહેવાની સંભાવના રહેલી છે. આથી કામની ભૌતિક પ્રગતિ પ્રમાણે નાણાકીય પ્રગતિ રહે કે જેથી સરકારશ્રી પર સમય પહેલા અયોગ્ય નાણાકીય બોજ ન પડે તે માટે નીચે મુજબની જોગવાઈ ટેન્ડરમાં કરવાનો નિર્ણય કરવામાં આવેલ છે. આ જોગવાઈ તમામ કામોના આ પરિપત્રની તારીખ પછી મંજૂર થતાં ડી.ટી.પી. માં અચૂક પણ કરવાની રહેશે.

જોગવાઈ :-

જે કોઈ આઈટમનો ભરેલ ભાવ. તે આઈટમના ટેન્ડરમાં મુકેલ અંદાજી ભાવ કરતા ટેન્ડરમાં મુકેલ અંદાજી રકમથી સમગ્ર ટેન્ડર જેટલા ટકા ઉંચુ કે નીચુ મંજૂર થયુ હોય તે ટકાવારીથી ૧૦% થી વધુ ઉંચો રહેતો હોય તેવી આઈટમનું ચકવણું રનીંગ બિલ વદતે જે તે આઈટમના અંદાજી ભાવ + / - મંજૂર ટેન્ડરની ટકાવારી + તે આઈટમના અંદાજી ભાવની ૫% ની મર્યાદામાં કરવામાં આવશે. આ રીતે વીથહેલ્ડ રાખેલ રકમ કામ સંતોષકારક રીતે પુર્ણ થયે ફાઈનલ બિલ મંજૂર કરતી વતખે વ્યાજભારણ વગર છુટી કરવામાં આવશે.

ઉદાહરણ :-

ઉક્ત જોગવાઈની સ્પષ્ટ સમજણ માટે આ સાથે આપેલ ઉદાહરણ ધ્યાને લેવું

૧	ટેન્ડરમાં મુકેલ અંદાજી રકમ	:	રૂ. ૧૦૦/-
૨	મંજૂર થયેલ ટેન્ડરની રકમ	:	રૂ. ૧૧૦/-
૩	ટેન્ડરમાં મુકેલ અંદાજી રકમ સામે ખરેખર મંજૂર થયેલ ટેન્ડરની ટકાવારી	:	૧૦%
૪	ટેન્ડરની એક આઈટમનો ટેન્ડરમાં મુકેલ અંદાજી ભાવ	:	રૂ. ૧૦/-
૫	તે આઈટમનો ભરેલ ભાવ	:	રૂ. ૧૪/-
૬	તે આઈટમમાં ભરેલ ઉંચા ભાવની ટકાવારી	:	૪૦%
૭	તે આઈટમ માટે રનીંગ બિલ વખતે ચુકવવાપાત્ર ભાવ	:	રૂ. ૧૦/- કો. ૩ પ્રમાણ ૧૦% ઉંચા અંદાજી ભાવના ૫% રૂ. ૧૧.૫૦
૮	ફાઈનલ બિલ વખતે વ્યાજ ભારણ વગર ચુકવવાપાત્ર થતો વીથહેલ્ડ રાખેલ ભાવ.	:	રૂ. ૧૪.૦૦-૧૧.૫૦ રૂ. ૨.૫૦

જો સદર આઈટમના ભાવ રૂ. ૧૨.૦૦ કે તેથી નીચો ભરેલ હોત તો રનીંગ બિલમાં ભાવ કપાત આ જોગવાઈ મુજબ કરવાની રહેત નહીં.

(આર. કે. ચૌહાણ)
ખાસ ફરજ પરના અધિકારી
માર્ગ અને મકાન વિભાગ

બાંધકામના મટીરીયલ્સ તેમજ કોમ્પોનેન્ટ્સ સેમ્પલની ગુણવત્તા માટે પરીક્ષણ પૈકીના ૮૦% પરીક્ષણ સ્થળ પર તથા ૧૦% પરીક્ષણ સરકાર માન્ય લેબોરેટરી / ગેરી ધ્વારા તથા ૧૦% ગેરી લેબોરેટરીમાં કરાવવા બાબત

ગુજરાત સરકાર
માર્ગ અને મકાન વિભાગ
પરિપત્ર ક્રમાંક : ૫૨૪/૧૦૨૦૦૭/૨૮/સ
સચિવાલય, ગાંધીનગર
તારીખ : ૩૧/૧૨/૨૦૦૮

પરિપત્ર

બાંધકામના મટીરીયલ્સ તેમજ કોમ્પોનેન્ટ્સના સેમ્પલની ગુણવત્તા માટેના પરીક્ષણ હાલ ગેરી કે સરકાર માન્ય સંસ્થા (લેબોરેટરી) મારફતે કરવામાં આવે છે. કામોની પ્રગતિની સમીક્ષા દરમ્યાન ક્ષેત્રીય અધિકારીઓ તરફથી જાણવા મળેલ છે કે ઉક્ત હયાત પ્રક્રિયામાં ટેસ્ટીંગના પરિણામો વિલંબથી મળે છે, જેમાં સમય પણ ખૂબ વ્યતિત થાય છે. ઇજારદાર એસોસિએશન તરફથી આવી રજૂઆતો મળે છે, આથી આ મુશ્કેલી ધ્યાને લેતા ઇજારદારશ્રી ધ્વારા જે તે કામ માટે સ્થાપવામાં આવતી લેબોરેટરીમાં સ્થળ પર જ પરીક્ષણ કરવામાં આવે તો વિલંબ નિવારી શકાય તે બાબત વિચારણા હેઠળ હતી, પુખ્ત વિચારણાના અંતે નીચે મુજબની નીતિ હાલના તબક્કે અનુસરવા નક્કી કરવામાં આવ્યું છે.

નીચે જણાવેલ પરીક્ષણોમાં પ્રવર્તમાન પધ્ધતિમાં ફેરફાર કરી ફીક્વન્શી અનુસાર જરૂરી પરીક્ષણો પૈકી ૧૦% સરકાર માન્ય લેબોરેટરી / ગેરી તથા ૧૦% ગેરી લેબોરેટરી અને ૮૦% ફીલ્ડ લેબોરેટરી ધ્વારા કરાવવાના રહેશે. પરંતુ ગેરીમાં નીચેના દરેક પૈકી ઓછામાં ઓછું ૧(એક) પરીક્ષણ ગેરી લેબોરેટરીમાં કરવાનું રહેશે તથા ઓછામાં ઓછું એક પરીક્ષણ ગેરી / સરકાર માન્ય લેબોરેટરીમાં કરાવવાનો રહેશે. જેમાં નીચે દર્શાવેલ પરીક્ષણો સ્થળ પર કરવાના રહે છે.

એ	એગ્રીગેટ	(૧) ગ્રેડેશન (૨) ફલેક્રીનેશ અને ઈલોગેશન વેલ્યુ (૩) ઇમ્પેક્ટ વેલ્યુ (૪) વોટર એબસોર્પશન
બી	માટી	(૧) ફિલ્ડ એફડીડી અને એફએમસી (૨) સીવ એનાલીસીસ
સી	રેતી	(૧) ગ્રેડેશન
ડી	ઇટો	(૧) ડાયમેનશન અને ટોલરન્સ ટેસ્ટ (૨) વોટર એબસોર્પશન
ઇ	કોક્રીટ	(૧) નોન ડીસ્ટ્રીક્ટીવ ટેસ્ટ (એલ્ટ્રા સોનીક ટેસ્ટીંગ પધ્ધતિથી) (૨) સ્લમ્પ ટેસ્ટ (૩) કોમ્પ્રેસીવ સ્ટ્રેન્થ
એફ	બીટયુમીનસ મીક્સ	(૧) ડામરની ટકાવારી
જી	ડ્રાય મીક્ષ મટીરીયલ	(૧) ગ્રેડેશન

શરતો :-

- (૧) ઇજારદારે કામની ગુણવત્તા માટે ધારા ધોરણ પ્રમાણેની અને ઉપર જણાવેલ પરિક્ષણો માટે પ્રમાણિત થયેલ જરૂરી તમામ સાધનો સહિતની ફિલ્ડ ટેસ્ટીંગ લેબોરેટરી સ્વ ખર્ચે કામના સ્થળે યોગ્ય જગ્યા ઉપર સ્થાપવાની રહેશે. રસ્તાના કામ માટે લાગુ પડતા પ્લાન્ટના સ્થળને કામનું સ્થળ ગણી શકાય. પરંતુ કામનું સ્થળ લેબોરેટરીથી દૂર હોય તો ઇજારદારશ્રી ધ્વારા મોબાઇલ લેબોરેટરીની જરૂરી વ્યવસ્થા રાખવાની રહેશે.
- (૨) કાર્યપાલક ઇજનેરશ્રી જ્યારે સ્થળ પર તેઓનું ચેકીંગ કરવા જાય ત્યારે ટેસ્ટીંગ તેઓએ તેમની રૂબરૂમાં પણ કરાવવાનું રહેશે.
- (૩) ધારા ધોરણ પ્રમાણેના પરીક્ષણોની સંખ્યા પૈકી ૮૦% પરીક્ષણ ફિલ્ડ લેબોરેટરીમાં ઇજારદારના અધિકૃત ક્વોલીટીકોન્ટ્રોલ ઇજનેર કે જેઓને સંબંધિત કાર્યપાલક ઇજનેરશ્રીએ આઈ-કાર્ડ આપેલ હોય તેમનાં ધ્વારા ખાતાના ના.કા.ઇ./મ.ઇ./અ.મ.ઇ.ની હાજરીમાં જ કરવાના રહેશે અને પરિણામોમાં સંયુક્ત સહીઓ કરવાની રહેશે જ્યારે ૧૦% પરિક્ષણ ગેરી/સરકાર માન્ય લેબોરેટરી (ઓછામાં ઓછું એક પરીક્ષણ) અને ૧૦% ગેરી લેબોરેટરી (ઓછામાં ઓછું એક પરીક્ષણ) મારફતે કરાવવાના રહેશે.
- (૪) કુલ પરિક્ષણોના ૮૦% પરિક્ષણ એક જ સ્થળે એકજ સમયે એકજ તબક્કામાં નહીં કરતાં કામની પ્રગતિ મુજબ જે તબક્કાએ જે તે કામગીરીને અનુરૂપ જે મટીરીયલ્સ વાપરવાનું થતું હોય તુદાનુસાર શરૂઆતના તબક્કામાં રાખવું વચ્ચેના તબક્કામાં તેમજ આખરી તબક્કામાં કરાવવાનું રહેશે. આમ છતાં આ બાબતે સ્થાનિક કક્ષાએથી ના.કા.ઇ.શ્રીએ જરૂરીયાત મુજબ તબક્કાવાર પરીક્ષણો તકકી કરવાના રહેશે.
- (૫) ગુણવત્તા નિયમન ધારા-ધોરણ પ્રમાણેના બધા જ રજીસ્ટર નિયમિત રીતે નિભાવવાના રહેશે અને તે જે તે સ્થળે લેબોરેટરીમાં ઉપલબ્ધ રહે તેમ રાખવાના રહેશે.
- (૬) જો કોઈ કારણોસર ટેસ્ટીંગના સાધન અપ્રાપ્ય હોય અથવા વસાવવામાં સમય જાય તેમ હોય કે વ્યવહારૂ ન હોય (જેમ કે ઇલેક્ટ્રોમેટ્રિક બેરીંગ) તો આવા પરીક્ષણો ગેરી/સરકાર માન્ય સંસ્થાઓમાં કરાવી શકાશે. અને આ બાબતનો નિર્ણય સંબંધિત કા.ઈ.શ્રી / ના.કા.ઇ.શ્રીએ કરવાનો રહેશે. ગેરીમાં ન થઈ શકે તેવા ટેસ્ટ સરકાર માન્ય લેબોરેટરીમાં કરાવી શકાય.
- (૭) વિભાગના ક્ષેત્રિય તાંત્રિક સ્ટાફ ના.કા.ઇ./મ.ઇ./અ.મ.ઇ.એ તેમજ ઇજારદારના તાંત્રિક સ્ટાફ ધ્વારા ગેરીમાં પરીક્ષણ જાતે કરવાનો સંતોષકારક અનુભવ મેળવી આ બાબતનું ગેરીનું પ્રમાણપત્ર પણ મેળવવાનું રહેશે. જે તે જિલ્લા/પ્રાદેશિક સ્તરે ગેરીની લેબોરેટરીમાં કોર્પ કન્ડક્ટ કરવા માટે જરૂરી ફી જે તે વિભાગના કા.ઈ.શ્રીએ ચુકવવાની રહેશે અને આ કાર્યવાહી સમયબદ્ધ પૂર્ણ થાય તે માટે સંબંધિત અ.ઈ.શ્રીએ આ કામગીરીની વખતોવખત સમીક્ષા કરવાની રહેશે.
- (૮) આ પરિપત્રથી ઉપર જણાવેલા પરીક્ષણો પૈકી ૮૦% પરીક્ષણો ક્ષેત્રિય લેબોરેટરીમાં કરવાનો સમય તા.૧/૧/૨૦૧૦ થી કરવાનો રહેશે.
- (૯) ગેરીમાં ટેસ્ટીંગ કરાવતાં સમયે ગેરીનો ટેસ્ટીંગ ચાર્જ ત્વરીત ભરવાનો રહેશે. જેથી પરીક્ષણના પરીણામો સમયસર મેળવી શકાય.

સહી/-

(આર. કે. ચૌહાણ)

ખાસ ફરજ પરના અધિકારી (વિ.યો.)

માર્ગ અને મકાન વિભાગ

ટેન્ડર ફોર્મ બી-૨ ના કોન્ટ્રાક્ટરોની
માર્ગદર્શન માટે સામાન્ય નિયમો
અને સૂચનોના સૂચન નં.૧૮ માં
સ્પષ્ટતા કરવા બાબત

ગુજરાત સરકાર
માર્ગ અને મકાન વિભાગ
ક્રમાંક:- ટીએનસી-૧૦-૨૦૧૩-(૦૨)-સી
સચિવાલય, ગાંધીનગર
તા. ૧૦-૦૫-૨૦૧૩

સંદર્ભ:- મા.મ.વિભાગના ઠરાવ ક. ટીએનસી-૧૦૯૦-(આઈબી-૨૨)-(૧૦)-સી તા.૨૪-૦૫-૧૯૯૦

આમુખ:-

ઉપરોક્ત વિષય અન્વયે ના સંદર્ભિત ઠરાવ માં સૂચન નં.૧૮ માં "આ કામ માટે
ટેન્ડરો રજીસ્ટર ટપાલ દ્વારા રવાના કરવામાં આવે ત્યારબાદ ટેન્ડર પર સ્વિકારવાની
સૂચિત તારીખથી ૯૦/૧૨૦ દિવસ સુધી ઓફર ખુલ્લી રહેશે." તેમ દર્શાવેલ છે.

હવે ઉદ્યોગ અને ખાણ વિભાગના ઠરાવ નં. એસપીઓ-૧૦૨૦૦૫-૧૪૦૭-સીએચ
તા.૨૨-૧૧-૨૦૦૬ ના સંદર્ભે કામોના ટેન્ડર Online માંગવામાં આવે છે અને ઉપરના
સૂચન નં. ૧૮ માં "ટેન્ડર પર સ્વિકારવાની સૂચિત તારીખથી ૯૦/૧૨૦ દિવસ સુધી
ઓફર ખુલ્લી રહેશે" તેવી જોગવાઈ ના કારણે ટેન્ડર ની વેલીડીટીમાં વિસંગતતા ઉભી
થવા બાબતની ગુજરાત કોન્ટ્રાક્ટર એસોસીએશન ની વિવિધ સ્તરે રજુઆતો મળેલ છે.
આ રજુઆતો પર પુખ્ત વિચારણાને અંતે આ બાબતે નીચે મુજબની સ્પષ્ટતા કરવામાં
આવે છે.

સ્પષ્ટતા

" Online Tender System માં સીગલ કવર સીસ્ટમ વાળા ટેન્ડરોમા ટેન્ડર વેલીડીટી નો
સમય ટેન્ડર ઓનલાઈન ખોલ્યા તારીખથી જ્યારે ટુ કવર બીડ સીસ્ટમમાં ટેન્ડર
વેલીડીટીનો સમય ટેકનીકલ બીડ ખોલ્યા તારીખથી ગણવાનો રહેશે."

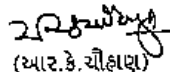
(આર.કે.ચૌહાણ)
ખાસ ફરજ પરના અધિકારી(વિ.વો.)
માર્ગ અને મકાન વિભાગ

ટેન્ડરમાં ભરેલ અસામાન્ય ઊંચા ભાવોના સંદર્ભે કાનૂનીય પગલાં પ્રત્યેક પર નિયંત્રણ રાખવા તથા કામને નાણાકીય પ્રગતિ સારી સુમેળમાં રહે તે માટે જરૂર જોગવાઈ કરવા બાબત

ગુજરાત સરકાર
માર્ગ અને મકાન વિભાગ
પરિપત્ર ક્રમાંક:- પરચ-૧૦૨૦૦૮-(૬૧)-સી
તા. ૦૩-૦૫-૨૦૧૩

વંચાણે લીધા:- પરિપત્ર ક્રમાંક:- પરચ-૧૦૨૦૦૮-(૬૧)-સી તા. ૨૭-૧૧-૨૦૦૮

સામાન્ય:-

ટેન્ડર માં ઈજારદારશ્રીઓ દ્વારા ભરાતા ભાવોના સંદર્ભે કાનૂનીય પગલાં પ્રત્યેક પર નિયંત્રણ રાખવા તથા કામને નાણાકીય પ્રગતિ સારી સુમેળમાં રહે તે માટે જરૂર જોગવાઈ કરવા બાબત

સુધારો:-

“આ રીતે વીથહેલ રાખેલ રકમ અસાધારણ નીચા ભાવ ભરેલ હોય તેવી આઈટમની નાણાકીય પ્રગતિનાં પ્રમાણસર રનીંગ બીલમાંથી છૂટી કરવાની રહેશે. જે કિસ્સામાં અસાધારણ નીચા ભાવ ભરેલ કોઈપણ આઈટમ ન હોય તેવા કિસ્સામાં અસાધારણ ભાવો ભરેલ આઈટમની સામે વીથહેલ રાખેલ રકમ બાકી રહેતી કામગીરી થાય તેના પ્રમાણસર રનીંગ બીલમાંથી છૂટી કરવાની રહેશે.”

વધુમાં વંચાણે લીધેલ પરિપત્ર ના ઉદ્દેશ્યમાં દર્શાવેલ ક્રમાંક-૮ રદ કરવામાં આવે છે.

ઉપરોક્ત સુધારાનો અમલ આ પરિપત્રની તારીખ પછી મંજૂર થતા ડી.ટી.પી. માં અચૂકપણે કરવાનો રહેશે.

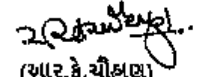

(આર.કે.ચૌહાણ)

ખાસ ફરજ પરના અધિકારી(વિ.ઓ.)
માર્ગ અને મકાન વિભાગ

પ્રતિ,

સર્વે અધિક્ષક ઈજનેરશ્રીઓ, મા.મ. વિભાગ (પાટનગર મોજના વર્તુળ, નેશનલ હાઈવે વર્તુળ, સહિત).

સર્વે અધિક્ષક ઈજનેરશ્રીઓ (પંચાયત) મા.મ. વિભાગ.

સર્વે કાર્યપાલક ઈજનેરશ્રીઓ, મા.મ. વિભાગ.

સર્વે કાર્યપાલક ઈજનેરશ્રીઓ, (પંચાયત), મા.મ. વિભાગ.

નકલ રવાના:-

૧. અગ્ર સચિવશ્રીના અંગત મદદનીશશ્રી, મા.મ. વિભાગ, સચિવાલય, ગાંધીનગર

૨. સર્વે મુખ્ય ઈજનેર અને અ.શ્રીઓ, મા.મ. વિભાગ.

૩. સર્વે તાંત્રિક ઉપ સચિવશ્રીઓ, મા.મ. વિભાગ.

૪. ના.કા.ઈ.શ્રીઓ, મા. મ. વિભાગ.

૫. નાણાં શાખા, મા.મ. વિભાગ.

૬. ના.સે.અ, સી શાખા, મા.મ. વિભાગ., સિલેક્ટ હાઈલ.

૭. શાખા સિલેક્ટ હાઈલ -૨૦૧૩

Modification in Defect Liability
Clause 17 A of Tenders for
Building works

Government of Gujarat
Roads & Buildings Department
Circular No. PRCH-102013-207/2759/N
Sachivalaya, Gandhinagar
Date :- 27-05-2013

Ref :- Circular No. PRCH-102008-(2076) – N Dt. 3-12-2009

R&B Department had issued a circular as referred above where in following provision has been made for building works.

The Defects Liability period shall be as under for original building works:

Three years of elapse of three monsoon periods following date of possession of building taken over by user agency OR Four years of elapse of four monsoon periods following the certified date of completion, Whichever is earlier.

After due considerations on the representations received at various levels from the Gujarat Contractor Associations the above clause is now modified as under

The defects Liability period shall be as under for original building works:

" One year or elapse of one monsoon period from the certified date of completion whichever is greater "

The other conditions in the above said circular will remain as it is.

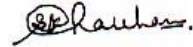

(R.K. Chauhan)

Officer on Special Duty(S.P.)

Road & Buildings Department

To,

All , Superintending Engineers, State,Ahmedabad city,Capital,Project and Panchayat Circles, R & B Department,

All,Executive Engineers under above circles.

Copy To:

1. PA to Principal Secretary(R&B), Sachivalaya, Gandhinagar.
2. All Chief Engineers & Additional Secretaries (R&B), Sachivalaya, Gandhinagar.
3. Select File.

પરફોર્મન્સ બોન્ડ તથા જામીન અનામત પેટે બેંક
ગેરેન્ટી મેળવવા બાબત

ગુજરાત સરકાર

માર્ગ અને મકાન વિભાગ

પરિપત્ર ક્રમાંક: ટી.એન.સી-૧૦-૨૦૧૩-૩૨(ભાગ-૧)-સ

સચિવાલય, ગાંધીનગર

તા.૧૯-૧૧-૨૦૧૩

વંચાણે લીધો પરિપત્ર ક્રમાંક:- ટી.એન.સી-૧૦૯૧/આઈ.બી/૧૦/૧૧/સ તા.૩૧-૩-૧૯૯૯

આમુખ:-

વંચાણે લીધેલ પરિપત્ર મુજબ હાલમાં ૧૫ લાખ કે તેથી વધુ રકમની કામો માં ઈજારદારશ્રી પાસેથી પરફોર્મન્સ બોન્ડ લેવાની જોગવાઈ છે. પરંતુ હવે મોટા ભાગના કામો ૧૫ લાખ થી વધુ રકમના હોય છે અને ચાલુ મરામતના કામો પણ હવે ૧૫ લાખ થી વધુ રકમના હોય છે. આ બાબતે કોન્ટ્રાક્ટસ ઓસોસીએશન તરફથી પણ પરફોર્મન્સ બોન્ડ માટે કામની રકમ ની મર્યાદા વધારવા માટેની રજુઆત કરવામાં આવેલ છે. આથી વહીવટી સરળતા અને અનુકૂળતા જાળવાય તે હેતુસર પરફોર્મન્સ બોન્ડ માટે કામની રકમમાં ફેરફાર કરવાનું સરકારશ્રીની વિચારણા હેઠળ હતું

પરિપત્ર:-

પુખ્ત વિચારણાને અંતે નક્કી થયેલ છે કે હવે ૩.૧૫ લાખ કે તેથી વધુ રકમને બદલે ૩.૩૦ લાખ કે તેથી વધુ રકમ ના સરકારી કામોમાં ઈજારદારશ્રી પાસેથી પરફોર્મન્સ બોન્ડ લેવાના રહેશે.

આ પરિપત્ર વિભાગની સરખા ક્રમાંકની કાંઈલ પરની નોંધ પર નાણાંવિભાગની તા.૨૨-૯-૧૩ ના રોજથી પ્રતોલ સંમતીથી બહાર પાડવામાં આવે છે.

ગુજરાત ના રાજ્યપાલશ્રીના હુકમથી અને તેમના નામે.



(આર.કે.ચૌહાણ)

ખાસ ફરજ પરના અધિકારી(ચિ.ચો.)

માર્ગ અને મકાન વિભાગ

બાંધકામના કોન્ટ્રાક્ટર પાસેથી સી.યુ.રી.ટી ડીપોઝીટ
સ્વિકારવાની પ્રથામાં અંશતઃ ફેરફાર કરવા બાબત

ગુજરાત સરકાર
માર્ગ અને મકાન વિભાગ
ઠરાવ ક્રમાંક: ટીએનસી-૧૦-૨૦૧૩-૩-(બાગ-૨)-સી
સચિવાલય, ગાંધીનગર
તા.૨૦-૧૧-૨૦૧૩

વંચાણે લીધો ઠરાવ ક્રમાંક:- ટીએનસી-૧૦૮૮/આઈબી/૧૮/(૧૩)/સ તા.૩૧-૮-૧૯૪

આમુખ:-

કોન્ટ્રાક્ટરોને આપવામાં આવતા કામો માં સીક્યુરીટી ડીપોઝીટ અંગેની હાલની પદ્ધતિ પ્રમાણે એગ્રીમેન્ટ સમયે ૫% પરફોર્મન્સ બોન્ડ બેંક ગેરંટી સ્વરૂપે, ૨.૫% સીક્યુરીટી ડીપોઝીટ નર્મદ બોન્ડ અથવા એન.એસ.એસ. સ્વરૂપે લેવામાં આવે છે તેમજ ૨.૫% રકમ ઈજારદારશ્રીના રનોંગ બીલમાંથી કપાત સ્વરૂપે વસુલ કરવામાં આવે છે. કોન્ટ્રાક્ટર્સ એસોસિએશન દ્વારા નાણાકીય તરલતા હેઠળ તે માટે ૨.૫% લેખે કાપવામાં આવતી સીક્યુરીટી ડીપોઝીટની રકમ બેંક ગેરંટી સામે છુટી કરવાની રજુઆત કરવામાં આવેલ હતી. જે બાબત વિચારણા હેઠળ હતી.

ઠરાવ:-

પુખ્ત વિચારણાને અંતે સરકારી કામોના કોન્ટ્રાક્ટ માટે સીક્યુરીટી ડીપોઝીટ સ્વિકારવાની હાલની પ્રથામાં નીચે મુજબ નો ફેરફાર કરવામાં આવે છે.

૧. હાલમાં પ્રથમ તબક્કે લેવામાં આવતી ૨.૫% સીક્યુરીટીની રકમ જે નર્મદા બોન્ડ/ એન.એસ.એસ. સ્વરૂપે લેવાની જોગવાઈ છે, તે કવે નર્મદા બોન્ડ/ એન.એસ.એસ. તેમજ શીક્વલ બેંકની એફ.ડી.આર. સ્વરૂપે પણ લઈ શકાયો.
૨. રનોંગ બીલમાંથી કપાત થતી ૨.૫% સીક્યુરીટી ડીપોઝીટની રકમ ઈજારદારશ્રી દ્વારા શીક્વલ બેંકની બેંક ગેરંટી રજુ કર્યોથી નીચે જણાવ્યા મુજબ રીલીઝ કરવાની રહેશે.

ક્રમ	નાણાકીય પ્રગતિ	રનોંગ બીલમાંથી ૨.૫% લેખે સીક્યુરીટી ડીપોઝીટ પેટે કાપવામાં આવેલ રકમ માંથી છુટી કરવા પાત્ર રકમ	બેંક ગેરંટીની રકમ
૧	ટેન્ડરની રકમના ૨૫%	રનોંગ બીલમાંથી કાપવામાં આવેલ રકમ અથવા કામની અંદાજિત કિંમતના ૦.૬૨૫%. બેમાંથી જે ઓછી રકમ હોય તે.	રીલીઝ કરવામાં આવેલ રકમ જે લી
૨	ટેન્ડરની રકમના ૫૦%	રનોંગ બીલમાંથી કાપવામાં આવેલ રકમ અથવા કામની અંદાજિત કિંમતના ૧.૨૫%, બેમાંથી જે ઓછી રકમ હોય તે.	રીલીઝ કરવામાં આવેલ રકમ જે લી
૩	ટેન્ડરની રકમના ૭૫%	રનોંગ બીલમાંથી કાપવામાં આવેલ રકમ અથવા કામની અંદાજિત કિંમતના ૧.૮૭૫%, બેમાંથી જે ઓછી રકમ હોય તે.	રીલીઝ કરવામાં આવેલ રકમ જે લી

ઉપરોક્ત બેંક ગેરંટીની મુદત કામ પુર્ણ થવાની ખરેખર તારીખથી છ(છા)માસ વધુ સમયની લેવાની રહેશે તથા ઈજારદારશ્રી પાસેથી બાંહેધરીપત્ર મેળવવાનો રહેશે કે, જે કામ પુર્ણ કરવાની સમયમર્યાદામાં વધારો થશે તો વધારેલ સમયમર્યાદાની તારીખથી ૬ માસ વધુ સમયમર્યાદા વાળી બેંક ગેરંટી નેઓશ્રી દ્વારા પુરી પાડવામાં આવશે.

કામ પુર્ણ થાય ત્યાં સુધી ઈજારદારશ્રી પાસેથી લેવાની થતી ૧૦% સીક્યુરીટી ડીપોઝીટનું પ્રમાણ કોઈપણ સ્વરૂપે જળવાઈ રહે તેની અચૂક કાળજી રાખવાની રહેશે.

આ ઠરાવ વિભાગનો સરખા ક્રમાંકની ફાઇલ પરની નોંધ પર નાણાવિભાગની તા.૬-૧૦-૧૩ ના રોજથી મળેલ સંમતીથી બહાર પાડવામાં આવે છે.

ગુજરાત ના રાજ્યપાલશ્રીના હુકમથી અને તેમના નામે.

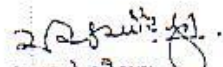
(આર.કે.ચૌહાણ)
પાસ ફરજ પરના અધિકારી(વિ.વો.)
માર્ગ અને મકાન વિભાગ

સ્પષ્ટતા કરતા જણાવવાનું કે, ટેન્ડર કલોઝ નં. પલ્એની મુળ જોગવાઈ જે પ્રથમ ત્રણ પંક્તિમાં જણાવેલ છે તેમાં સ્પષ્ટ જણાવેલ છે કે, ".....SHALL BE ADJUSTED FOR INCREASE OR DECREASE IN THE RATES OF THESE MATERIALS AS UNDER" આમ આ કલોઝની આ જોગવાઈ હેઠળ જ આગળની કાર્યવાહી તે પ્રમાણે કરવાની થાય છે.

આમ, ઉપરોક્ત બાબતે સર્વે કાર્યપાલક ઈજનેરશ્રી તેમજ એકાઉન્ટન્ટશ્રીઓનું ધ્યાન દોરવું જરૂરી છે અને આવા વસુલાતપાત્ર કિસ્સામાં વસુલાત કરવામાં આવે તે બાબતે ધ્યાન આપવા તાકીદ કરવામાં આવે છે. જો આમ કરવામાં ચુક થશે તો સંબંધિત નાયબ કાર્યપાલક ઈજનેરશ્રી, કાર્યપાલક ઈજનેરશ્રી, વિભાગીય સિસાબનીશ / અધિકારીની સીધી જવાબદારી રહેશે.

સદર બાબતે સર્વે અધિક્ષક ઈજનેરશ્રીઓને સુચના આપવામાં આવે છે કે, તેઓના હસ્તકના વિભાગોમાંથી આ પ્રકારના કામો જુદા તારવી તેમાં વસુલાત કરવામાં આવી છે કે નહીં તે બાબતે યોગ્ય ચકાસણી કરી લેવી અને જો વસુલાત કરવામાં ના આવી હોય તો તે અંગે ત્વરિત જરૂરી વસુલાત કરવા જરૂરી સુચના સંબંધિત કાર્યપાલક ઈજનેરશ્રીને આપવી.

(એન.જી. પરમાર)
ખાસ ફરજ પરના અધિકારી (વિ.યો.)
માર્ગ અને મકાન વિભાગ

S.E. RAJKOT
R & B Circle No. II

INWARD 306
DATE: 3/3

મકાનો તથા પુલોના આર.સી.સી. કામોમાં લોખંડના સળીયાના માપો લખવા તથા ચૂકવણામાં લેપ લેન્થ ની લંબાઈ ગણતરીમાં નહીં લવા બાબત

ગુજરાત સરકાર
માર્ગ અને મકાન વિભાગ
સચિવાલય, ગાંધીનગર
પરિપત્ર ક્રમાંક:- PDW-10-2017-01-C
તા.૧૫-૦૨-૨૦૧૭

પરિપત્ર:-

મકાન, રસ્તા અને પુલોના કામોમાં આર.સી.સી. આઇટમોમાં સમાવિષ્ટ સ્ટીલ રેઇનફોર્સમેન્ટના માપો લખવા અને ચૂકવણા દરમ્યાન લેપની લંબાઈ ગણતરીમાં લેવામાં આવે છે. રેઇનફોર્સમેન્ટમાં લેપની વધુ સંખ્યાને પ્રોત્સાહન ન આપતા સળંગ રેઇનફોર્સમેન્ટ (સળીયા) જ મહદઅંશે વપરાય એ તાંત્રિક રીતે વધુ યોગ્ય છે.

MORT&H સ્પેશીફિકેશનના પ્રવર્તમાન ધારાધોરણ મુજબ રેઇનફોર્સ (સળીયા)ના ચૂકવણામાં લેપની લંબાઈના માપો ગણતરીમાં લેવામાં આવતા નથી. (Section 1608)

MORT&H સ્પેશીફિકેશનના પ્રવર્તમાન ધારાધોરણ મુજબ માર્ગ અને મકાન વિભાગ હેઠળ મકાન, રસ્તા અને પુલના રેઇનફોર્સ (સળીયા)ના સ્પેશીફિકેશનમાં Mode of Measurement & Payment માં હવે પછી નીચે મુજબના ફેરફાર કરવા આથી સુચના આપવામાં આવે છે.

EXISTING ITEM	PROPOSED AMENDMENT (As per MORT&H Specification Item No.1608)
<p><u>મકાનના સ્પેશીફિકેશન</u></p> <p>5.4.10 Providing an Mild Steel reinforcement for R.C.C. work including bending binding and placing in position etc. complete up to floor two level.</p> <p>5.4.11 High yield deform bars steel reinforcement for R.C.C. work including bending, binding and placing in position complete up to floor two level.</p> <p>3.2 Reinforcement shall be measured in length including overlaps, separately for different diameters as actually used in the work. Where welding or coupling is resorted to in place lap joints, such</p>	<p><u>મકાનના સ્પેશીફિકેશન</u></p> <p>5.4.10 Providing an Mild Steel reinforcement for R.C.C. work including bending binding and placing in position etc. complete up to floor two level.</p> <p>5.4.11 High yield deform bars steel reinforcement for R.C.C. work including bending, binding and placing in position complete up to floor two level.</p> <p>3.2 Reinforcement shall be measured in length including hooks, if any, separately for differnent diameters as actually used in work, excluding overlaps. From the length so</p>

Ext. DTP ની
Incompletable
BY
E

2

<p>joints shall be measured for payment as equivalent length of overlap as per design requirement. From the length so measured, the weight of reinforcement shall be calculated in tones on the same basis of as per M-18 even though steel is supplied to the contractor by the department on actual weight. Length shall include hooks at the ends Wastage and annealed steel wire for binding shall not be measured and the cost of these items shall be deemed to be included in the rate for reinforcement.</p>	<p><i>measured, the weight of reinforcement shall be calculated in tonnes on the basis of IS: 1732. Wastage, overlaps, couplings, welded joints, spacer bars, chairs, stays, hangers and annealed steel wire or other methods for binding and placing shall not be measured and cost of these items shall be deemed to be included in the rates for reinforcement.</i></p>
<p><u>EXISTING ITEM</u></p>	<p><u>PROPOSED AMENDMENT</u> (As per MORT&H Speciafication Item No.1608)</p>
<p><u>रस्ताला स्पेशलीकेशन</u> Item No. 39 : Providing steel reinforcement. a) Providing and placing in position mild steel bar reinforcement including cutting, bending, hooking and tying complete as per details. b) High yield strength deformed bars reinforcement. (10) Reinforcement shall be measured in length seperealy for different diameters as actually used in the work, from the length so measured the weight of reinforcement shall be calculated in tones on the same basis of IS : 1732 even though steel is supplied to the contractor by the Department on actual wieghment. Length shall ilcude hooks at ends. Wastage and annealed steel wire for binding shall not be measured and cost of thes items shall be deemed to be</p>	<p><u>रस्ताला स्पेशलीकेशन</u> Item No. 39 : Providing steel reinforcement. a) Providing and placing in position mild steel bar reinforcement including cutting, bending, hooking and tying complete as per details. b) High yield strength deformed bars reinforcement. (10) Reinforcement shall be measured in length including hooks, if any, separately for differenct diameters as actually used in work, excluding overlaps. From the length so measured, the weight of reinforcement shall be calculated in tonnes on the basis of IS: 1732. Wastage, overlaps, couplings, welded joints, spacer bars, chairs, stays, hangers and annealed steel wire or</p>

3

included in the rates for reinforcement.	<i>other methods for binding and placing shall not be measured and cost of these items shall be deemed to be included in the rates for reinforcement.</i>
<p><u>પુલના સ્પેશીફિકેશન</u> Item: 21 –Providing (A) Mild Steel Reinforcement (B) High Yield Strength Deformed bars, reinforcements. (10) Reinforcement shall be measured in length including overlaps, separately for different diameter, as actually used in the work, where welding or coupling is restored to, in place of lap-joints, such joints shall be measured for payment as the equivalent length of over lap as per design requirement. From the length so measured the weight of reinforcement shall be calculated in tones on the same basis of IS 1732 even though steel is supplied to the contractor by the Department on actual weight. Length shall include hooks at ends. Wastage and annealed steel wire for binding shall not be measured and cost of these items shall be deemed to be included in the rates for reinforcement.</p>	<p><u>પુલના સ્પેશીફિકેશન</u> Item: 21 –Providing (A) Mild Steel Reinforcement (B) High Yield Strength Deformed bars, reinforcements. (10) Reinforcement shall be measured in length including hooks, if any, separately for different diameters as actually used in work, excluding overlaps. From the length so measured, the weight of reinforcement shall be calculated in tonnes on the basis of IS: 1732. Wastage, overlaps, couplings, welded joints, spacer bars, chairs, stays, hangers and annealed steel wire or other methods for binding and placing shall not be measured and cost of these items shall be deemed to be included in the rates for reinforcement.</p>

aydun
(એન. જી. પરમાર)
ખાસ ફરજ પરના અધિકારી (વિ.યો.)
માર્ગ અને મકાન વિભાગ

વિભાગીય સહાયક
અધિકારી
18/10/2018

માર્ગ અને મકાન વિભાગના કામોમાં ડીફેક્ટ
લાયેબીલીટી પીરીયડમાં ફેરફાર કરવા બાબત

ગુજરાત સરકાર
માર્ગ અને મકાન વિભાગ
ઠરાવ ક્રમાંક: ટીએનસી/૧૦/૨૦૧૬/કલોઝ-૧૭ એ/સુધારો/(૧)/સ
સરદાર ભવન, બ્લોક નં.૧૪
સચિવાલય, ગાંધીનગર
તા.૧૨/૦૫/૨૦૧૬

સંદર્ભ:- માર્ગ અને મકાન વિભાગના કામો માટે નિયત કરેલ ટેન્ડર ફોર્મ બી-૧ અને બી-૨ ના કલોઝ-૧૭ એ માંની
જોગવાઈ

આમુખ:-

ગુજરાત સરકાર માર્ગ અને મકાન વિભાગ દ્વારા હાથ ધરવામાં આવતા કામો માટે નિયત કરેલ ટેન્ડર ફોર્મ
બી-૧ અને બી-૨ નો ઉપયોગ કરવામાં આવે છે. આ કામોમાં ડીફેક્ટ લાયેબીલીટી પીરીયડ માટે નિયત કરેલ ટેન્ડર
ફોર્મ બી-૧ અને બી-૨ ના કલોઝ-૧૭ એ મુજબની કાર્યવાહી કરવામાં આવે છે. આ ડીફેક્ટ લાયેબીલીટી પીરીયડની
જોગવાઈઓમાં ફેરફાર કરવાની બાબત સરકારશ્રીની સક્રિય વિચારણા હેઠળ હતી.

ઠરાવ:-

ઉપરોક્ત બાબતે પુખ્ત વિચારણાના અંતે માર્ગ અને મકાન વિભાગના કામો માટે નિયત કરેલ ટેન્ડર ફોર્મ
બી-૧ અને બી-૨ માંના ડીફેક્ટ લાયેબીલીટી પીરીયડ અંગેના કલોઝ-૧૭ એ માંની જોગવાઈઓમાં નીચે મુજબનો
ફેરફાર કરવામાં આવે છે.

Clause	Existing Provision	Modified Provision
17 A (b)	For all works costing more than Rs.50,000/- and up to Rs.1 crore (amount put to tender), period shall be 6 months from the certified date of completion or one monsoon, whichever is later.	For all works costing more than Rs.50,000/- and up to Rs.1 crore (amount put to tender), period shall be 12 months from the certified date of completion or one monsoon, whichever is later.
17 A (c)	For major projects costing more than Rs. 1 crore , period shall be 12 months from the certified date of completion which should include one monsoon	For major projects costing more than Rs. 1 crore, (amount put to tender) , period shall be 36 months (thirty six) from the certified date of completion or three monsoons, whichever is later.

ઉપરોક્ત ઠરાવ સરખા ક્રમાંકની ફાઇલ પરની નોંધમાં માનનીય મંત્રીશ્રી (મા.મ.)ની તા.૧૦/૦૫/૨૦૧૬ના
રોજ મંજૂરી મેળવી બહાર પાડવામાં આવેલ છે. આ ઠરાવના ઇચ્છુ તારીખથી ઉપરોક્ત સુધારેલ જોગવાઈઓનો
ચુસ્તપણે અમલ કરવાનો રહેશે.

ગુજરાતના રાજ્યપાલશ્રીના હુકમથી અને તેમના નામે,

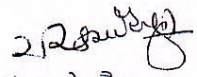
(આર.કે.ચૌહાણ)
ખાસ ફરજ પરના અધિકારી (વિ.ચો.)
માર્ગ અને મકાન વિભાગ
ગાંધીનગર

**INVITATION OF TENDER ON PERCENTAGE
RATE (B-1) TENDER CONTRACT FORM**

Government of Gujarat
Road & Buildings Department
No.TNC-1088-D-347-(7)-C
Schivalaya, Gandhinagar
Date:- 11/07/2017

Reference:-

1. R & B Department Resolution No.CON-1269-PAC-(52)-C, Dated 05/06/1985
2. R & B Department Resolution No.TNC-1088-D-347-(7)-C dated 22/04/1988
3. R & B Department Resolution No. TNC-1088-D-347-(7)-C dated 05/08/1988
4. R & B Department Resolution No. TNC-1088-D-347-(7)-C dated 15/12/2003

RESOLUTION

1. The question of raising monetary limit for B-1 tender form from Rs.50.00 lakhs (Rupees Fifty Lakhs only) was under consideration of Government. Government is pleased to order that the monetary limit of Rs.50.00 lakhs (Rupees Fifty Lakhs only) for B-1 tender form (fixed under aforesaid G.R. dated 15/12/2003) is hereby enhanced to Rs.12.00 Crore (Rupees Twelve Crore only) for Road works, and Rs.10.00 Crore (Rupees Ten Crore only) for Bridge and Building works. This enhanced monetary limit shall be applicable to the tenders to be invited hereafter with the strict application of a condition that tenders for the works amount put to tender upto Rs.12.00 Crore (Rupees Twelve Crore only) for Road works, and Rs.10.00 Crore (Rupees Ten Crore only) for Bridge and Building works should invariably be invited on B-1 tender form only.
2. Other safeguards and instructions in the G.Rs. mentioned in reference should be strictly followed.
3. These orders are issued with the concurrence of Finance Department dated 27/06/2017 on this Department's file No. TNC-102013-731236-04-C

By order and in the name of the Governor of Gujarat,

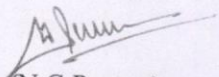
(N.G.Parmar)
Officer on Special Duty (S.P)
R&B Department
Gandhinagar

ટેન્ડરમાં જથ્થાવધારા તથા
જથ્થાવધારાના ભાવના માપદંડમાં
સુધારણા કરવા બાબત

ગુજરાત સરકાર
માર્ગ અને મકાન વિભાગ
બ્લોક નં.૧૪/૨, સરદાર ભવન,
સચિવાલય, ગાંધીનગર
ઠરાવ ક્રમાંક: TNC-10-2017-01-C
તા.૧૧/૦૭/૨૦૧૭

ઠરાવ

ટેન્ડરમાં જથ્થાવધારા તથા જથ્થાવધારાના ભાવના માપદંડ બાબતે બી-૧ અને બી-૨ ટેન્ડરના કલોઝ-૧૪.૨ માં જણાવ્યા મુજબ જથ્થાવધારા માટે ૩૦ ટકા સુધીનો જથ્થો ટેન્ડરના ભાવથી અને ૩૦ ટકાથી વધુ જથ્થામાં વધારો હોય તો જે તે વર્ષમાં કામગીરી કરેલ હોય તે વર્ષના એસ.ઓ.આર.થી કરવાની જોગવાઈ છે.

સદરહુ જોગવાઈમાં સુધારણા કરવા બાબતે સરકારશ્રીમાં ઘણા લાંબા સમયથી વિચારણા હેઠળ હતું. જે અન્વયે નીચે મુજબનો સુધારો કરવામાં આવે છે.

EXISTING CLAUSE	AMENDMENT
Form B-1 Clause- 14.2 Form B-2 Clause- 14.2 Except that when the quantity of any item exceeds the quantity as in the tender by more than 30% the contractor will be paid for the quantity in excess of 30% at the rate entered in the SOR of the year during which the excess in quantity is first executed and for the material consumed in excess quantity the rate for the material to be charged would be basic rate taken into account for fixing the rate for the SOR above instead of the rate stipulated in Schedule-A.	Form B-1 Clause- 14.2 Form B-2 Clause- 14.2 Except that when the quantity of any item exceeds the quantity as in the tender by more than 10% the contractor will be paid for the quantity in excess of 10% at the rate entered in the SOR of the year during which the excess in quantity is first executed or tender rate whichever is less.

ઉપરોક્ત તમામ સુચનાનો અમલ ચુસ્તપણે તાત્કાલિક અસરથી કરવાનો રહેશે.

ગુજરાત રાજ્યના રાજ્યપાલશ્રીના હુકમથી અને તેમના નામે,

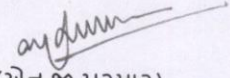
(એન.જી.પરમાર)

ખાસ ફરજ પરના અધિકારી (વિ.યો.)

માર્ગ અને મકાન વિભાગ

ગાંધીનગર

**STANDARDS FOR CEMENT
CONSUMPTION FOR DIFFERENT
ITEMS OF WORK**

Government of Gujarat
Roads & Building Department,
Circular No. PRC/10/2017/Cement Consumption/16/C
14, Sardar Bhavan, 2nd Floor,
Sachivalaya, Gandhinagar
Date:- 11/05/2017

Read:- Government of Gujarat, Road & Building Department, Sachivalaya, Gandhinagar Circular
No. SOR/1085/7/H(1) dated 08/12/1986.

CIRCULAR

The uniform rate of cement consumption for various item was prepared and circulated vide
No. SOR/1085/7/H(1) dated 08/12/1986.

At the outset, current practice of estimating cement consumption in concrete item of
various Building, Bridge and Road project is based on above circular. However, it is generally
observed that the cement consumption derived by actual mix design is lower than the standard
cement consumption. Some of provision of the said circular become obsolete due to subsequent
revisions in the relevant IS code and IRC code. The maximum cement consumption as per IS :
456-2000 and IRC : 112-2011 is 450 Kg./m³. Also cement industry and aggregate crushing
industry have involved better quality of cement and aggregate over the years which have far
reaching impact on mix design of the present day concrete.

Mix design report of GERI reflecting entire Gujarat region have been considered in
averaging the cement consumption in various grade of design mix concrete. To minimize the
difference between standard cement consumption of cement and actual consumption derived by
mix design by GERI and the cement consumption as per provision of IS and IRC code falling
cement consumption is proposed for estimation purpose.

Looking the above facts, the cement consumption mentioned in circular vide No.
SOR/1085/7/H(1) dated 08/12/1986 is required to modify as per below:

EXISTING ITEM			AMENDMENT		
Item	Unit	Quantity of cement to be used per unit quantity of work in Kg	Item	Unit	Quantity of cement to be used per unit quantity of work in Kg.
Building, Road & Bridge Items					
Providing & casting in situ ordinary cement concrete M75 for PCC work	Cu.m.	160	Providing & casting in situ ordinary cement concrete M7.5 for PCC work	Cu.m.	160
Providing & casting in situ ordinary cement concrete M100 for PCC work	Cu.m.	220	Providing & casting in situ ordinary cement concrete M10 for PCC work	Cu.m.	220
Providing & casting in situ ordinary cement concrete M150 for PCC work	Cu.m.	320	Providing & casting in situ ordinary cement concrete M15 for PCC work	Cu.m.	290
Providing and casting situ control cement concrete M200 for RCC work	Cu.m.	400	Providing and casting situ control cement concrete M20 for RCC work	Cu.m.	360
Providing and casting situ control cement concrete M250 for RCC work	Cu.m.	450	Providing and casting situ control cement concrete M25 for RCC work	Cu.m.	380
Providing and casting situ control cement concrete M350 for RCC work	Cu.m.	500	Providing and casting situ control cement concrete M35 for RCC work	Cu.m.	425
Providing and casting situ control cement concrete M400 for RCC work	Cu.m.	525	Providing and casting situ control cement concrete M40 for RCC work	Cu.m.	440
Providing and casting situ control cement concrete M450 for RCC work	Cu.m.	540	Providing and casting situ control cement concrete M45 for RCC work	Cu.m.	450
New Item					
-	-	-	Providing and casting situ control cement concrete M30 for RCC work	Cu.m.	410

The cement consumption of other than above concrete item and other details mentioned in circular vide No. SOR/1085/7/H(1) dated 08/12/1986 will be remain same.

(N.G. Parmar)
Officer on Special Duty (S.P.)
R&B Department
Gandhinagar

To,

- 1) The Personal Secretary, Office of the Secretary, Road & Building Department, Sachivalaya, Gandhinagar
- 2) The Personal Secretary, Office of the Secretary, Narmada, Water Resources, Water Supply and Kalpsar Department, Sachivalaya, Gandhinagar
- 3) The Personal Secretary, Office of the Principal Secretary, Health & Family Welfare Department, Sachivalaya, Gandhinagar
- 4) The Personal Secretary, Office of the Additional Chief Secretary, Urban Development and Urban Housing Department, Sachivalaya, Gandhinagar
- 5) The Personal Secretary, Office of the Principal Secretary, Panchayat, Rural Housing and Rural Development Department, Sachivalaya, Gandhinagar
- 6) Accountant General, Rajkot/Ahmedabad
- 7) All the Chief Engineers, Road & Building Department, Sachivalaya, Gandhinagar
- 8) All the Chief Engineers, Narmada, Water Resources, Water Supply and Kalpsar Department, Sachivalaya, Gandhinagar
- 9) The Managing Director, Gujarat State Road Development Corporation, Nirman Bhavan, Gandhinagar
- 10) The Chief Engineer & Director, Staff Training College, Gandhinagar
- 11) The Director, Gujarat Engineering Research Institute (GERI), Vadodara
- 12) The Under Secretary, Gujarat Vigilance Commission, Vigilance Bhavan, Gandhinagar
- 13) All the Superintending Engineers, Road & Building Department (State, Panchayat, National Highway, Capital Project Circle, Electric Circle)
- 14) All the Executive Engineers, (as above circles)
- 15) All Technical Officers, Road & Building Department, Sachivalaya, Gandhinagar
- 16) All Technical Branches, Road & Building Department, Sachivalaya, Gandhinagar
- 17) President, Gujarat Contractors Association, Gajjana Hall, Law Garden, Law College Road, Ahmedabad
- 18) Branch Select file-2017.

રસ્તા, પુલો અને મકાનોની ગુણવત્તા
ચકાસણી માટેના નિયતપત્રકોનો ઉપયોગ
ઇન્સ્પેક્શન નોંધ માટે કરવા બાબત

ગુજરાત સરકાર
માર્ગ અને મકાન વિભાગ
બ્લોક નં.૧૪/૨, સરદાર ભવન,
સચિવાલય, ગાંધીનગર
ક્રમાંક: PRC-10-2017-31-C
તા.૨૬/૦૫/૨૦૧૭

પરિપત્ર

માર્ગ અને મકાન વિભાગના રસ્તા, પુલ અને મકાનના કામો ઇજારદારશ્રી મારફત કરાવવામાં આવે છે. આ કામોની ગુણવત્તા ચકાસણી કરવાનું કામ ગુણવત્તા નિયમન (મા.મ.) વિભાગ દ્વારા કરવામાં આવે છે. કામોની ચકાસણી માટે ગુણવત્તા નિયમન (મા.મ.) વિભાગ હેઠળ ગુજરાત રાજ્યમાં કુલ-૬ (છ) કાર્યપાલક ઇજનેરશ્રીઓની નિમણૂક કરવામાં આવેલ છે. કામોની ગુણવત્તા ચકાસણી કરી તેનો સ્થળસ્થિતિ મુજબનો ઇન્સ્પેક્શન રીપોર્ટ કાર્યપાલક ઇજનેરશ્રી દ્વારા તૈયાર કરી જે તે સંબંધિત કાર્યપાલક ઇજનેરશ્રીને પૂર્તતા અર્થે સાદર કરવામાં આવે છે અને એની જાણ જે તે વિભાગના સંબંધિત અધિક્ષક ઇજનેરશ્રી અને મુખ્ય ઇજનેરશ્રીને કરવામાં આવે છે. ગુણવત્તા નિયમનના કાર્યપાલક ઇજનેરશ્રીઓ દ્વારા રજુ કરવામાં આવતા ઇન્સ્પેક્શન રીપોર્ટની વિગતોમાં એકસરખા ફોર્મેટ વિભાગ દ્વારા નિયત કરેલ ન હોવાથી એકસૂત્રતા રહેતી નથી.

મુખ્ય ઇજનેરશ્રીઓની કમિટીમાં નક્કી થયા મુજબ ઇન્સ્પેક્શન રીપોર્ટમાં એકસૂત્રતા રહે અને પી.એમ.જી.એસ.વાય.માં “ગ્રેડ સિસ્ટમ” વાળો રીપોર્ટ સાદર કરવામાં આવે છે એ પદ્ધતિએ ઇન્સ્પેક્શન રીપોર્ટનું ફોર્મેટ બનાવવા જણાવવામાં આવેલ હતું. માર્ગ અને મકાન વિભાગના રસ્તા, પુલ અને મકાન માટેના ગુણવત્તા ચકાસણી કરવા માટેના ઇન્સ્પેક્શન રીપોર્ટના ફોર્મેટ ગ્રેડ સિસ્ટમવાળા આ સાથે તૈયાર કરવામાં આવેલ છે. હવે પછી ગુણવત્તા વિભાગના મુખ્ય ઇજનેરશ્રી, અધિક્ષક ઇજનેરશ્રી, કાર્યપાલક ઇજનેરશ્રી, સંબંધિત અધિક્ષક ઇજનેરશ્રી તથા જે કોઈ પણ અધિકારીશ્રી ગુણવત્તા ચકાસણીની કામગીરી કરે તેમણે આ ફોર્મેટનો ઇન્સ્પેક્શન રીપોર્ટ માટે ઉપયોગ કરવાનો રહેશે.

કામની ચકાસણી કર્યા બાદ કામનો એકંદરે ગ્રેડ “S (Satisfactory), SRI (Satisfactory but require improvement) કે U (Unsatisfactory)” આપવાનો રહેશે.

(૧) જો ગુણવત્તા ચકાસણીમાં કામનો એકંદરે ગ્રેડ “S” મળશે તો એ કામ Satisfactory કક્ષાનું હોય કોઈ પૂર્તતા કરવાની રહેતી નથી.

(ર) જો ગુણવત્તા ચકાસણીમાં કામની એકંદરે ગ્રેડ "SRI" (Satisfactory but require improvement) મળશે તો જે તે આઉટમમાં "SRI U" ગ્રેડ મળેલ છે એ આઉટમની સુધારણા ટેન્ડરમાં જણાવેલ સ્પેશીકીકેશન મુજબ કરી એનો "ATR" (Action Taken Report) સંબંધિત કાર્યપાલક ઇજનેરશ્રીએ તૈયાર કરી જે તે ગુણવત્તા નિયમન વિભાગના કાર્યપાલક ઇજનેરશ્રીની કરીથી સ્થળ મુલાકાત કરાવશે અને ગુણવત્તા નિયમન વિભાગના કાર્યપાલક ઇજનેરશ્રી પૂર્તતા સાથે સહમત હોય તો અહેવાલ અધિક્ષક ઇજનેરશ્રી, ગુણવત્તા નિયમન વિભાગને સાદર કરશે. અધિક્ષક ઇજનેરશ્રી, ગુણવત્તા નિયમન વિભાગ પૂર્તતા અહેવાલ યોગ્ય હશે તો રીગ્રેડ એટલે "SRI U" માંથી "S" માટે ભલામણ કરશે. ત્યારબાદ સદરહુ પૂર્તતા અહેવાલ સંબંધિત અધિક્ષક ઇજનેરશ્રી મારફત સંબંધિત મુખ્ય ઇજનેરશ્રીને સાદર કરવાનો રહેશે. સંબંધિત મુખ્ય ઇજનેરશ્રીએ સદરહુ "ATR" મુખ્ય ઇજનેરશ્રી ગુણવત્તા નિયમન વિભાગને પૂર્તતા ગ્રાહ્ય રાખી "S" ગ્રેડીંગ આપવા માટે ભલામણ સદર કરવાનો રહેશે. ગુણવત્તા નિયમન વિભાગમાંથી પૂર્તતા ગ્રાહ્ય રાખી "S" ગ્રેડીંગનું પ્રમાણપત્ર મુખ્ય બાદ જ આ આઉટમનું બાકીનું ચૂકવણ કરવાનું રહેશે.

(૩) ગુણવત્તા ચકાસણીમાં કામની એકંદરે ગ્રેડ "U" (unsatisfactory) મળશે તો જે તે આઉટમમાં "SRI U" મળેલ છે એ આઉટમમાં સુધારણા અથવા Reconstruction (આઉટમ કરીદો કરવી) ટેન્ડરમાં જણાવેલ સ્પેશીકીકેશન મુજબ કરી એનો "ATR" સંબંધિત કાર્યપાલક ઇજનેરશ્રીએ તૈયાર કરી જે તે ગુણવત્તા નિયમન વિભાગના કાર્યપાલક ઇજનેરશ્રીની કરીથી સ્થળ મુલાકાત કરાવશે અને ગુણવત્તા નિયમન વિભાગના કાર્યપાલક ઇજનેરશ્રી પૂર્તતા સાથે સહમત હોય તો અહેવાલ અધિક્ષક ઇજનેરશ્રી, ગુણવત્તા નિયમન વિભાગને સાદર કરશે. અધિક્ષક ઇજનેરશ્રી, ગુણવત્તા નિયમન વિભાગ પૂર્તતા અહેવાલ યોગ્ય હશે તો રીગ્રેડ એટલે "SRI U" માંથી "S" માટે ભલામણ કરશે. ત્યારબાદ સદરહુ પૂર્તતા અહેવાલ સંબંધિત અધિક્ષક ઇજનેરશ્રી મારફત સંબંધિત મુખ્ય ઇજનેરશ્રીને સાદર કરવાનો રહેશે. સંબંધિત મુખ્ય ઇજનેરશ્રીએ સદરહુ "ATR" મુખ્ય ઇજનેરશ્રી ગુણવત્તા નિયમન વિભાગને પૂર્તતા ગ્રાહ્ય રાખી "S" ગ્રેડીંગ આપવા માટે ભલામણ સદર કરવાનો રહેશે. ગુણવત્તા નિયમન વિભાગમાંથી પૂર્તતા ગ્રાહ્ય રાખી "S" ગ્રેડીંગનું પ્રમાણપત્ર મુખ્ય બાદ જ સમગ્ર કામનું બાકીનું ચૂકવણ કરવાનું રહેશે.

કોન્ટ્રોલન સુચનાની આમલ ધુન્નપણે તત્કાલિક અસરથી કરવાનો રહેશે.

વિ.કે.કે.-

(૧) રસ્તા, પુલ અને મકાનના કામોની ગુણવત્તા

ચકાસણી માટેના નિયત પત્રકો

(૨) એ.ટી.આર.નું નિયત પત્રક

(એન.જી.પરમાર)

ખાસ કરજ પરના અધિકારી (વિ.યો.)

માર્ગ અને મકાન વિભાગ

ગાંધીનગર

**MUNICIPAL CORPORATION
BHAVNAGAR**

VENDOR LIST

(A) LIST OF APPROVED VENDORS FOR CIVIL WORKS

Sr. No.	ITEMS	Approved Brands / Quality
1	CEMENT PPC 53 Grade & SULPHATE RESISTANT CEMENT,S.R.C.	Ambuja, Hathi, Ultra Tech, Sanghi, Siddhi, Hi-bond
2	BRICKS	MBM, Arjun, PBM, 555, Kisan, ABM, TRD, Paresh, Dhara, B.R.C., Kiran, BMB, Kirit, Sonal
3	Steel TMT, CRS	TISCO, SAIL, VIZAG, Kamdhenu, NATIONAL, Electrotherm, JSW, Welspun steel, Pollad Steel, DIAMOUND TMT, M. G. Steel, Friends Steel, Crown next TMT, Briskon TMT
4	VITRIFIED TILES	Asian, Kajaria, Jonson, Varmora, Simpolo, OASIS
5	CERAMIC TILES	Asian, Kajaria, Johnson, Varmora, Simpolo, OASIS
6	GLAZED TILES	Asian, Kajaria, Johnson, Varmora, Simpolo
7	ACRYLIC PAINT	ICI, Asian, Nerolac, Burger
8	OIL BOUND DISTEMPER	ICI, Asian, Nerolac, Burger
9	EXTERIOR WEATHER PROOF EMULSION PAINT	ICI, Asian, Nerolac, Burger
10	Oil Paint	ICI, Asian, Nerolac, Burger
11	SANITARY WARE	Cera, Hindware, Parryware
12	CAST IRON PIPES AND FITTINGS.	NECO, Swayarhoo, Bengal, Oriental Castings, Electro steel Castings
13	P.V.C. PIPES AND FITTING (UPVC/CPVC)	Finolex, Supreme, Jain, Kisan, Astral, Dutron, Prince
14	CHROMIUM PLATED WATER SUPPLY FITTINGS	Jaquar, Ess Ess, Plumber ,ESSCO, Crown, Metro, Prince
15	GALVANIZED PIPE	Tata, Essco, Jaquar, Ess Ess, Plumber
16	GALVANIZED FITTINGS	'R' Brand, 'RV' Brand, Kranti
17	C.I. MANHOLE COVER	Manish, Sil, NECO
18	PLUMBING FIXTURES	Jaguar, Plumber, Essco
19	PVC WATER TANK (100% VIRGIN PVC)	Sintex, Aqua
20	ALUMINIUM SHEETS AND ACCESSORIES	Nalco, Jindal, Hindalco, Banko

Sr. No.	ITEMS	Approved Brands / Quality
21	ALUMINIUM EXTRUDED DOOR/ WINDOW SECTION	Jindal, Hindalco, Banko, Ajin India, Aldowin, Alumilite
22	ALUMINIUM HARDWARE	Rajdoot, Belu, Diamond, Glider, Ajin India, Aldowin, Alumilite
23	WATER PROOFING MATERIALS	Zycosil, Dr. Fixit, Kerakoll, Pidilite, Roff
24	DOOR CLOSER	Efficient Gadget, Everite, Hardwin, Aldowin, Ozone
25	DOOR FITTINGS	Godrej, Efficient Gadgets (E.G.) Dunex, Doorset, Suzu, Coral
26	HINGES	Suzu, Yama, E.P.P.W.
27	SCREW AND BOLTS	Nettle Folds, GKW, Stud
28	BOLTS & FASTENERS	Hilti, Fisher
29	LIFT	Top, Express, Omega, OTIS, Schander, TRIO, Aegis Elevator, Mitsubishi, Aditya, Siemens slider
30	ROOFING MATERIAL – Galvalume sheets	TATA, Essar, Jindal
31	Slag Cement	SANGHI CEMENT Sanghipuram
32	CPVC PIPES FOR AUTOMATIC SPRINKLER FIRE EXTINGUISHING SYSTEM	ASTRAL POLY TECHNIK LIMITED પાર્કિંગ એરિયા, બેઈઝમેન્ટ એરિયા જેવા વિસ્તારો સિવાય માત્ર કન્સીલ્ડ પાઈપીંગ માટે આ કંપનીના CPVC pipe નો ઉપયોગ fire sprinkler piping માટે કરવાની મંજૂરી આપવામાં આવે છે.
33	AAC Blocks	NXTBLOC
34	Jointing Mortar	NXTFIX Block
35	Ready Mix Plaster	NXTPLAST
36	Block joining Masonry Mortar	Unifix
37	Tile adhesive	Unifix
38	RCC bench	Sardar Pre cast
39	Rubber mould garden curbin	Sardar Pre cast

Sr. No.	ITEMS	Approved Brands / Quality
40	Rubber mould Paver block	Sardar Pre cast
41	Fencing Pole	Sardar Pre cast
42	RCC Masonry block	Sardar Pre cast
43	Pre cast wall	Sardar Pre cast

(B) LIST OF APPROVED VENDORS FOR MECHANICAL & ELECTRICAL WORKS

Sr. No.	Description	Name of Manufacturer
1	HSCF Pump	Crompton Greaves Ltd
		Kirloskar Brothers Limited (KBL)
		JASCO
		Mather & Platt Pumps Ltd.
		Jyoti Ltd.
2	Electric Motor	Lubi Industries LLP
		Bharat Bijlee Ltd.
		Jyoti Ltd.
		JSL Industries Ltd.
		Jeumont Electrical India Pvt. Ltd.
3	Electrical Panel	LHP
		Crompton Greaves Ltd
		Bhagyashree Power Control
		Dynamic Control System
		Elembica Services
		JSL Industries Ltd.
4	Kinetic Air Valve	Nutral Power Tech
		Kirloskar Brothers Limited (KBL)
		FOURESS Engineering (India) Limited.
		Durga Valves Pvt.Ltd
		Orbinox
5	Expansion Bellows	श्री. डिवा. ए.ए.ए.ए.ए.
6	Dewatering (Drain) Pump(Submersible/ Horizontal)	Precise Engineers
		KSB Pumps
		Kirloskar Brothers Limited (KBL)
		JASCO
		Crompton Greaves Ltd
		La Gajjar Machinery Pvt Ltd.
7	Sluice Valves and Sluice Gate	Pullen Pumps Industries Pvt. Ltd.
		MBH
		Kirloskar Brothers Limited (KBL)
		DURGA Valves Pvt.Ltd
		L & T Valves
8	UPVC Pipe	Jupiter
		SACHDEVA
		Supreme Industries Ltd.,Mumbai
		Dutron Polymers Ltd
		Parixit Industries Ltd., A'bad
9	HDPE Pipe	Jain Irrigation Systems Ltd., Jalgaon
		Parixit Industries Ltd., A'bad
		Jain Irrigation Systems Ltd., Jalgaon
		Dutron Polymers Ltd
10	C.I. Pipe	Jindal
		Essar Steel
		Electro Steel, Kejriwal, Oriental Castings, BIC, Jindal, Lanco Industries Ltd.,Chennai, Kesins
13	EOT Crane	Grip Engineering Pvt. Ltd., JAPS Project, Brady & Morris Engineering Co. Ltd., Techno Industries

Sr. No.	Description	Name of Manufacturer
14	Cable & Wires	KEI Industries Ltd.
		Polycab Wires Pvt. Ltd.
		Aerolex Cables Pvt. Ltd.
		Allwin Industries
		Finolex Cables
		L&T Cables
	ULTRA CAB (India) Limited	
15	Transformer	Atlanta Electricals Pvt. Ltd.
		Powerlite Electricals
		Voltamp Transformers Ltd.
		SKP Transformers
		Arya Electronics
16	Components for MCC :	
	Switch	L&T, Siemens
	HRC Fuse	L&T, Siemens
	Timer	L&T, Siemens
	Relay	L&T, Siemens
	Push Button Stations	L&T, Siemens
	Indicating Lamp	L&T, Siemens
	Cable Jointing Kit	CCI, M. Seal
	MCB/DB's	MDS, Siemens, Indokupp
17	Capacitors	L&T, Crompton, Khatau Note: Capacitors shall be oil fill type
18	KWH Meter	Simco, Jaipur, GEC
19	Light Fittings: (Indoor & Outdoor Luminaries)	Philips, Crompton, Bajaj, NESSA Illumination
20	Exhaust Fans	Crompton, Bajaj,
21	Ceiling Fans	Crompton, Bajaj, Havells
22	Air Blowers	Everest Ltd.
		Swan Pneumatics (P) Ltd
23	Alum Dosing Pumps	Asia LMI
		VK Pumps
		Swelore
24	Pressure Gauges	General Instruments
		Bells Control
		H. Guru Marketing
25	Level Gauge / Indicator	R K Dutt
		Levecon
		S. B. Electromec
26	Clarifier Equipment	Enviro Control Associates
		Voltas Ltd
		Hindustan Dorr-Oliver
		Geomiller/Triveni
27	Chlorination System	Industrial Device (I) Pvt. Ltd
		Metito
		Chloroequip
		Pennwalt
28	Gear Box	Greaves
		Radicon
		Elecon
		Shanti

Sr. No.	Description	Name of Manufacturer
29	Level Switches	Level-Tech
		Revathi Electronics
		Levec
30	Refrigerator	LG, Samsung, Kelvinator
31	PVC Pipes for Fluid	Finolex, Jain Irrigation
32	PVC Conduits for Electricals	Precision, Shakti
33	Butterfly Valve	KIRLOSKAR Brothers Limited(KBL), DURGA valves Pvt Ltd, L & T valves, R&D MULTIPLE, Jupiter, श्री कृष्णा इंटरप्र्राइज IVC, IVI, Audco, R & D multiple, Jupiter, Cair, Orbit Engineers
34	Check Valve (Dual Plate check Valve)	KIRLOSKAR Brothers Limited(KBL), DURGA valves Pvt Ltd, Orbinox, R&D MULTIPLE, Orbit Engineers
35	Metallic Expansion Bellow	Beloflex(B.D. Engineers), Stanfab Engineering Pvt. Ltd., D. Wren Engineering Pvt. Ltd., Sur Industries,
36	Centrifugal / Centrifugal Non Clog Pumps	Beacon Weir, KSB, Mather & Platt (Wilo), Worthington, WPIL, Xylem pumps , Grundfos Pumps Pvt. Ltd., MBH, JASCO
37	Submersible non Clog Pumps / Submersible Centrifugal Pumps	Kirlosker, KSB, ABS, ITT- Flyght, Xylem pumps, Grundfos Pumps Pvt. Ltd. , MBH, JASCO, AQUA, Jyoti, PULLEN PUMPS, Alpha, Het Pump
38	Screw Pump	Roto, Netzsch, Tushaco, Seepex
39	Metering / Dosing Pumps	Swellore, V.K. Pumps, Shapotools
40	Non Return Valves (Single / multi door) / Dual Plate Check Valves	Kirlosker, IVC, IVI, R & D multiple, Durga, Jupiter, Cair, Orbit Engineers
41	Knife Gate valves	Jash, Fouess, Vass (Dezurick), Vag, Orbinox, Orbit Engineers
42	Sluice gates / open Chanel Gates	Jash Engineering, IVC, R & D Multiple, Jupiter
43	Mechanical Fine Screens – Step (Mat) Type / Drum Type	Jash, Huber, Johnson, Savi, Italy, Apollo Screens
44	Mechanical Course bar Screen	Jash, Huber, Johnson, HDO, Triveni, Savi, Italy
45	Manual Bar Screen	Jash, Japs, HDO, Triveni, Auric
46	Grit mechanism	EIMCO – KCP, Hindustan Dorr – Oliver, Jash-Shivpad, Triveni, Voltas
47	Diffused Aeration System	EDI, OTT, Rehau
48	Air Blower	Kay, Swam, Everest, Usha Compressors, Gardner Denver
49	Agitator / mixer	Remi, Schurtek, Fibre & Fibre, Milton Roy
50	Gear Boxes	Greaves, Elecon, CPEC, PEPL, Bonfiglioli
51	Centrifuge	Humboldt, Alpha Laval, Hiller

Sr. No.	Description	Name of Manufacturer
52	HDPE Pipes	Astral, Dutron, Duraline, Narmada, RIL (PIL), Penwalt, Anjney, Jain Irrigation, Sangir
53	Air Compressor	Ingersoll – Rand, Khosla, Kirlosker, CPE, Alpha
54	Bearing For All Equipments	SKF, FAG, Tata
55	Fasteners	Precision, Durakhanawala, Echjay, Tata, Sundaram
56	Mechanical Seals	Eagle Seals (Sealol), Durametallic, Burgman
57	Electric Actuator	Auma, Rotork, Emerson, Pentair
58	(1) CATEGORY III Indoor LED fittings, LED Panel light, LED down light, outdoor LED light (street light, LED flood light, LED Post top lantern, LED bollard) (2) Solar LED Light	NESSA ILLUMINATION TECHNOLOGIES PVT.LTD., Litsun, Nextray
59	STREET LIGHT POLES	AMBICA POLES (for octagonal poles, swage poles, street light poles, high mast poles, decorative poles, conical poles, JETCOTECH Engineering LLP
60	Resilient Seated Slice Valve	Cair
61	Air Valve	Cair, Orbit Engineers
62	Flow Control valve	Cair
63	Altitude Control valve	Cair, Orbit Engineers
64	Pressure reducing valve	Orbit Engineers
65	Pressure relief valve	Orbit Engineers
66	Ball valve	Orbit Engineers
67	Mast pole	JETCOTECH Engineering LLP
68	Earthing material	JETCOTECH Engineering LLP
69	Hot dip galvanizing	JETCOTECH Engineering LLP
70	LED Highbay	Litsun

(C) LIST OF APPROVED VENDOR FOR INSTRUMENTATION SYSTEM

SR NO	DESCRIPTION	Name Of Manufacturer
1	Electromagnetic Flow Meter	E+H, Siemens, Abb, Fuji, Yokogawa, Krohne-Marshall, AAROHI Embedded System Pvt Ltd., Emerson, SBEM
2	Pressure Gauges	Wika, H.Guru, General Instruments Consortium Manometer (India) P. Ltd., Baumer, Waaree
3	Pressure Switch	Danfoss, Indfoss, Switzer
4	Process Analyzers (pH, DO, Free / Residual Chlorine, BOD / COD)	E+H, Emerson, Hach, Chemitech, Polymetron, Wtw (Forbes Marshall), Yokogawa
5	Ultrasonic transmitter level / diff. level / flow	E+H, Siemens – Milltronics, Krohne, Vega
6	Hydraulic level transmitter	E+H, Siemens, ABB, Forbes- Marshall, Emerson, SBEM
7	Displacer/Float Switches	Levcon, Nivo, Toshbro, Pune Techtrol, SBEM
8	PP Float / Buoyancy switch	Peppri + Fuchs, Baumer, Waaree, E+H, Pune Techtrol, SBEM
9	Float & Board Type Level Gauge	Levcon, Nivo, Toshbro, Pune Techtrol, SBEM
10	Electromagnetic Flow Meter	E+H, Siemens, ABB, Fuji, Yokogawa, Krohne-Marshall
11	Field Transmitter (P, DP, F, L, T)	ABB, Fuji, Yokogawa, Honeywell, Emerson
12	Pressure Gauges	Wika, H.Guru, General Instruments Consortium Manometer (India) P. Ltd., Baumer, Waaree
13	Panel Mounted Process Indicator & Flow Integrator	Masibus, Nishko, Nivam, Selectron, Radix, Yokogawa, ABB
14	Pressure Switch	Danfoss, Indfoss, Switzer
15	Programmable Logic Controllers	Rockwell (Allen Bradeley), Siemens, Schneider, Fuji, ABB, GE Fanuc
16	Control Panel Enclosure	Rittal, Enklotek, Bartakke, BCH, Eldon
17	Alarm Annunciator	Aplab Ltd., Minilec, IIC
18	Solenoid valves	Asco, Rotex, Schrader
19	Tube Fitting	Excel Hydropneumatic, Multimetal, Placka

20	Instrument Valves , Manifolds	Aptek, Anmol (Superlok), Excel Hydropneumatic, General
21	Fitting	Instrument Consortium , Multimetal, Technomatic, Placka
22	Pneum , Brass Fitting	Swagelok, Multimetal Industries, SMC, Festo
23	Control Panel Accessories / Components	
a.	Miniature Relay	Wago, Omron,Phoenix, Rockwell
b.	Indication Pilot Lamps (LED Type)	Teknic, Schneider, Siemens
c.	Push Button / Selector Switch (with NO/NC Elements)	Teknic, Schneider, Siemens
d.	DC Power Supplies (DIN Rail mounted)	Phoenix, Omron, Schneider, Rockwell
e.	Terminals	Elmex, Phoenix, Wago, Connectwell
f.	Panel Wires	Finolex , Havell's , R R Kabel
g.	Panel Illumination	Philips , Crompton , GE
24	Instrument Cables (Power , Signal , Control)	Associated Cables, Associated Flexible and Wires P.Ltd., Brooks Cables, Thermo Cables, Udey Pyro
25	Cable Glands	Ex- protecta, Braco, Sudhir, Comet, Connectwell
26	Junction Box	Ex- protecta, CEAG, Sudhir, Baliga, FCG
27	Cable Tray	M.M.Engineering, Globe, Jacinth, Equi. Reputed, JETCOTECH Engineering LLP
28	Computer System	HP-Compaq, Dell, IBM, Sony, Samsung
29	UPS	Hirel-Hitachi, Emerson, APC
30	<ol style="list-style-type: none"> 1. PLC (Programmable Logic Controller) 2. SCADA (Supervisory Control and Data acquisition) 3. VFD (Variable Frequency Drive Up to 500 KW) 4. ACB (Air Circuit Breaker up to 	MITSUBISHI ELECTRIC INDIA PRIVATE LIMITED, Emerald House, EL-3, J Block, M.I.D.C., Bhosari, Pune 411026

	<p>6000A)</p> <ol style="list-style-type: none">5. MCCB (Moulded Case Circuit Breaker up to – 1600 A)6. MCB (Miniature Circuit Breaker up to – 63 A)7. ELCB (Earth Leakage Moulded Case Circuit Breaker up to 1600 A)8. Contractor up to – 800 A & OLR (Over load Relay) up to 630 A9. Multi Functional Meters10. MPCB (Motor Protection Circuit Breaker up to 32 A)	
--	---	--

(D) LIST OF APPROVED VENDORS FOR MATERIALS RELATED TO WATER**SUPPLY AND SEWERAGE NETWORK**

SR. NO.	ITEMS	NAME OF AGENCIES
1	A C Pressure pipe MAZZA process	Lotus, Kirti
2	A C Pressure pipe MEGHNANI process	Lotus, Kirti, Hindustan
3	Sluice Valve	Durga, kartar, Kirloskar, Jupiter, SACHDEVA (C.I. & D.I.), શ્રી કિર્તી ઇન્ડસ્ટ્રીઝ, Cair, Orbit Engineers
4	DI Pipe	Electrotherm (I) Ltd.,Ahmedabad, Lanco Industries Ltd.,Chennai, Electrsteel, Jindal Saw Ltd.,Ahmedabad, Kesins, Welspun
5	R.C.C. PIPE (COLLAR JOINT & SOCKET SPIGOT JOINT) CLASS NP3 & NP4, & R.C.C. COLLARS	VIPUL SPUN PIPES (SIHOR & LATHIDAD,BOTAD), KATARIYA & CO. (DHASSA), OMKARESHVAR PIPES (NAVAGAAM), OMKAR PIPES (LATHIDAD, BOTAD), MARUTI PIPES (BAGODARA ,AHMEDABAD), KALATHIYA PIPES(BAGODARA ,AHMEDABAD), R. S. PIPES (BODELI), UMA HUME PIPES (KALOL, GANDHINAGAR), SIDHDHIVINAYAK (KARDEJ ,BHAVNAGAR)
6	R.C.C. MACHINEOLE FRAME & COVER, INLET FRAME COVER 10T.(600*450 MM.) , 20T.,35T., & 50T.	SONI CEMENT PRODUCT , VIPUL SPUN PIPES, KATARIYA & CO., OMKARESHVAR PIPES, OMKAR PIPES, MARUTI PIPES, KALATHIYA PIPES , R. S. PIPES, UMA HUME PIPES, SIDHDHIVINAYAK , S.K. Corporation, Laxmi Price Industries, S.J.Corporation, Sardar pre cast
7	Stone ware PipeManufacturer having BIS Certificate for ISI marking	Krishna Pipe, j.K. Pipe, Taya ceramic, Burn & co., perfect Potteries, Navroji Vakil, Kashmira
8	D.I. & C.I. FITTINGS	RG BRAND, ESSEM Engineering Industries, Bikaners Engineers works
9	CID Joints	ESSEM Engineering Industries
10	Valves & Graded Castings	ESSEM Engineering Industries
11	Pipe Fittings	ESSEM Engineering Industries, Bikaners Engineers works
12	CI/DI/MS graded castings	Bikaners Engineers works
13	Scaper machine hole	Sardar Pre cast

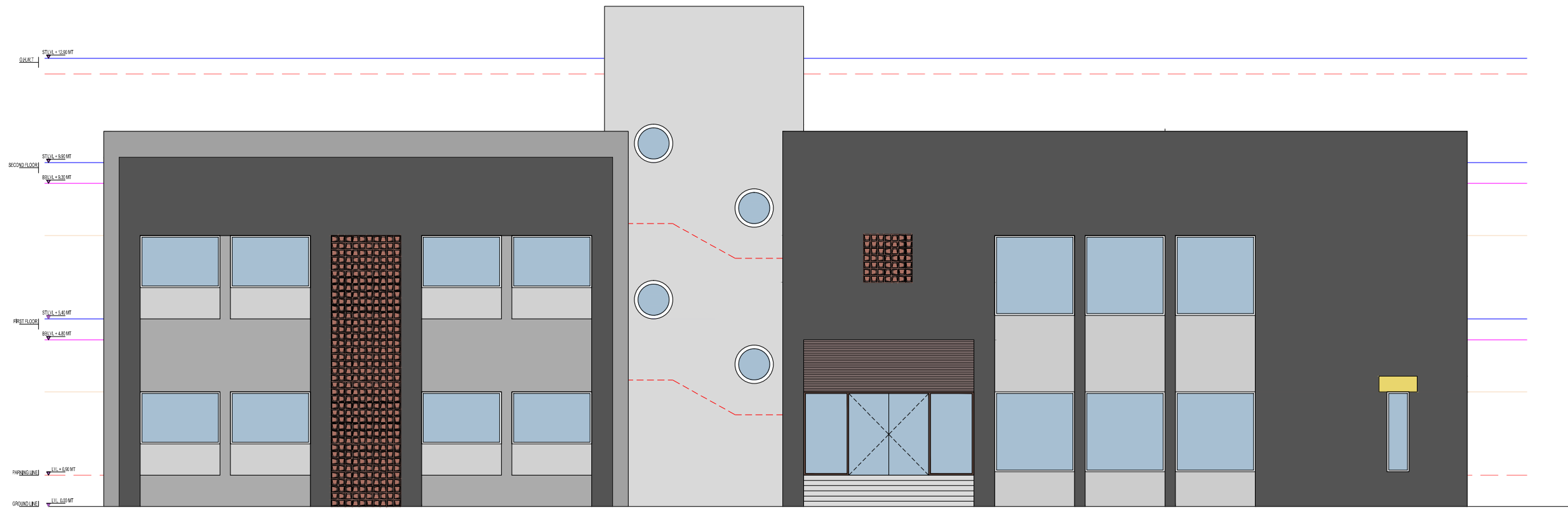

FRONT SIDE ELEVATION



LEFT SIDE ELEVATION

PROJECT NO.
BMC -03/gd
DRAWING NO.
A3-05

TITLE :-
ELEVATIONS

B.M.C.
PROPOSED NIGHT
SHELTER AT FULSAR T.P.
SCHEME, BHAVNAGAR FOR
BMC

DWG.DATE:-
31-03-2023

1) ALL DIMENSIONS ARE IN METERS. 2) ALL DIMENSIONS TO BE READ AND NOT MEASURED. 3) ALL DIMENSIONS ARE FROM UNFINISHED SURFACES. 4) ALL STRUCTURAL DRGS. TO BE READ SIMULTANEOUSLY WITH ARCHITECTURAL DRGS. 5) ALL DIMENSIONS TO BE VERIFIED BY THE CONTRACTOR AND ANY AMBIGUITY TO BE BROUGHT TO THE IMMEDIATE NOTICE OF THE ARCHITECT. 6) ALL INTERNAL WALLS, BEAMS, COLUMNS AND SLABS ARE FINISHED WITH 12.5MM THK. SMOOTH PLASTER UNLESS OTHERWISE SPECIFIED. 7) ALL EXTERNAL WALLS ARE FINISHED WITH 25MM. THK. SANDFACED PLASTER UNLESS OTHERWISE SPECIFIED. 8) ALL LEVELS ARE INDICATED CONSIDERING THE EDGE OF APPERTANT ROAD AS + 0000 LVL.

THESE DRAWINGS & DESIGNS ARE THE SOLE PROPERTY OF **AR. CHINTAN SACHAPARA** AND AS SUCH SHALL NOT BE REPRODUCED IN ANY FORM WITHOUT EXPRESSED WRITTEN PERMISSION OF **AR. CHINTAN SACHAPARA**. ALL DRAWINGS AND RELATED DOCUMENTS SHALL BE RETURNED TO **AR. CHINTAN SACHAPARA** UPON REQUEST.

IT IS THE RESPONSIBILITY OF THE CLIENT OR THE PROJECT MANAGEMENT COMPANY/ BMC'S ENGINEERS TO CHECK THE COORDINATION OF THE DRAWING WITH SITE BOUNDARIES. **AR. CHINTAN SACHAPARA** DO NOT HOLD ANY RESPONSIBILITIES IN CASE OF LEGAL CONFLICTS AND /OR MISHANDLED SITE COORDINATION.



CHINTAN SACHAPARA ARCHITECTS
ARCHITECTURE & INTERIOR DESIGN
+ 91 - 94 - 28 - 401 - 640
3, SHAHIBAUG, ABOVE HOMEDECOR,
WAGHAWADI ROAD, BHAVNAGAR.

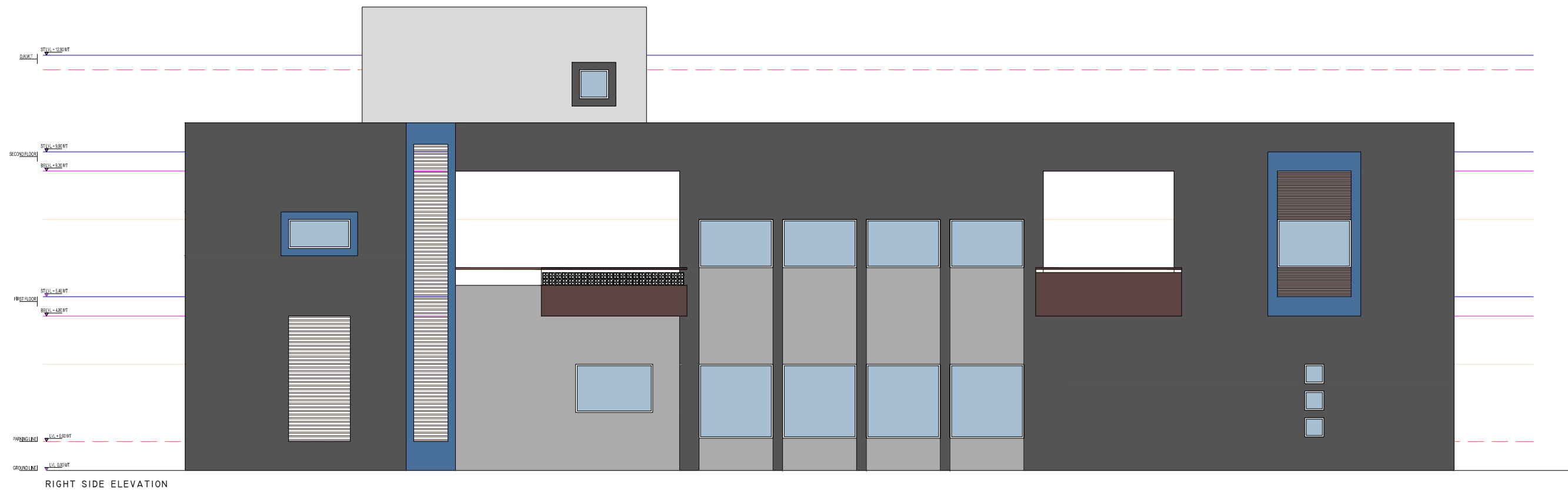

RIGHT SIDE ELEVATION

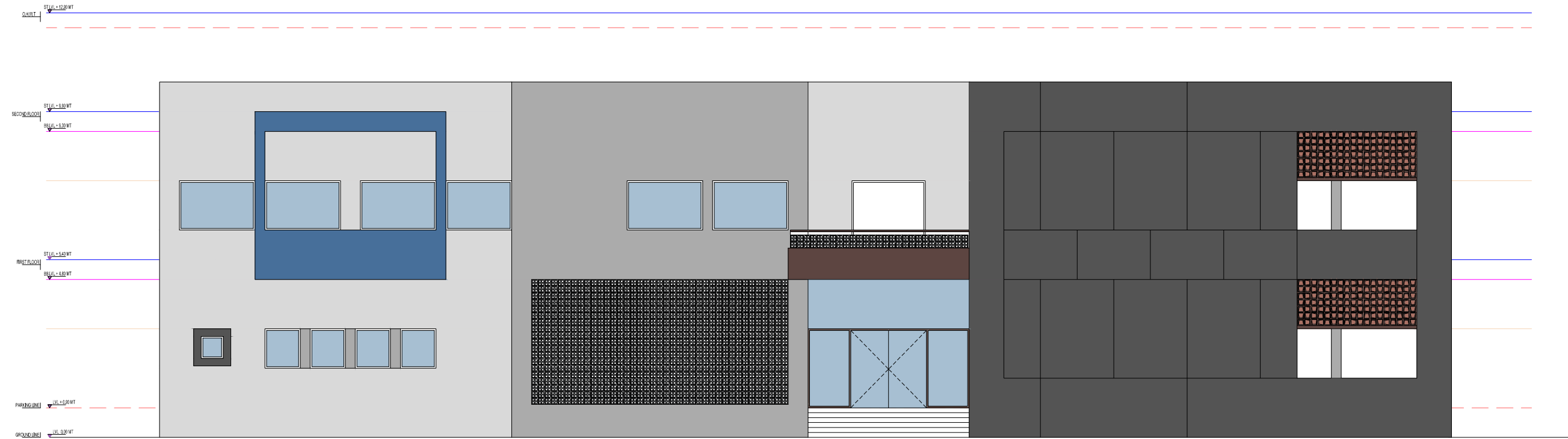

REAR SIDE ELEVATION

PROJECT NO. BMC -03/gd DRAWING NO. A3-06	TITLE :- ELEVATIONS	B.M.C. PROPOSED NIGHT SHELTER AT FULSAR T.P. SCHEME, BHAVNAGAR FOR BMC	DWG.DATE:- 31 -03 -2023	1) ALL DIMENSIONS ARE IN METERS. 2) ALL DIMENSIONS TO BE READ AND NOT MEASURED. 3) ALL DIMENSIONS ARE FROM UNFINISHED SURFACES. 4) ALL STRUCTURAL DRGS. TO BE READ SIMULTANEOUSLY WITH ARCHITECTURAL DRGS. 5) ALL DIMENSIONS TO BE VERIFIED BY THE CONTRACTOR AND ANY AMBIGUITY TO BE BROUGHT TO THE IMMEDIATE NOTICE OF THE ARCHITECT. 6) ALL INTERNAL WALLS, BEAMS, COLUMNS AND SLABS ARE FINISHED WITH 12.5MM THK. SMOOTH PLASTER UNLESS OTHERWISE SPECIFIED. 7) ALL EXTERNAL WALLS ARE FINISHD WITH 25MM. THK. SANDFACED PLASTER UNLESS OTHERWISE SPECIFIED. 8) ALL LEVELS ARE INDICATED CONSIDERING THE EDGE OF APPERTANT ROAD AS + 0000 LVL.	THESE DRAWINGS & DESIGNS ARE THE SOLE PROPERTY OF AR. CHINTAN SACHAPARA AND AS SUCH SHALL NOT BE REPRODUCED IN ANY FORM WITHOUT EXPRESSED WRITTEN PERMISSION OF AR. CHINTAN SACHAPARA . ALL DRAWINGS AND RELATED DOCUMENTS SHALL BE RETURNED TO AR. CHINTAN SACHAPARA UPON REQUEST.	IT IS THE RESPONSIBILITY OF THE CLIENT OR THE PROJECT MANAGEMENT COMPANY/ BMC'S ENGINEERS TO CHECK THE COORDINATION OF THE DRAWING WITH SITE BOUNDARIES. AR. CHINTAN SACHAPARA DO NOT HOLD ANY RESPONSIBILITIES IN CASE OF LEGAL CONFLICTS AND /OR MISHANDLED SITE C O O R D I N A T I O N .	 CHINTAN SACHAPARA ARCHITECTS ARCHITECTURE & INTERIOR DESIGN + 9 1 - 9 4 - 2 8 - 4 0 1 - 6 4 0 3, SHAHIBAUG, ABOVE HOMEDECOR, WAGHAWADI ROAD, BHAVNAGAR.
---	-----------------------------------	--	----------------------------	--	--	---	--

ELECTRICAL LEGEND FOR GROUND FLOOR

SYMBOL	DESCRIPTION	HEIGHT(M) FOR FFL
	18W RECESSED MOUNTED LED DOWN LIGHT	IN CEILING
	18W SURFACE MOUNTED LED DOWN LIGHT	IN CEILING
	20W RECESSED MOUNTED LED DOWN LIGHT	IN CEILING
	10W BRACKET LIGHT POINT	2.1 mmm
	1200mm DIA CEILING FANT	IN CEILING
	EXHAUST FAN	IN WINDOW
	5A SOCKET OUTLET FOR EXHAUST FAN	NEAR WINDOW
	SWITCH BOARD WITH 5A SOCKET (SB)	0.9 m
	SWITCH BOARD WITHOUT 5A SOCKET (SB)	0.9 m
	5A SWITCH SOCKET OUTLET (P)	0.9 m
	15A SWITCH SOCKET OUTLET (PP)	0.9 m
	5/15A PROJECTOR SOCKET (ON UPS POWER)	IN CEILING
	AC SOCKET - 15A SWITCH SOCKET OUTLET	2.6 m
	3 PHASE INDUSTRIAL TYPE SOCKET 200mm(W)x200mm(H)x100mm(D) HENSEL CAT. REF. - 6000101	1.2 m
	COMPUTER DATA POINT	0.9 m
	TELEPHONE POINT	0.9 m
	LIGHTING DISTRIBUTION BOARD (LDB)	1.5 m
	CAMERA POINT	BB

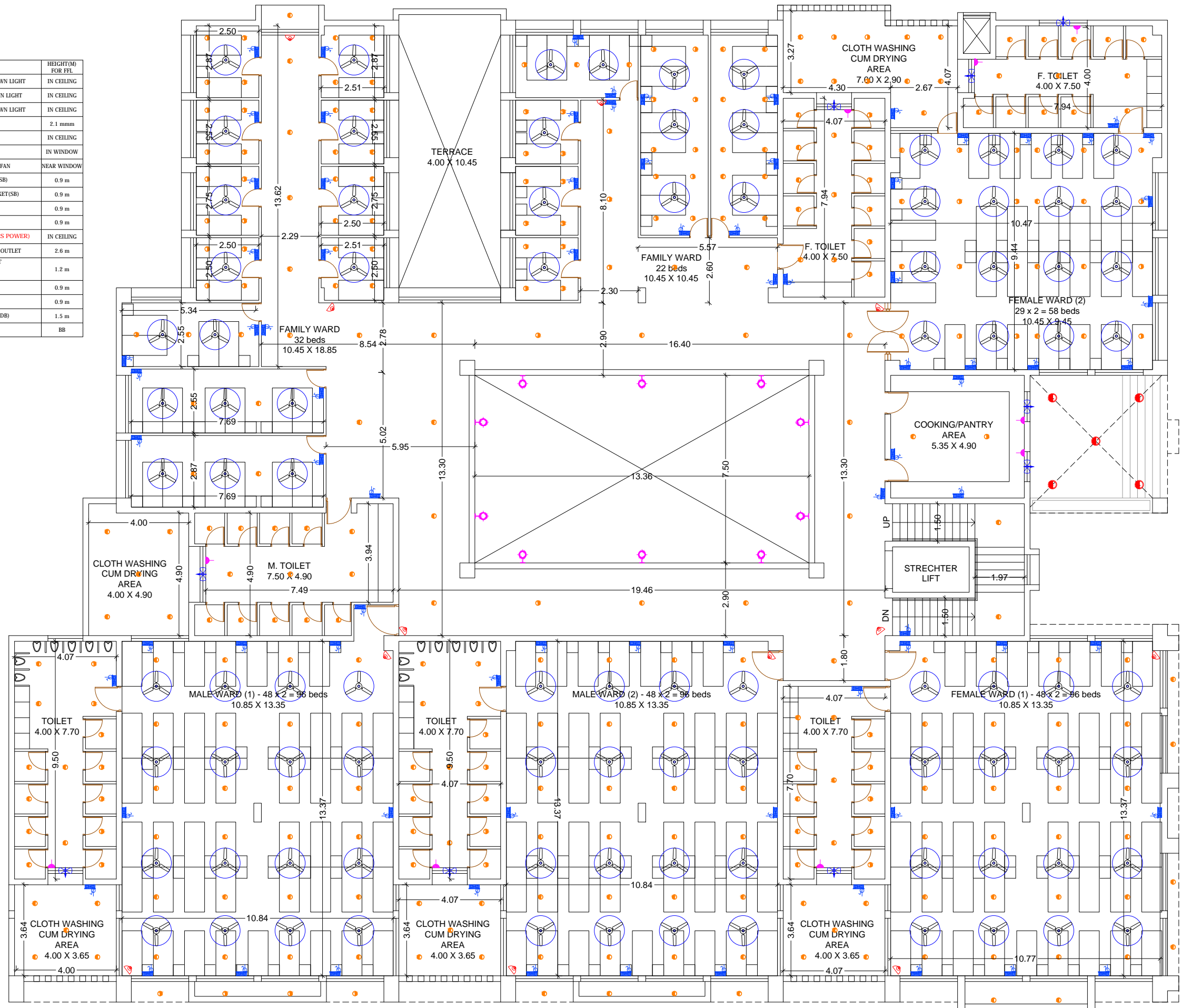

FIRST FLOOR PLAN

RIGHT SIDE

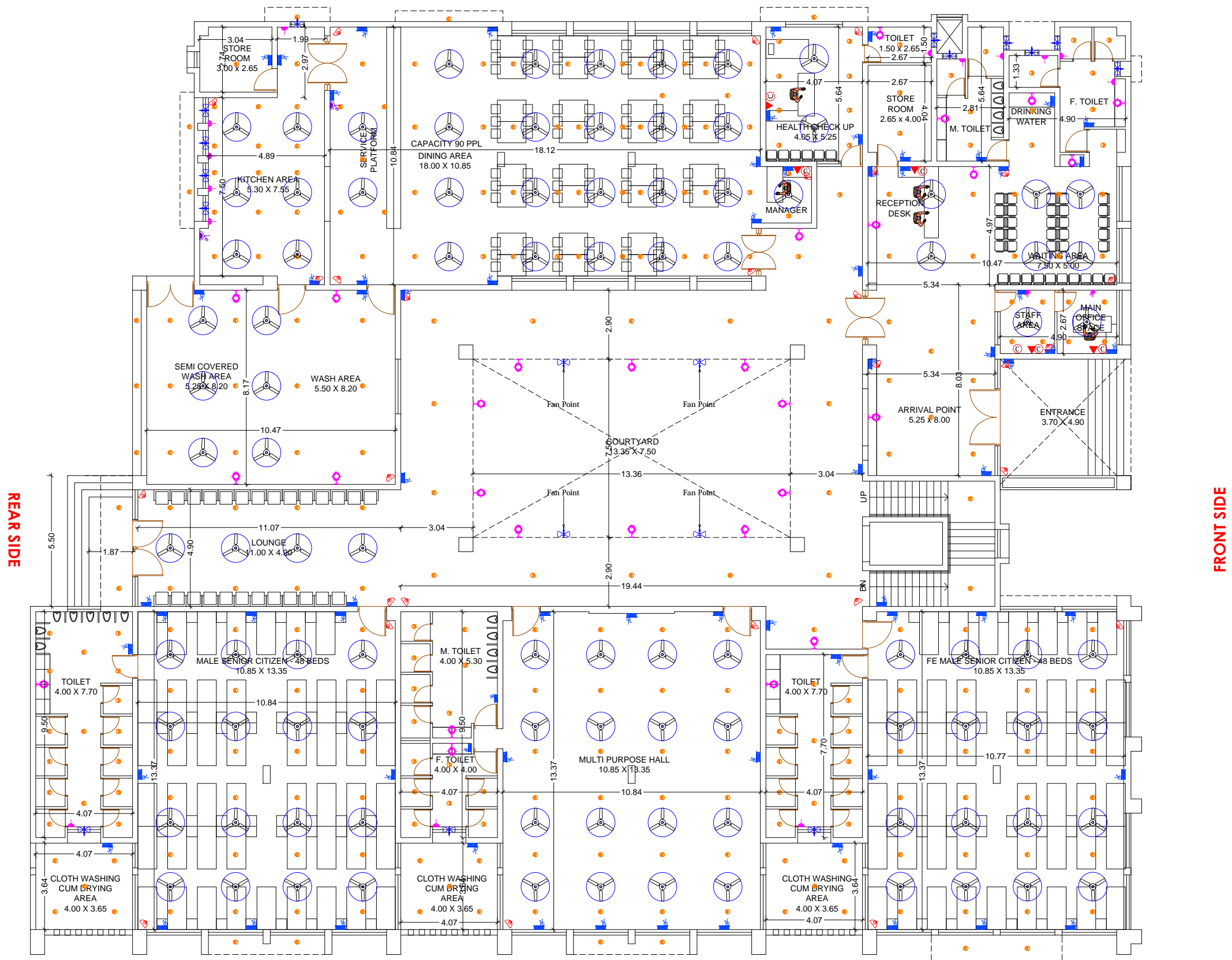

REAR SIDE

FRONT SIDE

GROUND FLOOR PLAN

main lt panel

1500

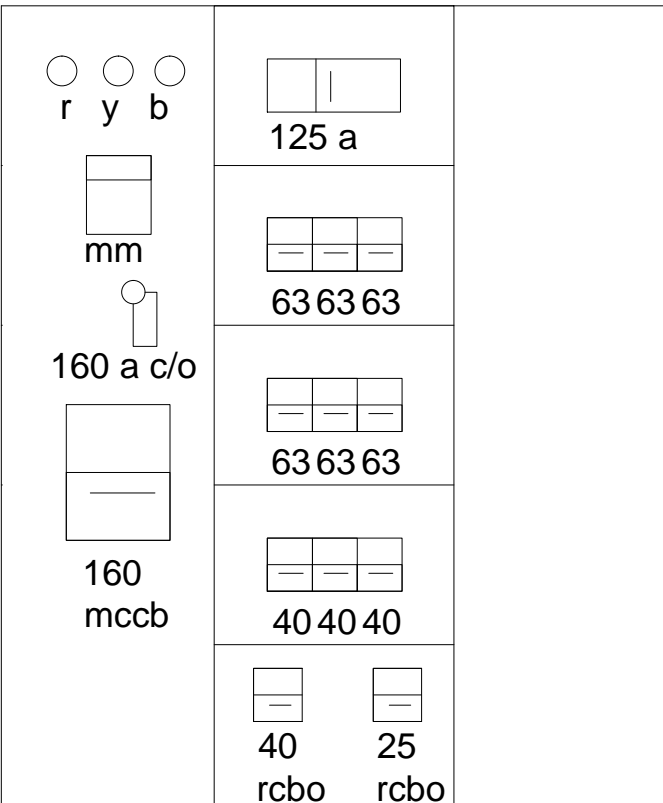

300

- 160 a mccb
- 160 a c/o incommer
- 125a mccb fire panel
- 63a mcb gf/ ff dbs
- 40a street light
- 40a security
- 40a spare
- 40 rcbo lift
- 25 rcbo lift lighting



900

PANEL SPECIFICATION

out of 16 swg crcasheet duly powder coated 85 microns duly painted siemence
grey colour ral 7032 cubical type dust and vermin proof, bottom entry, front
operated, with 400 mm angle stand and provision of gland plate size @
1500x900x300 mm

incommer

160a 3p 36ka mccb with

4p 160a c/o on load switch

multimediameter, ryb lamp

out going

125a 3p 36ka mccb 1 no

63a 4p 10ka tp mcb 3 nos

63a 4p 10ka tp mcb 3 nos

40a 4p mcb 10ka 3 nos

40a 4p rcbo 1nos

25a 2p rcbo 1 nos

Switch gear

multimediameter

wire

lugs

conductor

c/o switch

connector

lamp

scheinder make

conserve, schneider

isi rr/ finolex

dowells

elmax

hpl make

connect well/ elmax

led schneider

sld

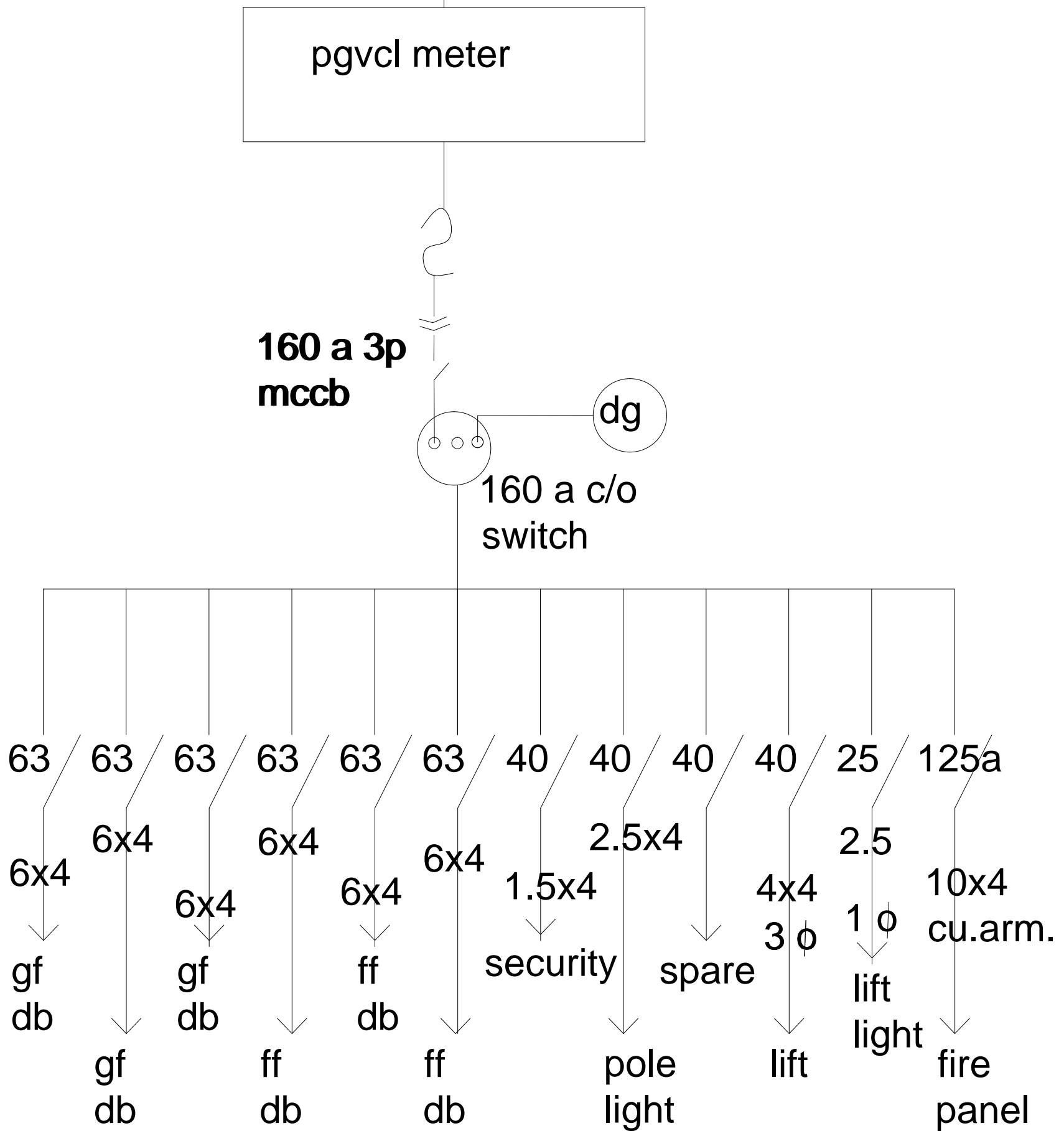

note:-

- pgvcl meter to panel cable not counted as length is not finalised.
- camera and its accessories not counted. wiring provision done.
- nvr location in office.
- main It panel and dg location in electrical room.
- fire panel location b/h building, near child play area.
- ckt distribution from db as per measurement sheets. no change allow.

Material Specification		
Sr. no	Item	Specification
1	PVC Pipe & it's accessories	ISI Precision Vraj, Nihir
2	PVC Wire/Cable	Finolex/RR/KEI
3	Switch & it's accessories	Schneider/Legrand/havells
4	DB/MCB/Reeb	hager/Schneider/Legrand
5	Ceilling Fan	Crompton/Havell's/USHA
6	Exhaust Fan	Crompton/Havell's/USHA
7	LED Flood Light	Crompton/Havell's/philips
8	ac	mitsubishi/ ogeneral
9	water cooler	usha/ bluestar/ lyod
10	lugs	dowells
11	glands	hmi/ cable grip
12	dgset	kirlosker/ cummins/ mahindra
NOTE : All LIGHTING FIXTURES MUST BE APPROVED BY ARCHITECT/ bmc before proceding materials (MAKE, MODEL,		

load calculation					
no	item	qty	watt	total watt	
1	led lights	645	20	12900	
2	ceilling fans	188	60	11280	
3	ex. Fans	25	40	1000	
4	kitchen equipments	1s	5000	5000	
5	a/c	2	1800	3600	
6	lift	1	3700	3700	
7	water cooler	2	500	1000	
8	o/s lights	14	40	560	
9	fire pump	1	20000	20000	
			total	59040	watt
			say	60 kw	
			pgvcl demand	40 kw	
			d.g. set	62.5 kw	

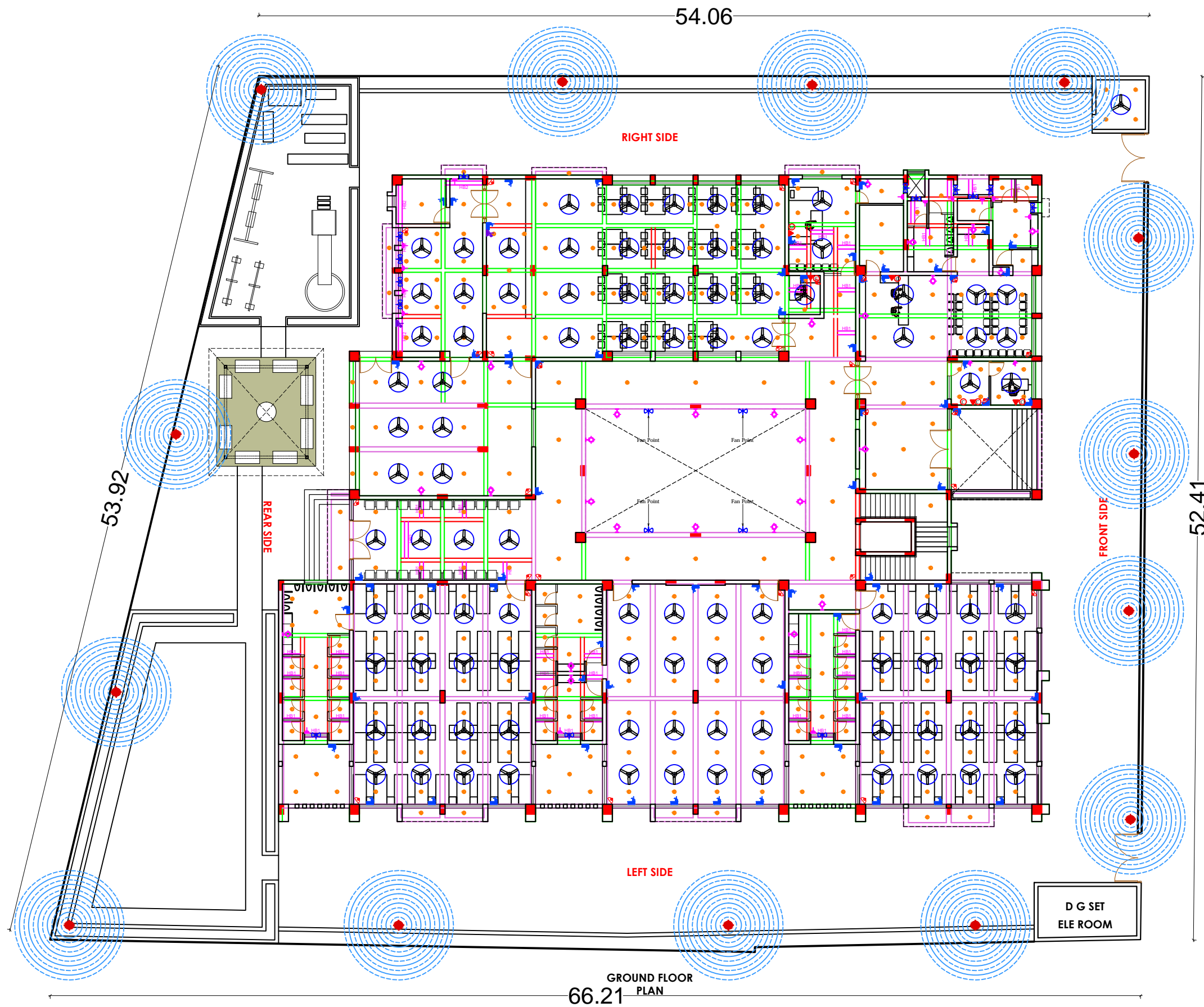

FIRE FIGHTING LEGENDS	
LEGEND	DESCRIPTION
	FIRE HOSE REEL (WITH 30M HOSE)
	HOSE BOX SINGLE DOOR (WITH 15M CANVAS HOSE)
	Four Way
	Fire Hydrant
	PENDENT TYPE SPRINKLER
	25 NB SPRINKLER PIPE
	50 NB SPRINKLER PIPE
	80 NB SPRINKLER PIPE
	100 NB HYDRANT PIPE
	SMOKE DETECTOR
	ABC TYPE FIRE EXTINGUISHER
MP	MAIN FIRE PUMP
CP	CONTROL PANEL FOR PUMP

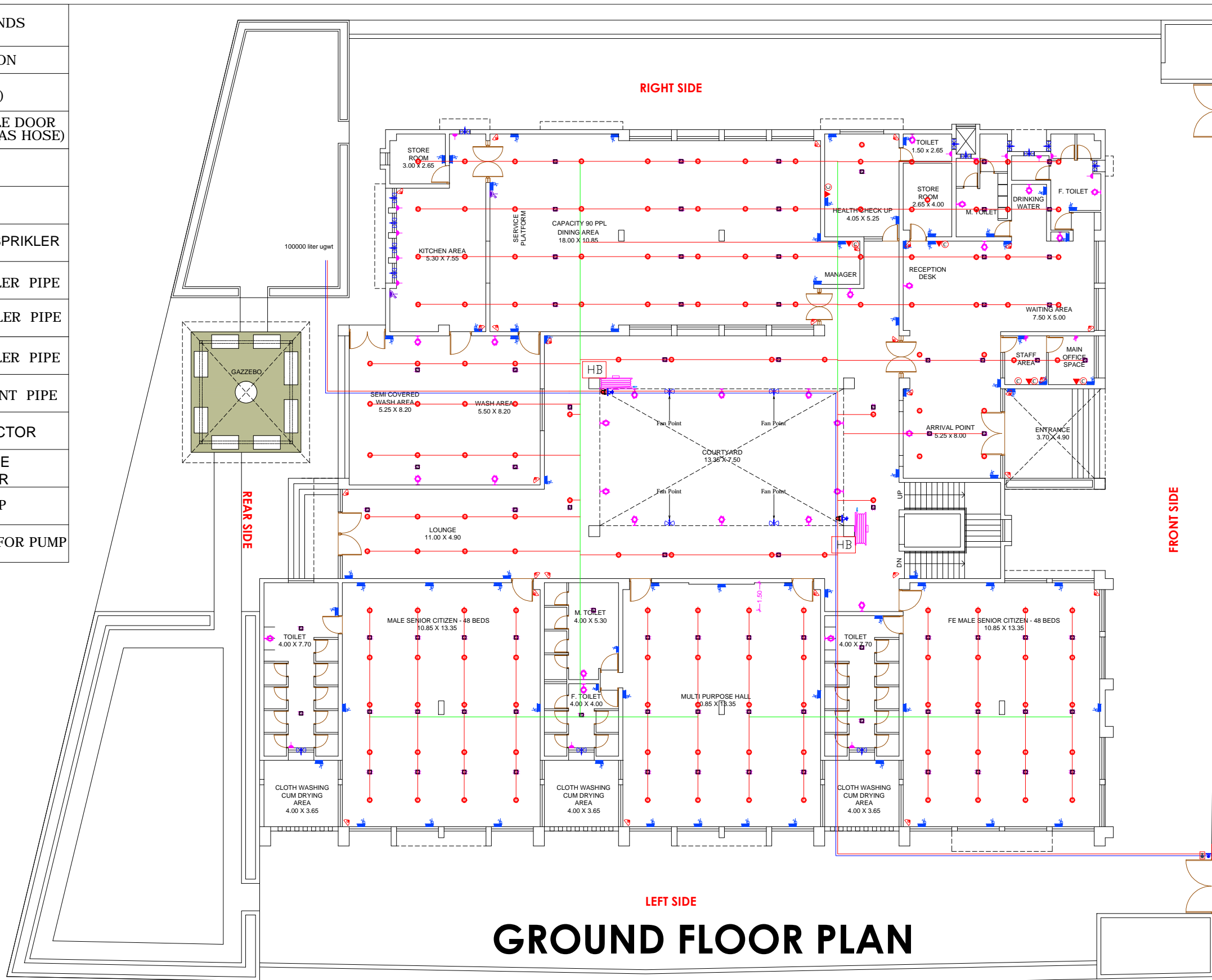

GROUND FLOOR PLAN

PROJECT NO.
BMC -03/gd

DRAWING NO.
A3-02

TITLE :-
GROUND FLOOR PLAN

B.M.C.

PROPOSED NIGHT SHELTER AT FULSAR T.P. SCHEME, BHAVNAGAR FOR BMC

DWG.DATE:-
31-03-2023

1) ALL DIMENSIONS ARE IN METERS. 2) ALL DIMENSIONS TO BE READ AND NOT MEASURED. 3) ALL DIMENSIONS ARE FROM UNFINISHED SURFACES. 4) ALL STRUCTURAL DRGS. TO BE READ SIMULTANEOUSLY WITH ARCHITECTURAL DRGS. 5) ALL DIMENSIONS TO BE VERIFIED BY THE CONTRACTOR AND ANY AMBIGUITY TO BE BROUGHT TO THE IMMEDIATE NOTICE OF THE ARCHITECT. 6) ALL INTERNAL WALLS, BEAMS, COLUMNS AND SLABS ARE FINISHED WITH 12.5MM THK. SMOOTH PLASTER UNLESS OTHERWISE SPECIFIED. 7) ALL EXTERNAL WALLS ARE FINISHED WITH 25MM. THK. SANDFACED PLASTER UNLESS OTHERWISE SPECIFIED. 8) ALL LEVELS ARE INDICATED CONSIDERING THE EDGE OF APPERTANT ROAD AS + 0000 LVL.

THESE DRAWINGS & DESIGNS ARE THE SOLE PROPERTY OF **AR. CHINTAN SACHAPARA** AND AS SUCH SHALL NOT BE REPRODUCED IN ANY FORM WITHOUT EXPRESSED WRITTEN PERMISSION OF **AR. CHINTAN SACHAPARA**. ALL DRAWINGS AND RELATED DOCUMENTS SHALL BE RETURNED TO **AR. CHINTAN SACHAPARA** UPON REQUEST.

IT IS THE RESPONSIBILITY OF THE CLIENT OR THE PROJECT MANAGEMENT COMPANY/ BMC'S ENGINEERS TO CHECK THE COORDINATION OF THE DRAWING WITH SITE BOUNDARIES. **AR. CHINTAN SACHAPARA** DO NOT HOLD ANY RESPONSIBILITIES IN CASE OF LEGAL CONFLICTS AND /OR MISHANDLED SITE COORDINATION.

CHINTAN SACHAPARA ARCHITECTS
ARCHITECTURE & INTERIOR DESIGN
+ 91 - 94 - 28 - 401 - 640
3, SHAHIBAUG, ABOVE HOMEDECOR,
WAGHAWADI ROAD, BHAVNAGAR.

FIRE FIGHTING LEGENDS	
LEGEND	DESCRIPTION
	FIRE HOSE REEL (WITH 30M HOSE)
	HOSE BOX SINGLE DOOR (WITH 15M CANVAS HOSE)
	Four Way
	Fire Hydrant
	PENDENT TYPE SPRINKLER
	25 NB SPRINKLER PIPE
	50 NB SPRINKLER PIPE
	80 NB SPRINKLER PIPE
	100 NB HYDRANT PIPE
	SMOKE DETECTOR
	ABC TYPE FIRE EXTINGUISHER
MP	MAIN FIRE PUMP
CP	CONTROL PANEL FOR PUMP

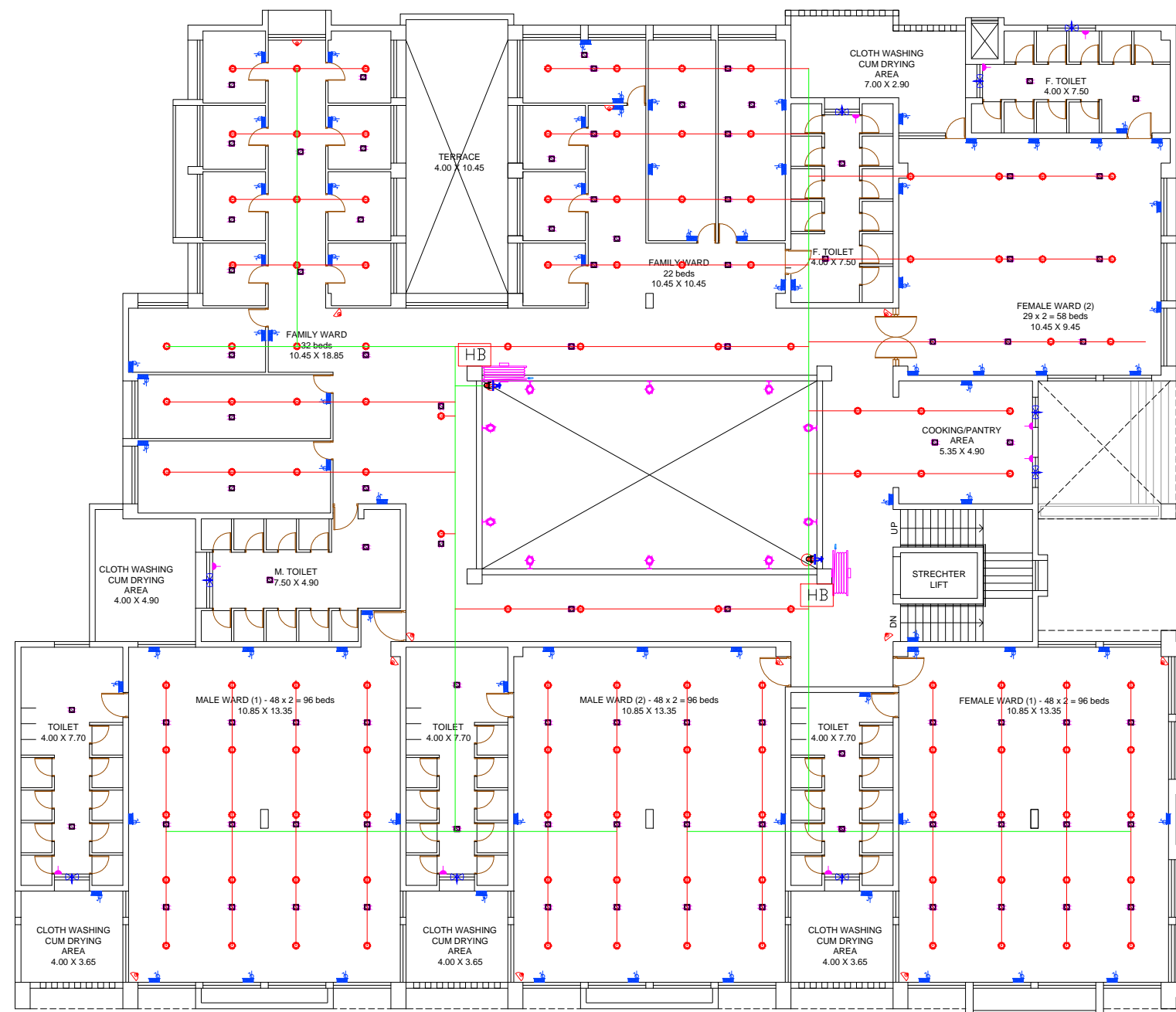

FIRST FLOOR PLAN

PROJECT NO. BMC -03/gd	TITLE :- GROUND FLOOR PLAN	B.M.C. PROPOSED NIGHT SHELTER AT FULSAR T.P. SCHEME, BHAVNAGAR FOR BMC	DWG.DATE:- 31-03-2023		1) ALL DIMENSIONS ARE IN METERS. 2) ALL DIMENSIONS TO BE READ AND NOT MEASURED. 3) ALL DIMENSIONS ARE FROM UNFINISHED SURFACES. 4) ALL STRUCTURAL DRGS. TO BE READ SIMULTANEOUSLY WITH ARCHITECTURAL DRGS. 5) ALL DIMENSIONS TO BE VERIFIED BY THE CONTRACTOR AND ANY AMBIGUITY TO BE BROUGHT TO THE IMMEDIATE NOTICE OF THE ARCHITECT. 6) ALL INTERNAL WALLS, BEAMS, COLUMNS AND SLABS ARE FINISHED WITH 12.5MM THK. SMOOTH PLASTER UNLESS OTHERWISE SPECIFIED. 7) ALL EXTERNAL WALLS ARE FINISHED WITH 25MM. THK. SANDFACED PLASTER UNLESS OTHERWISE SPECIFIED. 8) ALL LEVELS ARE INDICATED CONSIDERING THE EDGE OF APPERTANT ROAD AS + 0000 LVL.	THESE DRAWINGS & DESIGNS ARE THE SOLE PROPERTY OF AR. CHINTAN SACHAPARA AND AS SUCH SHALL NOT BE REPRODUCED IN ANY FORM WITHOUT EXPRESSED WRITTEN PERMISSION OF AR. CHINTAN SACHAPARA . ALL DRAWINGS AND RELATED DOCUMENTS SHALL BE RETURNED TO AR. CHINTAN SACHAPARA UPON REQUEST.	IT IS THE RESPONSIBILITY OF THE CLIENT OR THE PROJECT MANAGEMENT COMPANY/ BMC'S ENGINEERS TO CHECK THE COORDINATION OF THE DRAWING WITH SITE BOUNDARIES. AR. CHINTAN SACHAPARA DO NOT HOLD ANY RESPONSIBILITIES IN CASE OF LEGAL CONFLICTS AND /OR MISHANDLED SITE COORDINATION.	 CHINTAN SACHAPARA ARCHITECTS ARCHITECTURE & INTERIOR DESIGN + 91 - 94 - 28 - 401 - 6403, SHAHIBAUG, ABOVE HOMEDECOR, WAGHAWADI ROAD, BHAVNAGAR.
----------------------------------	--------------------------------------	---	--------------------------	--	---	--	---	--

FIRST FLOOR PLAN

BEDS CAPACITY AT F.F. LEVEL					
Ward	Bed No.	Bath	WC	Urinal	Basin
Male Ward (1)	96	04	05	07	04
Male Ward (2)	96	04	05	07	04
Female Ward (1)	96	04	05		04
Female Ward (2)	58	04	05		04
Family Ward	54	09	10		08
Total	400	21	30	14	20

	Bed No.	Bath	WC	Urinal	Basin
GROUND LEVEL	96	12	15	11	12
FIRST LEVEL	400	21	30	14	20
TOTAL	496	33	45	25	32

DOOR WINDOW SCHEDULE

WINDOW	Size
W1	2.30 x 2.40
W2	1.00 x 2.40
W3	0.60 x 0.60
W4	1.20 x 1.20
W5	0.65 x 2.40
V1	1.40 x 0.60
V2	0.6 x 0.90
V3	1.20 x 0.60
D/W	1.40 x 2.40
D/W 1	2.25 x 2.40
D/W 2	2.65 x 2.40

DOOR	Size
D1	2.40 x 2.40
D2	2.00 x 2.40
D3	1.80 x 2.40
D4	0.90 x 2.40
D5	0.75 x 2.40
D6	1.20 x 2.40
D7	1.00 x 2.40
D8	1.50 x 2.40

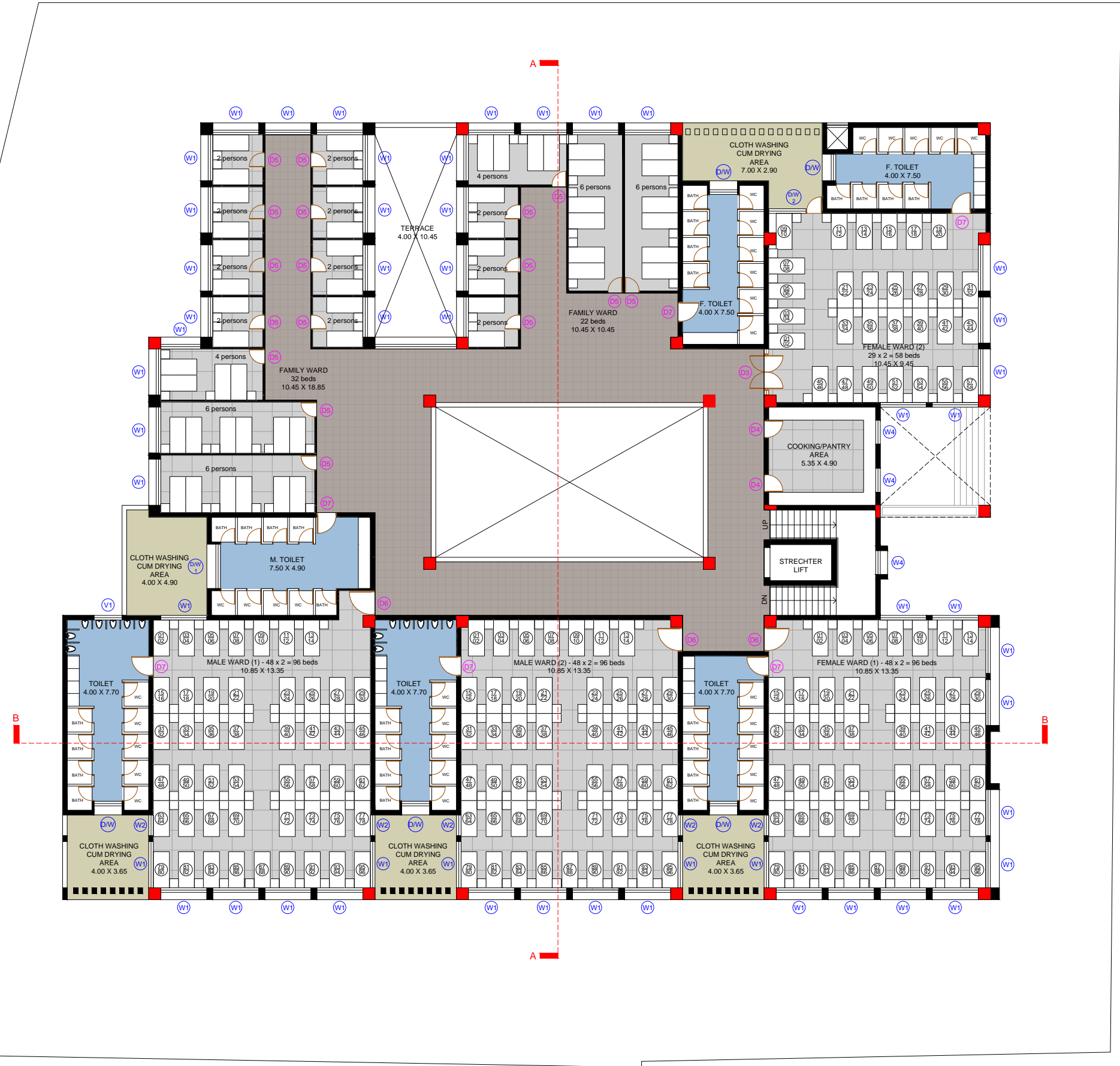

PROJECT NO. BMC -03/gd	TITLE :- FIRST FLOOR PLAN	B.M.C. PROPOSED NIGHT SHELTER AT FULSAR T.P. SCHEME, BHAVNAGAR FOR BMC	DWG. DATE:- 31-03-2023		1) ALL DIMENSIONS ARE IN METERS. 2) ALL DIMENSIONS TO BE READ AND NOT MEASURED. 3) ALL DIMENSIONS ARE FROM UNFINISHED SURFACES. 4) ALL STRUCTURAL DRGS. TO BE READ SIMULTANEOUSLY WITH ARCHITECTURAL DRGS. 5) ALL DIMENSIONS TO BE VERIFIED BY THE CONTRACTOR AND ANY AMBIGUITY TO BE BROUGHT TO THE IMMEDIATE NOTICE OF THE ARCHITECT. 6) ALL INTERNAL WALLS, BEAMS, COLUMNS AND SLABS ARE FINISHED WITH 12.5MM THK. SMOOTH PLASTER UNLESS OTHERWISE SPECIFIED. 7) ALL EXTERNAL WALLS ARE FINISHED WITH 25MM. THK. SANDFACED PLASTER UNLESS OTHERWISE SPECIFIED. 8) ALL LEVELS ARE INDICATED CONSIDERING THE EDGE OF APPERTANT ROAD AS + 0000 LVL.	THESE DRAWINGS & DESIGNS ARE THE SOLE PROPERTY OF AR. CHINTAN SACHAPARA AND AS SUCH SHALL NOT BE REPRODUCED IN ANY FORM WITHOUT EXPRESSED WRITTEN PERMISSION OF AR. CHINTAN SACHAPARA . ALL DRAWINGS AND RELATED DOCUMENTS SHALL BE RETURNED TO AR. CHINTAN SACHAPARA UPON REQUEST.	IT IS THE RESPONSIBILITY OF THE CLIENT OR THE PROJECT MANAGEMENT COMPANY/ BMC'S ENGINEERS TO CHECK THE COORDINATION OF THE DRAWING WITH SITE BOUNDARIES. AR. CHINTAN SACHAPARA DO NOT HOLD ANY RESPONSIBILITIES IN CASE OF LEGAL CONFLICTS AND/OR MISHANDLED SITE COORDINATION.	 CHINTAN SACHAPARA ARCHITECTS ARCHITECTURE & INTERIOR DESIGN + 91 - 94 - 28 - 401 - 640 3, SHAHIBAUG, ABOVE HOMEDECOR, WAGHAWADI ROAD, BHAVNAGAR.
----------------------------------	-------------------------------------	--	---------------------------	--	---	--	--	---

GROUND FLOOR PLAN

BEDS CAPACITY AT G.F. LEVEL

Ward	Bed No.	Bath	WC	Urinal	Basin
Male Senior Citizen Ward	48	04	05	07	04
Female Senior Citizen Ward	48	04	05		04
Multi Purpose		04	05	04	04
Total	96	12	15	11	12

BUILT UP AREA CALCULATION

Area	Sq Mtr
Plot Area	3173 smt
Ground Floor Plan	1513 smt
First Floor Plan	1475 smt
Terrace Floor Plan	53 smt
Total Area	3041 smt

DOOR WINDOW SCHEDULE

WINDOW	Size
W1	2.30 x 2.40
W2	1.00 x 2.40
W3	0.60 x 0.60
W4	1.20 x 1.20
W5	0.65 x 2.40
V1	1.40 x 0.60
V2	0.6 x 0.90
V3	1.20 x 0.60
D/W	1.40 x 2.40
D/W 1	2.25 x 2.40
D/W 2	2.65 x 2.40

DOOR	Size
D1	2.40 x 2.40
D2	2.00 x 2.40
D3	1.80 x 2.40
D4	0.90 x 2.40
D5	0.75 x 2.40
D6	1.20 x 2.40
D7	1.00 x 2.40
D8	1.50 x 2.40



PROJECT NO.
BMC -03/gd
DRAWING NO.
A3-02

TITLE :-
GROUND FLOOR PLAN

B.M.C.
PROPOSED NIGHT SHELTER AT FULSAR T.P. SCHEME, BHAVNAGAR FOR BMC

DWG.DATE:-
31-03-2023

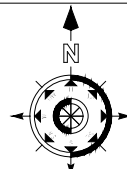

1) ALL DIMENSIONS ARE IN METERS. 2) ALL DIMENSIONS TO BE READ AND NOT MEASURED. 3) ALL DIMENSIONS ARE FROM UNFINISHED SURFACES. 4) ALL STRUCTURAL DRGS. TO BE READ SIMULTANEOUSLY WITH ARCHITECTURAL DRGS. 5) ALL DIMENSIONS TO BE VERIFIED BY THE CONTRACTOR AND ANY AMBIGUITY TO BE BROUGHT TO THE IMMEDIATE NOTICE OF THE ARCHITECT. 6) ALL INTERNAL WALLS, BEAMS, COLUMNS AND SLABS ARE FINISHED WITH 12.5MM THK. SMOOTH PLASTER UNLESS OTHERWISE SPECIFIED. 7) ALL EXTERNAL WALLS ARE FINISH WITH 25MM. THK. SANDFACED PLASTER UNLESS OTHERWISE SPECIFIED. 8) ALL LEVELS ARE INDICATED CONSIDERING THE EDGE OF APPERTANT ROAD AS + 0000 LVL.

THESE DRAWINGS & DESIGNS ARE THE SOLE PROPERTY OF **AR. CHINTAN SACHAPARA** AND AS SUCH SHALL NOT BE REPRODUCED IN ANY FORM WITHOUT EXPRESSED WRITTEN PERMISSION OF **AR. CHINTAN SACHAPARA**. ALL DRAWINGS AND RELATED DOCUMENTS SHALL BE RETURNED TO **AR. CHINTAN SACHAPARA** UPON REQUEST.

IT IS THE RESPONSIBILITY OF THE CLIENT OR THE PROJECT MANAGEMENT COMPANY/ BMC'S ENGINEERS TO CHECK THE COORDINATION OF THE DRAWING WITH SITE BOUNDARIES. **AR. CHINTAN SACHAPARA** DO NOT HOLD ANY RESPONSIBILITIES IN CASE OF LEGAL CONFLICTS AND/OR MISHANDLED SITE COORDINATION.

CHINTAN SACHAPARA ARCHITECTS
ARCHITECTURE & INTERIOR DESIGN
+ 91 - 94 - 28 - 401 - 640
3, SHAHIBAUG, ABOVE HOMEDECOR, WAGHAWADI ROAD, BHAVNAGAR.

TENDER SHEET

**PROPOSED DEVELOPMENT OF NIGHT SHELTER AT FULSAR, FOR BHAVNAGAR MUNICIPAL CORPORATION
(B.M.C), BHAVANAGAR**

(CIVIL WORK & PLUMBING, SANITARY+ELECTRICAL WORKS)+FURNITURE+ELEVATOR+FIRE+GYM EQUIPMENTS

// BILL OF QUANTITY //

It	Description	Qty	Rate	Per	Amount
1	Clearing and grubbing road land including uprooting rank vegetation grass bushes,shrubs,sapling and trees girth up to 300 mm removal of stumps of trees cut earlier and disposal of unserviceable materials (C) By mechanical means in area of light jungle	0.32	28111.92	Hectare	8995.81
2	Excavation for foundation upto1.50 MT depth including sorting out and stacking of useful materials and disposing the excavated stuff up to all leads (A) loose or Soft Soil	3518.84	243.92	Cum	858315.45
3	Excavation for foundation upto1.50 MT depth including sorting out and stacking of useful materials and disposing the excavated stuff up to all leads (B) Dense or Hard Soil	2899.19	276.19	Cum	800727.29
4	Excavation for foundation for depth from 1.5 m to 3.0 m including sorting out and stacking of useful materials and disposing off the excavated stuff upto 50 Meter lead. (B) Dense or Hard soil	2611.80	288.77	Cum	754209.49
5	Excavation for foundation for depth from 1.5 m to 3.0 m including sorting out and stacking of useful materials and disposing off the excavated stuff upto 50 Meter lead. (C) Hard Murrum	2374.23	398.83	Cum	946914.15
6	Excavation for foundation for depth from 3.00 m to 6.0 m including sorting out and stacking of useful materials and disposing off the excavated stuff upto 50 Meter lead. (C) Hard Murrum	3299.92	439.65	Cum	1450809.83
7	Dewatering In all sorts of soil and soft murrum,hard murrum and bulders, soft rock, hard rock up to 1.50 mt depth from G.L.	4748.46	17.00	Cum	80723.82

8	Extra for dewatering in all sorts of strata's for each 1.50 mt or part thereof beyond 1.50 mt depth.	4748.46	10.00	Cum	47484.60
9	Boring holes 4.50 m deep in ordinary soil (for cast in situ piles) and getting out the soil and disposal of the surplus excavated soil as directed within a lead of 50 Meter for following diameter of pipes.(iii) 300 mm	40	1,997.56	EA	79902.40
10	Extra for under reaming inside the bore holes for under reamed piles of following diameter .(iii) 300 mm	40	626.18	EA	25047.20
11	Filling in foundation and plinth with murrum or selected soil in layers of 20 cm. Thickness including watering ramming and consolidating etc. comp.	12780.11	286.20	Cum	3657667.48
12	Filling available excavated earth (excluding rock) intrenches. plinth, sides of foundations etc. in layers not exceeding 20 cm. in depth consolidating each disposedv layer by ramming and watering.	13519.20	129.10	Cum	1745328.72
13	Providing and laying in position Ready Mixed M-150 grade concrete for reinforced cement conctere work , using cement content as per approved Design Mix manufactured in fully automatic batching plant and transported to site of work in transit mixer for a lead up to 10 kms having continuous agitated mixer, manufactured as per mix design of specified grade for reinforced cement concrete work including pumping of R.M.C. from transit mixer to site of laying, including the cost of centering shuttering finishing and excluding the cost of reinforcement including cost of admixtures in recommended proportions as per IS: 9103 to accelerate/retard setting of concrete, improve workability without impairing strength and durability as per direction of the Engineer - in - charge. Without Fly Ash (Min cement level as per latest IS 456 shall be maintained)	657.63	4281.00	Cum	2815314.03

14	<p>Providing and laying in position Ready Mixed M-300 grade concrete for reinforced cement concrete work , using cement content as per approved Design Mix manufactured in fully automatic batching plant and transported to site of work in transit mixer for a lead up to 10 kms having continuous agitated mixer, manufactured as per mix design of specified grade for reinforced cement concrete work including pumping of R.M.C. from transit mixer to site of laying, including the cost of centering shuttering finishing and excluding the cost of reinforcement including cost of admixtures in recommended proportions as per IS: 9103 to accelerate/ retard setting of concrete, improve workability without impairing strength and durability as per direction of the Engineer - in - charge. Without Fly Ash (Min cement level as per latest IS 456 shall be maintained) (Cement level 475kg)</p> <p>for R.C.C.piles 230/300</p>	17.6	5,043.66	cum	88768.42
15	<p>Providing and laying in position Ready Mixed M-300 grade concrete for reinforced cement concrete work , using cement content as per approved Design Mix manufactured in fully automatic batching plant and transported to site of work in transit mixer for a lead up to 10 kms having continuous agitated mixer, manufactured as per mix design of specified grade for reinforced cement concrete work including pumping of R.M.C. from transit mixer to site of laying, including the cost of centering shuttering finishing and excluding the cost of reinforcement including cost of admixtures in recommended proportions as per IS: 9103 to accelerate/ retard setting of concrete, improve workability without impairing strength and durability as per direction of the Engineer - in - charge. Without Fly Ash (Min cement level as per latest IS 456 shall be maintained) (Cement level 475kg):</p> <p>R.C.C Pile Cap</p>	3.65	5534.00	Cum	20199.10

16	<p>Providing and laying in position Ready Mixed M-300 grade concrete for reinforced cement concrete work , using cement content as per approved Design Mix manufactured in fully automatic batching plant and transported to site of work in transit mixer for a lead up to 10 kms having continuous agitated mixer, manufactured as per mix design of specified grade for reinforced cement concrete work including pumping of R.M.C. from transit mixer to site of laying, including the cost of centering shuttering finishing and excluding the cost of reinforcement including cost of admixtures in recommended proportions as per IS: 9103 to accelerate/ retard setting of concrete, improve workability without impairing strength and durability as per direction of the Engineer - in - charge. Without Fly Ash (Min cement level as per latest IS 456 shall be maintained) (Cement level 475 kg)</p> <p>(a) Foundations, footings Bases of columns</p>	683.96			
17	<p>Providing and laying in position Ready Mixed M-250 grade concrete for reinforced cement concrete work , using cement content as per approved Design Mix manufactured in fully automatic batching plant and transported to site of work in transit mixer for a lead up to 10 kms having continuous agitated mixer, manufactured as per mix design of specified grade for reinforced cement concrete work including pumping of R.M.C. from transit mixer to site of laying, including the cost of centering shuttering finishing and excluding the cost of reinforcement including cost of admixtures in recommended proportions as per IS: 9103 to accelerate/ retard setting of concrete, improve workability without impairing strength and durability as per direction of the Engineer - in - charge. Without Fly Ash (Min cement level as per latest IS 456 shall be maintained) (Cement level 475 kg) in</p> <p>Beams, girders and cantilever up to floor For GROUND FLOOR</p>	375.68	5534.00	Cum	3785034.64
			6983.00	Cum	2623373.44

18	<p>Providing and laying in position Ready Mixed M-250 grade concrete for reinforced cement concrete work , using cement content as per approved Design Mix manufactured in fully automatic batching plant and transported to site of work in transit mixer for a lead up to 10 kms having continuous agitated mixer, manufactured as per mix design of specified grade for reinforced cement concrete work including pumping of R.M.C. from transit mixer to site of laying, including the cost of centering shuttering finishing and excluding the cost of reinforcement including cost of admixtures in recommended proportions as per IS: 9103 to accelerate/ retard setting of concrete, improve workability without impairing strength and durability as per direction of the Engineer - in - charge. Without Fly Ash (Min cement level as per latest IS 456 shall be maintained) (Cement level 450 kg) in Beams, girders and cantilever up to floor For FIRST FLOOR</p>	152.46			
19	<p>Providing and laying in position Ready Mixed M-250 grade concrete for reinforced cement concrete work , using cement content as per approved Design Mix manufactured in fully automatic batching plant and transported to site of work in transit mixer for a lead up to 10 kms having continuous agitated mixer, manufactured as per mix design of specified grade for reinforced cement concrete work including pumping of R.M.C. from transit mixer to site of laying, including the cost of centering shuttering finishing and excluding the cost of reinforcement including cost of admixtures in recommended proportions as per IS: 9103 to accelerate/ retard setting of concrete, improve workability without impairing strength and durability as per direction of the Engineer - in - charge. Without Fly Ash (Min cement level as per latest IS 456 shall be maintained) (Cement level 450 kg) in Beams, girders and cantilever up to floor For SECOND FLOOR</p>	10.05	7022.85	Cum	1070703.71
			7062.70	Cum	70980.14

20	<p>Providing and laying in position Ready Mixed M-300 grade concrete for reinforced cement concrete work , using cement content as per approved Design Mix manufactured in fully automatic batching plant and transported to site of work in transit mixer for a lead up to 10 kms having continuous agitated mixer, manufactured as per mix design of specified grade for reinforced cement concrete work including pumping of R.M.C. from transit mixer to site of laying, including the cost of centering shuttering finishing and excluding the cost of reinforcement including cost of admixtures in recommended proportions as per IS: 9103 to accelerate/ retard setting of concrete, improve workability without impairing strength and durability as per direction of the Engineer - in - charge. Without Fly Ash (Min cement level as per latest IS 456 shall be maintained) (Cement level 475 kg) IN Columns, pillars, posts and struts for GROUND FLOOR COLUMN UP TO PLINTH LEVEL</p>	132.02	8025.00	Cum	1059460.50
21	<p>Providing and laying in position Ready Mixed M-250 grade concrete for reinforced cement concrete work , using cement content as per approved Design Mix manufactured in fully automatic batching plant and transported to site of work in transit mixer for a lead up to 10 kms having continuous agitated mixer, manufactured as per mix design of specified grade for reinforced cement concrete work including pumping of R.M.C. from transit mixer to site of laying, including the cost of centering shuttering finishing and excluding the cost of reinforcement including cost of admixtures in recommended proportions as per IS: 9103 to accelerate/ retard setting of concrete, improve workability without impairing strength and durability as per direction of the Engineer - in - charge. Without Fly Ash (Min cement level as per latest IS 456 shall be maintained) (Cement level 450 kg) IN Columns, pillars, posts and struts for GROUND FLOOR COLUMN UP TO GROUND FLOOR SLAB LEVEL</p>	107.79	7835.00	Cum	844534.65

22	<p>Providing and laying in position Ready Mixed M-250 grade concrete for reinforced cement concrete work , using cement content as per approved Design Mix manufactured in fully automatic batching plant and transported to site of work in transit mixer for a lead up to 10 kms having continuous agitated mixer, manufactured as per mix design of specified grade for reinforced cement concrete work including pumping of R.M.C. from transit mixer to site of laying, including the cost of centering shuttering finishing and excluding the cost of reinforcement including cost of admixtures in recommended proportions as per IS: 9103 to accelerate/ retard setting of concrete, improve workability without impairing strength and durability as per direction of the Engineer - in - charge. Without Fly Ash (Min cement level as per latest IS 456 shall be maintained) (Cement level 475 kg) IN Columns, pillars, posts and struts for FIRST FLOOR COLUMN all floor above floor two level</p>	96.59			
			7874.85	Cum	760631.76
23	<p>Providing and laying in position Ready Mixed M-250 grade concrete for reinforced cement concrete work , using cement content as per approved Design Mix manufactured in fully automatic batching plant and transported to site of work in transit mixer for a lead up to 10 kms having continuous agitated mixer, manufactured as per mix design of specified grade for reinforced cement concrete work including pumping of R.M.C. from transit mixer to site of laying, including the cost of centering shuttering finishing and excluding the cost of reinforcement including cost of admixtures in recommended proportions as per IS: 9103 to accelerate/ retard setting of concrete, improve workability without impairing strength and durability as per direction of the Engineer - in - charge. Without Fly Ash (Min cement level as per latest IS 456 shall be maintained) (Cement level 450 kg) IN Columns, pillars, posts and struts for SECOND FLOOR COLUMN all floor above floor two level</p>	26.75			
			7914.70	Cum	211718.23

24	<p>Providing and laying in position Ready Mixed M-250 grade concrete for reinforced cement concrete work , using cement content as per approved Design Mix manufactured in fully automatic batching plant and transported to site of work in transit mixer for a lead up to 10 kms having continuous agitated mixer, manufactured as per mix design of specified grade for reinforced cement concrete work including pumping of R.M.C. from transit mixer to site of laying, including the cost of centering shuttering finishing and excluding the cost of reinforcement including cost of admixtures in recommended proportions as per IS: 9103 to accelerate/ retard setting of concrete, improve workability without impairing strength and durability as per direction of the Engineer - in - charge. Without Fly Ash (Min cement level as per latest IS 456 shall be maintained) (Cement level 450 kg) IN R.C.C Lintel for all thickness etc comp. FOR GROUND FLOOR</p>	42.38	7852.00	Cum	332767.76
25	<p>Providing and laying in position Ready Mixed M-250 grade concrete for reinforced cement concrete work , using cement content as per approved Design Mix manufactured in fully automatic batching plant and transported to site of work in transit mixer for a lead up to 10 kms having continuous agitated mixer, manufactured as per mix design of specified grade for reinforced cement concrete work including pumping of R.M.C. from transit mixer to site of laying, including the cost of centering shuttering finishing and excluding the cost of reinforcement including cost of admixtures in recommended proportions as per IS: 9103 to accelerate/ retard setting of concrete, improve workability without impairing strength and durability as per direction of the Engineer - in - charge. Without Fly Ash (Min cement level as per latest IS 456 shall be maintained) (Cement level 475 kg) in R.C.C Lintel for all thickness etc comp. FOR FIRST FLOOR</p>	38.37	7891.85	Cum	302810.28

26	<p>Providing and laying in position Ready Mixed M-250 grade concrete for reinforced cement concrete work , using cement content as per approved Design Mix manufactured in fully automatic batching plant and transported to site of work in transit mixer for a lead up to 10 kms having continuous agitated mixer, manufactured as per mix design of specified grade for reinforced cement concrete work including pumping of R.M.C. from transit mixer to site of laying, including the cost of centering shuttering finishing and excluding the cost of reinforcement including cost of admixtures in recommended proportions as per IS: 9103 to accelerate/ retard setting of concrete, improve workability without impairing strength and durability as per direction of the Engineer - in - charge. Without Fly Ash (Min cement level as per latest IS 456 shall be maintained) (Cement level 450 kg) in R.C.C Lintel for all thickness etc comp. FOR SECOND FLOOR</p>	2.01	7931.70	Cum	15942.72
27	<p>Providing and laying in position Ready Mixed M-250 grade concrete for reinforced cement concrete work , using cement content as per approved Design Mix manufactured in fully automatic batching plant and transported to site of work in transit mixer for a lead up to 10 kms having continuous agitated mixer, manufactured as per mix design of specified grade for reinforced cement concrete work including pumping of R.M.C. from transit mixer to site of laying, including the cost of centering shuttering finishing and excluding the cost of reinforcement including cost of admixtures in recommended proportions as per IS: 9103 to accelerate/ retard setting of concrete, improve workability without impairing strength and durability as per direction of the Engineer - in - charge. Without Fly Ash (Min cement level as per latest IS 456 shall be maintained) (Cement level 450 kg) in R.C.C. Flat slabs for all thickness for up to floor two level GROUND FLOOR</p>	476.22	6583.00	Cum	3134956.26

28	<p>Providing and laying in position Ready Mixed M-250 grade concrete for reinforced cement concrete work , using cement content as per approved Design Mix manufactured in fully automatic batching plant and transported to site of work in transit mixer for a lead up to 10 kms having continuous agitated mixer, manufactured as per mix design of specified grade for reinforced cement concrete work including pumping of R.M.C. from transit mixer to site of laying, including the cost of centering shuttering finishing and excluding the cost of reinforcement including cost of admixtures in recommended proportions as per IS: 9103 to accelerate/ retard setting of concrete, improve workability without impairing strength and durability as per direction of the Engineer - in - charge. Without Fly Ash (Min cement level as per latest IS 456 shall be maintained) (Cement level 475 kg) in R.C.C. Flat slabs for all thickness for FIRST FLOOR</p>	213.48			
29	<p>Providing and laying in position Ready Mixed M-250 grade concrete for reinforced cement concrete work , using cement content as per approved Design Mix manufactured in fully automatic batching plant and transported to site of work in transit mixer for a lead up to 10 kms having continuous agitated mixer, manufactured as per mix design of specified grade for reinforced cement concrete work including pumping of R.M.C. from transit mixer to site of laying, including the cost of centering shuttering finishing and excluding the cost of reinforcement including cost of admixtures in recommended proportions as per IS: 9103 to accelerate/ retard setting of concrete, improve workability without impairing strength and durability as per direction of the Engineer - in - charge. Without Fly Ash (Min cement level as per latest IS 456 shall be maintained) (Cement level 450 kg) in R.C.C. Flat slabs for all thickness for SECOND FLOOR</p>	7.77	6622.85	Cum	1413846.02
			6662.70	Cum	51769.18

30	<p>Providing and laying in position Ready Mixed M-250 grade concrete for reinforced cement concrete work , using cement content as per approved Design Mix manufactured in fully automatic batching plant and transported to site of work in transit mixer for a lead up to 10 kms having continuous agitated mixer, manufactured as per mix design of specified grade for reinforced cement concrete work including pumping of R.M.C. from transit mixer to site of laying, including the cost of centering shuttering finishing and excluding the cost of reinforcement including cost of admixtures in recommended proportions as per IS: 9103 to accelerate/ retard setting of concrete, improve workability without impairing strength and durability as per direction of the Engineer - in - charge. Without Fly Ash (Min cement level as per latest IS 456 shall be maintained) (Cement level 450 kg) in coping up to floor two level. For GROUND FLOOR</p>	32.08	7852.00	Cum	251892.16
31	<p>Providing and laying in position Ready Mixed M-250 grade concrete for reinforced cement concrete work , using cement content as per approved Design Mix manufactured in fully automatic batching plant and transported to site of work in transit mixer for a lead up to 10 kms having continuous agitated mixer, manufactured as per mix design of specified grade for reinforced cement concrete work including pumping of R.M.C. from transit mixer to site of laying, including the cost of centering shuttering finishing and excluding the cost of reinforcement including cost of admixtures in recommended proportions as per IS: 9103 to accelerate/ retard setting of concrete, improve workability without impairing strength and durability as per direction of the Engineer - in - charge. Without Fly Ash (Min cement level as per latest IS 456 shall be maintained) (Cement level 475 kg) in coping up to floor two level. For ALL FLOOR ABOVE FLOOR TWO LEVEL SECOND FLOOR</p>	12.09	7931.70	Cum	95894.25

32	<p>Providing and laying in position Ready Mixed M-250 grade concrete for reinforced cement concrete work , using cement content as per approved Design Mix manufactured in fully automatic batching plant and transported to site of work in transit mixer for a lead up to 10 kms having continuous agitated mixer, manufactured as per mix design of specified grade for reinforced cement concrete work including pumping of R.M.C. from transit mixer to site of laying, including the cost of centering shuttering finishing and excluding the cost of reinforcement including cost of admixtures in recommended proportions as per IS: 9103 to accelerate/ retard setting of concrete, improve workability without impairing strength and durability as per direction of the Engineer - in - charge. Without Fly Ash (Min cement level as per latest IS 456 shall be maintained) (Cement level 450 kg) in R.C.C. Chajja up to floor two level. For ground floor</p>	12.29	6638.00	Cum	81581.02
33	<p>Providing and laying in position Ready Mixed M-250 grade concrete for reinforced cement concrete work , using cement content as per approved Design Mix manufactured in fully automatic batching plant and transported to site of work in transit mixer for a lead up to 10 kms having continuous agitated mixer, manufactured as per mix design of specified grade for reinforced cement concrete work including pumping of R.M.C. from transit mixer to site of laying, including the cost of centering shuttering finishing and excluding the cost of reinforcement including cost of admixtures in recommended proportions as per IS: 9103 to accelerate/ retard setting of concrete, improve workability without impairing strength and durability as per direction of the Engineer - in - charge. Without Fly Ash (Min cement level as per latest IS 456 shall be maintained) (Cement level 450 kg) in R.C.C. Chajja ALL FLOOR ABOVE FLOOR TWO LEVEL FIRST FLOOR</p>	17.79	6677.85	Cum	118798.95

34	<p>Providing and laying in position Ready Mixed M-250 grade concrete for reinforced cement concrete work , using cement content as per approved Design Mix manufactured in fully automatic batching plant and transported to site of work in transit mixer for a lead up to 10 kms having continuous agitated mixer, manufactured as per mix design of specified grade for reinforced cement concrete work including pumping of R.M.C. from transit mixer to site of laying, including the cost of centering shuttering finishing and excluding the cost of reinforcement including cost of admixtures in recommended proportions as per IS: 9103 to accelerate/ retard setting of concrete, improve workability without impairing strength and durability as per direction of the Engineer - in - charge. Without Fly Ash (Min cement level as per latest IS 456 shall be maintained) (Cement level 475 kg) in R.C.C. Chajja all floor above floor two level. For SECOND floor</p>	0.44	6717.70	Cum	2955.79
35	<p>Providing and laying in position Ready Mixed M-250 grade concrete for reinforced cement concrete work , using cement content as per approved Design Mix manufactured in fully automatic batching plant and transported to site of work in transit mixer for a lead up to 10 kms having continuous agitated mixer, manufactured as per mix design of specified grade for reinforced cement concrete work including pumping of R.M.C. from transit mixer to site of laying, including the cost of centering shuttering finishing and excluding the cost of reinforcement including cost of admixtures in recommended proportions as per IS: 9103 to accelerate/ retard setting of concrete, improve workability without impairing strength and durability as per direction of the Engineer - in - charge. Without Fly Ash (Min cement level as per latest IS 456 shall be maintained) (Cement level 450 kg) in R.C.C. Stair case up to floor two level. For ground floor</p>	3.94	7105.00	Cum	27993.70

36	<p>Providing and laying in position Ready Mixed M-250 grade concrete for reinforced cement concrete work , using cement content as per approved Design Mix manufactured in fully automatic batching plant and transported to site of work in transit mixer for a lead up to 10 kms having continuous agitated mixer, manufactured as per mix design of specified grade for reinforced cement concrete work including pumping of R.M.C. from transit mixer to site of laying, including the cost of centering shuttering finishing and excluding the cost of reinforcement including cost of admixtures in recommended proportions as per IS: 9103 to accelerate/ retard setting of concrete, improve workability without impairing strength and durability as per direction of the Engineer - in - charge. Without Fly Ash (Min cement level as per latest IS 456 shall be maintained) (Cement level 450 kg) in R.C.C. Stair case For FIRST FLOOR</p>	3.94	7144.85	Cum	28150.71
37	<p>Providing and laying in position Ready Mixed M-250 grade concrete for reinforced cement concrete work , using cement content as per approved Design Mix manufactured in fully automatic batching plant and transported to site of work in transit mixer for a lead up to 10 kms having continuous agitated mixer, manufactured as per mix design of specified grade for reinforced cement concrete work including pumping of R.M.C. from transit mixer to site of laying, including the cost of centering shuttering finishing and excluding the cost of reinforcement including cost of admixtures in recommended proportions as per IS: 9103 to accelerate/ retard setting of concrete, improve workability without impairing strength and durability as per direction of the Engineer - in - charge. Without Fly Ash (Min cement level as per latest IS 456 shall be maintained) (Cement level 475 kg) in R.C.C.WALL/Pardi FOR ARCH or all thickness and cantilever up to floor two level. FOR GROUND FLOOR UP TO FLOOR TWO LEVEL</p>	467.87	7049.00	Cum	3298015.63

38	<p>Providing and laying in position Ready Mixed M-250 grade concrete for reinforced cement concrete work , using cement content as per approved Design Mix manufactured in fully automatic batching plant and transported to site of work in transit mixer for a lead up to 10 kms having continuous agitated mixer, manufactured as per mix design of specified grade for reinforced cement concrete work including pumping of R.M.C. from transit mixer to site of laying, including the cost of centering shuttering finishing and excluding the cost of reinforcement including cost of admixtures in recommended proportions as per IS: 9103 to accelerate/ retard setting of concrete, improve workability without impairing strength and durability as per direction of the Engineer - in - charge. Without Fly Ash (Min cement level as per latest IS 456 shall be maintained) (Cement level 450 kg) in R.C.C.WALL/Pardi FOR ARCH or all thickness and cantilever up to floor two level. for FIRST FLOOR all floor above floor two level</p>	11.20	7088.85	Cum	79395.12
39	<p>Providing and laying in position Ready Mixed M-250 grade concrete for reinforced cement concrete work , using cement content as per approved Design Mix manufactured in fully automatic batching plant and transported to site of work in transit mixer for a lead up to 10 kms having continuous agitated mixer, manufactured as per mix design of specified grade for reinforced cement concrete work including pumping of R.M.C. from transit mixer to site of laying, including the cost of centering shuttering finishing and excluding the cost of reinforcement including cost of admixtures in recommended proportions as per IS: 9103 to accelerate/ retard setting of concrete, improve workability without impairing strength and durability as per direction of the Engineer - in - charge. Without Fly Ash (Min cement level as per latest IS 456 shall be maintained) (Cement level 450 kg) in R.C.C.WALL/Pardi FOR ARCH or all thickness and cantilever up to floor two level. for SECOND FLOOR all floor above floor two level</p>	4.98	7128.70	Cum	35500.93

40	Providing and laying in position Ready Mixed M-250 grade concrete for reinforced cement concrete work , using cement content as per approved Design Mix manufactured in fully automatic batching plant and transported to site of work in transit mixer for a lead up to 10 kms having continuous agitated mixer, manufactured as per mix design of specified grade for reinforced cement concrete work including pumping of R.M.C. from transit mixer to site of laying, including the cost of centering shuttering finishing and excluding the cost of reinforcement including cost of admixtures in recommended proportions as per IS: 9103 to accelerate/ retard setting of concrete, improve workability without impairing strength and durability as per direction of the Engineer - in - charge. Without Fly Ash (Min cement level as per latest IS 456 shall be maintained) (Cement level 450 kg) in out side floor by trimix up to floor two level. and dewatering the floor with vaccum pump and top finished with power trowel compactor and double beam screed vibrator and making groove in the floor and fill with asphalt as directed by Architect/EIC.	180.70			
			9113.00	CUM	1646719.10
41	Providing FE-500D TMT STEEL (Code 1786-2008) reinforcement for RCC work including cutting bending, binding and placing in position for All floor	347464.52			
			76.45	Kg.	26563662.55
42	Rammed Rubble soling With Lean Mix cement mortar (CM 1:10) Preferably Joint fill up with lime mortar 1:4 etc. comp.	571.15			
			2131.00	Cum	1217120.65
43	Brick work using common Brunt clay building bricks having crushing strength not less than 35 Kg./Sqcm. In Super structure above plinth level in cement mortar 1:6 (1cement : 6 fine sand) Conventional for ground floor(BRICK MASONARY) FOR PLINTH	227.26			
			3981.21	Cum	904769.78
44	Brick work using common Brunt clay building bricks having crushing strength not less than 35 Kg./Sqcm. In Super structure above plinth level in cement mortar 1:6 (1cement : 6 fine sand) Conventional for ground floor(BRICK MASONARY)	524.48			
			4246.65	Cum	2227282.99
45	Brick work using common Brunt clay building bricks having crushing strength not less than 35 Kg./Sqcm. In Super structure above plinth level in cement mortar 1:6 (1cement : 6 fine sand) Conventional for all floor above floor two level FIRST FLOOR	437.54			
			4286.44	Cum	1875488.96

46	Brick work using common Brunt clay building bricks having crushing strength not less than 35 Kg./Sqcm. In Super structure above plinth level in cement mortar 1:6 (1cement : 6 fine sand) Conventional for all floor above floor two level SECOND FLOOR	110.22	4326.23	Cum	476837.07
47	Half brick masonry in common brunt clay building strength not less than 35 Kg./Sqcm. In cement mortar 1:3 (1cement : 3 coarse sand) with 2 Nos. of 6 mm. Diameter mild steel round bars after every three coarse embedded in cement mortar in foundation and plinth FOR GROUND FLOOR	339.33	707.96	sq.mt	240232.07
48	Half brick masonry in common brunt clay building strength not less than 35 Kg./Sqcm. In cement mortar 1:3 (1cement : 3 coarse sand) with 2 Nos. of 6 mm. Diameter mild steel round bars after every three coarse embedded in cement mortar in foundation and plinth FOR FIRST FLOOR	923.85	713.90	sq.mt	659536.52
49	Providing 20 mm thick double coat mala cement plaster on interior brick/white stone bela/ concrete work for plastering comprising of base coat of 12 mm thick cement plaster in cement mortar (1 cement : 4 coarse sand) in rough finishing and 8 mm thick top coat of cement mortar 1 :2 (1 Cement : 2 Coarse sand) finished with trowel including scaffolding curing etc. comp.For GROUND FLOOR walls	5074.67	267.75	sq.mt	1358742.89
50	Providing 20 mm thick double coat mala cement plaster on interior brick/ white stone bela/ concrete work for plastering comprising of base coat of 12 mm thick cement plaster in cement mortar (1 cement : 4 coarse sand) in rough finishing and 8 mm thick top coat of cement mortar 1 :2 (1 Cement : 2 Coarse sand) finished with trowel including scaffolding curing etc. comp.For GROUND FLOOR all floor above floor two level ceilings & soffits of stairs	1581.40	312.96	sq.mt	494914.94

51	Providing 20 mm thick double coat mala cement plaster on interior brick/white stone bela/ concrete work for plastering comprising of base coat of 12 mm thick cement plaster in cement mortar (1 cement : 4 coarse sand) in rough finishing and 8 mm thick top coat of cement mortar 1 :2 (1 Cement : 2 Coarse sand) finished with trowel including scaffolding curing etc. comp. For FIRST FLOOR all floor above floor two level walls	5017.71			
			293.43	sq.mt	1472346.65
52	Providing 20 mm thick double coat mala cement plaster on interior brick/ white stone bela/ concrete work for plastering comprising of base coat of 12 mm thick cement plaster in cement mortar (1 cement : 4 coarse sand) in rough finishing and 8 mm thick top coat of cement mortar 1 :2 (1 Cement : 2 Coarse sand) finished with trowel including scaffolding curing etc. comp.For FIRST FLOOR all floor above floor two level ceilings & soffits of stairs	1339.06			
			333.60	sq.mt	446710.42
53	Providing 20 mm thick double coat mala cement plaster on interior brick/white stone bela/ concrete work for plastering comprising of base coat of 12 mm thick cement plaster in cement mortar (1 cement : 4 coarse sand) in rough finishing and 8 mm thick top coat of cement mortar 1 :2 (1 Cement : 2 Coarse sand) finished with trowel including scaffolding curing etc. comp. For SECOND FLOOR all floor above floor two level walls	112.39			
			318.00	sq.mt	35740.02
54	Providing 20 mm thick double coat mala cement plaster on interior brick/ white stone bela/ concrete work for plastering comprising of base coat of 12 mm thick cement plaster in cement mortar (1 cement : 4 coarse sand) in rough finishing and 8 mm thick top coat of cement mortar 1 :2 (1 Cement : 2 Coarse sand) finished with trowel including scaffolding curing etc. comp.For SECOND FLOOR all floor above floor two level ceilings & soffits of stairs	44.16			
			354.24	sq.mt	15643.24
55	20 mm thick Pana Polish cement plaster for OUT SIDE on walls up to height 10 metres above ground level consisting of 12 mm thick backing coat of C.M. 1:3 (1-Cement : 3-sand) and 8mm thick finishing coat of C.M.1:1(1-cement:1-send) etc. complete. UP TO FLOOR TWO LEVEL(GROUND FLOOR) +F.F	5239.89			
			341.00	sq.mt	1786802.49

56	20 mm thick Pana Polish cement plaster for OUT SIDE on walls up to height 10 metres above ground level consisting of 12 mm thick backing coat of C.M. 1:3 (1-Cement : 3-sand) and 8mm thick finishing coat of C.M.1:1(1-cement:1-send) etc. complete. FOR ALL FLOOR ABOVE FLOOR TWO LEVEL SECOND FLOOR	874.47			
			366.68	sq.mt	320650.66
57	Providing cement vata (10cm. x 10 cm. size) quarter round in cement mortar 1:1 including neat cement finishing, watering etc. complete.FOR ALL FLOOR	511.84			
			23.45	Rmt	12002.65
58	Providing and fixing good quality as per manufacturer specification flush door shutters(35 mm thick), solid core construction with frame of first class hardwood with cross board and face veneer or plywood face panels or Laminates on both sides , including Steam beach member on periphery for fixing 4" long hinges 3 Nos. Fixing 1.0mm thick laminate on both sides including S.S Handles, S.S.ALDROP, S.S.stoppers, S.S.TOWER BOLS,doorstop with necessary screws & polishing with french/laquer to exposed edges as directed etc.complete.S.S. butt hinges with necessary screws. Non-decorative type and block board core s.s butt hinges in flush door shutters 35 mm thick.for all floors	413.69			
			1779.97	sq.mt	736355.79
59	Providing, Laying and fixing Polished Granite stone 18mm to 20 mm thick for Door Frame including with required Moulding on both edges as directed and design by Architect with cement mortar and cement slurry rubbing, polishing etc. complete.green stone 19mm to 20mm thick granite stone Basic Rate 915/-per sq.mt FOR ALL FLOOR	243.59			
			2761.00	sq.mt	672551.99
60	Providing, fixing and laying Polished Granite stone sill, lintel and jambs for alluminium section window with half round nosing green stone 18mm to 20mm thick granite stone Basic Rate 915/-per sq.mt FOR ALL FLOOR	213.05			
			2761.00	sq.mt	588231.05

61	Providing and laying 120 cm x 60 cm Antiskid Vitrified 8 to 10 mm thick tiles flooring over over 20 mm (average) base if cement mortar 1:6(1cement : 6 coarse sand) on new surface or fixing on existing flooring by adhesive material including dismantalling of existing flooring and jointed with colour cement slurry including finishing joint with flush pointing with epoxy grout 3mm thick joint and cleaning the surface etc complete size, shade, finish and pattern as approved by Architect and EIC. (Premium First Quality) FOR ALL FLOOR	2985.13			
			1635.00	sq.mt	4880687.55
62	Providing and laying 120/60 cm x 60 cm Antiskid vitrified tiles 8 to 10 mm thick in skirting risers of steps and dedo on 10mm thick cement plaster 1:3 (1-cement : 3-coarse sand) and jointed with epoxy grout/white cement slurry size, shade, finish and pattern as approved (matched to flooring)by Architect and EIC. (Premium First Quality) FOR ALL FLOOR	200.09			
			1523.61	sq.mt	304859.12
63	Providing and laying 20 mm thick Machine Polished Granite stone slab flooring for stair case over 20 mm. risers of steps. Dado and pillars laid on 10/20 mm. Thick cement mortar 1:3 (1 cement : 3 coarse sand) laid over and jointed with grey/white cement slurry with matching color of stone including half round nosing, rubbing and making two groove on front edge for steps (TREAD) and polishing complete. basic rate for granite stone Rs.1721/-(Sq.mt) FOR ALL FLOORS	97.37			
			2825.00	sq.mt	275070.25
64	Providing and laying Ceramic tiles 6 mm. Thick in skirting risers of steps and dado on 10 mm. Thick cement plaster 1:3 (1 cement : 3 coarse sand) pointing in white cleaned jointed with white cement slurry. size,shade and pattern as approved (matched to flooring) by Architect and EIC. for all floor WALL	1616.67			
			965.48	sq.mt	1560862.55

65	Providing and fixing counter top wash basin(oval shape)sandwich type top with granite stone (shade approved by Architects) with making hole and with all necessary required fittings and fixtures for washbasin likes waste cuplin,bottle trep, flexible pipe fittings ets comp 60 cm wide top including with oval shape wash basin counter top size as per drawing & oval shape wash basin size 56 cm x 43 cm (viene oval self rimming basin S.white 51x43 cm(10038)/ZEN star white under counter (10049) as directed by Architect Hindware/CERA) for All floor above floor two level as directed by Architect and EIC	32.55	5983.00	sq.mt	194746.65
66	Providing, supplying and fixing counter top sandwich type finish top with granite stone and base with kotastone with making hole as per requirement, kota stone vertical support (both granite and kota stone all exposed surface must mirror polish and all edges moulded) and counter top size as per drawing and design given by Architect/EIC etc comp.gor kitchen	41.27	4715.00	sq.mt	194588.05
67	Providing and fixing counter top basin for drinking water and hand wash basin sandwich type(both side) top and bottom with mirror polished granite stone with making hole and with all necessary required fittings and fixtures for basin likes waste cuplin, flexible pipe fittings ets comp 0.47 cm wide top including with rubbing, polishing all vertical and horizontal front edge with noising for basin counter size for drinking water and hand wash basin as per drawing and using thick cement slurry, adhasive and white cement for jointing etc comp as per design and directed by Architects	3.84	8030.00	Rmt	30835.20
68	Providing and laying water proofing treatment with broken china mosaic flooring for terrace using 12 mm to 20 mm broken pieces of glazed tiles to be laid over cement mortar 1:3 to plain or slope and to be tempered to bring mortar crème out upto surface using white cement including rounding off junctions and extending then upto 15 cm along the wall, clearing with water and oxalic acid etc, as directed, shade and pattern as directed by Architect and EIC.	1658.03	739.89	SqM	1226759.82
69	Providing and laying cushioning layer on R.C.C Slab, concrete using brick aggregate of 20mm nominal size mortar compresing of (1-Lime 2-Fine sand)	1658.03	234.68	SqM	389106.48

70	Providing, supplying, laying and planting different kinds of plants/shrubs/ground cover (10nos per sq.mt) HADGES and Trees/Palm tree (minimum height 10' TO 12' feet)as directed by Architect in suggested area with necessary excavation minimum (size of excavation 1.20mt X 1.20mt X 1.20mt) as directed by Architect, garden soil required for plants, curing, required FYM farm yard manure, for flower bed etc. complete at all level, heights as per design by ARCHITECT and directed by EIC (work start after getting prior approval for sample of all plants and trees)	159.51			
			900.00	sq.mt	143559.00
71	Providing, Supplying and laying Land Scaping work, green lawn include with necessary required excavation (minimum depth of excavation 0.30mt), FYM (good quality farm yard manure) and garden soil etc complete as per design and directed by ARCHITECT(work start after getting prior approval for sample)	244.64			
			796.00	sq.mt	194733.44
72	Providing Supplying and laying fine sand(PANO)(approved quality of surendranagar bhogavo river) for sand pit(children play area) as design by architect and directed by EIC	95.66			
			750.00	CUM	71745.00
73	Providing and fixing standard extruded of aluminium section of size 63mm x 38.10mm x 1.2mm (@ Wt. 0.643 Kg/mt) with colour anodized aluminium frame for ventilation with 5 mm thick frosted glass as details etc complete for Ventilation	11.10			
			1163.92	sq.mt	12919.51
74	Providing and fixing extruded aluminum window(sliding window) having extruded aluminum Colour Powder Coated section frame main outer size 127mm x 38.10mm x 1.35mm (of Jindal Section no:2443, @ Wt.1.384 Kg/mt), horizontal Four track member size 122.20mm x 31.75mm x 1.10mm (@ Wt. 1.205 Kg/mt), vertical member of size 122.20mm x 31.75mm x 1.50mm (@ Wt. 1.398 Kg/mt) with sliding shutters of horizontal member size 40mm x 18mm x 1.29mm (@ wt.of 0.456Kg/mt), vertical member of size 40mm x 18mm x 1.29mm (@ wt.of 0.456Kg/mt, (@ Wt. 0.457 Kg/mt) with 5 mm thick transparent bronze colour tinted float glass with powder coated aluminum fittings and fixtures and transparent silicon sealant glass fixing to frame as per details etc complete for window.	371.28			
			2119.14	sq.mt	786794.30

75	Providing and Fixing safety grill for windows, doors/Railing for staircase and Remp, M.S.GATE of required pattern for windows/ventilations/Door/staircase, Remp, Compound wall AND GATE using M.S. polished bars size 12mm, m.s flat and rectangular/round CRC pipes of required size at required spacing as per design directed by architect and hold fast with coach bolts etc. complete.	20079.78			
			112.00	Kg	2248935.36
76	Providing and fixing rolling shutters of approved make made of 80 mm wide M.S. laths inter-locked together through their entire length and jointed together at the ends by end locks mounted on specially designed pipe shaft with bracket plates, guide channels and arrangements for inside and outside locking with pushpull operation including the cost of hood cover and spring etc. complete.(A) Shutters having width below 3.5 M.	69.91			
			3468.72	sq.mt	242498.22
77	Applying priming coat over new steel and other metal surfaces after and including preparing the surface by thoroughly cleaning, oil grease, dirt and other foreign matter and scoured with brushes fine steel wool, scrapers, and sand paper with ready mixed priming paint brushing red lead.	1133.30			
			34.65	sq.mt	39268.85
78	Painting two coats (excluding priming coat) on new steel and other metal surfaces with enamel paint, brushing interior to give an even shade including cleaning the surface of all dirt, dust and other foreign matter.	1133.30			
			86.94	sq.mt	98529.10
79	Applying two coats of Birla (white cement based) or Asian (acrylic lapy-putty) or equivalent & two coats of primer of approved brand and manufacture on new wall/ceiling surface to give an even shade including thoroughly brushing the surface free from mortar dropping and other foreign matter and sand papered smooth.	16133.29			
			40.19	sq.mt	648396.93
80	Wall painting (three coats) with plastic emulsion paint of approved brand and manufacture on undecorated wall surface to give an even shade including throughly brushing the surface free from mortar droppings and other foreign matter and sand papered smooth. on walls shade and pattern as directed by Architect and EIC.	13168.67			
			118.24	sq.mt	1557063.54

81	Wall painting (three coats) with plastic emulsion paint of approved brand and manufacture on undecorated ceiling and soffit surface to give an even shade including thoroughly brushing the surface free from mortar droppings and other foreign matter and sand papered smooth. on ceiling and soffit shade and pattern as directed by Architect and EIC.	2964.62			
			123.45	sq.mt	365982.34
82	Finishing wall with 100% ACRYLIC EXTERIOR paint (PU/SILICON BASED) of approved make,brand and shade on wall surfaces (two coats), with 100% alcaly resistance primer(PU/SILICON BASED) one coats , recessed /embossed panels, pillars etc., give an even shade after thoroughly brushing the surface to remove all the dirt and remains of loose powdered material. The material shall be as described in list of approved material.shade and pattern as directed by Architect and EIC.	6114.36			
			281.00	sq.mt	1718135.16
83	Providing, Supplying and Filling with good quality Broken AEC block for Sunk etc comp..	102685.80			
			8.00	KG	821486.40
84	Applying general insecticide pest control treatment to floors, cupboards, etc. including labours materials etc. complete.	1814.05			
			36.86	sq.mt	66865.88
85	Providing,supplying, making,eracting and Fixing M.S.Steel Roof structure with M.S trusses and G.I.Coated Sheet of required pattern as required using M.S. polished bars, M.S.Flats,M.S.angles,M.S. Channels and rectangular CRC pipes(Heavy) of required size at required spacing for purlins,Hip and jack rafters,connecting plates,tees,eams connected to commen rafters and the like as per design and hold fast with coach bolts including cutting, hoisting, fixing in position with one coat of primer and two coats of matt finished oil painting & required foundation J bolt, base plate of required size as directed with cement concrete (M200/250) etc. complete.FOR OTS AND GAZEBO	9521.34			
			145.00	Kg	1380594.30
86	Providing and fixing concealed center point to wall ceiling & floor CPVC (SDR 13.5) PIPE having National Sanitation Foundation (NSF) seal for potable water of following dia. Normal bore tube fitting and clamps including making good the wall, ceiling and floor etc. complete. (E) 40 mm.	547.00			
			437.66	Rmt	239400.02

87	Providing and fixing concealed center point to wall ceiling & floor CPVC (SDR 13.5) PIPE having National Sanitation Foundation (NSF) seal for potable water of following dia. Normal bore tube fitting and clamps including making good the wall, ceiling and floor etc. complete. (A) 25 mm.	834.00			
			247.25	Rmt.	206206.50
88	Providing and fixing concealed center point to wall ceiling & floor CPVC (SDR 13.5) PIPE having National Sanitation Foundation (NSF) seal for potable water of following dia. Normal bore tube fitting and clamps including making good the wall, ceiling and floor etc. complete. (A) 15 mm.	705.00			
			165.21	Rmt.	116473.05
89	Providing laying and jointing in true line and level 40mm dia. U.P.V.C. Pipe (SCH- 40) for cold water including fittings make PRINCE / SUPREME / ASTRAL / FINOLEX or equivalent as approved by Engineer In Charge. Pipe shall be fixed on the wall with the help of clamp at every two metre C/C or shall be cancelled as directed including necessary fittings etc. including testing of pipe and joints and fixing the same with adhesive solvent, including cost of all materials.	498.00			
			146.65	Rmt	73031.70
90	Providing laying and jointing in true line and level 25mm dia. U.P.V.C. Pipe (SCH- 40) for cold water including fittings make PRINCE / SUPREME / ASTRAL / FINOLEX or equivalent as approved by Engineer In Charge. Pipe shall be fixed on the wall with the help of clamp at every two metre C/C or shall be cancelled as directed including necessary fittings etc. including testing of pipe and joints and fixing the same with adhesive solvent, including cost of all materials.	608.00			
			90.93	Rmt.	55285.44
91	Providing laying and jointing in true line and level 15mm dia. U.P.V.C. Pipe (SCH- 40) for cold water including fittings make PRINCE / SUPREME / ASTRAL / FINOLEX or equivalent as approved by Engineer In Charge. Pipe shall be fixed on the wall with the help of clamp at every two metre C/C or shall be cancelled as directed including necessary fittings etc. including testing of pipe and joints and fixing the same with adhesive solvent, including cost of all materials.	575.00			
			71.93	Rmt.	41359.75

92	Providing and fixing screw down bib taps of following size :(B) Brass chromium plated screw down bib tap (l) 15 mm dia.	132.00	184.98	No	24417.36
93	Providing and fixing chromium plated brass screw down stopcock of approved quality including fixing in pipe line etc. complete .(A) 15 mm. Dia	75.00	212.68	No	15951.00
94	Providing and fixing chromium plated brass Health Faucet of approved quality including fixing in pipe line etc. complete Hindware, EssEss, ap royale or equivalent.	30.00	599.00	No	17970.00
95	Providing and fixing chromium plated brass screw down stopcock of approved quality including fixing in pipe line etc. complete .(C) 25 mm. Dia	30.00	218.63	No	6558.90
96	Providing and fixing gun metal check or non return full way wheel valve (A) 15mm. Dia	15.00	184.98	No	2774.70
97	Providing and fixing gun metal check or non return full way wheel valve (C) 25 mm. Dia	15.00	416.47	No	6247.05
98	Providing and fixing gun metal check or non return full way wheel valve (E) 40 mm. Dia	10.00	656.86	No	6568.60
99	Providing and fixing C.P.brass shower rose with 15mm or 20mm inlet.(A) 100mm dia.Each	37.00	279.37	No	10336.69
100	Providing and fixing 600mmX450mm Beveled edge glass mirror of superior glass mounted on 6mm the A.C. sheet or plywood sheet & fixed to wooden plugs with C.P.brass screws and washers.	45.00	825.48	No	37146.60
101	Providing and fixing C.P.brass towel rail complete with c.p. brass brackets fixed to wooden plugs with c.p. brass screw. (B)600mmx20mm size	46.00	597.22	No	27472.12
102	Providing and fixing chromium plated bottle trap with necessary couplings of approved quality for wash basin	45.00	292.87	No	13179.15
103	Providing and fixing pillar tap , capstan head , screw down high pressure with serews, shanks and bank nuts.(i) 15mm	45.00	305.67	No	13755.15
104	Providing and fixing pillar tap/swan neck pillar cock left hand operating capstan head , screw down high pressure with serews, shanks and bank nuts etc comp Hindware, EssEss, ap royale or equivalent (i) 15mm	45.00	1550.00	No	69750.00
105	Providing and fixing chromium plated brass waste coupling F/T of approved quality including fixing in pipe line etc. complete Hindware, EssEss, ap royale or equivalent.	45.00	363.00	No	16335.00

106	Providing and fixing chromium plated brass Angle cock common with flange of approved quality including fixing in pipe line etc. complete Hindware, EssEss, ap royale or equivalent. 15mm Dia	74.00	799.00	No	59126.00
107	Providing and fixing urinal approved quality connecting the urinal with waste pipe, trap etc. complete.(A) White earthen ware flat back or corner type size 430mm x 260mm x 350 mm	29.00	1026.01	No	29754.29
108	Providing and fixing chromium plated brass half turn flush cock of approved quality including fixing in pipe line etc. complete.(ii) 25mm Dia	51.00	261.16	No	13319.16
109	Providing and fixing wash down water closet (European type, W.C. Pan with integral 'P' or 'S' trap including jointing the trap with soil pipe in cement mortar 1:1 (1 cement : 1 fine sand) (seat and cover to be measured and paid for separately)(A) Vitreous china pattern : I (I) In white colour including with 100mm size P or S trap for water closet squatting pan including jointing the trap with the pan and soil pipe in cement Mortar 1:1 (1-Cement :1-Fine sand)(A) Vitreous China.	30.00	1604.23	No	48126.90
110	Providing and fixing water closet squatting pan (Indian type W.C. Pan) size 580 mm. (Earth work, Bed concrete foot rests and trap to be measured and paid for separately.)(A) Vitreous china(I) Long pattern white colour including with 100mm size P or S trap for water closet squatting pan including jointing the trap with the pan and soil pipe in cement Mortar 1:1 (1-Cement :1-Fine sand)(A) Vitreous China.	21.00	1241.11	No	26063.31
111	Providing and fixing wash basin with single hole for pillar tap with C.I. Or M.S. brackets painted white including cutting holes and making good the same but excluding fittings :(A) Vitreous china(ii) Flat back wash basin 500mm x 400mm size(I) in white colour	15.00	1400.18	No	21002.70
112	Providing and fixing plastic seat and cover for wash down water closet with C.P. Brass hinges and rubber buffers.(B). Black plastic seat and cover	30.00	288.45	No	8653.50
113	Providing and fixing PVC SWR (spun) nahni trap of the following nominal diameter of self cleaning design with C I screwed down of hinged grating including cost of cutting and making good the walls and floors 100 mm inlet and 50 mm out let etc complete	175.00	371.00	No	64925.00

114	Providing and fixing S.W. Gully trap with C I grating brick masonry chamber and water tight C I cover with frame of 300 x 300 mm size (inside) with standard weight (i)squre mouth traps (B) 150 mm x 100 mm size P or R type	35.00	1234.57	No	43209.95
115	Providing, laying and jointing in true line and level 160 diametre U.P.V.C.SWR (Type B) conforming to IS 13592-1992 with one end plain and other end socketed with rubber ring, & fittings conforming to ISI 14735-1999 of approved make for drainage system pipe line, pipe shall be jointed with each other with rubber lubricant, pipe shall be fixed on wall using of PVC clamp of the size 160 mm diametre x 210 mm length x 196 mm heigh at every 2000 mm center to center or shall be concealed in walls as directed including necessary fittings such as bends, shoes etc. including testing of pipes and joints and jointed with adhesive solvent cement including cost of all materials.	428.00	822.99	Rmt	352239.72
116	Providing laying and joining in true line and level 110 mm diameter U.P.V.C. SWR Type B pipe confirming to IS 13592-1992 with one and plain and other end socketed with rubber ring and fitting confirming to IS 14735-1999 of approved make for drainage system pipe line, pipe shall be jointed with each other with rubber lubricant, pipe shall be fixed on wall using of PVC clamps of the size 110mm diameter x 149 mm length x 145 mm high at every 2000 mm center to center or shall be eoncealed in walls as directed including necessary fittings such as bends, shoes etc, including testing of pipes and joints and jointed with adhesive solvent cement including cost of all materials	925.50	826.88	Rmt	765277.44

117	Providing laying and joining in true line and level 75 mm diameter U.P.V.C. SWR Type B pipe confirming to IS 13592-1992 with one end plain and other end socketed with rubber ring and fitting confirming to IS 14735-1999 of approved make for drainage system pipe line, pipe shall be jointed with each other with rubber lubricant, pipe shall be fixed on wall using of PVC clamps of the size 75mm diameter x 149 mm length x 145 mm high at every 2000 mm center to center or shall be concealed in walls as directed including necessary fittings such as bends, shoes etc, including testing of pipes and joints and jointed with adhesive solvent cement including cost of all materials	425.00			
			418.00	Rmt	177650.00
118	Providing and fixing to wall, ceiling and floor 6.0 Kg f/cm2 working pressure polythelene pipes of the following outside dia. Low density, complete with special flange compression type fittings wall clamps etc. including making good the wall, ceiling and floor. Rain Water pipe 110 MM	372.00			
			820.00	Rmt	305040.00
119	Providing and Fixing in position PVC SWR cowl vent to pipes 75 mm	15.00			
			9.32	No	139.80
120	Providing and Fixing in position PVC SWR cowl vent to pipes 110 mm	40.00			
			19.49	No	779.60
121	Providing erecting and fixing double coated (ISI) water tank of required capacity each with all necessary fittings & connection etc.complete on terrace.	50000.00			
			3.91	liter	195500.00
122	Constructing brick masonry chamber for under ground C.I. Inspection chamber and bends with bricks having crushing strength not less than 35 Kg/cm2 in cm. 1:5 C.I. Cover with frame (light duty) 455 mm. X 610 mm. Internal dimensions, total weight of cover with frame to be not less than 38 Kgs. weight of cover 23 Kg. and wt. of frame 15 Kg) R.C.C. top slab with 1:2:4 mix(1 cement : 2 coarse sand : 4 graded stone aggregate 20 mm. size) foundation concrete 1:5:10 inside plaster 15 mm. thick with cement mortar 1:3 finished smooth with a floating coat of neat cement on walls & abed concrete etc. complete.(ii) Inside dimensions, 500 mm. X 700 mm. And 450 mm. Deep for pipe line with one or two inlets.	30.00			
			3624.51	No	108735.30

123	Providing soak-pit of 5.0 Cu.m volume including excavation and filling brick-bats with dry masonry work at top for 45cm height including providing vatas in c:m. 1:3 with finishing, curing etc, complete as directed.	1	3,338.80	No	3338.80
124	Providing septic tank of given size including excavation, Bed Concrete, masonry work in 23cm thick wall, inside plaster finished with floting coat of cement C.I.steps, completes as per design and directed by Architects, and covering the top with stone/Rajula Stone including providing vatas in C.M 1:3 with curing.	1	73,300.00	Ea.	73300.00
125	Referigerant piping- insulated copper tube & electrical cabling between indoor to out door unit beyond 5 R mt dist. of 1 / 1.5 / 2.0 TR Hi-wall split unit.	195	800.00	RMT	156000.00
126	25/32mm Dia PVC drain pipe of Dutron / Supreme make for water outlet from indoor unit.	180	80.00	RMT	14400.00
127	Providing & erecting water cooler having storage capacity 150 Ltr. & cooling capacity 150 Ltr.per hour @ an ambient temp of 450 C. The outlet temp. of the water should drop by 150C within a hour, The water cooler should be comprising of hermetically sNosled compressor, fan motor, condensing unit, water tank surrounded by evaporating, coil, thermostats, relay etc.complete with necessary inlet & outlet connection. The body of water cooler will be made from Stainless Steel.	2	54,500.00	Nos.	109000.00
128	Supplying and erecting water filter cum purifier with ultra violate technology. (Aquaguard / waterdoc model or equivalent symphony/ crystal/videocon model)	2	5,290.00	Nos.	10580.00
129	Providing and laying polished Kota stone slab flooring over 20mm (Average) thick base of cement mortar 1:6 (1-cement : 6-coarse sand) or L.M. 1.1.5 (1-Lime putty :1.5 - coarse sand) laid over and jointed with grey cement slurry mixed with pigment to match the shade of slab including rubbing and polishing etc. complete. (A) 25mm thick	494.64	962.33	Sq.Mt	476006.91

130	Providing and laying polished kota stone slab 25mm thick in risers of steps,skirting Dedo and pillars laid on 10mm thick cement mortar 1:3 (1-Cement : 3 coarse sand) and jointed with gray cement slurry mixed with pigment to match the shade of slab including rubbing and polishing etc. complete.	31.68	1045.80	Sq.Mt	33130.94
131	Providing Supplying and Fixing 4 in 1 Swing (Rubber Belt Seat)Code-RSW-04 etc. Complete as design by Architect and directed by EIC	1.00	43904.00	Nos.	43904.00
132	Providing Supplying and Fixing Plain Slide (GI Sheet) 2.10 M HT.Code-RSL-02 etc. Complete as design by Architect and directed by EIC	1.00	34375.00	Nos.	34375.00
133	Providing Supplying and Fixing Spiral Slide (FRP) 1.50 M HT.Code-RSL-05 etc. Complete as design by Architect and directed by EIC	1.00	66925.00	Nos.	66925.00
134	Providing Supplying and Fixing Single Sesaw.Code-RSS-01 etc. Complete as design by Architect and directed by EIC	1.00	11867.00	Nos.	11867.00
135	Providing Supplying and Fixing S' Bridge Ladder.Code-RCL-02 etc. Complete as design by Architect and directed by EIC	1.00	32569.00	Nos.	32569.00
136	Providing Supplying and Fixing Revolving Platform 1.50 M Dia.Code-RMG-01 etc. Complete as design by Architect and directed by EIC	1.00	40828.00	Nos.	40828.00
137	Providing Supplying and Fixing/Laying Metal Single bed with storage (powder coated colour directed by Architect) etc. Complete as design by Architect and directed by EIC Warranty: the product is having warranty for period of 12 months from the date of material received by Bhavnagar Municipal Corporation.	497.00	8500.00	Nos.	4224500.00
138	Providing Supplying and Fixing/Laying Single bed Mattress(size 72" x 35")with Bedsheet (size 72" x 48" x 6"), Pillow (size 18" x 27") with cover and Blanket single bed Khadi cotton khes comforter set of ONE etc. Complete as design by Architect and directed by EIC warranty for period of 12 months from the date of material received by Bhavnagar Municipal Corporation.	497.00	1565.00	Nos.	777805.00

139	Providing Supplying and Fixing/Laying Dining table with Chair(4+1)pear wood dining set shahensha with CHR 400 by Nilkamal, Cello or equivalent etc. Complete as design by Architect and directed by EIC Warranty: the product is having warranty for period of 12 months from the date of material received by Bhavnagar Municipal Corporation.	20.00			
			3250.00	Nos.	65000.00
140	Providing Supplying and Fixing/Laying Three Seater Wooden Sofa etc. Complete as design by Architect and directed by EIC Warranty: the product is having warranty for period of 12 months from the date of material received by Bhavnagar Municipal Corporation.	24.00			
			6500.00	Nos.	156000.00
141	Providing Supplying and Fixing/Laying one Office table(size not less then 1.80 x 0.90 mt) with one Revolving chair (High back) and Four Lowback office chair and Three metal powder coated cupboard for office and store etc. Complete as design by Architect and directed by EIC Warranty: the product is having warranty for period of 12 months from the date of material received by Bhavnagar Municipal Corporation.	2.00			
			75250.00	job	150500.00
142	Providing Supplying, Fixing and commissioning POLYESTER BASED FABRIC SOLID WINDOW CURTAIN DARK IN COLOUR AND MACHINE WASHABLE FOR WINDOW WITH S.S CURTAIN ROD, S.S.CURTAIN BRACKETS AND DECORATIVE SOKETS SILVER FINISH FINIALS AND SUPPORTS SET all required fixers and fittings etc. Complete size and colour as design by Architect and directed by EIC(minimumm size not less then 1.50 x 1.50 mt) Warranty: the product is having warranty for period of 12 months from the date of material received by Bhavnagar Municipal Corporation.	107.00			
			1126.10	Nos.	120492.70

143	Providing Supplying, Fixing and commissioning S.S.kitchen equipment likes three and one burner commercial gas stove, haevy chimany for restourant, food storage container with contain food hot, WATER STORAGE, for food making and serving utensils and all required necessary equipments etc. Complete as design by Architect and directed by EIC(ALL EQUIPMENTS GOOD HIGHER GRADE QUALITY STAINLESS STEEL)Warranty: the product is having warranty for period of 12 months from the date of material received by Bhavnagar Municipal Corporation.	1.00			
			399890.00	job	399890.00
144	Providing Supplying and Fixing Parallel Bar for open GYM etc. Complete as design by Architect and directed by EIC	1.00			
			17380.00	Nos.	17380.00
145	Providing Supplying and Fixing Horizontal Bar (IRON) TOPSUN BRAND for open GYM etc. Complete as design by Architect and directed by EIC	1.00			
			21450.00	Nos.	21450.00
146	Providing Supplying and Fixing Cycle(spin fitness bike) WITH 6 KG FLYWJEEL/ADJUSTABLE, LLESB99 for open GYM etc. Complete as design by Architect and directed by EIC	1.00			
			12648.00	Nos.	12648.00
147	Providing Supplying and Fixing Loop Rung climber for open GYM etc. Complete as design by Architect and directed by EIC	1.00			
			39193.00	Nos.	39193.00
148	Providing Supplying and Fixing Rainbow climber for open GYM etc. Complete as design by Architect and directed by EIC	1.00			
			17600.00	Nos.	17600.00
149	Providing Supplying and Fixing Sit up board for open GYM etc. Complete as design by Architect and directed by EIC	1.00			
			18975.00	Nos.	18975.00
150	Providing, Supplying and Fixing for Handicap(Physically Disable People) Toilet Assessories including with S.S. Grab Bars straight size 600 mm long(30 inch)S.S.304, S.S.Brush Finish made from 32mm Dia pipe Three piece, S.S.U shape Moveble Grab Bars size 600 mm long(30 inch) S.S.304, S.S. Brush Finish made from 32mm dia pipe Two piece and Mirror One piece 600mm x 450mm size with all S.S.screws and pvc plugs in line and levels etc.comp at require hight and width mention as per requirement of Handicap Toilet guidelines as per NBC and given layout as suggested and directed by Authority/Architect	6.00			
			16445.00	Nos.	98670.00

151	Providing, Supplying and fixing cast iron cover with frame of size 455mm x 610mm internal dimension and painting with two coats of Anti-corrosive paint etc. complete.(weight of cover with frame not less than 38.00kg cover weight 23.00 kg and wt of frame 15.00 kg with required cement mortar and cement slurry etc comp.	6.00			
			1756.00	Nos.	10536.00
152	Providing and fixing cast iron steps of size 500mm x 150mm x 22.5mm and painting with two coats of Anti-corrosive paint etc. complete. Sor no 24010/24.33/pg no 133 rate 180.60	24.00			
			142.86	Nos.	3428.64
153	Providing and fixing pre-cast concrete kerb stone of gray cement based concrete block 30cm length,30cm height and 15cm thick of M250 grade concret as per approved design and including excavation for fixing in proper line and level,filling the joint with C:M 1:3 (1cement:3fine sand) etc complete.	322.17			
			358.06	Rmt	115356.19
154	Double Deck Steel Bed Providing & fixing Double Deck Steel Bed With mattress, bed sheet, pillow ,blanket (For 2 Persons)Overall Size: 1981L x 838W x 1830H mm(78"L x 33"W x 72"H inch)Bottom Storage: 1830L x 650D x 400H mm(with inbuilt Locker)Mattress Size: 1905x762mm (75"x30" inch)As per attached drawing/Image Material Description:1. Bed Frame structure made up of 38x38x2 mm thick. (14swg) CRCA square tube.2. Staircase tube of Ø 25x 2 mm thick. (14swg) CRCA round tube.3.Head & Tail Side & Top Side frame tube of Ø 25x 2mm thick. (14 swg) &Center Support tube of Ø 19x1.5 mm thick. (16 swg) CRCA round tube.4. Mid panel of 12mm thick. Waterproof ply with teakwood beading(SIZE :75 " x 30 ")5. Horizontal Mid Panel support of 20x20x2 mm thick. (14 swg) CRCA square tube.6. Bottom Storage (Drawer with telescopic channel and with inbuilt locker lock) unit of 0.7mm & 0.8mm (22swg& 21swg) thick. CRCASheet with 38x38x2mm thick (14swg) CRCA square tube with six side closed.7.Bottom storage unit with good quality telescopic channel for smooth slide.8. Good quality PVC shoes at leg bottom.(With flooring level adjustable) 261• All Steel parts of powder coated with high quality powder after 10 tanks anti-rust treatment process. Mattress: U-foam mattress with cover (2 Nos/ bunk bed) Rs.2750/- base price per no	173.00			
			22550.00	Nos.	3901150.00

	<p>*Size: 75 inch x 30 inch x 4 inch *40 density *4 inch (95mm U foam + quilted cover) *As per IS 7933 : 1975 with ISI mark *Quilted fabric, 200 to 250 GSM, polyester, pattern-square checks, color-as per department instruction *Cover (cotton cover for U foam mattress) 100% cotton, color –as per department instruction Pillow with cover : (2 Nos/ bunk bed) Rs.120/- base price per no *Size: 16 inch x 26 inch made from 1.2 Kg. cotton with printed color cover for pillow (100% cotton) Blanket: (2 Nos/ bunk bed) Rs.145/- base price per no. good quality blanket of size 7 feet x 4 feet, minimum weight 1.2 Kg Bedsheet with pillow cover : (2 Nos/ bunk bed) Rs.380/- base price per no *Size: 86 inch x 56 inch or 218 cm x 142 cm pillow cover size: 17 inch x 27 inch or 42 cm x 68 cm *100% cotton cloth material as per required color, Print and design *All side 1 inch width border</p> <p>*Appropriate thread & stitches should be used *Brands: Raymond, Oswal, Mafatlal, Bombay Dyeing. Material should be of standard company in original packing, Name of company/brand/model name/number etc. should be mentioned above packing. Warranty: the product is having warranty for period of 12 months from the date of material received by Bhavnagar Municipal Corporation.</p>				
155	<p>Multipurpose Industrial locker Providing & fixing Multipurpose Industrial locker without inbuilt lock. Total lockers – 18 nos. Pad locking system in each locker. Overall size H-1980 x W-915 x D-485(mm) (H-78" x W- 36" x D-19") as per Attached Drawing/Image. Material Description: all steel parts 22 swg (0.8 mm) thick.CRCA Sheet IS;513 grade hinged Door of 19 swg (1.0 mm) thick.CRCA Sheet IS;513 grade MS label holder and MS handel in each lockers.(minimum weight of product approx 51 KG) Good Quality Plastic Shoes At bottom. • All steel parts will be epoxy Polyester Powder Coated to the thickness of 50 microns finish after 10 tank antirust Warranty: the product is having warranty for period of 12 months from the date of material received by Bhavnagar Municipal Corporation.</p>	35.00	28159.00	Nos.	985565.00
156	<p>Providing,Supplying & fixing Square Taracotta Clay Jali size 8" x8" x3" and (Brown color or suggested) wall in proper line and level with required ready mix mortar and shade and size as directed by Architect/EIC etc. comp in all respect</p>	93.32	1454.00	Sq.Mt	135687.28
157	<p>Providing, Supplying & Fixing in line and level SS RAILING, 304 grade, brush finish, 16 gauge, with 50mm diameter closed ends handrail, fixed with vertical posts of 40 x 40mm, Horizontals pipes 19mm dia fixed with studs inclusive of any other accessories as may be required allong with fixing with proper SS screws and covering disk and making good as per Design and directed by EIC including labour and all necessary tools and plants for the work etc complete</p>	91.00	2258.00	Rmt	205478.00

158	Point wiring for Light / Bell with 2-1.5 sq.mm & earth wire of 1.5 sq.mm (Green) both are of ISI marked 1.1 KV grade FRLS PVC insulated multi strand copper wires up to 10 mtr length , in below type of pipe erected with 6A Modular type switch / bell push & accessories and earth continuity of following type, erected on PVC / Metallic/Wooden box, single mounting base frame covered with textured/metallic/white front plate modules erected on / in wall / ceiling as per pipe erected, with necessary Lamp holder/ceiling rose / H.D.Connector as directed. (a) with medium class Rigid PVC pipe and accessories erected flushed on wall/ceiling complete Cat. III	670.00			
			415.00	Pt.	278050.00
159	Point wiring for FAN with 2-1.5 sq.mm & earth wire of 1.5 sq.mm (Green) both are of .ISI marked 1.1 KV Grade FRLS PVC insulated multi strand copper wires up to 10 mtr length, in below type of pipe erected with 6A Modular type switch and hum free EME step type electronic fan regulator mounted and accessories with earth continuity of following type erected on PVC / Metallic/Wooden box, single mounting base frame covered with textured/metallic/white front plate modules erected on / in wall / ceiling as per pipe erected. with necessary ceiling rose / H.D.Connector as directed. (a) with medium class Rigid PVC pipe and accessories erected flushed on wall/ceiling complete Cat. III	200.00			
			593	Pt.	118600.00
160	Point wiring for on board Looped Plug with 6A Modular type switch & 5 pin socket erected on PVC / Metallic/Wooden box, single mounting base frame covered with textured / metallic/white front plate modules erected on / in wall / ceiling with following type accessories Cat. III	179			
			239	Pt.	42781.00
161	Point wiring for Individual Plug with & earth wire of 1.5 sq.mm (Green) both are of ISI marked 1.1 KV grade FRLS PVC insulated multi strand copper wires up to 10 mtr length, in below type of pipe erected complete with Modular type switch & 5 pin Plug erected on PVC / Metallic/Wooden box covered with appropriate front plate modules erected on / in wall / ceiling as per pipe erected with following type of accessories. [I] For 6A Plug and 6 a switch with 2-1.5 sq.mm Cu. Wire from nearby switchboard/mcb db board (a) with medium class Rigid PVC pipe and accessories erected flushed on wall/ceiling complete Cat. III	58			
			441	Pt.	25578.00

162	Point wiring for Individual Plug with & earth wire of 1.5 sq.mm (Green) both are of ISI marked 1.1 KV grade FRLS PVC insulated multi strand copper wires up to 10 mtr length, in below type of pipe erected complete with Modular type switch & 5 pin Plug erected on PVC / Metallic/Wooden box covered with appropriate front plate modules erected on / in wall / ceiling as per pipe erected with following type of accessories. [II] For 16A Plug and 16 amp switch with 2-2.5 sq.mm Cu. Wire from mcb db board. (a) with medium class Rigid PVC pipe and accessories erected flushed on wall/ceiling complete Cat. III	20	782	Pt.	15640.00
163	Providing following type of Modular Type Accessories mounted with PVC / metallic/Wooden box, single mounting base frame covered with textured / metallic/white front plate , modules erected with necessary connections as per site situation directed by Engineer In charge. (3) Two Pin/RJ-11 Telephone Socket [A] For One Gang Cat.III	6	152	Ea.	912.00
164	Providing and erecting 3 PHASE POWER PLUG WITH MCB OF 32 A IN METAL BOX DULY PAINTED	3	1450	Ea.	4350.00
165	Providing and erecting Mains with 1.1 KV grade FRLS PVC insulated ISI marked stranded Copper conductor wire in following type of pipe to be erected concealed in /flushed on wall/ceiling, with 1.5 sq. mm copper conductor FRLS PVC insulated stranded wire of green colour for earth continuity of following size (A) With medium class Rigid PVC pipe and accessories (b) 2 wire 2.5 sq. mm	3100	78	Mtr.	241800.00
166	providing and erecting Mains with 1.1 KV grade FRLS PVC insulated ISI marked stranded Copper conductor wire in following type of pipe to be erected in / on wall / ceiling with 2.5 sq. mm copper conductor FRLS PVC insulated stranded wire of green colour for earth continuity of following size (A) with medium class Rigid PVC pipe and accessories (a) 2 wire 4 sq. mm	200	106	Mtr.	21200.00
167	providing and erecting Mains with 1.1 KV grade FRLS PVC insulated ISI marked stranded Copper conductor wire in following type of pipe to be erected in / on wall / ceiling with 2.5 sq. mm copper conductor FRLS PVC insulated stranded wire of green colour for earth continuity of following size (A) with medium class Rigid PVC pipe and accessories (g) 4 wire 4 sq. mm	70	171	Mtr.	11970.00

168	Supplying & erecting approved make Telephone Cable electrolytic copper conductor PE insulation twisted in two pairs, & wrapped with FRLS PVC tape & sheathed with FRLS PVC or HFFR outer Jacket suitable for telephone wiring & confirming to C-DOT erected in existing pipe. of following size of conductors & nos.of pairs. With necessary connections.[A] Conductor Size 0.5 mm (a) Unarmoured (4) Five Pairs	110	38	Mtr.	4180.00
169	Supplying & erecting approved make LAN cable of following size in existing pipe as per direction [C] CAT - 6	1990	45	Mtr.	89550.00
170	Providing and erecting approved make split air-conditioning unit consisting of copper condensing unit with fan motor, hermetically sealed rotary compressor with accessories etc. duly connected separately erected evaporating unit and blower motor with its accessories by means of extra supplied proper insulated copper tubing,drain PVC pipes suitable for (cost includes powder coated Stand, Eco Friendly green gas charging, 15A plug top & Remote Control) with necessary core cutting For 3 Star Rating of current year (b) for 1.5 ton capacity	2	30624	Ea.	61248.00
171	Supplying and erecting, commissioning and testing of Diesel Generating set confirming to IS: 4722:1968 & BS:5514 having continuous rating, 3 phase, 415 volts, 50 cycles A.C. supply comprising of a totally enclosed air/water cooled diesel engine with multi-cylinders developing suitable BHP not less than following capacity at 1500 RPM with 10% overload for one hour in 24 hours with standard accessories like fly wheel, lubricating oil cooler, "A" class governor, heavy duty fuel wheel and lubricating oil filter, oil bath air filler, lubricating oil pressure gauge, end exhaust manifold, standard set of tools with adjustable spanners, screw drivers, cylinder head to cover, joint cylinder head to exhaust, element lube oil filter, 12 / 24 volts electric starting equipment complete with standard heavy duty battery, dynamo, cut-outs, ammeter, necessary wiring, pressure gauge, starter etc and heavy duty Residential type exhaust silencer and vertical hot air duct both logged with asbestos rope, save oil trays, exhaustcking, Name of company/brand/model name/number etc. should be mentioned above packing. Warranty: the product is having warranty for period of 12 months from the date of material received by Bhavnagar Municipal Corporation.mattress with cover (2 Nos/ bunk bed) Rs.2750/- base price per no 25 Kg.	1	535934.00	ea	535934.00

172	Solder less crimping type Aluminium lugs conforming to IS suitable for cable of following size evenly crimped with high pressure tool & connected to switchgear terminals with brass/cadmium plated nut bolts in an approved manner. (F) 95 Sq.mm.	8.00	40.00	ea	320.00
173	Supplying and erecting LED indoor fittings with LEDs of wattage 0.2 Watt to 0.5 Watt assembled on single MCPCB, with housing used as a heat sink shall be made of thick sheet Steel conforming to IS: 513/CRCA/aluminium pressure die cast powder coated and high U.V. & corrosion resistance with diffuser housed in aluminium casted body with company mark/name 160V to 270V, Power Factor more than 0.95, THD < 15 %, CCT 3000 K to 6500K, Luminaire efficacy > 85 lumens/watt , LED driver efficiency > 85 % (fitting required LM-79 & LM-80 Certificates)(NOTE: Below description have shown ranges of Wattage capacity of LED fittings.The Engineer incharge may select any wattage capacity between the ranges shown.) (A) Square/ Circular shaped Surface/Recessed Mount Downlight with provision for spring loaded mounting clips complete.IP20(iv) 22-24 watts, Surge-2 KV Cat.III	645.00	751.00	ea	484395.00
174	Providing & erecting Approved make Power Saving 50 Watt Ceiling Fan with double ball bearing ISI mark with Condenser 230 volt A.C. 50 Hz 1200 mm sweep complete having 3blades with aluminium blades with , canopy & 30 cm. down rod erected with earthing.(Make shall be approved by Engineer in charge))	188.00	1929.00	ea	362652.00
175	Supplying and erecting approved make Bracket fan of 230 volt, A.C. 50 Cy/s., 400/450 mm sweep complete erected on wall or with lead Cores and connections complete. Cat.II	4.00	2085.00	ea	8340.00
176	Supplying & erecting single phase approved make industrial exhaust fan suitable for medium duty ring mounted low noise operation suitable for medium duty having following dia size and maximum speed in RPM [A] 305 mm dia 900 RPM Cat.II	21.00	2034.00	ea	42714.00

177	Supplying & erecting UPVC Mini trunking (PVC Casing-n-Capping) having double-locking arrangement with grooves, trunking of size not below 12.5 mm in height as per IS with accessories of PVC/Resin polypropylene not below 1.8 mm thick duly sealed in joint & erected on wall / ceiling of following size . (2) 25 mm	100.00			
			30.00	Mtr.	3000.00
178	Providing and erecting Sheet Steel powder coated MCB distribution board - flush / surface mounted fitted with busbar, neutral link, earth bar and DIN rail, Conforms to IS 8623-1 & 3, IEC 61439-1 & 3 without MCB to house appropriate nos. of MCBs.(The DBs should be used of same company of MCB to be used) suitable for (B) three phase incoming and single phase horizontal type outgoing Per phase isolation type (PPI) (b) sheet steel double door (ii)6 way	6			
			2885	ea	17310.00
179	Providing and erecting Sheet Steel powder coated MCB distribution board - flush / surface mounted fitted with busbar, neutral link, earth bar and DIN rail, Conforms to IS 8623-1 & 3, IEC 61439-1 & 3 without MCB to house appropriate nos. of MCBs.(The DBs should be used of same company of MCB to be used) suitable for (B) three phase incoming and single phase horizontal type outgoing Per phase isolation type (PPI) (a) single door (ii)6 way	1.00			
			2233.00	ea	2233.00
180	Providing and erecting Approved make RCCBs conforming to IS: 12640 and having sensitivity of 30 mA and Short Circuit withstand capacity of 10 KA and suitable for operation on 3 phase and neutral 415V,50Hz. having characteristic of quick action & tripping with all advance feature & do not incorporate any electronic component for following Max. rating erected as directed.(iii) 63 Amps. FP Cat. III	6			
			3010	ea	18060.00
181	providing and erecting Miniature circuit breaker single pole 6A to 25A suitable to operate on 240 V A.C. system and having breaking capacity 10 KA to be erected in existing box. confirming to IS 8828/1996 with ISI Mark Cat.III	104.00			
			111.00	ea	11544.00
182	Providing & erecting 415V MCB Four Pole Switch for Lighting Load (B curve) having 10KA breaking capacity & confirms to IS :8828 in existing box having following capacity (a) 6 to 32 Amp. Cat.III	1			
			573	ea	573.00

183	Supplying & erecting approved make RCCB + MCB (Electro magnetic type only) working on residual current device having 10 KA short circuit breaking capacity and 30 mAmp. Sensitivity & 30 mili sec. tripping time conforming to IS 12640 test knob facility trip free mechanism operating for rated leakage at nominal ten volt, complete erected including all materials lugs screws etc. completed. [e] 32A to 40 A, 4 Pole Three Phase Cat. II	1.00			
			2145.00	ea	2145.00
184	Supplying & erecting approved make RCCB + MCB (Electro magnetic type only) working on residual current device having 10 KA short circuit breaking capacity and 30 mAmp. Sensitivity & 30 mili sec. tripping time conforming to IS 12640 test knob facility trip free mechanism operating for rated leakage at nominal ten volt, complete erected including all materials lugs screws etc. completed. [a] 6A / 10A / 16A / 20A / 25A 2 pole single phase Cat. II	1			
			1798	ea	1798.00
185	Providing and erecting XLPE(IS:7098)(I)-88 ISI armoured cable multistrand / Solid Copper conductor for 1.1 KV. to be laid on wall with necessary clamps or in existing trench / pipe at road crossing or floor of following size of cables.(C) 4 core 6 Sq. mm	405.00			
			503.00	mtr	203715.00
186	Providing and erecting XLPE(IS:7098)(I)-88 ISI armoured cable multistrand / Solid Copper conductor for 1.1 KV. to be laid on wall with necessary clamps or in existing trench / pipe at road crossing or floor of following size of cables.(B) 4 core 4 Sq. mm	40			
			359	mtr	14360.00
187	Providing and erecting XLPE(IS:7098)(I)-88 ISI armoured cable multistrand Copper conductor for 1.1 KV. to be laid on wall with necessary clamps or in existing trench / pipe at road crossing or floor of following size of cables. (E) 3 1/2 core 95 Sq. mm (50 Sq. mm 1/2 core)	20.00			
			480.00	mtr	9600.00
188	Providing and erecting XLPE(IS:7098)(I)-88 ISI armoured cable multistrand / Solid Copper conductor for 1.1 KV. to be laid on wall with necessary clamps or in existing trench / pipe at road crossing or floor of following size of cables.(A) 4 core 2.5 Sq. mm	310			
			267	mtr	82770.00

189	Providing & laying approved make Double walled corrugated pipes (DWC) of polyethylene(conforming to IS 14930 II)with necessary connecting accessories of same material at required depth in existing trench for laying of cable. below ground / road surface for enclosing cable (A)50 mm outer dia	300.00	62.00	mtr	18600.00
190	Solder less crimping type Aluminium lugs conforming to IS suitable for cable of following size evenly crimped with high pressure tool & connected to switchgear terminals with brass/cadmium plated nut bolts in an approved manner. (A) 1.5/ 2.5/4/6 Sq.mm	192	6	ea	1152.00
191	Providing and, fixing heavy duty flange type brass cable gland with rubber ring for PVC insulated armoured cable complete with out going tails, insulating tape etc for following size of cables.(A) 2 to 4 core 2.5 / 4 Sq. mm	32.00	33.00	ea	1056.00
192	Providing and, fixing heavy duty flange type brass cable gland with rubber ring for PVC insulated armoured cable complete with out going tails, insulating tape etc for following size of cables. (B) 2 to 4 core 6 Sq. mm	12	38	ea	456.00
193	Making trench in soft soil of suitable width of 90 cm deep for laying cable or locating the fault all over the run and back filling the same and making the surface as normal ground.	350.00	46.00	mtr	16100.00
194	Providing & laying approved make ISI marked HDPE 6Kg / cm2 (Class-3) as per IS:4984:1995 PE-80 to be erected at road crossing on or floor as directed for laying of cable. The pipes as following size of dia & weight per 6 mtr.(D) 75 mm inner Dia.	120	348	mtr	41760.00

195	<p>Supplying and erecting LED indoor fittings with LEDs of wattage 0.2 Watt to 0.5 Watt assembled on single MCPCB, with housing used as a heat sink shall be made of thick sheet Steel conforming to IS: 513/CRCA/ aluminium die cast powder coated and high U.V. & corrosion resistance with diffuser with company mark/name 160V to 270V, Power Factor more than 0.95, THD < 15%, CCT 3000 K to 6500K, Luminaire efficacy > 85 lumens/watt ,LED LED driver efficiency > 85 % (fitting required LM-79 & LM-80 Certificates)(NOTE: Below description have shown ranges of Wattage capacity of LED fittings.The Engineer incharge may select any wattage capacity between the ranges shown.) (A) Tube Light with integral driver (iv) 22-24 Watts, Surge - 2KV,IP-20, conventional 4 feet Cat-III</p>	6.00	370.00	EA	2220.00
196	<p>Supplying and erecting Flexible PVC insulated multi strand multi core 1.1 kv grade ISI marked copper wires of following size to be erected as directed. (e) 1.50 Sq.mm 3 core round PVC sheathed</p>	50	44	MTR	2200.00
197	<p>Supplying & erecting Galvanized M.S pipe post "B" class 88.9 mm O.D 4 mtr. Long duly painted with two coats of aluminium paint complete with metallic base plate of 300 mm x 300 mm x 4mm thick for using as a compound light pole with approx. weight 32 Kg.</p>	14.00	3194.00	EA	44716.00
198	<p>Supplying and erecting LED street light / Flood light fittings with High power White LEDs wattage of 3 Watt and above assembled on single MCPCB, efficiency more than 130 lm/w and corrosion free High pressure die cast aluminum housing with smooth finish powder coated and heat sink extruded aluminium with diffuser and Polycarbonate optics/ lenses, with toughened glass with company mark/name engraved or embossed 160 to 270 V,Power Factor more than 0.95, THD < 10 %, CCT 3000 K to 5700K,Uniformity ratio >0.45, Luminaire efficacy > 100 lumens/watt . LED driver efficiency > 85 %.(fittings required LM-79 & LM-80 certificates)(NOTE: Below description have shown ranges of Wattage capacity of LED fittings.The Engineer incharge may select any wattage capacity between the ranges shown.) (C) Post Top Lantern LED fitting comprises of finish cast aluminum spigot and spun aluminum canopy fixed with opal polycarbonate, pipe arrangement for vertical mounting driver and accessories wired upto terminal block.IP 65 (ii)32-40W Ccking,</p>	14.00	4772.00	EA	66808.00

199	Supplying & erecting approved make SMC press moulded composite FRP. loop-in, loop-out approx. 2mm thick box complete with Bakelite connector strip 5way(3P+N+E),DIN rail for mounting mob & hinged doors as per requirement having locking arrangements with mounting clamp with nuts, bolts & washers suitable for erection on pole with cable clamps& earth bolt of following size of box. (C)150mm x 125mm x 100mm [deep]	14	472	EA	6608.00
200	Providing and erecting Pipe type earthing having 150 cms.long and 2.5 cms. dia. galvanised iron pipe with coupling and buch buried in specially prepared earth pit complete with necessary 8 SWG earth wire.	14.00	365.00	EA	5110.00
201	Providing and, fixing heavy duty flange type brass double compression type cable gland with rubber ring for PVC insulated armoured cable complete with out going tails, insulating tape etc for following size of cables.(D) 3 & 1/2 core 95 Sq. mm	2	130	EA	260.00
202	For using salt and charcoal / coke as required for pipe type earthing.	14.00	170.00	EA	2380.00
203	Providing 1:2:4 cement concrete foundation & 70 % PCC from bottom including excavation for the pole of size 45 x 45 x 100 cm. Deep in below ground level with plinth of 45 cm x 45 cm (or 45 cm dia x 45 cm) high upper ground level with necessary curing and finishing in approved manner. (for 4 & 6 mtr pole)	14	801	EA	11214.00
204	Providing Supplying, Fixing and commissioning SOLAR WATER HEATER WITH all required fixers and fittings for hot water supply of Havells SOLERO 200 L SLR WHITE or Equivelant etc. Complete as design by Architect and directed by EIC	25.00	41156.00	EA	1028900.00

205	Supplying & erecting in earthpit of minimum bore dia. 225mm size approved make Safe Earthing Electrode consisting Pipe-in-Pipe Technology as per IS 3043-1987 made of corrosion free hot dipped G.I.Pipes having Outer pipe dia of 80 mm having 80-200 Micron galvanising, Inner pipe dia of 40 mm having 200-250 Micron galvanising, connection terminal dia of 14 mm with constant ohmic value surrounded by highly conductive compound with high charge dissipation suitable for following type of applications with chamber and heavy duty cover (A)(approved make OEM has to submit test certificate including value of earth resistance of installation duly stamped and signed by agency and officer Incharge has to ensure the value of earthing resistane mentioned in test Certificate) & having back filling compound of (B) Inner chemical (CCM Compound)- Resistivity:- 0.2 ohm / meter testing as per IEC 62561-2017, Voltage drop:- < 1 volt at no load & dry form, Sulphar content: <2%(C) Back fill Compound :- Earthing compound should be capable to retain moisture for long time Necessary test report must be submitted by Agency.[B] For Electrical installation up to 11 KV located in other than normal soil i.e. Soft Rock, Marshy Soil etc.	9			
			7025	EA	63225.00
206	Providing and erecting required size HOT deep Galvanised iron strip for earthing of H.T. , OCB/ ACB/ Transformer LT panel board, Motors etc. using proper clam	20.00	77.00	KG	1540.00
207	Providing and erecting required size Copper strip for earthing of H.T. OCB / ACB/ Transformer, LT panel board, Motors etc. using copper clamp.	15	787	KG	11805.00
208	Providing and erecting Annealed bare Copper wire 8 to 16 SWG.	10.00	787.00	KG	7870.00
209	providing and erecting Mains with ISI marked, 1.5KV grade electrolyte multi stranded, annealed copper conductor with heat resistant PVC insulated conforms to IS 694, IEC - 227 erected in existing pipe of following size (Specifically for control panel, relays, power switchgears, motor starters & control wiring) with required size of copper lugs, nuts and bolts if required. (d) One wire 4.00 sq. mm	310	35	MTR	10850.00
210	Supplying KITKAT pattern porcelain cut-out fuse with base of following current capacity erected on existing block board. (vi) 200 A. 500 V.	3.00	416.00	EA	1248.00
211	MAIN LT PANEL AS PER DESIGN AND SPECIFICATION	1	115000	EA	115000.00
212	Providing and, fixing heavy duty flange type brass cable gland with rubber ring for PVC insulated armoured cable complete with out going tails, insulating tape etc for following size of cables. (C) 2 to 4 core 10 Sq. mm	2.00	38.00	EA	76.00

213	Providing and erecting XLPE(IS:7098)(I)-88 ISI armoured cable multistrand Copper conductor for 1.1 KV. to be laid on wall with necessary clamps or in existing trench / pipe at road crossing or floor of following size of cables. (A) 4 core 10 Sq. mm	90	667	MTR	60030.00
214	Solder less crimping type Copper lugs conforming to IS suitable for cable of following size evenly crimped with high pressure tool & connected to switchgear terminals with brass/cadmium plated nut bolts in an approved manner. (B) 10 Sq.mm	8.00	10.00	EA	80.00
215	Supplying, Erecting, Testing & Commissioning the passenger / stretcher lift having following main features:15/16 Passengers, Ground plus 1 upper floor with Rated Speed of 1.0 m/sec., (B) With General Specification attached herewith. Cat.III (B) SPECIAL FEATURES DESCRIPTION OF LIFTS for PREMIUM category 1. Advanced control system dual 64 bit embedded microprocessor with CANBUS Serial Communication mode including Regenerative power efficient operation,on site programming facility, Anti nuisance, Pte-opening, BMS/RMS with necessary online real time monitoring system having necessary connectivity for remote monitoring & other suitable supporting hardware & software devices to fulfil the purpose. 2. Floor Indication LCD Display with call registration & brail mark with arrival gong and hall lantern & TFT Screen in the car with MP3 Voice Announcer. 3. CAR Panel should be Scratch resistive SS Moonrock finish / Hair Line / Honeycomb for car and all Doors, All landing doors must have fire rating up to 2 hourould be capable to retain moisture for long time Necessary test report must be submitted by Agency.[B] For Electrical installation up to 11 KV located in other than normal soil i.e. Soft Rock Marshy Soil etc	1	1485982	EA	1485982.00
216	Design,Supply,installation and testing of Fire Protection System all Fire safety equipments inclusive of on-site work (chasing, piping, fixing, colour etc as may be required and making good) as per requirement stipulated in prevailing NBC code for said building type. Inclusive of testing, commissioning in all respects and getting approval (noc) from all concerned authorities etc complete. NOTES.1- work done as per prior approval of drawings, 2- It is the responsibility of agency to get approval of fire plan before work start from respective departments., 3- whole work done as per present fire guidelines, 4- It is the responsibility of agency to get approval of Fire NOC from respective departments., 5- It is the responsibility of agency to take care of Existing building during Executing the work, if any damage occurs in building its contractor responsibility to repair own cost., 6- It is responsibility of agency to take care of each items installed till handing over., 7- It is the responsibility of agency to execute mock drill with intimation & in presence of engineer in charge.	1	2126501	job	2126501.00

11,99,40,840.71

	TOTAL RS.(WHITHOUT GST)	SAY'S	11,99,40,841.00
I/We am / are willing to carry out the work at % above/ below percent (Should be written in figures and words) of the estimated rate mentioned above. Amount of my/ our tender works out as under.			
*Estimated Amount		*Estimated Amount	
Put to tender	Rs.	Put to tender	Rs.
Add.....% above	Rs.	Deduct% below	Rs.
Total	Rs.	Net.	Rs.
In Words	In Words
.....

Notes 1 - All work shall be carried out as per Public Works Department Handbook and other specifications of Division or as directed.

Notes 2 - Rates quoted include clearance of site (prior commencement of work and at its close) in all respects and hold good for work under all conditions, site, moisture, weather etc.

Note 3 - To be continued on additional sheets, if found necessary.

Note. During the execution of the tendered work, if any other defect is found in the previously implemented civil work, the repair work needs to be carried out by selected agency at their own cost and at their own risk. BHAVNAGAR MUNICIPAL CORPORATION is not obliged to pay anything for that repair work.

SIGNATURE OF CONTRACTOR/AGENCY WITH STEMP

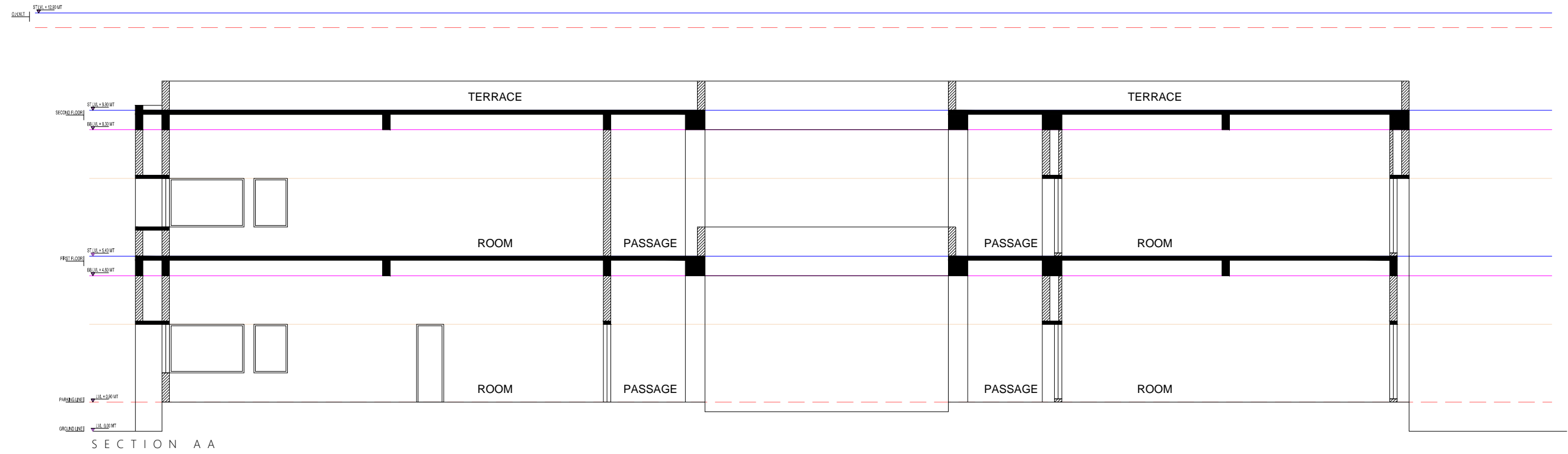

SECTION AA

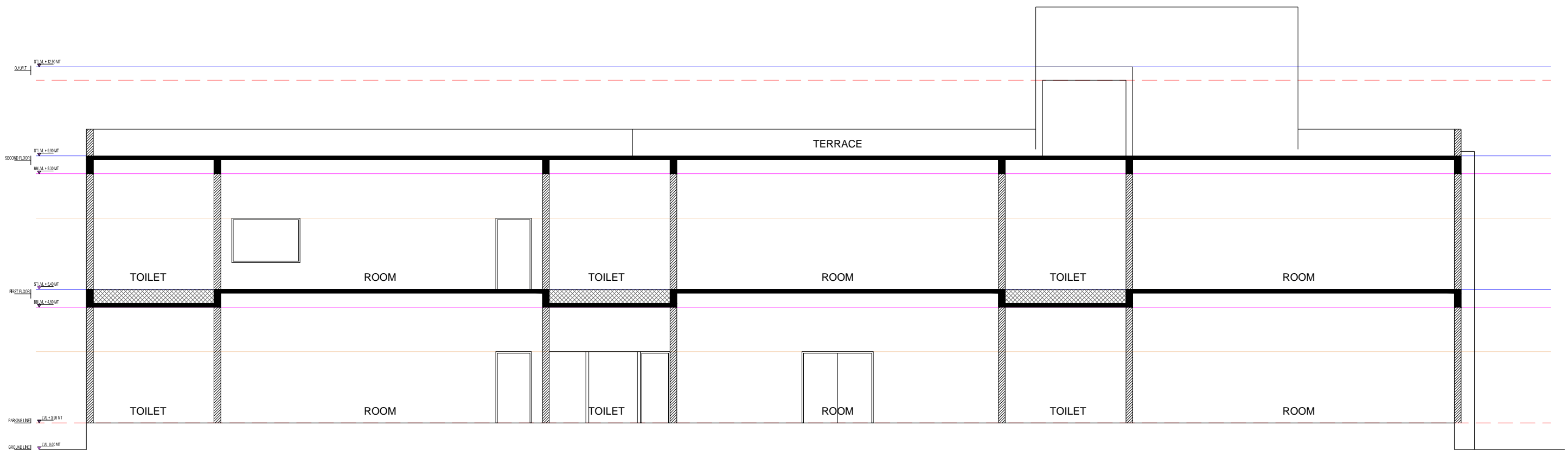

SECTION BB

PROJECT NO. BMC -03/gd DRAWING NO. A3-07	TITLE :- SECTIONS	B.M.C. PROPOSED NIGHT SHELTER AT FULSAR T.P. SCHEME, BHAVNAGAR FOR BMC	DWG.DATE:- 31-03-2023	1) ALL DIMENSIONS ARE IN METERS. 2) ALL DIMENSIONS TO BE READ AND NOT MEASURED. 3) ALL DIMENSIONS ARE FROM UNFINISHED SURFACES. 4) ALL STRUCTURAL DRGS. TO BE READ SIMULTANEOUSLY WITH ARCHITECTURAL DRGS. 5) ALL DIMENSIONS TO BE VERIFIED BY THE CONTRACTOR AND ANY AMBIGUITY TO BE BROUGHT TO THE IMMEDIATE NOTICE OF THE ARCHITECT. 6) ALL INTERNAL WALLS, BEAMS, COLUMNS AND SLABS ARE FINISHED WITH 12.5MM THK. SMOOTH PLASTER UNLESS OTHERWISE SPECIFIED. 7) ALL EXTERNAL WALLS ARE FINISHD WITH 25MM. THK. SANDFACED PLASTER UNLESS OTHERWISE SPECIFIED. 8) ALL LEVELS ARE INDICATED CONSIDERING THE EDGE OF APPERTANT ROAD AS + 0000 LVL.	THESE DRAWINGS & DESIGNS ARE THE SOLE PROPERTY OF AR. CHINTAN SACHAPARA AND AS SUCH SHALL NOT BE REPRODUCED IN ANY FORM WITHOUT EXPRESSED WRITTEN PERMISSION OF AR. CHINTAN SACHAPARA . ALL DRAWINGS AND RELATED DOCUMENTS SHALL BE RETURNED TO AR. CHINTAN SACHAPARA UPON REQUEST.	IT IS THE RESPONSIBILITY OF THE CLIENT OR THE PROJECT MANAGEMENT COMPANY/ BMC'S ENGINEERS TO CHECK THE COORDINATION OF THE DRAWING WITH SITE BOUNDARIES. AR. CHINTAN SACHAPARA DO NOT HOLD ANY RESPONSIBILITIES IN CASE OF LEGAL CONFLICTS AND /OR MISHANDLED SITE C O O R D I N A T I O N .	 CHINTAN SACHAPARA ARCHITECTS ARCHITECTURE & INTERIOR DESIGN + 9 1 - 9 4 - 2 8 - 4 0 1 - 6 4 0 3, SHAHIBAUG, ABOVE HOMEDCOR, WAGHAWADI ROAD, BHAVNAGAR.
---	---------------------------------	---	--------------------------	--	--	---	--



SITE PLAN

CHINTAN SACHAPARA ARCHITECTS
 ARCHITECTURE & INTERIOR DESIGN
 + 91 11 94 287401 640
 3, SHAHIBAUG, ABOVE HOMEDECOR,
 WAGHAWADI ROAD, BHAVNAGAR.

IT IS THE RESPONSIBILITY OF THE CLIENT OR THE PROJECT MANAGER TO CHECK THE COORDINATION OF THE DRAWING WITH SITE BOUNDARIES. **CHINTAN SACHAPARA** DO NOT HOLD ANY RESPONSIBILITIES IN CASE OF LEGAL CONFLICTS AND/OR MISHANDLED SITE COORDINATION.

THESE DRAWINGS & DESIGNS ARE THE SOLE PROPERTY OF **CHINTAN SACHAPARA** AND AS SUCH SHALL NOT BE REPRODUCED IN ANY FORM WITHOUT EXPRESS WRITTEN PERMISSION OF **CHINTAN SACHAPARA**. ALL DRAWINGS AND RELATED DOCUMENTS SHALL BE RETURNED TO **CHINTAN SACHAPARA** UPON REQUEST.

1) ALL DIMENSIONS ARE IN METERS. 2) ALL DIMENSIONS TO BE READ AND NOT MEASURED. 3) ALL DIMENSIONS ARE FROM UNFINISHED SURFACES. 4) ALL STRUCTURAL DRGS. TO BE READ SIMULTANEOUSLY WITH ARCHITECTURAL DRGS. 5) ALL DIMENSIONS TO BE VERIFIED BY THE CONTRACTOR AND ANY AMBIGUITY TO BE BROUGHT TO THE IMMEDIATE NOTICE OF THE ARCHITECT. 6) ALL INTERNAL WALLS, BEAMS, COLUMNS AND SLABS ARE FINISHED WITH 12.5MM THK. SMOOTH PLASTER UNLESS OTHERWISE SPECIFIED. 7) ALL EXTERNAL WALLS ARE FINISHED WITH 25MM THK. SANDFACED PLASTER UNLESS OTHERWISE SPECIFIED. 8) ALL LEVELS ARE INDICATED CONSIDERING THE EDGE OF APPURTANT ROAD AS + 0000 LVL.

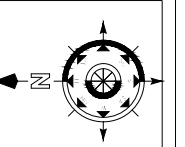

DWG. DATE: 31-03-2023

B.M.C.
 PROPOSED NIGHT SHELTER AT FULSAR T.P. SCHEME, BHAVNAGAR FOR BMC

TITLE: SITE PLAN

PROJECT NO. BMC-03/gd
 DRAWING NO. A3-01

**TENDER
PART-I
TECHNICAL BID**

NAME OF WORK : PROPOSED DEVELOPMENT OF NIGHT SHELTER
AT FULSAR, FOR BHAVNAGAR MUNICIPAL
CORPORATION (B.M.C), BHAVANAGAR

ESTIMATED COST :- 11,99,40,841.00

EARNEST MONEY DEPOSIT :- 12,00,000.00

TIME LIMIT :- 32 months(including Monsoon Period)

**LAST DATE OF ACCEPTING
TENDER :-**

TENDER FEE :-

**21240.00(Non refundable)18000.00+18
%GST(3240.00)=21240.00**

ARCHITECTS:-

CHINTAN SACHAPARA

ARCHITECTS

3,SHAHIBAUG,ABOVE HOME DÉCOR,WAGHA WADI ROAD,

BHAVNAGAR

PHONE : 9428401640

***EXECUTIVE ENGINEER
BUILDING DEPARTMENT
BHAVNAGAR MUNICIPAL CORPORATION
BHAVNAGAR***

**NAME OF WORK :-
PROPOSED DEVELOPMENT OF NIGHT SHELTER AT FULSAR, FOR BHAVNAGAR
MUNICIPAL CORPORATION (B.M.C), BHAVANAGAR**

TECHNICAL BID

SCHEDULE : 'A'

-: STRUCTURE AND ORGANISATION:-

1	Name of the company Address, Telephone No. Telex No. Fax No.	:	
2	Description of Company (For e.g. General Civil Engineering contractor Supplier of equipment etc.)	:	
3	Registration and classification with the P.W.D. in Gujarat/India.	:	
4	Name and address of the Bankers.	:	
5	No. of year of Experience as a general contractor	:	
6	Number of year of Experience as a sub - country.	:	
	In own country Internationally.		
7	Name and address of the companies who will be involved in the construction of various items civil works namely.	:	
	[a] Preconstruction soil investigations. [b] Main work (Building work) [c] Miscellaneous works.		
8	Attached an organization chart showing the structure of the company including names and position of directors and key personal.		
<p>NOTE :</p> <p>[1] The above information shall be supported with documents other wise the same shall be treated as null & void.</p> <p>[2] Particular of above items should be furnished separately for each partner.</p>			

Signature of Bidder

SCHEDULE : 'B'

-: FINANCIAL STATEMENT:-

1	Name of firm		:	
2	Capital			
	[a] Authorized		:	
	[b] Issued & paid up		:	
3	Attach audited balance sheet and profit & loss statement for the last 05 (Five) years. i.e. 2019-20 to 2023-24		:	
4	Financial position			
	[a] Cash		:	
	[b]	(i) Fixed assets	:	
		(ii) Liquid or movable assets	:	
	[c] Current Liabilities		:	
	[d] Working capitals			
		(i) Share capitals	:	
		(ii) Partner's capital	:	
		(iii) Deposit	:	
	[e] Net worth (Excess at current liabilities over liquid or movable assets)		:	

5	<i>Total Liabilities</i>				
	<i>[a] Current ratio</i> <i>(Current assets to current liabilities)</i>				
	<i>[b] Acid test Ratio</i> <i>(Acid tests ratio cash, Temporary investment held in lieu of cash & current Recoverable to current liabilities.</i>				
	<i>[c] Total Liabilities to net worth.</i>				
NOTE :- Information asked against each item is to be carefully filled in more reference to balance sheet in reply to above point is not acceptable.					
6	<i>Annual value Turnover of construction works undertaken for each of the last five (5) Financial years.</i>				
	<i>One year before</i>	<i>Two year before</i>	<i>Three year before</i>	<i>Four year before</i>	<i>Five year before</i>
	<i>2023-24</i>	<i>2022-23</i>	<i>2021-22</i>	<i>2020-21</i>	<i>2019-20</i>
	<i>Home :</i>				
	<i>Abroad :</i>				
7	<i>Net Profit before tax</i>				
	<i>[a] Current period</i>				
	<i>[b] During the last Financial year</i>				
	<i>[c] During each of the four</i>				
	<i>[d] Previous financial years</i> <i>The Profit and loss statements have been certified Through _____ by _____.</i>				
8	<i>Applicant's financial arrangement for proposed work. (Exact amount in Rs. to be mentioned)</i>				
	<i>[a] Own resources</i>				
	<i>Rs.</i>				

	<i>[b] Bank credits</i>	:	Rs.
	<i>[c] Others (Specify)</i>	:	Rs.
9	<i>Certificate of financial soundness from bankers of applicants together with their full address.</i>	:	
10	<i>Approximate value of works in hand.</i>	:	Rs.
11	<i>Value of anticipated orders For next financial year.</i>	:	Rs,
	<i>Home :</i>		
	<i>Abroad :</i>		
<p>Note :- <i>[1] Details of Item No.10 and 11 are to be given in Schedule 'E' & 'F' - certified copies of actual audit report by chartered accountant for the financial year 2019-20 to 2023-24 shall have to be uploaded by scanning.</i></p> <p><i>[2] Information asked against each item shall be carefully filled & any additional information shall be given separately duly signed.</i></p> <p><i>[3] The above information supported by last financial year Balance Sheet/ Profit & Loss account etc. must be audited by the C.A. & I.T.C. shall be furnished.</i></p> <p><i>[4] The above information shall be supported with necessary documents otherwise the same shall be treated as null & void.</i></p>			

Signature of Applicant.

CONTRACT

SCHEDULE : 'C'

PERSONNEL

DETAILS OF PERSONNEL WITH THE APPLICANT

NAME OF THE APPLICANT :-

Sr. No.	Description	On Applicants Pay Roll	
		Civil Work	Electric Work
1	2	3	4
1	Project Manager		
2	Works Manager (Main Civil Works)		
3	Number of Engineering Graduates		
	[a] Design (Civil)		
	[b] Construction Supervision (Civil)		
	[c] Electrical Engineer.		
4	Number of Administrative Graduates		
5	Number of Skilled Employees		
6	Number of Unskilled Employees		
7	[1] In case of personal at Sr. No.1 to 4 please give name, qualification present condition, professional experience and linguistic ability.		
	[2] The certified copy of degree/ diploma engineers, qualification with an affidavit on stamp paper stating their appointment in the firm shall have to be attached with this schedule		
	[3] The above information shall be supported with necessary documents otherwise the same shall be treated as null and void.		

Signature of Applicant.

SCHEDULE : 'D'

NAME OF THE APPLICANT :

The applicant shall provide adequate information to demonstrate clearly that it has the capability to meet the requirements for each and all items of equipment listed below. A separate form shall be prepared for each Item of equipment listed in : Para 9 - 14 of the Instruction to applications, or for alternative purposed - by the applicant.

PLANT & EQUIPMENT PROPOSED TO BE DEPLOYED BY THE APPLICANT FOR USE ON THE ROAD WORK AND BUILDING WORK LAND SCAPING WORK & ELECTRICAL WORK .

Sr. No.	Name of Equipment	Equipment In hand (Owned)			Equipment to be Procured		
		No. of Each	Year of Manu. & Present	Name of Owner	No. on each	Capacity	Through Purchased / Lease.
1	2	3	4	5	6	7	8
1							
2							
3							
4							
5							
6							
7							
8							
9							
10							
11							
12							

NOTE :

[1] *The above information may be furnished for each machinery and equipment listed herewith.*

[2] *The location of machinery should be furnished in detail i.e.*

(i) Site of work (ii) Own workshop (iii) Other places.

[3] *The documents regarding ownership of machinery/ equipment etc. and attested copies of hire purchase agreement if any must be enclosed.*

** If listed indicate the date when the current lease expires.*

*[4] Describe the fabrication and workshop facilities. [a] To be set up at site.
[b] To be sub contracted locally. [c] To be set up at any other place with
relevant details.*

*[5] The above information shall be supported with necessary documents
otherwise, the same shall be treated as null & void.*

*[6] Name of equipments are as per qualification document point number
9.14 A equipment capabilities of building works.*

Signature of Applicant.

SCHEDULE : 'E'

EQUIPMENT CAPABILITY

NAME OF THE APPLICANT :

The applicant shall provide adequate information to demonstrate clearly that. Is has the capability to meet the requirements for each and all items of equipment listed in the instruction to applicants. A separate form shall be prepared for each Item of equipment listed in; Para 9.14 of the Instruction to applicants, or for alternative proposed - by the applicant.

Item of equipment

Equipment Information

- 1. Name of manufacture*
- 2. Model and power rating*
- 3. Capacity*
- 4. Year of manufacturer*

Current Status

- 5. Current location*
- 6. Details of current commitments*

Sources

- 7. Indicate source of the equipment
Owned, Rented leased specially
manufactured.*

Omit the following information for equipment owned by the applicant or partner.

Owner

8. Name of Owner

9. Address of Owner

10 Contract Name and Title

11. Telephone

12. Fax

13. Telex

Agreement :- Details of Rental/ Lease manufacture agreement specified to the Project.

Signature of Applicant.

SCHEDULE : 'F'

EXPERIENCE: - Relevant (**Building work, Electrical work,**) Project Completed.

Please furnish information about the relevant project (**Building work, Electrical work**) completed over the last five years

Name of the employer	Name of location and type of building contracted	Name of engineer responsible for supervision	Contract price (Rs.in lacs)	Final value as per bill prepared by employer	Additional amount realised if any through court claims or by awarded or arbitrator	Date of work order	Stipulated date of completion of work	Actual date of completion	Reasons for delay in completion if any
1	2	3	4	5	6	7A	7B	7C	8

NOTE :

- [1] Attested copies of the latest certificate from the employers may be attached.
- [2] Non disclosures of any information in the schedule will result in disqualification of the firm.
- [3] In case of private work sufficient authentic proof of work done. Along with evidence of financial transactions shall have to be furnished.

Signature of Applicant.

SCHEDULE : 'G'

EXPERIENCE :- Relevant (**Building work**) Project In progress.

*Give information about the relevant project (**Building work**) in progress including the works for which the company has received a letter of intent but a formal contract has not yet been awarded*

<i>Name of the employer</i>	<i>Name of engineer responsible for supervision</i>	<i>Location and description of building works</i>	<i>Value of contract</i>	<i>Value of completed and certified</i>	<i>Percentage of practical completion</i>	<i>Date of work order</i>	<i>Stipulated date of completion of work</i>	<i>Likely completion date</i>	<i>Reasons for delay in completion if any</i>
1	2	3	4	5	6	7A	7B	7C	8

NOTE :

- [1] *Attested copies of the latest certificate from the employers may be attached.*
- [2] *Non disclosures of any information in the schedule will result in disqualification of the firm.*
- [3] *In case of private work sufficient authentic proof of work done. Along with evidence of financial transactions shall have to be furnished.*

Signature of Applicant.

SCHEDULE : 'H'

STATEMENT OF WORKS UNDER LITIGATION

<i>Year</i>	<i>Award for work</i>	<i>Name of Client/ cause of litigation and matter in Disputed (Amount in Rs.)</i>

Signature of Applicant.

CONTRACT

SCHEDULE : 'I'

ADDITIONAL INFORMATION

The applicant can add here any further information relevant to the evaluation of their qualifying criteria.

Signature of Applicant.

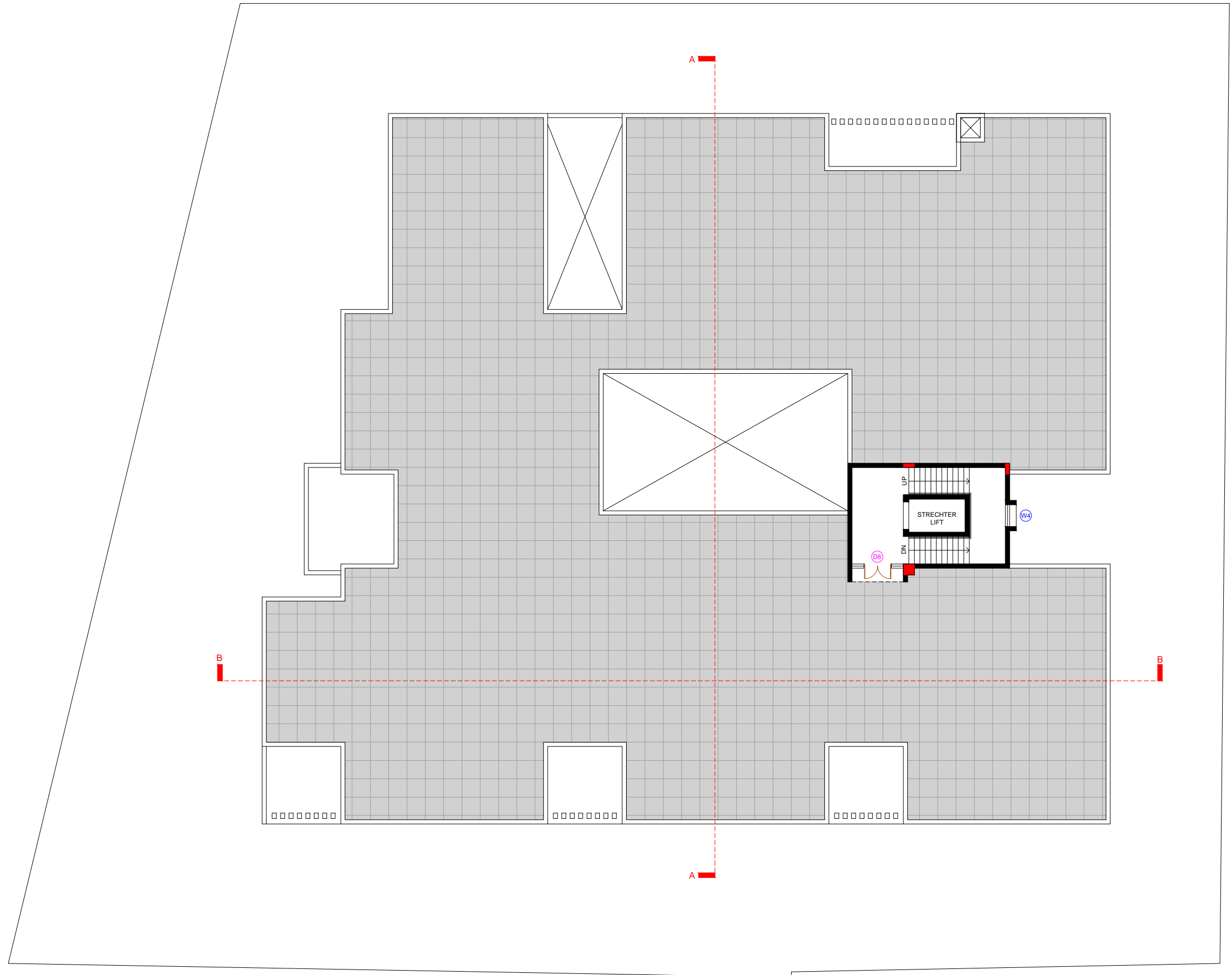

PROJECT NO.
BMC -03/gd
 DRAWING NO.
A3-04

TITLE :-
TERRACE FLOOR PLAN

B.M.C.
 PROPOSED NIGHT SHELTER AT FULSAR T.P. SCHEME, BHAVNAGAR FOR BMC

DWG.DATE:-
 31 -03 -2023

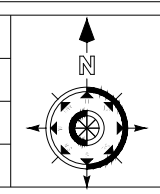

1) ALL DIMENSIONS ARE IN METERS. 2) ALL DIMENSIONS TO BE READ AND NOT MEASURED. 3) ALL DIMENSIONS ARE FROM UNFINISHED SURFACES. 4) ALL STRUCTURAL DRGS. TO BE READ SIMULTANEOUSLY WITH ARCHITECTURAL DRGS. 5) ALL DIMENSIONS TO BE VERIFIED BY THE CONTRACTOR AND ANY AMBIGUITY TO BE BROUGHT TO THE IMMEDIATE NOTICE OF THE ARCHITECT. 6) ALL INTERNAL WALLS, BEAMS, COLUMNS AND SLABS ARE FINISHED WITH 12.5MM THK. SMOOTH PLASTER UNLESS OTHERWISE SPECIFIED. 7) ALL EXTERNAL WALLS ARE FINISHD WITH 25MM. THK. SANDFACED PLASTER UNLESS OTHERWISE SPECIFIED. 8) ALL LEVELS ARE INDICATED CONSIDERING THE EDGE OF APPERTANT ROAD AS + 0000 LVL.

THESE DRAWINGS & DESIGNS ARE THE SOLE PROPERTY OF **AR. CHINTAN SACHAPARA** AND AS SUCH SHALL NOT BE REPRODUCED IN ANY FORM WITHOUT EXPRESSED WRITTEN PERMISSION OF **AR. CHINTAN SACHAPARA**. ALL DRAWINGS AND RELATED DOCUMENTS SHALL BE RETURNED TO **AR. CHINTAN SACHAPARA** UPON REQUEST.

IT IS THE RESPONSIBILITY OF THE CLIENT OR THE PROJECT MANAGEMENT COMPANY/ BMC'S ENGINEERS TO CHECK THE COORDINATION OF THE DRAWING WITH SITE BOUNDARIES. **AR. CHINTAN SACHAPARA** DO NOT HOLD ANY RESPONSIBILITIES IN CASE OF LEGAL CONFLICTS AND /OR MISHANDLED SITE COORDINATION.

CHINTAN SACHAPARA ARCHITECTS
 ARCHITECTURE & INTERIOR DESIGN
 + 9 1 - 9 4 - 2 8 - 4 0 1 - 6 4 0
 3, SHAHIBAUG, ABOVE HOMEDCOR,
 WAGHAWADI ROAD, BHAVNAGAR.

GROUND FLOOR PLAN

BEDS CAPACITY AT G.F. LEVEL

Ward	Bed No.	Bath	WC	Urinal	Basin
Male Senior Citizen Ward	48	04	05	07	04
Female Senior Citizen Ward	48	04	05		04
Multi Purpose		04	05	04	04
Total	96	12	15	11	12

BUILT UP AREA CALCULATION

Area	Sq Mtr
Plot Area	3173 smt
Ground Floor Plan	1513 smt
First Floor Plan	1475 smt
Terrace Floor Plan	53 smt
Total Area	3041 smt

DOOR WINDOW SCHEDULE

WINDOW	Size
W1	2.30 x 2.40
W2	1.00 x 2.40
W3	0.60 x 0.60
W4	1.20 x 1.20
W5	0.65 x 2.40
V1	1.40 x 0.60
V2	0.6 x 0.90
V3	1.20 x 0.60
D/W	1.40 x 2.40
D/W 1	2.25 x 2.40
D/W 2	2.65 x 2.40

DOOR	Size
D1	2.40 x 2.40
D2	2.00 x 2.40
D3	1.80 x 2.40
D4	0.90 x 2.40
D5	0.75 x 2.40
D6	1.20 x 2.40
D7	1.00 x 2.40
D8	1.50 x 2.40



PROJECT NO.
BMC -03/gd

DRAWING NO.
A3-02

TITLE :-
GROUND FLOOR PLAN

B.M.C.
PROPOSED NIGHT SHELTER AT FULSAR T.P. SCHEME, BHAVNAGAR FOR BMC

DWG.DATE:-
31-03-2023

1) ALL DIMENSIONS ARE IN METERS. 2) ALL DIMENSIONS TO BE READ AND NOT MEASURED. 3) ALL DIMENSIONS ARE FROM UNFINISHED SURFACES. 4) ALL STRUCTURAL DRGS. TO BE READ SIMULTANEOUSLY WITH ARCHITECTURAL DRGS. 5) ALL DIMENSIONS TO BE VERIFIED BY THE CONTRACTOR AND ANY AMBIGUITY TO BE BROUGHT TO THE IMMEDIATE NOTICE OF THE ARCHITECT. 6) ALL INTERNAL WALLS, BEAMS, COLUMNS AND SLABS ARE FINISHED WITH 12.5MM THK. SMOOTH PLASTER UNLESS OTHERWISE SPECIFIED. 7) ALL EXTERNAL WALLS ARE FINISH WITH 25MM. THK. SANDFACED PLASTER UNLESS OTHERWISE SPECIFIED. 8) ALL LEVELS ARE INDICATED CONSIDERING THE EDGE OF APPERTANT ROAD AS + 0000 LVL.

THESE DRAWINGS & DESIGNS ARE THE SOLE PROPERTY OF **AR. CHINTAN SACHAPARA** AND AS SUCH SHALL NOT BE REPRODUCED IN ANY FORM WITHOUT EXPRESSED WRITTEN PERMISSION OF **AR. CHINTAN SACHAPARA**. ALL DRAWINGS AND RELATED DOCUMENTS SHALL BE RETURNED TO **AR. CHINTAN SACHAPARA** UPON REQUEST.

IT IS THE RESPONSIBILITY OF THE CLIENT OR THE PROJECT MANAGEMENT COMPANY/ BMC'S ENGINEERS TO CHECK THE COORDINATION OF THE DRAWING WITH SITE BOUNDARIES. **AR. CHINTAN SACHAPARA** DO NOT HOLD ANY RESPONSIBILITIES IN CASE OF LEGAL CONFLICTS AND/OR MISHANDLED SITE COORDINATION.

CHINTAN SACHAPARA ARCHITECTS
ARCHITECTURE & INTERIOR DESIGN
+ 91 - 94 - 28 - 401 - 640
3, SHAHIBAUG, ABOVE HOMEDECOR, WAGHAWADI ROAD, BHAVNAGAR.

TENDER SHEET

**PROPOSED DEVELOPMENT OF NIGHT SHELTER AT FULSAR, FOR BHAVNAGAR MUNICIPAL CORPORATION
(B.M.C), BHAVANAGAR**

(CIVIL WORK & PLUMBING, SANITARY+ELECTRICAL WORKS)+FURNITURE+ELEVATOR+FIRE+GYM EQUIPMENTS

// BILL OF QUANTITY //

It	Description	Qty	Rate	Per	Amount
1	Clearing and grubbing road land including uprooting rank vegetation grass bushes,shrubs,sapling and trees girth up to 300 mm removal of stumps of trees cut earlier and disposal of unserviceable materials (C) By mechanical means in area of light jungle	0.32	28111.92	Hectare	8995.81
2	Excavation for foundation upto1.50 MT depth including sorting out and stacking of useful materials and disposing the excavated stuff up to all leads (A) loose or Soft Soil	3518.84	243.92	Cum	858315.45
3	Excavation for foundation upto1.50 MT depth including sorting out and stacking of useful materials and disposing the excavated stuff up to all leads (B) Dense or Hard Soil	2899.19	276.19	Cum	800727.29
4	Excavation for foundation for depth from 1.5 m to 3.0 m including sorting out and stacking of useful materials and disposing off the excavated stuff upto 50 Meter lead. (B) Dense or Hard soil	2611.80	288.77	Cum	754209.49
5	Excavation for foundation for depth from 1.5 m to 3.0 m including sorting out and stacking of useful materials and disposing off the excavated stuff upto 50 Meter lead. (C) Hard Murrum	2374.23	398.83	Cum	946914.15
6	Excavation for foundation for depth from 3.00 m to 6.0 m including sorting out and stacking of useful materials and disposing off the excavated stuff upto 50 Meter lead. (C) Hard Murrum	3299.92	439.65	Cum	1450809.83
7	Dewatering In all sorts of soil and soft murrum,hard murrum and bulders, soft rock, hard rock up to 1.50 mt depth from G.L.	4748.46	17.00	Cum	80723.82

8	Extra for dewatering in all sorts of strata's for each 1.50 mt or part thereof beyond 1.50 mt depth.	4748.46	10.00	Cum	47484.60
9	Boring holes 4.50 m deep in ordinary soil (for cast in situ piles) and getting out the soil and disposal of the surplus excavated soil as directed within a lead of 50 Meter for following diameter of pipes.(iii) 300 mm	40	1,997.56	EA	79902.40
10	Extra for under reaming inside the bore holes for under reamed piles of following diameter .(iii) 300 mm	40	626.18	EA	25047.20
11	Filling in foundation and plinth with murrum or selected soil in layers of 20 cm. Thickness including watering ramming and consolidating etc. comp.	12780.11	286.20	Cum	3657667.48
12	Filling available excavated earth (excluding rock) intrenches. plinth, sides of foundations etc. in layers not exceeding 20 cm. in depth consolidating each disposedv layer by ramming and watering.	13519.20	129.10	Cum	1745328.72
13	Providing and laying in position Ready Mixed M-150 grade concrete for reinforced cement conctere work , using cement content as per approved Design Mix manufactured in fully automatic batching plant and transported to site of work in transit mixer for a lead up to 10 kms having continuous agitated mixer, manufactured as per mix design of specified grade for reinforced cement concrete work including pumping of R.M.C. from transit mixer to site of laying, including the cost of centering shuttering finishing and excluding the cost of reinforcement including cost of admixtures in recommended proportions as per IS: 9103 to accelerate/retard setting of concrete, improve workability without impairing strength and durability as per direction of the Engineer - in - charge. Without Fly Ash (Min cement level as per latest IS 456 shall be maintained)	657.63	4281.00	Cum	2815314.03

14	<p>Providing and laying in position Ready Mixed M-300 grade concrete for reinforced cement concrete work , using cement content as per approved Design Mix manufactured in fully automatic batching plant and transported to site of work in transit mixer for a lead up to 10 kms having continuous agitated mixer, manufactured as per mix design of specified grade for reinforced cement concrete work including pumping of R.M.C. from transit mixer to site of laying, including the cost of centering shuttering finishing and excluding the cost of reinforcement including cost of admixtures in recommended proportions as per IS: 9103 to accelerate/ retard setting of concrete, improve workability without impairing strength and durability as per direction of the Engineer - in - charge. Without Fly Ash (Min cement level as per latest IS 456 shall be maintained) (Cement level 475kg)</p> <p>for R.C.C.piles 230/300</p>	17.6	5,043.66	cum	88768.42
15	<p>Providing and laying in position Ready Mixed M-300 grade concrete for reinforced cement concrete work , using cement content as per approved Design Mix manufactured in fully automatic batching plant and transported to site of work in transit mixer for a lead up to 10 kms having continuous agitated mixer, manufactured as per mix design of specified grade for reinforced cement concrete work including pumping of R.M.C. from transit mixer to site of laying, including the cost of centering shuttering finishing and excluding the cost of reinforcement including cost of admixtures in recommended proportions as per IS: 9103 to accelerate/ retard setting of concrete, improve workability without impairing strength and durability as per direction of the Engineer - in - charge. Without Fly Ash (Min cement level as per latest IS 456 shall be maintained) (Cement level 475kg):</p> <p>R.C.C Pile Cap</p>	3.65	5534.00	Cum	20199.10

16	<p>Providing and laying in position Ready Mixed M-300 grade concrete for reinforced cement concrete work , using cement content as per approved Design Mix manufactured in fully automatic batching plant and transported to site of work in transit mixer for a lead up to 10 kms having continuous agitated mixer, manufactured as per mix design of specified grade for reinforced cement concrete work including pumping of R.M.C. from transit mixer to site of laying, including the cost of centering shuttering finishing and excluding the cost of reinforcement including cost of admixtures in recommended proportions as per IS: 9103 to accelerate/ retard setting of concrete, improve workability without impairing strength and durability as per direction of the Engineer - in - charge. Without Fly Ash (Min cement level as per latest IS 456 shall be maintained) (Cement level 475 kg)</p> <p>(a) Foundations, footings Bases of columns</p>	683.96	5534.00	Cum	3785034.64
17	<p>Providing and laying in position Ready Mixed M-250 grade concrete for reinforced cement concrete work , using cement content as per approved Design Mix manufactured in fully automatic batching plant and transported to site of work in transit mixer for a lead up to 10 kms having continuous agitated mixer, manufactured as per mix design of specified grade for reinforced cement concrete work including pumping of R.M.C. from transit mixer to site of laying, including the cost of centering shuttering finishing and excluding the cost of reinforcement including cost of admixtures in recommended proportions as per IS: 9103 to accelerate/ retard setting of concrete, improve workability without impairing strength and durability as per direction of the Engineer - in - charge. Without Fly Ash (Min cement level as per latest IS 456 shall be maintained) (Cement level 475 kg) in</p> <p>Beams, girders and cantilever up to floor For GROUND FLOOR</p>	375.68	6983.00	Cum	2623373.44

18	<p>Providing and laying in position Ready Mixed M-250 grade concrete for reinforced cement concrete work , using cement content as per approved Design Mix manufactured in fully automatic batching plant and transported to site of work in transit mixer for a lead up to 10 kms having continuous agitated mixer, manufactured as per mix design of specified grade for reinforced cement concrete work including pumping of R.M.C. from transit mixer to site of laying, including the cost of centering shuttering finishing and excluding the cost of reinforcement including cost of admixtures in recommended proportions as per IS: 9103 to accelerate/ retard setting of concrete, improve workability without impairing strength and durability as per direction of the Engineer - in - charge. Without Fly Ash (Min cement level as per latest IS 456 shall be maintained) (Cement level 450 kg) in Beams, girders and cantilever up to floor For FIRST FLOOR</p>	152.46			
19	<p>Providing and laying in position Ready Mixed M-250 grade concrete for reinforced cement concrete work , using cement content as per approved Design Mix manufactured in fully automatic batching plant and transported to site of work in transit mixer for a lead up to 10 kms having continuous agitated mixer, manufactured as per mix design of specified grade for reinforced cement concrete work including pumping of R.M.C. from transit mixer to site of laying, including the cost of centering shuttering finishing and excluding the cost of reinforcement including cost of admixtures in recommended proportions as per IS: 9103 to accelerate/ retard setting of concrete, improve workability without impairing strength and durability as per direction of the Engineer - in - charge. Without Fly Ash (Min cement level as per latest IS 456 shall be maintained) (Cement level 450 kg) in Beams, girders and cantilever up to floor For SECOND FLOOR</p>	10.05	7022.85	Cum	1070703.71
			7062.70	Cum	70980.14

20	<p>Providing and laying in position Ready Mixed M-300 grade concrete for reinforced cement concrete work , using cement content as per approved Design Mix manufactured in fully automatic batching plant and transported to site of work in transit mixer for a lead up to 10 kms having continuous agitated mixer, manufactured as per mix design of specified grade for reinforced cement concrete work including pumping of R.M.C. from transit mixer to site of laying, including the cost of centering shuttering finishing and excluding the cost of reinforcement including cost of admixtures in recommended proportions as per IS: 9103 to accelerate/ retard setting of concrete, improve workability without impairing strength and durability as per direction of the Engineer - in - charge. Without Fly Ash (Min cement level as per latest IS 456 shall be maintained) (Cement level 475 kg) IN Columns, pillars, posts and struts for GROUND FLOOR COLUMN UP TO PLINTH LEVEL</p>	132.02	8025.00	Cum	1059460.50
21	<p>Providing and laying in position Ready Mixed M-250 grade concrete for reinforced cement concrete work , using cement content as per approved Design Mix manufactured in fully automatic batching plant and transported to site of work in transit mixer for a lead up to 10 kms having continuous agitated mixer, manufactured as per mix design of specified grade for reinforced cement concrete work including pumping of R.M.C. from transit mixer to site of laying, including the cost of centering shuttering finishing and excluding the cost of reinforcement including cost of admixtures in recommended proportions as per IS: 9103 to accelerate/ retard setting of concrete, improve workability without impairing strength and durability as per direction of the Engineer - in - charge. Without Fly Ash (Min cement level as per latest IS 456 shall be maintained) (Cement level 450 kg) IN Columns, pillars, posts and struts for GROUND FLOOR COLUMN UP TO GROUND FLOOR SLAB LEVEL</p>	107.79	7835.00	Cum	844534.65

22	<p>Providing and laying in position Ready Mixed M-250 grade concrete for reinforced cement concrete work , using cement content as per approved Design Mix manufactured in fully automatic batching plant and transported to site of work in transit mixer for a lead up to 10 kms having continuous agitated mixer, manufactured as per mix design of specified grade for reinforced cement concrete work including pumping of R.M.C. from transit mixer to site of laying, including the cost of centering shuttering finishing and excluding the cost of reinforcement including cost of admixtures in recommended proportions as per IS: 9103 to accelerate/ retard setting of concrete, improve workability without impairing strength and durability as per direction of the Engineer - in - charge. Without Fly Ash (Min cement level as per latest IS 456 shall be maintained) (Cement level 475 kg) IN Columns, pillars, posts and struts for FIRST FLOOR COLUMN all floor above floor two level</p>	96.59			
			7874.85	Cum	760631.76
23	<p>Providing and laying in position Ready Mixed M-250 grade concrete for reinforced cement concrete work , using cement content as per approved Design Mix manufactured in fully automatic batching plant and transported to site of work in transit mixer for a lead up to 10 kms having continuous agitated mixer, manufactured as per mix design of specified grade for reinforced cement concrete work including pumping of R.M.C. from transit mixer to site of laying, including the cost of centering shuttering finishing and excluding the cost of reinforcement including cost of admixtures in recommended proportions as per IS: 9103 to accelerate/ retard setting of concrete, improve workability without impairing strength and durability as per direction of the Engineer - in - charge. Without Fly Ash (Min cement level as per latest IS 456 shall be maintained) (Cement level 450 kg) IN Columns, pillars, posts and struts for SECOND FLOOR COLUMN all floor above floor two level</p>	26.75			
			7914.70	Cum	211718.23

24	<p>Providing and laying in position Ready Mixed M-250 grade concrete for reinforced cement concrete work , using cement content as per approved Design Mix manufactured in fully automatic batching plant and transported to site of work in transit mixer for a lead up to 10 kms having continuous agitated mixer, manufactured as per mix design of specified grade for reinforced cement concrete work including pumping of R.M.C. from transit mixer to site of laying, including the cost of centering shuttering finishing and excluding the cost of reinforcement including cost of admixtures in recommended proportions as per IS: 9103 to accelerate/ retard setting of concrete, improve workability without impairing strength and durability as per direction of the Engineer - in - charge. Without Fly Ash (Min cement level as per latest IS 456 shall be maintained) (Cement level 450 kg) IN R.C.C Lintel for all thickness etc comp. FOR GROUND FLOOR</p>	42.38	7852.00	Cum	332767.76
25	<p>Providing and laying in position Ready Mixed M-250 grade concrete for reinforced cement concrete work , using cement content as per approved Design Mix manufactured in fully automatic batching plant and transported to site of work in transit mixer for a lead up to 10 kms having continuous agitated mixer, manufactured as per mix design of specified grade for reinforced cement concrete work including pumping of R.M.C. from transit mixer to site of laying, including the cost of centering shuttering finishing and excluding the cost of reinforcement including cost of admixtures in recommended proportions as per IS: 9103 to accelerate/ retard setting of concrete, improve workability without impairing strength and durability as per direction of the Engineer - in - charge. Without Fly Ash (Min cement level as per latest IS 456 shall be maintained) (Cement level 475 kg) in R.C.C Lintel for all thickness etc comp. FOR FIRST FLOOR</p>	38.37	7891.85	Cum	302810.28

26	<p>Providing and laying in position Ready Mixed M-250 grade concrete for reinforced cement concrete work , using cement content as per approved Design Mix manufactured in fully automatic batching plant and transported to site of work in transit mixer for a lead up to 10 kms having continuous agitated mixer, manufactured as per mix design of specified grade for reinforced cement concrete work including pumping of R.M.C. from transit mixer to site of laying, including the cost of centering shuttering finishing and excluding the cost of reinforcement including cost of admixtures in recommended proportions as per IS: 9103 to accelerate/ retard setting of concrete, improve workability without impairing strength and durability as per direction of the Engineer - in - charge. Without Fly Ash (Min cement level as per latest IS 456 shall be maintained) (Cement level 450 kg) in R.C.C Lintel for all thickness etc comp. FOR SECOND FLOOR</p>	2.01	7931.70	Cum	15942.72
27	<p>Providing and laying in position Ready Mixed M-250 grade concrete for reinforced cement concrete work , using cement content as per approved Design Mix manufactured in fully automatic batching plant and transported to site of work in transit mixer for a lead up to 10 kms having continuous agitated mixer, manufactured as per mix design of specified grade for reinforced cement concrete work including pumping of R.M.C. from transit mixer to site of laying, including the cost of centering shuttering finishing and excluding the cost of reinforcement including cost of admixtures in recommended proportions as per IS: 9103 to accelerate/ retard setting of concrete, improve workability without impairing strength and durability as per direction of the Engineer - in - charge. Without Fly Ash (Min cement level as per latest IS 456 shall be maintained) (Cement level 450 kg) in R.C.C. Flat slabs for all thickness for up to floor two level GROUND FLOOR</p>	476.22	6583.00	Cum	3134956.26

28	<p>Providing and laying in position Ready Mixed M-250 grade concrete for reinforced cement concrete work , using cement content as per approved Design Mix manufactured in fully automatic batching plant and transported to site of work in transit mixer for a lead up to 10 kms having continuous agitated mixer, manufactured as per mix design of specified grade for reinforced cement concrete work including pumping of R.M.C. from transit mixer to site of laying, including the cost of centering shuttering finishing and excluding the cost of reinforcement including cost of admixtures in recommended proportions as per IS: 9103 to accelerate/ retard setting of concrete, improve workability without impairing strength and durability as per direction of the Engineer - in - charge. Without Fly Ash (Min cement level as per latest IS 456 shall be maintained) (Cement level 475 kg) in R.C.C. Flat slabs for all thickness for FIRST FLOOR</p>	213.48			
29	<p>Providing and laying in position Ready Mixed M-250 grade concrete for reinforced cement concrete work , using cement content as per approved Design Mix manufactured in fully automatic batching plant and transported to site of work in transit mixer for a lead up to 10 kms having continuous agitated mixer, manufactured as per mix design of specified grade for reinforced cement concrete work including pumping of R.M.C. from transit mixer to site of laying, including the cost of centering shuttering finishing and excluding the cost of reinforcement including cost of admixtures in recommended proportions as per IS: 9103 to accelerate/ retard setting of concrete, improve workability without impairing strength and durability as per direction of the Engineer - in - charge. Without Fly Ash (Min cement level as per latest IS 456 shall be maintained) (Cement level 450 kg) in R.C.C. Flat slabs for all thickness for SECOND FLOOR</p>	7.77	6622.85	Cum	1413846.02
			6662.70	Cum	51769.18

30	<p>Providing and laying in position Ready Mixed M-250 grade concrete for reinforced cement concrete work , using cement content as per approved Design Mix manufactured in fully automatic batching plant and transported to site of work in transit mixer for a lead up to 10 kms having continuous agitated mixer, manufactured as per mix design of specified grade for reinforced cement concrete work including pumping of R.M.C. from transit mixer to site of laying, including the cost of centering shuttering finishing and excluding the cost of reinforcement including cost of admixtures in recommended proportions as per IS: 9103 to accelerate/ retard setting of concrete, improve workability without impairing strength and durability as per direction of the Engineer - in - charge. Without Fly Ash (Min cement level as per latest IS 456 shall be maintained) (Cement level 450 kg) in coping up to floor two level. For GROUND FLOOR</p>	32.08	7852.00	Cum	251892.16
31	<p>Providing and laying in position Ready Mixed M-250 grade concrete for reinforced cement concrete work , using cement content as per approved Design Mix manufactured in fully automatic batching plant and transported to site of work in transit mixer for a lead up to 10 kms having continuous agitated mixer, manufactured as per mix design of specified grade for reinforced cement concrete work including pumping of R.M.C. from transit mixer to site of laying, including the cost of centering shuttering finishing and excluding the cost of reinforcement including cost of admixtures in recommended proportions as per IS: 9103 to accelerate/ retard setting of concrete, improve workability without impairing strength and durability as per direction of the Engineer - in - charge. Without Fly Ash (Min cement level as per latest IS 456 shall be maintained) (Cement level 475 kg) in coping up to floor two level. For ALL FLOOR ABOVE FLOOR TWO LEVEL SECOND FLOOR</p>	12.09	7931.70	Cum	95894.25

32	<p>Providing and laying in position Ready Mixed M-250 grade concrete for reinforced cement concrete work , using cement content as per approved Design Mix manufactured in fully automatic batching plant and transported to site of work in transit mixer for a lead up to 10 kms having continuous agitated mixer, manufactured as per mix design of specified grade for reinforced cement concrete work including pumping of R.M.C. from transit mixer to site of laying, including the cost of centering shuttering finishing and excluding the cost of reinforcement including cost of admixtures in recommended proportions as per IS: 9103 to accelerate/ retard setting of concrete, improve workability without impairing strength and durability as per direction of the Engineer - in - charge. Without Fly Ash (Min cement level as per latest IS 456 shall be maintained) (Cement level 450 kg) in R.C.C. Chajja up to floor two level. For ground floor</p>	12.29	6638.00	Cum	81581.02
33	<p>Providing and laying in position Ready Mixed M-250 grade concrete for reinforced cement concrete work , using cement content as per approved Design Mix manufactured in fully automatic batching plant and transported to site of work in transit mixer for a lead up to 10 kms having continuous agitated mixer, manufactured as per mix design of specified grade for reinforced cement concrete work including pumping of R.M.C. from transit mixer to site of laying, including the cost of centering shuttering finishing and excluding the cost of reinforcement including cost of admixtures in recommended proportions as per IS: 9103 to accelerate/ retard setting of concrete, improve workability without impairing strength and durability as per direction of the Engineer - in - charge. Without Fly Ash (Min cement level as per latest IS 456 shall be maintained) (Cement level 450 kg) in R.C.C. Chajja ALL FLOOR ABOVE FLOOR TWO LEVEL FIRST FLOOR</p>	17.79	6677.85	Cum	118798.95

34	<p>Providing and laying in position Ready Mixed M-250 grade concrete for reinforced cement concrete work , using cement content as per approved Design Mix manufactured in fully automatic batching plant and transported to site of work in transit mixer for a lead up to 10 kms having continuous agitated mixer, manufactured as per mix design of specified grade for reinforced cement concrete work including pumping of R.M.C. from transit mixer to site of laying, including the cost of centering shuttering finishing and excluding the cost of reinforcement including cost of admixtures in recommended proportions as per IS: 9103 to accelerate/ retard setting of concrete, improve workability without impairing strength and durability as per direction of the Engineer - in - charge. Without Fly Ash (Min cement level as per latest IS 456 shall be maintained) (Cement level 475 kg) in R.C.C. Chajja all floor above floor two level. For SECOND floor</p>	0.44	6717.70	Cum	2955.79
35	<p>Providing and laying in position Ready Mixed M-250 grade concrete for reinforced cement concrete work , using cement content as per approved Design Mix manufactured in fully automatic batching plant and transported to site of work in transit mixer for a lead up to 10 kms having continuous agitated mixer, manufactured as per mix design of specified grade for reinforced cement concrete work including pumping of R.M.C. from transit mixer to site of laying, including the cost of centering shuttering finishing and excluding the cost of reinforcement including cost of admixtures in recommended proportions as per IS: 9103 to accelerate/ retard setting of concrete, improve workability without impairing strength and durability as per direction of the Engineer - in - charge. Without Fly Ash (Min cement level as per latest IS 456 shall be maintained) (Cement level 450 kg) in R.C.C. Stair case up to floor two level. For ground floor</p>	3.94	7105.00	Cum	27993.70

36	<p>Providing and laying in position Ready Mixed M-250 grade concrete for reinforced cement concrete work , using cement content as per approved Design Mix manufactured in fully automatic batching plant and transported to site of work in transit mixer for a lead up to 10 kms having continuous agitated mixer, manufactured as per mix design of specified grade for reinforced cement concrete work including pumping of R.M.C. from transit mixer to site of laying, including the cost of centering shuttering finishing and excluding the cost of reinforcement including cost of admixtures in recommended proportions as per IS: 9103 to accelerate/ retard setting of concrete, improve workability without impairing strength and durability as per direction of the Engineer - in - charge. Without Fly Ash (Min cement level as per latest IS 456 shall be maintained) (Cement level 450 kg) in R.C.C. Stair case For FIRST FLOOR</p>	3.94	7144.85	Cum	28150.71
37	<p>Providing and laying in position Ready Mixed M-250 grade concrete for reinforced cement concrete work , using cement content as per approved Design Mix manufactured in fully automatic batching plant and transported to site of work in transit mixer for a lead up to 10 kms having continuous agitated mixer, manufactured as per mix design of specified grade for reinforced cement concrete work including pumping of R.M.C. from transit mixer to site of laying, including the cost of centering shuttering finishing and excluding the cost of reinforcement including cost of admixtures in recommended proportions as per IS: 9103 to accelerate/ retard setting of concrete, improve workability without impairing strength and durability as per direction of the Engineer - in - charge. Without Fly Ash (Min cement level as per latest IS 456 shall be maintained) (Cement level 475 kg) in R.C.C.WALL/Pardi FOR ARCH or all thickness and cantilever up to floor two level. FOR GROUND FLOOR UP TO FLOOR TWO LEVEL</p>	467.87	7049.00	Cum	3298015.63

38	<p>Providing and laying in position Ready Mixed M-250 grade concrete for reinforced cement concrete work , using cement content as per approved Design Mix manufactured in fully automatic batching plant and transported to site of work in transit mixer for a lead up to 10 kms having continuous agitated mixer, manufactured as per mix design of specified grade for reinforced cement concrete work including pumping of R.M.C. from transit mixer to site of laying, including the cost of centering shuttering finishing and excluding the cost of reinforcement including cost of admixtures in recommended proportions as per IS: 9103 to accelerate/ retard setting of concrete, improve workability without impairing strength and durability as per direction of the Engineer - in - charge. Without Fly Ash (Min cement level as per latest IS 456 shall be maintained) (Cement level 450 kg) in R.C.C.WALL/Pardi FOR ARCH or all thickness and cantilever up to floor two level. for FIRST FLOOR all floor above floor two level</p>	11.20	7088.85	Cum	79395.12
39	<p>Providing and laying in position Ready Mixed M-250 grade concrete for reinforced cement concrete work , using cement content as per approved Design Mix manufactured in fully automatic batching plant and transported to site of work in transit mixer for a lead up to 10 kms having continuous agitated mixer, manufactured as per mix design of specified grade for reinforced cement concrete work including pumping of R.M.C. from transit mixer to site of laying, including the cost of centering shuttering finishing and excluding the cost of reinforcement including cost of admixtures in recommended proportions as per IS: 9103 to accelerate/ retard setting of concrete, improve workability without impairing strength and durability as per direction of the Engineer - in - charge. Without Fly Ash (Min cement level as per latest IS 456 shall be maintained) (Cement level 450 kg) in R.C.C.WALL/Pardi FOR ARCH or all thickness and cantilever up to floor two level. for SECOND FLOOR all floor above floor two level</p>	4.98	7128.70	Cum	35500.93

40	Providing and laying in position Ready Mixed M-250 grade concrete for reinforced cement concrete work , using cement content as per approved Design Mix manufactured in fully automatic batching plant and transported to site of work in transit mixer for a lead up to 10 kms having continuous agitated mixer, manufactured as per mix design of specified grade for reinforced cement concrete work including pumping of R.M.C. from transit mixer to site of laying, including the cost of centering shuttering finishing and excluding the cost of reinforcement including cost of admixtures in recommended proportions as per IS: 9103 to accelerate/ retard setting of concrete, improve workability without impairing strength and durability as per direction of the Engineer - in - charge. Without Fly Ash (Min cement level as per latest IS 456 shall be maintained) (Cement level 450 kg) in out side floor by trimix up to floor two level. and dewatering the floor with vaccum pump and top finished with power trowel compactor and double beam screed vibrator and making groove in the floor and fill with asphalt as directed by Architect/EIC.	180.70			
			9113.00	CUM	1646719.10
41	Providing FE-500D TMT STEEL (Code 1786-2008) reinforcement for RCC work including cutting bending, binding and placing in position for All floor	347464.52			
			76.45	Kg.	26563662.55
42	Rammed Rubble soling With Lean Mix cement mortar (CM 1:10) Preferably Joint fill up with lime mortar 1:4 etc. comp.	571.15			
			2131.00	Cum	1217120.65
43	Brick work using common Brunt clay building bricks having crushing strength not less than 35 Kg./Sqcm. In Super structure above plinth level in cement mortar 1:6 (1cement : 6 fine sand) Conventional for ground floor(BRICK MASONARY) FOR PLINTH	227.26			
			3981.21	Cum	904769.78
44	Brick work using common Brunt clay building bricks having crushing strength not less than 35 Kg./Sqcm. In Super structure above plinth level in cement mortar 1:6 (1cement : 6 fine sand) Conventional for ground floor(BRICK MASONARY)	524.48			
			4246.65	Cum	2227282.99
45	Brick work using common Brunt clay building bricks having crushing strength not less than 35 Kg./Sqcm. In Super structure above plinth level in cement mortar 1:6 (1cement : 6 fine sand) Conventional for all floor above floor two level FIRST FLOOR	437.54			
			4286.44	Cum	1875488.96

46	Brick work using common Brunt clay building bricks having crushing strength not less than 35 Kg./Sqcm. In Super structure above plinth level in cement mortar 1:6 (1cement : 6 fine sand) Conventional for all floor above floor two level SECOND FLOOR	110.22	4326.23	Cum	476837.07
47	Half brick masonry in common brunt clay building strength not less than 35 Kg./Sqcm. In cement mortar 1:3 (1cement : 3 coarse sand) with 2 Nos. of 6 mm. Diameter mild steel round bars after every three coarse embedded in cement mortar in foundation and plinth FOR GROUND FLOOR	339.33	707.96	sq.mt	240232.07
48	Half brick masonry in common brunt clay building strength not less than 35 Kg./Sqcm. In cement mortar 1:3 (1cement : 3 coarse sand) with 2 Nos. of 6 mm. Diameter mild steel round bars after every three coarse embedded in cement mortar in foundation and plinth FOR FIRST FLOOR	923.85	713.90	sq.mt	659536.52
49	Providing 20 mm thick double coat mala cement plaster on interior brick/white stone bela/ concrete work for plastering comprising of base coat of 12 mm thick cement plaster in cement mortar (1 cement : 4 coarse sand) in rough finishing and 8 mm thick top coat of cement mortar 1 :2 (1 Cement : 2 Coarse sand) finished with trowel including scaffolding curing etc. comp.For GROUND FLOOR walls	5074.67	267.75	sq.mt	1358742.89
50	Providing 20 mm thick double coat mala cement plaster on interior brick/ white stone bela/ concrete work for plastering comprising of base coat of 12 mm thick cement plaster in cement mortar (1 cement : 4 coarse sand) in rough finishing and 8 mm thick top coat of cement mortar 1 :2 (1 Cement : 2 Coarse sand) finished with trowel including scaffolding curing etc. comp.For GROUND FLOOR all floor above floor two level ceilings & soffits of stairs	1581.40	312.96	sq.mt	494914.94

51	Providing 20 mm thick double coat mala cement plaster on interior brick/white stone bela/ concrete work for plastering comprising of base coat of 12 mm thick cement plaster in cement mortar (1 cement : 4 coarse sand) in rough finishing and 8 mm thick top coat of cement mortar 1 :2 (1 Cement : 2 Coarse sand) finished with trowel including scaffolding curing etc. comp. For FIRST FLOOR all floor above floor two level walls	5017.71			
			293.43	sq.mt	1472346.65
52	Providing 20 mm thick double coat mala cement plaster on interior brick/ white stone bela/ concrete work for plastering comprising of base coat of 12 mm thick cement plaster in cement mortar (1 cement : 4 coarse sand) in rough finishing and 8 mm thick top coat of cement mortar 1 :2 (1 Cement : 2 Coarse sand) finished with trowel including scaffolding curing etc. comp.For FIRST FLOOR all floor above floor two level ceilings & soffits of stairs	1339.06			
			333.60	sq.mt	446710.42
53	Providing 20 mm thick double coat mala cement plaster on interior brick/white stone bela/ concrete work for plastering comprising of base coat of 12 mm thick cement plaster in cement mortar (1 cement : 4 coarse sand) in rough finishing and 8 mm thick top coat of cement mortar 1 :2 (1 Cement : 2 Coarse sand) finished with trowel including scaffolding curing etc. comp. For SECOND FLOOR all floor above floor two level walls	112.39			
			318.00	sq.mt	35740.02
54	Providing 20 mm thick double coat mala cement plaster on interior brick/ white stone bela/ concrete work for plastering comprising of base coat of 12 mm thick cement plaster in cement mortar (1 cement : 4 coarse sand) in rough finishing and 8 mm thick top coat of cement mortar 1 :2 (1 Cement : 2 Coarse sand) finished with trowel including scaffolding curing etc. comp.For SECOND FLOOR all floor above floor two level ceilings & soffits of stairs	44.16			
			354.24	sq.mt	15643.24
55	20 mm thick Pana Polish cement plaster for OUT SIDE on walls up to height 10 metres above ground level consisting of 12 mm thick backing coat of C.M. 1:3 (1-Cement : 3-sand) and 8mm thick finishing coat of C.M.1:1(1-cement:1-send) etc. complete. UP TO FLOOR TWO LEVEL(GROUND FLOOR) +F.F	5239.89			
			341.00	sq.mt	1786802.49

56	20 mm thick Pana Polish cement plaster for OUT SIDE on walls up to height 10 metres above ground level consisting of 12 mm thick backing coat of C.M. 1:3 (1-Cement : 3-sand) and 8mm thick finishing coat of C.M.1:1(1-cement:1-send) etc. complete. FOR ALL FLOOR ABOVE FLOOR TWO LEVEL SECOND FLOOR	874.47			
			366.68	sq.mt	320650.66
57	Providing cement vata (10cm. x 10 cm. size) quarter round in cement mortar 1:1 including neat cement finishing, watering etc. complete.FOR ALL FLOOR	511.84			
			23.45	Rmt	12002.65
58	Providing and fixing good quality as per manufacturer specification flush door shutters(35 mm thick), solid core construction with frame of first class hardwood with cross board and face veneer or plywood face panels or Laminates on both sides , including Steam beach member on periphery for fixing 4" long hinges 3 Nos. Fixing 1.0mm thick laminate on both sides including S.S Handles, S.S.ALDROP, S.S.stoppers, S.S.TOWER BOLS,doorstop with necessary screws & polishing with french/laquer to exposed edges as directed etc.complete.S.S. butt hinges with necessary screws. Non-decorative type and block board core s.s butt hinges in flush door shutters 35 mm thick.for all floors	413.69			
			1779.97	sq.mt	736355.79
59	Providing, Laying and fixing Polished Granite stone 18mm to 20 mm thick for Door Frame including with required Moulding on both edges as directed and design by Architect with cement mortar and cement slurry rubbing, polishing etc. complete.green stone 19mm to 20mm thick granite stone Basic Rate 915/-per sq.mt FOR ALL FLOOR	243.59			
			2761.00	sq.mt	672551.99
60	Providing, fixing and laying Polished Granite stone sill, lintel and jambs for alluminium section window with half round nosing green stone 18mm to 20mm thick granite stone Basic Rate 915/-per sq.mt FOR ALL FLOOR	213.05			
			2761.00	sq.mt	588231.05

61	Providing and laying 120 cm x 60 cm Antiskid Vitrified 8 to 10 mm thick tiles flooring over over 20 mm (average) base if cement mortar 1:6(1cement : 6 coarse sand) on new surface or fixing on existing flooring by adhesive material including dismantalling of existing flooring and jointed with colour cement slurry including finishing joint with flush pointing with epoxy grout 3mm thick joint and cleaning the surface etc complete size, shade, finish and pattern as approved by Architect and EIC. (Premium First Quality) FOR ALL FLOOR	2985.13	1635.00	sq.mt	4880687.55
62	Providing and laying 120/60 cm x 60 cm Antiskid vitrified tiles 8 to 10 mm thick in skirting risers of steps and dedo on 10mm thick cement plaster 1:3 (1-cement : 3-coarse sand) and jointed with epoxy grout/white cement slurry size, shade, finish and pattern as approved (matched to flooring)by Architect and EIC. (Premium First Quality) FOR ALL FLOOR	200.09	1523.61	sq.mt	304859.12
63	Providing and laying 20 mm thick Machine Polished Granite stone slab flooring for stair case over 20 mm. risers of steps. Dado and pillars laid on 10/20 mm. Thick cement mortar 1:3 (1 cement : 3 coarse sand) laid over and jointed with grey/white cement slurry with matching color of stone including half round nosing, rubbing and making two groove on front edge for steps (TREAD) and polishing complete. basic rate for granite stone Rs.1721/-(Sq.mt) FOR ALL FLOORS	97.37	2825.00	sq.mt	275070.25
64	Providing and laying Ceramic tiles 6 mm. Thick in skirting risers of steps and dado on 10 mm. Thick cement plaster 1:3 (1 cement : 3 coarse sand) pointing in white cleaned jointed with white cement slurry. size,shade and pattern as approved (matched to flooring) by Architect and EIC. for all floor WALL	1616.67	965.48	sq.mt	1560862.55

65	Providing and fixing counter top wash basin(oval shape)sandwich type top with granite stone (shade approved by Architects) with making hole and with all necessary required fittings and fixtures for washbasin likes waste cuplin,bottle trep, flexible pipe fittings ets comp 60 cm wide top including with oval shape wash basin counter top size as per drawing & oval shape wash basin size 56 cm x 43 cm (vienne oval self rimming basin S.white 51x43 cm(10038)/ZEN star white under counter (10049) as directed by Architect Hindware/CERA) for All floor above floor two level as directed by Architect and EIC	32.55	5983.00	sq.mt	194746.65
66	Providing, supplying and fixing counter top sandwich type finish top with granite stone and base with kotastone with making hole as per requirement, kota stone vertical support (both granite and kota stone all exposed surface must mirror polish and all edges moulded) and counter top size as per drawing and design given by Architect/EIC etc comp.gor kitchen	41.27	4715.00	sq.mt	194588.05
67	Providing and fixing counter top basin for drinking water and hand wash basin sandwich type(both side) top and bottom with mirror polished granite stone with making hole and with all necessary required fittings and fixtures for basin likes waste cuplin, flexible pipe fittings ets comp 0.47 cm wide top including with rubbing, polishing all vertical and horizontal front edge with noising for basin counter size for drinking water and hand wash basin as per drawing and using thick cement slurry, adhasive and white cement for jointing etc comp as per design and directed by Architects	3.84	8030.00	Rmt	30835.20
68	Providing and laying water proofing treatment with broken china mosaic flooring for terrace using 12 mm to 20 mm broken pieces of glazed tiles to be laid over cement mortar 1:3 to plain or slope and to be tempered to bring mortar crème out upto surface using white cement including rounding off junctions and extending then upto 15 cm along the wall, clearing with water and oxalic acid etc, as directed, shade and pattern as directed by Architect and EIC.	1658.03	739.89	SqM	1226759.82
69	Providing and laying cushioning layer on R.C.C Slab, concrete using brick aggregate of 20mm nominal size mortar compresing of (1-Lime 2-Fine sand)	1658.03	234.68	SqM	389106.48

70	Providing, supplying, laying and planting different kinds of plants/shrubs/ground cover (10nos per sq.mt) HADGES and Trees/Palm tree (minimum height 10' TO 12' feet)as directed by Architect in suggested area with necessary excavation minimum (size of excavation 1.20mt X 1.20mt X 1.20mt) as directed by Architect, garden soil required for plants, curing, required FYM farm yard manure, for flower bed etc. complete at all level, heights as per design by ARCHITECT and directed by EIC (work start after getting prior approval for sample of all plants and trees)	159.51			
			900.00	sq.mt	143559.00
71	Providing, Supplying and laying Land Scaping work, green lawn include with necessary required excavation (minimum depth of excavation 0.30mt), FYM (good quality farm yard manure) and garden soil etc complete as per design and directed by ARCHITECT(work start after getting prior approval for sample)	244.64			
			796.00	sq.mt	194733.44
72	Providing Supplying and laying fine sand(PANO)(approved quality of surendranagar bhogavo river) for sand pit(children play area) as design by architect and directed by EIC	95.66			
			750.00	CUM	71745.00
73	Providing and fixing standard extruded of aluminium section of size 63mm x 38.10mm x 1.2mm (@ Wt. 0.643 Kg/mt) with colour anodized aluminium frame for ventilation with 5 mm thick frosted glass as details etc complete for Ventilation	11.10			
			1163.92	sq.mt	12919.51
74	Providing and fixing extruded aluminum window(sliding window) having extruded aluminum Colour Powder Coated section frame main outer size 127mm x 38.10mm x 1.35mm (of Jindal Section no:2443, @ Wt.1.384 Kg/mt), horizontal Four track member size 122.20mm x 31.75mm x 1.10mm (@ Wt. 1.205 Kg/mt), vertical member of size 122.20mm x 31.75mm x 1.50mm (@ Wt. 1.398 Kg/mt) with sliding shutters of horizontal member size 40mm x 18mm x 1.29mm (@ wt.of 0.456Kg/mt), vertical member of size 40mm x 18mm x 1.29mm (@ wt.of 0.456Kg/mt, (@ Wt. 0.457 Kg/mt) with 5 mm thick transparent bronze colour tinted float glass with powder coated aluminum fittings and fixtures and transparent silicon sealant glass fixing to frame as per details etc complete for window.	371.28			
			2119.14	sq.mt	786794.30

75	Providing and Fixing safety grill for windows, doors/Railing for staircase and Remp, M.S.GATE of required pattern for windows/ventilations/Door/staircase, Remp, Compound wall AND GATE using M.S. polished bars size 12mm, m.s flat and rectangular/round CRC pipes of required size at required spacing as per design directed by architect and hold fast with coach bolts etc. complete.	20079.78			
			112.00	Kg	2248935.36
76	Providing and fixing rolling shutters of approved make made of 80 mm wide M.S. laths inter-locked together through their entire length and jointed together at the ends by end locks mounted on specially designed pipe shaft with bracket plates, guide channels and arrangements for inside and outside locking with pushpull operation including the cost of hood cover and spring etc. complete.(A) Shutters having width below 3.5 M.	69.91			
			3468.72	sq.mt	242498.22
77	Applying priming coat over new steel and other metal surfaces after and including preparing the surface by thoroughly cleaning, oil grease, dirt and other foreign matter and scoured with brushes fine steel wool, scrapers, and sand paper with ready mixed priming paint brushing red lead.	1133.30			
			34.65	sq.mt	39268.85
78	Painting two coats (excluding priming coat) on new steel and other metal surfaces with enamel paint, brushing interior to give an even shade including cleaning the surface of all dirt, dust and other foreign matter.	1133.30			
			86.94	sq.mt	98529.10
79	Applying two coats of Birla (white cement based) or Asian (acrylic lapy-putty) or equivalent & two coats of primer of approved brand and manufacture on new wall/ceiling surface to give an even shade including thoroughly brushing the surface free from mortar dropping and other foreign matter and sand papered smooth.	16133.29			
			40.19	sq.mt	648396.93
80	Wall painting (three coats) with plastic emulsion paint of approved brand and manufacture on undecorated wall surface to give an even shade including throughly brushing the surface free from mortar droppings and other foreign matter and sand papered smooth. on walls shade and pattern as directed by Architect and EIC.	13168.67			
			118.24	sq.mt	1557063.54

81	Wall painting (three coats) with plastic emulsion paint of approved brand and manufacture on undecorated ceiling and soffit surface to give an even shade including thoroughly brushing the surface free from mortar droppings and other foreign matter and sand papered smooth. on ceiling and soffit shade and pattern as directed by Architect and EIC.	2964.62			
			123.45	sq.mt	365982.34
82	Finishing wall with 100% ACRYLIC EXTERIOR paint (PU/SILICON BASED) of approved make,brand and shade on wall surfaces (two coats), with 100% alcaly resistance primer(PU/SILICON BASED) one coats , recessed /embossed panels, pillars etc., give an even shade after thoroughly brushing the surface to remove all the dirt and remains of loose powdered material. The material shall be as described in list of approved material.shade and pattern as directed by Architect and EIC.	6114.36			
			281.00	sq.mt	1718135.16
83	Providing, Supplying and Filling with good quality Broken AEC block for Sunk etc comp..	102685.80			
			8.00	KG	821486.40
84	Applying general insecticide pest control treatment to floors, cupboards, etc. including labours materials etc. complete.	1814.05			
			36.86	sq.mt	66865.88
85	Providing,supplying, making,eracting and Fixing M.S.Steel Roof structure with M.S trusses and G.I.Coated Sheet of required pattern as required using M.S. polished bars, M.S.Flats,M.S.angles,M.S. Channels and rectangular CRC pipes(Heavy) of required size at required spacing for purlins,Hip and jack rafters,connecting plates,tees,eams connected to commen rafters and the like as per design and hold fast with coach bolts including cutting, hoisting, fixing in position with one coat of primer and two coats of matt finished oil painting & required foundation J bolt, base plate of required size as directed with cement concrete (M200/250) etc. complete.FOR OTS AND GAZEBO	9521.34			
			145.00	Kg	1380594.30
86	Providing and fixing concealed center point to wall ceiling & floor CPVC (SDR 13.5) PIPE having National Sanitation Foundation (NSF) seal for potable water of following dia. Normal bore tube fitting and clamps including making good the wall, ceiling and floor etc. complete. (E) 40 mm.	547.00			
			437.66	Rmt	239400.02

87	Providing and fixing concealed center point to wall ceiling & floor CPVC (SDR 13.5) PIPE having National Sanitation Foundation (NSF) seal for potable water of following dia. Normal bore tube fitting and clamps including making good the wall, ceiling and floor etc. complete. (A) 25 mm.	834.00			
			247.25	Rmt.	206206.50
88	Providing and fixing concealed center point to wall ceiling & floor CPVC (SDR 13.5) PIPE having National Sanitation Foundation (NSF) seal for potable water of following dia. Normal bore tube fitting and clamps including making good the wall, ceiling and floor etc. complete. (A) 15 mm.	705.00			
			165.21	Rmt.	116473.05
89	Providing laying and jointing in true line and level 40mm dia. U.P.V.C. Pipe (SCH- 40) for cold water including fittings make PRINCE / SUPREME / ASTRAL / FINOLEX or equivalent as approved by Engineer In Charge. Pipe shall be fixed on the wall with the help of clamp at every two metre C/C or shall be cancelled as directed including necessary fittings etc. including testing of pipe and joints and fixing the same with adhesive solvent, including cost of all materials.	498.00			
			146.65	Rmt	73031.70
90	Providing laying and jointing in true line and level 25mm dia. U.P.V.C. Pipe (SCH- 40) for cold water including fittings make PRINCE / SUPREME / ASTRAL / FINOLEX or equivalent as approved by Engineer In Charge. Pipe shall be fixed on the wall with the help of clamp at every two metre C/C or shall be cancelled as directed including necessary fittings etc. including testing of pipe and joints and fixing the same with adhesive solvent, including cost of all materials.	608.00			
			90.93	Rmt.	55285.44
91	Providing laying and jointing in true line and level 15mm dia. U.P.V.C. Pipe (SCH- 40) for cold water including fittings make PRINCE / SUPREME / ASTRAL / FINOLEX or equivalent as approved by Engineer In Charge. Pipe shall be fixed on the wall with the help of clamp at every two metre C/C or shall be cancelled as directed including necessary fittings etc. including testing of pipe and joints and fixing the same with adhesive solvent, including cost of all materials.	575.00			
			71.93	Rmt.	41359.75

92	Providing and fixing screw down bib taps of following size :(B) Brass chromium plated screw down bib tap (l) 15 mm dia.	132.00	184.98	No	24417.36
93	Providing and fixing chromium plated brass screw down stopcock of approved quality including fixing in pipe line etc. complete .(A) 15 mm. Dia	75.00	212.68	No	15951.00
94	Providing and fixing chromium plated brass Health Faucet of approved quality including fixing in pipe line etc. complete Hindware, EssEss, ap royale or equivalent.	30.00	599.00	No	17970.00
95	Providing and fixing chromium plated brass screw down stopcock of approved quality including fixing in pipe line etc. complete .(C) 25 mm. Dia	30.00	218.63	No	6558.90
96	Providing and fixing gun metal check or non return full way wheel valve (A) 15mm. Dia	15.00	184.98	No	2774.70
97	Providing and fixing gun metal check or non return full way wheel valve (C) 25 mm. Dia	15.00	416.47	No	6247.05
98	Providing and fixing gun metal check or non return full way wheel valve (E) 40 mm. Dia	10.00	656.86	No	6568.60
99	Providing and fixing C.P.brass shower rose with 15mm or 20mm inlet.(A) 100mm dia.Each	37.00	279.37	No	10336.69
100	Providing and fixing 600mmX450mm Beveled edge glass mirror of superior glass mounted on 6mm the A.C. sheet or plywood sheet & fixed to wooden plugs with C.P.brass screws and washers.	45.00	825.48	No	37146.60
101	Providing and fixing C.P.brass towel rail complete with c.p. brass brackets fixed to wooden plugs with c.p. brass screw. (B)600mmx20mm size	46.00	597.22	No	27472.12
102	Providing and fixing chromium plated bottle trap with necessary couplings of approved quality for wash basin	45.00	292.87	No	13179.15
103	Providing and fixing pillar tap , capstan head , screw down high pressure with serews, shanks and bank nuts.(i) 15mm	45.00	305.67	No	13755.15
104	Providing and fixing pillar tap/swan neck pillar cock left hand operating capstan head , screw down high pressure with serews, shanks and bank nuts etc comp Hindware, EssEss, ap royale or equivalent (i) 15mm	45.00	1550.00	No	69750.00
105	Providing and fixing chromium plated brass waste coupling F/T of approved quality including fixing in pipe line etc. complete Hindware, EssEss, ap royale or equivalent.	45.00	363.00	No	16335.00

106	Providing and fixing chromium plated brass Angle cock common with flange of approved quality including fixing in pipe line etc. complete Hindware, EssEss, ap royale or equivalent. 15mm Dia	74.00	799.00	No	59126.00
107	Providing and fixing urinal approved quality connecting the urinal with waste pipe, trap etc. complete.(A) White earthen ware flat back or corner type size 430mm x 260mm x 350 mm	29.00	1026.01	No	29754.29
108	Providing and fixing chromium plated brass half turn flush cock of approved quality including fixing in pipe line etc. complete.(ii) 25mm Dia	51.00	261.16	No	13319.16
109	Providing and fixing wash down water closet (European type, W.C. Pan with integral 'P' or 'S' trap including jointing the trap with soil pipe in cement mortar 1:1 (1 cement : 1 fine sand) (seat and cover to be measured and paid for separately)(A) Vitreous china pattern : I (I) In white colour including with 100mm size P or S trap for water closet squatting pan including jointing the trap with the pan and soil pipe in cement Mortar 1:1 (1-Cement :1-Fine sand)(A) Vitreous China.	30.00	1604.23	No	48126.90
110	Providing and fixing water closet squatting pan (Indian type W.C. Pan) size 580 mm. (Earth work, Bed concrete foot rests and trap to be measured and paid for separately.)(A) Vitreous china(I) Long pattern white colour including with 100mm size P or S trap for water closet squatting pan including jointing the trap with the pan and soil pipe in cement Mortar 1:1 (1-Cement :1-Fine sand)(A) Vitreous China.	21.00	1241.11	No	26063.31
111	Providing and fixing wash basin with single hole for pillar tap with C.I. Or M.S. brackets painted white including cutting holes and making good the same but excluding fittings :(A) Vitreous china(ii) Flat back wash basin 500mm x 400mm size(I) in white colour	15.00	1400.18	No	21002.70
112	Providing and fixing plastic seat and cover for wash down water closet with C.P. Brass hinges and rubber buffers.(B). Black plastic seat and cover	30.00	288.45	No	8653.50
113	Providing and fixing PVC SWR (spun) nahni trap of the following nominal diameter of self cleaning design with C I screwed down of hinged grating including cost of cutting and making good the walls and floors 100 mm inlet and 50 mm out let etc complete	175.00	371.00	No	64925.00

114	Providing and fixing S.W. Gully trap with C I grating brick masonry chamber and water tight C I cover with frame of 300 x 300 mm size (inside) with standard weight (i)squre mouth traps (B) 150 mm x 100 mm size P or R type	35.00	1234.57	No	43209.95
115	Providing, laying and jointing in true line and level 160 diametre U.P.V.C.SWR (Type B) conforming to IS 13592-1992 with one end plain and other end socketed with rubber ring, & fittings conforming to ISI 14735-1999 of approved make for drainage system pipe line, pipe shall be jointed with each other with rubber lubricant, pipe shall be fixed on wall using of PVC clamp of the size 160 mm diametre x 210 mm length x 196 mm heigh at every 2000 mm center to center or shall be concealed in walls as directed including necessary fittings such as bends, shoes etc. including testing of pipes and joints and jointed with adhesive solvent cement including cost of all materials.	428.00	822.99	Rmt	352239.72
116	Providing laying and joining in true line and level 110 mm diameter U.P.V.C. SWR Type B pipe confirming to IS 13592-1992 with one and plain and other end socketed with rubber ring and fitting confirming to IS 14735-1999 of approved make for drainage system pipe line, pipe shall be jointed with each other with rubber lubricant, pipe shall be fixed on wall using of PVC clamps of the size 110mm diameter x 149 mm length x 145 mm high at every 2000 mm center to center or shall be eoncealed in walls as directed including necessary fittings such as bends, shoes etc, including testing of pipes and joints and jointed with adhesive solvent cement including cost of all materials	925.50	826.88	Rmt	765277.44

117	Providing laying and joining in true line and level 75 mm diameter U.P.V.C. SWR Type B pipe confirming to IS 13592-1992 with one end plain and other end socketed with rubber ring and fitting confirming to IS 14735-1999 of approved make for drainage system pipe line, pipe shall be jointed with each other with rubber lubricant, pipe shall be fixed on wall using of PVC clamps of the size 75mm diameter x 149 mm length x 145 mm high at every 2000 mm center to center or shall be concealed in walls as directed including necessary fittings such as bends, shoes etc, including testing of pipes and joints and jointed with adhesive solvent cement including cost of all materials	425.00			
			418.00	Rmt	177650.00
118	Providing and fixing to wall, ceiling and floor 6.0 Kg f/cm2 working pressure polythelene pipes of the following outside dia. Low density, complete with special flange compression type fittings wall clamps etc. including making good the wall, ceiling and floor. Rain Water pipe 110 MM	372.00			
			820.00	Rmt	305040.00
119	Providing and Fixing in position PVC SWR cowl vent to pipes 75 mm	15.00			
			9.32	No	139.80
120	Providing and Fixing in position PVC SWR cowl vent to pipes 110 mm	40.00			
			19.49	No	779.60
121	Providing erecting and fixing double coated (ISI) water tank of required capacity each with all necessary fittings & connection etc.complete on terrace.	50000.00			
			3.91	liter	195500.00
122	Constructing brick masonry chamber for under ground C.I. Inspection chamber and bends with bricks having crushing strength not less than 35 Kg/cm2 in cm. 1:5 C.I. Cover with frame (light duty) 455 mm. X 610 mm. Internal dimensions, total weight of cover with frame to be not less than 38 Kgs. weight of cover 23 Kg. and wt. of frame 15 Kg) R.C.C. top slab with 1:2:4 mix(1 cement : 2 coarse sand : 4 graded stone aggregate 20 mm. size) foundation concrete 1:5:10 inside plaster 15 mm. thick with cement mortar 1:3 finished smooth with a floating coat of neat cement on walls & abed concrete etc. complete.(ii) Inside dimensions, 500 mm. X 700 mm. And 450 mm. Deep for pipe line with one or two inlets.	30.00			
			3624.51	No	108735.30

123	Providing soak-pit of 5.0 Cu.m volume including excavation and filling brick-bats with dry masonry work at top for 45cm height including providing vatas in c:m. 1:3 with finishing, curing etc, complete as directed.	1	3,338.80	No	3338.80
124	Providing septic tank of given size including excavation, Bed Concrete, masonry work in 23cm thick wall, inside plaster finished with floting coat of cement C.I.steps, completes as per design and directed by Architects, and covering the top with stone/Rajula Stone including providing vatas in C.M 1:3 with curing.	1	73,300.00	Ea.	73300.00
125	Referigerant piping- insulated copper tube & electrical cabling between indoor to out door unit beyond 5 R mt dist. of 1 / 1.5 / 2.0 TR Hi-wall split unit.	195	800.00	RMT	156000.00
126	25/32mm Dia PVC drain pipe of Dutron / Supreme make for water outlet from indoor unit.	180	80.00	RMT	14400.00
127	Providing & erecting water cooler having storage capacity 150 Ltr. & cooling capacity 150 Ltr.per hour @ an ambient temp of 450 C. The outlet temp. of the water should drop by 150C within a hour, The water cooler should be comprising of hermetically sNosled compressor, fan motor, condensing unit, water tank surrounded by evaporating, coil, thermostats, relay etc.complete with necessary inlet & outlet connection. The body of water cooler will be made from Stainless Steel.	2	54,500.00	Nos.	109000.00
128	Supplying and erecting water filter cum purifier with ultra violate technology. (Aquaguard / waterdoc model or equivalent symphony/ crystal/videocon model)	2	5,290.00	Nos.	10580.00
129	Providing and laying polished Kota stone slab flooring over 20mm (Average) thick base of cement mortar 1:6 (1-cement : 6-coarse sand) or L.M. 1.1.5 (1-Lime putty :1.5 - coarse sand) laid over and jointed with grey cement slurry mixed with pigment to match the shade of slab including rubbing and polishing etc. complete. (A) 25mm thick	494.64	962.33	Sq.Mt	476006.91

130	Providing and laying polished kota stone slab 25mm thick in risers of steps,skirting Dedo and pillars laid on 10mm thick cement mortar 1:3 (1-Cement : 3 coarse sand) and jointed with gray cement slurry mixed with pigment to match the shade of slab including rubbing and polishing etc. complete.	31.68	1045.80	Sq.Mt	33130.94
131	Providing Supplying and Fixing 4 in 1 Swing (Rubber Belt Seat)Code-RSW-04 etc. Complete as design by Architect and directed by EIC	1.00	43904.00	Nos.	43904.00
132	Providing Supplying and Fixing Plain Slide (GI Sheet) 2.10 M HT.Code-RSL-02 etc. Complete as design by Architect and directed by EIC	1.00	34375.00	Nos.	34375.00
133	Providing Supplying and Fixing Spiral Slide (FRP) 1.50 M HT.Code-RSL-05 etc. Complete as design by Architect and directed by EIC	1.00	66925.00	Nos.	66925.00
134	Providing Supplying and Fixing Single Sesaw.Code-RSS-01 etc. Complete as design by Architect and directed by EIC	1.00	11867.00	Nos.	11867.00
135	Providing Supplying and Fixing S' Bridge Ladder.Code-RCL-02 etc. Complete as design by Architect and directed by EIC	1.00	32569.00	Nos.	32569.00
136	Providing Supplying and Fixing Revolving Platform 1.50 M Dia.Code-RMG-01 etc. Complete as design by Architect and directed by EIC	1.00	40828.00	Nos.	40828.00
137	Providing Supplying and Fixing/Laying Metal Single bed with storage (powder coated colour directed by Architect) etc. Complete as design by Architect and directed by EIC Warranty: the product is having warranty for period of 12 months from the date of material received by Bhavnagar Municipal Corporation.	497.00	8500.00	Nos.	4224500.00
138	Providing Supplying and Fixing/Laying Single bed Mattress(size 72" x 35")with Bedsheet (size 72" x 48" x 6"), Pillow (size 18" x 27") with cover and Blanket single bed Khadi cotton khes comforter set of ONE etc. Complete as design by Architect and directed by EIC warranty for period of 12 months from the date of material received by Bhavnagar Municipal Corporation.	497.00	1565.00	Nos.	777805.00

139	Providing Supplying and Fixing/Laying Dining table with Chair(4+1)pear wood dining set shahensha with CHR 400 by Nilkamal, Cello or equivalent etc. Complete as design by Architect and directed by EIC Warranty: the product is having warranty for period of 12 months from the date of material received by Bhavnagar Municipal Corporation.	20.00			
			3250.00	Nos.	65000.00
140	Providing Supplying and Fixing/Laying Three Seater Wooden Sofa etc. Complete as design by Architect and directed by EIC Warranty: the product is having warranty for period of 12 months from the date of material received by Bhavnagar Municipal Corporation.	24.00			
			6500.00	Nos.	156000.00
141	Providing Supplying and Fixing/Laying one Office table(size not less then 1.80 x 0.90 mt) with one Revolving chair (High back) and Four Lowback office chair and Three metal powder coated cupboard for office and store etc. Complete as design by Architect and directed by EIC Warranty: the product is having warranty for period of 12 months from the date of material received by Bhavnagar Municipal Corporation.	2.00			
			75250.00	job	150500.00
142	Providing Supplying, Fixing and commissioning POLYESTER BASED FABRIC SOLID WINDOW CURTAIN DARK IN COLOUR AND MACHINE WASHABLE FOR WINDOW WITH S.S CURTAIN ROD, S.S.CURTAIN BRACKETS AND DECORATIVE SOKETS SILVER FINISH FINIALS AND SUPPORTS SET all required fixers and fittings etc. Complete size and colour as design by Architect and directed by EIC(minimumm size not less then 1.50 x 1.50 mt) Warranty: the product is having warranty for period of 12 months from the date of material received by Bhavnagar Municipal Corporation.	107.00			
			1126.10	Nos.	120492.70

143	Providing Supplying, Fixing and commissioning S.S.kitchen equipment likes three and one burner commercial gas stove, haevy chimany for restourant, food storage container with contain food hot, WATER STORAGE, for food making and serving utensils and all required necessary equipments etc. Complete as design by Architect and directed by EIC(ALL EQUIPMENTS GOOD HIGHER GRADE QUALITY STAINLESS STEEL)Warranty: the product is having warranty for period of 12 months from the date of material received by Bhavnagar Municipal Corporation.	1.00			
			399890.00	job	399890.00
144	Providing Supplying and Fixing Parallel Bar for open GYM etc. Complete as design by Architect and directed by EIC	1.00			
			17380.00	Nos.	17380.00
145	Providing Supplying and Fixing Horizontal Bar (IRON) TOPSUN BRAND for open GYM etc. Complete as design by Architect and directed by EIC	1.00			
			21450.00	Nos.	21450.00
146	Providing Supplying and Fixing Cycle(spin fitness bike) WITH 6 KG FLYWHEEL/ADJUSTABLE, LLESB99 for open GYM etc. Complete as design by Architect and directed by EIC	1.00			
			12648.00	Nos.	12648.00
147	Providing Supplying and Fixing Loop Rung climber for open GYM etc. Complete as design by Architect and directed by EIC	1.00			
			39193.00	Nos.	39193.00
148	Providing Supplying and Fixing Rainbow climber for open GYM etc. Complete as design by Architect and directed by EIC	1.00			
			17600.00	Nos.	17600.00
149	Providing Supplying and Fixing Sit up board for open GYM etc. Complete as design by Architect and directed by EIC	1.00			
			18975.00	Nos.	18975.00
150	Providing, Supplying and Fixing for Handicap(Physically Disable People) Toilet Assessories including with S.S. Grab Bars straight size 600 mm long(30 inch)S.S.304, S.S.Brush Finish made from 32mm Dia pipe Three piece, S.S.U shape Moveble Grab Bars size 600 mm long(30 inch) S.S.304, S.S. Brush Finish made from 32mm dia pipe Two piece and Mirror One piece 600mm x 450mm size with all S.S.screws and pvc plugs in line and levels etc.comp at require hight and width mention as per requirement of Handicap Toilet guidelines as per NBC and given layout as suggested and directed by Authority/Architect	6.00			
			16445.00	Nos.	98670.00

151	Providing, Supplying and fixing cast iron cover with frame of size 455mm x 610mm internal dimension and painting with two coats of Anti-corrosive paint etc. complete.(weight of cover with frame not less than 38.00kg cover weight 23.00 kg and wt of frame 15.00 kg with required cement mortar and cement slurry etc comp.	6.00			
			1756.00	Nos.	10536.00
152	Providing and fixing cast iron steps of size 500mm x 150mm x 22.5mm and painting with two coats of Anti-corrosive paint etc. complete. Sor no 24010/24.33/pg no 133 rate 180.60	24.00			
			142.86	Nos.	3428.64
153	Providing and fixing pre-cast concrete kerb stone of gray cement based concrete block 30cm length,30cm height and 15cm thick of M250 grade concret as per approved design and including excavation for fixing in proper line and level,filling the joint with C:M 1:3 (1cement:3fine sand) etc complete.	322.17			
			358.06	Rmt	115356.19
154	Double Deck Steel Bed Providing & fixing Double Deck Steel Bed With mattress, bed sheet, pillow ,blanket (For 2 Persons)Overall Size: 1981L x 838W x 1830H mm(78"L x 33"W x 72"H inch)Bottom Storage: 1830L x 650D x 400H mm(with inbuilt Locker)Mattress Size: 1905x762mm (75"x30" inch)As per attached drawing/Image Material Description:1. Bed Frame structure made up of 38x38x2 mm thick. (14swg) CRCA square tube.2. Staircase tube of Ø 25x 2 mm thick. (14swg) CRCA round tube.3.Head & Tail Side & Top Side frame tube of Ø 25x 2mm thick. (14 swg) &Center Support tube of Ø 19x1.5 mm thick. (16 swg) CRCA round tube.4. Mid panel of 12mm thick. Waterproof ply with teakwood beading(SIZE :75 " x 30 ")5. Horizontal Mid Panel support of 20x20x2 mm thick. (14 swg) CRCA square tube.6. Bottom Storage (Drawer with telescopic channel and with inbuilt locker lock) unit of 0.7mm & 0.8mm (22swg& 21swg) thick. CRCASheet with 38x38x2mm thick (14swg) CRCA square tube with six side closed.7.Bottom storage unit with good quality telescopic channel for smooth slide.8. Good quality PVC shoes at leg bottom.(With flooring level adjustable) 261• All Steel parts of powder coated with high quality powder after 10 tanks anti-rust treatment process. Mattress: U-foam mattress with cover (2 Nos/ bunk bed) Rs.2750/- base price per no	173.00			
			22550.00	Nos.	3901150.00

	<p>*Size: 75 inch x 30 inch x 4 inch *40 density *4 inch (95mm U foam + quilted cover) *As per IS 7933 : 1975 with ISI mark *Quilted fabric, 200 to 250 GSM, polyester, pattern-square checks, color-as per department instruction *Cover (cotton cover for U foam mattress) 100% cotton, color –as per department instruction Pillow with cover : (2 Nos/ bunk bed) Rs.120/- base price per no *Size: 16 inch x 26 inch made from 1.2 Kg. cotton with printed color cover for pillow (100% cotton) Blanket: (2 Nos/ bunk bed) Rs.145/- base price per no. good quality blanket of size 7 feet x 4 feet, minimum weight 1.2 Kg Bedsheet with pillow cover : (2 Nos/ bunk bed) Rs.380/- base price per no *Size: 86 inch x 56 inch or 218 cm x 142 cm pillow cover size: 17 inch x 27 inch or 42 cm x 68 cm *100% cotton cloth material as per required color, Print and design *All side 1 inch width border</p> <p>*Appropriate thread & stitches should be used *Brands: Raymond, Oswal, Mafatlal, Bombay Dyeing. Material should be of standard company in original packing, Name of company/brand/model name/number etc. should be mentioned above packing. Warranty: the product is having warranty for period of 12 months from the date of material received by Bhavnagar Municipal Corporation.</p>				
155	<p>Multipurpose Industrial locker Providing & fixing Multipurpose Industrial locker without inbuilt lock. Total lockers – 18 nos. Pad locking system in each locker. Overall size H-1980 x W-915 x D-485(mm) (H-78" x W- 36" x D-19") as per Attached Drawing/Image. Material Description: all steel parts 22 swg (0.8 mm) thick.CRCA Sheet IS;513 grade hinged Door of 19 swg (1.0 mm) thick.CRCA Sheet IS;513 grade MS label holder and MS handel in each lockers.(minimumm weight of product approx 51 KG) Good Quality Plastic Shoes At bottom. • All steel parts will be epoxy Polyester Powder Coated to the thickness of 50 microns finish after 10 tank antirust Warranty: the product is having warranty for period of 12 months from the date of material received by Bhavnagar Municipal Corporation.</p>	35.00	28159.00	Nos.	985565.00
156	<p>Providing,Supplying & fixing Square Taracotta Clay Jali size 8" x8" x3" and (Brown color or suggested) wall in proper line and level with required ready mix mortar and shade and size as directed by Architect/EIC etc. comp in all respect</p>	93.32	1454.00	Sq.Mt	135687.28
157	<p>Providing, Supplying & Fixing in line and level SS RAILING, 304 grade, brush finish, 16 gauge, with 50mm diameter closed ends handrail, fixed with vertical posts of 40 x 40mm, Horizontals pipes 19mm dia fixed with studs inclusive of any other accessories as may be required allong with fixing with proper SS screws and covering disk and making good as per Design and directed by EIC including labour and all necessary tools and plants for the work etc complete</p>	91.00	2258.00	Rmt	205478.00

158	Point wiring for Light / Bell with 2-1.5 sq.mm & earth wire of 1.5 sq.mm (Green) both are of ISI marked 1.1 KV grade FRLS PVC insulated multi strand copper wires up to 10 mtr length , in below type of pipe erected with 6A Modular type switch / bell push & accessories and earth continuity of following type, erected on PVC / Metallic/Wooden box, single mounting base frame covered with textured/metallic/white front plate modules erected on / in wall / ceiling as per pipe erected, with necessary Lamp holder/ceiling rose / H.D.Connector as directed. (a) with medium class Rigid PVC pipe and accessories erected flushed on wall/ceiling complete Cat. III	670.00			
			415.00	Pt.	278050.00
159	Point wiring for FAN with 2-1.5 sq.mm & earth wire of 1.5 sq.mm (Green) both are of .ISI marked 1.1 KV Grade FRLS PVC insulated multi strand copper wires up to 10 mtr length, in below type of pipe erected with 6A Modular type switch and hum free EME step type electronic fan regulator mounted and accessories with earth continuity of following type erected on PVC / Metallic/Wooden box, single mounting base frame covered with textured/metallic/white front plate modules erected on / in wall / ceiling as per pipe erected. with necessary ceiling rose / H.D.Connector as directed. (a) with medium class Rigid PVC pipe and accessories erected flushed on wall/ceiling complete Cat. III	200.00			
			593	Pt.	118600.00
160	Point wiring for on board Looped Plug with 6A Modular type switch & 5 pin socket erected on PVC / Metallic/Wooden box, single mounting base frame covered with textured / metallic/white front plate modules erected on / in wall / ceiling with following type accessories Cat. III	179			
			239	Pt.	42781.00
161	Point wiring for Individual Plug with & earth wire of 1.5 sq.mm (Green) both are of ISI marked 1.1 KV grade FRLS PVC insulated multi strand copper wires up to 10 mtr length, in below type of pipe erected complete with Modular type switch & 5 pin Plug erected on PVC / Metallic/Wooden box covered with appropriate front plate modules erected on / in wall / ceiling as per pipe erected with following type of accessories. [I] For 6A Plug and 6 a switch with 2-1.5 sq.mm Cu. Wire from nearby switchboard/mcb db board (a) with medium class Rigid PVC pipe and accessories erected flushed on wall/ceiling complete Cat. III	58			
			441	Pt.	25578.00

162	Point wiring for Individual Plug with & earth wire of 1.5 sq.mm (Green) both are of ISI marked 1.1 KV grade FRLS PVC insulated multi strand copper wires up to 10 mtr length, in below type of pipe erected complete with Modular type switch & 5 pin Plug erected on PVC / Metallic/Wooden box covered with appropriate front plate modules erected on / in wall / ceiling as per pipe erected with following type of accessories. [II] For 16A Plug and 16 amp switch with 2-2.5 sq.mm Cu. Wire from mcb db board. (a) with medium class Rigid PVC pipe and accessories erected flushed on wall/ceiling complete Cat. III	20	782	Pt.	15640.00
163	Providing following type of Modular Type Accessories mounted with PVC / metallic/Wooden box, single mounting base frame covered with textured / metallic/white front plate , modules erected with necessary connections as per site situation directed by Engineer In charge. (3) Two Pin/RJ-11 Telephone Socket [A] For One Gang Cat.III	6	152	Ea.	912.00
164	Providing and erecting 3 PHASE POWER PLUG WITH MCB OF 32 A IN METAL BOX DULY PAINTED	3	1450	Ea.	4350.00
165	Providing and erecting Mains with 1.1 KV grade FRLS PVC insulated ISI marked stranded Copper conductor wire in following type of pipe to be erected concealed in /flushed on wall/ceiling, with 1.5 sq. mm copper conductor FRLS PVC insulated stranded wire of green colour for earth continuity of following size (A) With medium class Rigid PVC pipe and accessories (b) 2 wire 2.5 sq. mm	3100	78	Mtr.	241800.00
166	providing and erecting Mains with 1.1 KV grade FRLS PVC insulated ISI marked stranded Copper conductor wire in following type of pipe to be erected in / on wall / ceiling with 2.5 sq. mm copper conductor FRLS PVC insulated stranded wire of green colour for earth continuity of following size (A) with medium class Rigid PVC pipe and accessories (a) 2 wire 4 sq. mm	200	106	Mtr.	21200.00
167	providing and erecting Mains with 1.1 KV grade FRLS PVC insulated ISI marked stranded Copper conductor wire in following type of pipe to be erected in / on wall / ceiling with 2.5 sq. mm copper conductor FRLS PVC insulated stranded wire of green colour for earth continuity of following size (A) with medium class Rigid PVC pipe and accessories (g) 4 wire 4 sq. mm	70	171	Mtr.	11970.00

168	Supplying & erecting approved make Telephone Cable electrolytic copper conductor PE insulation twisted in two pairs, & wrapped with FRLS PVC tape & sheathed with FRLS PVC or HFFR outer Jacket suitable for telephone wiring & confirming to C-DOT erected in existing pipe. of following size of conductors & nos.of pairs. With necessary connections.[A] Conductor Size 0.5 mm (a) Unarmoured (4) Five Pairs	110	38	Mtr.	4180.00
169	Supplying & erecting approved make LAN cable of following size in existing pipe as per direction [C] CAT - 6	1990	45	Mtr.	89550.00
170	Providing and erecting approved make split air-conditioning unit consisting of copper condensing unit with fan motor, hermetically sealed rotary compressor with accessories etc. duly connected separately erected evaporating unit and blower motor with its accessories by means of extra supplied proper insulated copper tubing,drain PVC pipes suitable for (cost includes powder coated Stand, Eco Friendly green gas charging, 15A plug top & Remote Control) with necessary core cutting For 3 Star Rating of current year (b) for 1.5 ton capacity	2	30624	Ea.	61248.00
171	Supplying and erecting, commissioning and testing of Diesel Generating set confirming to IS: 4722:1968 & BS:5514 having continuous rating, 3 phase, 415 volts, 50 cycles A.C. supply comprising of a totally enclosed air/water cooled diesel engine with multi-cylinders developing suitable BHP not less than following capacity at 1500 RPM with 10% overload for one hour in 24 hours with standard accessories like fly wheel, lubricating oil cooler, "A" class governor, heavy duty fuel wheel and lubricating oil filter, oil bath air filler, lubricating oil pressure gauge, end exhaust manifold, standard set of tools with adjustable spanners, screw drivers, cylinder head to cover, joint cylinder head to exhaust, element lube oil filter, 12 / 24 volts electric starting equipment complete with standard heavy duty battery, dynamo, cut-outs, ammeter, necessary wiring, pressure gauge, starter etc and heavy duty Residential type exhaust silencer and vertical hot air duct both logged with asbestos rope, save oil trays, exhaustcking, Name of company/brand/model name/number etc. should be mentioned above packing. Warranty: the product is having warranty for period of 12 months from the date of material received by Bhavnagar Municipal Corporation.mattress with cover (2 Nos/ bunk bed) Rs.2750/- base price per no 25 Kg.	1	535934.00	ea	535934.00

172	Solder less crimping type Aluminium lugs conforming to IS suitable for cable of following size evenly crimped with high pressure tool & connected to switchgear terminals with brass/cadmium plated nut bolts in an approved manner. (F) 95 Sq.mm.	8.00	40.00	ea	320.00
173	Supplying and erecting LED indoor fittings with LEDs of wattage 0.2 Watt to 0.5 Watt assembled on single MCPCB, with housing used as a heat sink shall be made of thick sheet Steel conforming to IS: 513/CRCA/aluminium pressure die cast powder coated and high U.V. & corrosion resistance with diffuser housed in aluminium casted body with company mark/name 160V to 270V, Power Factor more than 0.95, THD < 15 %, CCT 3000 K to 6500K, Luminaire efficacy > 85 lumens/watt , LED driver efficiency > 85 % (fitting required LM-79 & LM-80 Certificates)(NOTE: Below description have shown ranges of Wattage capacity of LED fittings.The Engineer incharge may select any wattage capacity between the ranges shown.) (A) Square/ Circular shaped Surface/Recessed Mount Downlight with provision for spring loaded mounting clips complete.IP20(iv) 22-24 watts, Surge-2 KV Cat.III	645.00	751.00	ea	484395.00
174	Providing & erecting Approved make Power Saving 50 Watt Ceiling Fan with double ball bearing ISI mark with Condenser 230 volt A.C. 50 Hz 1200 mm sweep complete having 3blades with aluminium blades with , canopy & 30 cm. down rod erected with earthing.(Make shall be approved by Engineer in charge))	188.00	1929.00	ea	362652.00
175	Supplying and erecting approved make Bracket fan of 230 volt, A.C. 50 Cy/s., 400/450 mm sweep complete erected on wall or with lead Cores and connections complete. Cat.II	4.00	2085.00	ea	8340.00
176	Supplying & erecting single phase approved make industrial exhaust fan suitable for medium duty ring mounted low noise operation suitable for medium duty having following dia size and maximum speed in RPM [A] 305 mm dia 900 RPM Cat.II	21.00	2034.00	ea	42714.00

177	Supplying & erecting UPVC Mini trunking (PVC Casing-n-Capping) having double-locking arrangement with grooves, trunking of size not below 12.5 mm in height as per IS with accessories of PVC/Resin polypropylene not below 1.8 mm thick duly sealed in joint & erected on wall / ceiling of following size . (2) 25 mm	100.00			
			30.00	Mtr.	3000.00
178	Providing and erecting Sheet Steel powder coated MCB distribution board - flush / surface mounted fitted with busbar, neutral link, earth bar and DIN rail, Conforms to IS 8623-1 & 3, IEC 61439-1 & 3 without MCB to house appropriate nos. of MCBs.(The DBs should be used of same company of MCB to be used) suitable for (B) three phase incoming and single phase horizontal type outgoing Per phase isolation type (PPI) (b) sheet steel double door (ii)6 way	6			
			2885	ea	17310.00
179	Providing and erecting Sheet Steel powder coated MCB distribution board - flush / surface mounted fitted with busbar, neutral link, earth bar and DIN rail, Conforms to IS 8623-1 & 3, IEC 61439-1 & 3 without MCB to house appropriate nos. of MCBs.(The DBs should be used of same company of MCB to be used) suitable for (B) three phase incoming and single phase horizontal type outgoing Per phase isolation type (PPI) (a) single door (ii)6 way	1.00			
			2233.00	ea	2233.00
180	Providing and erecting Approved make RCCBs conforming to IS: 12640 and having sensitivity of 30 mA and Short Circuit withstand capacity of 10 KA and suitable for operation on 3 phase and neutral 415V,50Hz. having characteristic of quick action & tripping with all advance feature & do not incorporate any electronic component for following Max. rating erected as directed.(iii) 63 Amps. FP Cat. III	6			
			3010	ea	18060.00
181	providing and erecting Miniature circuit breaker single pole 6A to 25A suitable to operate on 240 V A.C. system and having breaking capacity 10 KA to be erected in existing box. confirming to IS 8828/1996 with ISI Mark Cat.III	104.00			
			111.00	ea	11544.00
182	Providing & erecting 415V MCB Four Pole Switch for Lighting Load (B curve) having 10KA breaking capacity & confirms to IS :8828 in existing box having following capacity (a) 6 to 32 Amp. Cat.III	1			
			573	ea	573.00

183	Supplying & erecting approved make RCCB + MCB (Electro magnetic type only) working on residual current device having 10 KA short circuit breaking capacity and 30 mAmp. Sensitivity & 30 mili sec. tripping time conforming to IS 12640 test knob facility trip free mechanism operating for rated leakage at nominal ten volt, complete erected including all materials lugs screws etc. completed. [e] 32A to 40 A, 4 Pole Three Phase Cat. II	1.00			
			2145.00	ea	2145.00
184	Supplying & erecting approved make RCCB + MCB (Electro magnetic type only) working on residual current device having 10 KA short circuit breaking capacity and 30 mAmp. Sensitivity & 30 mili sec. tripping time conforming to IS 12640 test knob facility trip free mechanism operating for rated leakage at nominal ten volt, complete erected including all materials lugs screws etc. completed. [a] 6A / 10A / 16A / 20A / 25A 2 pole single phase Cat. II	1			
			1798	ea	1798.00
185	Providing and erecting XLPE(IS:7098)(I)-88 ISI armoured cable multistrand / Solid Copper conductor for 1.1 KV. to be laid on wall with necessary clamps or in existing trench / pipe at road crossing or floor of following size of cables.(C) 4 core 6 Sq. mm	405.00			
			503.00	mtr	203715.00
186	Providing and erecting XLPE(IS:7098)(I)-88 ISI armoured cable multistrand / Solid Copper conductor for 1.1 KV. to be laid on wall with necessary clamps or in existing trench / pipe at road crossing or floor of following size of cables.(B) 4 core 4 Sq. mm	40			
			359	mtr	14360.00
187	Providing and erecting XLPE(IS:7098)(I)-88 ISI armoured cable multistrand Copper conductor for 1.1 KV. to be laid on wall with necessary clamps or in existing trench / pipe at road crossing or floor of following size of cables. (E) 3 1/2 core 95 Sq. mm (50 Sq. mm 1/2 core)	20.00			
			480.00	mtr	9600.00
188	Providing and erecting XLPE(IS:7098)(I)-88 ISI armoured cable multistrand / Solid Copper conductor for 1.1 KV. to be laid on wall with necessary clamps or in existing trench / pipe at road crossing or floor of following size of cables.(A) 4 core 2.5 Sq. mm	310			
			267	mtr	82770.00

189	Providing & laying approved make Double walled corrugated pipes (DWC) of polyethylene(conforming to IS 14930 II)with necessary connecting accessories of same material at required depth in existing trench for laying of cable. below ground / road surface for enclosing cable (A)50 mm outer dia	300.00	62.00	mtr	18600.00
190	Solder less crimping type Aluminium lugs conforming to IS suitable for cable of following size evenly crimped with high pressure tool & connected to switchgear terminals with brass/cadmium plated nut bolts in an approved manner. (A) 1.5/ 2.5/4/6 Sq.mm	192	6	ea	1152.00
191	Providing and, fixing heavy duty flange type brass cable gland with rubber ring for PVC insulated armoured cable complete with out going tails, insulating tape etc for following size of cables.(A) 2 to 4 core 2.5 / 4 Sq. mm	32.00	33.00	ea	1056.00
192	Providing and, fixing heavy duty flange type brass cable gland with rubber ring for PVC insulated armoured cable complete with out going tails, insulating tape etc for following size of cables. (B) 2 to 4 core 6 Sq. mm	12	38	ea	456.00
193	Making trench in soft soil of suitable width of 90 cm deep for laying cable or locating the fault all over the run and back filling the same and making the surface as normal ground.	350.00	46.00	mtr	16100.00
194	Providing & laying approved make ISI marked HDPE 6Kg / cm2 (Class-3) as per IS:4984:1995 PE-80 to be erected at road crossing on or floor as directed for laying of cable. The pipes as following size of dia & weight per 6 mtr.(D) 75 mm inner Dia.	120	348	mtr	41760.00

195	<p>Supplying and erecting LED indoor fittings with LEDs of wattage 0.2 Watt to 0.5 Watt assembled on single MCPCB, with housing used as a heat sink shall be made of thick sheet Steel conforming to IS: 513/CRCA/ aluminium die cast powder coated and high U.V. & corrosion resistance with diffuser with company mark/name 160V to 270V, Power Factor more than 0.95, THD < 15%, CCT 3000 K to 6500K, Luminaire efficacy > 85 lumens/watt ,LED LED driver efficiency > 85 % (fitting required LM-79 & LM-80 Certificates)(NOTE: Below description have shown ranges of Wattage capacity of LED fittings.The Engineer incharge may select any wattage capacity between the ranges shown.) (A) Tube Light with integral driver (iv) 22-24 Watts, Surge - 2KV,IP-20, conventional 4 feet Cat-III</p>	6.00	370.00	EA	2220.00
196	<p>Supplying and erecting Flexible PVC insulated multi strand multi core 1.1 kv grade ISI marked copper wires of following size to be erected as directed. (e) 1.50 Sq.mm 3 core round PVC sheathed</p>	50	44	MTR	2200.00
197	<p>Supplying & erecting Galvanized M.S pipe post "B" class 88.9 mm O.D 4 mtr. Long duly painted with two coats of aluminium paint complete with metallic base plate of 300 mm x 300 mm x 4mm thick for using as a compound light pole with approx. weight 32 Kg.</p>	14.00	3194.00	EA	44716.00
198	<p>Supplying and erecting LED street light / Flood light fittings with High power White LEDs wattage of 3 Watt and above assembled on single MCPCB, efficiency more than 130 lm/w and corrosion free High pressure die cast aluminum housing with smooth finish powder coated and heat sink extruded aluminium with diffuser and Polycarbonate optics/ lenses, with toughened glass with company mark/name engraved or embossed 160 to 270 V,Power Factor more than 0.95, THD < 10 %, CCT 3000 K to 5700K,Uniformity ratio >0.45, Luminaire efficacy > 100 lumens/watt . LED driver efficiency > 85 %.(fittings required LM-79 & LM-80 certificates)(NOTE: Below description have shown ranges of Wattage capacity of LED fittings.The Engineer incharge may select any wattage capacity between the ranges shown.) (C) Post Top Lantern LED fitting comprises of finish cast aluminum spigot and spun aluminum canopy fixed with opal polycarbonate, pipe arrangement for vertical mounting driver and accessories wired upto terminal block.IP 65 (ii)32-40W Ccking,</p>	14.00	4772.00	EA	66808.00

199	Supplying & erecting approved make SMC press moulded composite FRP. loop-in, loop-out approx. 2mm thick box complete with Bakelite connector strip 5way(3P+N+E),DIN rail for mounting mob & hinged doors as per requirement having locking arrangements with mounting clamp with nuts, bolts & washers suitable for erection on pole with cable clamps& earth bolt of following size of box. (C)150mm x 125mm x 100mm [deep]	14	472	EA	6608.00
200	Providing and erecting Pipe type earthing having 150 cms.long and 2.5 cms. dia. galvanised iron pipe with coupling and buch buried in specially prepared earth pit complete with necessary 8 SWG earth wire.	14.00	365.00	EA	5110.00
201	Providing and, fixing heavy duty flange type brass double compression type cable gland with rubber ring for PVC insulated armoured cable complete with out going tails, insulating tape etc for following size of cables.(D) 3 & 1/2 core 95 Sq. mm	2	130	EA	260.00
202	For using salt and charcoal / coke as required for pipe type earthing.	14.00	170.00	EA	2380.00
203	Providing 1:2:4 cement concrete foundation & 70 % PCC from bottom including excavation for the pole of size 45 x 45 x 100 cm. Deep in below ground level with plinth of 45 cm x 45 cm (or 45 cm dia x 45 cm) high upper ground level with necessary curing and finishing in approved manner. (for 4 & 6 mtr pole)	14	801	EA	11214.00
204	Providing Supplying, Fixing and commissioning SOLAR WATER HEATER WITH all required fixers and fittings for hot water supply of Havells SOLERO 200 L SLR WHITE or Equivelant etc. Complete as design by Architect and directed by EIC	25.00	41156.00	EA	1028900.00

205	Supplying & erecting in earthpit of minimum bore dia. 225mm size approved make Safe Earthing Electrode consisting Pipe-in-Pipe Technology as per IS 3043-1987 made of corrosion free hot dipped G.I.Pipes having Outer pipe dia of 80 mm having 80-200 Micron galvanising, Inner pipe dia of 40 mm having 200-250 Micron galvanising, connection terminal dia of 14 mm with constant ohmic value surrounded by highly conductive compound with high charge dissipation suitable for following type of applications with chamber and heavy duty cover (A)(approved make OEM has to submit test certificate including value of earth resistance of installation duly stamped and signed by agency and officer Incharge has to ensure the value of earthing resistane mentioned in test Certificate) & having back filling compound of (B) Inner chemical (CCM Compound)- Resistivity:- 0.2 ohm / meter testing as per IEC 62561-2017, Voltage drop:- < 1 volt at no load & dry form, Sulphar content: <2%(C) Back fill Compound :- Earthing compound should be capable to retain moisture for long time Necessary test report must be submitted by Agency.[B] For Electrical installation up to 11 KV located in other than normal soil i.e. Soft Rock, Marshy Soil etc.	9			
			7025	EA	63225.00
206	Providing and erecting required size HOT deep Galvanised iron strip for earthing of H.T. , OCB/ ACB/ Transformer LT panel board, Motors etc. using proper clam	20.00	77.00	KG	1540.00
207	Providing and erecting required size Copper strip for earthing of H.T. OCB / ACB/ Transformer, LT panel board, Motors etc. using copper clamp.	15	787	KG	11805.00
208	Providing and erecting Annealed bare Copper wire 8 to 16 SWG.	10.00	787.00	KG	7870.00
209	providing and erecting Mains with ISI marked, 1.5KV grade electrolyte multi stranded, annealed copper conductor with heat resistant PVC insulated conforms to IS 694, IEC - 227 erected in existing pipe of following size (Specifically for control panel, relays, power switchgears, motor starters & control wiring) with required size of copper lugs, nuts and bolts if required. (d) One wire 4.00 sq. mm	310	35	MTR	10850.00
210	Supplying KITKAT pattern porcelain cut-out fuse with base of following current capacity erected on existing block board. (vi) 200 A. 500 V.	3.00	416.00	EA	1248.00
211	MAIN LT PANEL AS PER DESIGN AND SPECIFICATION	1	115000	EA	115000.00
212	Providing and, fixing heavy duty flange type brass cable gland with rubber ring for PVC insulated armoured cable complete with out going tails, insulating tape etc for following size of cables. (C) 2 to 4 core 10 Sq. mm	2.00	38.00	EA	76.00

213	Providing and erecting XLPE(IS:7098)(I)-88 ISI armoured cable multistrand Copper conductor for 1.1 KV. to be laid on wall with necessary clamps or in existing trench / pipe at road crossing or floor of following size of cables. (A) 4 core 10 Sq. mm	90	667	MTR	60030.00
214	Solder less crimping type Copper lugs conforming to IS suitable for cable of following size evenly crimped with high pressure tool & connected to switchgear terminals with brass/cadmium plated nut bolts in an approved manner. (B) 10 Sq.mm	8.00	10.00	EA	80.00
215	Supplying, Erecting, Testing & Commissioning the passenger / stretcher lift having following main features:15/16 Passengers, Ground plus 1 upper floor with Rated Speed of 1.0 m/sec., (B) With General Specification attached herewith. Cat.III (B) SPECIAL FEATURES DESCRIPTION OF LIFTS for PREMIUM category 1. Advanced control system dual 64 bit embedded microprocessor with CANBUS Serial Communication mode including Regenerative power efficient operation,on site programming facility, Anti nuisance, Pte-opening, BMS/RMS with necessary online real time monitoring system having necessary connectivity for remote monitoring & other suitable supporting hardware & software devices to fulfil the purpose. 2. Floor Indication LCD Display with call registration & brail mark with arrival gong and hall lantern & TFT Screen in the car with MP3 Voice Announcer. 3. CAR Panel should be Scratch resistive SS Moonrock finish / Hair Line / Honeycomb for car and all Doors, All landing doors must have fire rating up to 2 hourould be capable to retain moisture for long time Necessary test report must be submitted by Agency.[B] For Electrical installation up to 11 KV located in other than normal soil i.e. Soft Rock Marshy Soil etc	1	1485982	EA	1485982.00
216	Design,Supply,installation and testing of Fire Protection System all Fire safety equipments inclusive of on-site work (chasing, piping, fixing, colour etc as may be required and making good) as per requirement stipulated in prevailing NBC code for said building type. Inclusive of testing, commissioning in all respects and getting approval (noc) from all concerned authorities etc complete. NOTES.1- work done as per prior approval of drawings, 2- It is the responsibility of agency to get approval of fire plan before work start from respective departments., 3- whole work done as per present fire guidelines, 4- It is the responsibility of agency to get approval of Fire NOC from respective departments., 5- It is the responsibility of agency to take care of Existing building during Executing the work, if any damage occurs in building its contractor responsibility to repair own cost., 6- It is responsibility of agency to take care of each items installed till handing over., 7- It is the responsibility of agency to execute mock drill with intimation & in presence of engineer in charge.	1	2126501	job	2126501.00

11,99,40,840.71

	TOTAL RS.(WHITHOUT GST)	SAY'S	11,99,40,841.00
--	--------------------------------	--------------	------------------------

I/We am / are willing to carry out the work at % above/ below percent (Should be written in figures and words) of the estimated rate mentioned above. Amount of my/ our tender works out as under.

*Estimated Amount		*Estimated Amount	
Put to tender	Rs.	Put to tender	Rs.
Add.....% above Rs.		Deduct% below Rs.	
Total	Rs.	Net.	Rs.
In Words	In Words

Notes 1 - All work shall be carried out as per Public Works Department Handbook and other specifications of Division or as directed.

Notes 2 - Rates quoted include clearance of site (prior commencement of work and at its close) in all respects and hold good for work under all conditions, site, moisture, weather etc.

Note 3 - To be continued on additional sheets, if found necessary.

Note. During the execution of the tendered work, if any other defect is found in the previously implemented civil work, the repair work needs to be carried out by selected agency at their own cost and at their own risk. BHAVNAGAR MUNICIPAL CORPORATION is not obliged to pay anything for that repair work.

SIGNATURE OF CONTRACTOR/AGENCY WITH STAMP

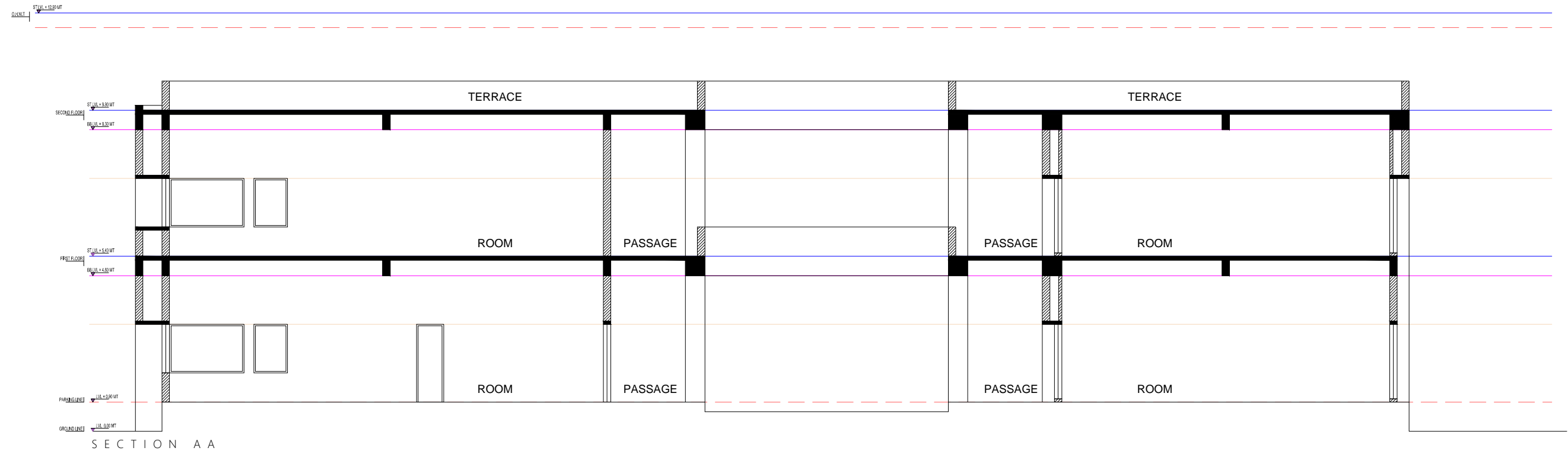

SECTION AA

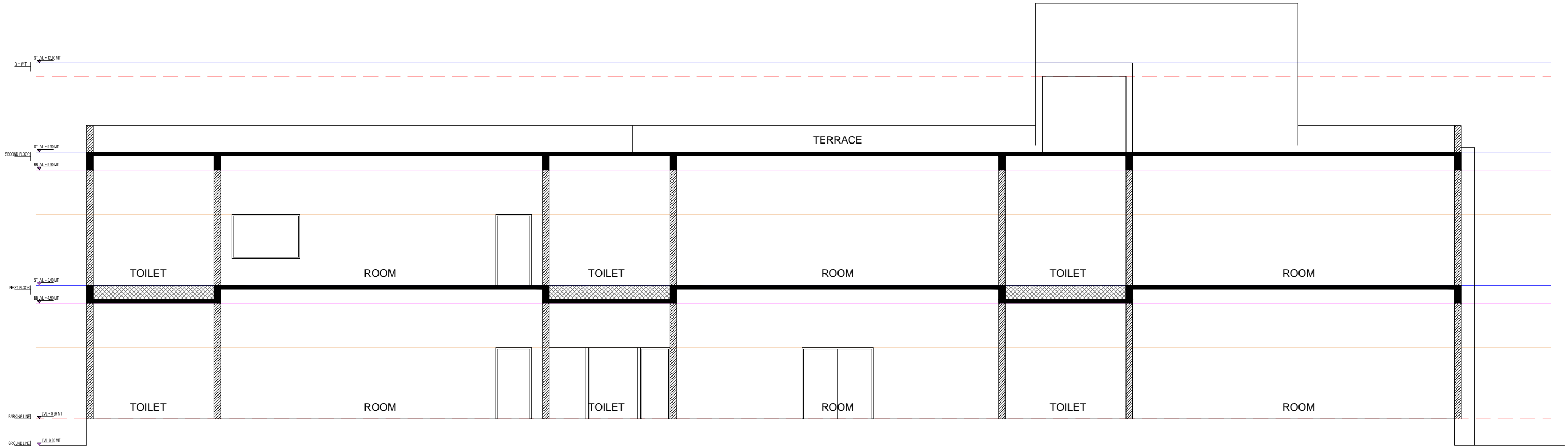

SECTION BB

PROJECT NO. BMC -03/gd DRAWING NO. A3-07	TITLE :- SECTIONS	B.M.C. PROPOSED NIGHT SHELTER AT FULSAR T.P. SCHEME, BHAVNAGAR FOR BMC	DWG.DATE:- 31 -03 -2023	1) ALL DIMENSIONS ARE IN METERS. 2) ALL DIMENSIONS TO BE READ AND NOT MEASURED. 3) ALL DIMENSIONS ARE FROM UNFINISHED SURFACES. 4) ALL STRUCTURAL DRGS. TO BE READ SIMULTANEOUSLY WITH ARCHITECTURAL DRGS. 5) ALL DIMENSIONS TO BE VERIFIED BY THE CONTRACTOR AND ANY AMBIGUITY TO BE BROUGHT TO THE IMMEDIATE NOTICE OF THE ARCHITECT. 6) ALL INTERNAL WALLS, BEAMS, COLUMNS AND SLABS ARE FINISHED WITH 12.5MM THK. SMOOTH PLASTER UNLESS OTHERWISE SPECIFIED. 7) ALL EXTERNAL WALLS ARE FINISHD WITH 25MM. THK. SANDFACED PLASTER UNLESS OTHERWISE SPECIFIED. 8) ALL LEVELS ARE INDICATED CONSIDERING THE EDGE OF APPERTANT ROAD AS + 0000 LVL.	THESE DRAWINGS & DESIGNS ARE THE SOLE PROPERTY OF AR. CHINTAN SACHAPARA AND AS SUCH SHALL NOT BE REPRODUCED IN ANY FORM WITHOUT EXPRESSED WRITTEN PERMISSION OF AR. CHINTAN SACHAPARA . ALL DRAWINGS AND RELATED DOCUMENTS SHALL BE RETURNED TO AR. CHINTAN SACHAPARA UPON REQUEST.	IT IS THE RESPONSIBILITY OF THE CLIENT OR THE PROJECT MANAGEMENT COMPANY/ BMC'S ENGINEERS TO CHECK THE COORDINATION OF THE DRAWING WITH SITE BOUNDARIES. AR. CHINTAN SACHAPARA DO NOT HOLD ANY RESPONSIBILITIES IN CASE OF LEGAL CONFLICTS AND /OR MISHANDLED SITE C O O R D I N A T I O N .	 CHINTAN SACHAPARA ARCHITECTS ARCHITECTURE & INTERIOR DESIGN + 9 1 - 9 4 - 2 8 - 4 0 1 - 6 4 0 3, SHAHIBAUG, ABOVE HOMEDCOR, WAGHAWADI ROAD, BHAVNAGAR.
---	---------------------------------	---	----------------------------	--	--	---	--



SITE PLAN

CHINTAN SACHAPARA ARCHITECTS
 ARCHITECTURE & INTERIOR DESIGN
 + 91 11 94 287401 640
 3, SHAHIBAUG, ABOVE HOMEDECOR,
 WAGHAWADI ROAD, BHAVNAGAR.

IT IS THE RESPONSIBILITY OF THE CLIENT OR THE PROJECT MANAGER TO CHECK THE COORDINATION OF THE DRAWING WITH SITE BOUNDARIES. **CHINTAN SACHAPARA** DO NOT HOLD ANY RESPONSIBILITIES IN CASE OF LEGAL CONFLICTS AND /OR MSHANDLED SITE COORDINATION.

THESE DRAWINGS & DESIGNS ARE THE SOLE PROPERTY OF **CHINTAN SACHAPARA** AND AS SUCH SHALL NOT BE REPRODUCED IN ANY FORM WITHOUT EXPRESS WRITTEN PERMISSION OF **CHINTAN SACHAPARA**. ALL DRAWINGS AND RELATED DOCUMENTS SHALL BE RETURNED TO **CHINTAN SACHAPARA** UPON REQUEST.

1) ALL DIMENSIONS ARE IN METERS. 2) ALL DIMENSIONS TO BE READ AND NOT MEASURED. 3) ALL DIMENSIONS ARE FROM UNFINISHED SURFACES. 4) ALL STRUCTURAL DRGS. TO BE READ SIMULTANEOUSLY WITH ARCHITECTURAL DRGS. 5) ALL DIMENSIONS TO BE VERIFIED BY THE CONTRACTOR AND ANY AMBIGUITY TO BE BROUGHT TO THE IMMEDIATE NOTICE OF THE ARCHITECT. 6) ALL INTERNAL WALLS, BEAMS, COLUMNS AND WALLS ARE FINISHED WITH 12.5MM THK. SMOOTH PLASTER UNLESS OTHERWISE SPECIFIED. 7) ALL EXTERNAL WALLS ARE FINISHED WITH 25MM THK. SANDFACED PLASTER UNLESS OTHERWISE SPECIFIED. 8) ALL LEVELS ARE INDICATED CONSIDERING THE EDGE OF APPURTANT ROAD AS + 0000 L.V.L.

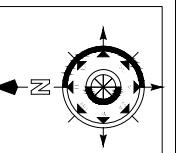

DWG. DATE: 31-03-2023

B.M.C.
 PROPOSED NIGHT SHELTER AT FULSAR T.P. SCHEME, BHAVNAGAR FOR BMC

TITLE: SITE PLAN

PROJECT NO. BMC-03/gd
 DRAWING NO. A3-01

**TENDER
PART-I
TECHNICAL BID**

NAME OF WORK : PROPOSED DEVELOPMENT OF NIGHT SHELTER
AT FULSAR, FOR BHAVNAGAR MUNICIPAL
CORPORATION (B.M.C), BHAVANAGAR

ESTIMATED COST :- 11,99,40,841.00

EARNEST MONEY DEPOSIT :- 12,00,000.00

TIME LIMIT :- 32 months(including Monsoon Period)

**LAST DATE OF ACCEPTING
TENDER :-**

TENDER FEE :-

**21240.00(Non refundable)18000.00+18
%GST(3240.00)=21240.00**

ARCHITECTS:-

CHINTAN SACHAPARA

ARCHITECTS

3,SHAHIBAUG,ABOVE HOME DÉCOR,WAGHA WADI ROAD,

BHAVNAGAR

PHONE : 9428401640

***EXECUTIVE ENGINEER
BUILDING DEPARTMENT
BHAVNAGAR MUNICIPAL CORPORATION
BHAVNAGAR***

**NAME OF WORK :-
PROPOSED DEVELOPMENT OF NIGHT SHELTER AT FULSAR, FOR BHAVNAGAR
MUNICIPAL CORPORATION (B.M.C), BHAVANAGAR**

TECHNICAL BID

SCHEDULE : 'A'

-: STRUCTURE AND ORGANISATION:-

1	Name of the company Address, Telephone No. Telex No. Fax No.	:	
2	Description of Company (For e.g. General Civil Engineering contractor Supplier of equipment etc.)	:	
3	Registration and classification with the P.W.D. in Gujarat/India.	:	
4	Name and address of the Bankers.	:	
5	No. of year of Experience as a general contractor	:	
6	Number of year of Experience as a sub - country.	:	
	In own country Internationally.		
7	Name and address of the companies who will be involved in the construction of various items civil works namely.	:	
	[a] Preconstruction soil investigations. [b] Main work (Building work) [c] Miscellaneous works.		
8	Attached an organization chart showing the structure of the company including names and position of directors and key personal.		
<p>NOTE : [1] The above information shall be supported with documents other wise the same shall be treated as null & void. [2] Particular of above items should be furnished separately for each partner.</p>			

Signature of Bidder

SCHEDULE : 'B'

-: FINANCIAL STATEMENT:-

1	Name of firm	:	
2	Capital		
	[a] Authorized	:	
	[b] Issued & paid up	:	
3	Attach audited balance sheet and profit & loss statement for the last 05 (Five) years. i.e. 2019-20 to 2023-24	:	
4	Financial position		
	[a] Cash	:	
	[b] (i) Fixed assets	:	
	(ii) Liquid or movable assets	:	
	[c] Current Liabilities	:	
	[d] Working capitals		
	(i) Share capitals	:	
	(ii) Partner's capital	:	
	(iii) Deposit	:	
	[e] Net worth (Excess at current liabilities over liquid or movable assets)	:	

5	<i>Total Liabilities</i>				
	<i>[a] Current ratio</i> <i>(Current assets to current liabilities)</i>				
	<i>[b] Acid test Ratio</i> <i>(Acid tests ratio cash, Temporary investment held in lieu of cash & current Recoverable to current liabilities.</i>				
	<i>[c] Total Liabilities to net worth.</i>				
NOTE :- Information asked against each item is to be carefully filled in more reference to balance sheet in reply to above point is not acceptable.					
6	<i>Annual value Turnover of construction works undertaken for each of the last five (5) Financial years.</i>				
	<i>One year before</i>	<i>Two year before</i>	<i>Three year before</i>	<i>Four year before</i>	<i>Five year before</i>
	<i>2023-24</i>	<i>2022-23</i>	<i>2021-22</i>	<i>2020-21</i>	<i>2019-20</i>
	<i>Home :</i>				
	<i>Abroad :</i>				
7	<i>Net Profit before tax</i>				
	<i>[a] Current period</i>				
	<i>[b] During the last Financial year</i>				
	<i>[c] During each of the four</i>				
	<i>[d] Previous financial years</i> <i>The Profit and loss statements have been certified Through _____ by _____.</i>				
8	<i>Applicant's financial arrangement for proposed work. (Exact amount in Rs. to be mentioned)</i>				
	<i>[a] Own resources</i>				
	<i>Rs.</i>				

	<i>[b] Bank credits</i>	:	Rs.
	<i>[c] Others (Specify)</i>	:	Rs.
9	<i>Certificate of financial soundness from bankers of applicants together with their full address.</i>	:	
10	<i>Approximate value of works in hand.</i>	:	Rs.
11	<i>Value of anticipated orders For next financial year.</i>	:	Rs,
	<i>Home :</i>		
	<i>Abroad :</i>		
<p>Note :- <i>[1] Details of Item No.10 and 11 are to be given in Schedule 'E' & 'F' - certified copies of actual audit report by chartered accountant for the financial year 2019-20 to 2023-24 shall have to be uploaded by scanning.</i></p> <p><i>[2] Information asked against each item shall be carefully filled & any additional information shall be given separately duly signed.</i></p> <p><i>[3] The above information supported by last financial year Balance Sheet/ Profit & Loss account etc. must be audited by the C.A. & I.T.C. shall be furnished.</i></p> <p><i>[4] The above information shall be supported with necessary documents otherwise the same shall be treated as null & void.</i></p>			

Signature of Applicant.

CONTRACT

SCHEDULE : 'C'

PERSONNEL

DETAILS OF PERSONNEL WITH THE APPLICANT

NAME OF THE APPLICANT :-

Sr. No.	Description	On Applicants Pay Roll	
		Civil Work	Electric Work
1	2	3	4
1	Project Manager		
2	Works Manager (Main Civil Works)		
3	Number of Engineering Graduates		
	[a] Design (Civil)		
	[b] Construction Supervision (Civil)		
	[c] Electrical Engineer.		
4	Number of Administrative Graduates		
5	Number of Skilled Employees		
6	Number of Unskilled Employees		
7	[1] In case of personal at Sr. No.1 to 4 please give name, qualification present condition, professional experience and linguistic ability.		
	[2] The certified copy of degree/ diploma engineers, qualification with an affidavit on stamp paper stating their appointment in the firm shall have to be attached with this schedule		
	[3] The above information shall be supported with necessary documents otherwise the same shall be treated as null and void.		

Signature of Applicant.

SCHEDULE : 'D'

NAME OF THE APPLICANT :

The applicant shall provide adequate information to demonstrate clearly that it has the capability to meet the requirements for each and all items of equipment listed below. A separate form shall be prepared for each Item of equipment listed in : Para 9 - 14 of the Instruction to applications, or for alternative purposed - by the applicant.

PLANT & EQUIPMENT PROPOSED TO BE DEPLOYED BY THE APPLICANT FOR USE ON THE ROAD WORK AND BUILDING WORK LAND SCAPING WORK & ELECTRICAL WORK .

Sr. No.	Name of Equipment	Equipment In hand (Owned)			Equipment to be Procured		
		No. of Each	Year of Manu. & Present	Name of Owner	No. on each	Capacity	Through Purchased / Lease.
1	2	3	4	5	6	7	8
1							
2							
3							
4							
5							
6							
7							
8							
9							
10							
11							
12							

NOTE :

[1] The above information may be furnished for each machinery and equipment listed herewith.

[2] The location of machinery should be furnished in detail i.e.

(i) Site of work (ii) Own workshop (iii) Other places.

[3] The documents regarding ownership of machinery/ equipment etc. and attested copies of hire purchase agreement if any must be enclosed.

* If listed indicate the date when the current lease expires.

*[4] Describe the fabrication and workshop facilities. [a] To be set up at site.
[b] To be sub contracted locally. [c] To be set up at any other place with
relevant details.*

*[5] The above information shall be supported with necessary documents
otherwise, the same shall be treated as null & void.*

*[6] Name of equipments are as per qualification document point number
9.14 A equipment capabilities of building works.*

Signature of Applicant.

SCHEDULE : 'E'

EQUIPMENT CAPABILITY

NAME OF THE APPLICANT :

The applicant shall provide adequate information to demonstrate clearly that. Is has the capability to meet the requirements for each and all items of equipment listed in the instruction to applicants. A separate form shall be prepared for each Item of equipment listed in; Para 9.14 of the Instruction to applicants, or for alternative proposed - by the applicant.

Item of equipment

Equipment Information

- 1. Name of manufacture*
- 2. Model and power rating*
- 3. Capacity*
- 4. Year of manufacturer*

Current Status

- 5. Current location*
- 6. Details of current commitments*

Sources

- 7. Indicate source of the equipment
Owned, Rented leased specially
manufactured.*

Omit the following information for equipment owned by the applicant or partner.

Owner

8. Name of Owner

9. Address of Owner

10 Contract Name and Title

11. Telephone

12. Fax

13. Telex

Agreement :- Details of Rental/ Lease manufacture agreement specified to the Project.

Signature of Applicant.

SCHEDULE : 'F'

EXPERIENCE: - Relevant (**Building work, Electrical work,)** Project Completed.

Please furnish information about the relevant project (**Building work, Electrical work**) completed over the last five years

Name of the employer	Name of location and type of building contracted	Name of engineer responsible for supervision	Contract price (Rs.in lacs)	Final value as per bill prepared by employer	Additional amount realised if any through court claims or by awarded or arbitrator	Date of work order	Stipulated date of completion of work	Actual date of completion	Reasons for delay in completion if any
1	2	3	4	5	6	7A	7B	7C	8

NOTE :

- [1] Attested copies of the latest certificate from the employers may be attached.
- [2] Non disclosures of any information in the schedule will result in disqualification of the firm.
- [3] In case of private work sufficient authentic proof of work done. Along with evidence of financial transactions shall have to be furnished.

Signature of Applicant.

SCHEDULE : 'G'

EXPERIENCE :- Relevant (**Building work**) Project In progress.

*Give information about the relevant project (**Building work**) in progress including the works for which the company has received a letter of intent but a formal contract has not yet been awarded*

Name of the employer	Name of engineer responsible for supervision	Location and description of building works	Value of contract	Value of completed and certified	Percentage of practical completion	Date of work order	Stipulated date of completion of work	Likely completion date	Reasons for delay in completion if any
1	2	3	4	5	6	7A	7B	7C	8

NOTE :

- [1] Attested copies of the latest certificate from the employers may be attached.
- [2] Non disclosures of any information in the schedule will result in disqualification of the firm.
- [3] In case of private work sufficient authentic proof of work done. Along with evidence of financial transactions shall have to be furnished.

Signature of Applicant.

SCHEDULE : 'H'

STATEMENT OF WORKS UNDER LITIGATION

<i>Year</i>	<i>Award for work</i>	<i>Name of Client/ cause of litigation and matter in Disputed (Amount in Rs.)</i>

Signature of Applicant.

CONTRACT

SCHEDULE : 'I'

ADDITIONAL INFORMATION

The applicant can add here any further information relevant to the evaluation of their qualifying criteria.

Signature of Applicant.

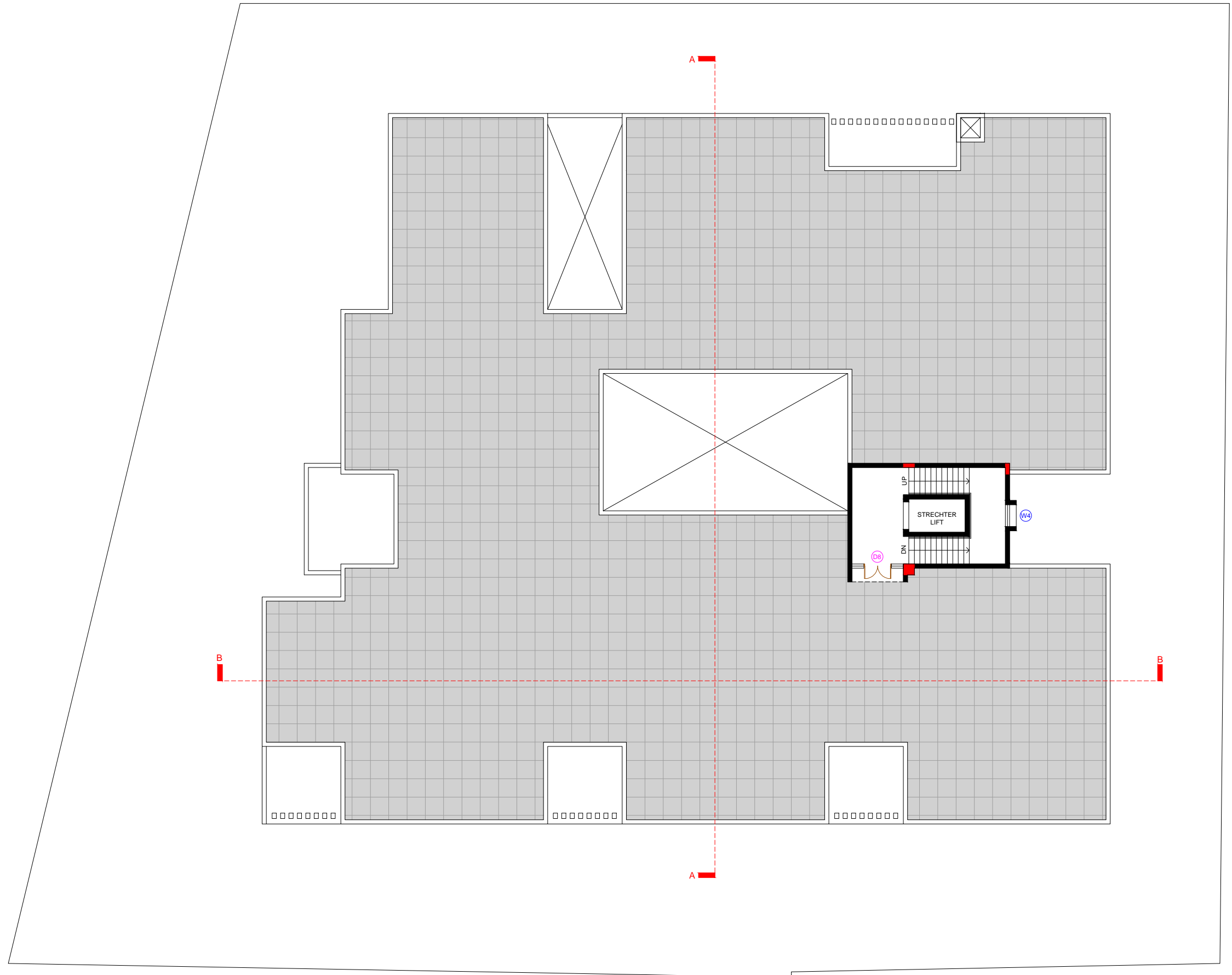

PROJECT NO.
BMC -03/gd
 DRAWING NO.
A3-04

TITLE :-
TERRACE FLOOR PLAN

B.M.C.
 PROPOSED NIGHT SHELTER AT FULSAR T.P. SCHEME, BHAVNAGAR FOR BMC

DWG.DATE:-
 31 -03 -2023

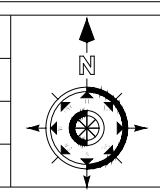

1) ALL DIMENSIONS ARE IN METERS. 2) ALL DIMENSIONS TO BE READ AND NOT MEASURED. 3) ALL DIMENSIONS ARE FROM UNFINISHED SURFACES. 4) ALL STRUCTURAL DRGS. TO BE READ SIMULTANEOUSLY WITH ARCHITECTURAL DRGS. 5) ALL DIMENSIONS TO BE VERIFIED BY THE CONTRACTOR AND ANY AMBIGUITY TO BE BROUGHT TO THE IMMEDIATE NOTICE OF THE ARCHITECT. 6) ALL INTERNAL WALLS, BEAMS, COLUMNS AND SLABS ARE FINISHED WITH 12.5MM THK. SMOOTH PLASTER UNLESS OTHERWISE SPECIFIED. 7) ALL EXTERNAL WALLS ARE FINISHD WITH 25MM. THK. SANDFACED PLASTER UNLESS OTHERWISE SPECIFIED. 8) ALL LEVELS ARE INDICATED CONSIDERING THE EDGE OF APPERTANT ROAD AS + 0000 LVL.

THESE DRAWINGS & DESIGNS ARE THE SOLE PROPERTY OF **AR. CHINTAN SACHAPARA** AND AS SUCH SHALL NOT BE REPRODUCED IN ANY FORM WITHOUT EXPRESSED WRITTEN PERMISSION OF **AR. CHINTAN SACHAPARA**. ALL DRAWINGS AND RELATED DOCUMENTS SHALL BE RETURNED TO **AR. CHINTAN SACHAPARA** UPON REQUEST.

IT IS THE RESPONSIBILITY OF THE CLIENT OR THE PROJECT MANAGEMENT COMPANY/ BMC'S ENGINEERS TO CHECK THE COORDINATION OF THE DRAWING WITH SITE BOUNDARIES. **AR. CHINTAN SACHAPARA** DO NOT HOLD ANY RESPONSIBILITIES IN CASE OF LEGAL CONFLICTS AND /OR MISHANDLED SITE COORDINATION.

CHINTAN SACHAPARA ARCHITECTS
 ARCHITECTURE & INTERIOR DESIGN
 + 9 1 - 9 4 - 2 8 - 4 0 1 - 6 4 0
 3, SHAHIBAUG, ABOVE HOMEDCOR, WAGHAWADI ROAD, BHAVNAGAR.