

BHAVNAGARMUNICIPALCORPORATION		
NoticeInvitingOn-LineTender		
TenderNoticeNo. /BUILDING/PHC-Kumbharwada/2024-25		
DepartmentName	:-	BuildingDepartment
IFBNo.	:-	BUILDING/PHC- Kumbharwada /2024-25 2nd attempt
NameofProject	:-	SJMSVY-2023-24 (Health Department)
NameofWork	:-	CONSTRUCTION OF NEW PHC IN THE AREA OF BHAVNAGAR CITY, KUMBHARWADA, BHAVNAGAR
TenderType		PERCENTAGE RATE TENDER ByOpenOnline
EstimatedContractValue(INR)	:-	Rs.3,10,17,210.00(Without GST)
PeriodofCompletion(inmonth)	:-	24 (Twenty four))Months including Monsoonperiod
BidderNationality		LCB (LocalCompetitionBidding)
QualificationOfBidder		DulyregisteredwithR&BinClass"A"Or Above
BidCall(Nos)	:-	1
TenderCurrencyType	:-	Single
TenderCurrencySettings	:-	IndianRupee(INR)
JointVenture/Consortium	:-	N.A.
Rebate	:-	Not Applicable
<u>AmountDetails</u>		
BidDocumentFee	:-	Rs.6000/-+ 1080/- (18% GST) = 7,080/- in the form of DD only
BidDocumentFeePayableTo	:-	Commissioner,MunicipalCorporation,Bhavnagar
BidSecurity /EMD(INR)	:-	Rs. 3,10,200 in the form of DD
BidSecurity/EMDinfavour of	:-	Commissioner,MunicipalCorporation,Bhavnagar
<u>TenderDates</u>		
BidDocumentDownloadingStart Date	:-	Dt. 20/12/2024
BidDocumentDownloadingEnd Date	:-	Dt. 30/12/2024 up to18.00 Hr.
PreBidMeeting&Time	:-	-
LastDate&TimeofOnlineBidSubmission	:-	Dt. 30/12/2024
PhysicalSubmissionofEMD Document Fee PQ Bid &Supportingalldocuments	:-	Up to Dt. 02/01/2025 up to 06:10pm officer of Executive Engineer Building Department, BMC-Bhavnagar
OpeningOfPQBid(Online)& TechnicalBid	:-	Dt. 03/01/2025 up to17.00 Hr.
Penalty		0.10 % of contract value per day to the maximum amount of 10% of contract value
OpeningOfPriceBid(Online)	:-	If convenient, intimationthroughletter.
BidValidity Period	:-	180Days

<p>Qualification of Bidder:</p>	<p>Tenderer shall be required to submit the enlisted documents in hard copy along with the Qualification Bid. If documents are insufficient or it does not match the required criteria mentioned below, then the Price Bid of the tenderer shall not be opened.</p> <p>Mainly tenderers shall fulfill following Technical & Financial pre-qualification criteria as a main contractor. The tenderer shall fulfill the following all points A to Q requirements / experiences for qualification.</p> <p>A. The Bidder must have achieved average annual turnover during last three financial years, ending on 31st March 2024, 30% of Estimated cost.</p> <p>Mainly tenderer shall fulfill following for pre-qualification,</p> <p>(a) Experience of having successfully completed "similar works" during last 05 years either of the following :</p> <p>(1a) Three similar completed works, each costing not less than amount equal to 40% of the Estimated Cost. OR</p> <p>(2a) Two similar completed works, each costing not less than amount equal to 50% of the Estimated Cost. OR</p> <p>(3a) One similar completed works, each costing not less than amount equal to 80% of the Estimated Cost.</p> <p><i>Similar work shall mean “ Successful completion of BUILDING WORK in R&B /Govt. /Semi Govt. / PSUs / Government Undertaking / Government Companies DEPARTMENT.”</i></p> <p>E. Available Bid Capacity (ABC) - must be more than the estimated tender cost. Note: Available Bid Capacity (ABC) will be derived by the following method. ABC is calculated as $ABC = 2 * A * N - B$ Where, A = Maximum value of works executed in any one year during the last five years (updated to present price level by applying enhancement factor) taking into account the completed as well as works in progress. N = Number of years prescribed for completion of the works for which tenders are invited. i.e. 12/12 = 1.00 B = Value of existing commitments and on-going works to be completed during that next N year (period of completion of the works for the tenders are invited.) Note: The statements/certificate showing the value of existing commitments and ongoing works as well as the stipulated period of completion remaining for each of the works listed should be signed by the respective Employer or his authorized representative, not below the rank of an Executive Engineer or equivalent.</p> <p>F. The cost of materials supplied by the Government / Clients shall not be taken into account for experience purpose.</p> <p>G. An attested copy of registration with R&B etc. Registration required: “A” class Or Above Bank Solvency of 2024-25, amounting 20% of estimated cost put to tender of any Nationalized / Scheduled Bank except Co-operative Bank.</p>
--	---

		<p>H. Following enhancement factors will be used for the cost of works executed and financial figures to arrive at common base for the value of the works completed in India. Cutoff month shall be considered from month of tender submission.</p> <table border="1"> <thead> <tr> <th>Year</th> <th>Multiplying factor</th> </tr> </thead> <tbody> <tr> <td>Immediate last year of the assessment year*</td> <td>1.1</td> </tr> <tr> <td>Second</td> <td>1.21</td> </tr> <tr> <td>Third</td> <td>1.33</td> </tr> <tr> <td>Fourth</td> <td>1.46</td> </tr> <tr> <td>Fifth</td> <td>1.61</td> </tr> </tbody> </table>	Year	Multiplying factor	Immediate last year of the assessment year*	1.1	Second	1.21	Third	1.33	Fourth	1.46	Fifth	1.61
Year	Multiplying factor													
Immediate last year of the assessment year*	1.1													
Second	1.21													
Third	1.33													
Fourth	1.46													
Fifth	1.61													

*Here assessment year shall be reckoned from year and month in Which tender is submitted.

	<p>I. The experience of Joint Venture / Back to back work/ Nominated Sub-contractors by agencies shall not be considered.</p> <p>J. The Bidder should submit Solvency Certificate minimum value of Rs. 62.03 lacs (20% of estimated cost put to tender) issued by schedule bank / Nationalized bank only and should be valid for at least up to six months from the date of submission. (Considering validity as 1 year from dt of issue of Solvency Certificate)</p> <p>K. The Bidder should submit the list of the works already completed during last 5 year in prescribed Performa and attested copies of certificates issued by head of the office concerned for completed work.</p> <p>L. The Bidder shall submit Declaration regarding the work on hand with the bidder in prescribed Performa. Attested copies of work orders, interim certificate if any shall also be attach as supporting documents for above.</p> <p>M. The Bidder shall submit the attested copy of partnership deed, power of attorney, etc.</p> <p>N. Joint Venture shall not be allowed.</p> <p>O. Even though the Bidder meets the above criteria, they are subject to be disqualified if they have</p> <ol style="list-style-type: none"> i) Made misleading or false presentations in the forms, statements and attachments submitted in proof of the qualification requirements; and /or ii) During verification if it is found from client that of poor performance such as abandoning the works, for financial failure or abnormal delay in work etc. iii) Regarding Litigation, in case where Bidder or JV
--	--

		<p>partner or MOU Partner is involved in illegal practice like any activities of corruption, coercive practice or debarred/blacklisted in last 2 years by Any Govt / Organization in respect of performance of Bidder / MOU partner /JV partner, BMC authority requires that bidders under this contracts, observe the highest standard of ethics during the procurement and execution of such contracts.</p> <ul style="list-style-type: none">(1) Will reject a proposal for award if it determines that the bidder has engaged in any corrupt or fraudulent practices in competing for this contract or in past history and(2) Will reject a proposal if it found debarred/blacklisted by any State Govt. /Govt. of India/ Semi Government/ PSU in last 10 years. <p>iv) The bidder or MOU partner shall not be under any Insolvency Bankruptcy code (IBC) resolution process at National Company Law Tribunal (NCLT) or undergone any Corporate Debt Restructuring (CDR) mode in the past 10 years in India from the date of the submission of the bid.</p>
--	--	--

P. The Bidder shall note that in case the Bidder / MOU partner is blacklisted / stated as defaulter/ barred participating in tenders by any of government agencies / semi government agencies / PSUs in India during last 10 years then in that case, the Bidder will be disqualified though the bidder satisfies all the pre-qualification conditions mentioned above, and the bidder will be debarred for next 3 years from participating in tender process for BMC.

Bidders should be selected based on quality work done by them and if necessary tender committee will inspect bidders ongoing and completed work

The decision of the commissioner to qualify the bidder will be the final.

Conditional Tenders will be out rightly rejected.

~~Q. The applicant must submitted this confirmation letter on Rs. 300.00 stamp paper with notary for Operating and Maintenance of proposed work shall include labour, all materials, plants, plants casualities, fertilizers, pesticides, tools, watering security of premises shall be responsibility of the Tenderer during the course of work and 2 year after the time of completion certificate from authority and all charges for the same born by the Contractor (Tenderer). 1% from every running bill shall be deducted towards SECURITY DEPOSITE of Operating and Maintenance of proposed work. IT WILL BE REALEASED AFTER COMPLETION PERIOD OF 24 MONTHS OF O & M.~~

R. If work is not completed within time limit, penalty of 0.10% per Day will be deducted from running bill and it will be upto 10%.

S. FDR For EMD and SD, or bank guarantee issued by **State Bank of india will not be accepted.** Bidder should submit FDR or bank guarantee issued by other nationalized bank only.

T. Bidders shall quote the rate with all taxes Excluding GST. Extra payment for GST will be done by BMC

U. If work is not completed within time limit, penalty of 0.10% per Day will be deducted from running bill and it will be upto 10%.

V. FDR For EMD and SD, or bank guarantee issued by state bank of India will not be accepted. Bidder should submit FDR or bank guarantee issued by another nationalized bank only.

W. Bidders shall quote the rate with all taxes excluding GST.

VARIATION IN QUANTITIES

Schedule of prices contain estimated quantities and actual quantities as executed becomes payable at agreed rates.

However, accepted rates will be valid till variation in quantities

	<p>up to any extent of the quantities so specified.</p> <p>Other terms and conditions of the tenders shall be read and considered as a part of the tender documents. The rates/prices quoted by the bidders will be final and any sort of escalation will not be considered.</p> <p>Note: Star Rate, Price Escalation, price Variation in any items of Schedule-B / Extra item will Not be given by Bhavnagar Municipal Corporation. If Same will be stated in any Bid Documents will not be Considered.</p>
--	--

Remarks	<p>:- Only Offer of those shall be opened whose EMD & Tender Fee evidence is received electronically along with the bids. However for the purpose of realization of Demand Draft bidders shall send them in original through RPAD/Speed Post /Reg.A.D. so as they reach to the office of Executive Engineers -Building Dept., Bhavnagar Municipal Corporation, Bhavnagar during office hours Up to Dt . 02/01/2025. Penetrative action shall be imposed for not submitting the supporting documents in original to E.E. by bidder. All the successful bids, if possible, will be physical document opened on 03/1/2025, 17.00 Hrs. in presence of tender committee at the City Engineer's Office, Commercial stage will be opened after approved this tender document Bhavnagar Municipal Corporation, Bhavnagar. FDR FOR EMD OR SD, OR BANK GAURANTEE issued by State bank of India will not be accepted</p>
General Terms & Conditions	<p>:- Bidders who wish to participate in this E-Tender will have to procure valid digital certificate as per information Technology Act 2000. Bidders can procure this certificate from any of the Government approved certifying agency i.e. (n) Code Solution.</p> <p>DOWNLOAD OF TENDER DOCUMENT:-</p> <p>The tender document for these work are available only in digital format which can be downloaded free of cost by the bidder.</p> <p>SUBMISSION OF TENDER:-</p> <p>Tenderer shall submit their offer in Electronic format on above mentioned website on or before the scheduled date and time as mentioned, after Digitally Signing the same.</p> <p>Bidders shall upload the tender documents after submitting the DD details for tender fees and EMD in form of DD/Bank Guaranteed details online. The Demand</p>
	<p>Draft toward Tender Document fees can be submitted along with Earnest Money Deposit before the due date as specified above. This should be as per details given online and it should be drawn before the last date of the uploading of the tender.</p> <p>The intending bidders shall have to submit the following documents in Physical form along with the EMD and tender fees.</p> <ul style="list-style-type: none"> (a) Documents required for evaluation as sought in different annexure duly digitally signed. (b) Power of attorney. (c) Company's profile and certificate of Registration of company under the law. <p>The Bidder should submit price Bid digitally only. <u>Price bid in physical form shall Not be accepted</u> and any such offer if received by Bhavnagar Municipal Corporation same will be outrightly rejected.</p> <p>Technical bid in physical form is not required to be submitted by all bidders. However, non submission of technical bid does not absolve bidders from and liability of the tender. Only successful bidders have to submit the technical bid duly signed in physical form upon intimation from BMC</p>

		<p>OPENING OF TENDER:-</p> <p>The Technical Bid will be opened on the specified date online on website https://tender.nprocure.com Bidders or their representative who wish to participate in online tender opening can log on to https://tender.nprocure.com on the due date and time, mark their presence and participate in online tender opening. Bidders who wish to remain present at Bhavnagar Municipal Corporation, Only one representative of each firm will be allowed to remain present.</p>
Information for online participation		<ol style="list-style-type: none"> 1. Internet site address for e-Tendering activities will be https://tender.nprocure.com 2. Interested bidders can view detailed tender notice and download tender documents from the above mentioned website. 3. Bidders who wish to participate in online tender have to register with the website through the “New User Registration” link provided on the home page. Bidder will create login id & password on their own in registration process. 4. Bidders who wish to participate in this tender need to procure Digital Certificate as per Information Technology Act-2000 using that they can digitally sign their electronic bids. Bidders can procure the same from any of the CCA approved certifying agencies, or they may contact (n) code Solution at below mentioned address and they will assist them in procuring the same. Bidders who already have a valid Digital Certificate need not to procure the same. In case bidders need any clarification regarding online participation, they can contact M/S (n) code Solution 301, G.N.F.C. Info Tower, Near Grant Bhagwati Hotel, Ahmedabad 380 015, India. Tel: +91 79 2685 7316 Tel: +91 79 2685 7317 Tel: +91 79 2685 7318 E-Mail: URL: https://tender.nprocure.com
		<ol style="list-style-type: none"> 5. Bidders who wish to participate in e-Tender need to fill data in predefined forms of tender fee, EMD, PQ (Technical) or experienced details and Price bid only. 6. Bidders should upload scan copies of referenced documents in support of their eligibility of the bid. 7. After filling data in predefined forms bidders need to click on final submission link to submit their encrypted bid. Bidder can also submit Document Fees, EMD, Technical bid document & Reference Documents in hard copy if such instructions are given by tendering authority.
Officer Inviting Bids	:-	Executive Engineer, Building Department, Bhavnagar Municipal Corporation, Bhavnagar.
Bid Opening Authority Members in committee	:-	(1) O.S. D/ City Engineer (2) Executive Engineer (Building Department.) (3) Chief Accountant (4) Chief Auditor
Address	:-	Building Department, Municipal Corporation, Sir Mangal Singhji Road, Bhavnagar.

Contact Person	:-	For further details of any query regarding the tender Contact to: Executive Engineer (Building Department), Bhavnagar Municipal Corporation., Sir Mangalsinhji Road, Bhavnagar-364001 Mobile no. 8128207404 E-mail address: building.bmcgujarat@gmail.com
-----------------------	-----------	---

Date : __/__/2024
Place:-
Bhavnagar

Executive Engineer
Building Department
Bhavnagar Municipal Corporation

STANDARD BIDDING DOCUMENT PROCUREMENT OF BUILDING WORKS

COMPLETE BIDDING DOCUMENT

BHAVNAGAR MUNICIPAL CORPORATION
BUILDING DEPARTMENT

Name Of Work :-CONSTRUCTION OF NEW PHC IN THE AREA OF BHAVNAGAR
CITY, **KUMBHARWADA**, BHAVNAGAR



BHAVNAGAR MUNICIPAL CORPORATION
BUILDING DEPARTMENT
BHAVNAGAR

Index

<u>Sr No</u>	<u>Section</u>	<u>Description</u>	<u>Page No</u>
1		Invitation for Bid (IFB)	3
2	Section -1	Instructions to Bidders	7
3	Section -2	Qualification Information	30
4	Section -3	Conditions of Contract	43
5	Section -4	Contract Data	71
6	Section -5	Technical Specification	83
7	Section -6	Form of Bid	84
8	Section -7	Bill of Quantities	87
9	Section -8	Securities and Other Forms	99
10	Section -9	Drawings	102
11	Section -10	Documents to be furnished by Bidder	103

**INVITATION FOR BID
(IFB)**

NATIONAL COMPETITIVE BIDDING-EPC BID

- The Executive Engineer, Building Department, Bhavnagar Municipal Corporation, Bhavnagar invites bids for the construction of works detailed in the table. The bidders may submit bids for any or all of the following works.

TABLE

Package No.	Name of work	Estimated Cost of Works (Rs.)	Bid Security (EMD) (Rs.)	Cost of Document (Tender Fee)	Period of completion	Class of Registration of Contractors & Special Category Building
1	2	3	4	5	6	7
1	CONSTRUCTION OF NEW PHC IN THE AREA OF BHAVNAGAR CITY, KUMBHARWADA, BHAVNAGAR	Rs. 3,10,17,210.00 (Without GST)	Rs. 3,10,200.00 DD or FDR (except SBI) only	Rs. 6000/- + 1080/- (18% GST) = 7080/-	24 (Twenty four) Months	"A" Class & Sp. Cat.-II (Bldg).

- Prospective / Interested bidder may download the Bid Documents from **Dt. As per NIT till 00:00 Hours** website <https://www.tender.nprocure.com> free of cost till the Time and Date as mentioned on online NIT at website <https://www.tender.nprocure.com>.
- However, Bidder who is submitting the Bid Online will have to pay the Bid Document Fee / Tender Fee through Demand Draft only of any Schedule Bank payable **at Bhavnagar and in favor of Commissioner, Bhavnagar Municipal Corporation.** Once the Bid is received online, Bid Document / Tender Fee will not be refundable.

The Demand Draft for Bid Document / Tender fee and FDR / Bank Guarantee against Bid Security / EMD shall be submitted in electronic format through online (by scanning) while uploading the bid, this submission shall mean that bid document / tender fee and Bid Security / EMD has been received. Accordingly, the offer of only those shall be opened whose Bid Document / Tender Fee and Bid Security / EMD have been received electronically. However, for the purpose of realization of Demand Draft, and FDR / Bank Guarantee bidder shall send the same in original through R.P.A.D. so as to reach to **Executive Engineer, Building Dept. Bhavnagar Municipal Corporation (BMC), Bhavnagar**, within stipulated time as per tender NIT.

Penalitive action for not submitting Demand Draft / FDR / Bank Guarantee in original to **Executive Engineer** / Tender Inviting Authority, BMC by bidder shall be initiated.

- Bids received online, will be opened on the time, date and place as specified in the online NIT at website <https://www.tender.nprocure.com> in the presence of the bidders or their authorized representatives, who wish to remain present. If the office happens to be closed on the day of opening of the bids as specified, the bids will be opened on the next working day at the same time and venue.

- A pre bid meeting will be held on **Dt. As per NIT...hrs.** at the office of **Executive**

Engineer, Building Dept.(BMC) at Bhavnagar to clarify the issues and to answer questions on any matter that may be raised at that stage as stated in clause 9.2 of 'instructions to Bidders' of the bidding documents.

6. Bid Security (EMD) is equal to 1% i.e. **3,10,200.00** of Estimated Amount put to bid / tender and should be rounded off to the next thousand rupees.
7. Other Information is as under:
 - A. Agencies can prepare and edit their offers a number of times before the end of the tender submission date and time. After the tender submission date and time, the bidder cannot modify / edit / withdraw their submitted offer in any case. No written or online request in this regard shall be granted.
 - B. Offers in physical form will not be accepted in any case.
 - C. Demand Draft purchased by the other than bidder and issued after the last date of submission of Bids, will not be considered or accepted.
 - D. The cost incurred by the contractor for this offer for clarification or attending discussion, conferences or site visits will not be reimbursed by the Employer or Engineer-in-Charge.
 - E. Conditional tender shall not be accepted.
 - F. Any changes, addition, alternation made in the prescribed form attached with tender are liable to be rejected.
 - G. Any change in format or conditional Bank Guarantee will not be accepted and the bidder will be considered non-responsive.
 - H. All the bidders are instructed to fill in information strictly in accordance with the format given in the checklist / qualification document / tender document.
 - I. It is mandatory for the bidders to supply each and every information as asked strictly in electronic format at appropriate places only.
 - J. Blank / insufficient information shall be treated as nil information and shall result in disqualification.
 - K. Even if the bidder has been qualified in a similar or larger size of project in the past, it shall not be deemed to be a ground / reason for not giving required information for this work / bid.
 - L. Information supplied for earlier projects shall not be considered while evaluation of this bid. The Government will not ask for any other information, unless it is found absolutely necessary by the competent authority.
 - M. If found necessary, the contractor will be intimated for negotiation,

For the works costing up to 7.5 crore (ROAD), 7.0 crore (BUILDING & BRIDGE) kindly refer to SSR-10-2015-17-C dated 03-02-2017

For the works costing under 7.5 crore for Road Works and 7.0 crore for Building and Bridge Works following documents shall be submitted in electronic format only through online by scanning and the (i) Bid Document Fee / Tender Fee (ii) Bid Security / EMD should be sent in original to the Tender opening authority through RPAD, so as to reach the Executive Engineer within 7 days from last day of submission of Bid.

- (i) Bid Document Fee / Tender Fee **(From Bidders A/C Only)**
- (ii) Bid Security / EMD or Valid EMD Exemption Certificate of Appropriate Class of Registration of Approved Contractors

- (iii) Registration Certificate "A" Class & Sp.Cat.-II(Bldg).
- (iv) Registration Certificate of Special Category - Building and Category I/II/III
- (v) GST Number & PAN Number
- (vi) Solvency Certificate (for current calendar year)
- (vii) A solvency certificate of an Amount of 20% (Twenty Percent) of estimated cost put to tender will have to be produced along with tender. It shall be of Scheduled Bank or Nationalized Bank or Bank Approved for Government business. Solvency Certificate shall have validity of same calendar year as that of date in which tender is issued.
- (viii) Successful Experience Work Completion Form 3A
- (ix) Anti-Blacklisting Affidavit with notarized (On non-judicial Stamp Paper of Rs.300, as per Annexure-7)
- (x) Turnover of Last five year i.e. 2019-20 to 2023-24
- (xi) EPF Registration Number & ESIC Registration Number
- (xii) Bid Capacity
- (xiii) Litigation History

SECTION - 1
INSTRUCTIONS TO BIDDERS
(ITB)

Section 1: Instructions to Bidders

Table of Clauses

	Page No.		Page No.
A. General		D. Submission of Bids	
1. Scope of Bid	9	19. Deleted	20
2. Source of Funds	9	20. Deadline for Submission of Bids	20
3. Eligible Bidders	9	21. Deleted	20
4. Qualification of the Bidder	9	22. Modification and Withdrawal of Bids	20
5. One Bid per Bidder	14		
6. Cost of Bidding	14	E. Bid Opening and Evaluation	
7. Site Visit	14	23. Bid Opening	21
8. Bidders Registration Class & Bldg. Category	14	24. Process to be Confidential	22
B. Bidding Documents		25. Clarification of Financial Bids	22
9. Content of Bidding Documents	15	26. Examination of Bids and Determination of Responsiveness	22
10. Clarification of Bidding Documents	15	27. Deleted	22
11. Amendment of Bidding Documents	16	28. Deleted	23
C. Preparation of Bids		29. Evaluation and Comparison of Financial Bids	23
12. Language of Bid	17	30. Deleted	23
13. Documents Comprising the Bid	17	F. Award of Contract	
14. Bid Prices	17	31. Award Criteria	24
15. Currencies of Bid and Payment	18	32. Employer's Right to Accept any Bid and to Reject any or all Bids	24
16. Bid Validity & Bid Security	18	33. Notification of Award and Signing of Agreement	24
17. Alternative Proposals By Bidders	19	34. Performance Security	24
18. Format and Signing of Bid	19	35. Advance Payment and Security	25
		36. Deleted	25
		37. Corrupt or Fraudulent Practices	25

A. GENERAL

1. Scope of Bid

- 1.1 The Executive Engineer, Building Dept. Bhavnagar Municipal Corporation (BMC), invites bids for the **Construction Of New PHC In The Area Of Bhavnagar City, Kumbharwada, Bhavnagar** detailed in the table given in IFB. The bidders may submit bids for any or all of the works detailed in the table given in IFB.
- 1.2 The successful bidder will be expected to complete the works by the intended completion date specified in the Contract data.
- 1.3 Throughout these bidding documents, the terms 'bid' and 'tender' and their derivatives (bidder/ tenderer, bid / tender, bidding/ tendering, etc.) are synonymous.

2. Source of Funds

2.1 The expenditure on this project will be met from the budget of **Health Department, Govt. of Gujarat / Govt. of India** for centrally sponsored projects.

3. Eligible Bidders

- 3.1 This Invitation for Bids is open to all eligible bidders.
- 3.2 All bidders shall provide in Section 2, Forms of Bid and Qualification Information, a statement that the Bidder is neither associated, nor has been associated, directly or indirectly, with the consultant or any other entity that has prepared the design, specifications, and other documents for the Project or being proposed as Project Manager for the Contract. A firm that has been engaged by the Employer to provide consulting services for the preparation or supervision of the works, and any of its affiliates, shall not be eligible to bid.

4. Qualification of the Bidder

- 4.1 All bidders shall provide in Section 2, Forms of Bid and Qualification Information, a preliminary description of the proposed work method and schedule, including drawings and charts, as necessary. The proposed methodology should include a program of construction backed with equipment planning and deployment duly supported with broad calculations and quality assurance procedures proposed to be adopted justifying their capability of execution and completion of work as per technical specifications, within stipulated period of completion.
- 4.2 Deleted
- 4.3 Deleted
- 4.4 Deleted

#4.5 QUALIFICATION CRITERIA:

Tenderer shall be required to submit the enlisted documents in hard copy along with the Qualification Bid. If documents are insufficient or it does not match the required criteria mentioned below, then the Price Bid of the tenderer shall not be opened.

Mainly tenderer shall fulfill following Technical & Financial pre-qualification criteria as a main contractor. The tenderer shall fulfill the following all points.

The Bidder must have achieved average annual turnover during last three financial years, ending on 31st March 2024, 30% of Estimated cost.

Mainly tenderer shall fulfill following for pre-qualification,

(a) Experience of having successfully completed "similar works" during last 05 years either of the following :

(1a) Three similar completed works, each costing not less than amount equal to 40% of the Estimated Cost.

OR

(2a) Two similar completed works, each costing not less than amount equal to 50% of the Estimated Cost.

OR

(3a) One similar completed works, each costing not less than amount equal to 80% of the Estimated Cost.

Similar work shall mean “

Successful completion of BUILDING WORK in R&B / Govt. / Semi Govt. / PSUs / Government Undertaking / Government Companies DEPARTMENT.”

E. Available Bid Capacity (ABC) - must be more than the estimated tender cost. Note: Available Bid Capacity (ABC) will be derived by the following method. ABC is calculated as $ABC = 2 * A * N - B$

Where,

A = Maximum value of works executed in any one year during the last five years (updated to present price level by applying enhancement factor) taking into account the completed as well as works in progress.

N = Number of years prescribed for completion of the works for which tenders are invited i.e. 12/12 = 1.00

B = Value of existing commitments and on-going work to be completed during that next N year (period of completion of the works for the tenders are invited.)

Note: The statements/certificate showing the value of existing commitments and ongoing works as well as the stipulated period of completion remaining for each of the works listed should be signed by the respective Employer or his authorized representative, not below the rank of an Executive Engineer or equivalent.

F. The cost of materials supplied by the Government / Clients shall not be taken into account for experience purpose.

G. An attested copy of registration with R&B etc. Registration required: “A” class & Sp. Cat. - II (Bldg). Bank Solvency of 2024-25, amounting 20% of estimated cost put to tender of any Nationalized / Scheduled Bank except Co-operative Bank.

(Applicable for the works which require Post Qualification)

4.51 Qualification will be based on Applicant's meeting all the minimum pass/ fail criteria regarding the Applicant's general and particular experience, personnel and equipment capabilities and financial positions, as demonstrated by the applicant's responses in the forms attached to the letter of application (~~specified requirement for joint ventures are given under para 4.6 below~~) Subcontractors experience and resources shall not be taken in to account in determining the applicants compliance with the qualifying criteria

To qualify for more than one contract, the applicant must demonstrate having experience and resources sufficient to meet the aggregate of the qualification criteria for each contract given in paragraphs 4.5.4, 4.5.5 and 4.5.9 below

4.52 Base year and Escalation

The base year shall be taken as Current financial year

Following enhancement factors will be used for the costs of works executed and the financial figure to a common base value for works completed in India.

<u>Year</u>	<u>Financial Year</u>	<u>Multiplying factor</u>
Base year of inviting tender	2024-2025	1.00
-1	2023-2024	1.10
-2	2022-2023	1.21
-3	2021-2022	1.33
-4	2020-2021	1.46
-5	2019-2020	1.61

Applicant should indicate actual figures of costs and amount for the works executed by them without accounting for the above-mentioned factors.

In case the financial figures and value of completed works are in foreign currency the above enhanced multiplying factors will not be applied. Instead, the current market exchange rate (State Bank of India BC Selling rate as on the last date of submission of the bid) will be applied for the purpose of conversion of the amount in foreign currency into India rupees.

4.5.3. General Experience.

The Applicant shall meet with the following minimum criteria:

(a) **Annual Turn Over**

Achieved a minimum annual financial turnover (defined as billing for works in progress and completed in all classes of civil engineering construction works only) in any one year, over the last five years of the annual value of contract / contracts applied for.

**Annual Turn Over shall be more than 30 % of project cost (i.e. X)
(for guidance of deriving X the value of X shall be derived by dividing amount put to tender by the time limit expressed in years for the project / work.)**

~~Joint Venture: Lead Partner & Second another Partner only (i.e. 1 (Lead Partner) + 1 (Other Partner))~~

~~For Joint Venture: The Lead Partner must have updated annual turnover not less than Rs. 153.70 Lacs. (51% of X) & remaining Partner must have updated annual turnover not less than Rs. 90.41 Lacs. (30% of X).~~

~~The Joint Venture must collectively have updated annual turnover not less than Rs. 301.38 Lacs. (i.e. X)~~

4.5.4. Personnel Capabilities.

Availability for his work of personnel with adequate experience as required; as per Appendix.

4.5.5. Equipment Capabilities

Based on the studies carried out by the Engineer, the minimum suggested major equipment to attain the completion of works in accordance with the prescribed construction schedule are shown in the Appendix.

The bidders should, however, undertake their own studies and furnish with their bid, a detailed construction planning and methodology supported with layout and necessary drawings and calculations to allow the employer to review their proposals. The numbers, types and capacities of each plant/equipment shall be shown in the proposals along with the cycle time for each operation for the given production capacity to match the requirements.

4.5.6. Financial Position

The Applicant should give undertaking that he has access to, or has available, liquid assets (aggregate of working capital, cash in hand and uncommitted bank guarantees) and / or credit facilities up to **25 percent of the value of the contract / contracts applied.**

4.5.7. The audited balance sheets for the last five years should be submitted, which must demonstrate the soundness of the applicant's financial position, showing long – term profitability including an estimated financial projection for the next two years, if necessary, the employer will make inquiries with the applicant's bankers.

4.5.8. Litigation History

The Applicant should provide accurate information on any litigation or arbitration resulting from contracts completed or under execution by him over the last five years. A consistent history of awards against the Applicant or any partner of a joint venture may result in failure of the applicant.

4.5.9. Disqualification

Even though the applicants meet the above criteria, they are subject to be disqualified if they have:

Made misleading or false representation in the forms, statements submitted, and / or Record of poor performance such as abandoning the work, rescinding of contract for which the reasons are attributable to the non – performance of the contractor; consistent history of litigation awarded against the applicant or financial failure due to bankruptcy. ~~The rescinding of contract of a joint venture on account of reasons other than non – performance, such as Most Experienced partner of joint venture pulling out, court directions leading to breaking up of a joint venture before the start of work, which are not attributable to the poor performance of the contractor will, however, not affect the qualification of the individual partners.~~

**#4.6 JOINT VENTURE: (Maximum 2 Members i.e. 1 Lead & 1 Others)
(Applicable only for estimated project cost of 50 Crore and above)**

4.6.1.— Joint ventures must comply with the following requirement:

(a) — Following are the minimum qualification requirements:

(i) — The lead partner shall meet not less than 51 percent of all criteria given in para 4.5.3 (a) Annual Turn Over 4.5.3 (b) Successful Experience V-I & 4.5.6 above. The joint venture must collectively satisfy the criteria of para 4.5.3 & 4.5.6 above. The experience of the other joint venture partners shall be considered if it is not less than 30 percent of the qualifying criteria in para 4.5.3 & 4.5.6 above.

(ii) — Individually each member must satisfy the requirements of para 4.5.3(a), 4.5.3.(b), 4.5.7, 4.5.8 above and 4.7 below.

(b) — Bid shall be signed so as to legally bind all partners, jointly and severally, and shall be submitted with a copy of the joint venture agreement providing the joint and several liabilities with respect to the contract.

4.6.2. Qualification of a joint venture does not necessarily qualify any of its partners individually or as a partner in any other joint venture. In case dissolution of a joint venture, each one of the constituent firms may qualify if they meet all the qualification requirements, subject to the written approval of the Employer.

4.7. Bid Capacity.

Applicants who meet the minimum qualification criteria will be qualified only if their available bid capacity at the expected time of bidding is more than the total estimated cost of the works. The available bid capacity will be calculated as under:

Assessed Available Bid Capacity = (A*N*2-B), where

A = Maximum value of work executed in any one year during the last five financial years i.e. from 2019-20 to 2023-24 (updated to the price level of the year indicated in appendix) taking into account the completed as well as works in Progress.

B = Value at current price level of the existing commitments and ongoing works to be completed during the next 24 Months (period of completion of work for which bids are invited); and

N = Number of years prescribed for completion of the works for which the bids are invited.

Note :- In Case of joint venture, the available bid capacity will be applied for each partner to the extent of his proposed participation in the execution of the work. Some of the bid capacity of all the member shall be more than 4.7.

4.8 Even though the bidders meet the above qualifying criteria, they are subject to be disqualified if they have:

- Made misleading or false representation in the forms, statements and Attachments the submitted in proof the qualification requirements; and /or
- Record of poor performance such as abandoning the works, not properly completing the contract, inordinate delay in completion, litigation history, or financial failures etc.; and/or
- Participated in the previous bidding for the same work and had quoted unreasonably high bid prices and could not furnish rational justification to the employer.

5. One bid per bidder

5.1. Each bidder shall submit only one bid for one package. A bidder who submits or participates in more than one bid (other than as a subcontractor or in cases of alternatives that have been permitted or requested) will cause all the proposals with the bidder's participation to be disqualified.

6. Cost of Bidding

6.1. The bidder shall bear all costs associated with the preparation and submission of his Bid, and the Employer will in no case be responsible and liable for those costs.

7. Site Visit

7.1. The Bidder, at the Bidder's own responsibility and risk is encouraged to visit and examine the Site of work and its surrounding and obtain all information that may be necessary for preparing the Bid and entering into a contract for construction of the Works.

The costs of visiting the site shall be at the Bidder's own expense.

8. Bidders Registration Class and Building Category

8.1. Registration certificate of R & B Registered in "A" Class & Sp. Cat.-III (Bldg). / Water Resources Department, The contractors, who are registered in appropriate category of C.P.W.D., M.E.S., Railways and Indian State Governments, can also bid provided the bidder produce such registration certificate at the time of bidding and obtain and submit registration in required class & category from the **BUILDINGWORK in R&B /Govt. /Semi Govt. / PSUs / Government Undertaking / Government Companies DEPARTMENT."**

before issue of work order in case they emerge as L-1 Bidder. Bidder will solely be responsible for obtaining and submitting the certificate before issue of work order.

B. BIDDING DOCUMENTS

9. Content of Bidding Documents

9.1 The set of bidding documents comprises the documents listed below and addenda issued in accordance with Clause 10:

Section	Particulars	Volume No.
-	Invitation for Bids	I
1	Instructions to Bidders	
2	Qualification Information, and other forms	
3	Conditions of Contract	
4	Contract Data	
5	Technical Specifications	II
6	Form of Bid	III
7	Bill of Quantities	
8	Securities and other forms	
9	Drawings	IV
10	Documents to be furnished by bidder	V

9.2 Volumes I, II, III and IV are available online and documents to be furnished by the bidder in compliance to section 2 will be prepared by him and furnished as Volume- V in two parts (refer clause 12).

9.3 The bidder is expected to examine carefully all instructions, conditions of contract, contract data, forms, terms, technical specifications, bill of quantities, forms, Annexes and drawings in the Bid Document. Failure to comply with the requirements of Bid Documents shall be at the bidder's own risk. **Pursuant to clause 26 hereof**, bids which are not substantially responsive to the requirements of the Bid Documents shall be rejected.

10. Clarification Bidding Documents

10.1 A prospective bidder requiring any clarification of the bidding documents may notify the Employer in writing or through E-mail at the Employer's address indicated in the invitation to bid. The Employer will respond to any request for clarification which he received earlier than 15 days prior to the deadline for submission of bids. Employer's response will be published on website including a description of the enquiry but without identifying its source.

10.2 Pre-bid meeting

10.2.1. The bidder or his official representative is invited to attend a pre-bid meeting which will take place at the address, venue, time and date as indicated in the NIT.

- 10.2.2. The purpose of the meeting will be to clarify issues and to answer questions on any matter that may be raised at that stage.
- 10.2.3. The bidder shall be required to submit any questions in writing or e-mail to reach the Employer not later than 03 days before the meeting.
- 10.2.4. Minutes of the meeting, including the question raised (Without identifying the source of enquiry) and the responses given will be published without delay on the tender website i.e. www.tender.nprocure.com. Any modification of the bidding documents listed in sub-Clause 8.1 which may become necessary as a result of the pre-bid meeting shall be made by the Employer exclusively through the issue of an Addendum pursuant to Clause 10 and not through the minutes of the pre-bid meeting.
- 10.2.5. Non-attendance at the pre-bid meeting will not be a cause for disqualification of a bidder.

11. Amendment of Bidding Documents

- 11.1. Before the deadline for submission of bids, the Employer may modify the bidding documents by issuing addenda.
- 11.2. Any addendum thus issued shall be part of the bidding documents. The Employer will assume no responsibility for the same.
- 11.3. To give prospective bidders reasonable time in which to take an addendum into account in preparing their bids, the Employer may, at his discretion, extend as necessary the deadline for submission of bids, in accordance with Sub-Clause 20.2 below.

C. PREPARATION OF BIDS

12. Language of the Bid

12.1 All documents relating to the bid shall be in the English language.

13. Documents Comprising the Bid

13.1. The bid to be submitted by the bidder as Volume V of the bid document (refer Clause 8.1) shall be in two separate parts:

Part I shall be named "Technical Bid" and shall comprise

- (i) Bid Security in the form specified in Section 8
- (ii) Qualification Information and supporting documents as specified in Section 2
- (iii) Certificates, undertakings, affidavits as specified in Section 2
- (iv) Any other information pursuant to Clause 4.5 of these instructions
- (v) Undertaking that the bid shall remain valid for the period specified in Clause 15.1

Part II shall be named "Financial Bid" and shall comprise

- (i) Form of Bid as specified in Section 6
- (ii) Priced Bill of Quantities for items specified in Section 7

13.2. The Bidder shall submit the details / information pertaining to each part i.e. technical as well as financial and must be submitted online only.

13.3. Following documents will be deemed to be part of the bid.

Section	Particulars	Volume No.
Invitation for Bids (IFB)		
1	Instruction to Bidders	Volume I
3	Conditions of Contract	
4	Contract Data	
5	Specifications	Volume II
9	Drawings	Volume IV

14. Bid Prices

14.1 The Contract shall be for the whole works as described in Sub-Clause 1.1, based on the priced Bill of Quantities submitted by the Bidder.

14.2 The bidder shall fill in rates and prices and line item total (both in figures and words) for all items of the Works described in the Bill of Quantities along with total bid price

(Both in figures and words). Items for which no rate or price is entered by the bidder will not be paid for by the Bill of Quantities.

14.3 All duties, taxes, and other levies **except GST** payable by the contractor under the contract, or for any other cause shall be included in the rates, prices and total Bid Price submitted by the Bidder. **(GST will be paid extra)**

14.4 Deleted

14.5 The rates and prices quoted by the bidder are subject to adjustment during the performance of the Contract in accordance with the provisions of Clause 47 of the Condition of Contract **(Irrespective of the time limit and Bid Amount)**

15. Currencies of Bid and Payment

15.1 The unit rates and the prices quoted by the bidder shall be entirely in Indian Rupees. All payments shall be made in Indian Rupees.

16. Bid Validity

16.1 Bids shall remain valid for a period of **not less than 180** days from the date of technical bid opened.

16.2 In exceptional circumstances, prior to expiry of the original time limit, the Employer may request that the bidders may extend the period of validity for a specified period. A bidder may refuse the request without forfeiting his bid security. A bidder agreeing to the request will not be required or permitted to modify his bid, but will be required to extend the validity of his security for a period of the extension, and in compliance with Clause 16 in all respects.

#16. Bid Security

16.1. The Bidder shall furnish, as part of his Bid, a Bid security in the amount as shown in column 4 of the table of IFB for this particular work. This Bid security shall be in favor of Employer as named in Appendix and may be in one of the following forms;

a. Bank Guarantee from any scheduled Indian bank, in the format given in Volume III. **(Bank Guarantee is applicable only for Bid Estimated Amount of 01 Crore and above) and Bank** Guarantee of Schedule and Private Banks shall be considered as per GoG Finance Department's Circular No. FD/MSM/e-file/4/2023/0057/D.M.O. Date 21/04/2023 or as per their latest amendment.

b. Fixed Deposit Receipt issued by any Scheduled Indian Bank or a foreign Bank approved by the Reserve Bank of India.

OR

A Valid Bid Security / EMD Exemption Certificate issued by (1) Road & Building Department or (2) Narmada Water Resources, Water Supply and Kalpsar Department of Govt of Gujarat. **Exemption Certificate is applicable only when Registration Certificate of Appropriate Class and Category of Approved Contractors is required as eligible criteria of bidder.**

- 16.2. Bank guarantees (and other instruments having fixed validity) issued as surety for the bid shall be valid for 45 days beyond the validity of the bid. i.e. total validity of $180+45=225$ Days
- 16.3. Any bid not accompanied by an acceptable Bid Security and not secured as indicated in Sub-Clauses 16.1 and 16.2 above shall be rejected by the Employer as non-responsive.
- 16.4. The Bid Security of unsuccessful bidders will be returned within 28 days of the end of the bid validity period specified in Sub-Clause 15.1
- 16.5. The Bid Security of the successful bidder will be discharged when the bidder has signed the Agreement and furnished the required Performance Security.
- 16.6. The bid Security may be forfeited
- (a) If the Bidder withdraws the bid after Bid opening during the period of Bid validity.
 - (b) If the Bidder does not accept the correction of the Bid Price, if any
 - (c) In the case of a successful Bidders, if the Bidder fails the specified time limit to
 - (i) Sign the Agreement; or
 - (ii) Furnish the requirement Performance Security.
 - (d) #If found necessary, the bidder will be intimated for negotiation, He will be intimated maximum three times within the validity period for negotiation, If contractor does not respond in time, his Bid Security (EMD) will be forfeited and his tender will be rejected. Punitive action will be taken on such contractors. (As per GoG R&B Dept's Gr. No. S/22/2017/6369/D, Dt.08/06/2018)

17. Alternative Proposals by Bidders.

- 17.1. Bidders shall submit offers that fully comply with the requirements of the bidding documents, including the conditions of contract (including mobilization advance or time for completion), basic technical design as indicated in the drawing and specifications. Conditional offers or alternative offers will not be considered further in the process of tender evaluation.

18. Format and Signing of Bid

- 18.1. The Bidder shall prepare documents comprising the bid as described in Clause 12 of these Instructions to bidder as the "Technical Bid" and "Financial Bid" in separate parts to be uploaded.

D. SUBMISSION OF BIDS

19. Deleted

20. **Deadline for Submission of the Bids**

20.1. Complete Bids must be received online by the Employer at the tender website specified above not later than the date indicated in appendix.

20.2. The Employer may extend the deadline for submission of bids by issuing an amendment in accordance with Clause 10, in which case all right and obligation of the Employer and the bidders previously subject to the original deadline will then be subject to the new deadline.

21. Deleted

22. **Modification and Withdrawal of Bids**

22.1. Bidders may modify or withdraw their bids online before the deadline prescribed in Clause 20 or pursuant to Clause 23.

22.2. Deleted

22.3. No bid shall be modified or withdrawn after the deadline for submission of Bid.

22.4. Withdrawal or modification of a bid between the deadline for submission of bids and the expiration of the original period of bid validity specified in Clause 15.1 above or as extended pursuant to Clause 15.2 may result in the forfeiture of the Bid security pursuant to Clause 16.

E. BID OPENING AND EVALUATION

23. Bid Opening

- 23.1. The Employer will open all the Bids received including modifications made pursuant to Clause 22, in the presence of the Bidders or their representatives who choose to attend at time, date and the place specified in Appendix in the manner specified in Clauses 20 and 23.3, In the event of the specified date of Bid opening being declared a holiday for the Employer, the Bids will be opened at the appointed time and location on the next workingday.
- 23.2. Deleted.
- 23.3. The "Technical Bid" shall be opened. The amount, form and validity of the bid security furnished with each bid will be announced. If the bid security furnished does not conform to the amount and validity period as specified in the invitation for bid (ref. Column 4 and paragraph 3), and has not been furnished in the form specified in Clause 16, the technical bid will not be opened.
- 23.4. (i) Subject to confirmation of the bid security by the issuing Bank, the bids accompanied with valid bid security will be taken up for evaluation with respect to the Qualification information and other information furnished in part I of the bid pursuant to Clause 12.1.
- (ii) If required, the bidder will be asked in writing to clarify his Qualification Documents with respect to any required clarification.
- (iii) The bidders will respond in not more than 7 days of issue of the clarification letter.
- (iv) Immediately (usually within 3 or 4 days), on receipt of these clarification the Evaluation Committee will finalize the list of responsive bidders whose financial bids are eligible for consideration.
- 23.5. Deleted
- 23.6. At the time of opening of "Financial Bid", the names of the bidders were found responsive in accordance with Clause 23.4(iv) will be announced. The bids of only these bidders will be opened. The responsive Bidders' names, the Bid prices, the total amount of each bid, any discount and such other details as the Employer may consider appropriate, will be announced by the Employer at the opening.
- 23.7. the time of opening of "Financial Bid", the names of the bidders were found responsive in accordance with Clause 23.4(iv) will be announced. The bids of only these bidders will be opened. The responsive Bidders' names, the Bid prices, the total amount of each bid, any discount, and such other details as the Employer may consider appropriate, will be announced by the Employer at the opening.
- 23.8. In case bids are invited for more than one package, the order for opening of the "Financial Bid" shall be in order of Estimated amount of Bids from highest to lowest.
- 23.9. The Employer shall prepare minutes of the Bid opening, including the information disclosed to those present in accordance with Sub-Clause 23.6.

24 Process to be Confidential

24.1 Information relating to the examination, clarification, evaluation, and comparison of Bids and recommendations for the award of a contract shall not be disclosed to Bidders or any other persons not officially concerned with such process until the award to the successful Bidder has been announced. Any effort by Bidder to influence the Employer's processing of Bids or award decisions may result in the rejection of his Bid.

25. Clarification of Financial Bids

25.1. To assist in the examination, evaluation, and comparison of Bids, the Employer may, at his discretion, ask any Bidder for clarification of his Bid, including breakdowns of unit rates. The request for clarification and the response shall be in writing or by e-mail, but no change in the price or substances of the Bid shall be sought, offered, or permitted except as required to confirm the correction of arithmetic errors discovered by the Employer in the evaluation of the Bids.

25.2 Subject to sub-clause 25.1, no Bidder shall contact the Employer on any matter relating to his Bid opening to the contract is awarded. If the Bidder wishes to bring additional information to the notice of the Employer, it should do so in writing.

25.3. Any effort by the Bidder to influence the Employer in the Employer's bid evaluation, bid comparison or contract award decision may result in the rejection of the Bidders' bid.

26. Examinations of Bids and Determination of Responsiveness

26.1 During the detail evaluation of "Technical Bid", the Employer will determine whether each Bid (a) meets the eligibility criteria defined in Clause 3 and 4; (b) has been properly signed; (c) is accompanied by the required securities and; (d) is substantially responsive to the requirements of the Bidding document. During the detailed evaluation of the "Financial Bid", the responsiveness of the bids will be further determined with respect to the remaining bid conditions, i.e., priced bill of quantities, technical specifications, and drawings.

26.2 A substantially responsive "Financial Bid" is one which confirms all the terms, conditions and specifications of bidding documents, without material deviation or reservation. A material deviation or reservation is one (a) which affects in any substantial way the scope, quality, or performance of the Works; (b) which limits in any substantial way, inconsistent with the Bidding documents, the Employer's rights or the Bidder's obligations under the Contract; or (c) whose rectification would affect unfairly the competitive position of other Bidders presenting substantially responsive Bids.

26.3 If a "Financial Bid" is not substantially responsive, it will be rejected by the Employer, and may not subsequently be made responsive by correction or withdrawal of the non-conforming deviation or reservation.

27. Deleted

28. Deleted

29. Evaluation and Comparison of Financial Bids

- 29.1. The Employer will evaluate and compare only the Bids determined to be substantially responsive in accordance with Sub-Clause 26.2.
- 29.2. Deleted.
- 29.3. The Employer reserves the right to accept or reject any variation or deviation. Variation and deviations and other factors, which are in excess of the requirements of the Bidding documents or otherwise result in unsolicited benefits for the Employer, shall not be taken in to account in Bid evaluation.
- 29.4. The estimated effect of the price adjustment conditions under Clause 47 of the Conditions of Contract, during the period of implementation of the Contract, will not be taken in to account in Bid evaluation.
- 29.5. If the Bid of the successful Bidder is seriously unbalanced in relation to the Engineer's estimate of the cost of work to be performed under the contract the Employer may require the Bidder to produce detailed consistency of those prices with the construction methods and schedule proposed. After evaluation of the price analyses, the Employer may require that the amount of the performance security set forth in Clause 34 be increased at the expense of the successful /bidder to a level sufficient to protect the Employer against financial loss in the event of default of the successful Bidder under the Contract.
- 29.6. A bid which contains several items in the bill of Quantities which are unrealistically priced low and which cannot be substantiated satisfactorily by the bidder may be rejected as non-responsive. (Applicable for item rate tender only)

30. Deleted

F. AWARD OF CONTRACT

31. Award Criteria

31.1. Subject to Clause 32, the Employer will award the contract to the Bidder whose Bid has been determined.

- (i) to be substantially responsive to the Bidding documents and who has offered the lowest evaluated Bid Price; and
- (ii) to be within the available bid capacity adjusted to account for his bid price which is the lowest evaluation in any of the packages opened earlier than the one consideration.

In no case, the contract shall be awarded to any bidder whose available bid capacity is less than the evaluated bid price, even if the said bid is the lowest evaluated bid. The contract will in such cases be awarded to the next lowest bidder at his evaluation bid price.

32. Employer's Right to Accept any Bid and to Reject any or all Bids

32.1. Notwithstanding Clause 31, the Employer reserves the right to accept or reject any Bid, and to cancel the Bidding process and reject all Bids, at any time prior to the award of contract, without thereby incurring any liability to the affected bidder or Bidder or any obligation to inform the affected Bidder or Bidders of the grounds for the Employer's action.

33. Notification of Award and Signing of Agreement

33.1. The Bidder whose Bid has been accepted will be notified of the award by the Employer prior to expiration of the Bid validity period by cable, telex or facsimile confirmed by registered letter. This letter (hereinafter and in the condition of contract called the "Letter of Acceptance") will state the sum that the Employer will pay the Contractor in consideration of the execution, completion, and maintenance of the Works by the Contractor as prescribed by the Contract (hereinafter and in the Contract called the "Contract Price").

33.2 The notification of award will constitute the formation of the contract, subject only to the furnishing of a performance security in accordance with the provisions of Clause.

33.3. The Agreement will incorporate all agreements between the Employer and the successful Bidder. It will be signed by the Employer and to the successful Bidder, within 28 days following the notification of award along with the Letter of Acceptance. Within 21 days of receipt, the successful Bidder will sign the Agreement and deliver it to the Employer.

33.4. Upon the furnishing by the successful Bidder of the Performance Security, the Employer will promptly notify the other Bidders that their Bids have been unsuccessful.

34. Security Deposit

(Total 5.0% of contract value, This will be deposited as under)

Initial S.D. @ 2.50% of contract value 2.50% of contract value

(Not less than EMD) in cash or in the

In the form of pay order/DD/FDR/Bank

Guarantee (From the Nationalized Bank

Encashable at BHAVNAGAR Only)

To be deducted from current bill at: 2.50% of contract value
10.00% to buildup remaining 2.50%
Of SD value

Total deposite at 5.00% of contract 5.00% of contract value
Value

B. Performance Gurantee

Performance Gurantee @5.00% of actual work amount in form of F.D.R. of Nationalized or Scheduled bank / N.S.C. / Narmada bond pledged in favour of Commissioner, Municipal Corporation, Bhavnagar. (To be submitted on completion of work & before final payment) Performance gurantee will be released after defect liability period is over.

~~34 Performance Security~~

~~34.3. (A) Within 10 (Ten) days of receipt of Letter of Acceptance, the successful Bidder shall furnish to the Employer an irrevocable and unconditional guarantee from a Bank in the form set forth in Section 8 (the "Performance Security") for an amount equal to 5% (five percent) of its Contract Price. In case of bids mentioned below, the successful Bidder, along with the Performance Security, shall also furnish to the Authority an irrevocable and unconditional guarantee from a Bank in the same form given at Section 8 towards an Additional Performance Security (The "Additional Performance Security") for an amount calculated as under:~~

~~(a) If the Contract Price offered by the Selected Bidder is lower than 10% but upto 20% of the Estimated Project Cost, then the Additional Performance Security shall be calculated @ 20% of the difference in the (i) Estimated Project Cost (as mentioned in Bid Document) Minus 10% of the Estimated Project Cost and (ii) Contract Price offered by the selected Bidder.~~

~~(b) If the Contract Price offered by the Selected Bidder is lower than 20% of the Estimated Project Cost, then the Additional Performance Security shall be calculated @ 30% of the difference in the (i) Estimated Project Cost (as mentioned in Bid Document) Minus 10% of the Estimated Project Cost and (ii) Contract Price offered by the selected Bidder.~~

~~(c) This Additional Performance Security shall be treated as part of the Performance Security.~~

~~(B) The Performance Security shall be valid beyond 60 (sixty) days of the Defects Liability Period and the Additional Performance Security shall be valid beyond 28 (twenty eight) days of Project Completion Date.~~

~~34.4. If the performance security is provided by the successful Bidder in the form of a Bank Guarantee, it shall be issued either (a) at the Bidder's option, by a Nationalized/Scheduled Indian bank or (b) by a foreign bank located in India and acceptable to the Employer. As per GoG Finance Department's Circular No. FD/MSM/e file/4/2023/0057/D.M.O. Date 21/04/2023 or as per their latest amendment.~~

~~34.5. Failure of the successful Bidder to comply with the requirement of Sub Clause 34.1 shall constitute sufficient grounds for cancellation of the award and forfeiture of the Bid Security.~~

35 Advance Payment and Security

35.1 The Employer will provide an Advance payment on the Contract Price as stipulated in the Conditions of Contract, subject to maximum amount, as stated in the Contract Data.

36. Deleted

37. Corrupt or Fraudulent Practices

37.1 The Employer will reject a proposal if it determines that the Bidder recommended for award has engaged in corrupt or fraudulent practices in completing for the contract in question and will declare the firm ineligible, either indefinitely or for a stated period of time, to be awarded a contract with National Highways Authority of India/ State PWD and any other agencies, if it at any time determines that the firm has engaged in corrupt or fraudulent practices in completing for the contractor, or in execution.

37.2 Furthermore, Bidders shall be aware of the provision stated in Sub- Clause 59.2 of the Conditions of Contract.

APPENDIX TO ITB

Clause Reference With respect to Section -I

1.	The Name of the Employer is Commissioner Shree, Bhavnagar Municipal Corporation.	[Cl.1.1]
2.	The last five/Seven years.	
	2023 – 2024	
	2022 – 2023	
	2021 – 2022	
	2020 – 2021	
	2019 – 2020 2018 – 2019 2017 – 2018	
3.	This Annual Financial Turnover Amount is Rs.	[Cl.4.5.3 (a)]
4.	Value of Work is Rs. 3,10,17,210.00 (Without GST)	
5.	Deleted	
6.	The cost of electric work is Rs. 25,17,310.87 The cost of CCTV work is Rs. 1,45,279.00	
7.	The cost of Fire safety works is Rs. 14,72,534.55	
8.	Liquid assets and / or availability of credit facilities(i.e.25%of contract value/ estimated cost) is Rs. 77.39 Lacs.	[Cl.4.5.6]
9.	Price level of the financial year 2024-25	[Cl. 4.5.2]
10.	The pre-bid meeting will take place at	[Cl. 10.2]
11.	The technical Bid will be opened at the office of the..... ondt.As per NIT	
12.	Address of the Employer: 2 nd Floor, Office of the Executive Engineer, Building Department, Sir Mangalsinhji road, Municipal Corporation Bhavnagar, Main office building, Bhavnagar 364001	
13.	Deleted	
14.	The bid should be submitted latest by As stated on online NIT	[Cl. 20.1 & 20.2]
15.	The bid will be opened at Dt. As stated on online NIT	[Cl. 23.1]
16.	The Bank Draft in favour of 'Commissioner Shree, Bhavnagar Municipal Corporation.	
17.	Deleted	
18.	Escalation factors (for the cost of works executed and financial figure to a common base value) for works completed	[Cl.4.5.2]

<u>Year</u>	<u>Financial Year</u>	<u>Multiplying factor</u>
Base year of inviting tender	2024-2025	1.00
-1	2023-2024	1.10

-2	2022-2023	1.21
-3	2021-2022	1.33
-4	2020-2021	1.46
-5	2019-2020	1.61

#LIST OF KEY PLANT & EQUIPMENT TO BE DEPLOYED ON CONTRACT WORK

[Reference CL. 4.5.5]

The contractors shall also give a list of machineries in his possession and which they propose to use on the work.

Sr. No.	Plant or Machinery	Nos.	Location	Age of Machinery (maximum 15 years)	Make	Capacity	Approximate Value	Remark
1	2(a)	2(b)	2(c)	3	4	5	6	7
1	Tipper Trucks							
2	Concrete mixer with integral way batch facility							
3	Needle Vibrator							
4	Surface Vibrator							
5	Diesel Generator							
6	Concrete Conveying System and Trolley							
7	Excavator							
8	Steel/ Wooden shuttering (Scaffolding, props)							
9	Concrete breaker							
10	Surveying Equipment (Total Station & Other)							
11	Welding machine							
12	Bar Bending and Cutting machines							
13	Goods lift for							
14	Water tanker							

List of Key Personnel to be deployed on Contract Work

(Reference Cl. 4.5.4)

Employment of a qualified site Engineer by the Contractor.

The Contractor shall employ full-time technically qualified staff during the execution of this work as under: -

1. Two graduate Civil Engineers and three diploma Civil Engineers when cost of the work to be executed is more than Rs.50 lakhs.
2. One graduate & two Diploma, Civil Engineers when the cost of the work to be executed is more than Rs.15 lakhs but less than Rs.50lakhs.
3. Minimum one Diploma Civil Engineer when the cost of work is less than Rs.15 lakhs but more than Rs.5lakhs.
4. Minimum two Diploma Civil Engineers for the work when the cost of work to be executed is less than Rs. 5 lakhs. The Engineer so employed for the Government work must have sufficient experience to handle the work independently. Such an Engineer shall have to stay at the site of work and he shall not be entrusted with other duty except thiswork.

Within 15 days of issue of work-order the Contractor will have to furnish to the Deputy Executive Engineer-in-charge of the work the Name, Qualifications, copy of marksheet, Colour Photograph and the appointment order issued such engineers engaged for this contract work. If 15 days after issue of work order such designated Site Engineers do not resume or do not remain present on site of work, the recovery at the rate of Rs.15,000-00 per month per Engineer will be made from the bills/deposit/dues of the contractor. Such recovery shall be non-refundable.

SECTION - 2
QUALIFICATION INFORMATION

QUALIFICATION INFORMATION

The information to be filled in by the Bidder in the following pages will be used for the purpose of post qualification as provided for in Clause 4 of the Instruction to Bidders. This information will not be incorporated in the Contract.

1. For Individual Bidders

1.1 Constitution or legal status of Bidder
(Attach Copy)

Place of registration _____

Principal place of business _____

Power of attorney of signatory of Bid
(Attach)

1.2 Total value of Civil engineering constructions Work performed in the last five/seven years (in Rs. Lakhs)

Year	Work done value (in Rs. Lakhs)	Supporting documents certified by CA
2019-20		
2020-21		
2021-22		
2022-23		
2023-24		

1.3.1 ~~Work performed as prime contractor, work performed in the past as a nominated sub-contractor will also be considered the sub-contract involved execution of all main items of work described in the bid documents, provided further that all other qualification criteria are satisfied (in the same name) on works of a similar nature over the last five years** and in current year before the submission of the bid.~~

Project Name	Name of the Employer	Description of work	Contract No.	Value of contract (Rs. Crore)	Date of issue of work order	Stipulated period of completion	Actual date of completion*	Remark explaining reasons for delay & work Completed

* Attach certificate(s) from the Engineer(s) in charge

** Immediately preceding the financial year in which bids are received.

Preferably standard - 3-A certificate issued by various government authority/ if work is private it should be by employer and private work should be supported by TDS work order, final bill payment, work order and as instructed in ITB.

#1.3.2 Quantities of work executed as prime contractor, work performed, in the past as a nominated sub-contractor, will also be considered provided the sub-contract involved execution of all main items of work described in the bid document, provided, further that all other qualification criteria are called (in the same name and style) in the last five years** and in current year before the submission of the bid.

Year	Name of the work	Name of the Employer	Quantity of work performed (Cum/MT)				Remarks* (indicate contract Ref)
			Cement Concrete (Including RCC & PCC)	Masonry	Earth Works	Bituminous Work	
2023-2024							
2022-2023							
2021-2022							
2020-2021							
2019-2020							

1.4 Information on Bid Capacity (works for which bids have been submitted and works which are yet to be completed) as on the date of this bid.

(A) Existing commitments and on-going works:

Name of Building/Hospital works	Place & State	Contract No.	Name & Address of Employer	Value Contract (Rs. Cr)	Stipulated Period of Completion	Value of Works* remaining to be completed (Rs. Cr)	Anticipated of completion	Remarks
1	2	3	4	5	6	7	8	9

* Attach certificate (s) from the Engineer(s) in-charge

** Immediately preceding the financial year in which bids are received.

1.5 Availability of key items of Contractors Equipment for carrying out the works (Ref. Clause 4.5.5). The Bidder should list all the information requested below.

Sr. No.	Plant or Machinery	Nos.	Location	Age of Machinery (maximum 15 years)	Make	Capacity	Approximate Value	Remark
1	2(a)	2(b)	2(c)	3	4	5	6	7

- 4.6 Qualifications and experience of key personnel required for administration and execution of the contract. Attach biographical data. Refer also to Sub Clause 9.1 of the Conditions of Contract.

Bidder should propose the structure and composition of the team dedicated for carrying out the Assignment. Bidder should list the main disciplines of the assignment, the key personnel responsible, and proposed technical and support staff. The personnel schedule shall be consistent with the approach and methodology, detailed work plan, activity schedule.				
Sr. No	Position	No. Of Resources	Min Qualification	Deployment
Key Personal				

1.7 Proposed sub-contract and firmsinvolved

Sections of the works	Value of Sub-Contractor	Sub-Contractor (Name& Address)	Experience in similar work

Attach copies of certificates on possession of valid license for executing water supply/ sanitary work/ building electrification works.

- 1.8 Financial reports for the last five years: balance sheets, profit and loss statements, auditors' reports (in case of companies/corporations), etc. List them below and attachcopies.
- 1.9 Evidence of access to financial resources to meet the qualification requirements: cash in hand, lines of credit, etc. List them below and attach copieddocuments.
- 1.10 Name, address, and telephone, mobile number and Email ID of the Bidders bankers who may provide references if contacted by theEmployer.
- 1.11 Information on Litigation history in which the Bidder isinvolved.

Other Party (ies)	Employer	Cause of Dispute	Amount Involved	Remarks showing Present Status

1.12. ~~Statement of compliance under the requirements of Sub Clause 3.2 of the instruction to Bidders.~~ (Name of Consultant engaged for project preparations*)

1.13 Proposed work method and schedule. The Bidder should attach descriptions, drawings and charts as necessary to comply with the requirements of the Bidding documents. (Refer ITB Clause4.1)

- 1 Key Plan
- 2 Sectional Elevation
- 3 Campus Layout
- 4 Water Supply & Sewage Points
- 5 Any other

1.14 Programme

2. Deleted

3. Additional Requirements

3.1 Bidders should provide any additional information required to fulfill the requirements of Clause 4 of the Instructions to the Bidders, if applicable.

- (i) Affidavit
- (ii) Undertaking

* Fill the name of consultant

**SAMPLE FORMAT FOR EVIDENCE OF ACCESS TO OR
AVAILABILITY OF CREDIT FACILITIES**

(CLAUSE 4.5.6 OF

ITB)BANK

CERTIFICATE

ThisistocertifythatM/s._____ is a reputed company
with a good financialstanding.

If the contract for thework,namely_____ is awarded to the
above firm, we shall be able to provide overdraft/credit facilities to the extentof
Rs._____ to meet their working capital requirements for executing the above
during the contractperiod. **Estimated Cost**

(Signature)

Name of Bank

Senior Bank Manager

Address of the Bank

APPENDIX – A

(Form No. 3 A) (Self attested)

Referred to in Rules No. 1.3.1

DETAILS OF SIMILAR WORK COMPLETED

1. Name of Contractor :
2. Name of Work :
3. Estimated cost of Work put to tender :
4. Revised Estimated Cost :
5. Tender Amount :
6. Date of Starting the Work :
7. Date of completion of the work (As per contract agreement) :
8. Actual date of the Completion of work :
9. Amount of Actual completion of the total project :
A) Electrical Work cost:

10. State whether the details as above given by the contractor are correct if not state as to what is the correct information :
11. State whether the contractor has executed the work in progress. Satisfactory as per specification if not give the correct position of the work. :
12. Period rate & amount of compensation if levied. :
13. Period of extension granted if any :
14. Reason for delay in granted if any :
15. Any other remarks :

Particulars of work completed :

Date :

-Authorized Signature-

ANNEXURE - C

Format: Joint Venture

Referred to in Rules No. 4.6

(1) The Joint Venture Agreement made and entered into at _____ day of _____ (year) by _____ and between _____.

a. Firm A (Name with address of the registered office)

b. Firm B (Name with address of the registered office)

(2) **Definitions:** In this deed the following words and expressions shall have the meaning set out below:

a. "The Authority" shall mean Project Implementation Unit, Gandhinagar.

b. "The Works" shall mean

(Name of work) which is more particularly _____ described in the pre-qualification and tender documents issued thereof by the Authority.

c. The Tender "shall" mean the tender to be submitted by Joint Venture to the Authority for the work/works.

d. "The Contract" shall mean the contract entered/to be entered into between the Joint Venture and the Authority for the works.

(3) **Joint Venture (JV)**

The Parties hereto declare that they have agreed to form a Joint Venture for the purpose of submitting the pre-qualification Application/tender document initially and then tender and if successful for the execution of the works as an integrated Joint Venture. The parties are not under this agreement entering into any permanent partnership of Joint Venture to tender or undertake any contract other than the subject works. Nothing herein contained shall be considered to constitute the parties or partners to constitute either Party the agent of the other.

(4) **Witnesses:** Whereas Project Implementation Unit, Gandhinagar / Authority has invited tenders from intending bidders and the Authority has permitted a group of firms (not exceeding three) forming a Joint Venture to be eligible to be a bidder. And whereas _____ party of the first part, _____ party of the second part and _____ party of the third part are desirous to enter into a Joint Venture in the nature of partnership engaged in the joint undertaking for the specific purpose of execution of the work of constructing _____ and whereas Parties of the First, Second and Third part reached understanding to submit pre-qualification/tender, if pre-qualified, and to execute the contract if awarded;

This agreement witnesses as follows:

(a) The parties do not enter into an agreement of any permanent partnership of Joint Venture to tender or undertake any Contract other than the specified above;

(b) That the operation of this Joint Venture firm concerns and is confined to the work of _____ of Authority.

(c) The name of the Joint Venture firm for convenience and continuity shall be.....

(d) The Address of Joint Venture for communications shall be as under:

.....
.....
.....
.....

(e) The Joint Venture shall jointly submit pre-qualification application on the above name according to all terms and conditions stated in the relevant instructions contained in the bid documents.

(f) That this Joint Venture shall regulate the relations between the parties thereto and shall include without being limited to them the following conditions.

(1) _____ firm shall be the lead company in charge of the Joint Venture for all intents and purpose.

(2) In case the said work is awarded to the Joint Venture, the partners of the Joint Venture _____ will nominate a person with duly _____ notarized power of Attorney on stamp paper, who will represent the Joint Venture with the authority to incur liabilities, receive instructions and payments, sign and execute the contract for and on behalf of the Joint Venture.

(i) All the (Maximum two) parties agree to make financial participation and to place at disposal of Joint Venture the benefits of its individual experience, technical knowledge skill and shall in all respect bear its share as regards planning and execution of the work and responsibilities including the provision of information, advice and other assistance required in the Joint Venture and participation shall be in proportion of Firm-A.....% and Firm-B.....%

(ii) All rights, interests, liabilities, obligations work experience and risks (and all net profits or net losses) arising out of the contract shall be borne by the parties in proportion to their shares. Each of the parties shall furnish its proportionate share in any bonds, guarantees, sureties required for the works as well as its proportionate share in connection with the works. The share and participation of the two/three partners in working capital and other financial requirements shall be in ratio as mentioned above.

(5) Internal responsibilities and liabilities

(a) The division of individual scope of work may be worked out mutually by the parties but the party shall be jointly and severally liable to the Authority for the whole work.

(b) The parties specifically undertake to carry out their separate works in full compliance with the contract with the Authority. Each party shall be responsible jointly and severally for consequences if any arising out of defective or delayed execution of works which fall within the individual's party's area of responsibility and/or it has been caused due to acts and/or omission of the concerned party.

(c) The parties jointly and severally agree to replace, modify or repair any defect in their respective portions of works in accordance with the terms and condition of the Contract with the Authority.

(d) The parties jointly and severally shall indemnify and hold harmless to each other against any claim made by the Authority or any other third party for injury,

damage, _____ loss _____ or expenses is attributed to the breach/non-performance of his responsibilities by the indemnifying party in accordance with the agreements and/or Contract with the Authority.

(e) None of parties have joined in any other Joint Venture for the said works.

(6) Responsibilities and liabilities of Joint Venture towards the Authority

(a) Parties hereto shall be jointly and severally liable and responsible for the acts, deeds and things done or omitted to be done in respect of the execution of the Contract and for any financial liability arising therefrom.

(a) Parties hereto shall be jointly and severally responsible to the Authority for the execution of the works in accordance with the Contract Conditions;

(c) Parties hereto shall be jointly and severally indemnifying to the Authority against any claim made against the Authority or any other third party for any injury, damage or loss which may be attributed to the breach of the obligations under the Contract pursuant to the Contract.

(7) Site management

(a) The execution of the work on the site will be managed by a Project Manager appointed _____ by the Joint Venture and who will report to the _____ (JV). The Project Manager shall be authorized to represent the Joint Venture on site in respect of matters arising under the Contract.

(b) The _____ (Name of the JV) shall be jointly and severally liable to the Authority for the execution of the Contract commitment in respect of the works in accordance with Contract Conditions.

(8) Termination of the Agreement

This agreement shall be terminated in the following circumstances.

(a) The Authority awards the contract for the work to the other Bidder.

(b) The Authority cancels the work to award the contract.

(c) On completion of the defect liability period as stipulated in the Contract Agreement of the works and all the liabilities thereof are liquidated.

(9) No partner has right to assign any benefits, obligation of liability under the agreement to any third party without prior written consent of the other partner as well as Authority.

(10) Financial matter

(a) Bank Account in the name of the Joint Venture will be opened with any scheduled or nationalized Bank to be operated by an individual signatory as decided mutually by the Joint Venture partners.

(b) All the partners shall be responsible to maintain or cause to maintain proper Books of accounts, balances sheet and profit and loss account as to the state of affairs of the firm as at the end of the financial year and as to the profit and loss made or incurred by the firm for the year ended on that date, respectively shall be prepared and the same shall be subject to audit by a Chartered Accountant.

(c) None of the party shall be entitled to make any borrowing on behalf of the Joint Venture without express prior written consent of the other party.

(d) Bank guarantee for the application/execution of the work shall be provided jointly

from a bank acceptable to the Authority.

(11) Negotiation: Any negotiation of agreement between the parties hereto and the Authority subsequent to the submission of the tender and prior to award, shall take place only with consent of each of the parties who shall be represented at the such negotiation by one or more representative(s) duly empowered to make such negotiation or agreement.

(12) Legal jurisdiction: All questions relating to validity interpretation of this agreement shall be governed by the law of India and shall be subject to jurisdiction of High Court at Ahmedabad.

(13) Settlement of disputes: Any dispute in interpretation of any condition mentioned herein shall be referred to an arbitrator/tribunal by mutual consent of the partners and such proceedings shall be governed by Gujarat Public Works contract disputes tribunal act of 1992 and as amended from time to time. The award of arbitrator shall be final and binding on the party hereto. Neither the obligation of each party hereto the performance of contract nor the execution of work shall stop during the course of arbitration proceeding or as a result thereof.

(14) Insurance

(a) The Joint Venture through the parties individually shall take such insurance in connection with the work in accordance with the tender condition as acceptable to the Authority.

(b) The cost of the insurance premium paid by the Joint Venture shall be borne and paid by the parties in proportion to their respective shares of work. Other insurance taken individually by the parties shall be fully borne by the respective parties.

(15) No change shall be made this agreement without prior written consent of the Authority and other party. However the Authority directs the parties to make changes in the agreement so as to fulfil tender conditions the parties discuss with Authority and mutually agreed such changes required to be made in the agreement.

(16) Default and withdrawal from the Joint Venture: in case that either party fails to observe the provision stipulated in this agreement withdrawal from the Joint Venture, Loss and/or expenses incurred by other party due to such default and/or withdrawal shall be fully compensated by the party who has defaulted.

(17) All matter relating to or arising due to this agreement shall be treated as confidential and shall not be disclosed to any other party.

In witness whereof the parties have caused their duly authorized representatives to sign below.

Signed for and on behalf of Firm - A

Date

Seal & Sign

Witness

Signed for and on behalf of Firm - B

Date

Seal & Sign

Witness

AFFIDAVIT

1. I, the undersigned, do hereby certify that all the statements made in the required attachments are true and correct.

2. The undersigned also hereby certifies that neither our firm M/s. _____
_____ have not abandoned any work of Government of Gujarat/Government of India/any Board or Corporation under Government of Gujarat/Government of India nor any contract awarded to us for such works have been rescinded, during last five years prior to the date of this bid.

3. The undersigned hereby authorize(s) and request (s) any bank, person, firm or corporation to furnish pertinent information deemed necessary and requested by the Department to verify this statement or regarding any (our) competence and general reputation.

4. The Undersigned understands and agrees that further qualifying information may be requested, and agrees to furnish any such information at the request of the Department/ Project implementing agency.

(Signed by an Authorized Officer of the Firm)

Title of Officer

Name of Firm

Date

UNDERTAKING

I, the undersigned do hereby undertake that our firm
M/s would invest a minimum cash
up to 25% of the value of the work during implementation of the contract.

(Signed by an Authorized officer of the firm)

Title of officer

Name of firm

DATE

SECTION - 3
CONDITIONS OF CONTRACT

Conditions of Contract

Table of Contents

A	General	Page No.	D.	Cost Control	
1	Definitions	72	37	Bill of Quantities	83
2	Interpretation	73	38	Changes in the Quantities	83
3	Language and Law	74	39	Variations	83
4	Engineer's Decisions	74	40	Payments for Variations	83
5	Delegations	74	41	Cash Flow Forecasts	84
6	Communications	74	42	Payment Certificates	85
7	Sub-Contractors	74	43	Payments	85
8	Other Contractors	74	44	Compensations Events	85
9	Personnel	75	45	Tax	86
10	Employer's & Contractor Risk	75	46	Currencies	86
11	Employers Risks	75	47	Price Adjustment	86
12	Contractor's Risk	75	48	Retention	86
13	Insurance	75	49	Liquidated damages	87
14	Site Investigations Reports	76	50	Bonus	88
15	Queries about the Contract	76	51	Advance Payment	88
16	Contractors to Construct the works	76	52	Securities	89
17	The Works to be Completed By the Intended Completion Date	76	53	Deleted	89
18	Approval by the Engineer	76	54	Cost of Repair	89
19	Safety	76			
20	Discoveries	77			
21	Possession of the Site	77	E.	Finishing the Contract	
22	Access to the Site	77	55	Completion	90
23	Instructions	77	56	Taking Over	90
24	Disputes	77	57	Final Account	90
				Operating and Maintenance manuals	90
25	Procedure for Disputes	78			
26	Deleted	78	58	Terminations	90
			59	Payment upon Terminations	91
B.	Time Control		60	Property	92
27	Programme	79	61	Release from Performance	92
28	Extensions of the Intended completion date	79			
29	Deleted	79	F.	Special Conditions of Contract	
30	Delays Ordered by The Engineer	79	62	Labour	93
			63	Compliance with labour regulations	93
31	Management Meetings	80	64	Arbitration	96
32	Early Warning	80			
C.	Quality Control				
33	Identifying Defects	81			
34	Tests	82			
35	Correction of Defects	82			
36	Uncorrected Defects	82			

CONDITIONS OF CONTRACT

A. GENERAL

1. Definitions

- 1.1 Terms which are defined in the Contract Data are not also defined in the Conditions of Contract but keep their defined meaning.

Bill of Quantities means the priced and completed Bill of Quantities forming part of the Bid

Compensation Events are those defined in Clause 44 hereunder

The **Completion Date** is the date of completion of the Works as certified by the Engineer in accordance with Sub Clause 55.1

The Contract is the contract between the Employer and Contractor to execute, complete and maintain the Works **till the completion of Defects Liability Period**. It consists of the documents listed in Clause 2.3 below.

The **Contract data** defines the documents and other information which comprise the Contract.

The **Contractor** is a person or corporate body whose Bid to carry out the Work has been accepted by the Employer.

The **Contractor's Bid** is the completed Bidding document submitted by the Contractor to the Employer and includes Technical and Financial Bids.

The **Contract Price** is the price stated in the Letter of Acceptance and thereafter as adjusted in accordance with the provisions of the Contract.

Days are calendar days: **months** are calendar months.

The **Defects Liability Period** is the period named in the Contract Data and calculated from the Completion Date.

The **Employer- BMC**

On behalf of the Bhavnagar Municipal Corporation, The Executive Engineer, Building Department, Municipal Corporation, Bhavnagar is in charge of the works and one of the persons for contract signing authority.

The Engineer is the person named in the Contract Data (or any other competent person appointed and notified to the contractor to act in replacement of the Engineer) who is responsible for supervising the Contractor, administering the Contract, certifying payments due to the Contractor, issuing and valuing Variations to the Contract, and valuing the Compensations Events under the control of **Executive Engineer**.

Equipment is Contractor's machinery and vehicles brought temporarily to the site to construct the Works.

The **Initial Contract Price** is the Contract Price listed in the Employer's Letter of Acceptance.

The **Intended Completion Date** is the date on which it is intended that the Contractor shall complete the Works. The Intended Completion Date is specified in the Contract Data. The Intended Completion Date may be revised only by the Engineer by issuing an extension of time.

Materials are all supplies, including consumables, used by the contractor for incorporation in the works.

Plant is any integral part of the work which is to have mechanical, electrical, electronic or chemical or biological functions.

The **Site** is the area defined as such in the Contract Data.

Site Investigation Reports are those which were included in the Bidding documents and are factual interpretive reports about the surface and subsurface conditions at the site.

Specifications means the Specifications of the works included in the Contract and any modification or addition made or approved by the Engineer.

The **Start Date** is given in the Contract Data or Indicating in Work Order. It is the date when the Contractor shall commence execution of the works. It does not necessarily coincide with any of the Site Possession Dates.

A **Subcontractor** is a person or corporate body who has a Contract with the Contractor to carry out a part of the work in the Contract which includes work on the Site.

Temporary Works are works designed, constructed, installed, and removed by the Contractor which are needed for construction or installation of the Works.

A **Variation** is an instruction given by the Engineer, which varies the Works.

The **Works** are what the Contract requires the Contractor to construct, install, and turn over to the Employer, as defined in the Contract Data.

2. Interpretation

- 2.1 In interpreting these Conditions of Contract, singular also means plural, male also means female or neuter and the other way around. Heading have no significance. Words have their normal meaning under the language of the Contract unless specifically defined. The Engineer will provide instructions clarifying queries about Conditions of Contract.
- 2.2 If sectional completion is specified in the Contract Data, references in the Conditions of Contract to the Works, the Completion date, and Intended Completion Date apply to any Section of the Works (other than references to the Completion Date and Intended Completion date for the whole works)
- 2.3 The documents forming the Contract shall be interpreted in the following order of priority
 - (1) Agreement
 - (2) Letter of Acceptance, notice to proceed with works
 - (3) Contractor's Bid

- (4) ContractData
- (5) Conditions of Contract including Conditions ofContract
- (6) Specifications
- (7) Drawings
- (8) Bills of quantitiesand
- (9) Any other document listed in the Contract Data as forming part of the Contract.

3. Language andLaw

- 3.1 The language of the Contract and the law governing the Contract are stated in the ContractData.

4. EngineersDecisions

- 4.1 Except where otherwise specifically stated, the Engineer will decide contractual matters between the Employer and the Contractor in the role representing theEmployer.

5. Delegation

- 5.1 The Engineer may delegate any of his duties and responsibilities to other people after notifying the Contractor and may cancel any delegation after notifying theContractor.

6. Communications

- 6.1 Communications between parties which are referred to in the conditions are effective only when in writing. A notice shall be effective only when it is delivered (in terms of Indian Contract Act).

7. Sub-Contracting

- ~~7.1 The Contractor may subcontract any portion of work, up to a limit specified in contract data, with the approval of the engineer but may not assign the Contract without the approval of the Employer in writing. Subcontracting shall not alter the Contractor's obligations. **Sub contracting of supply or specific items of work is not allowed.**~~

- 7.2 The sub-contractor must be registered in appropriate class and category for the part of work to besubcontracted.

8. OtherContractors

- 8.1 The Contractor shall cooperate and share the Site with other contractors, public authorities, utilities and the Employer between the dates given in the Schedule of other Contractor. The Contractors shall as refer to in the Contract Data, also provide facilities and services for them as described in the Schedule. The employer may modify the schedule of other contractors and shall notify the contractor of any suchmodifications.

9. Personnel

9.1 The Contractor shall employ the key personnel named in the Schedule of Key Personnel as referred to in the Contract Data to carry out the functions stated in the Schedule or other personnel approved by the Engineer. The Engineer will approve any proposed replacement of key personnel only if their qualifications, abilities, and relevant experience are substantially equal to or better than those of the personnel listed in the Schedule.

9.2 If the engineer asks the Contractor to remove a person who is a member of the Contractor Staff or his work force stating the reasons the Contractor shall ensure that the person leaves the Site within seven days and has no further connection with the work in the Contract.

10. Employer's and Contractors Risks

10.1 The Employer carries the risk which these Contract states are Employer's risks, and the Contractor carries the risks which these Contracts states are Contractors risk.

11. Employer's Risks

11.1 The employer is responsible for the excepted risks which are (a) in so far as they directly affect the execution of the Works, the risks of war, hostilities, invasion, act of foreign enemies, rebellion, revolution, insurrection or military or usurped power, civil war, riot commotion or disorder (unless restricted to the Contractor's employees), and contamination from any nuclear fuel or nuclear waste or radioactive toxic explosive.

12. Contractor's Risks

12.1 All risks of loss of or damages to physical property and of personal injury and death which arise during and in consequence of the performance of the Contract other than the excepted risks are the responsibility of the Contractor.

13. Insurance

13.1 The Contractor shall provide, in the joint names of the Employer and the Contractor, insurance cover from the Start date to the end of the Defects Liability Period, in the amounts and deductibles stated in the Contract data for the following events which are due to the Contractor's risks:

(a) Loss of or damage to the works, Plant and materials,

(b) Loss of or damage to Equipment

(c) Loss of or damages of property (except the Works, Plant, Materials and Equipment) in connection with the Contract; and

(d) Personal injury or death.

13.2 Policies and certificates for insurance shall be delivered by the Contractor to the Engineer for the Engineer's approval before the Start Date. All such insurance shall provide for compensation to be payable in the types and proportions of currencies required to rectify the loss or damage incurred.

- 133 If the Contractor does not provide any of the policies and certificates required, the Employer may affect the insurance which the Contractor should have provided and recover the premiums the Employer has paid from payments otherwise due to the Contractor or, if no payment is due, the payment of the premiums shall be a debt due.
- 134 Alterations to the terms of an insurance shall not be made without the approval of the Engineer.
- 135 Both parties shall comply with any conditions of the insurance policies.

14. Site Investigation Report

- 14.1 The Contractor in preparing the Bid shall rely on any site Investigation reports referred to in the Contract Data, supplemented by any information available to the Bidder.

15. Queries about the Contract data

- 15.1 The engineer will clarify queries on the Contract Data

16. Contractor to Construct the Works

- 16.1 The Contractor shall construct and install the works in accordance with the specification and Drawings.

17. The Works to be completed by the Intended Completion Date

- 17.1 The Contractor may commence execution of the Works on the Start Date and shall carry out the Works in accordance with the programme submitted by the Contractor, as updated with the approval of the Engineer, and complete them by the Intended Completion date

18. Approval by the Engineer

- 18.1 The Contractor shall submit Specifications and Drawings showing the proposed Temporary works to the Engineer, who is to approve them if they comply with the Specifications and drawings.
- 18.2 The Contractor shall be responsible for design of temporary works.
- 18.3 The Engineer's approval shall not alter the contractor responsibility for design of the Temporary works.
- 18.4 The Contractor shall obtain approval of third parties to the design of the Temporary works where required.
- 18.5 All Drawings prepared by the Contractors for the execution of the temporary or permanent work are subject to prior approval by the Engineer before their use.

19. Safety

- 19.1 The Contractor shall be responsible for the safety of all activities on the Site.

20. Discoveries

20.1 Anything of historical or other interest or of significant value unexpectedly discovered on the site is the property of the Employer. The contractor is to notify the engineer of such discoveries and carry out the Engineer's instructions for dealing with them.

21. Possession of the Site

21.1 The Employer shall give possession of all parts of the site to the Contractor. If possession of a part is not given by the date stated in the Contract Data the Employer is deemed to have delayed the start of the relevant activities and this will be a Compensation Event.

21.2 If within 25% of the time limit of the project, 80% of possession of the site is not handed over to the Contractor, then contractor/ Employer may fore-close the contract. Contractor/Employer has to foreclose the work within as decided by Employer. after lapse of 25%-time limit and after 30 days foreclosure option will be closed.

22. Access to the Site

22.1 The Contractor shall allow the Engineer and any person authorized by the Engineer access to the Site, to any place where work in connection with the Contract is being carried out or is intended to be carried out and to any place where materials or plants are being manufactured/ fabricated/ assembled for the works.

23. Instructions

23.1 The Contractor shall carry out all instructions of the Engineer pertaining to works which comply with the applicable laws where the site is located.

23.2 The Contractor shall permit the Employer to inspect the Contractor's accounts and records relating to the performance of the Contractor and to have them audited by auditors appointed by the Employer, if so required by the Employer.

24. Disputes

24.1 If the Contractor is of the view that a decision taken by the Engineer was either outside the authority given to the Engineer by the Contract or that the decision was wrongly taken, the decision shall be referred to **#Commissioner, BMC** Higher Authority within 30 days of the notification of the Engineer's decision. If the issue is not resolved, any party can refer the matter for conciliation within 30 days from the decision given by the **#Commissioer, BMC** Higher Authority

24.2

(a) For any of the parties is not satisfied with the decision of the **#Commissioner, BMC**, both the parties have to refer to the OSD or DMC or Municipal Commissioner **#Commissioner, BMC** for the conciliation process.

~~(b) For the work more than Rs.250 Cr., if any of the parties is not satisfied with the decision of the #Chief Engineer, both the parties have to refer to the #Secretary, Roads & Building Department, Government of Gujarat for the conciliation process.~~

If the dispute is not resolved through the conciliation process, he may refer the dispute to Competent Authority of BMC .

If the dispute is not resolved by the Employer, he may refer to Gujarat Public Works Contract Dispute Arbitration Tribunal. If the Contractor fails to refer a claim / dispute to the Higher Authority within 14 days of the notification of the Engineer's decision, the Contractor shall not be entitled to any additional payment/claim if he doesn't follow the above sequence in stipulated time and he should not stop the work.

25. Procedure for Disputers

- 25.1 The arbitration shall be conducted in accordance with the arbitration procedure stated in the Special Conditions of Contract.

26. Deleted

B. TIMECONTROL

27. Programme

- 27.1 Within the time stated in the Contract Data the Contractor shall submit to the Engineer for approval a Programme showing the general methods, arrangements orders, and timing for all the activities in the works along with monthly cash flowforecast.
- 27.2 An update of the Programme shall be a programme showing the actual progress achieved on each activity and the effect of the progress achieved on the timing of the remaining work including any changes to the sequence of theactivities.
- 27.3 The Contractor shall submit to the Engineer, for approval an updated programme at intervals no longer than the period stated in the Contract data. If the Contractor does not submit an updated programme within this period, the Engineer may withhold the amount stated in the Contract data from the next payment after the date on which the overdue programme has been submitted.
- 27.4 The Engineer's approval of the programme shall not alter the Contractor's obligations. The Contractor may revise the programme and submit it to the Engineer again at any time. A revised programme is to show the effect of Variations and Compensationevents.

28. Extension of the Intended CompletionDate

- 28.1 The Engineer shall extend the Intended Completion Date if a compensation Event occurs or a Variation is issued which makes it impossible for completion to be achieved by the Intended Completion Date without the Contractor taking steps to accelerate the remaining work and which would cause the Contractor to incur additionalcost.
- 28.2 The Engineer shall decide whether and by how much to extend the Intended Completion Date within 35 days of the Contractor asking the Engineer for a decision upon the effect of a compensation event or Variation and submitting full supporting information. If the Contractor has failed to give early warning of a delay or has failed to cooperate in dealing with a delay, the delay by this failure shall not be considered in assessing the new Intended Completion Date.
- 28.3 The Engineer shall within 14 days of receiving full justification from the contractor for extension of Intended Completion Date refer to the Employer his decision. The employer shall in not more than 21 days communicate to the engineer the acceptance or otherwise of the Engineer's decision. If the employer fails to give his acceptance, the Engineer shall not grant the extension and the contractor may refer the matter under Clause24.1

29. Deleted

30. Delays Ordered by the Engineer

30.1 The Engineer may instruct the Contractor to delay the start or progress of any activity within the works.

31. Management Meetings

31.1 Either the Engineer or the Contractor may require the other to attend a management meeting. The business of a management meeting shall be to review the plans for remaining work and to deal with matters raised in accordance with the early warning procedure.

31.2 The Engineer shall record the business of management meetings and is to provide copies of his record to those attending the meeting and to the Employer. The responsibility of the parties for actions to be taken is to be decided by the Engineer either at the management meeting or after the management meeting and stated in writing to all who attended the meeting.

32. Early Warning

32.1 The Contractor is to warn the Engineer at the earliest opportunity of specific likely future events or circumstances that may adversely affect the quality of the work, increase the Contract price or delay the execution of works. The Engineer may require the contractor to provide an estimate of the expected effect of the future event or circumstance on the contract price and completion date. The estimate is to be provided by the Contractor as soon as reasonably possible.

32.2 The Contractor shall cooperate with the Engineer in making and considering proposals for how the effect of such an event or circumstance can be avoided or reduced by anyone involved in the work and in carrying out any resulting instruction of the Engineer.

C. QUALITYCONTROL

#33. Identifying Defects/ Defect liabilityperiod

33.1 : Defect liability period: The contractor shall be responsible to make good and remedy at his own expense any defect which may develop or may be noticed before the period mentioned hereunder from the certified date of completion. The Engineer in charge shall give the contractor a notice in writing about the defects and the contractor shall make good the same within 15 days of receipt of the notice. In the case of failure on the part of the contractor, the Engineer-in-charge may rectify or remove or re-execute the work at the risk & cost of the contractor. The Engineer-in-charge shall be entitled to appropriate the whole or any part of the amount of security deposit towards the expenses, if any, Incurred by him in rectification, removal or re-execution. The Defects Liability period shall be asunder....

- ~~(a) For all works costing up to Rs. 50,000 (amount put to tender), the period shall be 3 Months from the certified date of completion.~~
 - ~~(b) For all works costing more than Rs. 50,000 and up to Rs. 1 crore (amount put tender), the period shall be 12 (Twelve) months from the certified date of completion or one monsoon, whichever is later.~~
 - (c) For major projects costing more than Rs. 1 crore, the period shall be 36 Months from the certified date of completion which should include three monsoons.
 - ~~(d) For original building works the defect liability period will be 4 years or elapse of 4 monsoon period following date of possession of building taken over by user agency following the certified date of completion, whichever is later.~~
- For the purpose of deciding the monsoon period, the 30th September shall be treated as the last date.

~~33.2 Free maintenance guarantee period for works of building and allied system construction.~~

~~(a) Deleted~~

~~(b) Deleted~~

~~(c) Building and allied system of MGPS, MOT, CSSD, Lift, Electrification, ELV, Water Supply System, Drainage System, HVAC contractor shall maintain in operational condition by repairing, replacing, renovating of any component of building or allied system above as per mention period Cl.33 (D) also contractor shall deploy the qualified manpower for the operation of the system as per requirement~~

However, this amount shall be released against fixed deposit or bank guarantee pledged in the name of Executive Engineer after completion certificate of work is issued.

(1) Deleted

(2) Deleted

(3) Deleted

(4) Deleted

further that such interruption and diversion shall be undertaken by the Contractor only with the prior written approval of the Executive Engineer which approval shall not be unreasonably withheld. For the avoidance of doubt, it is agreed that the Contractor shall at all times be responsible for ensuring safe operation of the road.

33.3 The Engineer shall check the Contractor's work and notify the Contractor of any defects that are found. Such checking shall not affect the Contractor's responsibilities the Engineer may instruct the Contractor to search for a Defect and to uncover and test any work that the Engineer considers may have a Defect.

34. Tests

34.1 If the engineer instructs the Contractor to carry out a test not specified in the Specification to check whether any work has a Defect and the test shows that it does, the Contractor shall pay for the test and any samples. If there is no defect the test shall be a CompensationEvent.

34.2 #1% of the amount of work done should be deducted from R.A. Bill of the contractor for testing the quality of material workmanship, irrespective of actual charges. We may allow testing certificates of GERI or Government approved Lab by R&B Department/ BMC

~~34.3 Agency has to establish testing laboratory on site for the various test to be carried out in the work for this purpose agency shall construct a pukka laboratory building with all facility on site at location specified by the engineer incharge. Penalty as per R&B Circular no. _____ Dt. _____.~~

35. Correction of defects

35.1 The engineer shall give notice to the Contractor of any defects before the end of the defects Liability Period, which begins at Completion and is defined in the contract data. The Defects Liability Period shall be extended for as long as Defects remain to be corrected.

35.2 Every time notice of a Defect is given, the Contractor shall correct the notified defect within the length of time specified by the Engineer's notice.

36. Uncorrected Defects

36.1 If the Contractor has not corrected a defect within the time specified in the Engineer's notice, the Engineer will assess the cost of having the Defect corrected, and the Contractor will pay this amount.

D. COST CONTROL

37. Bill of Quantities

37.1 The bill of Quantities shall contain items for the constructions, installation, testing and commissioning work to be done by the Contractor.

37.2 The bill of Quantities is used to calculate the Contract price. The Contractor is paid for the quantity of the work done at the rate in the Bill of Quantities for each item.

38. Change in the Quantities

38.1 The Engineer shall have power to make any alterations in or addition to the original specifications, drawings, designs and instructions that may appear to him to be necessary or advisable during the progress of the work and the contractor shall be bound to carry out the work in accordance with any instruction in this connection which may be given to him in writing signed by the Engineer and such alteration shall not invalidate the contract and any additional work which the contractor may be directed to do in the manner above specified as part of the work shall be carried out by the contractor on the same conditions in all respects on which he agreed to do the main work and at the same rate as are specified in the tender for the main work.

Except that when the quantity of any item exceeds the quantity as in the tender by more than 130%, the contractor will be paid for the quantity in excess of 130%, at the rate entered in the SOR of the year during which the excess in quantity is first executed.

39. Variations

39.1 All Variations shall be included in updated programmes produced by the Contractor.

40. Payments for Variations

40.1 If the additional or altered work includes any class of work for which no rate is specified in this contract, then such class of work shall be carried out as under.

(i) At the rate derived from the item within the contract which is comparable to the one involving additional or altered class of work; where there are more than one comparable items, the item of the contract which is nearest in comparison with regard to class or classes of the work involved shall be selected and the decision of the **Executive Engineer** as to the nearest comparable item shall be final and binding on the contractor.

(ii) If the rate cannot be derived in accordance with (i) above, such class of works shall be carried out at the rate entered in the Schedule of Rates of the division

for the year in which the tender was received, increased or decreased by the percentage by which the tender amount is more or less as compared to the amount arrived at the rates in the "Schedule of Rates" of the Division in the year in which the tender was received. If the Schedule of rates of the Division does not contain all the items, the percentage increase or decrease of the tender shall be calculated considering such items which were included in the "Scheduled Rates" of the division for the year and for materials consumed on such item the rate to be charged would be the basic rate taken into account for fixing the rate in S.O.R. referred to above.

- (iii) If it is not possible to arrive at the rate from (i) and (ii) above, such class of work shall be carried out at the rate decided by the competent authorities on the basis of detailed rate analysis after hearing the contractor before a Committee of two **Executive Engineer** stationed at the same place or the nearest place.

- 402 If the additional or altered work, for which no rate is entered in the "Schedule of Rates" of the Division is ordered to be carried out before the rate is agreed upon, then the contractor shall within seven days of the date of receipt by him of the order to carry out the work, inform the Engineer-in-charge of the rate, which it is his intention to charge for such class of work and if the Engineer in charge does not agree to this rates, he shall by notice in writing be at liberty to cancel his order to carry out such class of work and arrange to carry it out in such manner as he may consider it advisable, provided always that if the contractor shall commence work or incur any expenditure in regard thereof before the rates shall have been determined as lastly herein before mentioned, then in such cases he shall only be entitled to be paid in respect of the work carried out or expenditure incurred by him prior to the date of the determination of the rate as aforesaid according to such rate or rates as shall be fixed by the Engineer-in-charge. In the event of the dispute, the decision of the **Municipal Commissioner (BMC) shall be final.**

Where, however, the work is to be executed according to the designs, drawings and specifications recommended by the contractor and accepted by the competent authority, the alternation above referred to shall be within the scope of such designs, drawings and specifications appended to the tenders.

The time limit for the completion of the work shall be extended in the proportion that the increase in the cost occasioned by alterations bears to the cost of the original work and the certificate of the Engineer-in-charge as to such proportion shall be final and conclusive.

41. Cash Flow Forecasts

- 41.1 When the programme is updated, the contractor is to provide the engineer with an updated cash flow forecast.

42. Payment certificates.

421 The Contractor shall submit to the Engineer monthly statements of the estimated value of the work completed less the cumulative amount certified previously.

~~422 The Engineer shall check the Contractor's monthly statement within 14 days and certify the amount to be paid to the Contractor after taking in to account any credit or debit for the month in question in respect of materials for the works in the relevant amounts and under conditions set for this sub-clause 32.3 of the Contract Data (secured Advance).~~

423 The value of work executed shall be determined by the Engineer.

424 The value of work executed shall comprise the value of the quantities of the items in the Bill of Quantities completed.

425 The value of work executed shall include the valuation of variations and compensation events.

426 The Engineer may exclude any item certified in a previous certificate or reduce the proportion of any item previously certified in any certificate in the light of later information

43. Payments

431 Payments shall be adjusted for deductions for advance payments, retention, other recoveries in terms of the contract and taxes at source, as applicable under the law. The Employer shall pay the Contractor the amounts certified by the Engineer within 28 days of the date of each certificate.

432 Payment of GST (prevailing rates) on the amount payable under the contract to the Contractor will be made by the Employer.

Hence, it is the responsibility of the contractor to pay the GST to the concerned Authority of Government. We should decide policy for estimate base on R&B SOR other than 2023-24 and other RA items and electrical items.

433 Items of the works for which no rate or price has been entered in will not be paid by the Employer and shall be deemed covered by other rates and prices in the Contract.

44. Compensation events

441 The following are compensation Events unless they are caused by the Contractor:

(a) The Employer does not give access to a part of the Site by the site Possession date stated in Contract data to the Contractor

442 In case of compensation event occurs and it prevents the work being completed beyond the Intended Completion Date then Authority will approve Extension of Time with eligible contractual price escalation.

45. Tax

45.1 The rates quoted by the Contractor must be inclusive of all taxes prevailing on due date of bid submission except GST. However, any subsequent changes in the tax structure by Government after due date of bid submission will be compensated (+/-) on availability or submission of actual documentation. Contractor will have to intimate Engineer regarding changes occurred in the tax structure after bid submission. If the contractor fails to provide such information and if any financial obligation may arise due to change in tax structure, same will be recovered from the contractor.

45.2 GST will be paid separately on the bills. Hence, it is the responsibility of the contractor to pay the GST to the concerned Authority. Ref. 43.2

46. Currencies.

46.1 All payment shall be made in Indian Rupees.

~~47. Price Adjustment~~

~~47.1 Contract price shall be adjusted for increase or decrease in rates and price of labour, materials, fuels and lubricants in accordance with the following principles and procedures and as per formula given in the contract data:~~

~~(a) The price adjustment shall apply for the work done from the start date given in the contract data up to end of the initial intended completion date or extensions granted by the Engineer and shall not apply to the work carried out beyond the stipulated time for reasons attributable to the contractor.~~

~~(b) The price adjustment shall be determined during each month from the formula given in the contract data.~~

~~(c) Following expressions and meanings during to the work done during each month~~

~~R = Total value of work done during the month. It would include the amount of secured advance granted, if any, during the month less the amount of secured advance recovered, if any during the month. It will exclude value for works executed under variations for which price adjustment will be worked separately based on the terms mutually agreed.~~

~~47.2 To the extent that full compensation for any rise or fall in costs to the contractor is not covered by the provisions of this or other clause in the contract, the unit rates and prices included in the contract shall be deemed to include amounts to cover the contingency of such other rise or fall in costs.~~

48. Retention

48.1 The Employer shall retain from each payment due to Contractor the proportion stated in the Contract Data until Completion of the whole of the Works.

- 482 On Completion of the whole of the Works half the total amount retained is repaid to the Contractor and half when the Defects Liability Period has passed and the Engineer has certified that all Defects notified by the Engineer to the Contractor before the end of this period have been corrected.
- 483 On completion of the whole works, the contractor may substitute retention money with an "on demand" Bank guarantee.

In case, Contractor requests for refund of the Retention Money deducted by the Employer under the provision of this clause, Employer shall consider the said request of the Contractor provided that the refund hereunder shall be made in tranches of not less than 1% (One Percent) of the Contract Price and Contractor furnishes an irrevocable and unconditional Bank guarantee for an equal amount substantially in the format of Bank Guarantee for Performance Guarantee enclosed with SBD and valid up to 60 day beyond the scheduled / extended Defects Liability Period. On completion of the whole works, the contractor has however an option to submit a fresh irrevocable and unconditional Bank Guarantee for an amount equal to 5% of the total value of work executed substantially in the format of Bank Guarantee for Performance Guarantee enclosed with SBD and valid up to 60 days beyond the Defect Liability Period and yet refund the Retention Money Bank Guarantee submitted for refund of Retention Money.

49. Liquidated Damages

- 491 The Contractor shall pay liquidated damages to the Employer at the rate per day stated in the Contract Data for each day that the Completion Date is later than the Intended Completion Date (for the whole works or the milestone as stated in the contract data). The total amount of liquidated damages shall not exceed the amount defined in the Contract Data. The Employer may deduct liquidated damages from payment due to the Contractor. Payment of liquidated damages does not affect the Contractor's liabilities.
- 492 If the Intended Completion Date is extended after liquidated damages have been paid, the Engineer shall correct any overpayment of liquidated damages by the Contractor by adjusting the next payment certificate. The Contractor shall not be entitled for any interest on the over payment calculated from the date of payment to the date of repayment.
- 493 If the contractor fails to comply with the time for completion as stipulated in the tender, then the contractor shall pay to the employer the relevant sum stated in the Contract Data as Liquidated damages for such default and not as penalty for everyday or part of day which shall elapse between relevant time for completion and the date stated in the taking over certificate of the whole of the works on the relevant section, subject to the limit stated in the contract data.

The employer may, without prejudice to any other method of recovery deduct the amount of such damages from any monies due or to become due to the contractor. The payment or deduction of such damages shall not relieve

the contractor from his obligation to complete the works on from any other of his obligations and liabilities under the contract.

494 If, before the Time for Completion of the whole of the Works or, if applicable any Section, a Taking Over Certificate has been issued for any part of the Works or of a Section, the liquidated damages for delay in completion of the remainder of the Works or of that Section shall, for any period of delay after the date stated in such Taking-Over-Certificate, and in the absence of alternative provisions in the Contract, be reduced in the proportion which the value of the part so certified bears to the value of the whole of the Works or Section, as applicable. The provisions of this Sub-clause shall only apply to the rate of liquidated damages and shall not affect the limit thereof.

50 — Bonus

501 — If the contractor achieves completion of the whole of the works prior to the intended Completion Date prescribed in Contract Data the Employer shall pay to the contractor a sum stated in Contract Data as bonus for every completed month ~~but subjected to maximum amount as stated in Contract Data;~~ which shall elapse between the date of completion of all items of works as stipulated in the contract, including variations ordered by the Engineer and the time prescribed in Clause 17.

502 — Bonus shall be paid only to works amounting to above INR 5 crore with time limit of the works is equal or more than 6 months. The bonus would be paid as under

% of Time Saved	% of Initial Contract Price entitled for Bonus
50 %	5%
40 %	4%
30 %	3%
20 %	2%
10 %	1%
Less than 10%	0%

51. — Advance Payment.

51.1 — The Employer shall make advance payment (not to be paid less than two installments except in special circumstances for which the reason to be Recorded in writing) to the Contractor of the amounts stated in the Contract Date by the date stated in the Contract Date, against provision by the Contactor of an Unconditional Bank Guarantee in a form and by a bank acceptable to the Employer in amounts and currencies equal to be at least 110% of the advance payment. The guarantee shall remain effective until the

~~advance payment has been repaid, but the amount of the guarantee shall be progressively reduced by the amounts repaid by the Contractor. The Mobilization advance would be deemed as interest bearing advance at an interest rate of 10 % to be compounded, quarterly.~~

~~512 The Contractor is to use the advance payment only to pay for Equipment, plant and Mobilization expenses required specifically for execution of the Works. The Contractor shall demonstrate that advance payment has been used in this way by supplying copies of invoices or other documents to the engineer.~~

~~513 The advance payment shall be repaid by deduction proportionate amount from payments otherwise due to the Contractor, following the schedule of completed percentages of the Works on a payment basis. No account shall be taken of the advance payment or its repayment in assessing valuations of work done, variations, price adjustments, Compensation Events, or Liquidated damages.~~

~~514 Deleted~~

52. Securities

521 The performance Security (including additional security for unbalanced bids) shall be provided to the Employer no later than the date specified in the Letter of Acceptance and shall be issued in an amount and form and by a bank or surety acceptable to the Employer, and denominated in Indian Rupees. The performance Security shall be valid until a date 60 days from the date of expiry of Defects Liability Period and the additional security for unbalanced bids shall be valid until a date 28 days from the date of issue of the certificate of completion.

53. Deleted

54. Cost of Repairs.

541 Loss or damage to the Works or Materials to be incorporated in the Works between the Start date and the end of Defects Correction periods shall be remedied by the Contractor at the Contractor's cost if the loss or damages arises from the Contractor's acts or omissions.

E. FINISHING THE CONTRACT

55. Completion

55.1 The Contractor shall request the Engineer to issue a Certificate of Completion of the works and the Engineer will do so upon deciding that the work is completed.

56. Taking Over

56.1 The Employer shall take over the Site and the Works within seven days of the Engineer issuing a certificate of Completion.

57. Final Account

57.1 The Contractor shall supply to the Engineer a detailed final account of the total amount that the Contractor considers payable as full and final settlement of all claims under the Contract for items before the end of the Defects Liability Period. The Engineer shall issue a Defect Liability Certificate and certify any final payment that is due to the Contractor within 56 days of receiving the Contractor's account if it is correct and complete. If it is not, the Engineer shall issue within 56 days a schedule that states the scope of the corrections or additions that are necessary. If the Final Account is still unsatisfactory after it has been resubmitted, the Engineer shall decide on the amount payable to the Contractor and issue a payment certificate, within 56 days of receiving the Contractor's revised account.

57.2 If reversal in characteristic of tender (L1 becoming L2) on account of excesses and savings in final account is observed, the Engineer/Employer shall be at liberty to restrict the final payment of BOQ items to the lowest amount evaluated of the bids considering the final quantities and the rates quoted including the rebates if any. Payment of variation items shall however be made at the rates approved by the Employer, within 90 days from the physical completion of work. (Applicable for item rate tender only)

Operating and Maintenance Manuals

57.3 If "as built" drawings and/or operating and maintenance manuals are required, the Contractor shall supply them by the dates stated in the Contract data.

57.4 If the Contractor does not supply the Drawings and/or manuals by the dates stated in the Contract data, or they do not receive the Engineer's approval, the Engineer shall withhold the amount stated in the Contract Data from payments due to the Contractor.

58. Termination

58.1 The Employer or the Contractor may terminate the Contract if the other party causes a fundamental breach of the Contract.

582 Fundamental breaches of Contract include, but shall not be limited to the following:

1. The contractor stops work for 28 days when no stoppage of work is shown on the current programme and the stoppage has not been authorized by the Engineer
2. The Engineer instructs the Contractor to delay the progress of the Works and the instructions is not withdrawn within 28 days;
3. The Employer or the Contractor is made bankrupt or goes into liquidation other than for a reconstruction or amalgamation
4. A payment certified by the Engineer is not paid by the Employer to the Contractor within 56 days of the date of the Engineer's certificate
5. The Engineer gives Notice that failure to correct a particular Defect is a fundamental breach of Contract and the Contractor fails to correct it within a reasonable period of time determined by the Engineer;
6. The Contractor does not maintain a security which is required;
7. The Contractor has delayed the completion of works by the number of days for which the maximum amount of liquidated damages can be paid as defined in the Contract data; and
8. If the Contractor, in the judgment of the Employer has engaged in corrupt or fraudulent practices in competing for or in executing the Contract.

For the purpose of this paragraph: "corrupt practice" means the offering, giving, receiving or soliciting of anything of value to influence the action of a public official in the procurement process or in contract execution. "Fraudulent practice" means a misrepresentation of facts in order to influence a procurement process or the execution of a contract to the detriment of the borrower, and includes collusive practice among Bidders (prior to or after bid submission) designed to establish bid prices at artificial non-competitive levels and to deprive the Borrower of the benefits of free and open competition.

583 When either party to the Contract gives notice of a breach of contract to the Engineer for a cause other than those listed under Sub Clause 59.2 above, the Engineer shall decide whether the breach is fundamental or not.

584 Notwithstanding the above, the employer may terminate the Contract for convenience.

59. Payment upon Termination

59.1 If the Contract is terminated because of a fundamental breach of Contract by the Contractor, the Engineer shall issue a Certificate for the value of the work done less advance payments received up to the date of the issue of the

certificate, less other recoveries due in terms of the contract, less taxes due to deducted at source as per applicable law and less the percentage to apply to the work not completed as indicated in the Contract data. Additional Liquidated Damages shall not apply. If the total amount due to the Employer exceeds any payment due to the Contractor the difference shall be a debt payable to the Employer.

- 592 If the Contract is terminated at the Employer's convenience or because of a fundamental breach of Contract by the Employer, the Engineer shall issue a certificate for the value of the work done, the cost of balance material brought by the contractor and available at site, the reasonable cost of removal of equipment, repatriation of the Contractor's personnel employed solely on the works, and the Contractor's cost of protecting and securing the Works and less advance payment received up to the date of the certificate, less other recoveries due in terms of the contract and less taxes due to deducted at source as per applicable law.

60. Property

- 601 All materials on the Site, Plant Equipments, Temporary Works and Works are deemed to be property of the Employer, if the Contract is terminated because of a Contractor's default.

61. Release from Performance

- 61.1 If the Contract is frustrated by the outbreak of war or by any other event entirely outside the control of either the Employer or the Contractor the Engineer shall certify that the Contract has been frustrated. The Contractor shall make the Site safe and stop work as quickly as possible after receiving this certificate and shall be paid for all work carried out before receiving it and for any work carried out afterwards to which commitment was made.

F. SPECIAL CONDITIONS OF CONTRACT

62. LABOUR

The Contractor shall, unless otherwise provided in the Contract, make his own arrangements for the engagement of all staff and labour, local or other, and for their payment of housing, feeding and transport.

The Contractor shall, if required by the Engineer, deliver to the Engineer a return in detail, in such form and at such intervals as the Engineer may prescribe, showing the staff and the numbers of the several classes of labour from time to time employed by the Contractor on the site and such other information as the Engineer may require.

63. COMPLIANCE WITH LABOUR REGULATIONS

During continuance of the contract, the Contractor and his sub-contractor shall abide at all times by all existing labour enactments and rules made thereunder, regulations, notification and bye laws of the State or central Government or local authority and any other labour law (including rules), regulations, bye laws that may be passed or notifications that may be issued under any labour law in future either by the State or the Central Government or the local authority. Salient features of some of the major labour laws that are applicable to the construction industry are given below. The Contractor shall keep the Employer indemnified in case any action is taken against the Employer by the competent authority on account of contravention of any of the provisions of any Act or rules made thereunder, regulations or notifications including amendments. If the Employer is caused to pay or reimburse, such amounts as may be necessary to cause or observe, or for observance of the provisions stipulated in the notifications/bye laws/Acts/Rules/regulations including amendments, if any, on the part of the Contractor, the Engineer/employer shall have the right to deduct any money due to the Contractor including his amount of performance security. The Employer/Engineer shall also have the right to recover from the Contractor any sum required or estimated to be required for making good the loss or damage suffered by the Employer.

The employees of the Contractor and the Sub-Contractor in no case shall be treated as the employees of the Employer at any point to time.

SALIENT FEATURES OF SOME MAJOR LABOUR AND OTHER LAWS APPLICABLE TO ESTABLISHMENTS ENGAGED IN BUILDING AND OTHER CONSTRUCTIONS WORK

- A) **Workmen Compensation Act 1923**:- The Act provides for compensation in case of injury by accident arising out of and during the course of employment.
- B) **Payment of Gratuity Act. 1972**:- Gratuity is payable to an employee under the Act on satisfaction of certain conditions on separation if an employee has completed 5 years service or more on death, the rate of 15 days wages for every completed year of service. The Act is applicable to all establishments employing 10 or more employees.
- C) **Employees P.F. and Miscellaneous Provision Act 1952**:- The Act Provides for monthly contributions by the employer plus workers @ 10% or 8.33% The benefits payable under the Act are:
1. Pension or family pension on retirement or death, as the case maybe.
 2. Deposit linked insurance on the death in harness of the worker.
 3. Payment of P.F. accumulation on retirement/death etc.
- D) **Maternity Benefit Act 1951** :- The Act provides for leave and some other benefits to women employees in case of confinement or miscarriage etc.
- E) **Contract Labour (Regulation & Abolition) Act 1970**: The Act provides for certain welfare measures to be provided by the Contractor to contract labour and in case the Contractor fails to provide, the same are required to be provided, by the Principal Employer by Law. The principal Employer is required to take Certificate of Registration and the Contractor is required to take license from the designated Officer. The Act is applicable to the establishments or Contractor of Principal Employer, if they employ 20 or more contract labour.
- F) **Minimum Wages Act 1948** :- The Employer is supposed to pay not less than the Minimum Wages fixed by appropriate Government as per provisions of the Act, if the employment is a scheduled employment. Construction of Building, Roads, Runways are scheduled employment.
- G) **Payments of wages Act 1936**:- It lays down as to by what date the wages are to be paid, when it will be paid and what deductions can be made from the wages of the workers.
- H) **Equal remunerations Act 1979** :- The Act provides for payment of equal wages for work of equal nature to Male and Female workers and for not making discrimination against female employees in the matter of transfer, training and promotion etc.
- I) **Payments of Bonus Act 1965**:- The Act is applicable to all establishments employing 20 or more employees. The Act provides for payments of annual bonus subject to a minimum of 8.33% of wages and maximum of 20 % of wages to employees drawing Rs. 3500/- per month or less. The bonus to be paid to employees getting Rs. 2500/- per month or above Rs. 3500/- per month shall be worked out by taking wages as Rs. 2500/- per month only. The Act does not

apply to certain establishments. The newly set-up establishments are exempted for five years in certain circumstances. Some of the State Governments have reduced the employment size from 20 to 10 for the purpose of applicability of this Act.

- J) **Industrial Disputes Act 1947** :- The Act lays down the machinery and procedure for resolutions of Industrial disputes, in what situations a strike or lock-out becomes illegal and what are the requirements for laying off or retrenching the employees or closing down the establishment.
- K) **Industrial employment (standing Orders) Act 1946** :- It is applicable to all establishments employing 100 or more workmen (employment size reduced by some of the State and Central Government to 50). The Act provides for laying down rules governing the conditions of employment by the Employer on matters provided in the Act and get the same certified by the designated Authority.
- L) **Trade Unions Act 1926**:-The Act lays the procedure for registration of trade unions of workmen and employers. The Trade Unions registered under the Act have given certain immunities from civil and criminal liabilities.
- M) **Child Labour (Prohibition & Regulation Act 1986** :-The Act prohibits employment of children below 14 years of age in certain occupations and process and provides for regulation of employment of children in all other occupations and processes. Employment of Child labour is prohibited in Building and Construction Industry.
- N) **Inter – State Migrant workmen’s (Regulation of Employment & Conditions of service) Act 1979**:-The Act is applicable to an establishment which employs 5 or more inter-state migrant workmen through an intermediary (who has recruited workmen in one state for employment in the establishment situated in another state).The inter-state migrant workmen, is an establishment to which this Act becomes applicable, are required to be provided certain facilities such as housing, medical aid, traveling expenses from home upto the establishment and back, etc.
- O) **The Building and Other Construction workers (Regulation of employment and Conditions of Service) Act 1996 and the Cess Act of 1996**:-All the establishments who carry on any building or other constructions work and employ 10 or more workers are covered under this Act.
All such establishments are required to pay cess at the rate not exceeding 1% of the cost of construction as may be modified by the government. The Employer of the establishment is required to provide safety measures at the Building or construction work and other welfare measures, such as canteens, First Aid facilities, Ambulance, Housing accommodations for workers near the workplace etc. The Employer to whom the Act applies has to obtain a registration certificate from the Registering Officers appointed by the Government.

- P) **Factories Act 1948** :-The Act lays down the procedure for approval of plans before setting up a factory, health and safety provisions, welfare provisions, working hours, annual earned leave and rendering information regarding accidents or dangerous occurrences to designated authorities. It is applicable to premises employing 10 persons or more with aid of power or 20 or more persons without the aid of power engaged in the manufacturing process.
- Q) **Royalty charges**-The contractor shall pay the royalty to the competent authority as per rule. The **royalty** charges paid shall be borne by the contractor and shall not be reimbursed by the Employer.
- R) **Following Pollution control Acts and amendments made thereof from time to time shall be applicable.**
1. Water (Preservation and control of Pollution) Act, 1974
 2. Air (Prevention and Control of Pollution Act) 1981
 3. Environmental (Protection) Act 1986

The contractor must commit to adopting Environmental management plan for best energy use, waste management, the reduction of pollution as in EMS (Environmental Management system) ISO-14001-2015

64. **ARBITRATION (GCC Clause 24)**

The procedure for arbitration will be as follows: -

- 64.1 If the Contractor is of the view that a decision taken by the Engineer was either outside the authority given to the Engineer by the Contract or that the decision was wrongly taken, the decision shall be referred to # **Executive Engineer** (Higher Authority) within 14 days of the notification of the Engineer's decision. If the issue is not resolved, any party can refer the matter for conciliation within 15 days from the decision given by the # **Executive Engineer**.
- 64.2 If the Contractor is of the view that a decision taken by the Engineer was either outside the authority given to the Engineer by the Contract or that the decision was wrongly taken, the decision shall be referred to # **Executive Engineer** Higher Authority within 30 days of the notification of the Engineer's decision. If the issue is not resolved, any party can refer the matter for conciliation within 30 days from the decision given by the # **Executive Engineer** Higher Authority
- 64.3
- (a) For any of the parties is not satisfied with the decision of the # **Executive Engineer**, both the parties have to refer to the OSD or DMC or Municipal Commissioner **Chief Engineer concern** for the conciliation process.
 - (b) ~~For the work more than Rs.250 Cr., if any of the parties is not satisfied with the decision of the #Chief Engineer, both the parties have to refer to the #Secretary, Roads & Building Department, Government of Gujarat for the conciliation process.~~

If the dispute is not resolved through the conciliation process, he may refer the dispute to Competent Authority of BMC .

If the dispute is not resolved by the Employer, he may refer to Gujarat Public Works Contract Dispute Arbitration Tribunal. If the Contractor fails to refer a claim / dispute to the Higher Authority within 14 days of the notification of the Engineer's decision, the Contractor shall not be entitled to any additional payment/claim if he doesn't follow the above sequence in stipulated time and he should not stop the work.

SECTION - 4
CONTRACT DATA

#CONTRACT DATA

Clause Reference With respect To section 3

Item marked "N/A" do not apply to this Contract.

1. The Employers is [CL.1.1]
Name:Commissioner,Bhavnagar Municipal Corporation
Address: Bhavnagar Municipal Corporation,Bhavnagar
Name of authorized Representative.....
2. The Engineer is Executive Engineer.
Name of Authorized Representative:
3. **The Defects Liability Period is 3 years from the date of completion.** [CL.1.1&33]
4. The Start Date shall be **1st**days for the date of issue of the Notice to proceed with thework. [CL.1.1]
5. The Intended Completion Date for the whole of the works is [CL.1.1,17&2]
24 Monthsafter start of work with the following milestones:
Milestone dates: [CL.2.2& 49.1]
Physical works to be completed Period from the start date
6. The Site is located at**Kumbharwada**, Bhavnagar city [CL.1.1]
7. The name and identification number of the Contract is:..... [CL.1.1]
8. The worksconsistof**Building Work with items asperB.O.Q.**The works shall, inter alia, include the following, as Specified or as directed: [CL.1.1]

~~(A) Road Works Deleted~~

~~Site clearance; setting — out and layout; widening of existing carriageway and strengthening including camber corrections; construction of new road/ Parallel service road; bituminous pavements remodeling/construction of Junctions, intersections, bus bays, lay bays; supplying and placing of drainage Channels, flumes, guard posts and guard other related items; construction/extension of cross drainage works, bridge, approaches and other related stones; protective works for roads/bridge; all aspects of quality assurance of various components of the works; rectification of The defects in the completed works during the Defects Liability Period; submission of "As built" drawings and any other related documents; and other item of work as may be required to be carried out for completing the work in accordance with the drawings and the provisions of the contract and to ensure safety.~~

~~(B) Bridge Works Deleted~~

~~Site clearance; setting out, provision of foundations, piers abutments and bearing; prestressed/reinforced cement concrete superstructure; wearing coat, hand railings, expansion joints, approach slabs, drainages spouts/ drowthake pipes, arrangements for fixing light posts, water mains, utilities etc; provision of suitably designed protective works; providing wing/return walls; provision of road markings, road signs etc.; all aspects of quality assurance; clearing the site and handing over the works on completion; rectification of the defects during the Defects Liability Period and submission of "As-built" drawings and other related documents; and other items of work as may be required to be carried out for completing the works in accordance with the drawings and the provisions of the contract and to insure safety~~

(C) Building Works

[CL.1.1]

(D) Other Items

Any Other Items as required to fulfill all contractual obligations as per the Bid documents.

10. The following documents also form part of the Contract:
_____As per clause 2-3_____ [CL.2.3(9)]
11. The law which applies to the Contract is the law of Union of India [CL.3.1]
12. The language of the Contract documents is English [CL.3.1]
13. Limit of subcontracting 25% of the Initial Contract Price (Not Applicable) [CL.7.1]
14. The Schedule of Other Contractors [CL.8]
15. The Schedule of Key Personnel As per Annex – II to Section I [CL.9]
16. **The minimum insurance cover should be done by the contractor for physical property, injury and death is Rs. 5 lakhs per occurrence** with the number of occurrences limited to four. After each occurrence, the contractor will pay an additional premium necessary to make insurance valid for four occurrences always. [CL.13]
17. Site Investigation report [CL.14]
18. The Site Possession dates shall be actual date of Possession given to the contractor. [CL.21]
19. The period for submission of programme **with BAR CHART** for approval of the engineer shall be **10 days** from the issue of Letter of Acceptance. [CL. 27.1]
20. The period between program updates **will be 60 days.** [CL.27.3]
21. **The amount to be withheld for late submission of each updated programme shall be Rs.0.10 lakhs per day.** [CL. 27.3]

22. The following events shall also be Compensation Events
Substantially adverse ground conditions encountered during the
course of execution of work not provided for in the bidding document.
- (i) Removal of underground utilities detected subsequently
 - (ii) Significant changes in classification of soil requiring
additional mobilization by the contractor, e.g. ordinary soil
to rock excavation,
 - (iii) Removal of unsuitable material like marsh, debris dumps,
etc. not caused by the contractor.

[CL. 44]

- (iv) Artesian conditions
- (v) Seepage, erosion landslide
- (vi) River training requiring protection of permanent work
- (vii) Presence of historical, archeological or religious structures, monuments interfering with the works
- (viii) Restriction of access to ground imposed by civil, judicial, or military authority

23. The currency of the Contract is Indian Rupees [CL. 46]

24. **The formula (e) for adjustment of prices are as under:** [CL.47]

NOT APPLICABLE

~~• If any of the commodities like Cement, Steel or Bitumen are not found applicable in a work, the weight component of that commodities (i.e. 'Cement' (Pc), 'Steel' (Ps) or 'Bitumen' (Pb) as indicated in SBD for the purpose of Price Adjustment) shall be clubbed with the weight component of 'Other Material' (Pm), such that the gross % weight of the components shall remain as 100%.~~

~~R = value of work as defined in Clause 47.1 of Conditions of Contract~~

Adjustment for labour component

(i) Price adjustment for increase or decrease in the cost due to labour shall be paid in accordance with the following formula:

$$V_L = 0.85 \times (P_i/100) \times R \times (L_i - L_0)/L_0$$

~~V_L = Increase or decrease in the cost of work during the month under consideration due to changes in rates for local labour~~

~~L₀ = The consumer price index for industrial workers for the State on 28 days preceding the scheduled date of opening of technical Bids as published by Labour Bureau, Ministry of Labour, Government of India~~

~~L_i = The consumer price index for industrial workers for the State for the month under consideration as published by the Labour Bureau, Ministry of Labour, Government of India.~~

~~P_i = Percentage of labor component of the work.~~

Adjustment for cement component.

(ii) Prices adjustment for increase or decrease in the cost of cement procured by the contractor

$$V_c = 0.85 \times (P_c/100) \times R \times (C_i - C_0)/C_0$$

~~V_c = Increase or decrease in the cost of work during the month under consideration due to changes in rates for cement.~~

~~C₀ = The all India wholesale price index for Ordinary Portland Cement on 28 days preceding the scheduled date of opening of technical bid as published by the **Office of the Economic Adviser, Department for Promotion of Industry and Internal Trade, Ministry of Commerce & Industry.**~~

~~C_i = The all India average wholesale price index for Ordinary Portland Cement for the month under consideration as published by **Office of the Economic Adviser, Department for Promotion of Industry and Internal Trade, Ministry of Commerce & Industry.**~~

~~P_c = Percentage of cement component of the work~~

Adjustment for steel component

(iii) — Price adjustment for increase or decrease in the cost of steel procured by the contractor shall be paid in accordance with the following formula

$$V_s = 0.85 \times (P_s/100) \times R \times (S_i - S_0)/S_0$$

~~V_s = Increase or decrease in the cost of work during the month under consideration due to changes in the rates for steel~~

~~S₀ = The all India wholesale price index for steel (**Mild Steel – Long Products Rebars**) on 28 days preceding the date of opening of Bids as published by the **Office of the Economic Adviser, Department for Promotion of Industry and Internal Trade, Ministry of Commerce & Industry.**~~

~~S_i = The all India average wholesale price index for steel (**Mild Steel – Long Products Rebars**) for the month under consideration as published by **Office of the Economic Adviser, Department for Promotion of Industry and Internal Trade, Ministry of Commerce & Industry.**~~

~~P_s = Percentage of steel component of the work~~

Note : For the application of this clause, the index of **Mild Steel – Long products Rebars** has been chosen to represent the steel group.

Adjustments of bitumen component

(iv) — Price adjustment for increase in the cost of bitumen shall be paid in accordance with the following formula

$$V_b = 0.85 \times (P_b/100) \times R \times (B_i - B_0)/B_0$$

~~V_b = Increase or decrease in the cost of work during the month under consideration due to changes in rates for bitumen.~~

~~B₀ = The official retail price of bitumen at the IOC depot at the nearest centre on the day 28 days prior to the scheduled date of opening of technical bid.~~

~~B_i = The official retail price of bitumen of IOC depot at the nearest centre for the 15th day of the month under consideration.~~

~~P_b = Percentage of bitumen component of the work~~

Adjustment of POL (fuel and lubricant) component

~~(v) — Price adjustment for increase or decrease in cost of POL (fuel and lubricant) shall be paid in accordance with the following formula~~

$$V_f = 0.85 \times (P_f/100) \times R \times (F_i - F_0)/F_0$$

~~V_f = Increase or decrease in the cost of work during the month under consideration due to changes in rates for fuel and lubricants.~~

~~F₀ = The official retail price of High Speed Diesel (HSD) at the existing consumer pumps of IOC at the nearest centre on the day 28 prior to the date of opening of Bids.~~

~~F_i = The official retail price of HSD at the existing consumer pumps of IOC at the nearest centre for the 15th day of the month of the under consideration.~~

~~P_f = Percentage of fuel and lubricants component of the work~~

~~Note: For the application of this clause, the price of High Speed diesel Oil has been chosen to represent the fuel and lubricants group.~~

Adjustment for Construction Machinery

~~(vi) — Price adjustment for increase or decrease in the cost of plant and Machinery spare procured by the Contractor shall be paid in accordance with the following formula~~

$$V_p = 0.85 \times (P_p/100) \times R \times (P_i - P_0)/P_0$$

~~V_p = Increase or decrease in the cost of work during the month under consideration due to changes in rates for plant and machinery spares~~

~~P₀ = The all India wholesale price index for **manufacturer of machinery for mining, quarrying and Construction** for the month under consideration as published **Office of the Economic Adviser, Department for Promotion of Industry and Internal Trade, Ministry of Commerce & Industry.**~~

~~P_i = The all India average wholesale price index for **manufacturer of machinery for mining, quarrying and Construction** for the month under consideration as published **Office of the Economic Adviser, Department for Promotion of Industry and Internal Trade, Ministry of Commerce & Industry.**~~

~~P_p = Percentage of plant and machinery spares component of the work.~~

~~Note: For the application of this clause, index of Heavy Machinery and parts has been chosen to represent the Plant and Machinery Spares group~~

Adjustment of other materials Component

(vii) ~~Price adjustment for increase or decrease in cost of local materials other than cement, steel, bitumen and POL procured by the contractor shall be paid in accordance with the following formula~~

$$V_m = 0.85 \times (P_m/100) \times R \times (M_i - M_0)/M_0$$

~~V_m = Increase or decrease in the cost of work during the month under consideration due to change in rates for local materials other than cement, steel, bitumen and POL.~~

~~M₀ = The All India wholesale price index (all commodities) on 28 days preceding the scheduled date of opening of technical Bids, as published by the **Office of the Economic Adviser, Department for Promotion of Industry and Internal Trade, Ministry of Commerce & Industry.**~~

~~M_i = The All India wholesale price index (all commodities) for the month under consideration as published by the **Office of the Economic Adviser, Department for Promotion of Industry and Internal Trade, Ministry of Commerce & Industry.**~~

~~P_m = Percentage of local material components (other than cement, steel, bitumen and POL) of the work.~~

~~The following percentage will govern the price adjustment for the entire contract:~~

			Other s
Labour P _L %			
Cement P _c %			
Steel P _s %			
Bitumen P _b %			
POL P _f %			
Plant & Machinery Spares P _p %			
Other Materials P _m %			
Total	100	100	100
	%	%	%

Note 1) Delete

2) for new construction of SDH/DH/Medical Colleges and Other building works % shall be applicable as mentioning tender documents.

~~25. The proportion of payments retained (retention money) shall be 6% {CL-48} from each RA bill subject to a maximum of 5% of final contract price.~~

~~26. Amount of Liquidated damages for delay in completion of works~~ ~~For Whole of work (CL 49)~~
~~(1/2000)*of the Initial contract price, rounded off to the nearest Thousand, per day. For sectional Completion (wherever specified In item 6 of Contract data) (1/2000)*of initial contract price for #5 km Section, rounded off to the nearest thousand per day.~~

~~27. Maximum limit of liquidated damages 10 percent of the Initial (CL. 49)
 For delay in completion work Contract Price rounded off to
 the nearest thousand~~

28. Amount of Bonus for early completion Amount of bonus for early
 completion of work shall be given
 as per CL. 50 of Section-3

29. Maximum limit of bonus for early 5 percent of the Contract (CL. 50)
 Completion of work Price

30. The amount of the advance payment are: (CL. 51 & 52)

# Nature of Advances	Amount (Rs.)	Conditions to be fulfilled
i Mobilization	10% of the contract Price	On submission of unconditional Bank Guarantee. (to be drawn before the end of 20% of the contract period). The contractor may furnish four bank guarantees of 2.5 % of each valid for the full period.
ii Equipment	90% for new and 50% of depreciated value for old equipment. Total amount will be subject to a maximum of 5% of the Contract Price	After equipment is brought to site (provided the Engineer is satisfied That the equipment is required for performance of the contract) and on submission of unconditional Bank Guarantee for amount of advance
iii Secured Advance for Non-persish able material Brought to site	Deleted	

(The advance payment will be paid to the Contractor no later than 28 days after fulfillment of the above conditions).

31. **Repayment of advance payment for mobilization and equipment (CL. 51.3)**

The advance loan shall be repaid with percentage deduction from the interim payments certified by the Engineer under the Contract. Deduction shall commence in the next Interim Payment Certificate following that in which the

total of all such payments to the Contractor has reached not less than 20 percent of the Contract Price or 6 (six) months from the date of payment of first installment of advance, whichever period concludes earlier, and shall be made at the rate of 20 percent **(collectively for both Mobilization Advance and Equipment Advance)** of the amounts of all Interim Payment Certificate until such time as the loan has been repaid, always provided that the loan shall be completely repaid prior to the expiry of the original time for completion pursuant to Clause 17 and 28.

32. Deleted
33. The securities shall be for the following minimum amounts equivalent {CL. 52}
As a percentage of the Contract Price:
Performance Security for 5 percent of contract price plus Rs. (to be decided after evaluation of the bid) as additional security in terms of ITB Clause 29.5

The standard form of Performance security acceptable to the Employer shall be an unconditional Bank Guarantee of the type as presented in Section 8 of the Bidding Documents.

34. **The Schedule of Operating and maintenance Manuals.....N/A.** {CL.58}
35. The date by which "as- built" drawings (in scale as directed) in 2 sets {CL. 58} are required within 28 days of the issue of certificate of completion of the whole or section of the work, as the case maybe.
36. The amount to be withheld for failing to supply "as built" drawings {CL. 58} by the Date required is Rs..... Lakhs.
37. The following events shall also be fundamentals breach of contract: {CL.59.2}
"The Contractor has contravened Sub- clause 7.1 and Clause 9 of GCC"
38. **The percentage to apply the value of the work not completed representing {Cl 60} the Employer's additional cost for completing the Works shall be 20 percent.**

SECTION - 5
TECHNICAL SPECIFICATION

Separate Sheet Attached

SECTION - 6
FORM OF BID

FORM OF BID

Description of the Works:

BID

To :

Address :

- 1. We offer to execute the Works described above and remedy any defects therein in conformity with the conditions of Contract, specification, drawings, Bill of Quantities and Addenda for the sum (s)of

(-----)

- 2. We undertake, if our Bid is accepted, to commence the Works as soon as is reasonably possible after the receipt of the Engineer's notice to commence, and to complete the whole of the Works in the Contact within the time stated in the document.
- 3. We agree to abide by this Bid for the period of 120 Days from the date fixed for receiving the same, and it shall remain binding upon it and may be accepted at any time before the expiration of thatperiod.
- 4. Unless and until a formal Agreement is prepared and executed this Bid, together with your written acceptance thereof, shall constitute a binding contract between us.
- 5. We understand that you are not bound to accept the lowest or any tender you may receive.

Datedthis----- dayof ----- 20

Signature ----- in the capacity of -----

----- duly authorized to sign bids for and on behalf of -----

(in block capitals or typed)

Address

Witness

Address

Occupation

SECTION - 7
BILL OF QUANTITIES

Separate Sheet Attached

BILL OF QUANTITIES

Preamble

1. The bill of Quantities shall be read in conjunction with the Instructions to Bidder, Conditions of Contract, Technical Specifications and Drawings.
2. The quantities given in the Bill of Quantities are estimated and provisional, and are given to provide a common basis for bidding. The basis of payment will be the actual quantities of work ordered and carried out, as measured by the Contractor and verified by the Engineer and valued at the rates and prices tendered in the priced Bill of Quantities, where applicable, and otherwise at such rates and prices as the Engineer may fix within the terms of the Contract.
3. The rates and prices tendered in the priced Bill of Quantities shall, except in so far as it is otherwise provided under the Contract, include all constructional plant, layout, supervision, materials, erection, maintenance, insurance, profit, taxes and duties, together with all general risks, liabilities and obligations set out or implied in the Contract.
4. The rates and prices shall be quoted entirely in Indian Currency.
5. A rate or prices shall be entered against each item in the Bill Quantities, whether quantities are stated or not. The cost of Items against which Contractor has failed to enter a rate or price shall be deemed to be covered by other rates and prices entered in the Bill of Quantities (in case of Item rate contract).
6. The whole cost of complying with the provisions of the Contract shall be included in the items provided in the priced Bill of Quantities, and where no Items are provided the cost shall be deemed to be distributed among the rates and prices entered for the related items of Work.
7. General direction and descriptions of work and materials are not necessarily repeated or summarized in the Bill of Quantities. References to the relevant sections of the contract documentation shall be made before entering rates or prices against each item in the Bill of Quantities.
8. The method of completed work of payment shall be in accordance with the specification for Road and Bridge works. For building works specifications for building are to be followed.
9. Errors will be corrected by the Employer for any arithmetic errors pursuant to **Clause 29** of the Instructions to Bidder.
10. Rock is defined as all materials which, in the opinion of the Engineer, required blasting, or the use of metal wedges and sledgehammers, or the use of compressed air drilling for its removal, and which cannot be extracted by ripping with a tractor of at least 150 kw with a single rear mounted heavy duty ripper.

BILL OF QUANTITIES

(A) Percentage Rate Tender : Separate sheet attached

I/We am/are willing to carry out the work at.....% above/below percent (Should be written in figures and words) of the estimated rate mentioned above. Amount of my /our tender works out as under.

Estimated amount put to tender	Estimated amount put to tender
Deduct.....% below	Add.....% Above
Net	Net
In words	In words

(B) — For Item Rate Tender (For above INR 50Cr.): SOR Year 20__-20__ (Not Applicable)

Item No	Description of Item (with brief specification and reference to book of specifications)	Quantity	Unit	Rate		Amount
				In-figures	In-Words	

(A) Total Tendered Amount

(B) Rebate on above tendered amount (if any) % (in figure)
(in words).....

(C) Net Tendered Amount (A-B) (in figure)
(in words).....

1	The Contractor shall exhibit a board with detailed specification and details of work as directed by the Engineer-In-Charge for which no extra payment shall be made.
2	The labour cess will be deducted as per prevailing rules i.e. 1% of the work done.
3	All taxes and levies as per prevailing norms of Government will be born by the contractor, excluding GST. GST will be paid extra as per prevailing norms for bills.

SECTION - 8
SECURITIES AND OTHER FORMS

BID SECURITY (BANK GUARANTEE)

WHEREAS, ----- (name of Bidder) (hereinafter called the "The Bidder") has submitted his bid Dated ----- (Date) for the construction of ----- (Name of Contractor hereinafter called "the Bid")

KNOW ALL PEOPLE by these presents that We ----- (name of Bank) of ----- (name of country) having our registered office at ----- (hereinafter called "the bank") are bound unto _____ (name of Employer) (hereinafter called "The Employer") in the sum of ----- * for which payment well and truly to be made to the said Employer the Bank itself, his successors and assigns by these presents.

SEALED with the Common Seal of the said Bank this ----- day of ----- 20

THE CONDITIONS of these obligations are:

(1) If after Bid opening the Bidder withdraws his bid during the period of Bid validity specified in the Form of Bid;

Or

(2) If the Bidder has been notified of the acceptance of his bid by the Employer during the period of Bid Validity:

- A Fails or refuses to execute the Form of Agreement in accordance with the Instructions to Bidders, if required; or
- B. Fails or refuse to furnish the Performance Security, in accordance with the Instructions to Bidders; or
- C. does not accept the correction of the Bid Price pursuant to Clause 27 (Correction of Errors)

We undertake to pay to the Employer up to the above amount upon receipt of his first written demand, without the employer having to substantiate his demand, provided that in his demand the Employer will note that the amount claimed by him is due to him owing to the occurrence of one or any of the three conditions, specifying the occurred conditions or conditions.

This Guarantee will remain in force up to and including the date ----- ** days after the deadline for submission of Bids as such the deadline is stated in the Instructions to Bidders or as it may be extended by the Employer, notice of which extension (s) to the Bank is hereby waived. Any demand in respect of this guarantee should reach the Bank not later than the above date

DATE-----

SIGNATURE-----

WITNESS-----

SEAL-----

(Signature, name and address)

* The Bidder should insert the amount of the guarantee in words and figures denominated in Indian Rupees. This figure should be the same as shown in Clause 16.1 (Bid Security) of the Instructions to Bidders.

** **45 days** after the **end of the validity period** of the Bid. Date should be inserted by the Employer before the Bidding documents are issued.

PERFORMANCE SECURITY

TO,
Commissioner, Bhavnagar Municipal Corporation (Name of Employer)
....., Bhavnagar. (Address of Employer)

WHEREAS (name and address of contractor) (hereafter called "the Contractor") has undertaken, in pursuance of Contracts No. dates to execute (name of Contract and brief description of Works) (hereinafter called "The Contract")

AND WHEREAS it has been stipulated by you in the said Contract that the Contractor shall furnish you with a Bank Guarantee by a recognized bank for the sum specified therein as security for compliance with his obligation in accordance with the Contract.

AND WHEREAS we have agreed to give the Contractors such a bank Guarantee:

NOW THEREFORE we hereby affirm that we are the Guarantor and responsible to you on behalf of the Contractor, upto a total of (amount of guarantee)* (in words), such sum being payable in types and proportions of currencies in which the Contract price is payable, and we undertake to pay you, upon your first written demand and without cavil or argument, any sum or sums within the limits of (amount of guarantee) as aforesaid without your needing to prove or to show grounds or reasons for your demand for the sum specified therein.

We hereby waive the necessity of your demanding the said debt from the contractor before presenting it with the demand.

We further agree that no change or addition to or other modification of the terms of the Contract to of the Works to be performed thereunder or of any of the Contract documents which may be made between you and the Contractor shall in any way release us from any liability under this guarantee, and we hereby waive notice of any such charge, addition or modifications.

This guarantee shall be valid until 60 days from the date of expiring of the Defect Liabilities period.

Signature and Seal of the guarantor

Name of Bank

Address

Date

*An amount shall be inserted by the Guarantor, representing the percentage the Contract price specified in the Contract denominated in Indian Rupees.

ADDITIONAL PERFORMANCE SECURITY

[Clause 34.1. (A)]

TO,
Commissioner, Bhavnagar Municipal Corporation (Name of Employer)
....., Bhavnagar. (Address of Employer)

WHEREAS (Name and address of contractor) (hereafter called "The Contractor") has undertaken, in pursuance of Contracts No. dates to execute (Name of Contract and brief description of Works) (hereinafter called "The Contract")

AND WHEREAS it has been stipulated by you in the said Contract that the Contractor shall furnish you with a Bank Guarantee by a recognized bank for the sum specified therein as security for compliance with his obligation in accordance with the Contract.

AND WHEREAS we have agreed to give the Contractors such a bank Guarantee:

NOW THEREFORE we hereby affirm that we are the Guarantor and responsible to you on behalf of the Contractor, upto a total of (amount of guarantee) (in words), such sum being payable in types and proportions of currencies in which the Contract prices is payable, and we undertake to pay you, upon your first written demand and without cavil or argument, any sum or sums within the limits of (amount of guarantee) as aforesaid without your needing to prove or to show grounds or reasons for your demand for the sum specified therein.

We hereby waive the necessity of your demanding the said debt from the contractor before presenting is with the demand

We further agree that no change or addition to or other modification of the terms of the Contract to of the Works to be performed thereunder or of any of the Contract documents which may be made between your and the Contractor shall in any way release us from any liability under this guarantee, and we hereby waive notice of any such charge, addition or modifications.

This guarantee shall be valid until **90 days** from the project completion date.

Signature and Seal of the guarantor

Name of Bank

Address

Date

BANK GUARANTEE FOR ADVANCE PAYMENT

TO,

Commissioner, Bhavnagar Municipal Corporation (Name of Employer)
....., Bhavnagar. (Address of Employer)

----- (Name of Contractor)

Gentlemen:

In accordance with the provisions of the Conditions of Contract, sub-clause 51.1 ("Advance Payment") of the above-mentioned Contract, ----- (name and address of Contractor) (hereinafter called "the Contractor") shall deposit with (name of Employer) a bank guarantee his proper and faithful performance under the said Clause of the Contract in an amount of -- (amount of Guarantee)* ----- in words).

We, the ----- (bank of financial institution), as instructed by the Contractor, agree unconditionally and irrevocably to guarantee as primary obligator and not as Surety merely, the payment to ----- (name of Employer) on his first demand without whatsoever right of obligation on our part and without his first claim to the Contractor, in the amount not exceeding --- ----- (amount of guarantee)* ----- (in words)

We further agree that no change or addition to or other modifications of the terms of the Contractor or Works to be performed thereunder or of any of the Contract documents which may be made between ----- (name of Employer) and the Contractor, shall in any way release us from any liability under this guarantee, and we hereby waive notice of any such change, addition or modifications.

This guarantee shall remain valid and in full effect from the date of the advance payment under the Contract until ----- (name of employer) receives full repayment of the same amount from the contractor.

YOUR'S TRULY

Signature and Seal _____
Name of Bank/Financial Institution _____
Address _____
Date _____

* An amount shall be inserted by that Bank or Financial Institution representing the amount of the Advance Payment, and denominated in Indian Rupees.

Letter of Acceptance

(Letter head paper of the Employer)

_____ (date)

To,

_____ (Name and address of the Contractor)

Dear Sirs,

This is to notify you that your Bid dated _____ for execution of the _____ (Name of the contract and identification number, as given in the Instructions to Bidders) for the Contract Price of Rupees _____ (_____) (amount in words and figures) as corrected and modified in accordance with the Instructions to Bidders* is hereby accepted by our agency.

You are requested to furnish performance security, in the form detailed in para 34.1 of ITB for an amount equivalent to Rs. _____ within **10 days** of the receipt of this letter of acceptance, having Validity up to beyond **90 days** from the date of expiry of defects Liability period i.e. upto _____ and the Additional Performance Security for an amount equivalent to Rs. _____ shall be valid beyond 90 (Ninety) days of Project Completion Date i.e. upto _____ and sign the contract, failing which action as stated in Para 34.3 of ITB will be taken.

Yours Faithfully

Authorized Signature
Name and title of Signatory
Name of Employer

* Delete "Corrected and" or and modified if only one of these actions applies. Delete as corrected and modified in accordance with the Instructions to Bidders, if corrections or modifications have not been affected.

Issue of Notice to proceed with the work

(Letterhead of the Employer)

----- (date)

To,

_____ (Name and address of the Contractor)

Dear Sirs,

Pursuant to your furnishing the requisite security in ITB Clause 34.1 and signing of the Contract for the construction of _____

_____ at a bid Price of Rs.

_____.

You are hereby instructed to proceed with the execution of the said works in accordance with the contract documents.

Yours faithfully

(Signature, name and title of signatory authorized
To sign on behalf of Employer)

AGREEMENT FORM

This agreement, made on the _____ day of _____ between _____ (name and address of Employer) (Hereinafter called "the Employer) and _____ (name and address of contractor) hereinafter called "the Contractor" of the other part.

Whereas the Employer is desirous that the Contractor execute

Name and identification number of contract (hereinafter called "the works") and the employer has accepted the Bid by the Contractor for the execution and completion of such works and the remedying of any defects therein, at a cost of Rs.

NOW THIS AGREEMENT WITNESSETH AS FOLLOWS

1. In this Agreement, words and expression shall have the same meanings as are respectively assigned to them in the conditions of contract hereinafter referred to and they shall be deemed to form and be read construed as part of this Agreement.
2. In Consideration of the payment to be made by the Employer to the contractor as hereinafter mentioned, the Contractor hereby covenants with the Employer to executive and complete the works and remedy any defects therein in conformity in all aspects with the provisions of the contracts.
3. The employer hereby covenants to pay the Contractor in consideration of the execution and completion of the works and the remedying the defects wherein contract price or such other sum as may become payable under the provisions of the Contract at the times and in the manner prescribed by the contract.
4. The Following documents shall be deemed to form and be ready and construed as part of this Agreement viz
 - i) letter of Acceptance
 - ii) Notice to proceed with the works:
 - iii) Contractor's Bid

- iv) Conditions of contract: General and Special
- v) Contract Data
- vi) Additional conditions
- vii) Drawings
- viii) Bill of Quantities and
- ix) Any other documents listed in the Contract data as forming part of the Contract.

In witness whereof the parties there to have caused this Agreement to be executed the day and year first before written

The Commonseal of _____

Was hereunto affixed in the presence of:

Signed, sealed and Delivered by the said _____

In the presence of

Binding signature of Employer _____

Binding Signature of Contractor _____

UNDERTAKING
(For Investment)

I, the undersigned do hereby undertake that our firm M/s
..... would invest a minimum cash up
to **25%** of the value of the work during implementation of the contract.

(Signed by an Authorized officer of the firm)

Title of officer

Name of firm

DATE

UNDERTAKING
(For Validity)

I, the undersigned do hereby undertake that our firm M/s.....
..... agree to abide by this bid for a period..... days
for date fixed for receiving the same and it shall be binding on us and may be accepted at
any time before the expiration of that period.

(Signed by an Authorized officer of the firm)

Title of officer

Name of firm

DATE

SECTION - 9
DRAWINGS

As per attached files in this tender

SECTION - 10

DOCUMENTS TO BE FURNISHED BY BIDDER

Following documents shall be submitted in electronic format only through online by scanning and the (i) Bid Document Fee/ Tender Fee (ii) Bid Security / EMD should be sent in original to the Tender opening authority through RPAD, so as to reach the Executive Engineer within stipulated date in the tender.

- (xiv) Bid Document Fee / Tender Fee **(From Bidder's A/C Only)**
- (xv) Bid Security / EMD ~~or Valid EMD Exemption Certificate of Appropriate Class of Registration of Approved Contractors~~
- (xvi) Registration Certificate: "A" Class & Special Category-III (Bldg.) State/ Central Govt./Municipal Corporations/P.S.U.
- (xvii) Registration Certificate of Special Category - Building and Category I / II / III
- (xviii) GST Number & PAN Number
- (xix) Solvency Certificate (for current calendar year)
- (xx) A solvency certificate of an Amount of 20% (Twenty Percent) of estimated cost put to tender will have to be produced along with tender. It shall be of Scheduled Bank or Nationalized Bank or Bank Approved for Government business. Solvency Certificate shall have validity of same calendar year as that of date in which tender is issued.
- (xxi) Work Experience, FORM 3(A), should be given by officer not having position below then Executive Engineer.
- (xxii) EPF Registration Number & ESIC Registration Number
- (xxiii) Other Documents, as required...

STANDARD BIDDING DOCUMENT PROCUREMENT OF BUILDING WORKS

COMPLETE BIDDING DOCUMENT

BHAVNAGAR MUNICIPAL CORPORATION
BUILDING DEPARTMENT

Name Of Work :-CONSTRUCTION OF NEW PHC IN THE AREA OF BHAVNAGAR
CITY, **KUMBHARWADA**, BHAVNAGAR



BHAVNAGAR MUNICIPAL CORPORATION
BUILDING DEPARTMENT
BHAVNAGAR

Index

<u>Sr No</u>	<u>Section</u>	<u>Description</u>	<u>Page No</u>
1		Invitation for Bid (IFB)	3
2	Section -1	Instructions to Bidders	7
3	Section -2	Qualification Information	30
4	Section -3	Conditions of Contract	43
5	Section -4	Contract Data	71
6	Section -5	Technical Specification	83
7	Section -6	Form of Bid	84
8	Section -7	Bill of Quantities	87
9	Section -8	Securities and Other Forms	99
10	Section -9	Drawings	102
11	Section -10	Documents to be furnished by Bidder	103

**INVITATION FOR BID
(IFB)**

NATIONAL COMPETITIVE BIDDING-EPC BID

- The Executive Engineer, Building Department, Bhavnagar Municipal Corporation, Bhavnagar invites bids for the construction of works detailed in the table. The bidders may submit bids for any or all of the following works.

TABLE

Package No.	Name of work	Estimated Cost of Works (Rs.)	Bid Security (EMD) (Rs.)	Cost of Document (Tender Fee)	Period of completion	Class of Registration of Contractors & Special Category Building
1	2	3	4	5	6	7
1	CONSTRUCTION OF NEW PHC IN THE AREA OF BHAVNAGAR CITY, KUMBHARWADA, BHAVNAGAR	Rs. 3,10,17,210.00 (Without GST)	Rs. 3,10,200.00 DD or FDR (except SBI) only	Rs. 6000/- + 1080/- (18% GST) = 7080/-	24 (Twenty four) Months	"A" Class or Above

- Prospective / Interested bidder may download the Bid Documents from **Dt. As per NIT till 00:00 Hours** website <https://www.tender.nprocure.com> free of cost till the Time and Date as mentioned on online NIT at website <https://www.tender.nprocure.com>.
- However, Bidder who is submitting the Bid Online will have to pay the Bid Document Fee / Tender Fee through Demand Draft only of any Schedule Bank payable **at Bhavnagar and in favor of Commissioner, Bhavnagar Municipal Corporation.** Once the Bid is received online, Bid Document / Tender Fee will not be refundable.

The Demand Draft for Bid Document / Tender fee and FDR / Bank Guarantee against Bid Security / EMD shall be submitted in electronic format through online (by scanning) while uploading the bid, this submission shall mean that bid document / tender fee and Bid Security / EMD has been received. Accordingly, the offer of only those shall be opened whose Bid Document / Tender Fee and Bid Security / EMD have been received electronically. However, for the purpose of realization of Demand Draft, and FDR / Bank Guarantee bidder shall send the same in original through R.P.A.D. so as to reach to **Executive Engineer, Building Dept. Bhavnagar Municipal Corporation (BMC), Bhavnagar**, within stipulated time as per tender NIT.

Penalitive action for not submitting Demand Draft / FDR / Bank Guarantee in original to **Executive Engineer** / Tender Inviting Authority, BMC by bidder shall be initiated.

- Bids received online, will be opened on the time, date and place as specified in the online NIT at website <https://www.tender.nprocure.com> in the presence of the bidders or their authorized representatives, who wish to remain present. If the office happens to be closed on the day of opening of the bids as specified, the bids will be opened on the next working day at the same time and venue.

- A pre bid meeting will be held on **Dt. As per NIT...hrs.** at the office of **Executive**

Engineer, Building Dept.(BMC) at Bhavnagar to clarify the issues and to answer questions on any matter that may be raised at that stage as stated in clause 9.2 of 'instructions to Bidders' of the bidding documents.

6. Bid Security (EMD) is equal to 1% i.e. **3,10,200.00** of Estimated Amount put to bid / tender and should be rounded off to the next thousand rupees.
7. Other Information is as under:
 - A. Agencies can prepare and edit their offers a number of times before the end of the tender submission date and time. After the tender submission date and time, the bidder cannot modify / edit / withdraw their submitted offer in any case. No written or online request in this regard shall be granted.
 - B. Offers in physical form will not be accepted in any case.
 - C. Demand Draft purchased by the other than bidder and issued after the last date of submission of Bids, will not be considered or accepted.
 - D. The cost incurred by the contractor for this offer for clarification or attending discussion, conferences or site visits will not be reimbursed by the Employer or Engineer-in-Charge.
 - E. Conditional tender shall not be accepted.
 - F. Any changes, addition, alternation made in the prescribed form attached with tender are liable to be rejected.
 - G. Any change in format or conditional Bank Guarantee will not be accepted and the bidder will be considered non-responsive.
 - H. All the bidders are instructed to fill in information strictly in accordance with the format given in the checklist / qualification document / tender document.
 - I. It is mandatory for the bidders to supply each and every information as asked strictly in electronic format at appropriate places only.
 - J. Blank / insufficient information shall be treated as nil information and shall result in disqualification.
 - K. Even if the bidder has been qualified in a similar or larger size of project in the past, it shall not be deemed to be a ground / reason for not giving required information for this work / bid.
 - L. Information supplied for earlier projects shall not be considered while evaluation of this bid. The Government will not ask for any other information, unless it is found absolutely necessary by the competent authority.
 - M. If found necessary, the contractor will be intimated for negotiation,

For the works costing up to 7.5 crore (ROAD), 7.0 crore (BUILDING & BRIDGE) kindly refer to SSR-10-2015-17-C dated 03-02-2017

For the works costing under 7.5 crore for Road Works and 7.0 crore for Building and Bridge Works following documents shall be submitted in electronic format only through online by scanning and the (i) Bid Document Fee / Tender Fee (ii) Bid Security / EMD should be sent in original to the Tender opening authority through RPAD, so as to reach the Executive Engineer within 7 days from last day of submission of Bid.

- (i) Bid Document Fee / Tender Fee (**From Bidders A/C Only**)
- (ii) Bid Security / EMD or Valid EMD of Registration of Approved Contractors
- (iii) Registration **Certificate "A" Class or Above**

~~(iv) Registration Certificate of Special Category – Building and Category I / II /~~

~~III~~

- (v) GST Number & PAN Number
- (vi) Solvency Certificate (for current calendar year)
- (vii) A solvency certificate of an Amount of 20% (Twenty Percent) of estimated cost put to tender will have to be produced along with tender. It shall be of Scheduled Bank or Nationalized Bank or Bank Approved for Government business. Solvency Certificate shall have validity of same calendar year as that of date in which tender is issued.
- (viii) Successful Experience Work Completion Form 3A
- (ix) Anti-Blacklisting Affidavit with notarized (On non-judicial Stamp Paper of Rs.300, as per Annexure-7)
- (x) Turnover of Last five year i.e. 2019-20 to 2023-24
- (xi) EPF Registration Number & ESIC Registration Number
- (xii) Bid Capacity
- (xiii) Litigation History

SECTION - 1
INSTRUCTIONS TO BIDDERS
(ITB)

Section 1: Instructions to Bidders

Table of Clauses

	Page No.		Page No.
A. General		D. Submission of Bids	
1. Scope of Bid	9	19. Deleted	20
2. Source of Funds	9	20. Deadline for Submission of Bids	20
3. Eligible Bidders	9	21. Deleted	20
4. Qualification of the Bidder	9	22. Modification and Withdrawal of Bids	20
5. One Bid per Bidder	14		
6. Cost of Bidding	14	E. Bid Opening and Evaluation	
7. Site Visit	14	23. Bid Opening	21
8. Bidders Registration Class & Bldg. Category	14	24. Process to be Confidential	22
B. Bidding Documents		25. Clarification of Financial Bids	22
9. Content of Bidding Documents	15	26. Examination of Bids and Determination of Responsiveness	22
10. Clarification of Bidding Documents	15	27. Deleted	22
11. Amendment of Bidding Documents	16	28. Deleted	23
C. Preparation of Bids		29. Evaluation and Comparison of Financial Bids	23
12. Language of Bid	17	30. Deleted	23
13. Documents Comprising the Bid	17	F. Award of Contract	
14. Bid Prices	17	31. Award Criteria	24
15. Currencies of Bid and Payment	18	32. Employer's Right to Accept any Bid and to Reject any or all Bids	24
16. Bid Validity & Bid Security	18	33. Notification of Award and Signing of Agreement	24
17. Alternative Proposals By Bidders	19	34. Performance Security	24
18. Format and Signing of Bid	19	35. Advance Payment and Security	25
		36. Deleted	25
		37. Corrupt or Fraudulent Practices	25

A. GENERAL

1. Scope of Bid

- 1.1 The Executive Engineer, Building Dept. Bhavnagar Municipal Corporation (BMC), invites bids for the **Construction Of New PHC In The Area Of Bhavnagar City, Kumbharwada, Bhavnagar** detailed in the table given in IFB. The bidders may submit bids for any or all of the works detailed in the table given in IFB.
- 1.2 The successful bidder will be expected to complete the works by the intended completion date specified in the Contract data.
- 1.3 Throughout these bidding documents, the terms 'bid' and 'tender' and their derivatives (bidder/ tenderer, bid / tender, bidding/ tendering, etc.) are synonymous.

2. Source of Funds

2.1 The expenditure on this project will be met from the budget of **Health Department, Govt. of Gujarat / Govt. of India** for centrally sponsored projects.

3. Eligible Bidders

- 3.1 This Invitation for Bids is open to all eligible bidders.
- 3.2 All bidders shall provide in Section 2, Forms of Bid and Qualification Information, a statement that the Bidder is neither associated, nor has been associated, directly or indirectly, with the consultant or any other entity that has prepared the design, specifications, and other documents for the Project or being proposed as Project Manager for the Contract. A firm that has been engaged by the Employer to provide consulting services for the preparation or supervision of the works, and any of its affiliates, shall not be eligible to bid.

4. Qualification of the Bidder

- 4.1 All bidders shall provide in Section 2, Forms of Bid and Qualification Information, a preliminary description of the proposed work method and schedule, including drawings and charts, as necessary. The proposed methodology should include a program of construction backed with equipment planning and deployment duly supported with broad calculations and quality assurance procedures proposed to be adopted justifying their capability of execution and completion of work as per technical specifications, within stipulated period of completion.
- 4.2 Deleted
- 4.3 Deleted
- 4.4 Deleted

#4.5 QUALIFICATION CRITERIA:

Tenderer shall be required to submit the enlisted documents in hard copy along with the Qualification Bid. If documents are insufficient or it does not match the required criteria mentioned below, then the Price Bid of the tenderer shall not be opened.

Mainly tenderer shall fulfill following Technical & Financial pre-qualification criteria as a main contractor. The tenderer shall fulfill the following all points.

The Bidder must have achieved average annual turnover during last three financial years, ending on 31st March 2024, 30% of Estimated cost.

Mainly tenderer shall fulfill following for pre-qualification,

(a) Experience of having successfully completed "similar works" during last 05 years either of the following :

(1a) Three similar completed works, each costing not less than amount equal to 40% of the Estimated Cost.

OR

(2a) Two similar completed works, each costing not less than amount equal to 50% of the Estimated Cost.

OR

(3a) One similar completed works, each costing not less than amount equal to 80% of the Estimated Cost.

Similar work shall mean “

Successful completion of BUILDING WORK in R&B / Govt. / Semi Govt. / PSUs / Government Undertaking / Government Companies DEPARTMENT.”

E. Available Bid Capacity (ABC) - must be more than the estimated tender cost. Note: Available Bid Capacity (ABC) will be derived by the following method. ABC is calculated as $ABC = 2 * A * N - B$

Where,

A = Maximum value of works executed in any one year during the last five years (updated to present price level by applying enhancement factor) taking into account the completed as well as works in progress.

N = Number of years prescribed for completion of the works for which tenders are invited i.e. 12/12 = 1.00

B = Value of existing commitments and on-going work to be completed during that next N year (period of completion of the works for the tenders are invited.)

Note: The statements/certificate showing the value of existing commitments and ongoing works as well as the stipulated period of completion remaining for each of the works listed should be signed by the respective Employer or his authorized representative, not below the rank of an Executive Engineer or equivalent.

F. The cost of materials supplied by the Government / Clients shall not be taken into account for experience purpose.

G. An attested copy of registration with R&B etc. Registration required: "A" class or Above . Bank Solvency of 2024-25, amounting 20% of estimated cost put to tender of any Nationalized / Scheduled Bank except Co-operative Bank.

(Applicable for the works which require Post Qualification)

4.51 Qualification will be based on Applicant's meeting all the minimum pass/ fail criteria regarding the Applicant's general and particular experience, personnel and equipment capabilities and financial positions, as demonstrated by the applicant's responses in the forms attached to the letter of application (~~specified requirement for joint ventures are given under para 4.6 below~~) Subcontractors experience and resources shall not be taken in to account in determining the applicants compliance with the qualifying criteria

To qualify for more than one contract, the applicant must demonstrate having experience and resources sufficient to meet the aggregate of the qualification criteria for each contract given in paragraphs 4.5.4, 4.5.5 and 4.5.9 below

4.52 Base year and Escalation

The base year shall be taken as Current financial year

Following enhancement factors will be used for the costs of works executed and the financial figure to a common base value for works completed in India.

<u>Year</u>	<u>Financial Year</u>	<u>Multiplying factor</u>
Base year of inviting tender	2024-2025	1.00
-1	2023-2024	1.10
-2	2022-2023	1.21
-3	2021-2022	1.33
-4	2020-2021	1.46
-5	2019-2020	1.61

Applicant should indicate actual figures of costs and amount for the works executed by them without accounting for the above-mentioned factors.

In case the financial figures and value of completed works are in foreign currency the above enhanced multiplying factors will not be applied. Instead, the current market exchange rate (State Bank of India BC Selling rate as on the last date of submission of the bid) will be applied for the purpose of conversion of the amount in foreign currency into India rupees.

4.5.3. General Experience.

The Applicant shall meet with the following minimum criteria:

(a) **Annual Turn Over**

Achieved a minimum annual financial turnover (defined as billing for works in progress and completed in all classes of civil engineering construction works only) in any one year, over the last five years of the annual value of contract / contracts applied for.

**Annual Turn Over shall be more than 30 % of project cost (i.e. X)
(for guidance of deriving X the value of X shall be derived by dividing amount put to tender by the time limit expressed in years for the project / work.)**

~~Joint Venture: Lead Partner & Second another Partner only (i.e. 1 (Lead Partner) + 1 (Other Partner))~~

~~For Joint Venture: The Lead Partner must have updated annual turnover not less than Rs. 153.70 Lacs. (51% of X) & remaining Partner must have updated annual turnover not less than Rs. 90.41 Lacs. (30% of X).~~

~~The Joint Venture must collectively have updated annual turnover not less than Rs. 301.38 Lacs. (i.e. X)~~

4.5.4. Personnel Capabilities.

Availability for his work of personnel with adequate experience as required; as per Appendix.

4.5.5. Equipment Capabilities

Based on the studies carried out by the Engineer, the minimum suggested major equipment to attain the completion of works in accordance with the prescribed construction schedule are shown in the Appendix.

The bidders should, however, undertake their own studies and furnish with their bid, a detailed construction planning and methodology supported with layout and necessary drawings and calculations to allow the employer to review their proposals. The numbers, types and capacities of each plant/equipment shall be shown in the proposals along with the cycle time for each operation for the given production capacity to match the requirements.

4.5.6. Financial Position

The Applicant should give undertaking that he has access to, or has available, liquid assets (aggregate of working capital, cash in hand and uncommitted bank guarantees) and / or credit facilities up to **25 percent of the value of the contract / contracts applied.**

4.5.7. The audited balance sheets for the last five years should be submitted, which must demonstrate the soundness of the applicant's financial position, showing long – term profitability including an estimated financial projection for the next two years, if necessary, the employer will make inquiries with the applicant's bankers.

4.5.8. Litigation History

The Applicant should provide accurate information on any litigation or arbitration resulting from contracts completed or under execution by him over the last five years. A consistent history of awards against the Applicant or any partner of a joint venture may result in failure of the applicant.

4.5.9. Disqualification

Even though the applicants meet the above criteria, they are subject to be disqualified if they have:

Made misleading or false representation in the forms, statements submitted, and / or Record of poor performance such as abandoning the work, rescinding of contract for which the reasons are attributable to the non – performance of the contractor; consistent history of litigation awarded against the applicant or financial failure due to bankruptcy. ~~The rescinding of contract of a joint venture on account of reasons other than non – performance, such as Most Experienced partner of joint venture pulling out, court directions leading to breaking up of a joint venture before the start of work, which are not attributable to the poor performance of the contractor will, however, not affect the qualification of the individual partners.~~

**#4.6 JOINT VENTURE: (Maximum 2 Members i.e. 1 Lead & 1 Others)
(Applicable only for estimated project cost of 50 Crore and above)**

4.6.1.— Joint ventures must comply with the following requirement:

(a) — Following are the minimum qualification requirements:

(i) — The lead partner shall meet not less than 51 percent of all criteria given in para 4.5.3 (a) Annual Turn Over 4.5.3 (b) Successful Experience V-I & 4.5.6 above. The joint venture must collectively satisfy the criteria of para 4.5.3 & 4.5.6 above. The experience of the other joint venture partners shall be considered if it is not less than 30 percent of the qualifying criteria in para 4.5.3 & 4.5.6 above.

(ii) — Individually each member must satisfy the requirements of para 4.5.3(a), 4.5.3.(b), 4.5.7, 4.5.8 above and 4.7 below.

(b) — Bid shall be signed so as to legally bind all partners, jointly and severally, and shall be submitted with a copy of the joint venture agreement providing the joint and several liabilities with respect to the contract.

4.6.2. Qualification of a joint venture does not necessarily qualify any of its partners individually or as a partner in any other joint venture. In case dissolution of a joint venture, each one of the constituent firms may qualify if they meet all the qualification requirements, subject to the written approval of the Employer.

4.7. Bid Capacity.

Applicants who meet the minimum qualification criteria will be qualified only if their available bid capacity at the expected time of bidding is more than the total estimated cost of the works. The available bid capacity will be calculated as under:

Assessed Available Bid Capacity = (A*N*2-B), where

A = Maximum value of work executed in any one year during the last five financial years i.e. from 2019-20 to 2023-24 (updated to the price level of the year indicated in appendix) taking into account the completed as well as works in Progress.

B = Value at current price level of the existing commitments and ongoing works to be completed during the next 24 Months (period of completion of work for which bids are invited); and

N = Number of years prescribed for completion of the works for which the bids are invited.

Note :- In Case of joint venture, the available bid capacity will be applied for each partner to the extent of his proposed participation in the execution of the work. Some of the bid capacity of all the member shall be more than 4.7.

4.8 Even though the bidders meet the above qualifying criteria, they are subject to be disqualified if they have:

- Made misleading or false representation in the forms, statements and Attachments the submitted in proof the qualification requirements; and /or
- Record of poor performance such as abandoning the works, not properly completing the contract, inordinate delay in completion, litigation history, or financial failures etc.; and/or
- Participated in the previous bidding for the same work and had quoted unreasonably high bid prices and could not furnish rational justification to the employer.

5. One bid per bidder

5.1. Each bidder shall submit only one bid for one package. A bidder who submits or participates in more than one bid (other than as a subcontractor or in cases of alternatives that have been permitted or requested) will cause all the proposals with the bidder's participation to be disqualified.

6. Cost of Bidding

6.1. The bidder shall bear all costs associated with the preparation and submission of his Bid, and the Employer will in no case be responsible and liable for those costs.

7. Site Visit

7.1. The Bidder, at the Bidder's own responsibility and risk is encouraged to visit and examine the Site of work and its surrounding and obtain all information that may be necessary for preparing the Bid and entering into a contract for construction of the Works.

The costs of visiting the site shall be at the Bidder's own expense.

8. Bidders Registration Class and Building Category

8.1. Registration certificate of R & B Registered in "A" Class or above / Water Resources Department, The contractors, who are registered in appropriate category of C.P.W.D., M.E.S., Railways and Indian State Governments, can also bid provided the bidder produce such registration certificate at the time of bidding and obtain and submit registration in required class & category from the **BUILDINGWORK in R&B /Govt. /Semi Govt. / PSUs / Government Undertaking / Government Companies DEPARTMENT."**

before issue of work order in case they emerge as L-1 Bidder. Bidder will solely be responsible for obtaining and submitting the certificate before issue of work order.

B. BIDDING DOCUMENTS

9. Content of Bidding Documents

9.1 The set of bidding documents comprises the documents listed below and addenda issued in accordance with Clause 10:

Section	Particulars	Volume No.
-	Invitation for Bids	I
1	Instructions to Bidders	
2	Qualification Information, and other forms	
3	Conditions of Contract	
4	Contract Data	
5	Technical Specifications	II
6	Form of Bid	III
7	Bill of Quantities	
8	Securities and other forms	
9	Drawings	IV
10	Documents to be furnished by bidder	V

9.2 Volumes I, II, III and IV are available online and documents to be furnished by the bidder in compliance to section 2 will be prepared by him and furnished as Volume- V in two parts (refer clause 12).

9.3 The bidder is expected to examine carefully all instructions, conditions of contract, contract data, forms, terms, technical specifications, bill of quantities, forms, Annexes and drawings in the Bid Document. Failure to comply with the requirements of Bid Documents shall be at the bidder's own risk. **Pursuant to clause 26 hereof**, bids which are not substantially responsive to the requirements of the Bid Documents shall be rejected.

10. Clarification Bidding Documents

10.1 A prospective bidder requiring any clarification of the bidding documents may notify the Employer in writing or through E-mail at the Employer's address indicated in the invitation to bid. The Employer will respond to any request for clarification which he received earlier than 15 days prior to the deadline for submission of bids. Employer's response will be published on website including a description of the enquiry but without identifying its source.

10.2 Pre-bid meeting

10.2.1. The bidder or his official representative is invited to attend a pre-bid meeting which will take place at the address, venue, time and date as indicated in the NIT.

- 10.2.2. The purpose of the meeting will be to clarify issues and to answer questions on any matter that may be raised at that stage.
- 10.2.3. The bidder shall be required to submit any questions in writing or e-mail to reach the Employer not later than 03 days before the meeting.
- 10.2.4. Minutes of the meeting, including the question raised (Without identifying the source of enquiry) and the responses given will be published without delay on the tender website i.e. www.tender.nprocure.com. Any modification of the bidding documents listed in sub-Clause 8.1 which may become necessary as a result of the pre-bid meeting shall be made by the Employer exclusively through the issue of an Addendum pursuant to Clause 10 and not through the minutes of the pre-bid meeting.
- 10.2.5. Non-attendance at the pre-bid meeting will not be a cause for disqualification of a bidder.

11. Amendment of Bidding Documents

- 11.1. Before the deadline for submission of bids, the Employer may modify the bidding documents by issuing addenda.
- 11.2. Any addendum thus issued shall be part of the bidding documents. The Employer will assume no responsibility for the same.
- 11.3. To give prospective bidders reasonable time in which to take an addendum into account in preparing their bids, the Employer may, at his discretion, extend as necessary the deadline for submission of bids, in accordance with Sub-Clause 20.2 below.

C. PREPARATION OF BIDS

12. Language of the Bid

12.1 All documents relating to the bid shall be in the English language.

13. Documents Comprising the Bid

13.1. The bid to be submitted by the bidder as Volume V of the bid document (refer Clause 8.1) shall be in two separate parts:

Part I shall be named "Technical Bid" and shall comprise

- (i) Bid Security in the form specified in Section 8
- (ii) Qualification Information and supporting documents as specified in Section 2
- (iii) Certificates, undertakings, affidavits as specified in Section 2
- (iv) Any other information pursuant to Clause 4.5 of these instructions
- (v) Undertaking that the bid shall remain valid for the period specified in Clause 15.1

Part II shall be named "Financial Bid" and shall comprise

- (i) Form of Bid as specified in Section 6
- (ii) Priced Bill of Quantities for items specified in Section 7

13.2. The Bidder shall submit the details / information pertaining to each part i.e. technical as well as financial and must be submitted online only.

13.3. Following documents will be deemed to be part of the bid.

Section	Particulars	Volume No.
Invitation for Bids (IFB)		
1	Instruction to Bidders	Volume I
3	Conditions of Contract	
4	Contract Data	
5	Specifications	Volume II
9	Drawings	Volume IV

14. Bid Prices

14.1 The Contract shall be for the whole works as described in Sub-Clause 1.1, based on the priced Bill of Quantities submitted by the Bidder.

14.2 The bidder shall fill in rates and prices and line item total (both in figures and words) for all items of the Works described in the Bill of Quantities along with total bid price

(Both in figures and words). Items for which no rate or price is entered by the bidder will not be paid for by the Bill of Quantities.

14.3 All duties, taxes, and other levies **except GST** payable by the contractor under the contract, or for any other cause shall be included in the rates, prices and total Bid Price submitted by the Bidder. **(GST will be paid extra)**

14.4 Deleted

14.5 The rates and prices quoted by the bidder are subject to adjustment during the performance of the Contract in accordance with the provisions of Clause 47 of the Condition of Contract **(Irrespective of the time limit and Bid Amount)**

15. Currencies of Bid and Payment

15.1 The unit rates and the prices quoted by the bidder shall be entirely in Indian Rupees. All payments shall be made in Indian Rupees.

16. Bid Validity

16.1 Bids shall remain valid for a period of **not less than 180** days from the date of technical bid opened.

16.2 In exceptional circumstances, prior to expiry of the original time limit, the Employer may request that the bidders may extend the period of validity for a specified period. A bidder may refuse the request without forfeiting his bid security. A bidder agreeing to the request will not be required or permitted to modify his bid, but will be required to extend the validity of his security for a period of the extension, and in compliance with Clause 16 in all respects.

#16. Bid Security

16.1. The Bidder shall furnish, as part of his Bid, a Bid security in the amount as shown in column 4 of the table of IFB for this particular work. This Bid security shall be in favor of Employer as named in Appendix and may be in one of the following forms;

a. Bank Guarantee from any scheduled Indian bank, in the format given in Volume III. **(Bank Guarantee is applicable only for Bid Estimated Amount of 01 Crore and above) and Bank** Guarantee of Schedule and Private Banks shall be considered as per GoG Finance Department's Circular No. FD/MSM/e-file/4/2023/0057/D.M.O. Date 21/04/2023 or as per their latest amendment.

b. Fixed Deposit Receipt issued by any Scheduled Indian Bank or a foreign Bank approved by the Reserve Bank of India.

OR

A Valid Bid Security / EMD Exemption Certificate issued by (1) Road & Building Department or (2) Narmada Water Resources, Water Supply and Kalpsar Department of Govt of Gujarat. **Exemption Certificate is applicable only when Registration Certificate of Appropriate Class and Category of Approved Contractors is required as eligible criteria of bidder.**

- 16.2. Bank guarantees (and other instruments having fixed validity) issued as surety for the bid shall be valid for 45 days beyond the validity of the bid. i.e. total validity of $180+45=225$ Days
- 16.3. Any bid not accompanied by an acceptable Bid Security and not secured as indicated in Sub-Clauses 16.1 and 16.2 above shall be rejected by the Employer as non-responsive.
- 16.4. The Bid Security of unsuccessful bidders will be returned within 28 days of the end of the bid validity period specified in Sub-Clause 15.1
- 16.5. The Bid Security of the successful bidder will be discharged when the bidder has signed the Agreement and furnished the required Performance Security.
- 16.6. The bid Security may be forfeited
- (a) If the Bidder withdraws the bid after Bid opening during the period of Bid validity.
 - (b) If the Bidder does not accept the correction of the Bid Price, if any
 - (c) In the case of a successful Bidders, if the Bidder fails the specified time limit to
 - (i) Sign the Agreement; or
 - (ii) Furnish the requirement Performance Security.
 - (d) #If found necessary, the bidder will be intimated for negotiation, He will be intimated maximum three times within the validity period for negotiation, If contractor does not respond in time, his Bid Security (EMD) will be forfeited and his tender will be rejected. Punitive action will be taken on such contractors. (As per GoG R&B Dept's Gr. No. S/22/2017/6369/D, Dt.08/06/2018)

17. Alternative Proposals by Bidders.

- 17.1. Bidders shall submit offers that fully comply with the requirements of the bidding documents, including the conditions of contract (including mobilization advance or time for completion), basic technical design as indicated in the drawing and specifications. Conditional offers or alternative offers will not be considered further in the process of tender evaluation.

18. Format and Signing of Bid

- 18.1. The Bidder shall prepare documents comprising the bid as described in Clause 12 of these Instructions to bidder as the "Technical Bid" and "Financial Bid" in separate parts to be uploaded.

D. SUBMISSION OF BIDS

19. Deleted

20. **Deadline for Submission of the Bids**

20.1. Complete Bids must be received online by the Employer at the tender website specified above not later than the date indicated in appendix.

20.2. The Employer may extend the deadline for submission of bids by issuing an amendment in accordance with Clause 10, in which case all right and obligation of the Employer and the bidders previously subject to the original deadline will then be subject to the new deadline.

21. Deleted

22. **Modification and Withdrawal of Bids**

22.1. Bidders may modify or withdraw their bids online before the deadline prescribed in Clause 20 or pursuant to Clause 23.

22.2. Deleted

22.3. No bid shall be modified or withdrawn after the deadline for submission of Bid.

22.4. Withdrawal or modification of a bid between the deadline for submission of bids and the expiration of the original period of bid validity specified in Clause 15.1 above or as extended pursuant to Clause 15.2 may result in the forfeiture of the Bid security pursuant to Clause 16.

E. BID OPENING AND EVALUATION

23. Bid Opening

- 23.1. The Employer will open all the Bids received including modifications made pursuant to Clause 22, in the presence of the Bidders or their representatives who choose to attend at time, date and the place specified in Appendix in the manner specified in Clauses 20 and 23.3, In the event of the specified date of Bid opening being declared a holiday for the Employer, the Bids will be opened at the appointed time and location on the next workingday.
- 23.2. Deleted.
- 23.3. The "Technical Bid" shall be opened. The amount, form and validity of the bid security furnished with each bid will be announced. If the bid security furnished does not conform to the amount and validity period as specified in the invitation for bid (ref. Column 4 and paragraph 3), and has not been furnished in the form specified in Clause 16, the technical bid will not be opened.
- 23.4. (i) Subject to confirmation of the bid security by the issuing Bank, the bids accompanied with valid bid security will be taken up for evaluation with respect to the Qualification information and other information furnished in part I of the bid pursuant to Clause 12.1.
- (ii) If required, the bidder will be asked in writing to clarify his Qualification Documents with respect to any required clarification.
- (iii) The bidders will respond in not more than 7 days of issue of the clarification letter.
- (iv) Immediately (usually within 3 or 4 days), on receipt of these clarification the Evaluation Committee will finalize the list of responsive bidders whose financial bids are eligible for consideration.
- 23.5. Deleted
- 23.6. At the time of opening of "Financial Bid", the names of the bidders were found responsive in accordance with Clause 23.4(iv) will be announced. The bids of only these bidders will be opened. The responsive Bidders' names, the Bid prices, the total amount of each bid, any discount and such other details as the Employer may consider appropriate, will be announced by the Employer at the opening.
- 23.7. the time of opening of "Financial Bid", the names of the bidders were found responsive in accordance with Clause 23.4(iv) will be announced. The bids of only these bidders will be opened. The responsive Bidders' names, the Bid prices, the total amount of each bid, any discount, and such other details as the Employer may consider appropriate, will be announced by the Employer at the opening.
- 23.8. In case bids are invited for more than one package, the order for opening of the "Financial Bid" shall be in order of Estimated amount of Bids from highest to lowest.
- 23.9. The Employer shall prepare minutes of the Bid opening, including the information disclosed to those present in accordance with Sub-Clause 23.6.

24 Process to be Confidential

24.1 Information relating to the examination, clarification, evaluation, and comparison of Bids and recommendations for the award of a contract shall not be disclosed to Bidders or any other persons not officially concerned with such process until the award to the successful Bidder has been announced. Any effort by Bidder to influence the Employer's processing of Bids or award decisions may result in the rejection of his Bid.

25. Clarification of Financial Bids

25.1. To assist in the examination, evaluation, and comparison of Bids, the Employer may, at his discretion, ask any Bidder for clarification of his Bid, including breakdowns of unit rates. The request for clarification and the response shall be in writing or by e-mail, but no change in the price or substances of the Bid shall be sought, offered, or permitted except as required to confirm the correction of arithmetic errors discovered by the Employer in the evaluation of the Bids.

25.2 Subject to sub-clause 25.1, no Bidder shall contact the Employer on any matter relating to his Bid opening to the contract is awarded. If the Bidder wishes to bring additional information to the notice of the Employer, it should do so in writing.

25.3. Any effort by the Bidder to influence the Employer in the Employer's bid evaluation, bid comparison or contract award decision may result in the rejection of the Bidders' bid.

26. Examinations of Bids and Determination of Responsiveness

26.1 During the detail evaluation of "Technical Bid", the Employer will determine whether each Bid (a) meets the eligibility criteria defined in Clause 3 and 4; (b) has been properly signed; (c) is accompanied by the required securities and; (d) is substantially responsive to the requirements of the Bidding document. During the detailed evaluation of the "Financial Bid", the responsiveness of the bids will be further determined with respect to the remaining bid conditions, i.e., priced bill of quantities, technical specifications, and drawings.

26.2 A substantially responsive "Financial Bid" is one which confirms all the terms, conditions and specifications of bidding documents, without material deviation or reservation. A material deviation or reservation is one (a) which affects in any substantial way the scope, quality, or performance of the Works; (b) which limits in any substantial way, inconsistent with the Bidding documents, the Employer's rights or the Bidder's obligations under the Contract; or (c) whose rectification would affect unfairly the competitive position of other Bidders presenting substantially responsive Bids.

26.3 If a "Financial Bid" is not substantially responsive, it will be rejected by the Employer, and may not subsequently be made responsive by correction or withdrawal of the non-conforming deviation or reservation.

27. Deleted

28. Deleted

29. Evaluation and Comparison of Financial Bids

- 29.1. The Employer will evaluate and compare only the Bids determined to be substantially responsive in accordance with Sub-Clause 26.2.
- 29.2. Deleted.
- 29.3. The Employer reserves the right to accept or reject any variation or deviation. Variation and deviations and other factors, which are in excess of the requirements of the Bidding documents or otherwise result in unsolicited benefits for the Employer, shall not be taken in to account in Bid evaluation.
- 29.4. The estimated effect of the price adjustment conditions under Clause 47 of the Conditions of Contract, during the period of implementation of the Contract, will not be taken in to account in Bid evaluation.
- 29.5. If the Bid of the successful Bidder is seriously unbalanced in relation to the Engineer's estimate of the cost of work to be performed under the contract the Employer may require the Bidder to produce detailed consistency of those prices with the construction methods and schedule proposed. After evaluation of the price analyses, the Employer may require that the amount of the performance security set forth in Clause 34 be increased at the expense of the successful /bidder to a level sufficient to protect the Employer against financial loss in the event of default of the successful Bidder under the Contract.
- 29.6. A bid which contains several items in the bill of Quantities which are unrealistically priced low and which cannot be substantiated satisfactorily by the bidder may be rejected as non-responsive. (Applicable for item rate tender only)

30. Deleted

F. AWARD OF CONTRACT

31. Award Criteria

31.1. Subject to Clause 32, the Employer will award the contract to the Bidder whose Bid has been determined.

- (i) to be substantially responsive to the Bidding documents and who has offered the lowest evaluated Bid Price; and
- (ii) to be within the available bid capacity adjusted to account for his bid price which is the lowest evaluation in any of the packages opened earlier than the one consideration.

In no case, the contract shall be awarded to any bidder whose available bid capacity is less than the evaluated bid price, even if the said bid is the lowest evaluated bid. The contract will in such cases be awarded to the next lowest bidder at his evaluation bid price.

32. Employer's Right to Accept any Bid and to Reject any or all Bids

32.1. Notwithstanding Clause 31, the Employer reserves the right to accept or reject any Bid, and to cancel the Bidding process and reject all Bids, at any time prior to the award of contract, without thereby incurring any liability to the affected bidder or Bidder or any obligation to inform the affected Bidder or Bidders of the grounds for the Employer's action.

33. Notification of Award and Signing of Agreement

33.1. The Bidder whose Bid has been accepted will be notified of the award by the Employer prior to expiration of the Bid validity period by cable, telex or facsimile confirmed by registered letter. This letter (hereinafter and in the condition of contract called the "Letter of Acceptance") will state the sum that the Employer will pay the Contractor in consideration of the execution, completion, and maintenance of the Works by the Contractor as prescribed by the Contract (hereinafter and in the Contract called the "Contract Price").

33.2 The notification of award will constitute the formation of the contract, subject only to the furnishing of a performance security in accordance with the provisions of Clause.

33.3. The Agreement will incorporate all agreements between the Employer and the successful Bidder. It will be signed by the Employer and to the successful Bidder, within 28 days following the notification of award along with the Letter of Acceptance. Within 21 days of receipt, the successful Bidder will sign the Agreement and deliver it to the Employer.

33.4. Upon the furnishing by the successful Bidder of the Performance Security, the Employer will promptly notify the other Bidders that their Bids have been unsuccessful.

34. Security Deposit

(Total 5.0% of contract value, This will be deposited as under)

Initial S.D. @ 2.50% of contract value 2.50% of contract value

(Not less than EMD) in cash or in the

In the form of pay order/DD/FDR/Bank

Guarantee (From the Nationalized Bank

Encashable at BHAVNAGAR Only)

To be deducted from current bill at: 2.50% of contract value
10.00% to buildup remaining 2.50%
Of SD value

Total deposite at 5.00% of contract 5.00% of contract value
Value

B. Performance Gurantee

Performance Gurantee @5.00% of actual work amount in form of F.D.R. of Nationalized or Scheduled bank / N.S.C. / Narmada bond pledged in favour of Commissioner, Municipal Corporation, Bhavnagar. (To be submitted on completion of work & before final payment) Performance gurantee will be released after defect liability period is over.

~~34 Performance Security~~

~~34.3. (A) Within 10 (Ten) days of receipt of Letter of Acceptance, the successful Bidder shall furnish to the Employer an irrevocable and unconditional guarantee from a Bank in the form set forth in Section 8 (the "Performance Security") for an amount equal to 5% (five percent) of its Contract Price. In case of bids mentioned below, the successful Bidder, along with the Performance Security, shall also furnish to the Authority an irrevocable and unconditional guarantee from a Bank in the same form given at Section 8 towards an Additional Performance Security (The "Additional Performance Security") for an amount calculated as under:~~

~~(a) If the Contract Price offered by the Selected Bidder is lower than 10% but upto 20% of the Estimated Project Cost, then the Additional Performance Security shall be calculated @ 20% of the difference in the (i) Estimated Project Cost (as mentioned in Bid Document) Minus 10% of the Estimated Project Cost and (ii) Contract Price offered by the selected Bidder.~~

~~(b) If the Contract Price offered by the Selected Bidder is lower than 20% of the Estimated Project Cost, then the Additional Performance Security shall be calculated @ 30% of the difference in the (i) Estimated Project Cost (as mentioned in Bid Document) Minus 10% of the Estimated Project Cost and (ii) Contract Price offered by the selected Bidder.~~

~~(c) This Additional Performance Security shall be treated as part of the Performance Security.~~

~~(B) The Performance Security shall be valid beyond 60 (sixty) days of the Defects Liability Period and the Additional Performance Security shall be valid beyond 28 (twenty eight) days of Project Completion Date.~~

~~34.4. If the performance security is provided by the successful Bidder in the form of a Bank Guarantee, it shall be issued either (a) at the Bidder's option, by a Nationalized/Scheduled Indian bank or (b) by a foreign bank located in India and acceptable to the Employer. As per GoG Finance Department's Circular No. FD/MSM/e file/4/2023/0057/D.M.O. Date 21/04/2023 or as per their latest amendment.~~

~~34.5. Failure of the successful Bidder to comply with the requirement of Sub Clause 34.1 shall constitute sufficient grounds for cancellation of the award and forfeiture of the Bid Security.~~

35 Advance Payment and Security

35.1 The Employer will provide an Advance payment on the Contract Price as stipulated in the Conditions of Contract, subject to maximum amount, as stated in the Contract Data.

36. Deleted

37. Corrupt or Fraudulent Practices

37.1 The Employer will reject a proposal if it determines that the Bidder recommended for award has engaged in corrupt or fraudulent practices in completing for the contract in question and will declare the firm ineligible, either indefinitely or for a stated period of time, to be awarded a contract with National Highways Authority of India/ State PWD and any other agencies, if it at any time determines that the firm has engaged in corrupt or fraudulent practices in completing for the contractor, or in execution.

37.2 Furthermore, Bidders shall be aware of the provision stated in Sub- Clause 59.2 of the Conditions of Contract.

APPENDIX TO ITB

Clause Reference With respect to Section -I

1.	The Name of the Employer is Commissioner Shree, Bhavnagar Municipal Corporation.	[Cl.1.1]
2.	The last five/Seven years.	
	2023 – 2024	
	2022 – 2023	
	2021 – 2022	
	2020 – 2021	
	2019 – 2020 2018 – 2019 2017 – 2018	
3.	This Annual Financial Turnover Amount is Rs.	[Cl.4.5.3 (a)]
4.	Value of Work is Rs. 3,10,17,210.00 (Without GST)	
5.	Deleted	
6.	The cost of electric work is Rs. 25,17,310.87 The cost of CCTV work is Rs. 1,45,279.00	
7.	The cost of Fire safety works is Rs. 14,72,534.55	
8.	Liquid assets and / or availability of credit facilities(i.e.25%of contract value/ estimated cost) is Rs. 77.39 Lacs.	[Cl.4.5.6]
9.	Price level of the financial year 2024-25	[Cl. 4.5.2]
10.	The pre-bid meeting will take place at	[Cl. 10.2]
11.	The technical Bid will be opened at the office of the..... ondt.As per NIT	
12.	Address of the Employer: 2 nd Floor, Office of the Executive Engineer, Building Department, Sir Mangalsinhji road, Municipal Corporation Bhavnagar, Main office building, Bhavnagar 364001	
13.	Deleted	
14.	The bid should be submitted latest by As stated on online NIT	[Cl. 20.1 & 20.2]
15.	The bid will be opened at Dt. As stated on online NIT	[Cl. 23.1]
16.	The Bank Draft in favour of 'Commissioner Shree, Bhavnagar Municipal Corporation.	
17.	Deleted	
18.	Escalation factors (for the cost of works executed and financial figure to a common base value) for works completed	[Cl.4.5.2]

<u>Year</u>	<u>Financial Year</u>	<u>Multiplying factor</u>
Base year of inviting tender	2024-2025	1.00
-1	2023-2024	1.10

-2	2022-2023	1.21
-3	2021-2022	1.33
-4	2020-2021	1.46
-5	2019-2020	1.61

#LIST OF KEY PLANT & EQUIPMENT TO BE DEPLOYED ON CONTRACT WORK

[Reference CL. 4.5.5]

The contractors shall also give a list of machineries in his possession and which they propose to use on the work.

Sr. No.	Plant or Machinery	Nos.	Location	Age of Machinery (maximum 15 years)	Make	Capacity	Approximate Value	Remark
1	2(a)	2(b)	2(c)	3	4	5	6	7
1	Tipper Trucks							
2	Concrete mixer with integral way batch facility							
3	Needle Vibrator							
4	Surface Vibrator							
5	Diesel Generator							
6	Concrete Conveying System and Trolley							
7	Excavator							
8	Steel/ Wooden shuttering (Scaffolding, props)							
9	Concrete breaker							
10	Surveying Equipment (Total Station & Other)							
11	Welding machine							
12	Bar Bending and Cutting machines							
13	Goods lift for							
14	Water tanker							

List of Key Personnel to be deployed on Contract Work (Reference Cl. 4.5.4)

Employment of a qualified site Engineer by the Contractor.

The Contractor shall employ full-time technically qualified staff during the execution of this work as under: -

1. Two graduate Civil Engineers and three diploma Civil Engineers when cost of the work to be executed is more than Rs.50 lakhs.
2. One graduate & two Diploma, Civil Engineers when the cost of the work to be executed is more than Rs.15 lakhs but less than Rs.50lakhs.
3. Minimum one Diploma Civil Engineer when the cost of work is less than Rs.15 lakhs but more than Rs.5lakhs.
4. Minimum two Diploma Civil Engineers for the work when the cost of work to be executed is less than Rs. 5 lakhs. The Engineer so employed for the Government work must have sufficient experience to handle the work independently. Such an Engineer shall have to stay at the site of work and he shall not be entrusted with other duty except thiswork.

Within 15 days of issue of work-order the Contractor will have to furnish to the Deputy Executive Engineer-in-charge of the work the Name, Qualifications, copy of marksheet, Colour Photograph and the appointment order issued such engineers engaged for this contract work. If 15 days after issue of work order such designated Site Engineers do not resume or do not remain present on site of work, the recovery at the rate of Rs.15,000-00 per month per Engineer will be made from the bills/deposit/dues of the contractor. Such recovery shall be non-refundable.

SECTION - 2
QUALIFICATION INFORMATION

QUALIFICATION INFORMATION

The information to be filled in by the Bidder in the following pages will be used for the purpose of post qualification as provided for in Clause 4 of the Instruction to Bidders. This information will not be incorporated in the Contract.

1. For Individual Bidders

1.1 Constitution or legal status of Bidder
(Attach Copy)

Place of registration _____

Principal place of business _____

Power of attorney of signatory of Bid
(Attach)

1.2 Total value of Civil engineering constructions Work performed in the last five/seven years (in Rs. Lakhs)

Year	Work done value (in Rs. Lakhs)	Supporting documents certified by CA
2019-20		
2020-21		
2021-22		
2022-23		
2023-24		

1.3.1 ~~Work performed as prime contractor, work performed in the past as a nominated sub-contractor will also be considered the sub-contract involved execution of all main items of work described in the bid documents, provided further that all other qualification criteria are satisfied (in the same name) on works of a similar nature over the last five years** and in current year before the submission of the bid.~~

Project Name	Name of the Employer	Description of work	Contract No.	Value of contract (Rs. Crore)	Date of issue of work order	Stipulated period of completion	Actual date of completion*	Remark explaining reasons for delay & work Completed

* Attach certificate(s) from the Engineer(s) in charge

** Immediately preceding the financial year in which bids are received.

Preferably standard - 3-A certificate issued by various government authority/ if work is private it should be by employer and private work should be supported by TDS work order, final bill payment, work order and as instructed in ITB.

#1.3.2 Quantities of work executed as prime contractor, work performed, in the past as a nominated sub-contractor, will also be considered provided the sub-contract involved execution of all main items of work described in the bid document, provided, further that all other qualification criteria are called (in the same name and style) in the last five years** and in current year before the submission of the bid.

Year	Name of the work	Name of the Employer	Quantity of work performed (Cum/MT)				Remarks* (indicate contract Ref)
			Cement Concrete (Including RCC & PCC)	Masonry	Earth Works	Bituminous Work	
2023-2024							
2022-2023							
2021-2022							
2020-2021							
2019-2020							

1.4 Information on Bid Capacity (works for which bids have been submitted and works which are yet to be completed) as on the date of this bid.

(A) Existing commitments and on-going works:

Name of Building/Hospital works	Place & State	Contract No.	Name & Address of Employer	Value Contract (Rs. Cr)	Stipulated Period of Completion	Value of Works* remaining to be completed (Rs. Cr)	Anticipated of completion	Remarks
1	2	3	4	5	6	7	8	9

* Attach certificate (s) from the Engineer(s) in-charge

** Immediately preceding the financial year in which bids are received.

1.5 Availability of key items of Contractors Equipment for carrying out the works (Ref. Clause 4.5.5). The Bidder should list all the information requested below.

Sr. No.	Plant or Machinery	Nos.	Location	Age of Machinery (maximum 15 years)	Make	Capacity	Approximate Value	Remark
1	2(a)	2(b)	2(c)	3	4	5	6	7

- 4.6 Qualifications and experience of key personnel required for administration and execution of the contract. Attach biographical data. Refer also to Sub Clause 9.1 of the Conditions of Contract.

Bidder should propose the structure and composition of the team dedicated for carrying out the Assignment. Bidder should list the main disciplines of the assignment, the key personnel responsible, and proposed technical and support staff. The personnel schedule shall be consistent with the approach and methodology, detailed work plan, activity schedule.				
Sr. No	Position	No. Of Resources	Min Qualification	Deployment
Key Personal				

1.7 Proposed sub-contract and firmsinvolved

Sections of the works	Value of Sub-Contractor	Sub-Contractor (Name& Address)	Experience in similar work

Attach copies of certificates on possession of valid license for executing water supply/ sanitary work/ building electrification works.

- 1.8 Financial reports for the last five years: balance sheets, profit and loss statements, auditors' reports (in case of companies/corporations), etc. List them below and attachcopies.
- 1.9 Evidence of access to financial resources to meet the qualification requirements: cash in hand, lines of credit, etc. List them below and attach copieddocuments.
- 1.10 Name, address, and telephone, mobile number and Email ID of the Bidders bankers who may provide references if contacted by theEmployer.
- 1.11 Information on Litigation history in which the Bidder isinvolved.

Other Party (ies)	Employer	Cause of Dispute	Amount Involved	Remarks showing Present Status

1.12. ~~Statement of compliance under the requirements of Sub Clause 3.2 of the instruction to Bidders. (Name of Consultant engaged for project preparations*)~~

1.13 Proposed work method and schedule. The Bidder should attach descriptions, drawings and charts as necessary to comply with the requirements of the Bidding documents. (Refer ITB Clause4.1)

- 1 Key Plan
- 2 Sectional Elevation
- 3 Campus Layout
- 4 Water Supply & Sewage Points
- 5 Any other

1.14 Programme

2. Deleted

3. Additional Requirements

3.1 Bidders should provide any additional information required to fulfill the requirements of Clause 4 of the Instructions to the Bidders, if applicable.

- (i) Affidavit
- (ii) Undertaking

* Fill the name of consultant

**SAMPLE FORMAT FOR EVIDENCE OF ACCESS TO OR
AVAILABILITY OF CREDIT FACILITIES**

(CLAUSE 4.5.6 OF

ITB)BANK

CERTIFICATE

ThisistocertifythatM/s._____ is a reputed company
with a good financialstanding.

If the contract for thework,namely_____ is awarded to the
above firm, we shall be able to provide overdraft/credit facilities to the extentof
Rs._____ to meet their working capital requirements for executing the above
during the contractperiod. **Estimated Cost**

(Signature)

Name of Bank

Senior Bank Manager

Address of the Bank

APPENDIX – A

(Form No. 3 A) (Self attested)

Referred to in Rules No. 1.3.1

DETAILS OF SIMILAR WORK COMPLETED

1. Name of Contractor :
2. Name of Work :
3. Estimated cost of Work put to tender :
4. Revised Estimated Cost :
5. Tender Amount :
6. Date of Starting the Work :
7. Date of completion of the work (As per contract agreement) :
8. Actual date of the Completion of work :
9. Amount of Actual completion of the total project :
A) Electrical Work cost:

10. State whether the details as above given by the contractor are correct if not state as to what is the correct information :
11. State whether the contractor has executed the work in progress. Satisfactory as per specification if not give the correct position of the work. :
12. Period rate & amount of compensation if levied. :
13. Period of extension granted if any :
14. Reason for delay in granted if any :
15. Any other remarks :

Particulars of work completed :

Date :

-Authorized Signature-

ANNEXURE - C

Format: Joint Venture

Referred to in Rules No. 4.6

(1) The Joint Venture Agreement made and entered into at _____ day of _____ (year) by _____ and between _____.

a. Firm A (Name with address of the registered office)

b. Firm B (Name with address of the registered office)

(2) **Definitions:** In this deed the following words and expressions shall have the meaning set out below:

a. "The Authority" shall mean Project Implementation Unit, Gandhinagar.

b. "The Works" shall mean

(Name of work) which is more particularly _____ described in the pre-qualification and tender documents issued thereof by the Authority.

c. The Tender "shall" mean the tender to be submitted by Joint Venture to the Authority for the work/works.

d. "The Contract" shall mean the contract entered/to be entered into between the Joint Venture and the Authority for the works.

(3) **Joint Venture (JV)**

The Parties hereto declare that they have agreed to form a Joint Venture for the purpose of submitting the pre-qualification Application/tender document initially and then tender and if successful for the execution of the works as an integrated Joint Venture. The parties are not under this agreement entering into any permanent partnership of Joint Venture to tender or undertake any contract other than the subject works. Nothing herein contained shall be considered to constitute the parties or partners to constitute either Party the agent of the other.

(4) **Witnesses:** Whereas Project Implementation Unit, Gandhinagar / Authority has invited tenders from intending bidders and the Authority has permitted a group of firms (not exceeding three) forming a Joint Venture to be eligible to be a bidder. And whereas _____ party of the first part, _____ party of the second part and _____ party of the third part are desirous to enter into a Joint Venture in the nature of partnership engaged in the joint undertaking for the specific purpose of execution of the work of constructing _____ and whereas Parties of the First, Second and Third part reached understanding to submit pre-qualification/tender, if pre-qualified, and to execute the contract if awarded;

This agreement witnesses as follows:

(a) The parties do not enter into an agreement of any permanent partnership of Joint Venture to tender or undertake any Contract other than the specified above;

(b) That the operation of this Joint Venture firm concerns and is confined to the work of _____ of Authority.

(c) The name of the Joint Venture firm for convenience and continuity shall be.....

(d) The Address of Joint Venture for communications shall be as under:

.....
.....
.....
.....

(e) The Joint Venture shall jointly submit pre-qualification application on the above name according to all terms and conditions stated in the relevant instructions contained in the bid documents.

(f) That this Joint Venture shall regulate the relations between the parties thereto and shall include without being limited to them the following conditions.

(1) _____ firm shall be the lead company in charge of the Joint Venture for all intents and purpose.

(2) In case the said work is awarded to the Joint Venture, the partners of the Joint Venture _____ will nominate a person with duly _____ notarized power of Attorney on stamp paper, who will represent the Joint Venture with the authority to incur liabilities, receive instructions and payments, sign and execute the contract for and on behalf of the Joint Venture.

(i) All the (Maximum two) parties agree to make financial participation and to place at disposal of Joint Venture the benefits of its individual experience, technical knowledge skill and shall in all respect bear its share as regards planning and execution of the work and responsibilities including the provision of information, advice and other assistance required in the Joint Venture and participation shall be in proportion of Firm-A.....% and Firm-B.....%

(ii) All rights, interests, liabilities, obligations work experience and risks (and all net profits or net losses) arising out of the contract shall be borne by the parties in proportion to their shares. Each of the parties shall furnish its proportionate share in any bonds, guarantees, sureties required for the works as well as its proportionate share in connection with the works. The share and participation of the two/three partners in working capital and other financial requirements shall be in ratio as mentioned above.

(5) Internal responsibilities and liabilities

(a) The division of individual scope of work may be worked out mutually by the parties but the party shall be jointly and severally liable to the Authority for the whole work.

(b) The parties specifically undertake to carry out their separate works in full compliance with the contract with the Authority. Each party shall be responsible jointly and severally for consequences if any arising out of defective or delayed execution of works which fall within the individual's party's area of responsibility and/or it has been caused due to acts and/or omission of the concerned party.

(c) The parties jointly and severally agree to replace modify or repair any defect in their respective portions of works in accordance with the terms and condition of the Contract with the Authority.

(d) The parties jointly and severally shall indemnify and hold harmless to each other against any claim made by the Authority or any other third party for injury,

damage, _____ loss _____ or expenses is attributed to the breach/non-performance of his responsibilities by the indemnifying party in accordance with the agreements and/or Contract with the Authority.

(e) None of parties have joined in any other Joint Venture for the said works.

(6) Responsibilities and liabilities of Joint Venture towards the Authority

(a) Parties hereto shall be jointly and severally liable and responsible for the acts, deeds and things done or omitted to be done in respect of the execution of the Contract and for any financial liability arising therefrom.

(a) Parties hereto shall be jointly and severally responsible to the Authority for the execution of the works in accordance with the Contract Conditions;

(c) Parties hereto shall be jointly and severally indemnifying to the Authority against any claim made against the Authority or any other third party for any injury, damage or loss which may be attributed to the breach of the obligations under the Contract pursuant to the Contract.

(7) Site management

(a) The execution of the work on the site will be managed by a Project Manager appointed _____ by the Joint Venture and who will report to the _____ (JV). The Project Manager shall be authorized to represent the Joint Venture on site in respect of matters arising under the Contract.

(b) The _____ (Name of the JV) shall be jointly and severally liable to the Authority for the execution of the Contract commitment in respect of the works in accordance with Contract Conditions.

(8) Termination of the Agreement

This agreement shall be terminated in the following circumstances.

(a) The Authority awards the contract for the work to the other Bidder.

(b) The Authority cancels the work to award the contract.

(c) On completion of the defect liability period as stipulated in the Contract Agreement of the works and all the liabilities thereof are liquidated.

(9) No partner has right to assign any benefits, obligation of liability under the agreement to any third party without prior written consent of the other partner as well as Authority.

(10) Financial matter

(a) Bank Account in the name of the Joint Venture will be opened with any scheduled or nationalized Bank to be operated by an individual signatory as decided mutually by the Joint Venture partners.

(b) All the partners shall be responsible to maintain or cause to maintain proper Books of accounts, balance sheet and profit and loss account as to the state of affairs of the firm as at the end of the financial year and as to the profit and loss made or incurred by the firm for the year ended on that date, respectively shall be prepared and the same shall be subject to audit by a Chartered Accountant.

(c) None of the party shall be entitled to make any borrowing on behalf of the Joint Venture without express prior written consent of the other party.

(d) Bank guarantee for the application/execution of the work shall be provided jointly

from a bank acceptable to the Authority.

(11) Negotiation: Any negotiation of agreement between the parties hereto and the Authority subsequent to the submission of the tender and prior to award, shall take place only with consent of each of the parties who shall be represented at the such negotiation by one or more representative(s) duly empowered to make such negotiation or agreement.

(12) Legal jurisdiction: All questions relating to validity interpretation of this agreement shall be governed by the law of India and shall be subject to jurisdiction of High Court at Ahmedabad.

(13) Settlement of disputes: Any dispute in interpretation of any condition mentioned herein shall be referred to an arbitrator/tribunal by mutual consent of the partners and such proceedings shall be governed by Gujarat Public Works contract disputes tribunal act of 1992 and as amended from time to time. The award of arbitrator shall be final and binding on the party hereto. Neither the obligation of each party hereto the performance of contract nor the execution of work shall stop during the course of arbitration proceeding or as a result thereof.

(14) Insurance

(a) The Joint Venture through the parties individually shall take such insurance in connection with the work in accordance with the tender condition as acceptable to the Authority.

(b) The cost of the insurance premium paid by the Joint Venture shall be borne and paid by the parties in proportion to their respective shares of work. Other insurance taken individually by the parties shall be fully borne by the respective parties.

(15) No change shall be made this agreement without prior written consent of the Authority and other party. However the Authority directs the parties to make changes in the agreement so as to fulfil tender conditions the parties discuss with Authority and mutually agreed such changes required to be made in the agreement.

(16) Default and withdrawal from the Joint Venture: in case that either party fails to observe the provision stipulated in this agreement withdrawal from the Joint Venture, Loss and/or expenses incurred by other party due to such default and/or withdrawal shall be fully compensated by the party who has defaulted.

(17) All matter relating to or arising due to this agreement shall be treated as confidential and shall not be disclosed to any other party.

In witness whereof the parties have caused their duly authorized representatives to sign below.

Signed for and on behalf of Firm - A

Date

Seal & Sign

Witness

Signed for and on behalf of Firm - B

Date

Seal & Sign

Witness

AFFIDAVIT

1. I, the undersigned, do hereby certify that all the statements made in the required attachments are true and correct.

2. The undersigned also hereby certifies that neither our firm M/s. _____
_____ have not abandoned any work of Government of Gujarat/Government of India/any Board or Corporation under Government of Gujarat/Government of India nor any contract awarded to us for such works have been rescinded, during last five years prior to the date of this bid.

3. The undersigned hereby authorize(s) and request (s) any bank, person, firm or corporation to furnish pertinent information deemed necessary and requested by the Department to verify this statement or regarding any (our) competence and general reputation.

4. The Undersigned understands and agrees that further qualifying information may be requested, and agrees to furnish any such information at the request of the Department/ Project implementing agency.

(Signed by an Authorized Officer of the Firm)

Title of Officer

Name of Firm

Date

UNDERTAKING

I, the undersigned do hereby undertake that our firm
M/s would invest a minimum cash
up to 25% of the value of the work during implementation of the contract.

(Signed by an Authorized officer of the firm)

Title of officer

Name of firm

DATE

SECTION - 3
CONDITIONS OF CONTRACT

Conditions of Contract

Table of Contents

A	General	Page No.	D.	Cost Control	
1	Definitions	72	37	Bill of Quantities	83
2	Interpretation	73	38	Changes in the Quantities	83
3	Language and Law	74	39	Variations	83
4	Engineer's Decisions	74	40	Payments for Variations	83
5	Delegations	74	41	Cash Flow Forecasts	84
6	Communications	74	42	Payment Certificates	85
7	Sub-Contractors	74	43	Payments	85
8	Other Contractors	74	44	Compensations Events	85
9	Personnel	75	45	Tax	86
10	Employer's & Contractor Risk	75	46	Currencies	86
11	Employers Risks	75	47	Price Adjustment	86
12	Contractor's Risk	75	48	Retention	86
13	Insurance	75	49	Liquidated damages	87
14	Site Investigations Reports	76	50	Bonus	88
15	Queries about the Contract	76	51	Advance Payment	88
16	Contractors to Construct the works	76	52	Securities	89
17	The Works to be Completed By the Intended Completion Date	76	53	Deleted	89
18	Approval by the Engineer	76	54	Cost of Repair	89
19	Safety	76			
20	Discoveries	77			
21	Possession of the Site	77	E.	Finishing the Contract	
22	Access to the Site	77	55	Completion	90
23	Instructions	77	56	Taking Over	90
24	Disputes	77	57	Final Account	90
				Operating and Maintenance manuals	90
25	Procedure for Disputes	78			
26	Deleted	78	58	Terminations	90
			59	Payment upon Terminations	91
B.	Time Control		60	Property	92
27	Programme	79	61	Release from Performance	92
28	Extensions of the Intended completion date	79			
29	Deleted	79	F.	Special Conditions of Contract	
30	Delays Ordered by The Engineer	79	62	Labour	93
			63	Compliance with labour regulations	93
31	Management Meetings	80	64	Arbitration	96
32	Early Warning	80			
C.	Quality Control				
33	Identifying Defects	81			
34	Tests	82			
35	Correction of Defects	82			
36	Uncorrected Defects	82			

CONDITIONS OF CONTRACT

A. GENERAL

1. Definitions

- 1.1 Terms which are defined in the Contract Data are not also defined in the Conditions of Contract but keep their defined meaning.

Bill of Quantities means the priced and completed Bill of Quantities forming part of the Bid

Compensation Events are those defined in Clause 44 hereunder

The **Completion Date** is the date of completion of the Works as certified by the Engineer in accordance with Sub Clause 55.1

The Contract is the contract between the Employer and Contractor to execute, complete and maintain the Works **till the completion of Defects Liability Period**. It consists of the documents listed in Clause 2.3 below.

The **Contract data** defines the documents and other information which comprise the Contract.

The **Contractor** is a person or corporate body whose Bid to carry out the Work has been accepted by the Employer.

The **Contractor's Bid** is the completed Bidding document submitted by the Contractor to the Employer and includes Technical and Financial Bids.

The **Contract Price** is the price stated in the Letter of Acceptance and thereafter as adjusted in accordance with the provisions of the Contract.

Days are calendar days: **months** are calendar months.

The **Defects Liability Period** is the period named in the Contract Data and calculated from the Completion Date.

The **Employer- BMC**

On behalf of the Bhavnagar Municipal Corporation, The Executive Engineer, Building Department, Municipal Corporation, Bhavnagar is in charge of the works and one of the persons for contract signing authority.

The Engineer is the person named in the Contract Data (or any other competent person appointed and notified to the contractor to act in replacement of the Engineer) who is responsible for supervising the Contractor, administering the Contract, certifying payments due to the Contractor, issuing and valuing Variations to the Contract, and valuing the Compensations Events under the control of **Executive Engineer**.

Equipment is Contractor's machinery and vehicles brought temporarily to the site to construct the Works.

The **Initial Contract Price** is the Contract Price listed in the Employer's Letter of Acceptance.

The **Intended Completion Date** is the date on which it is intended that the Contractor shall complete the Works. The Intended Completion Date is specified in the Contract Data. The Intended Completion Date may be revised only by the Engineer by issuing an extension of time.

Materials are all supplies, including consumables, used by the contractor for incorporation in the works.

Plant is any integral part of the work which is to have mechanical, electrical, electronic or chemical or biological functions.

The **Site** is the area defined as such in the Contract Data.

Site Investigation Reports are those which were included in the Bidding documents and are factual interpretive reports about the surface and subsurface conditions at the site.

Specifications means the Specifications of the works included in the Contract and any modification or addition made or approved by the Engineer.

The **Start Date** is given in the Contract Data or Indicating in Work Order. It is the date when the Contractor shall commence execution of the works. It does not necessarily coincide with any of the Site Possession Dates.

A **Subcontractor** is a person or corporate body who has a Contract with the Contractor to carry out a part of the work in the Contract which includes work on the Site.

Temporary Works are works designed, constructed, installed, and removed by the Contractor which are needed for construction or installation of the Works.

A **Variation** is an instruction given by the Engineer, which varies the Works.

The **Works** are what the Contract requires the Contractor to construct, install, and turn over to the Employer, as defined in the Contract Data.

2. Interpretation

2.1 In interpreting these Conditions of Contract, singular also means plural, male also means female or neuter and the other way around. Heading have no significance. Words have their normal meaning under the language of the Contract unless specifically defined. The Engineer will provide instructions clarifying queries about Conditions of Contract.

2.2 If sectional completion is specified in the Contract Data, references in the Conditions of Contract to the Works, the Completion date, and Intended Completion Date apply to any Section of the Works (other than references to the Completion Date and Intended Completion date for the whole works)

2.3 The documents forming the Contract shall be interpreted in the following order of priority

- (1) Agreement
- (2) Letter of Acceptance, notice to proceed with works
- (3) Contractor's Bid

- (4) ContractData
- (5) Conditions of Contract including Conditions ofContract
- (6) Specifications
- (7) Drawings
- (8) Bills of quantitiesand
- (9) Any other document listed in the Contract Data as forming part of the Contract.

3. Language andLaw

- 3.1 The language of the Contract and the law governing the Contract are stated in the ContractData.

4. EngineersDecisions

- 4.1 Except where otherwise specifically stated, the Engineer will decide contractual matters between the Employer and the Contractor in the role representing theEmployer.

5. Delegation

- 5.1 The Engineer may delegate any of his duties and responsibilities to other people after notifying the Contractor and may cancel any delegation after notifying theContractor.

6. Communications

- 6.1 Communications between parties which are referred to in the conditions are effective only when in writing. A notice shall be effective only when it is delivered (in terms of Indian Contract Act).

7. Sub-Contracting

- ~~7.1 The Contractor may subcontract any portion of work, up to a limit specified in contract data, with the approval of the engineer but may not assign the Contract without the approval of the Employer in writing. Subcontracting shall not alter the Contractor's obligations. **Sub contracting of supply or specific items of work is not allowed.**~~

- 7.2 The sub-contractor must be registered in appropriate class and category for the part of work to besubcontracted.

8. OtherContractors

- 8.1 The Contractor shall cooperate and share the Site with other contractors, public authorities, utilities and the Employer between the dates given in the Schedule of other Contractor. The Contractors shall as refer to in the Contract Data, also provide facilities and services for them as described in the Schedule. The employer may modify the schedule of other contractors and shall notify the contractor of any suchmodifications.

9. Personnel

9.1 The Contractor shall employ the key personnel named in the Schedule of Key Personnel as referred to in the Contract Data to carry out the functions stated in the Schedule or other personnel approved by the Engineer. The Engineer will approve any proposed replacement of key personnel only if their qualifications, abilities, and relevant experience are substantially equal to or better than those of the personnel listed in the Schedule.

9.2 If the engineer asks the Contractor to remove a person who is a member of the Contractor Staff or his work force stating the reasons the Contractor shall ensure that the person leaves the Site within seven days and has no further connection with the work in the Contract.

10. Employer's and Contractors Risks

10.1 The Employer carries the risk which these Contract states are Employer's risks, and the Contractor carries the risks which these Contracts states are Contractors risk.

11. Employer's Risks

11.1 The employer is responsible for the excepted risks which are (a) in so far as they directly affect the execution of the Works, the risks of war, hostilities, invasion, act of foreign enemies, rebellion, revolution, insurrection or military or usurped power, civil war, riot commotion or disorder (unless restricted to the Contractor's employees), and contamination from any nuclear fuel or nuclear waste or radioactive toxic explosive.

12. Contractor's Risks

12.1 All risks of loss of or damages to physical property and of personal injury and death which arise during and in consequence of the performance of the Contract other than the excepted risks are the responsibility of the Contractor.

13. Insurance

13.1 The Contractor shall provide, in the joint names of the Employer and the Contractor, insurance cover from the Start date to the end of the Defects Liability Period, in the amounts and deductibles stated in the Contract data for the following events which are due to the Contractor's risks:

- (a) Loss of or damage to the works, Plant and materials,
- (b) Loss of or damage to Equipment
- (c) Loss of or damages of property (except the Works, Plant, Materials and Equipment) in connection with the Contract; and
- (d) Personal injury or death.

13.2 Policies and certificates for insurance shall be delivered by the Contractor to the Engineer for the Engineer's approval before the Start Date. All such insurance shall provide for compensation to be payable in the types and proportions of currencies required to rectify the loss or damage incurred.

- 133 If the Contractor does not provide any of the policies and certificates required, the Employer may affect the insurance which the Contractor should have provided and recover the premiums the Employer has paid from payments otherwise due to the Contractor or, if no payment is due, the payment of the premiums shall be a debt due.
- 134 Alterations to the terms of an insurance shall not be made without the approval of the Engineer.
- 135 Both parties shall comply with any conditions of the insurance policies.

14. Site Investigation Report

- 14.1 The Contractor in preparing the Bid shall rely on any site Investigation reports referred to in the Contract Data, supplemented by any information available to the Bidder.

15. Queries about the Contract data

- 15.1 The engineer will clarify queries on the Contract Data

16. Contractor to Construct the Works

- 16.1 The Contractor shall construct and install the works in accordance with the specification and Drawings.

17. The Works to be completed by the Intended Completion Date

- 17.1 The Contractor may commence execution of the Works on the Start Date and shall carry out the Works in accordance with the programme submitted by the Contractor, as updated with the approval of the Engineer, and complete them by the Intended Completion date

18. Approval by the Engineer

- 18.1 The Contractor shall submit Specifications and Drawings showing the proposed Temporary works to the Engineer, who is to approve them if they comply with the Specifications and drawings.
- 18.2 The Contractor shall be responsible for design of temporary works.
- 18.3 The Engineer's approval shall not alter the contractor responsibility for design of the Temporary works.
- 18.4 The Contractor shall obtain approval of third parties to the design of the Temporary works where required.
- 18.5 All Drawings prepared by the Contractors for the execution of the temporary or permanent work are subject to prior approval by the Engineer before their use.

19. Safety

- 19.1 The Contractor shall be responsible for the safety of all activities on the Site.

20. Discoveries

20.1 Anything of historical or other interest or of significant value unexpectedly discovered on the site is the property of the Employer. The contractor is to notify the engineer of such discoveries and carry out the Engineer's instructions for dealing with them.

21. Possession of the Site

21.1 The Employer shall give possession of all parts of the site to the Contractor. If possession of a part is not given by the date stated in the Contract Data the Employer is deemed to have delayed the start of the relevant activities and this will be a Compensation Event.

21.2 If within 25% of the time limit of the project, 80% of possession of the site is not handed over to the Contractor, then contractor/ Employer may fore-close the contract. Contractor/Employer has to foreclose the work within as decided by Employer. after lapse of 25%-time limit and after 30 days foreclosure option will be closed.

22. Access to the Site

22.1 The Contractor shall allow the Engineer and any person authorized by the Engineer access to the Site, to any place where work in connection with the Contract is being carried out or is intended to be carried out and to any place where materials or plants are being manufactured/ fabricated/ assembled for the works.

23. Instructions

23.1 The Contractor shall carry out all instructions of the Engineer pertaining to works which comply with the applicable laws where the site is located.

23.2 The Contractor shall permit the Employer to inspect the Contractor's accounts and records relating to the performance of the Contractor and to have them audited by auditors appointed by the Employer, if so required by the Employer.

24. Disputes

24.1 If the Contractor is of the view that a decision taken by the Engineer was either outside the authority given to the Engineer by the Contract or that the decision was wrongly taken, the decision shall be referred to **#Commissioner, BMC** Higher Authority within 30 days of the notification of the Engineer's decision. If the issue is not resolved, any party can refer the matter for conciliation within 30 days from the decision given by the **#Commissioer, BMC** Higher Authority

24.2

(a) For any of the parties is not satisfied with the decision of the **#Commissioner, BMC**, both the parties have to refer to the OSD or DMC or Municipal Commissioner **#Commissioner, BMC** for the conciliation process.

~~(b) For the work more than Rs.250 Cr., if any of the parties is not satisfied with the decision of the #Chief Engineer, both the parties have to refer to the #Secretary, Roads & Building Department, Government of Gujarat for the conciliation process.~~

If the dispute is not resolved through the conciliation process, he may refer the dispute to Competent Authority of BMC .

If the dispute is not resolved by the Employer, he may refer to Gujarat Public Works Contract Dispute Arbitration Tribunal. If the Contractor fails to refer a claim / dispute to the Higher Authority within 14 days of the notification of the Engineer's decision, the Contractor shall not be entitled to any additional payment/claim if he doesn't follow the above sequence in stipulated time and he should not stop the work.

25. Procedure for Disputers

- 25.1 The arbitration shall be conducted in accordance with the arbitration procedure stated in the Special Conditions of Contract.

26. Deleted

B. TIMECONTROL

27. Programme

- 27.1 Within the time stated in the Contract Data the Contractor shall submit to the Engineer for approval a Programme showing the general methods, arrangements orders, and timing for all the activities in the works along with monthly cash flowforecast.
- 27.2 An update of the Programme shall be a programme showing the actual progress achieved on each activity and the effect of the progress achieved on the timing of the remaining work including any changes to the sequence of theactivities.
- 27.3 The Contractor shall submit to the Engineer, for approval an updated programme at intervals no longer than the period stated in the Contract data. If the Contractor does not submit an updated programme within this period, the Engineer may withhold the amount stated in the Contract data from the next payment after the date on which the overdue programme has been submitted.
- 27.4 The Engineer's approval of the programme shall not alter the Contractor's obligations. The Contractor may revise the programme and submit it to the Engineer again at any time. A revised programme is to show the effect of Variations and Compensationevents.

28. Extension of the Intended CompletionDate

- 28.1 The Engineer shall extend the Intended Completion Date if a compensation Event occurs or a Variation is issued which makes it impossible for completion to be achieved by the Intended Completion Date without the Contractor taking steps to accelerate the remaining work and which would cause the Contractor to incur additionalcost.
- 28.2 The Engineer shall decide whether and by how much to extend the Intended Completion Date within 35 days of the Contractor asking the Engineer for a decision upon the effect of a compensation event or Variation and submitting full supporting information. If the Contractor has failed to give early warning of a delay or has failed to cooperate in dealing with a delay, the delay by this failure shall not be considered in assessing the new Intended Completion Date.
- 28.3 The Engineer shall within 14 days of receiving full justification from the contractor for extension of Intended Completion Date refer to the Employer his decision. The employer shall in not more than 21 days communicate to the engineer the acceptance or otherwise of the Engineer's decision. If the employer fails to give his acceptance, the Engineer shall not grant the extension and the contractor may refer the matter under Clause24.1

29. Deleted

30. Delays Ordered by the Engineer

30.1 The Engineer may instruct the Contractor to delay the start or progress of any activity within the works.

31. Management Meetings

31.1 Either the Engineer or the Contractor may require the other to attend a management meeting. The business of a management meeting shall be to review the plans for remaining work and to deal with matters raised in accordance with the early warning procedure.

31.2 The Engineer shall record the business of management meetings and is to provide copies of his record to those attending the meeting and to the Employer. The responsibility of the parties for actions to be taken is to be decided by the Engineer either at the management meeting or after the management meeting and stated in writing to all who attended the meeting.

32. Early Warning

32.1 The Contractor is to warn the Engineer at the earliest opportunity of specific likely future events or circumstances that may adversely affect the quality of the work, increase the Contract price or delay the execution of works. The Engineer may require the contractor to provide an estimate of the expected effect of the future event or circumstance on the contract price and completion date. The estimate is to be provided by the Contractor as soon as reasonably possible.

32.2 The Contractor shall cooperate with the Engineer in making and considering proposals for how the effect of such an event or circumstance can be avoided or reduced by anyone involved in the work and in carrying out any resulting instruction of the Engineer.

C. QUALITYCONTROL

#33. Identifying Defects/ Defect liabilityperiod

33.1 : Defect liability period: The contractor shall be responsible to make good and remedy at his own expense any defect which may develop or may be noticed before the period mentioned hereunder from the certified date of completion. The Engineer in charge shall give the contractor a notice in writing about the defects and the contractor shall make good the same within 15 days of receipt of the notice. In the case of failure on the part of the contractor, the Engineer-in-charge may rectify or remove or re-execute the work at the risk & cost of the contractor. The Engineer-in-charge shall be entitled to appropriate the whole or any part of the amount of security deposit towards the expenses, if any, Incurred by him in rectification, removal or re-execution. The Defects Liability period shall be asunder....

- ~~(a) For all works costing up to Rs. 50,000 (amount put to tender), the period shall be 3 Months from the certified date of completion.~~
 - ~~(b) For all works costing more than Rs. 50,000 and up to Rs. 1 crore (amount put tender), the period shall be 12 (Twelve) months from the certified date of completion or one monsoon, whichever is later.~~
 - (c) For major projects costing more than Rs. 1 crore, the period shall be 36 Months from the certified date of completion which should include three monsoons.
 - ~~(d) For original building works the defect liability period will be 4 years or elapse of 4 monsoon period following date of possession of building taken over by user agency following the certified date of completion, whichever is later.~~
- For the purpose of deciding the monsoon period, the 30th September shall be treated as the last date.

~~33.2 Free maintenance guarantee period for works of building and allied system construction.~~

~~(a) Deleted~~

~~(b) Deleted~~

~~(c) Building and allied system of MGPS, MOT, CSSD, Lift, Electrification, ELV, Water Supply System, Drainage System, HVAC contractor shall maintain in operational condition by repairing, replacing, renovating of any component of building or allied system above as per mention period Cl.33 (D) also contractor shall deploy the qualified manpower for the operation of the system as per requirement~~

However, this amount shall be released against fixed deposit or bank guarantee pledged in the name of Executive Engineer after completion certificate of work is issued.

(1) Deleted

(2) Deleted

(3) Deleted

(4) Deleted

further that such interruption and diversion shall be undertaken by the Contractor only with the prior written approval of the Executive Engineer which approval shall not be unreasonably withheld. For the avoidance of doubt, it is agreed that the Contractor shall at all times be responsible for ensuring safe operation of the road.

33.3 The Engineer shall check the Contractor's work and notify the Contractor of any defects that are found. Such checking shall not affect the Contractor's responsibilities the Engineer may instruct the Contractor to search for a Defect and to uncover and test any work that the Engineer considers may have a Defect.

34. Tests

34.1 If the engineer instructs the Contractor to carry out a test not specified in the Specification to check whether any work has a Defect and the test shows that it does, the Contractor shall pay for the test and any samples. If there is no defect the test shall be a CompensationEvent.

34.2 #1% of the amount of work done should be deducted from R.A. Bill of the contractor for testing the quality of material workmanship, irrespective of actual charges. We may allow testing certificates of GERI or Government approved Lab by R&B Department/ BMC

~~34.3 Agency has to establish testing laboratory on site for the various test to be carried out in the work for this purpose agency shall construct a pukka laboratory building with all facility on site at location specified by the engineer incharge. Penalty as per R&B Circular no. _____ Dt. _____.~~

35. Correction of defects

35.1 The engineer shall give notice to the Contractor of any defects before the end of the defects Liability Period, which begins at Completion and is defined in the contract data. The Defects Liability Period shall be extended for as long as Defects remain to be corrected.

35.2 Every time notice of a Defect is given, the Contractor shall correct the notified defect within the length of time specified by the Engineer's notice.

36. Uncorrected Defects

36.1 If the Contractor has not corrected a defect within the time specified in the Engineer's notice, the Engineer will assess the cost of having the Defect corrected, and the Contractor will pay this amount.

D. COST CONTROL

37. Bill of Quantities

37.1 The bill of Quantities shall contain items for the constructions, installation, testing and commissioning work to be done by the Contractor.

37.2 The bill of Quantities is used to calculate the Contract price. The Contractor is paid for the quantity of the work done at the rate in the Bill of Quantities for each item.

38. Change in the Quantities

38.1 The Engineer shall have power to make any alterations in or addition to the original specifications, drawings, designs and instructions that may appear to him to be necessary or advisable during the progress of the work and the contractor shall be bound to carry out the work in accordance with any instruction in this connection which may be given to him in writing signed by the Engineer and such alteration shall not invalidate the contract and any additional work which the contractor may be directed to do in the manner above specified as part of the work shall be carried out by the contractor on the same conditions in all respects on which he agreed to do the main work and at the same rate as are specified in the tender for the main work.

Except that when the quantity of any item exceeds the quantity as in the tender by more than 130%, the contractor will be paid for the quantity in excess of 130%, at the rate entered in the SOR of the year during which the excess in quantity is first executed.

39. Variations

39.1 All Variations shall be included in updated programmes produced by the Contractor.

40. Payments for Variations

40.1 If the additional or altered work includes any class of work for which no rate is specified in this contract, then such class of work shall be carried out as under.

(i) At the rate derived from the item within the contract which is comparable to the one involving additional or altered class of work; where there are more than one comparable items, the item of the contract which is nearest in comparison with regard to class or classes of the work involved shall be selected and the decision of the **Executive Engineer** as to the nearest comparable item shall be final and binding on the contractor.

(ii) If the rate cannot be derived in accordance with (i) above, such class of works shall be carried out at the rate entered in the Schedule of Rates of the division

for the year in which the tender was received, increased or decreased by the percentage by which the tender amount is more or less as compared to the amount arrived at the rates in the "Schedule of Rates" of the Division in the year in which the tender was received. If the Schedule of rates of the Division does not contain all the items, the percentage increase or decrease of the tender shall be calculated considering such items which were included in the "Scheduled Rates" of the division for the year and for materials consumed on such item the rate to be charged would be the basic rate taken into account for fixing the rate in S.O.R. referred to above.

- (iii) If it is not possible to arrive at the rate from (i) and (ii) above, such class of work shall be carried out at the rate decided by the competent authorities on the basis of detailed rate analysis after hearing the contractor before a Committee of two **Executive Engineer** stationed at the same place or the nearest place.

- 402 If the additional or altered work, for which no rate is entered in the "Schedule of Rates" of the Division is ordered to be carried out before the rate is agreed upon, then the contractor shall within seven days of the date of receipt by him of the order to carry out the work, inform the Engineer-in-charge of the rate, which it is his intention to charge for such class of work and if the Engineer in charge does not agree to this rates, he shall by notice in writing be at liberty to cancel his order to carry out such class of work and arrange to carry it out in such manner as he may consider it advisable, provided always that if the contractor shall commence work or incur any expenditure in regard thereof before the rates shall have been determined as lastly herein before mentioned, then in such cases he shall only be entitled to be paid in respect of the work carried out or expenditure incurred by him prior to the date of the determination of the rate as aforesaid according to such rate or rates as shall be fixed by the Engineer-in-charge. In the event of the dispute, the decision of the **Municipal Commissioner (BMC) shall be final.**

Where, however, the work is to be executed according to the designs, drawings and specifications recommended by the contractor and accepted by the competent authority, the alternation above referred to shall be within the scope of such designs, drawings and specifications appended to the tenders.

The time limit for the completion of the work shall be extended in the proportion that the increase in the cost occasioned by alterations bears to the cost of the original work and the certificate of the Engineer-in-charge as to such proportion shall be final and conclusive.

41. Cash Flow Forecasts

- 41.1 When the programme is updated, the contractor is to provide the engineer with an updated cash flow forecast.

42. Payment certificates.

421 The Contractor shall submit to the Engineer monthly statements of the estimated value of the work completed less the cumulative amount certified previously.

~~422 The Engineer shall check the Contractor's monthly statement within 14 days and certify the amount to be paid to the Contractor after taking in to account any credit or debit for the month in question in respect of materials for the works in the relevant amounts and under conditions set for this sub-clause 32.3 of the Contract Data (secured Advance).~~

423 The value of work executed shall be determined by the Engineer.

424 The value of work executed shall comprise the value of the quantities of the items in the Bill of Quantities completed.

425 The value of work executed shall include the valuation of variations and compensation events.

426 The Engineer may exclude any item certified in a previous certificate or reduce the proportion of any item previously certified in any certificate in the light of later information

43. Payments

431 Payments shall be adjusted for deductions for advance payments, retention, other recoveries in terms of the contract and taxes at source, as applicable under the law. The Employer shall pay the Contractor the amounts certified by the Engineer within 28 days of the date of each certificate.

432 Payment of GST (prevailing rates) on the amount payable under the contract to the Contractor will be made by the Employer.

Hence, it is the responsibility of the contractor to pay the GST to the concerned Authority of Government. We should decide policy for estimate base on R&B SOR other than 2023-24 and other RA items and electrical items.

433 Items of the works for which no rate or price has been entered in will not be paid by the Employer and shall be deemed covered by other rates and prices in the Contract.

44. Compensation events

441 The following are compensation Events unless they are caused by the Contractor:

(a) The Employer does not give access to a part of the Site by the site Possession date stated in Contract data to the Contractor

442 In case of compensation event occurs and it prevents the work being completed beyond the Intended Completion Date then Authority will approve Extension of Time with eligible contractual price escalation.

45. Tax

45.1 The rates quoted by the Contractor must be inclusive of all taxes prevailing on due date of bid submission except GST. However, any subsequent changes in the tax structure by Government after due date of bid submission will be compensated (+/-) on availability or submission of actual documentation. Contractor will have to intimate Engineer regarding changes occurred in the tax structure after bid submission. If the contractor fails to provide such information and if any financial obligation may arise due to change in tax structure, same will be recovered from the contractor.

45.2 GST will be paid separately on the bills. Hence, it is the responsibility of the contractor to pay the GST to the concerned Authority. Ref. 43.2

46. Currencies.

46.1 All payment shall be made in Indian Rupees.

~~47. Price Adjustment~~

~~47.1 Contract price shall be adjusted for increase or decrease in rates and price of labour, materials, fuels and lubricants in accordance with the following principles and procedures and as per formula given in the contract data:~~

~~(a) The price adjustment shall apply for the work done from the start date given in the contract data up to end of the initial intended completion date or extensions granted by the Engineer and shall not apply to the work carried out beyond the stipulated time for reasons attributable to the contractor.~~

~~(b) The price adjustment shall be determined during each month from the formula given in the contract data.~~

~~(c) Following expressions and meanings during to the work done during each month~~

~~R = Total value of work done during the month. It would include the amount of secured advance granted, if any, during the month less the amount of secured advance recovered, if any during the month. It will exclude value for works executed under variations for which price adjustment will be worked separately based on the terms mutually agreed.~~

~~47.2 To the extent that full compensation for any rise or fall in costs to the contractor is not covered by the provisions of this or other clause in the contract, the unit rates and prices included in the contract shall be deemed to include amounts to cover the contingency of such other rise or fall in costs.~~

48. Retention

48.1 The Employer shall retain from each payment due to Contractor the proportion stated in the Contract Data until Completion of the whole of the Works.

- 482 On Completion of the whole of the Works half the total amount retained is repaid to the Contractor and half when the Defects Liability Period has passed and the Engineer has certified that all Defects notified by the Engineer to the Contractor before the end of this period have been corrected.
- 483 On completion of the whole works, the contractor may substitute retention money with an "on demand" Bank guarantee.

In case, Contractor requests for refund of the Retention Money deducted by the Employer under the provision of this clause, Employer shall consider the said request of the Contractor provided that the refund hereunder shall be made in tranches of not less than 1% (One Percent) of the Contract Price and Contractor furnishes an irrevocable and unconditional Bank guarantee for an equal amount substantially in the format of Bank Guarantee for Performance Guarantee enclosed with SBD and valid up to 60 day beyond the scheduled / extended Defects Liability Period. On completion of the whole works, the contractor has however an option to submit a fresh irrevocable and unconditional Bank Guarantee for an amount equal to 5% of the total value of work executed substantially in the format of Bank Guarantee for Performance Guarantee enclosed with SBD and valid up to 60 days beyond the Defect Liability Period and yet refund the Retention Money Bank Guarantee submitted for refund of Retention Money.

49. Liquidated Damages

- 491 The Contractor shall pay liquidated damages to the Employer at the rate per day stated in the Contract Data for each day that the Completion Date is later than the Intended Completion Date (for the whole works or the milestone as stated in the contract data). The total amount of liquidated damages shall not exceed the amount defined in the Contract Data. The Employer may deduct liquidated damages from payment due to the Contractor. Payment of liquidated damages does not affect the Contractor's liabilities.
- 492 If the Intended Completion Date is extended after liquidated damages have been paid, the Engineer shall correct any overpayment of liquidated damages by the Contractor by adjusting the next payment certificate. The Contractor shall not be entitled for any interest on the over payment calculated from the date of payment to the date of repayment.
- 493 If the contractor fails to comply with the time for completion as stipulated in the tender, then the contractor shall pay to the employer the relevant sum stated in the Contract Data as Liquidated damages for such default and not as penalty for everyday or part of day which shall elapse between relevant time for completion and the date stated in the taking over certificate of the whole of the works on the relevant section, subject to the limit stated in the contract data.

The employer may, without prejudice to any other method of recovery deduct the amount of such damages from any monies due or to become due to the contractor. The payment or deduction of such damages shall not relieve

the contractor from his obligation to complete the works on from any other of his obligations and liabilities under the contract.

494 If, before the Time for Completion of the whole of the Works or, if applicable any Section, a Taking Over Certificate has been issued for any part of the Works or of a Section, the liquidated damages for delay in completion of the remainder of the Works or of that Section shall, for any period of delay after the date stated in such Taking-Over-Certificate, and in the absence of alternative provisions in the Contract, be reduced in the proportion which the value of the part so certified bears to the value of the whole of the Works or Section, as applicable. The provisions of this Sub-clause shall only apply to the rate of liquidated damages and shall not affect the limit thereof.

50 — Bonus

501 — If the contractor achieves completion of the whole of the works prior to the intended Completion Date prescribed in Contract Data the Employer shall pay to the contractor a sum stated in Contract Data as bonus for every completed month ~~but subjected to maximum amount as stated in Contract Data;~~ which shall elapse between the date of completion of all items of works as stipulated in the contract, including variations ordered by the Engineer and the time prescribed in Clause 17.

502 — Bonus shall be paid only to works amounting to above INR 5 crore with time limit of the works is equal or more than 6 months. The bonus would be paid as under

% of Time Saved	% of Initial Contract Price entitled for Bonus
50 %	5%
40 %	4%
30 %	3%
20 %	2%
10 %	1%
Less than 10%	0%

51. — Advance Payment.

51.1 — The Employer shall make advance payment (not to be paid less than two installments except in special circumstances for which the reason to be Recorded in writing) to the Contractor of the amounts stated in the Contract Date by the date stated in the Contract Date, against provision by the Contactor of an Unconditional Bank Guarantee in a form and by a bank acceptable to the Employer in amounts and currencies equal to be at least 110% of the advance payment. The guarantee shall remain effective until the

~~advance payment has been repaid, but the amount of the guarantee shall be progressively reduced by the amounts repaid by the Contractor. The Mobilization advance would be deemed as interest bearing advance at an interest rate of 10 % to be compounded, quarterly.~~

~~512 The Contractor is to use the advance payment only to pay for Equipment, plant and Mobilization expenses required specifically for execution of the Works. The Contractor shall demonstrate that advance payment has been used in this way by supplying copies of invoices or other documents to the engineer.~~

~~513 The advance payment shall be repaid by deduction proportionate amount from payments otherwise due to the Contractor, following the schedule of completed percentages of the Works on a payment basis. No account shall be taken of the advance payment or its repayment in assessing valuations of work done, variations, price adjustments, Compensation Events, or Liquidated damages.~~

~~514 Deleted~~

52. Securities

521 The performance Security (including additional security for unbalanced bids) shall be provided to the Employer no later than the date specified in the Letter of Acceptance and shall be issued in an amount and form and by a bank or surety acceptable to the Employer, and denominated in Indian Rupees. The performance Security shall be valid until a date 60 days from the date of expiry of Defects Liability Period and the additional security for unbalanced bids shall be valid until a date 28 days from the date of issue of the certificate of completion.

53. Deleted

54. Cost of Repairs.

541 Loss or damage to the Works or Materials to be incorporated in the Works between the Start date and the end of Defects Correction periods shall be remedied by the Contractor at the Contractor's cost if the loss or damages arises from the Contractor's acts or omissions.

E. FINISHING THE CONTRACT

55. Completion

55.1 The Contractor shall request the Engineer to issue a Certificate of Completion of the works and the Engineer will do so upon deciding that the work is completed.

56. Taking Over

56.1 The Employer shall take over the Site and the Works within seven days of the Engineer issuing a certificate of Completion.

57. Final Account

57.1 The Contractor shall supply to the Engineer a detailed final account of the total amount that the Contractor considers payable as full and final settlement of all claims under the Contract for items before the end of the Defects Liability Period. The Engineer shall issue a Defect Liability Certificate and certify any final payment that is due to the Contractor within 56 days of receiving the Contractor's account if it is correct and complete. If it is not, the Engineer shall issue within 56 days a schedule that states the scope of the corrections or additions that are necessary. If the Final Account is still unsatisfactory after it has been resubmitted, the Engineer shall decide on the amount payable to the Contractor and issue a payment certificate, within 56 days of receiving the Contractor's revised account.

57.2 If reversal in characteristic of tender (L1 becoming L2) on account of excesses and savings in final account is observed, the Engineer/Employer shall be at liberty to restrict the final payment of BOQ items to the lowest amount evaluated of the bids considering the final quantities and the rates quoted including the rebates if any. Payment of variation items shall however be made at the rates approved by the Employer, within 90 days from the physical completion of work. (Applicable for item rate tender only)

Operating and Maintenance Manuals

57.3 If "as built" drawings and/or operating and maintenance manuals are required, the Contractor shall supply them by the dates stated in the Contract data.

57.4 If the Contractor does not supply the Drawings and/or manuals by the dates stated in the Contract data, or they do not receive the Engineer's approval, the Engineer shall withhold the amount stated in the Contract Data from payments due to the Contractor.

58. Termination

58.1 The Employer or the Contractor may terminate the Contract if the other party causes a fundamental breach of the Contract.

582 Fundamental breaches of Contract include, but shall not be limited to the following:

1. The contractor stops work for 28 days when no stoppage of work is shown on the current programme and the stoppage has not been authorized by the Engineer
2. The Engineer instructs the Contractor to delay the progress of the Works and the instructions is not withdrawn within 28 days;
3. The Employer or the Contractor is made bankrupt or goes into liquidation other than for a reconstruction or amalgamation
4. A payment certified by the Engineer is not paid by the Employer to the Contractor within 56 days of the date of the Engineer's certificate
5. The Engineer gives Notice that failure to correct a particular Defect is a fundamental breach of Contract and the Contractor fails to correct it within a reasonable period of time determined by the Engineer;
6. The Contractor does not maintain a security which is required;
7. The Contractor has delayed the completion of works by the number of days for which the maximum amount of liquidated damages can be paid as defined in the Contract data; and
8. If the Contractor, in the judgment of the Employer has engaged in corrupt or fraudulent practices in competing for or in executing the Contract.

For the purpose of this paragraph: "corrupt practice" means the offering, giving, receiving or soliciting of anything of value to influence the action of a public official in the procurement process or in contract execution. "Fraudulent practice" means a misrepresentation of facts in order to influence a procurement process or the execution of a contract to the detriment of the borrower, and includes collusive practice among Bidders (prior to or after bid submission) designed to establish bid prices at artificial non-competitive levels and to deprive the Borrower of the benefits of free and open competition.

583 When either party to the Contract gives notice of a breach of contract to the Engineer for a cause other than those listed under Sub Clause 59.2 above, the Engineer shall decide whether the breach is fundamental or not.

584 Notwithstanding the above, the employer may terminate the Contract for convenience.

59. Payment upon Termination

59.1 If the Contract is terminated because of a fundamental breach of Contract by the Contractor, the Engineer shall issue a Certificate for the value of the work done less advance payments received up to the date of the issue of the

certificate, less other recoveries due in terms of the contract, less taxes due to deducted at source as per applicable law and less the percentage to apply to the work not completed as indicated in the Contract data. Additional Liquidated Damages shall not apply. If the total amount due to the Employer exceeds any payment due to the Contractor the difference shall be a debt payable to the Employer.

- 592 If the Contract is terminated at the Employer's convenience or because of a fundamental breach of Contract by the Employer, the Engineer shall issue a certificate for the value of the work done, the cost of balance material brought by the contractor and available at site, the reasonable cost of removal of equipment, repatriation of the Contractor's personnel employed solely on the works, and the Contractor's cost of protecting and securing the Works and less advance payment received up to the date of the certificate, less other recoveries due in terms of the contract and less taxes due to deducted at source as per applicable law.

60. Property

- 601 All materials on the Site, Plant Equipments, Temporary Works and Works are deemed to be property of the Employer, if the Contract is terminated because of a Contractor's default.

61. Release from Performance

- 61.1 If the Contract is frustrated by the outbreak of war or by any other event entirely outside the control of either the Employer or the Contractor the Engineer shall certify that the Contract has been frustrated. The Contractor shall make the Site safe and stop work as quickly as possible after receiving this certificate and shall be paid for all work carried out before receiving it and for any work carried out afterwards to which commitment was made.

F. SPECIAL CONDITIONS OF CONTRACT

62. LABOUR

The Contractor shall, unless otherwise provided in the Contract, make his own arrangements for the engagement of all staff and labour, local or other, and for their payment of housing, feeding and transport.

The Contractor shall, if required by the Engineer, deliver to the Engineer a return in detail, in such form and at such intervals as the Engineer may prescribe, showing the staff and the numbers of the several classes of labour from time to time employed by the Contractor on the site and such other information as the Engineer may require.

63. COMPLIANCE WITH LABOUR REGULATIONS

During continuance of the contract, the Contractor and his sub-contractor shall abide at all times by all existing labour enactments and rules made thereunder, regulations, notification and bye laws of the State or central Government or local authority and any other labour law (including rules), regulations, bye laws that may be passed or notifications that may be issued under any labour law in future either by the State or the Central Government or the local authority. Salient features of some of the major labour laws that are applicable to the construction industry are given below. The Contractor shall keep the Employer indemnified in case any action is taken against the Employer by the competent authority on account of contravention of any of the provisions of any Act or rules made thereunder, regulations or notifications including amendments. If the Employer is caused to pay or reimburse, such amounts as may be necessary to cause or observe, or for observance of the provisions stipulated in the notifications/bye laws/Acts/Rules/regulations including amendments, if any, on the part of the Contractor, the Engineer/employer shall have the right to deduct any money due to the Contractor including his amount of performance security. The Employer/Engineer shall also have the right to recover from the Contractor any sum required or estimated to be required for making good the loss or damage suffered by the Employer.

The employees of the Contractor and the Sub-Contractor in no case shall be treated as the employees of the Employer at any point to time.

SALIENT FEATURES OF SOME MAJOR LABOUR AND OTHER LAWS APPLICABLE TO ESTABLISHMENTS ENGAGED IN BUILDING AND OTHER CONSTRUCTIONS WORK

- A) **Workmen Compensation Act 1923**:- The Act provides for compensation in case of injury by accident arising out of and during the course of employment.
- B) **Payment of Gratuity Act. 1972**:- Gratuity is payable to an employee under the Act on satisfaction of certain conditions on separation if an employee has completed 5 years service or more on death, the rate of 15 days wages for every completed year of service. The Act is applicable to all establishments employing 10 or more employees.
- C) **Employees P.F. and Miscellaneous Provision Act 1952**:- The Act Provides for monthly contributions by the employer plus workers @ 10% or 8.33% The benefits payable under the Act are:
1. Pension or family pension on retirement or death, as the case maybe.
 2. Deposit linked insurance on the death in harness of the worker.
 3. Payment of P.F. accumulation on retirement/death etc.
- D) **Maternity Benefit Act 1951** :- The Act provides for leave and some other benefits to women employees in case of confinement or miscarriage etc.
- E) **Contract Labour (Regulation & Abolition) Act 1970**: The Act provides for certain welfare measures to be provided by the Contractor to contract labour and in case the Contractor fails to provide, the same are required to be provided, by the Principal Employer by Law. The principal Employer is required to take Certificate of Registration and the Contractor is required to take license from the designated Officer. The Act is applicable to the establishments or Contractor of Principal Employer, if they employ 20 or more contract labour.
- F) **Minimum Wages Act 1948** :- The Employer is supposed to pay not less than the Minimum Wages fixed by appropriate Government as per provisions of the Act, if the employment is a scheduled employment. Construction of Building, Roads, Runways are scheduled employment.
- G) **Payments of wages Act 1936**:- It lays down as to by what date the wages are to be paid, when it will be paid and what deductions can be made from the wages of the workers.
- H) **Equal remunerations Act 1979** :- The Act provides for payment of equal wages for work of equal nature to Male and Female workers and for not making discrimination against female employees in the matter of transfer, training and promotion etc.
- I) **Payments of Bonus Act 1965**:- The Act is applicable to all establishments employing 20 or more employees. The Act provides for payments of annual bonus subject to a minimum of 8.33% of wages and maximum of 20 % of wages to employees drawing Rs. 3500/- per month or less. The bonus to be paid to employees getting Rs. 2500/- per month or above Rs. 3500/- per month shall be worked out by taking wages as Rs. 2500/- per month only. The Act does not

apply to certain establishments. The newly set-up establishments are exempted for five years in certain circumstances. Some of the State Governments have reduced the employment size from 20 to 10 for the purpose of applicability of this Act.

- J) **Industrial Disputes Act 1947** :- The Act lays down the machinery and procedure for resolutions of Industrial disputes, in what situations a strike or lock-out becomes illegal and what are the requirements for laying off or retrenching the employees or closing down the establishment.
- K) **Industrial employment (standing Orders) Act 1946** :- It is applicable to all establishments employing 100 or more workmen (employment size reduced by some of the State and Central Government to 50). The Act provides for laying down rules governing the conditions of employment by the Employer on matters provided in the Act and get the same certified by the designated Authority.
- L) **Trade Unions Act 1926**:-The Act lays the procedure for registration of trade unions of workmen and employers. The Trade Unions registered under the Act have given certain immunities from civil and criminal liabilities.
- M) **Child Labour (Prohibition & Regulation Act 1986** :-The Act prohibits employment of children below 14 years of age in certain occupations and process and provides for regulation of employment of children in all other occupations and processes. Employment of Child labour is prohibited in Building and Construction Industry.
- N) **Inter – State Migrant workmen’s (Regulation of Employment & Conditions of service) Act 1979**:-The Act is applicable to an establishment which employs 5 or more inter-state migrant workmen through an intermediary (who has recruited workmen in one state for employment in the establishment situated in another state).The inter-state migrant workmen, is an establishment to which this Act becomes applicable, are required to be provided certain facilities such as housing, medical aid, traveling expenses from home upto the establishment and back, etc.
- O) **The Building and Other Construction workers (Regulation of employment and Conditions of Service) Act 1996 and the Cess Act of 1996**:-All the establishments who carry on any building or other constructions work and employ 10 or more workers are covered under this Act.
All such establishments are required to pay cess at the rate not exceeding 1% of the cost of construction as may be modified by the government. The Employer of the establishment is required to provide safety measures at the Building or construction work and other welfare measures, such as canteens, First Aid facilities, Ambulance, Housing accommodations for workers near the workplace etc. The Employer to whom the Act applies has to obtain a registration certificate from the Registering Officers appointed by the Government.

- P) **Factories Act 1948** :-The Act lays down the procedure for approval of plans before setting up a factory, health and safety provisions, welfare provisions, working hours, annual earned leave and rendering information regarding accidents or dangerous occurrences to designated authorities. It is applicable to premises employing 10 persons or more with aid of power or 20 or more persons without the aid of power engaged in the manufacturing process.
- Q) **Royalty charges**-The contractor shall pay the royalty to the competent authority as per rule. The **royalty** charges paid shall be borne by the contractor and shall not be reimbursed by the Employer.
- R) **Following Pollution control Acts and amendments made thereof from time to time shall be applicable.**
1. Water (Preservation and control of Pollution) Act, 1974
 2. Air (Prevention and Control of Pollution Act) 1981
 3. Environmental (Protection) Act 1986

The contractor must commit to adopting Environmental management plan for best energy use, waste management, the reduction of pollution as in EMS (Environmental Management system) ISO-14001-2015

64. **ARBITRATION (GCC Clause 24)**

The procedure for arbitration will be as follows: -

- 64.1 If the Contractor is of the view that a decision taken by the Engineer was either outside the authority given to the Engineer by the Contract or that the decision was wrongly taken, the decision shall be referred to # **Executive Engineer** (Higher Authority) within 14 days of the notification of the Engineer's decision. If the issue is not resolved, any party can refer the matter for conciliation within 15 days from the decision given by the # **Executive Engineer**.
- 64.2 If the Contractor is of the view that a decision taken by the Engineer was either outside the authority given to the Engineer by the Contract or that the decision was wrongly taken, the decision shall be referred to # **Executive Engineer** Higher Authority within 30 days of the notification of the Engineer's decision. If the issue is not resolved, any party can refer the matter for conciliation within 30 days from the decision given by the # **Executive Engineer** Higher Authority
- 64.3
- (a) For any of the parties is not satisfied with the decision of the # **Executive Engineer**, both the parties have to refer to the OSD or DMC or Municipal Commissioner **Chief Engineer concern** for the conciliation process.
 - (b) ~~For the work more than Rs.250 Cr., if any of the parties is not satisfied with the decision of the #Chief Engineer, both the parties have to refer to the #Secretary, Roads & Building Department, Government of Gujarat for the conciliation process.~~

If the dispute is not resolved through the conciliation process, he may refer the dispute to Competent Authority of BMC .

If the dispute is not resolved by the Employer, he may refer to Gujarat Public Works Contract Dispute Arbitration Tribunal. If the Contractor fails to refer a claim / dispute to the Higher Authority within 14 days of the notification of the Engineer's decision, the Contractor shall not be entitled to any additional payment/claim if he doesn't follow the above sequence in stipulated time and he should not stop the work.

SECTION - 4
CONTRACT DATA

#CONTRACT DATA

Clause Reference With respect To section 3

Item marked "N/A" do not apply to this Contract.

1. The Employers is [CL.1.1]
Name:Commissioner,Bhavnagar Municipal Corporation
Address: Bhavnagar Municipal Corporation,Bhavnagar
Name of authorized Representative.....
2. The Engineer is Executive Engineer.
Name of Authorized Representative:
3. **The Defects Liability Period is 3 years from the date of completion.** [CL.1.1&33]
4. The Start Date shall be **1st**days for the date of issue of the Notice to proceed with thework. [CL.1.1]
5. The Intended Completion Date for the whole of the works is [CL.1.1,17&2]
24 Monthsafter start of work with the following milestones:
Milestone dates: [CL.2.2& 49.1]
Physical works to be completed Period from the start date
6. The Site is located at**Kumbharwada**, Bhavnagar city [CL.1.1]
7. The name and identification number of the Contract is:..... [CL.1.1]
8. The worksconsistof**Building Work with items asperB.O.Q.**The works shall, inter alia, include the following, as Specified or as directed: [CL.1.1]

~~(A) Road Works Deleted~~

~~Site clearance; setting — out and layout; widening of existing carriageway and strengthening including camber corrections; construction of new road/ Parallel service road; bituminous pavements remodeling/construction of Junctions, intersections, bus bays, lay bays; supplying and placing of drainage Channels, flumes, guard posts and guard other related items; construction/extension of cross drainage works, bridge, approaches and other related stones; protective works for roads/bridge; all aspects of quality assurance of various components of the works; rectification of The defects in the completed works during the Defects Liability Period; submission of "As built" drawings and any other related documents; and other item of work as may be required to be carried out for completing the work in accordance with the drawings and the provisions of the contract and to ensure safety.~~

~~(B) Bridge Works Deleted~~

~~Site clearance; setting out, provision of foundations, piers abutments and bearing; prestressed/reinforced cement concrete superstructure; wearing coat, hand railings, expansion joints, approach slabs, drainages spouts/ drowthake pipes, arrangements for fixing light posts, water mains, utilities etc; provision of suitably designed protective works; providing wing/return walls; provision of road markings, road signs etc.; all aspects of quality assurance; clearing the site and handing over the works on completion; rectification of the defects during the Defects Liability Period and submission of "As-built" drawings and other related documents; and other items of work as may be required to be carried out for completing the works in accordance with the drawings and the provisions of the contract and to insure safety~~

(C) Building Works

[CL.1.1]

(D) Other Items

Any Other Items as required to fulfill all contractual obligations as per the Bid documents.

10. The following documents also form part of the Contract:
_____As per clause 2-3_____ [CL.2.3(9)]
11. The law which applies to the Contract is the law of Union of India [CL.3.1]
12. The language of the Contract documents is English [CL.3.1]
13. Limit of subcontracting 25% of the Initial Contract Price (Not Applicable) [CL.7.1]
14. The Schedule of Other Contractors [CL.8]
15. The Schedule of Key Personnel As per Annex – II to Section I [CL.9]
16. **The minimum insurance cover should be done by the contractor for physical property, injury and death is Rs. 5 lakhs per occurrence** with the number of occurrences limited to four. After each occurrence, the contractor will pay an additional premium necessary to make insurance valid for four occurrences always. [CL.13]
17. Site Investigation report [CL.14]
18. The Site Possession dates shall be actual date of Possession given to the contractor. [CL.21]
19. The period for submission of programme **with BAR CHART** for approval of the engineer shall be **10 days** from the issue of Letter of Acceptance. [CL. 27.1]
20. The period between program updates **will be 60 days.** [CL.27.3]
21. **The amount to be withheld for late submission of each updated programme shall be Rs.0.10 lakhs per day.** [CL. 27.3]

22. The following events shall also be Compensation Events
Substantially adverse ground conditions encountered during the
course of execution of work not provided for in the bidding document.
- (i) Removal of underground utilities detected subsequently
 - (ii) Significant changes in classification of soil requiring
additional mobilization by the contractor, e.g. ordinary soil
to rock excavation,
 - (iii) Removal of unsuitable material like marsh, debris dumps,
etc. not caused by the contractor.

[CL. 44]

- (iv) Artesian conditions
- (v) Seepage, erosion landslide
- (vi) River training requiring protection of permanent work
- (vii) Presence of historical, archeological or religious structures, monuments interfering with the works
- (viii) Restriction of access to ground imposed by civil, judicial, or military authority

23. The currency of the Contract is Indian Rupees [CL. 46]

24. **The formula (e) for adjustment of prices are as under:** [CL.47]

NOT APPLICABLE

~~• If any of the commodities like Cement, Steel or Bitumen are not found applicable in a work, the weight component of that commodities (i.e. 'Cement' (Pc), 'Steel' (Ps) or 'Bitumen' (Pb) as indicated in SBD for the purpose of Price Adjustment) shall be clubbed with the weight component of 'Other Material' (Pm), such that the gross % weight of the components shall remain as 100%.~~

~~R = value of work as defined in Clause 47.1 of Conditions of Contract~~

Adjustment for labour component

(i) Price adjustment for increase or decrease in the cost due to labour shall be paid in accordance with the following formula:

$$V_L = 0.85 \times (P_i/100) \times R \times (L_i - L_0)/L_0$$

~~V_L = Increase or decrease in the cost of work during the month under consideration due to changes in rates for local labour~~

~~L₀ = The consumer price index for industrial workers for the State on 28 days preceding the scheduled date of opening of technical Bids as published by Labour Bureau, Ministry of Labour, Government of India~~

~~L_i = The consumer price index for industrial workers for the State for the month under consideration as published by the Labour Bureau, Ministry of Labour, Government of India.~~

~~P_i = Percentage of labor component of the work.~~

Adjustment for cement component.

(ii) Prices adjustment for increase or decrease in the cost of cement procured by the contractor

$$V_c = 0.85 \times (P_c/100) \times R \times (C_i - C_0)/C_0$$

~~V_c = Increase or decrease in the cost of work during the month under consideration due to changes in rates for cement.~~

~~C₀ = The all India wholesale price index for Ordinary Portland Cement on 28 days preceding the scheduled date of opening of technical bid as published by the **Office of the Economic Adviser, Department for Promotion of Industry and Internal Trade, Ministry of Commerce & Industry.**~~

~~C_i = The all India average wholesale price index for Ordinary Portland Cement for the month under consideration as published by **Office of the Economic Adviser, Department for Promotion of Industry and Internal Trade, Ministry of Commerce & Industry.**~~

~~P_c = Percentage of cement component of the work~~

Adjustment for steel component

(iii) — Price adjustment for increase or decrease in the cost of steel procured by the contractor shall be paid in accordance with the following formula

$$V_s = 0.85 \times (P_s/100) \times R \times (S_i - S_0)/S_0$$

~~V_s = Increase or decrease in the cost of work during the month under consideration due to changes in the rates for steel~~

~~S₀ = The all India wholesale price index for steel (**Mild Steel – Long Products Rebars**) on 28 days preceding the date of opening of Bids as published by the **Office of the Economic Adviser, Department for Promotion of Industry and Internal Trade, Ministry of Commerce & Industry.**~~

~~S_i = The all India average wholesale price index for steel (**Mild Steel – Long Products Rebars**) for the month under consideration as published by **Office of the Economic Adviser, Department for Promotion of Industry and Internal Trade, Ministry of Commerce & Industry.**~~

~~P_s = Percentage of steel component of the work~~

Note : For the application of this clause, the index of **Mild Steel – Long products Rebars** has been chosen to represent the steel group.

Adjustments of bitumen component

(iv) — Price adjustment for increase in the cost of bitumen shall be paid in accordance with the following formula

$$V_b = 0.85 \times (P_b/100) \times R \times (B_i - B_0)/B_0$$

~~V_b = Increase or decrease in the cost of work during the month under consideration due to changes in rates for bitumen.~~

~~B₀ = The official retail price of bitumen at the IOC depot at the nearest centre on the day 28 days prior to the scheduled date of opening of technical bid.~~

~~B_i = The official retail price of bitumen of IOC depot at the nearest centre for the 15th day of the month under consideration.~~

~~P_b = Percentage of bitumen component of the work~~

Adjustment of POL (fuel and lubricant) component

~~(v)~~ Price adjustment for increase or decrease in cost of POL (fuel and lubricant) shall be paid in accordance with the following formula

$$V_f = 0.85 \times (P_f/100) \times R \times (F_i - F_0)/F_0$$

~~V_f~~ = Increase or decrease in the cost of work during the month under consideration due to changes in rates for fuel and lubricants.

~~F₀~~ = The official retail price of High Speed Diesel (HSD) at the existing consumer pumps of IOC at the nearest centre on the day 28 prior to the date of opening of Bids.

~~F_i~~ = The official retail price of HSD at the existing consumer pumps of IOC at the nearest centre for the 15th day of the month of the under consideration.

~~P_f~~ = Percentage of fuel and lubricants component of the work

Note: For the application of this clause, the price of High Speed diesel Oil has been chosen to represent the fuel and lubricants group.

Adjustment for Construction Machinery

~~(vi)~~ Price adjustment for increase or decrease in the cost of plant and Machinery spare procured by the Contractor shall be paid in accordance with the following formula

$$V_p = 0.85 \times (P_p/100) \times R \times (P_i - P_0)/P_0$$

~~V_p~~ = Increase or decrease in the cost of work during the month under consideration due to changes in rates for plant and machinery spares

~~P₀~~ = The all India wholesale price index for **manufacturer of machinery for mining, quarrying and Construction** for the month under consideration as published **Office of the Economic Adviser, Department for Promotion of Industry and Internal Trade, Ministry of Commerce & Industry.**

~~P_i~~ = The all India average wholesale price index for **manufacturer of machinery for mining, quarrying and Construction** for the month under consideration as published **Office of the Economic Adviser, Department for Promotion of Industry and Internal Trade, Ministry of Commerce & Industry.**

~~P_p~~ = Percentage of plant and machinery spares component of the work.

Note: For the application of this clause, index of Heavy Machinery and parts has been chosen to represent the Plant and Machinery Spares group

Adjustment of other materials Component

(vii) ~~Price adjustment for increase or decrease in cost of local materials other than cement, steel, bitumen and POL procured by the contractor shall be paid in accordance with the following formula~~

$$V_m = 0.85 \times (P_m/100) \times R \times (M_i - M_0)/M_0$$

~~V_m = Increase or decrease in the cost of work during the month under consideration due to change in rates for local materials other than cement, steel, bitumen and POL.~~

~~M₀ = The All India wholesale price index (all commodities) on 28 days preceding the scheduled date of opening of technical Bids, as published by the **Office of the Economic Adviser, Department for Promotion of Industry and Internal Trade, Ministry of Commerce & Industry.**~~

~~M_i = The All India wholesale price index (all commodities) for the month under consideration as published by the **Office of the Economic Adviser, Department for Promotion of Industry and Internal Trade, Ministry of Commerce & Industry.**~~

~~P_m = Percentage of local material components (other than cement, steel, bitumen and POL) of the work.~~

~~The following percentage will govern the price adjustment for the entire contract:~~

	Other
	s
Labour P _L %	
Cement P _c %	
Steel P _s %	
Bitumen P _b %	
POL P _f %	
Plant & Machinery Spares P _p %	
Other Materials P _m %	
Total	100 %
	100 %
	100 %

Note 1) Delete

2) for new construction of SDH/DH/Medical Colleges and Other building works % shall be applicable as mentioning tender documents.

~~25. The proportion of payments retained (retention money) shall be 6% {CL-48} from each RA bill subject to a maximum of 5% of final contract price.~~

~~26. Amount of Liquidated damages for delay in completion of works~~ ~~For Whole of work (CL 49)~~
~~(1/2000)*of the Initial contract price, rounded off to the nearest Thousand, per day. For sectional Completion (wherever specified In item 6 of Contract data) (1/2000)*of initial contract price for #5 km Section, rounded off to the nearest thousand per day.~~

~~27. Maximum limit of liquidated damages 10 percent of the Initial (CL. 49)
 For delay in completion work Contract Price rounded off to
 the nearest thousand~~

28. Amount of Bonus for early completion Amount of bonus for early
 completion of work shall be given
 as per CL. 50 of Section-3

29. Maximum limit of bonus for early 5 percent of the Contract (CL. 50)
 Completion of work Price

30. The amount of the advance payment are: {CL. 51 & 52}

# Nature of Advances	Amount (Rs.)	Conditions to be fulfilled
i Mobilization	10% of the contract Price	On submission of unconditional Bank Guarantee. (to be drawn before the end of 20% of the contract period). The contractor may furnish four bank guarantees of 2.5 % of each valid for the full period.
ii Equipment	90% for new and 50% of depreciated value for old equipment. Total amount will be subject to a maximum of 5% of the Contract Price	After equipment is brought to site (provided the Engineer is satisfied That the equipment is required for performance of the contract) and on submission of unconditional Bank Guarantee for amount of advance
iii Secured Advance for Non-persish able material Brought to site	Deleted	

(The advance payment will be paid to the Contractor no later than 28 days after fulfillment of the above conditions).

31. **Repayment of advance payment for mobilization and equipment** {CL. 51.3}

The advance loan shall be repaid with percentage deduction from the interim payments certified by the Engineer under the Contract. Deduction shall commence in the next Interim Payment Certificate following that in which the

total of all such payments to the Contractor has reached not less than 20 percent of the Contract Price or 6 (six) months from the date of payment of first installment of advance, whichever period concludes earlier, and shall be made at the rate of 20 percent ~~(collectively for both Mobilization Advance and Equipment Advance)~~ of the amounts of all Interim Payment Certificate until such time as the loan has been repaid, always provided that the loan shall be completely repaid prior to the expiry of the original time for completion pursuant to Clause 17 and 28.

32. Deleted
33. The securities shall be for the following minimum amounts equivalent {CL. 52}
As a percentage of the Contract Price:
Performance Security for 5 percent of contract price plus Rs. (to be decided after evaluation of the bid) as additional security in terms of ITB Clause 29.5

The standard form of Performance security acceptable to the Employer shall be an unconditional Bank Guarantee of the type as presented in Section 8 of the Bidding Documents.

34. ~~The Schedule of Operating and maintenance Manuals.....N/A.~~ {CL.58}
35. The date by which "as- built" drawings (in scale as directed) in 2 sets {CL. 58} are required within 28 days of the issue of certificate of completion of the whole or section of the work, as the case maybe.
36. The amount to be withheld for failing to supply "as built" drawings {CL. 58} by the Date required is Rs..... Lakhs.
37. The following events shall also be fundamentals breach of contract: {CL.59.2}
"The Contractor has contravened Sub- clause 7.1 and Clause 9 of GCC"
38. The percentage to apply the value of the work not completed representing {Cl 60} the Employer's additional cost for completing the Works shall be 20 percent.

SECTION - 5
TECHNICAL SPECIFICATION

Separate Sheet Attached

SECTION - 6
FORM OF BID

FORM OF BID

Description of the Works:

BID

To :

Address :

- 1. We offer to execute the Works described above and remedy any defects therein in conformity with the conditions of Contract, specification, drawings, Bill of Quantities and Addenda for the sum (s)of

(-----)

- 2. We undertake, if our Bid is accepted, to commence the Works as soon as is reasonably possible after the receipt of the Engineer's notice to commence, and to complete the whole of the Works in the Contact within the time stated in the document.
- 3. We agree to abide by this Bid for the period of 120 Days from the date fixed for receiving the same, and it shall remain binding upon it and may be accepted at any time before the expiration of thatperiod.
- 4. Unless and until a formal Agreement is prepared and executed this Bid, together with your written acceptance thereof, shall constitute a binding contract between us.
- 5. We understand that you are not bound to accept the lowest or any tender you may receive.

Datedthis----- dayof ----- 20

Signature ----- in the capacity of -----

----- duly authorized to sign bids for and on behalf of -----

(in block capitals or typed)

Address

Witness

Address

Occupation

SECTION - 7
BILL OF QUANTITIES

Separate Sheet Attached

BILL OF QUANTITIES

Preamble

1. The bill of Quantities shall be read in conjunction with the Instructions to Bidder, Conditions of Contract, Technical Specifications and Drawings.
2. The quantities given in the Bill of Quantities are estimated and provisional, and are given to provide a common basis for bidding. The basis of payment will be the actual quantities of work ordered and carried out, as measured by the Contractor and verified by the Engineer and valued at the rates and prices tendered in the priced Bill of Quantities, where applicable, and otherwise at such rates and prices as the Engineer may fix within the terms of the Contract.
3. The rates and prices tendered in the priced Bill of Quantities shall, except in so far as it is otherwise provided under the Contract, include all constructional plant, layout, supervision, materials, erection, maintenance, insurance, profit, taxes and duties, together with all general risks, liabilities and obligations set out or implied in the Contract.
4. The rates and prices shall be quoted entirely in Indian Currency.
5. A rate or prices shall be entered against each item in the Bill Quantities, whether quantities are stated or not. The cost of Items against which Contractor has failed to enter a rate or price shall be deemed to be covered by other rates and prices entered in the Bill of Quantities (in case of Item rate contract).
6. The whole cost of complying with the provisions of the Contract shall be included in the items provided in the priced Bill of Quantities, and where no Items are provided the cost shall be deemed to be distributed among the rates and prices entered for the related items of Work.
7. General direction and descriptions of work and materials are not necessarily repeated or summarized in the Bill of Quantities. References to the relevant sections of the contract documentation shall be made before entering rates or prices against each item in the Bill of Quantities.
8. The method of completed work of payment shall be in accordance with the specification for Road and Bridge works. For building works specifications for building are to be followed.
9. Errors will be corrected by the Employer for any arithmetic errors pursuant to **Clause 29** of the Instructions to Bidder.
10. Rock is defined as all materials which, in the opinion of the Engineer, required blasting, or the use of metal wedges and sledgehammers, or the use of compressed air drilling for its removal, and which cannot be extracted by ripping with a tractor of at least 150 kw with a single rear mounted heavy duty ripper.

BILL OF QUANTITIES

(A) Percentage Rate Tender : Separate sheet attached

I/We am/are willing to carry out the work at.....% above/below percent (Should be written in figures and words) of the estimated rate mentioned above. Amount of my /our tender works out as under.

Estimated amount put to tender	Estimated amount put to tender
Deduct.....% below	Add.....% Above
Net	Net
In words	In words

(B) — For Item Rate Tender (For above INR 50Cr.): SOR Year 20__-20__ (Not Applicable)

Item No	Description of Item (with brief specification and reference to book of specifications)	Quantity	Unit	Rate		Amount
				In-figures	In-Words	

(A) Total Tendered Amount

(B) Rebate on above tendered amount (if any) % (in figure)
(in words).....

(C) Net Tendered Amount (A-B) (in figure)
(in words).....

1	The Contractor shall exhibit a board with detailed specification and details of work as directed by the Engineer-In-Charge for which no extra payment shall be made.
2	The labour cess will be deducted as per prevailing rules i.e. 1% of the work done.
3	All taxes and levies as per prevailing norms of Government will be born by the contractor, excluding GST. GST will be paid extra as per prevailing norms for bills.

SECTION - 8
SECURITIES AND OTHER FORMS

BID SECURITY (BANK GUARANTEE)

WHEREAS, ----- (name of Bidder) (hereinafter called the "The Bidder") has submitted his bid Dated ----- (Date) for the construction of ----- (Name of Contractor hereinafter called "the Bid")

KNOW ALL PEOPLE by these presents that We ----- (name of Bank) of ----- (name of country) having our registered office at ----- (hereinafter called "the bank") are bound unto _____ (name of Employer) (hereinafter called "The Employer") in the sum of ----- * for which payment well and truly to be made to the said Employer the Bank itself, his successors and assigns by these presents.

SEALED with the Common Seal of the said Bank this ----- day of ----- 20

THE CONDITIONS of these obligations are:

(1) If after Bid opening the Bidder withdraws his bid during the period of Bid validity specified in the Form of Bid;

Or

(2) If the Bidder has been notified of the acceptance of his bid by the Employer during the period of Bid Validity:

- A Fails or refuses to execute the Form of Agreement in accordance with the Instructions to Bidders, if required; or
- B. Fails or refuse to furnish the Performance Security, in accordance with the Instructions to Bidders; or
- C. does not accept the correction of the Bid Price pursuant to Clause 27 (Correction of Errors)

We undertake to pay to the Employer up to the above amount upon receipt of his first written demand, without the employer having to substantiate his demand, provided that in his demand the Employer will note that the amount claimed by him is due to him owing to the occurrence of one or any of the three conditions, specifying the occurred conditions or conditions.

This Guarantee will remain in force up to and including the date ----- **
days after the deadline for submission of Bids as such the deadline is stated in the
Instructions to Bidders or as it may be extended by the Employer, notice of which
extension (s) to the Bank is hereby waived. Any demand in respect of this
guarantee should reach the Bank not later than the above date

DATE-----

SIGNATURE-----

WITNESS-----

SEAL-----

(Signature, name and address)

* The Bidder should insert the amount of the guarantee in words and figures
denominated in Indian Rupees. This figure should be the same as shown in
Clause 16.1 (Bid Security) of the Instructions to Bidders.

****45 days** after the **end of the validity period** of the Bid. Date should be
inserted by the Employer before the Bidding documents are issued.

PERFORMANCE SECURITY

TO,
Commissioner, Bhavnagar Municipal Corporation (Name of Employer)
....., Bhavnagar. (Address of Employer)

WHEREAS (name and address of contractor) (hereafter called "the Contractor") has undertaken, in pursuance of Contracts No. dates to execute (name of Contract and brief description of Works) (hereinafter called "The Contract")

AND WHEREAS it has been stipulated by you in the said Contract that the Contractor shall furnish you with a Bank Guarantee by a recognized bank for the sum specified therein as security for compliance with his obligation in accordance with the Contract.

AND WHEREAS we have agreed to give the Contractors such a bank Guarantee:

NOW THEREFORE we hereby affirm that we are the Guarantor and responsible to you on behalf of the Contractor, upto a total of (amount of guarantee)* (in words), such sum being payable in types and proportions of currencies in which the Contract price is payable, and we undertake to pay you, upon your first written demand and without cavil or argument, any sum or sums within the limits of (amount of guarantee) as aforesaid without your needing to prove or to show grounds or reasons for your demand for the sum specified therein.

We hereby waive the necessity of your demanding the said debt from the contractor before presenting it with the demand.

We further agree that no change or addition to or other modification of the terms of the Contract to of the Works to be performed thereunder or of any of the Contract documents which may be made between you and the Contractor shall in any way release us from any liability under this guarantee, and we hereby waive notice of any such charge, addition or modifications.

This guarantee shall be valid until 60 days from the date of expiring of the Defect Liabilities period.

Signature and Seal of the guarantor

Name of Bank

Address

Date

*An amount shall be inserted by the Guarantor, representing the percentage the Contract price specified in the Contract denominated in Indian Rupees.

ADDITIONAL PERFORMANCE SECURITY

[Clause 34.1. (A)]

TO,
Commissioner, Bhavnagar Municipal Corporation (Name of Employer)
....., Bhavnagar. (Address of Employer)

WHEREAS (Name and address of contractor) (hereafter called "The Contractor") has undertaken, in pursuance of Contracts No. dates to execute (Name of Contract and brief description of Works) (hereinafter called "The Contract")

AND WHEREAS it has been stipulated by you in the said Contract that the Contractor shall furnish you with a Bank Guarantee by a recognized bank for the sum specified therein as security for compliance with his obligation in accordance with the Contract.

AND WHEREAS we have agreed to give the Contractors such a bank Guarantee:

NOW THEREFORE we hereby affirm that we are the Guarantor and responsible to you on behalf of the Contractor, upto a total of (amount of guarantee) (in words), such sum being payable in types and proportions of currencies in which the Contract prices is payable, and we undertake to pay you, upon your first written demand and without cavil or argument, any sum or sums within the limits of (amount of guarantee) as aforesaid without your needing to prove or to show grounds or reasons for your demand for the sum specified therein.

We hereby waive the necessity of your demanding the said debt from the contractor before presenting is with the demand

We further agree that no change or addition to or other modification of the terms of the Contract to of the Works to be performed thereunder or of any of the Contract documents which may be made between your and the Contractor shall in any way release us from any liability under this guarantee, and we hereby waive notice of any such charge, addition or modifications.

This guarantee shall be valid until **90 days** from the project completion date.

Signature and Seal of the guarantor

Name of Bank

Address

Date

BANK GUARANTEE FOR ADVANCE PAYMENT

TO,

Commissioner, Bhavnagar Municipal Corporation (Name of Employer)
....., Bhavnagar. (Address of Employer)

----- (Name of Contractor)

Gentlemen:

In accordance with the provisions of the Conditions of Contract, sub-clause 51.1 ("Advance Payment") of the above-mentioned Contract, ----- (name and address of Contractor) (hereinafter called "the Contractor") shall deposit with (name of Employer) a bank guarantee his proper and faithful performance under the said Clause of the Contract in an amount of -- (amount of Guarantee)*----- in words).

We, the ----- (bank of financial institution), as instructed by the Contractor, agree unconditionally and irrevocably to guarantee as primary obligator and not as Surety merely, the payment to----- (name of Employer) on his first demand without whatsoever right of obligation on our part and without his first claim to the Contractor, in the amount not exceeding--- ----- (amount of guarantee)* ----- (in words)

We further agree that no change or addition to or other modifications of the terms of the Contractor or Works to be performed thereunder or of any of the Contract documents which may be made between ----- (name of Employer) and the Contractor, shall in any way release us from any liability under this guarantee, and we hereby waive notice of any such change, addition or modifications.

This guarantee shall remain valid and in full effect from the date of the advance payment under the Contract until ----- (name of employer) receives full repayment of the same amount from the contractor.

YOUR'S TRULY

Signature and Seal _____
Name of Bank/Financial Institution _____
Address _____
Date _____

* An amount shall be inserted by that Bank or Financial Institution representing the amount of the Advance Payment, and denominated in Indian Rupees.

Letter of Acceptance

(Letter head paper of the Employer)

To, _____(date)
_____(Name and address of the Contractor)

Dear Sirs,

This is to notify you that your Bid dated _____ for execution of the _____ (Name of the contract and identification number, as given in the Instructions to Bidders) for the Contract Price of Rupees _____ (_____) (amount in words and figures) as corrected and modified in accordance with the Instructions to Bidders* is hereby accepted by our agency.

You are requested to furnish performance security, in the form detailed in para 34.1 of ITB for an amount equivalent to Rs. _____ within **10 days** of the receipt of this letter of acceptance, having Validity up to beyond **90 days** from the date of expiry of defects Liability period i.e. upto _____ and the Additional Performance Security for an amount equivalent to Rs. _____ shall be valid beyond 90 (Ninety) days of Project Completion Date i.e. upto _____ and sign the contract, failing which action as stated in Para 34.3 of ITB will be taken.

Yours Faithfully

Authorized Signature
Name and title of Signatory
Name of Employer

* Delete "Corrected and" or and modified if only one of these actions applies. Delete as corrected and modified in accordance with the Instructions to Bidders, if corrections or modifications have not been affected.

Issue of Notice to proceed with the work

(Letterhead of the Employer)

----- (date)

To,

_____(Name and address of the Contractor)

Dear Sirs,

Pursuant to your furnishing the requisite security in ITB Clause 34.1 and signing of the Contract for the construction of _____

_____ at a bid Price of Rs.

_____.

You are hereby instructed to proceed with the execution of the said works in accordance with the contract documents.

Yours faithfully

**(Signature, name and title of signatory authorized
To sign on behalf of Employer)**

AGREEMENT FORM

This agreement, made on the _____ day of _____ between _____ (name and address of Employer) (Hereinafter called "the Employer) and _____ (name and address of contractor) hereinafter called "the Contractor" of the other part.

Whereas the Employer is desirous that the Contractor execute

Name and identification number of contract (hereinafter called "the works") and the employer has accepted the Bid by the Contractor for the execution and completion of such works and the remedying of any defects therein, at a cost of Rs.

NOW THIS AGREEMENT WITNESSETH AS FOLLOWS

1. In this Agreement, words and expression shall have the same meanings as are respectively assigned to them in the conditions of contract hereinafter referred to and they shall be deemed to form and be read construed as part of this Agreement.
2. In Consideration of the payment to be made by the Employer to the contractor as hereinafter mentioned, the Contractor hereby covenants with the Employer to executive and complete the works and remedy any defects therein in conformity in all aspects with the provisions of the contracts.
3. The employer hereby covenants to pay the Contractor in consideration of the execution and completion of the works and the remedying the defects wherein contract price or such other sum as may become payable under the provisions of the Contract at the times and in the manner prescribed by the contract.
4. The Following documents shall be deemed to form and be ready and construed as part of this Agreement viz
 - i) letter of Acceptance
 - ii) Notice to proceed with the works:
 - iii) Contractor's Bid

- iv) Conditions of contract: General and Special
- v) Contract Data
- vi) Additional conditions
- vii) Drawings
- viii) Bill of Quantities and
- ix) Any other documents listed in the Contract data as forming part of the Contract.

In witness whereof the parties there to have caused this Agreement to be executed the day and year first before written

The Commonseal of _____

Was hereunto affixed in the presence of:

Signed, sealed and Delivered by the said _____

In the presence of

Binding signature of Employer _____

Binding Signature of Contractor _____

UNDERTAKING
(For Investment)

I, the undersigned do hereby undertake that our firm M/s would invest a minimum cash up to **25%** of the value of the work during implementation of the contract.

(Signed by an Authorized officer of the firm)

Title of officer

Name of firm

DATE

UNDERTAKING
(For Validity)

I, the undersigned do hereby undertake that our firm M/s.....
..... agree to abide by this bid for a period..... days
for date fixed for receiving the same and it shall be binding on us and may be accepted at
any time before the expiration of that period.

(Signed by an Authorized officer of the firm)

Title of officer

Name of firm

DATE

SECTION - 9
DRAWINGS

As per attached files in this tender

SECTION - 10

DOCUMENTS TO BE FURNISHED BY BIDDER

Following documents shall be submitted in electronic format only through online by scanning and the (i) Bid Document Fee/ Tender Fee (ii) Bid Security / EMD should be sent in original to the Tender opening authority through RPAD, so as to reach the Executive Engineer within stipulated date in the tender.

- (xiv) Bid Document Fee / Tender Fee **(From Bidder's A/C Only)**
- (xv) Bid Security / EMD ~~or Valid EMD Exemption Certificate of Appropriate Class of Registration of Approved Contractors~~
- (xvi) Registration Certificate: "A" Class or Above State/ Central Govt./Municipal Corporations/P.S.U.
- ~~(xvii) Registration Certificate of Special Category - Building and Category I / II / III~~
- (xviii) GST Number & PAN Number
- (xix) Solvency Certificate (for current calendar year)
- (xx) A solvency certificate of an Amount of 20% (Twenty Percent) of estimated cost put to tender will have to be produced along with tender. It shall be of Scheduled Bank or Nationalized Bank or Bank Approved for Government business. Solvency Certificate shall have validity of same calendar year as that of date in which tender is issued.
- (xxi) Work Experience, FORM 3(A) , should be given by officer not having position below then Executive Engineer.
- (xxii) EPF Registration Number & ESIC Registration Number
- (xxiii) Other Documents, as required...

BHAVNAGAR MUNICIPAL CORPORATION

Name of Work :- Construction Of New PHC In The Area Of Bhavnagar City,Kumbhrwada, Bhavnagar(B.M.C.)

Schedule - B

Item No.	Quantities estimated but may be more or less	Item of work	Unit	Tendered Rates		Total amount according to estimated quantities
				in figures	In Words	
1	680.50	Excavation for foundation upto 1.5 m depth including sorting out and stacking of useful materials and disposing off the excavated stuff upto 50 Meter lead.(A) Loose or soft soil	CMT	117.08	Rupees One Hundred Seventeen and Paise Eight Only	79672.94
2	855.10	Excavation for foundation for depth from 1.5 m to 3.0 m including sorting out and stacking of useful materials and disposing off the excavated stuff upto 50 Meter lead.(A) Loose or soft soil	CMT	128.41	Rupees One Hundred Twenty Eight and Paise Forty One Only	109803.39
3	258.00	Excavation for foundation for depth from 3.00 m to 6.0 m including sorting out and stacking of useful materials and disposing off the excavated stuff upto 50 Meter lead. (C) Hard Murrum	CMT	444.05	Rupees Four Hundred Forty Four and Paise Five Only	114564.90
4	0.16	Clearing and grubbing road land including uprooting rank vegetation grass bushes,shrubs,sapling and trees girth up to 300 mm removal of stumps of trees cut earlier and disposal of unserviceable materials (C) By mechanical means in area of light jungle	Hectare	28393.04	Rupees Twenty Eight Thousand Three Hundred Ninety Three and Paise Four Only	4542.89
5	773.08	Dewatering In all sorts of soil and soft murrum,hard murrum and bulders, soft rock, hard rock up to 1.50 mt depth from G.L.	CMT	17.17	Rupees Seventeen and Paise Seventeen Only	13273.82

Schedule - B						
Item No.	Quantities estimated but may be more or less	Item of work	Unit	Tendered Rates		Total amount according to estimated quantities
				in figures	In Words	
6	217.00	Rammed Rubble soling With Lean Mix cement mortar (CM 1:10) Preferably Joint fill up with lime mortar 1:4 etc. comp.	CMT	2152.31	Rupees Two Thousand One Hundred Fifty Two and Paise Thirty One Only	467051.27
7	67.00	Boring holes 3.5 m deep in ordinary soil (for cast in situ piles) and getting out the soil and disposal of the surplus excavated soil as directed within a lead of 50 Meter for following diameter of pipes.(iii) 300 mm	No.	1486.14	Rupees One Thousand Four Hundred Eighty Six and Paise Fourteen Only	99571.38
8	67.00	Add to or deduct from the rate for Bore Holes of 3.5 m Depth, if bore holes are made deeper or shallower than 3.5M. for Piles of following diameter.(iii) 300 mm (Boring holes beyond 3.5m to 6.0m depth)	No.	531.39	Rupees Five Hundred Thirty One and Paise Thirty Nine Only	35603.13
9	67.00	Extra for under reaming inside the bore Holes for under reamed piles of following Diameter.(iii) 300 mm	No.	632.44	Rupees Six Hundred Thirty Two and Paise Forty Four Only	42373.48
10	212.50	Providing and laying cement concrete 1:2:4 (1- Cement : 2- Coarse sand : 4- graded stone aggregates 20 mm nominal size) and curing complete excluding cost of formwork in (A) Foundation and Plinth	CMT	3697.91	Rupees Three Thousand Six Hundred Ninety Seven and Paise Ninety One Only	785805.88

Schedule - B						
Item No.	Quantities estimated but may be more or less	Item of work	Unit	Tendered Rates		Total amount according to estimated quantities
				in figures	In Words	
11	45.00	Providing and laying controlled cement concrete M.250 and curing complete excluding the cost of formwork and reinforcement for reinforced concrete work in (A) Foundations, footings, Base of columns and Mass concrete.	CMT	4280.42	Rupees Four Thousand Two Hundred Eighty and Paise Forty Two Only	192618.90
12	94.00	Providing and laying controlled cement concrete M250 work with curing etc. complete including the cost of from workbut excluding cost of Reinforcement for RCC work in (A) Foundation footing base of columns and mass concrete.	CMT	4555.34	Rupees Four Thousand Five Hundred Fifty Five and Paise Thirty Four Only	428201.96
13	29.00	Providing and laying controlled cement concrete M250 work with curing etc. complete including the cost of from workbut excluding cost of Reinforcement for RCC work in Column upto Plinth Level.	CMT	7147.33	Rupees Seven Thousand One Hundred Forty Seven and Paise Thirty Three Only	207272.57
14	25.00	Providing and laying controlled cement concrete M250 work with curing etc. complete including the cost of from workbut excluding cost of Reinforcement for RCC work in RCC Wall upto Plinth Level.	CMT	6585.20	Rupees Six Thousand Five Hundred Eighty Five and Paise Twenty Only	164630.00
15	66.00	Providing and laying controlled cement concrete M250 work with curing etc. complete including the cost of from work but excluding cost of Reinforcement for RCC work in Beam. .GB/PB	CMT	6170.94	Rupees Six Thousand One Hundred Seventy and Paise Ninety Four Only	407282.04

Schedule - B						
Item No.	Quantities estimated but may be more or less	Item of work	Unit	Tendered Rates		Total amount according to estimated quantities
				in figures	In Words	
16	24.50	Brick work using common burnt clay building bricks having crushing strength not less than 35 kg./Sq.Cm. in foundation and plinth in Cement Mortar 1:6 (1-Cement : 6 -fine sand)(B) Conventional	CMT	4021.02	Rupees Four Thousand Twenty One and Paise Two Only	98514.99
17	1511.68	Filling available excavated earth (excluding rock) in trenches. plinth, sides of foundations etc. in layers not exceeding 20 cm. in depth consolidating each disposed layer by ramming and watering.	CMT	130.39	Rupees One Hundred Thirty and Paise Thirty Nine Only	197107.96
18	922.00	Filling in foundation and plinth with murrum or selected soil/Garden soil in layers of 20cm. thickness including watering, ramming and consolidating etc. complete.	CMT	289.06	Rupees Two Hundred Eighty Nine and Paise Six Only	266513.32
19	273.00	Applying general insecticide pest control treatment to floors, cupboards etc including labour material etc. complete. Using Heptachloride 20 EC. As Per 6113_pests Concentration Weight 0.50 percent is recommended one litre chemical emulsion dilute with 39 liter of water will give. Total dilute concentration will be 40 litre inclusive of one litre chemical emulsion application 0.5 Litre chemical / Sqm of surface is recommended as per I.S	Sqm	37.23	Rupees Thirty Seven and Paise Twenty Three Only	10163.79

Schedule - B						
Item No.	Quantities estimated but may be more or less	Item of work	Unit	Tendered Rates		Total amount according to estimated quantities
				in figures	In Words	
20	35.00	Providing and laying controlled cement concrete M250 work with curing etc. complete including the cost of formwork but excluding cost of Reinforcement for RCC work in Column (G.F.)	CMT	7147.33	Rupees Seven Thousand One Hundred Forty Seven and Paise Thirty Three Only	250156.55
21	20.00	Providing and laying controlled cement concrete M.250 work with curing etc. complete including the cost of formwork but excluding the cost of reinforcement for RCC work in Column (F.F.)	CMT	7188.02	Rupees Seven Thousand One Hundred Eighty Eight and Paise Two Only	143760.40
22	20.00	Providing and laying controlled cement concrete M.250 work with curing etc. complete including the cost of formwork but excluding the cost of reinforcement for RCC work in Column (S.F.)	CMT	7228.42	Rupees Seven Thousand Two Hundred Twenty Eight and Paise Forty Two Only	144568.40
23	7.00	Providing and laying controlled cement concrete M.250 work with curing etc. complete including the cost of formwork but excluding the cost of reinforcement for RCC work in Column (T.F.)	CMT	7268.82	Rupees Seven Thousand Two Hundred Sixty Eight and Paise Eighty Two Only	50881.74
24	4.00	Providing and laying controlled cement concrete M250 work with curing etc. complete including the cost of formwork but excluding cost of Reinforcement for RCC work in RCC Wall (G.F.)	CMT	6585.20	Rupees Six Thousand Five Hundred Eighty Five and Paise Twenty Only	26340.80

Schedule - B						
Item No.	Quantities estimated but may be more or less	Item of work	Unit	Tendered Rates		Total amount according to estimated quantities
				in figures	In Words	
25	4.00	Providing and laying controlled cement concrete M.250 work with curing etc. complete including the cost of formwork but excluding the cost of reinforcement for RCC work in RCC Wall (F.F.)	CMT	6625.60	Rupees Six Thousand Six Hundred Twenty Five and Paise Sixty Only	26502.40
26	4.00	Providing and laying controlled cement concrete M.250 work with curing etc. complete including the cost of formwork but excluding the cost of reinforcement for RCC work in RCC Wall (S.F.)	CMT	6666.00	Rupees Six Thousand Six Hundred Sixty Six and Paise Zero Only	26664.00
27	3.00	Providing and laying controlled cement concrete M.250 work with curing etc. complete including the cost of formwork but excluding the cost of reinforcement for RCC work in RCC Wall (T.F.)	CMT	6706.40	Rupees Six Thousand Seven Hundred Six and Paise Forty Only	20119.20
28	17.50	Providing and laying controlled cement concrete M250 work with curing etc. complete including the cost of from workbut excluding cost of Reinforcement for RCC work in Lintel/Coping (G.F.)	CMT	6218.57	Rupees Six Thousand Two Hundred Eighteen and Paise Fifty Seven Only	108822.49
29	2.00	Providing and laying controlled cement concrete M250 work with curing etc. complete including the cost of from workbut excluding cost of Reinforcement for RCC work in Lintel/Coping (F.F.)	CMT	6258.97	Rupees Six Thousand Two Hundred Fifty Eight and Paise Ninety Seven Only	12517.94

Schedule - B						
Item No.	Quantities estimated but may be more or less	Item of work	Unit	Tendered Rates		Total amount according to estimated quantities
				in figures	In Words	
30	2.00	Providing and laying controlled cement concrete M250 work with curing etc. complete including the cost of from workbut excluding cost of Reinforcement for RCC work in Lintel/Coping (S.F.)	CMT	6299.37	Rupees Six Thousand Two Hundred Ninety Nine and Paise Thirty Seven Only	12598.74
31	4.00	Providing and laying controlled cement concrete M250 work with curing etc. complete including the cost of from workbut excluding cost of Reinforcement for RCC work in Lintel/Coping (T.F.)	CMT	6339.77	Rupees Six Thousand Three Hundred Thirty Nine and Paise Seventy Seven Only	25359.08
32	24.00	Providing and laying controlled cement concrete M250 work with curing etc. complete including the cost of from workbut excluding cost of Reinforcement for RCC work in Beam (G.F.)	CMT	6497.33	Rupees Six Thousand Four Hundred Ninety Seven and Paise Thirty Three Only	155935.92
33	23.00	Providing and laying controlled cement concrete M250 work with curing etc. complete including the cost of from workbut excluding cost of Reinforcement for RCC work in Beam (F.F.)	CMT	6537.73	Rupees Six Thousand Five Hundred Thirty Seven and Paise Seventy Three Only	150367.79
34	19.00	Providing and laying controlled cement concrete M250 work with curing etc. complete including the cost of from workbut excluding cost of Reinforcement for RCC work in Beam (S.F.)	CMT	6578.13	Rupees Six Thousand Five Hundred Seventy Eight and Paise Thirteen Only	124984.47

Schedule - B						
Item No.	Quantities estimated but may be more or less	Item of work	Unit	Tendered Rates		Total amount according to estimated quantities
				in figures	In Words	
35	4.00	Providing and laying controlled cement concrete M250 work with curing etc. complete including the cost of from workbut excluding cost of Reinforcement for RCC work in Beam (T.F.)	CMT	6618.53	Rupees Six Thousand Six Hundred Eighteen and Paise Fifty Three Only	26474.12
36	15.50	Providing and laying controlled cement concrete M250 work with curing etc. complete including the cost of from workbut excluding cost of Reinforcement for RCC work in CHAJJA, (G.F.)	CMT	5580.25	Rupees Five Thousand Five Hundred Eighty and Paise Twenty Five Only	86493.88
37	14.00	Providing and laying controlled cement concrete M250 work with curing etc. complete including the cost of from workbut excluding cost of Reinforcement for RCC work in CHAJJA, (F.F.)	CMT	5620.65	Rupees Five Thousand Six Hundred Twenty and Paise Sixty Five Only	78689.10
38	13.00	Providing and laying controlled cement concrete M250 work with curing etc. complete including the cost of from workbut excluding cost of Reinforcement for RCC work in CHAJJA, (S.F.)	CMT	5661.05	Rupees Five Thousand Six Hundred Sixty One and Paise Five Only	73593.65
39	1.00	Providing and laying controlled cement concrete M250 work with curing etc. complete including the cost of from workbut excluding cost of Reinforcement for RCC work in CHAJJA, (T.F.)	CMT	5701.45	Rupees Five Thousand Seven Hundred One and Paise Forty Five Only	5701.45

Schedule - B						
Item No.	Quantities estimated but may be more or less	Item of work	Unit	Tendered Rates		Total amount according to estimated quantities
				in figures	In Words	
40	53.93	Providing and laying controlled cement concrete M250 work with curing etc. complete including the cost of from workbut excluding cost of Reinforcement for RCC work in SLAB (G.F.)	CMT	6305.43	Rupees Six Thousand Three Hundred Five and Paise Forty Three Only	340051.84
41	38.00	Providing and laying controlled cement concrete M250 work with curing etc. complete including the cost of from workbut excluding cost of Reinforcement for RCC work in SLAB (F.F.)	CMT	6345.83	Rupees Six Thousand Three Hundred Forty Five and Paise Eighty Three Only	241141.54
42	38.00	Providing and laying controlled cement concrete M250 work with curing etc. complete including the cost of from workbut excluding cost of Reinforcement for RCC work in SLAB (S.F.)	CMT	6386.23	Rupees Six Thousand Three Hundred Eighty Six and Paise Twenty Three Only	242676.74
43	6.00	Providing and laying controlled cement concrete M250 work with curing etc. complete including the cost of from workbut excluding cost of Reinforcement for RCC work in SLAB (T.F.)	CMT	6426.63	Rupees Six Thousand Four Hundred Twenty Six and Paise Sixty Three Only	38559.78
44	5.00	Providing and laying controlled cement concrete M250 work with curing etc. complete including the cost of from workbut excluding cost of Reinforcement for RCC work in Staircase (G.F.)	CMT	7323.51	Rupees Seven Thousand Three Hundred Twenty Three and Paise Fifty One Only	36617.55

Schedule - B						
Item No.	Quantities estimated but may be more or less	Item of work	Unit	Tendered Rates		Total amount according to estimated quantities
				in figures	In Words	
45	5.00	Providing and laying controlled cement concrete M250 work with curing etc. complete including the cost of from workbut excluding cost of Reinforcement for RCC work in Staircase (F.F.)	CMT	7363.91	Rupees Seven Thousand Three Hundred Sixty Three and Paise Ninety One Only	36819.55
46	5.00	Providing and laying controlled cement concrete M250 work with curing etc. complete including the cost of from workbut excluding cost of Reinforcement for RCC work in Staircase (S.F.)	CMT	7404.31	Rupees Seven Thousand Four Hundred Four and Paise Thirty One Only	37021.55
47	72537.80	Providing TMT Bar FE 500D reinforcement for R.C.C. work including Cutting, bending, binding and placing in position complete upto floor two level (G.F.)	Kg.	76.21	Rupees Seventy Six and Paise Twenty One Only	5528105.74
48	17815.00	Providing TMT Bar FE 500D reinforcement for R.C.C. work including Cutting, bending, binding and placing in position complete upto floor two level (F.F.)	Kg.	77.21	Rupees Seventy Seven and Paise Twenty One Only	1375496.15
49	16915.00	Providing TMT Bar FE 500D reinforcement for R.C.C. work including Cutting, bending, binding and placing in position complete upto floor two level (S.F.)	Kg.	78.21	Rupees Seventy Eight and Paise Twenty One Only	1322922.15

Schedule - B						
Item No.	Quantities estimated but may be more or less	Item of work	Unit	Tendered Rates		Total amount according to estimated quantities
				in figures	In Words	
50	4430.00	Providing TMT Bar FE 500D reinforcement for R.C.C. work including Cutting, bending, binding and placing in position complete upto floor two level (T.F.)	Kg.	79.21	Rupees Seventy Nine and Paise Twenty One Only	350900.30
51	180.50	Brick work using common burnt clay building bricks having crushing strength not less than 35 Kg/ Sq.Cm. In Super Structure above plinth level up to floor two level in cement mortar 1:6 (1 Cement: 6-Fine sand) with curing etc. (b)Conventional. (G.F.)	CMT	4289.33	Rupees Four Thousand Two Hundred Eighty Nine and Paise Thirty Three Only	774224.07
52	60.50	Brick work using common burnt clay Building bricks having crushing strength not less than 35 Kg/ Sq.Cm. In Super Structure above plinth level up to floor two level in cement mortar 1:6 (1 Cement: 6-Fine sand) with curing etc. (b)Conventional. for F.F.	CMT	4329.52	Rupees Four Thousand Three Hundred Twenty Nine and Paise Fifty Two Only	261935.96
53	35.00	Brick work using common burnt clay Building bricks having crushing strength not less than 35 Kg/ Sq.Cm. In Super Structure above plinth level up to floor two level in cement mortar 1:6 (1 Cement: 6-Fine sand) with curing etc. (b)Conventional. for S.F.	CMT	4369.70	Rupees Four Thousand Three Hundred Sixty Nine and Paise Seventy Only	152939.50
54	25.00	Brick work using common burnt clay Building bricks having crushing strength not less than 35 Kg/ Sq.Cm. In Super Structure above plinth level up to floor two level in cement mortar 1:6 (1 Cement: 6-Fine sand) with curing etc. (b)Conventional. for T.F.	CMT	4409.89	Rupees Four Thousand Four Hundred Nine and Paise Eighty Nine Only	110247.25

Schedule - B						
Item No.	Quantities estimated but may be more or less	Item of work	Unit	Tendered Rates		Total amount according to estimated quantities
				in figures	In Words	
55	73.00	Half brick masonry in common brunt clay building bricks having crushing strength not less than 35 Kg/Sq.Cm. in Cement mortar 1:4 (1- Cement : 4 -coarse sand) in foundation and plinth (B) Conventional (upto 10 ton) (for GF)	Sqm	651.67	Rupees Six Hundred Fifty One and Paise Sixty Seven Only	47571.91
56	70.00	Half brick masonry in common brunt clay building bricks having crushing strength not less than 35 Kg/Sq.Cm. in Cement mortar 1:4 (1- Cement : 4 -coarse sand) in foundation and plinth (B) Conventional (upto 10 ton) (for FF)	Sqm	657.67	Rupees Six Hundred Fifty Seven and Paise Sixty Seven Only	46036.90
57	44.00	Half brick masonry in common brunt clay building bricks having crushing strength not less than 35 Kg/Sq.Cm. in Cement mortar 1:4 (1- Cement : 4 -coarse sand) in foundation and plinth (B) Conventional (upto 10 ton) (for SF)	Sqm	663.67	Rupees Six Hundred Sixty Three and Paise Sixty Seven Only	29201.48
58	15.00	Providing and fixing of full height glass partitions (AS PER DRAWINGS) using 19 or 25 mm C-channels in border and edge profile in between with powder coating , 12mm clear toughned glass, film work as per drawing including all hardware items, silicon, etc with all material, labour, cutouts, edge polish , lead and wastage etc. and complete the work satisfactorily as per instruction of architect or Engineer-in charge.	Sqm	4684.40	Rupees Four Thousand Six Hundred Eighty Four and Paise Forty Only	70266.00

Schedule - B						
Item No.	Quantities estimated but may be more or less	Item of work	Unit	Tendered Rates		Total amount according to estimated quantities
				in figures	In Words	
59	4.00	Providing and fixing of 12 mm tk toughned GLASS DOORS using Dorma XI-C 4001 Glass Door PKG EN 3 (Top Patch-1, Bottom patch-1, Floor Spring-1, Corner Lock-1); Dorma XI-C 4003 A Patch fitting for overpanel and sidelight; Dorma XI-C 4004 A Connector for overpanel and Sidelight; Dorma XI-C 4006 Central Connector; Dorma XI-C 4008 Side Connector; Dorma XI-C 3000 H Type Handle 400x22 CTC 300 AND AS PER DRAWING including all accessories,locks, material, silicone,labour,installation, Hole & slote charges etc. and complete the work satisfactorily as per instruction of architect or Engineer-in charge.(APPROX SIZE OF 0.90 X 2.40)	No.	39602.73	Rupees Thirty Nine Thousand Six Hundred Two and Paise Seventy Three Only	158410.92
60	89.00	Providing & fixing 35mm.th. Flush Door Solid Double Core type Both Face water proof Ply Vennered & 1.5 mm th.laminate shall be pasted on both side with adhesives as specified by the manufacturers. The laminate shall be as per approved shade & texture, of make incl.. S.S. Hinges with nessary screws & S.S.fixtures & fastenings like handle(10	Sqm	3074.64	Rupees Three Thousand Seventy Four and Paise Sixty Four Only	273642.96
61	38.00	Providing and fixing FRP frame size 100x50 mm and 28mm thick FRP depress panel shutter having extra reinforcement on sides & edges in Gel coat finish. The core of the shutter & frame is to be filed up with injected fire retardant grade polyurethene foam done in situ alongwith embedded wooden pieces for stiffening & also taking hinges & fintures. The whole	Sqm	2377.76	Rupees Two Thousand Three Hundred Seventy Seven and Paise Seventy Six Only	90354.88

Schedule - B						
Item No.	Quantities estimated but may be more or less	Item of work	Unit	Tendered Rates		Total amount according to estimated quantities
				in figures	In Words	
62	60.00	Providing and fixing window having extruded aluminum Colour anodized section frame main outer size 95mm x 24mm x 1.17mm @ wt.of 0.738 Kg/mt , horizontal Three track member size 92mm x 31.75mm x 1.30mm,@ Wt.1.07 Kg/mt , vertical member of size 92mm x 31.75mm x 1.50mm @ Wt. 1.06 Kg/mt with sliding shutters of horizontal member size 40 mmx18mm x1.29mm @ wt.of 0.456 Kg/mt, vertical member of size 40mm x 18mm x 1.29 mm @ wt.of 0.456Kg/mt/ with 5 mm thick transparent bronze colour tinted float glass with powder coated aluminum fittings and fixtures and transparent silicon sealant glass fixing to frame as per details etc	Sqm	1583.95	Rupees One Thousand Five Hundred Eighty Three and Paise Ninety Five Only	95037.00
63	19.00	roviding and fixing window having extruded aluminum Colour anodized section frame main outer size 63.50 x 38.10 x 1.95 mm,@ Wt 1.094 Kg / Rmt, horizontal two track member size 61.85 mm x 31.75 mm x 1.20mm @ wt.of 0.695 Kg/mt, vertical member of size 61.85 mm x 31.75mm x 1.30 mm @ wt.of 0.659 Kg/mt with sliding shutters of horizontal member size 40mm x 18mm x 1.29mm @ wt.of 0.456Kg/mt, vertical member of size 40mm x 18mm x 1.29mm @ wt.of 0.456Kg/mt, @ Wt. 0.457 Kg/mt with 5 mm thick transparent bronze colour tinted float glass with powder coated aluminum fittings and fixtures and transparent silicon sealant glass fixing to frame as per details etc complete for window.	Sqm	1713.70	Rupees One Thousand Seven Hundred Thirteen and Paise Seventy Only	32560.30

Schedule - B						
Item No.	Quantities estimated but may be more or less	Item of work	Unit	Tendered Rates		Total amount according to estimated quantities
				in figures	In Words	
64	1.00	Providing and fixing standard extruded aluminium section of size 63.50 x 38.10 x 1.95 mm, @ Wt 1.094Kg / Rmt with colour anodized aluminium frame with 5 mm thick transparent bronze colour tinted float glass as details etc complete for openable shutter window.	Sqm	1525.00	Rupees One Thousand Five Hundred Twenty Five and Paise Zero Only	1525.00
65	19.00	Providing and fixing standard extruded aluminium section of size 63mm x 38.10mm x 1.2mm @ Wt. 0.643 Kg/mt with colour anodized aluminium frame for ventilation with 5 mm thick frosted glass as details etc complete for Ventilation	Sqm	1175.56	Rupees One Thousand One Hundred Seventy Five and Paise Fifty Six Only	22335.64
66	2316.00	Providing and fixing M.S. grills of required pattern to marble/granite frames of window etc. with M.s. flats at required spacing and frames around, square or round bars fixed with round headed bolts and nuts or by screws, including oil painting with one coat of primer of approved quality and brand & two coats of synthetic enamel oil paint etc.	Kg	106.05	Rupees One Hundred Six and Paise Five Only	245611.80
67	25.00	Providing and fixing 0.90 meter wide and 0.80 meter high sand which type platform including supplying and fixing granite stone 18 mm thick mirror polished stones in top and side position and vertical strip at front over 25 mm thick polished kotah stone platform fixing in top and sides and intermediates supports fixing with cement mortar and	Sqm	4474.84	Rupees Four Thousand Four Hundred Seventy Four and Paise Eighty Four Only	111871.00
68	3.00	Providing & laying 24"x24" Vitrified tiles 8 MM thick in flooring over 40 mm (Av.) base of C.M. 1:6 (1 Cement : 6 Coarse sand) on new surface or fixing on existing flooring by adhesive materials incldg. Dismanteling of existing flooring & joined with colour cement slurry including finished with flush pointing & cleaning the surface etc. completed Light Shade.	Sqm	1204.20	Rupees One Thousand Two Hundred Four and Paise Twenty Only	3612.60

Schedule - B						
Item No.	Quantities estimated but may be more or less	Item of work	Unit	Tendered Rates		Total amount according to estimated quantities
				in figures	In Words	
69	1.00	Providing and laying Vitrified tiles 8 to 10 mm thick , 24" x 24" in skirting risers of steps and dedo on 10mm thick cement plaster 1:3 (1-cement : 3-coarse sand) and jointed with white cement slurry	SMT	1141.45	Rupees One Thousand One Hundred Forty One and Paise Forty Five Only	1141.45
70	533.00	P & L 24" x 24" vitrified 8 mm thick tile flooring over 40 mm (average) base of cement mortar 1:6 (1 cement: 6 coarse sand) on new surface or fixing on existing flooring by adhesive material including Applying spacer of 5mm and not less than 3mm depth and filling groove with epoxy filler material of laticrete , Roff or equivalent. & cleaning the surface etc.	SMT	1394.69	Rupees One Thousand Three Hundred Ninety Four and Paise Sixty Nine Only	743369.77
71	182.00	Providing and laying white glazed tiles 6mm thick in flooring treads of steps and landing laid on a bed of 12mm thick cement mortar 1:3 (1-cement : 3-coarse sand) finishing with flush pointing in white cement.	SMT	827.19	Rupees Eight Hundred Twenty Seven and Paise Nineteen Only	150548.58
72	1192.00	Providing and laying white glazed tiles 6mm thick in skirting risers of steps and dedo on 10mm thick cement plaster 1:3 (1-cement : 3-coarse sand) and jointed with white cement slurry	SMT	857.42	Rupees Eight Hundred Fifty Seven and Paise Forty Two Only	1022044.64
73	56.00	Providing and laying Lather finished granite stone slab 18mm thick in flooring treads of steps and landing laid on a bed of 12mm thick cement mortar 1:6 (1-Cement : 6-Coarse Sand) finishing with full molded round edges, flush pointing in white or colour cement.	SMT	2774.16	Rupees Two Thousand Seven Hundred Seventy Four and Paise Sixteen Only	155352.96

Schedule - B						
Item No.	Quantities estimated but may be more or less	Item of work	Unit	Tendered Rates		Total amount according to estimated quantities
				in figures	In Words	
74	243.00	Providing and laying polished Granite Slab 18mm thick in Risers of steps Dedo, window sill, jembs and pillars laid 10mm thick Cement Mortar 1:3 (1-Cement : 3 coarse sand and jointed with Grey Cement Slurry including full molded round front edges , rubbing and polishing etc. complete.	SMT	2620.82	Rupees Two Thousand Six Hundred Twenty and Paise Eighty Two Only	636859.26
75	39.00	Providing and laying polished Kota stone slab flooring over 20mm (Average) thick base of cement mortar 1:6 (1-cement : 6-coarse sand) or L.M. 1.1.5 (1-Lime putty :1.5 - coarse sand) laid over and jointed with grey cement slurry mixed with pigment to match the shade of slab including rubbing and polishing etc. complete. (A) 25mm thick	SMT	971.95	Rupees Nine Hundred Seventy One and Paise Ninety Five Only	37906.05
76	6.00	Providing and laying polished kota stone slab 25mm thick in risers of steps,skirting Dedo and pillars laid on 40mm thick cement mortar 1:3 (1-Cement : 3 coarse sand) and jointed with gray cement slury mixed with pigment to match the shade of slab including rubbing and polishing etc. complete.	SMT	1056.26	Rupees One Thousand Fifty Six and Paise Twenty Six Only	6337.56
77	284.00	Providing 10 mm thick cement mala plaster on ceiling and soffits of stairs for interior upto floor two level, in cement mortar (1:4) (1 cement : 4 sand) etc complete. Ground floor	SMT	147.94	Rupees One Hundred Forty Seven and Paise Ninety Four Only	42014.96
78	294.00	Providing 10 mm thick cement mala plaster on ceiling and soffits of stairs for interior upto floor two level, in cement mortar (1:4) (1 cement : 4 sand) etc complete. First floor	SMT	168.79	Rupees One Hundred Sixty Eight and Paise Seventy Nine Only	49624.26

Schedule - B						
Item No.	Quantities estimated but may be more or less	Item of work	Unit	Tendered Rates		Total amount according to estimated quantities
				in figures	In Words	
79	299.00	Providing 10 mm thick cement mala plaster on ceiling and soffits of stairs for interior upto floor two level, in cement mortar (1:4) (1 cement : 4 sand) etc complete. Second floor	SMT	189.64	Rupees One Hundred Eighty Nine and Paise Sixty Four Only	56702.36
80	26.00	Providing 10 mm thick cement mala plaster on ceiling and soffits of stairs for interior upto floor two level, in cement mortar (1:4) (1 cement : 4 sand) etc complete. Terrace floor	SMT	210.48	Rupees Two Hundred Ten and Paise Forty Eight Only	5472.48
81	969.00	Providing 15 mm thick cement mala plaster in single coat on fair side bricks/concret walls for interior plastering up to floor two level finished even and smooth in cement mortar 1:4 (1 cement : 4 sand) etc complete. Ground Floor	SMT	163.85	Rupees One Hundred Sixty Three and Paise Eighty Five Only	158770.65
82	752.00	Providing 15 mm thick cement mala plaster in single coat on fair side bricks/concret walls for interior plastering up to floor two level finished even and smooth in cement mortar 1:4 (1 cement : 4 sand) etc complete. First Floor	SMT	186.61	Rupees One Hundred Eighty Six and Paise Sixty One Only	140330.72
83	526.00	Providing 15 mm thick cement mala plaster in single coat on fair side bricks/concret walls for interior plastering up to floor two level finished even and smooth in cement mortar 1:4 (1 cement : 4 sand) etc complete. Second Floor	SMT	209.36	Rupees Two Hundred Nine and Paise Thirty Six Only	110123.36

Schedule - B						
Item No.	Quantities estimated but may be more or less	Item of work	Unit	Tendered Rates		Total amount according to estimated quantities
				in figures	In Words	
84	74.00	Providing 15 mm thick cement mala plaster in single coat on fair side bricks/concret walls for interior plastering up to floor two level finished even and smooth in cement mortar 1:4 (1 cement : 4 sand) etc complete. Third(Terace) Floor	SMT	232.12	Rupees Two Hundred Thirty Two and Paise Twelve Only	17176.88
85	1982.00	20mm.thick sand faced cement plaster on walls upto height 10 meters above ground level consisting of 12mm. Thick backing coat of CM.1:3 (1-cement:3-sand) and 8mm.thick finishing coat of C.M. 1:1 (1-cement:1-sand) etc. complete.	SMT	326.11	Rupees Three Hundred Twenty Six and Paise Eleven Only	646350.02
86	234.80	Providing and laying 20 mm thick water proof cement plaster using water proofing powder 1Kg/1bag of cement for all floors on brick / concrete wall work using water proofing materials in C M 1: 4 (1 cement 4 coarsse sand) including finishing with a floating coat of neat	SMT	265.63	Rupees Two Hundred Sixty Five and Paise Sixty Three Only	62369.92
87	437.00	Providing throating or plaster drip and moulding to R.C.C. Chajja etc.comp	RMT	41.00	Rupees Forty One and Paise Zero Only	17917.00
88	2604.75	Prov.20mm deep finished groove etc.comp	RMT	27.27	Rupees Twenty Seven and Paise Twenty Seven Only	71031.53

Schedule - B						
Item No.	Quantities estimated but may be more or less	Item of work	Unit	Tendered Rates		Total amount according to estimated quantities
				in figures	In Words	
89	707.00	Providing and fixing chicken wiremesh jali at R.C.C. masonry joints at any height with all labour & material etc. complete.	SMT	319.16	Rupees Three Hundred Nineteen and Paise Sixteen Only	225646.12
90	3255.97	Applying two coats of birla(White cement based) or Asian (acrylic lappy putty) or equivalent two coats of primer of approved brand and manufacture on new wall surface to give an even shade including thoroughly brushing the surface free from mortar dropping	SMT	40.59	Rupees Forty and Paise Fifty Nine Only	132159.82
91	4410.00	Wall painting (three coats) with plastic emulsion paint of approved brand and manufacture on undecorated wall surface to give an even shade including throughly brushing the surface free from mortar droppings and other foreign matter and sand papered smooth.	SMT	119.42	Rupees One Hundred Nineteen and Paise Forty Two Only	526642.20
92	71.00	Wall painting (two coats) with plastic emulsion paint of approved brand and manufacture on ceiling and slopping roofs to give an even shade including throughly brushing the surface free from mortar droppings and other foreign matter and sand papered smooth.For All	SMT	78.90	Rupees Seventy Eight and Paise Ninety Only	5601.90
93	18.00	Wall painting (two coats) with plastic emulsion paint of approved brand and manufacture on ceiling and slopping roofs to give an even shade including throughly brushing the surface free from mortar droppings and other foreign matter and sand papered smooth.For All	SMT	84.16	Rupees Eighty Four and Paise Sixteen Only	1514.88

Schedule - B						
Item No.	Quantities estimated but may be more or less	Item of work	Unit	Tendered Rates		Total amount according to estimated quantities
				in figures	In Words	
94	719.00	Finising wall with weatherproof exterior emulsion paint on wall surface (two coats) to give and required shape even shade after thoroughly brushing the surface to remove all dirts , and remains of ioose powdered materials etc. complete. including two Coats of	SMT	155.12	Rupees One Hundred Fifty Five and Paise Twelve Only	111531.28
95	1263.00	Providing & applying single coat of textured finish at external surface at all floor levels with three coats of weather proof cement exterior paint of approved standard brands make t at outer side of the building on RCC or Masonary walls. Including all labour. materials.	SMT	516.11	Rupees Five Hundred Sixteen and Paise Eleven Only	651846.93
96	644.55	Providing cement vata, 10 cm. x 10 cm. size, quarter round in cement mortar 1:1 including neat cement finishing, watering, etc. complete.	RMT	23.68	Rupees Twenty Three and Paise Sixty Eight Only	15262.94
97	281.00	Providing and laying chaina mosaic water proofing treatment on terrace including applying neat cement slurry 2.75 Kg./Sqm. Of cement admixed with water proofing compound after cleaning the surface (b) laying cement concrete usig brick bats 25 to 100 mm size with 50% C.M. 1:5 (1 cement : 5 coarse sand) admixed with water proofing compound over 20 mm	SMT	1321.31	Rupees One Thousand Three Hundred Twenty One and Paise Thirty One Only	371288.11
98	3.00	Supply & Fixing of Broken Glazed (China Mosaic) tiles size 5-6 mm thick of different size and shade (approved crazy patern) in Cement:Mortar 1:2 and joint filling with White Cement / Coloured Cement with water proofing component including Ramping, Watering, Curing etc. complete (FOR ALL FLOOR)	SMT	747.29	Rupees Seven Hundred Forty Seven and Paise Twenty Nine Only	2241.87

Schedule - B						
Item No.	Quantities estimated but may be more or less	Item of work	Unit	Tendered Rates		Total amount according to estimated quantities
				in figures	In Words	
99	1.50	Steel work welded in built up sections framed work including cutting, hoisting, fixing in position and applying a priming coat of red lead paint. [A.] In beams and joists, channels angles tees, flats with connecting plates or angle cleats as in main and cross beams, Hip and jack rafters, purlins connected to common rafters and the like.	Quintal	9047.86	Rupees Nine Thousand Forty Seven and Paise Eighty Six Only	13571.79
100	3854.00	Steel work, welded in built up sections framed work including cutting, hoisting, fixing in position and applying two coat priming of red lead paint and two coats of synthetic enamel paint . (A)In beams and joists, channels angles Tees, flats, with connecting plates or angle cleats as in main and cross beams. Hip and jack rafters, purlins conneted to common rafters and the like for for Main entry gate & compound wall grill.	Kg.	119.18	Rupees One Hundred Nineteen and Paise Eighteen Only	459319.72
101	29.00	Providing and Fixing 90 cm high stainless steel railing made from anticorrosive 304 grade S.S. Staircase Railing modular type welded fitting (S-Rail SR11 Square Type Steel Baluster),Main hand Rail pipe (DASA Pipe) 50mm outer dia 1.6 mm Thickness SS 304 Grade, Balustar steel square type 32X32mm outer dia. 1.6mm thickness ss 304 pipe, 3 pipe below main dasa pipe 16 mm outer dia. 1.6mm thickness ss304 grade as a vertical support fixed in RCC S.S. pipe with steel modular type fitting baluster including all type accessories as per detailed drawing as directed etc. complete for all floors.	SMT	3954.93	Rupees Three Thousand Nine Hundred Fifty Four and Paise Ninety Three Only	114692.97

Schedule - B						
Item No.	Quantities estimated but may be more or less	Item of work	Unit	Tendered Rates		Total amount according to estimated quantities
				in figures	In Words	
102	203.00	The providing & fixing of Fix louvered work. The main frames both verticals and horizontals have to be Aluminium pipes of 100 mm x 50 x 3.0 mm with colour anodized 20 micron (silver) thick, including All hardware, labour, scaffolding, fixtures, fasteners transport and all other taxes included etc. complete as per architect's details at all floor levels.	SMT	5262.31	Rupees Five Thousand Two Hundred Sixty Two and Paise Thirty One Only	1068248.93
103	40.00	Providing and fixing Semi unitized vision panel with glazed units (SGU) of size as per design and consisting of 6 mm thick (toughened) glass approved by the architect. with mullion (101mm x 57mm x 1.8mm, 8.9 kg/ 12 rft), transom (63mm x 57mm x 1.8mm, 5.8 kg/ 12 rft), sub frame (54mm x 22mm x 1.25mm, 2.4kg / 12 rft), with anodizing, with m.s. hot deep galvanized bracket, with s.s. hardware The glazed panel to be formed by means of imported special structural quality silicon adhesive sealant layer manufactured by M/S. Dow Corning 995 USA with material:- silicone dowcorring 789 weather silicone in 995 dow corring. It includes cost of labour, materials, accessories, adhesives, all required M.S FABRICATIONS scaffolding	SMT	7196.25	Rupees Seven Thousand One Hundred Ninety Six and Paise Twenty Five Only	287850.00

Schedule - B						
Item No.	Quantities estimated but may be more or less	Item of work	Unit	Tendered Rates		Total amount according to estimated quantities
				in figures	In Words	
104	4.00	(Top hung Openable part) Providing and fixing openable hardware for glazing as per detail , It includes cost of labour, materials, accessories,all required M.S FABRICATIONS,adhesives, scaffolding, wastages, transport, taxes, fixing into a neat finish in aesthetic point of view, without any undulations in facias all complete as per drawing and Instruction of engineer in-charge	No.	25502.50	Rupees Twenty Five Thousand Five Hundred Two and Paise Fifty Only	102010.00
105	8.00	Providing & fixing in position collapsible steel shutters with vertical channels 20 x10 x 2 mm. Braced with flat iron diagonals 20 x5mm size with top & bottom rails of T-iron 40x40x6mm. with 38mm dia. steel pulleys comp. with bolts, locking arrangements, stoppers, handles incl. applying a priming coat of Redlead paint etc. comp.	SMT	4128.88	Rupees Four Thousand One Hundred Twenty Eight and Paise Eighty Eight Only	33031.04
106	6.00	Providing and laying and fixing 50mm thick expansion joint by hydro cell semi rigid UV resistance with high performance laminated closed cell polythene foam joint filler in sheet foam as directed, etc. complete.	SMT	1491.03	Rupees One Thousand Four Hundred Ninety One and Paise Three Only	8946.18
107	18.00	Providing and fixing wsh down water closet (European type, W.C. Pan) with integral P or S trap including jointing the trap with soil pipe in Cement Mortar 1:1 (1-Cement : 1-fine sand) (Seal and cover to be measured and paid for separately)(A) vitreous China Pattern :(i) in white colour	No.	1303.71	Rupees One Thousand Three Hundred Three and Paise Seventy One Only	23466.78

Schedule - B						
Item No.	Quantities estimated but may be more or less	Item of work	Unit	Tendered Rates		Total amount according to estimated quantities
				in figures	In Words	
108	15.00	Providing and fixing plastic seat and cover for wash down water closer with C.P. brass hinges and rubber buffers.	No.	291.33	Rupees Two Hundred Ninety One and Paise Thirty Three Only	4369.95
109	22.00	Providing and fixing washbasin with single hole for pillar tap with C.I. or M.S. brackets painted white including sutting holes and making good the same but excluding fittings.(A) Vitreous China:(ii) Flat Back washbasin 550 mm x v 400mm size. (i) In white colour.	No.	1414.18	Rupees One Thousand Four Hundred Fourteen and Paise Eighteen Only	31111.96
110	22.00	Providing and fixing C.P. brass waste for washbasin or sink. (B) 40mm dia	No.	89.83	Rupees Eighty Nine and Paise Eighty Three Only	1976.26
111	22.00	Providing and fixing M.I. fisher union for washbasin or sink. (B) 40mm dia	No.	88.65	Rupees Eighty Eight and Paise Sixty Five Only	1950.30
112	22.00	Providing and fixing chromium plated, bottle trap with necessary couplings of approved quality for wash basin.	No.	295.80	Rupees Two Hundred Ninety Five and Paise Eighty Only	6507.60
113	7.00	Providing and fixing Urinal or approved quality including conecting the Urinal with waste pipe , tap etc. complete.(A) White earthenware flat back or corner type size 430mm x 260mm x 350mm.	No.	1036.27	Rupees One Thousand Thirty Six and Paise Twenty Seven Only	7253.89
114	22.00	Providing and fixing 600mm x 450mm bevelled edge mirror of superior glass mounted on 6mm thick A.C. sheet or plywood sheet and fixing to wooden pluge with C.P. brass screws and washers.	No.	833.73	Rupees Eight Hundred Thirty Three and Paise Seventy Three Only	18342.06
115	22.00	Providing and fixing C.P. brass towel rail comlete with C.P. brass brackets fixed to wooden plugs with C.P. brass scews.(B) 600mm x 20mm size.	No.	603.19	Rupees Six Hundred Three and Paise Nineteen Only	13270.18

Schedule - B						
Item No.	Quantities estimated but may be more or less	Item of work	Unit	Tendered Rates		Total amount according to estimated quantities
				in figures	In Words	
116	35.00	Providing and fixing PVC SWR Nahni trap IS 14735 for drain - 100 mm diameter with jali of the following nominal diameter of self cleansing design with C.I scread down or hinged grating including the cost of cutting and making good the walls	No.	558.36	Rupees Five Hundred Fifty Eight and Paise Thirty Six Only	19542.60
117	200.00	Providing and fixing to wall ceiling and floor 10.0 Kg. F/Cm2 working pressure polythene pipes of the following outside Dia. Low densidy, complete with special falnge compression type fittings, wall clipsetc. including making good the wall ceiling and floor.(F) 75mm	RMT	277.43	Rupees Two Hundred Seventy Seven and Paise Forty Three Only	55486.00
118	111.00	Providing and fixing to wall ceiling and floor 10.0 Kg. F/Cm2 working pressure poluthene pipes of the following outside Dia. Low densidy, complete with special falnge compression type fittings, wall clipsetc. including making good the wall ceiling and floor.(G)110 mm	RMT	240.21	Rupees Two Hundred Forty and Paise Twenty One Only	26663.31
119	5.00	Providing and fixing S.W. gully trap with C.I. grating brick masonry chamber and water tight C.I. cover with frame of 300mm x 300mm size (inside) with standard weight.(i) Square mouth traps.(B) 150mm x 100mm size P or R type	No	1246.92	Rupees One Thousand Two Hundred Forty Six and Paise Ninety Two Only	6234.60

Schedule - B						
Item No.	Quantities estimated but may be more or less	Item of work	Unit	Tendered Rates		Total amount according to estimated quantities
				in figures	In Words	
120	10.00	Constructing brick masonry chamber for underground C.I. Inspection chamber and bends with bricks having crushing strength not less than 35Kg/Cm ² in C.M. 1:5 C.I. cover with frame (Light duty) 455mm x 610mm intenal dimensions total weight of cover with frame to be not less than 38Kg. (Wt. of cover 23 Kg.) and Wt. of frame 15Kg.) (R.C.C. top slabe with 1:2:4 mix (1-cement :2- coarse sand :4-graded stone aggregate 20mm size) foundation concrete 1:5:10 inside plaster 15mm thick with cement mortar 1:3 finished smooth with a floating coat of neat cement on walls and bed concrete etc. complete.(i) Inside dimensions 455mmx 610mm and 450mm deep for single pipe line.	No	2932.93	Rupees Two Thousand Nine Hundred Thirty Two and Paise Ninety Three Only	29329.30
121	200.00	Providing laying and jointing in true line and level 15mm dia. U.P.V.C. Pipe (SCH-40) for cold water including fittings as approved by Engineer In Charge. Pipe shall be fixed on the wall with the help of clamp at every two metre C/C or shall be concealed as directed including necessary fittings etc. including testing of pipe and joints and fixing the same with adhesive solvent, including cost of all materials	RMT	72.65	Rupees Seventy Two and Paise Sixty Five Only	14530.00

Schedule - B						
Item No.	Quantities estimated but may be more or less	Item of work	Unit	Tendered Rates		Total amount according to estimated quantities
				in figures	In Words	
122	250.00	Providing laying and jointing in true line and level 25mm dia. U.P.V.C. Pipe (SCH- 40) for cold water including fittings as approved by Engineer In Charge. Pipe shall be fixed on the wall with the help of clamp at every two metre C/C or shall be concealed as directed including necessary fittings etc. including testing of pipe and joints and fixing the same with adhesive solvent, including cost of all materials.	RMT	91.84	Rupees Ninety One and Paise Eighty Four Only	22960.00
123	75.00	Providing laying and jointing in true line and level 40mm dia. U.P.V.C. Pipe (SCH- 40) for cold water including fittings as approved by Engineer In Charge. Pipe shall be fixed on the wall with the help of clamp at every two metre C/C or shall be concealed as directed including necessary fittings etc. including testing of pipe and joints and fixing the same with adhesive solvent, including cost of all materials.	RMT	148.12	Rupees One Hundred Forty Eight and Paise Twelve Only	11109.00
124	20.00	Providing and fixing concealed center point to wall ceiling & floor CPVC (SDR 13.5) PIPE having National Sanitation Foundation (NSF) seal for potable water of following dia. nominal bore tube fittings and clamps including making good the wall, ceiling and floor etc. complete.[A] 15 mm	RMT	166.86	Rupees One Hundred Sixty Six and Paise Eighty Six Only	3337.20

Schedule - B						
Item No.	Quantities estimated but may be more or less	Item of work	Unit	Tendered Rates		Total amount according to estimated quantities
				in figures	In Words	
125	38.00	Providing and fixing concealed center point to wall ceiling & floor CPVC (SDR 13.5) PIPE having National Sanitation Foundation (NSF) seal for potable water of following dia. nominal bore tube fittings and clamps including making good the wall, ceiling and floor etc. complete. [C] 25 mm.	RMT	249.72	Rupees Two Hundred Forty Nine and Paise Seventy Two Only	9489.36
126	28.00	Providing and fixing screw down bib taps of following size.(A) Brass screw down bib tap polished bright. (i) 15mm dia.	No.	186.83	Rupees One Hundred Eighty Six and Paise Eighty Three Only	5231.24
127	22.00	5 Providing and fixing pillar tap, capstan head, screw down high pressure with screws, shanks and back nuts. (i) 15mm dia.	No.	308.73	Rupees Three Hundred Eight and Paise Seventy Three Only	6792.06
128	22.00	Providing and fixing brass screw down stop tap.(A) 15mm dia	No.	205.83	Rupees Two Hundred Five and Paise Eighty Three Only	4528.26
129	18.00	Providing and fixing chromium plated brass half trun flush cock of approved quality including fixing in pipe line etc. complete.(ii) 25mm dia.	No.	263.77	Rupees Two Hundred Sixty Three and Paise Seventy Seven Only	4747.86
130	12.00	Providing and fixing ball cock of approved. quality as directed.(A) Copper Metal (i) 25mm dia	No.	132.89	Rupees One Hundred Thirty Two and Paise Eighty Nine Only	1594.68
131	5.00	Providing and fixing in position cowel went to pipes.(B) 75mm dia	No.	389.74	Rupees Three Hundred Eighty Nine and Paise Seventy Four Only	1948.70

Schedule - B						
Item No.	Quantities estimated but may be more or less	Item of work	Unit	Tendered Rates		Total amount according to estimated quantities
				in figures	In Words	
132	5.00	Providing and fixing in position cowel went to pipes.(C) 100mm dia	No.	501.87	Rupees Five Hundred One and Paise Eighty Seven Only	2509.35
133	10000.00	Providing erecting and fixing double coated ISI water tank of required capacity each with all necessary fittings and connection etc. complete on terrace	Liter	3.95	Rupees Three and Paise Ninety Five Only	39500.00
134	3.00	Providing and fixing SS Sink Glosy ASIS 304 Grade x 1mm thick with over all size 610x460 mm & bowl size 560x410x200 including Providing and fixing chromium plated, bottle trap with necessary couplings of approved quality and C.P. Pillar cock 15 mm Heavy duty swan neck etc complete as per detail drawing and instruction of EIC.	Nos.	3548.52	Rupees Three Thousand Five Hundred Forty Eight and Paise Fifty Two Only	10645.56
135	2.00	Providing and fixing G.I. Rain water spout of 50mm dia. and 30cm. length.	Nos.	101.91	Rupees One Hundred One and Paise Ninety One Only	203.82
136	4.00	Supplying & fixing 0.60x0.45 M size C.I. mahole cover with frame in slab as directed with 2 coats of anti-corrosive shop paint etc. comp. as directed.	Nos.	958.17	Rupees Nine Hundred Fifty Eight and Paise Seventeen Only	3832.68
137	15.00	Providing and fixing cast iron steps of size 500mm x 150mm x 22.5mm and painting with two coats of Anti-corrosive paint etc. complete.	Nos.	144.29	Rupees One Hundred Forty Four and Paise Twenty Nine Only	2164.35
138	375.00	Box cutting the road surface to proper slope & camber for making a base for road work including removing the excavated stuff, and depositing on the road side slopes as directed up to 50 Mt. Lead	CMT	104.20	Rupees One Hundred Four and Paise Twenty Only	39075.00

Schedule - B						
Item No.	Quantities estimated but may be more or less	Item of work	Unit	Tendered Rates		Total amount according to estimated quantities
				in figures	In Words	
139	188.00	Rolling and Consolidating of soling including filling in depression which occurs during the process with power roller 8 tonne to 12 tonne. and compacting the bed as per specifications to core test 97% compacting complete in all respects to the entire satisfaction of the Engineer-in - charge.	Sqm	22.36	Rupees Twenty Two and Paise Thirty Six Only	4203.68
140	83.00	Providing and fixing pre- cast concrete kerb stone of gray cement based concrete block 30 cm length, 30 cm height and 15cm thick of 250 grade concret as per approved design and including excavation for fixing in proper line and level, fillig the joint with C: M 1:3 (1 Cement : 3 Fine Sand) etc. complete	RMT	361.64	Rupees Three Hundred Sixty One and Paise Sixty Four Only	30016.12
141	94.00	Providing, laying, spreading and consolidation graded stone aggregate to wet mix macadam 150mm compacted thick as per MORT & H specifications including premixing the material with water at OMC in mechanical plant carriage of mixed material by tippers to site, laying in uniform layers with paver in sub base/ base course on well prepared surface and compacting with vibratory roller to achieve the desired density	CMT	1156.14	Rupees One Thousand One Hundred Fifty Six and Paise Fourteen Only	108677.16

Schedule - B						
Item No.	Quantities estimated but may be more or less	Item of work	Unit	Tendered Rates		Total amount according to estimated quantities
				in figures	In Words	
142	72.00	Providing & laying of specified compacted thickness Granular sub base (GSB) in specified grading in table 400-1 of the specification MORT&H and compactor to the required density with 8 - 10 tonne vibratory roller with plain drum or heavy pneumatic tyred roller of minimum 200 to 300 KN weight in all seasons as per MORT&H , maintaining the required slope & grade during the operation as approved by the engineer in charge & watering to the proper moisture content and sprinkled with the help of truck mounted water tank fitted with suitable arrangement .(fully saturated having CBR value greater or equal to 30) compacted thickness of 150 mm consisting of Machine crust stone aggregate as per grading 1 in table 400-1 of the specification MORT&H fifth Revision	CMT	891.39	Rupees Eight Hundred Ninety One and Paise Thirty Nine Only	64180.08
143	147.00	Providing and fixing pre-cast Rubber Dye / steel Dye inter locking concrete block 60mm thick with grade of concrete M300 pneumatic compressed / vibrated mechanically and as per approved design Confirming to IS 15658 : 2006 including 35 mm Sand layer for levelling and filling the joint with sand in proper line and level as per guidelines of IRC : SP 63-2018 etc. Complete.	SMT	686.90	Rupees Six Hundred Eighty Six and Paise Ninety Only	100974.30
144	72.00	Providing and Laying trimix Controlled cement concrete M-250 finishing smooth with curing etc. complete including the cost of formwork but excludng the cost of reinforcement for internal road having thickness of 15 CM.compaction and finishing of road by trimix process surface by using vaccum dewatering, floater surface vibrator etc.Rate are also inclusive of Providing and Mixing Plastisizer of approved make.	CMT	6371.08	Rupees Six Thousand Three Hundred Seventy One and Paise Eight Only	458717.76

Schedule - B						
Item No.	Quantities estimated but may be more or less	Item of work	Unit	Tendered Rates		Total amount according to estimated quantities
				in figures	In Words	
145	150.00	Shrubs/Ground coversSupplying and planting healthy shrubs of different species of 450mm to 900 mm height: by using the soil/ manure (either carted or supplied), and watering it immediately. Maintaining(application of liquid manures/ growth regulators/ pesticides as per need, weeding and gap filling regularly so as to keep the plant healthy all the time) it for a period of 3 months from the date of plantation-Ixora Pink,Ixora Red, Ixora Yellow,Ixora White or as per selection of Engg. in charge/Architect.	Nos.	227.25	Rupees Two Hundred Twenty Seven and Paise Twenty Five Only	34087.50
146	160.00	Lawn/Grass Supplying and planting of good quality nodes of specified grass for dibbling: It includes the cultivation of dround to a depth of 150mm, Planting (2"-3" apart) of grass as per drawing without disturbing the desired gradient and level, watering, maintaining (forking, mowing, weeding, fertilizer application, pest control etc.) it for a period of 3 months from the date of lawn dibbling/plantation. Doob grass(dibbling)	Sqm	224.22	Rupees Two Hundred Twenty Four and Paise Twenty Two Only	35875.20

Schedule - B						
Item No.	Quantities estimated but may be more or less	Item of work	Unit	Tendered Rates		Total amount according to estimated quantities
				in figures	In Words	
147	76.00	Point wiring for Light / Bell with 2-1.5 sq.mm & earth wire of 1.5 sq.mm (Green) both are of ISI marked 1.1 KV grade FRLS PVC insulated multi strand copper wires up to 10 mtr length , in below type of pipe erected with 6A Modular type switch / bell push & accessories and earth continuity of following type, erected on PVC / Metallic/Wooden box, single mounting base frame covered with textured/metallic/white front plate modules erected on / in wall / ceiling as per pipe erected, with necessary Lamp holder/ceiling rose / H.D.Connector as directed. (f) with medium class Rigid PVC pipe and accessories erected concealed in wall/ceiling complete Cat. III	Pt.	449.45	Rupees Four Hundred Forty Nine and Paise Forty Five Only	34158.20
148	68.00	Point wiring for Tissino / Modular secondary light point with 2-1.5 sq.mm & earth wire of 1.5 sq.mm (green) both are of ISI marked 1.1 KV grade FRLS PVC insulated multi strand copper wires, in below type of pipe to be erected complete with earth continuity and necessary connection with primary light with accessories erected on Metal / PVC / wooden box covered with 3 mm thick PC(Polycarbonate) / Acrylic sheet for open / concealed wiring. with necessary Lamp holder / ceiling rose / H.D.Connector as directed. (f) with medium class Rigid PVC pipe and accessories erected concealed in wall/ceiling complete	Pt.	151.50	Rupees One Hundred Fifty One and Paise Fifty Only	10302.00

Schedule - B						
Item No.	Quantities estimated but may be more or less	Item of work	Unit	Tendered Rates		Total amount according to estimated quantities
				in figures	In Words	
149	45.00	Point wiring for FAN with 2-1.5 sq.mm & earth wire of 1.5 sq.mm (Green) both are of .ISI marked 1.1 KV Grade FRLS PVC insulated multi strand copper wires up to 10 mtr length, in below type of pipe erected with 6A Modular type switch and hum free EME step type electronic fan regulator mounted and accessories with earth continuity of following type erected on PVC / Metallic/Wooden box, single mounting base frame covered with textured/metallic/white front plate modules erected on / in wall / ceiling as per pipe erected. with necessary ceiling rose / H.D.Connector as directed. (f) with medium class Rigid PVC pipe and accessories erected concealed in wall/ceiling complete Cat. III	Pt.	629.23	Rupees Six Hundred Twenty Nine and Paise Twenty Three Only	28315.35
150	200.00	Providing and erecting Mains with 1.1 KV grade FRLS PVC insulated ISI marked stranded Copper conductor wire in following type of pipe to be erected concealed in /flushed on wall/ceiling, with 1.5 sq. mm copper conductor FRLS PVC insulated stranded wire of green colour for earth continuity of following size (A) With medium class Rigid PVC pipe and accessories (a) 2 wire 1.5 sq. mm	Mtr	59.59	Rupees Fifty Nine and Paise Fifty Nine Only	11918.00
151	150.00	Providing and erecting Mains with 1.1 KV grade FRLS PVC insulated ISI marked stranded Copper conductor wire in following type of pipe to be erected concealed in /flushed on wall/ceiling, with 1.5 sq. mm copper conductor FRLS PVC insulated stranded wire of green colour for earth continuity of following size (A) With medium class Rigid PVC pipe and accessories (b) 2 wire 2.5 sq. mm	Mtr	78.78	Rupees Seventy Eight and Paise Seventy Eight Only	11817.00

Schedule - B						
Item No.	Quantities estimated but may be more or less	Item of work	Unit	Tendered Rates		Total amount according to estimated quantities
				in figures	In Words	
152	10.00	Point wiring for Two Way Controlled Light Point with 2-1.5 sq.mm & earth wire of 1.5 sq.mm (green) both are of .ISI marked 1.1 KV grade FRLS PVC insulated multi strand copper wires erected in below type of pipe with 6A Modular type switches and following type of accessories erected on PVC / Metallic/Wooden box, single mounting base frame covered with textured / metallic/white front plate modules erected on / in wall / ceiling as per pipe erected. with necessary batten/angle holder or ceiling rose or H.D.Connector as directed.(f) with medium class Rigid PVC pipe and accessories erected concealed in wall/ceiling complete Cat. III	Pt.	560.55	Rupees Five Hundred Sixty and Paise Fifty Five Only	5605.50
153	41.00	Point wiring for Individual Plug with & earth wire of 1.5 sq.mm (Green) both are of ISI marked 1.1 KV grade FRLS PVC insulated multi strand copper wires up to 10 mtr length, in below type of pipe erected complete with Modular type switch & 5 pin Plug erected on PVC / Metallic/Wooden box covered with appropriate front plate modules erected on / in wall / ceiling as per pipe erected with following type of accessories.[I] For 6A Plug and 6 a switch with 2-1.5 sq.mm Cu. Wire from nearby switchboard/mcb db board.(f) with medium class Rigid PVC pipe and accessories erected concealed in wall/ceiling complete Cat. III	Pt.	473.69	Rupees Four Hundred Seventy Three and Paise Sixty Nine Only	19421.29

Schedule - B						
Item No.	Quantities estimated but may be more or less	Item of work	Unit	Tendered Rates		Total amount according to estimated quantities
				in figures	In Words	
154	40.00	Point wiring for Individual Plug with & earth wire of 1.5 sq.mm (Green) both are of ISI marked 1.1 KV grade FRLS PVC insulated multi strand copper wires up to 10 mtr length, in below type of pipe erected complete with Modular type switch & 5 pin Plug erected on PVC / Metallic/Wooden box covered with appropriate front plate modules erected on / in wall / ceiling as per pipe erected with following type of accessories.[II] For 16A Plug and 16 amp switch with 2-2.5 sq.mm Cu. Wire from mcb db board.(f) with medium class Rigid PVC pipe and accessories erected concealed in wall/ceiling complete Cat. III	Pt.	697.91	Rupees Six Hundred Ninety Seven and Paise Ninety One Only	27916.40
155	13.00	Point wiring for Individual Plug with & earth wire of 1.5 sq.mm (Green) both are of ISI marked 1.1 KV grade FRLS PVC insulated multi strand copper wires up to 10 mtr length, in below type of pipe erected complete with Modular type switch & 5 pin Plug erected on PVC / Metallic/Wooden box covered with appropriate front plate modules erected on / in wall / ceiling as per pipe erected with following type of accessories.[III] For 16A Plug and 16 amp switch with 2-4 sq.mm Cu. Wire with 2.5 sq.mm (green) earthing wire from mcb d b board.(f) with medium class Rigid PVC pipe and accessories erected concealed in wall/ceiling complete Cat. III	Pt.	818.10	Rupees Eight Hundred Eighteen and Paise Ten Only	10635.30
156	35.00	Point wiring for on board Looped Plug with 6A Modular type switch & 5 pin socket erected on PVC / Metallic/Wooden box, single mounting base frame covered with textured /metallic/white front plate modules erected on / in wall / ceiling with following type accessories Cat. III	Pt.	241.39	Rupees Two Hundred Forty One and Paise Thirty Nine Only	8448.65

Schedule - B						
Item No.	Quantities estimated but may be more or less	Item of work	Unit	Tendered Rates		Total amount according to estimated quantities
				in figures	In Words	
157	10.00	Providing following type of Modular Type Accessories mounted with PVC / metallic/Wooden box, single mounting base frame covered with textured / metallic/white front plate , modules erected with necessary connections as per site situation directed by Engineer In charge. (7) Blank Plate Single Cat.III	Ea	24.24	Rupees Twenty Four and Paise Twenty Four Only	242.40
158	100.00	Providing & Erecting approved make following size of TV Co-axial flexible cable comprising inner conductor of solid bare copper insulated with Foam PE & Secondary conductor made of poly- Aluminium film bonded Al. Braids @ suitable coverage overall sheathed with black PVC insulation. b).RG-6	Mtr	37.37	Rupees Thirty Seven and Paise Thirty Seven Only	3737.00
159	200.00	Supplying & erecting approved make Telephone Cable electrolytic copper conductor PE insulation twisted in two pairs, & wrapped with FRLS PVC tape & sheathed with FRLS PVC or HFFR outer Jacket suitable for telephone wiring & conforming to C-DOT erected in existing pipe. of following size of conductors & nos.of pairs. With necessary connections.[A] Conductor Size 0.5 mm (a) Unarmoured 2) Two Pairs	Mtr	19.19	Rupees Nineteen and Paise Nineteen Only	3838.00
160	200.00	Providing and erecting ISI mark Medium class RIGID PVC PIPES of following size complete to be erected on/in wall or ceiling erected with necessary PVC fittings & Junction boxes fixed with adhesive solution & Clamps with following dia of pipes, in approved manner as directed.(a)20 mm	Mtr	23.23	Rupees Twenty Three and Paise Twenty Three Only	4646.00
161	150.00	Providing and erecting ISI mark Medium class RIGID PVC PIPES of following size complete to be erected on/in wall or ceiling erected with necessary PVC fittings & Junction boxes fixed with adhesive solution & Clamps with following dia of pipes, in approved manner as directed.(b) 25 mm	Mtr	32.32	Rupees Thirty Two and Paise Thirty Two Only	4848.00

Schedule - B						
Item No.	Quantities estimated but may be more or less	Item of work	Unit	Tendered Rates		Total amount according to estimated quantities
				in figures	In Words	
162	50.00	Providing and fixing approved make Perforated C type cable tray. Made from pre- galvanized sheet steel. The cable tray should be bended as per IS 2062/1079 . with max 17.5% perforation with coupler plate / Fish plate and GI hardware like nut - bolt and washers etc. erected on existing support as per Specification and as per instruction of engineer in charge(3) 150 X 50 X 1.5 mm Thick	Mtr	322.19	Rupees Three Hundred Twenty Two and Paise Nineteen Only	16109.50
163	10.00	Providing following type of Modular Type Accessories mounted with PVC / metallic/Wooden box, single mounting base frame covered with textured / metallic/white front plate , modules erected with necessary connections as per site situation directed by Engineer In charge.(3)Two pin RJ-11 Telephone socket with top [A] For One Gang Cat. III	Ea.	153.52	Rupees One Hundred Fifty Three and Paise Fifty Two Only	1535.20
164	5.00	Providing following type of Modular Type Accessories mounted with PVC / metallic/Wooden box, single mounting base frame covered with textured / metallic/white front plate , modules erected with necessary connections as per site situation directed by Engineer In charge.(4) TV Co-axial Socket outlet Cat. III	Ea.	153.52	Rupees One Hundred Fifty Three and Paise Fifty Two Only	767.60
165	15.00	Providing & erecting Switch board for Computer or electric apparatus consisting of following modular type accessories mounted with PVC / Metallic concealed/open box with single mounting base frame covered with textured/metallic /white front plate,modules erected with necessary connections as directed. 1 no. 6A/16A universal plug-switch combined.3 nos. 6A Switch 3 nos. 6A 5 pin Plug .For Modular Type Accessories Cat.III	Ea.	1081.71	Rupees One Thousand Eighty One and Paise Seventy One Only	16225.65

Schedule - B

Item No.	Quantities estimated but may be more or less	Item of work	Unit	Tendered Rates		Total amount according to estimated quantities
				in figures	In Words	
166	80.00	<p>Supplying and erecting LED indoor fittings with LEDs of wattage 0.2 Watt to 0.5 Watt assembled on single MCPCB, with housing used as a heat sink shall be made of thick sheet Steel conforming to IS: 513/CRCA/ aluminium die cast powder coated and high U.V. & corrosion resistance with diffuser with company mark/name 160V to 270V, Power Factor more than 0.95, THD < 15%, CCT 3000 K to 6500K, Luminaire efficacy > 85 lumens/watt ,LED LED driver efficiency > 85 % (fitting required LM-79 & LM-80 Certificates)(NOTE: Below description have shown ranges of Wattage capacity of LED fittings.The Engineer incharge may select any wattage capacity between the ranges shown.) (A) Tube Light with integral driver (iv) 22-24 Watts, Surge - 2KV,IP-20, conventional 4 feet Cat-III</p>	Ea.	373.70	Rupees Three Hundred Seventy Three and Paise Seventy Only	29896.00

Schedule - B

Item No.	Quantities estimated but may be more or less	Item of work	Unit	Tendered Rates		Total amount according to estimated quantities
				in figures	In Words	
167	1.00	Supplying and erecting LED indoor fittings with LEDs of wattage 0.2 Watt to 0.5 Watt assembled on single MCPCB, with housing used as a heat sink shall be made of thick sheet Steel conforming to IS: 513/CRCA/aluminium pressure die cast powder coated and high U.V. & corrosion resistance with diffuser housed in aluminium casted body with company mark/name 160V to 270V, Power Factor more than 0.9, THD < 15 %, CCT 3000 K to 6500K, Luminaire efficacy > 85 lumens/watt, LED driver efficiency > 85 % (fitting required LM-79 & LM-80 Certificates)(NOTE: Below description have shown ranges of Wattage capacity of LED fittings.The Engineer incharge may select any wattage capacity between the ranges shown.) (A) Square/ Circular shaped Surface/Recessed Mount Downlight with provision for spring loaded mounting clips complete.IP20 (ii) 11-15 watts, Surge-2 KV Cat-III	Ea.	427.23	Rupees Four Hundred Twenty Seven and Paise Twenty Three Only	427.23

Schedule - B

Item No.	Quantities estimated but may be more or less	Item of work	Unit	Tendered Rates		Total amount according to estimated quantities
				in figures	In Words	
168	10.00	Supplying and erecting LED indoor fittings with LEDs of wattage 0.2 Watt to 0.5 Watt assembled on single MCPCB, with housing used as a heat sink shall be made of thick sheet Steel conforming to IS: 513/CRCA/aluminium pressure die cast powder coated and high U.V. & corrosion resistance with diffuser housed in aluminium casted body with company mark/name 160V to 270V, Power Factor more than 0.9, THD < 15 %, CCT 3000 K to 6500K, Luminaire efficacy > 85 lumens/watt, LED driver efficiency > 85 % (fitting required LM-79 & LM-80 Certificates)(NOTE: Below description have shown ranges of Wattage capacity of LED fittings.The Engineer incharge may select any wattage capacity between the ranges shown.) (A) Square/ Circular shaped Surface/Recessed Mount Downlight with provision for spring loaded mounting clips complete.IP20 (iv) 22-24 watts, Surge-2 KV Cat-III	Ea.	758.51	Rupees Seven Hundred Fifty Eight and Paise Fifty One Only	7585.10

Schedule - B						
Item No.	Quantities estimated but may be more or less	Item of work	Unit	Tendered Rates		Total amount according to estimated quantities
				in figures	In Words	
169	1.00	Supplying and erecting LED indoor fittings with LEDs of wattage 0.2 Watt to 0.5 Watt assembled on single MCPCB, with housing used as a heat sink shall be made of thick sheet Steel conforming to IS: 513/CRCA/aluminium pressure die cast powder coated and high U.V. & corrosion resistance with diffuser housed in aluminium casted body with company mark/name 160V to 270V, Power Factor more than 0.9, THD < 15 %, CCT 3000 K to 6500K, Luminaire efficacy > 85 lumens/watt , LED driver efficiency > 85 % (fitting required LM-79 & LM-80 Certificates)(NOTE: Below description have shown ranges of Wattage capacity of LED fittings.The Engineer incharge may select any wattage capacity between the ranges shown.) (I) Adjustable spot light with COB led having aluminium reflector of following wattage (iv) 30 Watts Cat-III	Ea.	2161.40	Rupees Two Thousand One Hundred Sixty One and Paise Forty Only	2161.40
170	2.00	Supplying and erecting approved make oscillating type bracket fan A.C. 230V. 50cy/s 400/450 mm sweep wall mounted with height adjustment and rotary tilting device complete with guard, flexible Core plug top complete erected with lead wires as directed. Cat.II	Ea.	2534.09	Rupees Two Thousand Five Hundred Thirty Four and Paise Nine Only	5068.18
171	45.00	Providing & erecting Approved make Power Saving 50 Watt Ceiling Fan with double ball bearing ISI mark with Condenser 230 volt A.C. 50 Hz 1200 mm sweep complete having 3blades with aluminium blades with , canopy & 30 cm. down rod erected with earthing.(Make shall be approved by Engineer in charge))	Ea.	1948.29	Rupees One Thousand Nine Hundred Forty Eight and Paise Twenty Nine Only	87673.05

Schedule - B						
Item No.	Quantities estimated but may be more or less	Item of work	Unit	Tendered Rates		Total amount according to estimated quantities
				in figures	In Words	
172	45.00	Supplying & erecting fan hook box of 10 mm M.S. round bar bounded to the RCC bars up to 50mm length each side and pierced through a 16 Gauge M.S. box / Heavy Duty PVC box complete erected concealed in Ceiling with necessary finishing.	Ea.	108.07	Rupees One Hundred Eight and Paise Seven Only	4863.15
173	45.00	Providing 2.5mm.thick laminated acrylic sheet to cover the fan hook or Fan box.	Ea.	18.18	Rupees Eighteen and Paise Eighteen Only	818.10
174	15.00	Supplying & erecting approved make low noise decorative exhaust fan having square frame ABS body with inbuilt lowers & square frame.250mm with 1350 RPM Cat.II	Ea.	1366.53	Rupees One Thousand Three Hundred Sixty Six and Paise Fifty Three Only	20497.95
175	22.00	Supplying and erecting 19 / 20 mm. nominal bore Medium Class M.S. Pipe down rod erected duly painted for fan complete with proper insulation without leakage and earthing.	Mtr.	108.07	Rupees One Hundred Eight and Paise Seven Only	2377.54
176	2.00	Providing & erecting water cooler having storage capacity 150 Ltr. & cooling capacity 150 Ltr.per hour @ an ambient temp of 45° C. The outlet temp. of the water should drop by 15°C within a hour, The water cooler should be comprising of hermetically sealed compressor, fan motor, condensing unit, water tank surrounded by evaporating, coil, thermostats, relay etc.complete with necessary inlet & outlet connection. The body of water cooler will be made from Stainless Steel.	Ea.	46648.87	Rupees Forty Six Thousand Six Hundred Forty Eight and Paise Eighty Seven Only	93297.74

Schedule - B						
Item No.	Quantities estimated but may be more or less	Item of work	Unit	Tendered Rates		Total amount according to estimated quantities
				in figures	In Words	
177	2.00	Supplying & erecting 5 stage single reverse osmosis water purification system with M.S. powder coated frame, prefilter housing with 'O' ring presediment filter GAC filter, carbon filter suitable buster DC pump capacity 80 psi, mention with 40 psi inline type post carbon filter auto low & high pressure switches with following size of storage tank & LPH capacity & erected as directed [C] 50 Ltr / Hr with 150 psi 2 nos booster pump	Ea.	24394.53	Rupees Twenty Four Thousand Three Hundred Ninety Four and Paise Fifty Three Only	48789.06
178	30.00	Supplying & erecting UPVC Mini trunking (PVC Casing-n-Capping) having double-locking arrangement with grooves, trunking of size not below 12.5 mm in height as per IS with accessories of PVC/Resin polypropylene not below 1.8 mm thick duly sealed in joint & erected on wall / ceiling of following size .(2) 25 mm	Mtr.	30.30	Rupees Thirty and Paise Thirty Only	909.00
179	5.00	Supplying & erecting Approved make call bell indicator with buzzing sound and Red light indicating lamp with Red light button to attend the call suitable for 240 v 50 c/s supply to be erected.	Ea.	142.41	Rupees One Hundred Forty Two and Paise Forty One Only	712.05
180	1.00	Supplying and erecting approved make Single phase power conditioners suitable for input voltage 180V / 280V, output voltage 220V (+ / - 10%) AC 50 'Hz with electronic relays & component of housed in sheet metal cabinet 'with epoxy powder coated, with high - low cut-off, time delay, voltmeter, selector switch, 5/15 A universal socket with range off (E) 5 KVA	Ea.	3124.94	Rupees Three Thousand One Hundred Twenty Four and Paise Ninety Four Only	3124.94

Schedule - B						
Item No.	Quantities estimated but may be more or less	Item of work	Unit	Tendered Rates		Total amount according to estimated quantities
				in figures	In Words	
181	1.00	Supplying and erecting approved make online Un-interruptible Power Supply system comprising flat cum-boost charger with IGBT base rectifier & Inverter & sealed maintenance free SMF batteries. The charger having operating capacity for input 160-270V AC & inverter having output 230V,50 Hz Ac with 0.8 load power factor with battery, over/under voltage output with over load & short circuit protection equipment. The system housed in CRC sheet duly powder coated paint with following power backup.with MS painted batteries stand, 10% Overload capacity for momentary load. (A) 1 KVA with 1Hr Backup	Ea	24822.77	Rupees Twenty Four Thousand Eight Hundred Twenty Two and Paise Seventy Seven Only	24822.77
182	100.00	Supplying & erecting approved make LAN cable of following size in existing pipe as per direction [C] CAT - 6	Mtr	45.45	Rupees Forty Five and Paise Forty Five Only	4545.00
183	10.00	Supply & installation of modular type accessories for U PVC snap-on adaptable trunking/Pop up Box with required items erected with necessary connection. As desired by Engineer In charge vi) Cat-6 LAN Socket cat-III	Ea	540.35	Rupees Five Hundred Forty and Paise Thirty Five Only	5403.50
184	20.00	Supplying and laying UPVC cable trunking system comprising unplasticised polyvinyl, chloride rigid material with ignition free and flame proof confirming BS with necessary end caps Internal and external bend, flat bends, coupler, tee etc..All necessary accessories and measuring of following sizes (1) 75 mm x 50 mm trunking	Mtr	265.63	Rupees Two Hundred Sixty Five and Paise Sixty Three Only	5312.60
185	30.00	Supplying and laying UPVC cable trunking system comprising unplasticised polyvinyl, chloride rigid material with ignition free and flame proof confirming BS with necessary end caps Internal and external bend, flat bends, coupler, tee etc..All necessary accessories and measuring of following sizes (2) 100 mm x 50 mm trunking	Mtr	409.05	Rupees Four Hundred Nine and Paise Five Only	12271.50

Schedule - B						
Item No.	Quantities estimated but may be more or less	Item of work	Unit	Tendered Rates		Total amount according to estimated quantities
				in figures	In Words	
186	40.00	Supply & installation of surface mounted U PVC snap-on adaptable trunking raceways, fabricated out of U-PVC to Off-White or approved shade as per IS 733 of thickness 2.0mm for the base and sides with all accessories like removable covers, joints ,height spacer,angles complete with necessary bends, suitable sized junction boxes and tees etc, Complete. (a)Size: 50x80mm PVC Raceways for Power & Data with 2 compartments above specifications.	Mtr	1013.03	Rupees One Thousand Thirteen and Paise Three Only	40521.20
187	1.00	SITC of 3LCD Lamp based projector having wxga (1280x800) or better resolution with minimum white brightness of 3800 lumens and color brightness of 3800 lumens. The projector should have minimum 1HDMI,1VGA input. Having contrast ratio of 15000:1 or more. the projector should have auto vertical key stone correction of +/- 30 degree and Manual Horizontal of +/-30 degree. the projector should have optical lens, throw ratio 1.30-1.56:1. Zoom Factor of 1.2. Lens focus Manual having focal length 16.9mm to 20.28mm. projector should have features like AV mute slide, quick corner and split function and should support wireless functionality with inbuilt wifi or wifi dongle. [Approved by Competent Authority i.e. not Below the rank of Executive Engineer]	Ea	33895.60	Rupees Thirty Three Thousand Eight Hundred Ninety Five and Paise Sixty Only	33895.60
188	1.00	SITC of universal Projector mounting kit, with necessary grouting, fasteners etc. with adjustable height and suitable for all types of projectors. [Approved by Competent Authority i.e. not Below the rank of Executive Engineer]	Ea	6848.81	Rupees Six Thousand Eight Hundred Forty Eight and Paise Eighty One Only	6848.81

Schedule - B						
Item No.	Quantities estimated but may be more or less	Item of work	Unit	Tendered Rates		Total amount according to estimated quantities
				in figures	In Words	
189	1.00	SITC of 84 inch Self Lock MW (6 x 4) Instalock Slow Retraction Screen, Aspect Ratio-4:3 [Approved by Competent Authority i.e. not Below the rank of Executive Engineer]	Ea	3379.46	Rupees Three Thousand Three Hundred Seventy Nine and Paise Forty Six Only	3379.46
190	5.00	LG 139 cm (55 Inch) 4K ultra HD Smart LED TV (55UR7500PSC)	Ea	44429.90	Rupees Forty Four Thousand Four Hundred Twenty Nine and Paise Ninety Only	222149.50
191	60.00	Providing and erecting Miniature circuit breaker single pole 6A to 25A suitable to operate on 240 V A.C. system and having breaking capacity 10 KA to be erected in existing box. confirming to IS 8828/1996 with ISI Mark Cat.III	Ea.	112.11	Rupees One Hundred Twelve and Paise Eleven Only	6726.60
192	8.00	providing and erecting Miniature circuit breaker single pole 0.5A to 2A system and having breaking capacity 10 KA to be erected in existing box. confirming to IS 8828/1996 with ISI Mark Cat.III	Ea.	270.68	Rupees Two Hundred Seventy and Paise Sixty Eight Only	2165.44
193	3.00	Providing & erecting 415 V MCB Four Pole for Motor & Inductive Load (C Curve) having 10KA breaking capacity & confirms to IS :8828 in existing box having following capacity (c)63 Amp Cat.III	Ea.	737.30	Rupees Seven Hundred Thirty Seven and Paise Thirty Only	2211.90
194	2.00	Providing & erecting 415 V MCB Four Pole for Motor & Inductive Load (C Curve) having 10KA breaking capacity & confirms to IS :8828 in existing box having following capacity (b)40 Amp. Cat.III	Ea.	668.62	Rupees Six Hundred Sixty Eight and Paise Sixty Two Only	1337.24
195	1.00	Providing & erecting 240 V MCB double pole switch for lighting Load (B Curve) having 10 KA breaking capacity & confirms to IS : 8828 in existing box having following capacity (B) 40 Amp. Cat.III	Ea.	295.93	Rupees Two Hundred Ninety Five and Paise Ninety Three Only	295.93

Schedule - B						
Item No.	Quantities estimated but may be more or less	Item of work	Unit	Tendered Rates		Total amount according to estimated quantities
				in figures	In Words	
196	1.00	Providing and erecting Approved make RCCBs conforming to IS: 12640 and having sensitivity of 30 mA and Short Circuit withstand capacity of 10 KA and suitable for operation on 3 phase and neutral 415V,50Hz. having characteristic of quick action & tripping with all advance feature & do not incorporate any electronic component for following Max. rating erected as directed. (iv) 100 Amps. FP (100 mA Sensitivity) Cat. III	Ea.	4314.72	Rupees Four Thousand Three Hundred Fourteen and Paise Seventy Two Only	4314.72
197	6.00	providing and erecting Approved make RCCBs conforming to IS: 12640 and having sensitivity of 30 mA and Short Circuit withstand capacity of 10 KA and suitable for operation on single phase 240 V,50Hz. having characteristic of quick action & tripping with all advance feature & do not incorporate any electronic component. for following Max. rating erected as directed (i) 25 Amps.DP Cat. III	Ea.	1969.50	Rupees One Thousand Nine Hundred Sixty Nine and Paise Fifty Only	11817.00
198	3.00	Providing and erecting Sheet Steel powder coated MCB distribution board - flush / surface mounted fitted with busbar, neutral link, earth bar and DIN rail, Conforms to IS 8623-1 & 3, IEC 61439-1 & 3 without MCB to house appropriate nos. of MCBs.(The DBs should be used of same company of MCB to be used) suitable for (B) three phase incoming and single phase horizontal type outgoing Per phase isolation type (PPI) (b) sheet steel double door (iii)8 way	Ea	3412.79	Rupees Three Thousand Four Hundred Twelve and Paise Seventy Nine Only	10238.37

Schedule - B						
Item No.	Quantities estimated but may be more or less	Item of work	Unit	Tendered Rates		Total amount according to estimated quantities
				in figures	In Words	
199	1.00	Providing and erecting Sheet Steel powder coated MCB distribution board - flush / surface mounted fitted with busbar, neutral link, earth bar and DIN rail, Conforms to IS 8623-1 & 3, IEC 61439-1 & 3 without MCB to house appropriate nos. of MCBs.(The DBs should be used of same company of MCB to be used) suitable for (A) single phase incoming and horizontal single phase outgoing (b) sheet steel double door (IP-43) ((iii)8 way	Ea	1152.41	Rupees One Thousand One Hundred Fifty Two and Paise Forty One Only	1152.41
200	10.00	Supplying & erecting approved make RCCB + MCB (Electro magnetic type only) working on residual current device having 10 KA short circuit breaking capacity and 30 mAmp. Sensitivity & 30 milli sec. tripping time conforming to IS 12640 test knob facility trip free mechanism operating for rated leakage at nominal ten volt, complete erected including all materials lugs screws etc. completed. [a] 6A / 10A / 16A / 20A / 25A 2 pole single phase Cat. II	Ea	1815.98	Rupees One Thousand Eight Hundred Fifteen and Paise Ninety Eight Only	18159.80
201	1.00	Providing and erecting Approved make Four pole moulded case circuit breaker having breaking capacity ICU of 25 KA. at 415 V, having normal current rating up to 25 A to 100A. with Fixed thermal & magnetic release suitable to work on A.C. supply 50 c/s. with all internal connections, spreader tinned copper & complete erected in existing 16 G.M.S. housing. ICS=100% of ICU only Cat III	Ea.	6173.12	Rupees Six Thousand One Hundred Seventy Three and Paise Twelve Only	6173.12

Schedule - B						
Item No.	Quantities estimated but may be more or less	Item of work	Unit	Tendered Rates		Total amount according to estimated quantities
				in figures	In Words	
202	1.20	Providing and erecting busbar chamber conforming to IS-375 fabricated from 16 G.M.S. sheet, dust & vermin proof having hinged door with rubber gasket and necessary busbar supports with COPPER busbar having current density not more than 1.6 Amp. / sq.mm (Rated current / cross section area) duly wrapped with colour insulation tape for phase sequence, three phase & neutral each suitable for following current capacity with necessary painting mounted on wall or pedestal frame of required size with necessary connections. (B) Suitable for 200 Amp. capacity	Rn.Mtr	5731.75	Rupees Five Thousand Seven Hundred Thirty One and Paise Seventy Five Only	6878.10
203	7.00	Sheets steel powder coated enclosure suitable for incorporating One/Two nos. MCB.	Ea.	176.75	Rupees One Hundred Seventy Six and Paise Seventy Five Only	1237.25
204	1.00	Providing and erecting metallic vitrified danger notice board as per language suggested by engineer incharge for MEDIUM VOLTAGE installation to be erected as per IS-2551.	Ea	69.69	Rupees Sixty Nine and Paise Sixty Nine Only	69.69
205	150.00	Providing and erecting Mains with 1.1 KV grade FRLS PVC insulated ISI marked stranded Copper conductor wire in following type of pipe to be erected in / on wall / ceiling with 2.5 sq. mm copper conductor FRLS PVC insulated stranded wire of green colour for earth continuity of following size(A) with medium class Rigid PVC pipe and accessories.(a) 2 wire 4 sq. mm	Mtr	107.06	Rupees One Hundred Seven and Paise Six Only	16059.00

Schedule - B						
Item No.	Quantities estimated but may be more or less	Item of work	Unit	Tendered Rates		Total amount according to estimated quantities
				in figures	In Words	
206	30.00	Providing and erecting Mains with 1.1 KV grade FRLS PVC insulated ISI marked stranded Copper conductor wire in following type of pipe to be erected in / on wall / ceiling with 2.5 sq. mm copper conductor FRLS PVC insulated stranded wire of green colour for earth continuity of following size(A) with medium class Rigid PVC pipe and accessories.(b) 2 wire 6 sq. mm	Mtr	140.39	Rupees One Hundred Forty and Paise Thirty Nine Only	4211.70
207	50.00	Providing and erecting Mains with 1.1 KV grade FRLS PVC insulated ISI marked stranded Copper conductor wire in following type of pipe to be erected in / on wall / ceiling with 2.5 sq. mm copper conductor FRLS PVC insulated stranded wire of green colour for earth continuity of following size(A) with medium class Rigid PVC pipe and accessories.(h) 4 wire 6 sq. mm	Mtr	248.46	Rupees Two Hundred Forty Eight and Paise Forty Six Only	12423.00
208	50.00	Supplying & erecting Flexible PVC insulated multistrand multicore 1.1 KV grade ISI marked Copper Wires of following Size to be erected as directed.(j) 4.00 Sq.mm 3 core round PVC sheathed	Mtr.	121.20	Rupees One Hundred Twenty One and Paise Twenty Only	6060.00
209	50.00	Providing and erecting XLPE(IS:7098)(l) 88 ISI armoured cable multistrand Copper conductor for 1.1 KV. to be laid on wall with necessary clamps or in existing trench / pipe at road crossing or floor of following size of cable.(A) 3 core 2.5Sq. mm	Mtr	213.11	Rupees Two Hundred Thirteen and Paise Eleven Only	10655.50
210	50.00	Providing and erecting XLPE(IS:7098)(l) 88 ISI armoured cable multistrand Copper conductor for 1.1 KV. to be laid on wall with necessary clamps or in existing trench / pipe at road crossing or floor of following size of cables.(A) 4 core 10 Sq. mm	Mtr	673.67	Rupees Six Hundred Seventy Three and Paise Sixty Seven Only	33683.50

Schedule - B						
Item No.	Quantities estimated but may be more or less	Item of work	Unit	Tendered Rates		Total amount according to estimated quantities
				in figures	In Words	
211	150.00	Providing and erecting XLPE(IS:7098)(I) 88 ISI armoured cable multistrand / Solid Copper conductor for 1.1 KV. to be laid on wall with necessary clamps or in existing trench / pipe at road crossing or floor of following size of cables. (C) 4 core 6 Sq. mm	Mtr	508.03	Rupees Five Hundred Eight and Paise Three Only	76204.50
212	50.00	Providing and erecting XLPE(IS:7098)(I) 88 ISI armoured cable multistrand Copper conductor for 1.1 KV. to be laid on wall with necessary clamps or in existing trench / pipe at road crossing or floor of following size of cables. (B) 4 core 16 Sq. mm	Mtr	984.75	Rupees Nine Hundred Eighty Four and Paise Seventy Five Only	49237.50
213	8.00	Providing and, fixing heavy duty flange type brass cable gland with rubber ring for PVC insulated armoured cable complete with out going tails, insulating tape etc for following size of cables. (D) 2 to 4 core 16 Sq. mm	Ea.	47.47	Rupees Forty Seven and Paise Forty Seven Only	379.76
214	24.00	Providing and, fixing heavy duty flange type brass cable gland with rubber ring for PVC insulated armoured cable complete with out going tails, insulating tape etc for following size of cables. (B) 2 to 4 core 6 Sq. mm	Ea.	38.38	Rupees Thirty Eight and Paise Thirty Eight Only	921.12
215	8.00	Providing and, fixing heavy duty flange type brass cable gland with rubber ring for PVC insulated armoured cable complete with out going tails, insulating tape etc for following size of cables. (C) 2 to 4 core 10 Sq. mm	Ea.	38.38	Rupees Thirty Eight and Paise Thirty Eight Only	307.04
216	96.00	Solder less crimping type Copper lugs conforming to IS suitable for cable of following size evenly crimped with high pressure tool & connected to switchgear terminals with brass/cadmium plated nut bolts in an approved manner. (A) 1.5/2.5 to 6 Sq.mm	Ea.	8.08	Rupees Eight and Paise Eight Only	775.68

Schedule - B						
Item No.	Quantities estimated but may be more or less	Item of work	Unit	Tendered Rates		Total amount according to estimated quantities
				in figures	In Words	
217	32.00	Solder less crimping type Copper lugs conforming to IS suitable for cable of following size evenly crimped with high pressure tool & connected to switchgear terminals with brass/cadmium plated nut bolts in an approved manner. (B) 10 Sq.mm	Ea.	10.10	Rupees Ten and Paise Ten Only	323.20
218	32.00	Solder less crimping type Copper lugs conforming to IS suitable for cable of following size evenly crimped with high pressure tool & connected to switchgear terminals with brass/cadmium plated nut bolts in an approved manner. (C) 16 Sq.mm.	Ea.	12.12	Rupees Twelve and Paise Twelve Only	387.84
219	50.00	Providing and erecting Mains with ISI marked, 1.5KV grade electrolyte multi stranded, annealed copper conductor with heat resistant PVC insulated conforms to IS 694, IEC - 227 erected in existing pipe of following size (Specifically for control panel, relays, power switchgears, motor starters & control wiring) with required size of copper lugs, nuts and bolts if required.(b) One wire 1.50 sq. mm	Mtr	16.16	Rupees Sixteen and Paise Sixteen Only	808.00
220	40.00	(c) One wire 2.50 sq. mm	Mtr	26.26	Rupees Twenty Six and Paise Twenty Six Only	1050.40
221	40.00	(e) One wire 6.00 sq. mm	Mtr	53.53	Rupees Fifty Three and Paise Fifty Three Only	2141.20
222	40.00	(f) One wire 10.00 sq. mm	Mtr	87.87	Rupees Eighty Seven and Paise Eighty Seven Only	3514.80

Schedule - B						
Item No.	Quantities estimated but may be more or less	Item of work	Unit	Tendered Rates		Total amount according to estimated quantities
				in figures	In Words	
223	15.00	(g) One wire 16.00 sq. mm	Mtr	135.34	Rupees One Hundred Thirty Five and Paise Thirty Four Only	2030.10
224	10.00	(h) One wire 25.00 sq. mm	Mtr	225.23	Rupees Two Hundred Twenty Five and Paise Twenty Three Only	2252.30
225	150.00	Making trench in soft soil of suitable width of 90 cm deep for laying cable or locating the fault all over the run and back filling the same and making the surface as normal ground.	Mtr.	46.46	Rupees Forty Six and Paise Forty Six Only	6969.00
226	150.00	Providing & laying approved make Double walled corrugated pipes (DWC) of polyethylene(conforming to IS 14930 II)with necessary connecting accessories of same material at required depth in existing trench for laying of cable. below ground / road surface for enclosing cable (A)50 mm outer dia.	Mtr.	62.62	Rupees Sixty Two and Paise Sixty Two Only	9393.00
227	30.00	Providing & laying approved make Double walled corrugated pipes (DWC) of polyethylene(conforming to IS 14930 II)with necessary connecting accessories of same material at required depth in existing trench for laying of cable. below ground / road surface for enclosing cable (D)120 mm outer dia.	Mtr.	137.36	Rupees One Hundred Thirty Seven and Paise Thirty Six Only	4120.80

Schedule - B						
Item No.	Quantities estimated but may be more or less	Item of work	Unit	Tendered Rates		Total amount according to estimated quantities
				in figures	In Words	
228	50.00	Providing and erecting ISI marked PVC insulated PVC Sheathed Flat flexible Submersible copper cable approved make of following Size. (C) 3 Core x 4 Sq. mm	Mtr.	146.45	Rupees One Hundred Forty Six and Paise Forty Five Only	7322.50
229	20.00	Providing & laying. R.C.C. Hume pipe for cable to be laid 90 cm. below ground across the road crossing or on floor with necessary material in an approved manner and making the ground as per original.(E)150 mm dia	Mtr.	263.61	Rupees Two Hundred Sixty Three and Paise Sixty One Only	5272.20
230	4.00	Supplying & erecting earth pit of minimum bore dia.150mm size approved make Earthing Electrode consisting Pipe-in-Pipe Technology as per IS 3043-1987 made of corrosion free hot dipped G.I.Pipes having Outer pipe dia of 50mm having 80-200 Micron galvanising, Inner pipe dia of 25 mm having 200- 250 Micron galvanising, connection terminal dia of 12mm with constant ohmic value surrounded by highly conductive compound with high charge dissipation suitable for following type of applications with chamber and heavy duty cover.(approved make OEM has to submit test certificate) & having back filling compound of (B) Inner chemical (CCM Compound)- Resistivity:- 0.2 • / meter testing as per IEC 62561-2017, Voltage drop:- < 1 volt at no load & dry form, Sulphar content:- <2%(C) Back fill Compound :- Earthing compound should be capable to retainmoisture for long time Necessary test report must be submitted.(c) For Electrical Installation covering Transformer Neutrals, Lightning arrester Earthing, A.C.Plant & Sensitive Computer System(like Automation,	Ea.	5760.03	Rupees Five Thousand Seven Hundred Sixty and Paise Three Only	23040.12
231	8.00	Providing and erecting Pipe type earthing having 150 cms.long and 2.5 cms. dia. galvanised iron pipe with coupling and buch buried in specially prepared earth pit complete with necessary 8 SWG earth wire. - to be used for each Street Light	Ea.	368.65	Rupees Three Hundred Sixty Eight and Paise Sixty Five Only	2949.20

Schedule - B						
Item No.	Quantities estimated but may be more or less	Item of work	Unit	Tendered Rates		Total amount according to estimated quantities
				in figures	In Words	
232	8.00	For using salt and charcoal / coke as required for pipe type earthing.	Ea.	171.70	Rupees One Hundred Seventy One and Paise Seventy Only	1373.60
233	6.00	Providing one bag of 25 Kg. Additional Back Filling Compound (BFC) suitable for safe earthing device.	Ea.	707.00	Rupees Seven Hundred Seven and Paise Zero Only	4242.00
234	10.00	Providing and erecting required size HOT deep Galvanised iron strip for earthing of H.T. , OCB/ ACB/ Transformer LT panel board, Motors etc. using proper clamp.	Kg	794.87	Rupees Seven Hundred Ninety Four and Paise Eighty Seven Only	7948.70
235	1.00	Providing pair of rubber hand gloves suitable for working on 11 KV/22 KV supply.	Ea	214.12	Rupees Two Hundred Fourteen and Paise Twelve Only	214.12
236	1.00	providng and erecting Approved make. energy meter 3 phase 4 wire unbalanced load 500 V.50A / 100A complete erected as directed with necessary earth wire. Cat. III	Ea	2611.86	Rupees Two Thousand Six Hundred Eleven and Paise Eighty Six Only	2611.86
237	1.00	providng and erecting Suitable set of CTS for 100A Energy Meter	Ea	2105.85	Rupees Two Thousand One Hundred Five and Paise Eighty Five Only	2105.85
238	4.00	Supplying rubber matting of following thickness as per IS:15652/IEC 61111 (b)4mm (LT PANEL, DG SET)	Sq. Mtr	1027.17	Rupees One Thousand Twenty Seven and Paise Seventeen Only	4108.68
239	6.00	Providing & erecting L.T. Current Transformer with bar primary 50/5 to 1000/5 ratio 15 VA burden erected in existing CRCA box duly secured with insulating materials connected to the meter	Ea.	274.72	Rupees Two Hundred Seventy Four and Paise Seventy Two Only	1648.32

Schedule - B						
Item No.	Quantities estimated but may be more or less	Item of work	Unit	Tendered Rates		Total amount according to estimated quantities
				in figures	In Words	
240	6.00	Supplying and erecting approved make set of indicator lamps of LED type lamp, lens cover, Bakelite holder complete erected with necessary connections.	Ea.	43.43	Rupees Forty Three and Paise Forty Three Only	260.58
241	1.00	Supplying and erecting approved make panel mounting type Digital Voltmeter having 3 digits LED display, 0 to 750 AC Volts range erected on existing panel board with all connection, wiring etc .with manufacturers calibration certificate.	Ea.	1275.63	Rupees One Thousand Two Hundred Seventy Five and Paise Sixty Three Only	1275.63
242	1.00	Supplying and erecting approved make panel mounting type Digital Ammeter having 3 digits LED display, external CT operated, calibrated for 0 to 1000 Amps suitable to operate on 500 Volt AC , erected on existing panel board with all connection, wiring etc .with manufacturers calibration certificate.	Ea.	1558.43	Rupees One Thousand Five Hundred Fifty Eight and Paise Forty Three Only	1558.43
243	1.00	Supplying & erecting approved make Power Factor Meter 150mm dia flush/projection type/ balanced & unbalanced load to work with appropriately provided CT's 100/5A to 400/5A ratio & other accessories complete erected in M.S. box & connected to the circuit by means of PVC copper Core leads.	Ea.	5102.52	Rupees Five Thousand One Hundred Two and Paise Fifty Two Only	5102.52
244	2.00	Providing & erecting open well type horizontal mono block pump set with stainless steel body having following specification (C) 1 H.P. single phase open well motor pump set suitable for 185 LPM discharge @ 25 mtr. head, suitable for 32 mm dia. Delivery pipe with control panel. Cat. II	Ea.	9613.18	Rupees Nine Thousand Six Hundred Thirteen and Paise Eighteen Only	19226.36

Schedule - B						
Item No.	Quantities estimated but may be more or less	Item of work	Unit	Tendered Rates		Total amount according to estimated quantities
				in figures	In Words	
245	1.00	Supplying & erecting approved make motor control cubical panel [Star delta] made from 16G CRCA sheet duly epoxy powder painted inside and outside with hinged doors and locking with suitable size of ON - OFF isolator (AC 3 / 23 duty) main fuses. Digital volt and current meter (in a single unit) with micro controller based control unit and current sensing single phasing preventer electronic overload protection, over voltage (Programmable) protection and under voltage (Programmable) protection, prodless dry run protection programming facility for setting of all parameter like overload current, high voltage limit, low voltage limit, dry run limit with digital indication on seven segment LED display for any fault like over load, high voltage, low voltage, dry running single crimped, electronic star delta timer, feather touch start / stop push buttons to be erected on angle iron frame. Grouted on wall the contactors will be of L& T, Siemens, BCH make only) (a) DOL up to 5.0 H.P	Ea.	7250.79	Rupees Seven Thousand Two Hundred Fifty and Paise Seventy Nine Only	7250.79
246	1.00	Supplying & erecting approved make Automatic liquid level controller 6A.as per instruction of Engineer in charge on site complete with wiring connection with existing wires , with copper conductor from pump to upper and lower tank.(Size Not less than 1.5 Sq MM) from pump to upper and lower tank with ISI marked Rigid PVC Pipe.	Ea	2355.32	Rupees Two Thousand Three Hundred Fifty Five and Paise Thirty Two Only	2355.32

Schedule - B						
Item No.	Quantities estimated but may be more or less	Item of work	Unit	Tendered Rates		Total amount according to estimated quantities
				in figures	In Words	
247	8.00	Supplying and erecting approved make Octagonal pole made from HR sheet steel. The pole should be made as per IS. and shall be coated with hot dip galvanizing as per IS 2629/2633/4759, suitable suspend local wind speed with integral Junction box consist of terminal plate of min 6mm Hylam sheet, standard profile 35mmX7.5mm Din-Rail for MCB Mounting, stud type terminal and arrangement for cable termination to be erected With Suitable foundation (Included) as per details given by manufacturer considering site requirement. (D) 6 Mtr. Long 70 mm Top X 135 mm bottom dia, 3 mm thickness with 200mmX200mmX12mm base plate, 4-M20 Bolts and 600mm long with necessary G.I. J Bolts .Approx Pole weight 59 kg	Ea.	8192.11	Rupees Eight Thousand One Hundred Ninety Two and Paise Eleven Only	65536.88
248	8.00	Providing and erecting Street Light pole bracket comprising main B Class MS pipe of 4.2 cm/require outside dia. complete with suitable B Class M.S. sleeve tubing of approx. 45cms.length and suitable for 76.5 mm /80mm / required size of pole top having sufficient fasteners for fixing the brackets and having spread of 1.5.mtr. length with 110 deg.with vertical plane & suitable welded stays, reducer and with check nuts complete painted with one coat of Red oxide / PU base primer and two coats of Aluminium / PU paint. paint with following nos of arms [A] Single Arm Bracket 1.5 Mtr	Ea	626.20	Rupees Six Hundred Twenty Six and Paise Twenty Only	5009.60

Schedule - B						
Item No.	Quantities estimated but may be more or less	Item of work	Unit	Tendered Rates		Total amount according to estimated quantities
				in figures	In Words	
249	8.00	Supplying & erecting approved make SMC press moulded composite FRP . loop-in, loopout approx. 2mm thick box complete with Bakelite connector strip 5way(3P+N+E),DIN rail for mounting mob & hinged doors as per requirement having locking arrangements with mounting clamp with nuts, bolts & washers suitable for erection on pole with cable clamps& earth bolt of following size of box.(a) 300mm x 200mm x 100mm [deep]	Ea	898.90	Rupees Eight Hundred Ninety Eight and Paise Ninety Only	7191.20
250	8.00	Providing and erecting iron clad cable route marker duly marked with ELE.CABLE of size 23 cm.X 12 cm. Flushed with ground in cement foundation as directed by Engineer in charge.	Ea	240.38	Rupees Two Hundred Forty and Paise Thirty Eight Only	1923.04
251	16.00	Supplying and erecting B class Galvanized iron pipe having smooth finished bore of the pipe on both ends erected nuts and bolts along the pole / wall shaping the pipe as per site requirement. Pipe dia as following.(a) 25 mm dia	Mtr.	180.79	Rupees One Hundred Eighty and Paise Seventy Nine Only	2892.64
252	8.00	Providing 1:2:4 cement concrete foundation & 70 % PCC from bottom including excavation for the pole of size 45 x 45 x 100 cm. Deep in below ground level with plinth of 45 cm x 45 cm (or 45 cm dia x 45 cm) high upper ground level with necessary curing and finishing in approved manner.(for 4 & 6 mtr pole)	Ea.	809.01	Rupees Eight Hundred Nine and Paise One Only	6472.08

Schedule - B						
Item No.	Quantities estimated but may be more or less	Item of work	Unit	Tendered Rates		Total amount according to estimated quantities
				in figures	In Words	
253	8.00	Supplying and erecting LED street light / Flood light fittings with High power White LEDs wattage of 1Watt and above assembled on single MCPCB, efficiency more than 130 lm/w and corrosion free High pressure die cast aluminum housing with smooth finish powder coated and heat sink extruded aluminium with diffuser and Polycarbonate optics/ lenses with company mark/name engraved or embossed 120 to 300 V,Power Factor more than 0.95, THD < 10 %, CCT 3000 K to 5700K, Uniformity ratio >0.45, Luminaire efficacy> 100 lumens/watt . LED driver efficiency > 85 %.CREE /OSRAM / PHILIPS Lumileds / NICHIA / SEOUL/ BridgeLux (U.S.A.) make LED used for luminaire. (fittings required LM-79 & LM-80 certificates)(NOTE: Below description have shown ranges of Wattage capacity of LED fittings.The Engineer incharge may select any wattage capacity between the ranges shown.) (A) Street Light (IP-65), Surge protection - 4KV integral and 10 kv non integral ,Light must have 440VAC line supply protection. It should withstand 48 hours for 440VAC line supply.(e) above 48	Ea	4997.48	Rupees Four Thousand Nine Hundred Ninety Seven and Paise Forty Eight Only	39979.84
254	1.00	Supplying & erecting approved make Digital time switch having lithium cell 6 years operative and operate battery backup 1 channel day clock with 14 memory programme, suitable to operate on 240V + 5%, 16A with, floating contacts Minimum switching setup time 1 minimum & LCD display. Also comprised permanent ON/OFF switching. Programming switches & housed in fire proof thermoplastic enclosure & transparent cover erected as required with necessary connection erected as directed.	Ea	3168.37	Rupees Three Thousand One Hundred Sixty Eight and Paise Thirty Seven Only	3168.37

Schedule - B						
Item No.	Quantities estimated but may be more or less	Item of work	Unit	Tendered Rates		Total amount according to estimated quantities
				in figures	In Words	
255	1.00	Supply of Fibreglass Platform Step (A Type) Ladder - 18 FT having following specifications : It should have large fully serrated platform 15" wide 20" deep which locks ladder , Aluminium feet with thick rubber tread, top rail guard to serve as a railing, two pairs of gusset support at the bottom step and All gussets are heavy duty steel. Capacity : 300 lbs.	Ea.	33895.60	Rupees Thirty Three Thousand Eight Hundred Ninety Five and Paise Sixty Only	33895.60
256	1.00	Supplying, Erecting, Testing & Commissioning the passenger / stretcher lift having following main features:The Rates of the following items are for the lift without Machine room (A) GENERAL DESCRIPTION OF LIFTS. [1] GEAR LESS LIFT DRIVE (MRL) comprising of High Starting torque Lift 3 phase 440 V A. C. Permanent Magnet Synchronous motor of proper rating with high efficiency shall be used.[2] Micro processor based / PLC, ACVVVF, vector control drive with encoder feedback closed loop system shall be used for lift car and door operation which shall be full collective selective operation hall call demand response, UP/DOWN hall stops, Main, Up/ Down Contactor with overload and phase reversal relay and safety controls.[3] Car with M S platform with bracings of adequate size and to sustain the impact load cabin + passenger with safety factor of fire for steel and side panels of Stainless steel of sheet of grade 304 duty. Car ceiling will be S.S. finishes with aesthetic appearance with LED ceiling lights. Car flooring shall be of anti	Mtr	1046850.86	Rupees Ten Lakhs Forty Six Thousand Eight Hundred Fifty and Paise Eighty Six Only	1046850.86

Schedule - B

Item No.	Quantities estimated but may be more or less	Item of work	Unit	Tendered Rates		Total amount according to estimated quantities
				in figures	In Words	
	0.00	All car panel buttons and all floor switches must be with brail language as per lift act.[4] All landing doors must be fire rated for 2 hour shall be fully automatic centre opening/ telescopic opening made of hairline finish steel grade of 304 with key holes and infrared curtains with Unlocking facility from outside [5] Appropriate battery operated emergency light in the car along with alarm switch shall be provided. Also, Emergency Light & Fan should start immediately without any Time Delay as soon as power fails. [6] Digital scrolling indicator system for up-down arrow along with floor position indicator shall be provided inside the car and at all floors.[7] Full height infra red curtain with multiple cross / crossing light beams shall be provided.[8] Automatic Rescue Device (ARD) shall be provided accordingly of passenger capacity with Manual Rescue Operation (Manual Cranking Facility).[9] Audio visual indication in the lift car showing over loading shall be provided such that doors kept open till excess load is removed.[10] Spring buffers/PU Buffers shall be				
	0.00	[14] Mechanical over speed governor with governor calibration as per actual site parameters and submission of calibration certificate submission, door key holes in the floor doors, fireman switch shall be provided.[15] Lift machine hoisting arrangement in the lift machine room and monkey ladder for lift pit should be provided by the lift agency, along with the				

Schedule - B

Item No.	Quantities estimated but may be more or less	Item of work	Unit	Tendered Rates		Total amount according to estimated quantities
				in figures	In Words	
	0.00	<p>[19] Agency has to provide all working drawings and documents and liaison services for obtaining all necessary permission from lift inspector and other authorities.[20] acrylic transparent licence/display A4 size holder in lift car[20A] As per statutory requirement of Govt. Of Gujarat lift & escalator act 2000, lift agency has to provide 1. Car top safety barricade 2. Push & talk communication system.3. Fireman's switch operation at Ground Floor. 4.carrying out third party lift inspection during/after lift erection and provide report by third party authorized by concern licensing authority 5.agency has to provide third party insurance upto completion of free maintenance period and submit the document for the same.[21] Car Panel Operating Buttons with floor position indicator/buttons must be of Auto Glow type clearly visible when view from inside cabin. [22] For Physically Handicapped person Full Length Handrails of hairline finish steel grade of 304 should be provided at appropriate height on the Rear & Side Wall Panels in Lift Car.</p>				

Schedule - B						
Item No.	Quantities estimated but may be more or less	Item of work	Unit	Tendered Rates		Total amount according to estimated quantities
				in figures	In Words	
257	1.00	Supplying, installation, testing and commissioning of electric driven terrace pump suitable for automatic operation and consisting of following, complete in all respects, as required: (Terrace Pump) (a) Horizontal type, multistage, centrifugal, split casing pump of cast iron body & bronze impeller with stainless steel shaft, mechanical confirming to IS : 1520 b) Suitable HP squirell cage induction motor TEFC type suitable for operation on 415 volts, 3 phase, 50 Hz, AC supply with IP55 class of protection for enclosure, horizontal foot mounted type with Class-'F' insulation, conforming to IS-325. (c) M.S.fabricated common base plate, coupling, coupling guard, foundation bolts etc.as required. (d) Suitable cement concrete foundation duly plastered and with anti vibration pads. 4.2) 450 lpm at 35 m Head	SET	87065.03	Rupees Eighty Seven Thousand Sixty Five and Paise Three Only	87065.03
258	1.00	SITC of DIESEL ENGINE PUMP SETS 5 hp , Cooling Method Water Cooled , Voltage - 415 , Pump Type Fire fighting pump, Speed 1800 RPM, 2150 RPM , Maximum Discharge Flow 50 to 3000 Usgpm,Maximum Head 40 to 205 psi. Pump Size 1500 to 3000 rpm , Fuel Capacity maximum 1000 ltr Tank capacity,Frequency 50 Hz , 60 Hz.,3 phase , Made in India	SET	33835.00	Rupees Thirty Three Thousand Eight Hundred Thirty Five and Paise Zero Only	33835.00
259	1.00	Supplying, fixing, testing & commissioning of double flanged sluice valve of rating PN 1.6 with non rising spindle, bronze/gun metal seat, ISI marked complete with nuts, bolts, washers, gaskets and conforming to IS 780 of following sizes as required : (12.4) 80mm dia	NOS.	10802.96	Rupees Ten Thousand Eight Hundred Two and Paise Ninety Six Only	10802.96

Schedule - B						
Item No.	Quantities estimated but may be more or less	Item of work	Unit	Tendered Rates		Total amount according to estimated quantities
				in figures	In Words	
260	2.00	Supplying, fixing, testing & commissioning of double flanged sluice valve of rating PN 1.6 with non rising spindle, bronze/gun metal seat, ISI marked complete with nuts, bolts, washers, gaskets and conforming to IS 780 of following sizes as required : 150 mm dia	NOS.	22989.62	Rupees Twenty Two Thousand Nine Hundred Eighty Nine and Paise Sixty Two Only	45979.24
261	2.00	Supply, Installation and Testing of: Check Valve (Ball type or Swing type) with necessary pipe fitments, hardware and consumables. MOC:-Body: Cast Iron (With Flange Ends). Standard: ISI Marked. UOM:- Price Per Each No. 150 mm dia	NOS.	8583.99	Rupees Eight Thousand Five Hundred Eighty Three and Paise Ninety Nine Only	17167.98
262	1.00	Supply, Installation and Testing of: Check Valve (Ball type or Swing type) with necessary pipe fitments, hardware and consumables. MOC:-Body: Cast Iron (With Flange Ends). Standard: ISI Marked. UOM:- Price Per Each No. 80 mm dia	NOS.	8280.99	Rupees Eight Thousand Two Hundred Eighty and Paise Ninety Nine Only	8280.99
263	2.00	Supply, Installation and Testing of: Foot Valve (Ball type or Swing type) with necessary pipe fitments, hardware and consumables. MOC:-Body: Cast Iron (With Flange Ends). Standard: ISI Marked. UOM:- Price Per Each No. 150 mm dia	NOS.	11108.99	Rupees Eleven Thousand One Hundred Eight and Paise Ninety Nine Only	22217.98
264	1.00	Supply, Installation and Testing of: Foot Valve (Ball type or Swing type) with necessary pipe fitments, hardware and consumables. MOC:-Body: Cast Iron (With Flange Ends). Standard: ISI Marked. UOM:- Price Per Each No. 80 mm dia	NOS.	5048.99	Rupees Five Thousand Forty Eight and Paise Ninety Nine Only	5048.99
265	1.00	Providing, installation, testing and commissioning of stainless steel Y-strainer fabricated out of 1.6 mm thick stainless steel, Grade 304, sheet with 3 mm dia holes with stainless steel flange. : 80 mm	NOS.	4757.10	Rupees Four Thousand Seven Hundred Fifty Seven and Paise Ten Only	4757.10

Schedule - B						
Item No.	Quantities estimated but may be more or less	Item of work	Unit	Tendered Rates		Total amount according to estimated quantities
				in figures	In Words	
266	2.00	Providing, installation, testing and commissioning of stainless steel Y-strainer fabricated out of 1.6 mm thick stainless steel, Grade 304, sheet with 3 mm dia holes with stainless steel flange. (15.3)150 mm dia	NOS.	11255.44	Rupees Eleven Thousand Two Hundred Fifty Five and Paise Forty Four Only	22510.88
267	2.00	Supply, Installation and Testing of: Pressure Gauge with Siphon Tube and Cock. MOC:-4" Dial- Glycerin filled- Stainless Steel Body Pressure Gauge with GI Siphon Tube and Brass Cock. Size:-Dial: 4" (100 mm) Range: 0 – 16 Bar (kg/cm ²) UOM:-Price Per Unit	NOS.	2121.00	Rupees Two Thousand One Hundred Twenty One and Paise Zero Only	4242.00
268	2.00	Providing & fixing of pressure switch in M.S. pipe line including connection etc. as required.	NOS.	1561.46	Rupees One Thousand Five Hundred Sixty One and Paise Forty Six Only	3122.92
269	1.00	Supply, Installation and Testing of: Electric Control Panel for Electric Motor Driven Main Fire Pump and Jockey Fire Pump. Both pumps can be Start Automatically (by Pressure Switch) or Manually. Design As per the Detail Specifications given. We will provide Power Cable up to Pump Panel; Including Electrification work From Panel to Pump. UOM:-Price Per Set.	NOS.	60598.99	Rupees Sixty Thousand Five Hundred Ninety Eight and Paise Ninety Nine Only	60598.99
270	1.00	Supply, Installation and Testing of: Electric Control Panel for Diesel Engine Driven Standby Fire Pump. We will provide Power Cable up to Pump Panel; Electrification From Panel to Pump subject to your scope only. UOM:-Price Per Set.	NOS.	30298.99	Rupees Thirty Thousand Two Hundred Ninety Eight and Paise Ninety Nine Only	30298.99
271	1.00	Supplying and fixing air vessel made of 250 mm dia, 8 mm thick MS sheet, 1200 mm in height with air release valve on top and flanged connection to riser, drain arrangement with 25 mm dia gun metal wheel valve with required accessories, pressure gauge and painting with synthetic enamel paint of approved shade as required.	NOS.	18426.44	Rupees Eighteen Thousand Four Hundred Twenty Six and Paise Forty Four Only	18426.44

Schedule - B						
Item No.	Quantities estimated but may be more or less	Item of work	Unit	Tendered Rates		Total amount according to estimated quantities
				in figures	In Words	
272	30.00	Providing, laying, testing & commissioning of 'C' class heavy duty MS pipe conforming to IS 3589/IS 1239 including Welding, fittings like elbows, tees, flanges, tapers, nuts bolts, gaskets etc. and fixing the pipe on the wall/ceiling with suitable clamp/support frame and painting with two or more coats of synthetic enamel paint of required shade complete as required : 100 mm dia	Mtr.	2580.55	Rupees Two Thousand Five Hundred Eighty and Paise Fifty Five Only	77416.50
273	60.00	Providing, laying, testing & commissioning of 'C' class heavy duty MS pipe conforming to IS 3589/IS 1239 including Welding, fittings like elbows, tees, flanges, tapers, nuts bolts, gaskets etc. and fixing the pipe on the wall/ceiling with suitable clamp/support frame and painting with two or more coats of synthetic enamel paint of required shade complete as required : 150 mm dia	Mtr.	3609.74	Rupees Three Thousand Six Hundred Nine and Paise Seventy Four Only	216584.40
274	90.00	Providing, laying, testing & commissioning of 'C' class heavy duty MS pipe conforming to IS 3589/IS 1239 including Welding, fittings like elbows, tees, flanges, tapers, nuts bolts, gaskets etc. and fixing the pipe on the wall/ceiling with suitable clamp/support frame and painting with two or more coats of synthetic enamel paint of required shade complete as required : 40 mm dia	Mtr.	1044.34	Rupees One Thousand Forty Four and Paise Thirty Four Only	93990.60
275	80.00	Providing, laying, testing & commissioning of 'C' class heavy duty MS pipe conforming to IS 3589/IS 1239 including Welding, fittings like elbows, tees, flanges, tapers, nuts bolts, gaskets etc. and fixing the pipe on the wall/ceiling with suitable clamp/support frame and painting with two or more coats of synthetic enamel paint of required shade complete as required : 25 mm dia	Mtr.	751.44	Rupees Seven Hundred Fifty One and Paise Forty Four Only	60115.20

Schedule - B						
Item No.	Quantities estimated but may be more or less	Item of work	Unit	Tendered Rates		Total amount according to estimated quantities
				in figures	In Words	
276	3.00	Supply, Installation and Testing of: Fire Hose Cabinet (Hose Box) suitable to accommodate 02 no. of 15 m long fire hoses and 01 no. of nozzle. With Lock-n-key facility. Wall Mounting Design. MOC: 16 Gauge MS Box with Powder Coating Standard: - As per Guidelines. UOM:-Price Per Each No. Size:- Suitable for 02 nos. of 15 m long hoses.	No.	4242.00	Rupees Four Thousand Two Hundred Forty Two and Paise Zero Only	12726.00
277	1.00	Supplying and fixing of fire brigade connection of cast iron body with gun metal male instantaneous inlet couplings complete with cap and chain as reqd. for suitable dia MS pipe connection conforming to IS 904 as required : 4 way - 150 mm dia M.S. Pipe	No.	14113.74	Rupees Fourteen Thousand One Hundred Thirteen and Paise Seventy Four Only	14113.74
278	2.00	Supplying, fixing, testing and commissioning of butterfly valve of PN 1.6 rating with bronze/gunmetal seat duly ISI marked complete with nuts, bolts, washers, gaskets conforming to IS 13095 of following sizes as required : 150 mm dia	Set	9049.60	Rupees Nine Thousand Forty Nine and Paise Sixty Only	18099.20
279	1.00	Supplying, fixing, testing and commissioning of butterfly valve of PN 1.6 rating with bronze/gunmetal seat duly ISI marked complete with nuts, bolts, washers, gaskets conforming to IS 13095 of following sizes as required : 80 mm dia	Set	5031.82	Rupees Five Thousand Thirty One and Paise Eighty Two Only	5031.82
280	3.00	Supplying and fixing single headed internal hydrant valve with instantaneous Gunmetal/Stainless Steel coupling of 63 mm dia with cast iron wheel ISI marked conforming to IS 5290 (Type -A) with blank Gunmetal/Stainless Steel cap and chain as required : Single headed Gunmetal	NO.	7722.46	Rupees Seven Thousand Seven Hundred Twenty Two and Paise Forty Six Only	23167.38
281	6.00	Supplying and fixing 63 mm dia, 15 m long RRL hose pipe with 63 mm dia male and female couplings duly bound with GI wire, rivets etc. conforming to IS 636 (type-A) as required :Stainless less steel (Grade 304)	NO.	4492.48	Rupees Four Thousand Four Hundred Ninety Two and Paise Forty Eight Only	26954.88

Schedule - B						
Item No.	Quantities estimated but may be more or less	Item of work	Unit	Tendered Rates		Total amount according to estimated quantities
				in figures	In Words	
282	3.00	Supplying and fixing first-aid Hose Reel with MS construction spray painted in post office red, conforming to IS 884 complete with the following as required. 20 mm nominal internal dia water hose thermoplastic (Textile reinforced) type -2 as per IS: 12585 20 mm nominal internal dia gun metal globe valve & nozzle. Drum and brackets for fixing the equipments on wall. Connections from riser with 25 mm dia stop gun metal valve & M.S. Pipe and socket. : 30 m	NO.	8761.75	Rupees Eight Thousand Seven Hundred Sixty One and Paise Seventy Five Only	26285.25
283	6.00	Supply, Installation and Testing of: ABC Powder Fire Extinguisher necessary hardware and consumables. Stored Pressure Mechanism. Charged with MAP-50 % (ABC) Dry Powder. With wall mounting clamp. Standard: -Confirming to IS: 15683-2006 with ISI Mark UOM:-Price Per Each No. Size:-6 kg Powder.	NO.	1614.99	Rupees One Thousand Six Hundred Fourteen and Paise Ninety Nine Only	9689.94
284	6.00	Supplying & erecting carbon dioxide (CO2) fire extinguisher user of following capacity with necessary clamps made from 50 x 6 mm M.S. Flat with nut & bolts grouted in wall complete. [A] For 4.5 Kg Capacity	No.	6591.26	Rupees Six Thousand Five Hundred Ninety One and Paise Twenty Six Only	39547.56
285	3.00	Supplying FIRE bucket round bottom of 9 litres capacity made out of 24 gauge G.I. sheet with extra handle at bottom duly painted white inside and Red out side with FIRE mark, filled with dry-sand and kept on existing stand provided or hung on wall hook.	Each	214.12	Rupees Two Hundred Fourteen and Paise Twelve Only	642.36
286	3.00	Wall hook 22 to 25 cms. projection for keeping fire buckets made out of 15 mm dia. M.S rod grouted in wall to a depth of minimum 15 cms.	Each	60.60	Rupees Sixty and Paise Sixty Only	181.80

Schedule - B						
Item No.	Quantities estimated but may be more or less	Item of work	Unit	Tendered Rates		Total amount according to estimated quantities
				in figures	In Words	
287	3.00	Supplying, installation, testing & commissioning of addressable manual call point having IS or BS (EN 54) (Vds approved) or NFPA 72 (UL/ULC/FM approved) with Latest Amendment complete as required.	Each	3898.60	Rupees Three Thousand Eight Hundred Ninety Eight and Paise Sixty Only	11695.80
288	1.00	CERTIFICATION & FIRE N.O.C. CHARGES, Approval, Designing & Drawings of Fire Hydrant & Entire Fire Protection System from Local Fire Authority and any other relevant statutory authority at initial and various other stages of work, including preparation of report/drawings as per fire authority requirement. Contractor shall include cost of all liason work which are not explicitly mentioned above but are mandatory to have fire authority approval (any statutory charges will be paid extra).	Each	20200.00	Rupees Twenty Thousand Two Hundred and Paise Zero Only	20200.00
289	3.00	Hooter Cum Sounder Supply, Installation of: Hooter Cum Sounder size:- Range suitable for System Design Pressure. UOM:-Price Per Unit MAKE : DANFOSS	Each	1363.50	Rupees One Thousand Three Hundred Sixty Three and Paise Fifty Only	4090.50
290	1.00	Supply Installation Testing and Commissioning of Battery Backup for FA System.	Each	5048.99	Rupees Five Thousand Forty Eight and Paise Ninety Nine Only	5048.99
291	88.00	Supplying, installation, testing & commissioning of smoke detector with built in LED and mounting base complete with all connections etc. as required	Each	1164.53	Rupees One Thousand One Hundred Sixty Four and Paise Fifty Three Only	102478.64

Schedule - B						
Item No.	Quantities estimated but may be more or less	Item of work	Unit	Tendered Rates		Total amount according to estimated quantities
				in figures	In Words	
292	1.00	Fire Detection System SITC of Addressable Combined Fire Alarm and Emergency Lighting Control Panel features 4 loop complete with Network Card. The Panel shall be compliant with EN54-2 and EN54-4. Each loop shall have a capacity of 127 Fire Alarm and Emergency Lighting devices, Each loop current rated at 1 AMP. The Panel shall have 240 x 64	Each	242400.00	Rupees Two Lakhs Forty Two Thousand Four Hundred and Paise Zero Only	242400.00
293	500.00	Supplying & laying of 2x1.5 sqmm fire alarm armoured cable, 600/1000V rated with annealed copper conductor having XLPE insulation, steel wire armouring & FRLS outer sheath complete as required.	Mtr.	174.73	Rupees One Hundred Seventy Four and Paise Seventy Three Only	87365.00
294	1.00	Supplying stand first AID box with antiseptic cream, medicine for use on wounds due burn, crepe bandage, gauge bandage, medicated ready to use bandage (Band-aid) adhesive tape for medicinal user, Scissors, anti-septic solution (Savlon or similar) etc. (All above contents shall be of standard makes)	Each	353.50	Rupees Three Hundred Fifty Three and Paise Fifty Only	353.50
295	7.00	Providing & fixing 2 MP IP Dome Camera	Nos.	3219.00	Rupees Three Thousand Two Hundred Nineteen and Paise Zero Only	22533.00
296	4.00	Providing & fixing 2 MP IP Bullet Camera	Nos.	3119.00	Rupees Three Thousand One Hundred Nineteen and Paise Zero Only	12476.00

Schedule - B						
Item No.	Quantities estimated but may be more or less	Item of work	Unit	Tendered Rates		Total amount according to estimated quantities
				in figures	In Words	
297	1.00	Providing & fixing 16 ch NVR	Nos.	7725.00	Rupees Seven Thousand Seven Hundred Twenty Five and Paise Zero Only	7725.00
298	1.00	Providing & fixing 5 TB Hard Disk	Nos.	10460.00	Rupees Ten Thousand Four Hundred Sixty and Paise Zero Only	10460.00
299	1.00	Providing & fixing 16 Port POE switch	Nos.	13200.00	Rupees Thirteen Thousand Two Hundred and Paise Zero Only	13200.00
300	350.00	Providing & fixing Cat-6 Dual Sheath PVC & LSZH Anti-Rodent	Mtr	85.00	Rupees Eighty Five and Paise Zero Only	29750.00
301	11.00	Providing & fixing Back Box with IO at camera side	Nos.	455.00	Rupees Four Hundred Fifty Five and Paise Zero Only	5005.00

Schedule - B						
Item No.	Quantities estimated but may be more or less	Item of work	Unit	Tendered Rates		Total amount according to estimated quantities
				in figures	In Words	
302	350.00	Providing & fixing 25 MM PVC Pipe	Mtr	52.00	Rupees Fifty Two and Paise Zero Only	18200.00
303	1.00	Providing & fixing 55 inch display	Nos.	25930.00	Rupees Twenty Five Thousand Nine Hundred Thirty and Paise Zero Only	25930.00
TOTAL AMOUNT						3,10,17,210.01

I/We am/ are willing to carry out the work @ _____ % Above /Below _____ Percentage (Should be written in Figures and Words) of the Estimated rates mentioned above amount of my/ our Tender work out as under.

*Estimated Amount	*Estimated Amount
Put On Tender Rs.3,10,17,210.01	Put On Tender Rs.10,17,210.01
Deduct..... % Below Rs.	Add % Above Rs.
Net Rs.:.....	Total Rs. :
In Words :	In Words :

(* Please strike out whichever is not applicable.)

Note-1 All works shall be carried out as per Public Works Department Handbook and other specifications of Division or as directed.

GIMV! AM\H SFD AFWSFD IJEFUGL 5]:TSF VG[10IJhGGL A\ BF; IJUT D\HA VYJF ; RGF 5]Df6[SZL VF5JFG]ZCXP

Note-2 All the columns is Schedule should be filled in ink and the total of the entries in the last column should be struck by the contractor under his signature.

GIMVZ VG; }RDFAWF BFGFL IJUTM; CLYL EZJL VG[Kf; F BFGFL GIMMGM; ZJF/M SZL S8F8Z]5MTFGL ; CL SZJLP

Note-3 Rates quoted include clearance of site (prior commencement of work and at its close)in all respects and hold good for work under all conditions, site, moisture, weather etc.

GIMV# 8FS; F NZDF : Y/GL sSFDGF VFZE[VG[5]- YFI T[JBTF NZS ZLT]; FO; DL SZJFGM; DEFX YFI K# VG[T[NZ TDFD 5IZI:YIT4 : Y/4 E\H4 CJFDfG JUJZ[Cp/ SFD Df8[VD, DfZCXP

Note-4 To be continued on additional sheets, if found necessary.

GIMV\$ H-Z H6FI JWZFGF SFU/MHMOL RF, JZFBJP

Schedule - B						
Item No.	Quantities estimated but may be more or less	Item of work	Unit	Tendered Rates		Total amount according to estimated quantities
				in figures	In Words	
Signature of Contractor with Seal			Signature of Contracting Authority with Seal			



Bhavnagar Municipal Corporation



- એજન્સી દ્વારા કામ શરૂ કરતા પહેલા સ્થળ સ્થિતિ મુજબના ફોટા ગ્રાફ રજૂ કરવાના રહેશે અને ત્યારબાદ જ કામગીરી શરૂ કરવાની રહેશે. વખતો વખત ટેન્ડર માં સમાવેશ થતી આઈટમો ની કામગીરી ના ફોટા ગ્રાફ રજૂ કરવાના રહેશે.
- આ તમામ ભાવમાં જી.એસ.ટી.નો સમાવેશ કરવામાં આવેલ નથી. સરકારશ્રીના નિયમાનુસાર અલગથી જી.એસ.ટી ચુકવવામાં આવશે. વધુમાં એજન્સીને સરકારશ્રીના નિયમનુસાર જી.એસ.ટી.નું ચુકવણું કરવાનું રહેશે.
- સ્થળે VFRPBL JLH , F. G 5; FZ Yતી હોય તો VF DF8[JLH 5|B\$XG VUJL TDFD jI J:YF Sllg8FS8Z[: JBR[SZJFGL ZCXP TDPH SM. VS: DFT S[HFGCFGL YFI TMT[VUJL TDFD HJFANEZL Sllg8FS8ZGL ZCXP
- હાલના વેન્ડર લીસ્ટ અને ભવિષ્યમાં જે તે સમયે જ્યારે ભાવનગર મહાનગરપાલિકા અને સક્ષમ સત્તા વેન્ડરમાં ફેરફાર કરશે તે અદ્યતન વેન્ડર લીસ્ટ માન્ય ગણીને કોન્ટ્રાક્ટરશ્રીએ સાઈટ પર માન્ય મટીરીયલ વપરાશમાં લેવાનું રહેશે તે બાબતે વધારાના ભાવ તફાવત ખર્ચ ચુકવવામાં નહિ આવે.
- SFD X- SZTF 5J[SFDGL IJUTMNXFJT] AMO" SFD 56" YTF ; |M Sllg8FS8Z[: JBR[, UFOL ZFBJFG] ZCXP[VgI YF SM. 56 ; DI[AMO" , FU[, DF, D GCL 50X[tI FZ[-15I F 5 ___qV GL 5G<8L , FU] 50XP
- ટેન્ડર/એજન્સીએ ટેન્ડર ડોક્યુમેન્ટ સાથે ESIC કોડ/રજીસ્ટ્રેશન ફરજિયાત રજૂ કરવાનું રહેશે, ESIC કોડ/રજીસ્ટ્રેશન સિવાયનું ટેન્ડર માન્ય ગણાશે નહીં.
- કોન્ટ્રાક્ટરશ્રીએ બાંધકામ માં OPC ૫૩ ગ્રેડ સિમેન્ટ વાપરવાની રહેશે.
- ❖ p5ZMST TDFD XZTM VDM V[JFRLL4JRFJL4; DHL4JRFZLG[8gOZDF EFJM EZ[, K[H[DG[q VDG[SA], DHIZ K[VG[T[DJHA VDM SFD SZJF AWF. V[KLVp

Sllg8FS8ZGL ; CL P

Sllg8FS8ZG[GFD P

Sllg8FS8ZGM I; SSM

TFZLB

BHAVNAGAR MUNICIPAL CORPORATION			
Name of Work :- Construction Of New PHC In The Area Of Bhavnagar City,Kumbharwada, Bhavnagar(B.M.C.)			
Specification Index			
Item No	Item Description	Unit	Specification No as per General technical Specification Booklet
1	Excavation for foundation upto 1.5 m depth including sorting out and stacking of useful materials and disposing off the excavated stuff upto 50 Meter lead.(A) Loose or soft soil	CMT	it no 0,it code 04001A General Technical Specification Booklet
2	Excavation for foundation for depth from 1.5 m to 3.0 m including sorting out and stacking of useful materials and disposing off the excavated stuff upto 50 Meter lead.(A) Loose or soft soil	CMT	it no 0,it code 04002A General Technical Specification Booklet
3	Excavation for foundation for depth from 3.00 m to 6.0 m including sorting out and stacking of useful materials and disposing off the excavated stuff upto 50 Meter lead. (C) Hard Murrum	CMT	it no 0,it code 04003C General Technical Specification Booklet
4	Clearing and grubbing road land including uprooting rank vegetation grass bushes,shrubs,sapling and trees girth up to 300 mm removal of stumps of trees cut earlier and disposal of unserviceable materials (C) By mechanical means in area of light jungle	Hectare	Separate sheet attached
5	Dewatering In all sorts of soil and soft murrum,hard murrum and bulders, soft rock, hard rock up to 1.50 mt depth from G.L.	CMT	Separate sheet attached
6	Rammed Rubble soling With Lean Mix cement mortar (CM 1:10) Preferably Joint fill up with lime mortar 1:4 etc. comp.	CMT	Separate sheet attached
7	Boring holes 3.5 m deep in ordinary soil (for cast in situ piles) and getting out the soil and disposal of the surplus excavated soil as directed within a lead of 50 Meter for following diameter of pipes.(iii) 300 mm	No.	it no 4.27,it code 04010C General Technical Specification Booklet
10	Providing and laying cement concrete 1:2:4 (1-Cement : 2- Coarse sand : 4- graded stone aggregates 20 mm nominal size) and curing complete excluding cost of formwork in (A) Foundation and Plinth	CMT	it no 5.3.13 ,it code 05010BA General Technical Specification Booklet
11	Providing and laying controlled cement concrete M.250 and curing complete excluding the cost of formwork and reinforcement for reinforced concrete work in (A) Foundations, footings, Base of columns and Mass concrete.	CMT	it no5.8.3,it code 05025AA General Technical Specification Booklet
12	Providing and laying controlled cement concrete M250 work with curing etc. complete including the cost of from workbut excluding cost of Reinforcement for RCC work in (A) Foundation footing base of columns and mass concrete.	CMT	it no5.8.3,it code 05025AA General Technical Specification Booklet
13	Providing and laying controlled cement concrete M250 work with curing etc. complete including the cost of from workbut excluding cost of Reinforcement for RCC work in Column upto Plinth Level.	CMT	it no5.8.3,it code 05025AA + it no 9.1 it code 09001AA General Technical Specification Booklet
14	Providing and laying controlled cement concrete M250 work with curing etc. complete including the cost of from workbut excluding cost of Reinforcement for RCC work in RCC Wall upto Plinth Level.	CMT	it no5.8.3,it code 05025+ it no 9.1 it code 09001G1 General Technical Specification Booklet
15	Providing and laying controlled cement concrete M250 work with curing etc. complete including the cost of from work but excluding cost of Reinforcement for RCC work in Beam. .GB/PB	CMT	it no5.8.3,it code 05025AA + it no 9.1 it code 09001G1A General Technical Specification Booklet
16	Brick work using common burnt clay building bricks having crushing strength not less than 35 kg./Sq.Cm. in foundation and plinth in Cement Mortar 1:6 (1-Cement : 6 -fine sand)(B) Conventional	CMT	it no 6.13 ,it code 06002BA General Technical Specification Booklet
17	Filling available excavated earth (excluding rock) in trenches. plinth, sides of foundations etc. in layers not exceeding 20 cm. in depth consolidating each deposited layer by ramming and watering.	CMT	it no 4.12,it code4006 General Technical Specification Booklet

18	Filling in foundation and plinth with murrum or selected soil/Garden soil in layers of 20cm. thickness including watering, ramming and consolidating etc. complete.	Cmt	it no 0.0,it code 4008 General Technical Specification Booklet
19	Applying general insecticide pest control treatment to floors, cupboards etc including labour material etc. complete. Using Heptachloride 20 EC. As Per 6113_pests Concentration Weight 0.50 percent is recommended one litre chemical emulsion dilute with 39 liter of water will give. Total dilute concentration will be 40 litre inclusive of one litre chemical emulsion application 0.5 Litre chemical / Sqm of surface is recommended as per I.S	CMT	it no 0 it code22006 General Technical Specifications Booklet
20	Providing and laying controlled cement concrete M250 work with curing etc. complete including the cost of form work but excluding cost of Reinforcement for RCC work in Column (G.F.)	CMT	it no5.8.3,it code 05025+ it no 9.1 it code 09001G1 General Technical Specification Booklet
21	Providing and laying controlled cement concrete M.250 work with curing etc. complete including the cost of formwork but excluding the cost of reinforcement for RCC work in Column (F.F.)	CMT	it no5.8.3,it code 05025+ it no 9.1 it code 09001G1 General Technical Specification Booklet
22	Providing and laying controlled cement concrete M.250 work with curing etc. complete including the cost of formwork but excluding the cost of reinforcement for RCC work in Column (S.F.)	CMT	it no5.8.3,it code 05025+ it no 9.1 it code 09001G1 General Technical Specification Booklet
23	Providing and laying controlled cement concrete M.250 work with curing etc. complete including the cost of formwork but excluding the cost of reinforcement for RCC work in Column (T.F.)	CMT	it no5.8.3,it code 05025+ it no 9.1 it code 09001G1 General Technical Specification Booklet
24	Providing and laying controlled cement concrete M250 work with curing etc. complete including the cost of form work but excluding cost of Reinforcement for RCC work in RCC Wall (G.F.)	CMT	it no5.8.3,it code 05025+ it no 9.1 it code 09001G1 General Technical Specification Booklet
25	Providing and laying controlled cement concrete M.250 work with curing etc. complete including the cost of formwork but excluding the cost of reinforcement for RCC work in RCC Wall (F.F.)	CMT	it no5.8.3,it code 05025+ it no 9.1 it code 09001G1 General Technical Specification Booklet
26	Providing and laying controlled cement concrete M.250 work with curing etc. complete including the cost of formwork but excluding the cost of reinforcement for RCC work in RCC Wall (S.F.)	CMT	it no5.8.3,it code 05025+ it no 9.1 it code 09001G1 General Technical Specification Booklet
27	Providing and laying controlled cement concrete M.250 work with curing etc. complete including the cost of formwork but excluding the cost of reinforcement for RCC work in RCC Wall (T.F.)	CMT	it no5.8.3,it code 05025+ it no 9.1 it code 09001G1 General Technical Specification Booklet
28	Providing and laying controlled cement concrete M250 work with curing etc. complete including the cost of form workbut excluding cost of Reinforcement for RCC work in Lintel/Coping (G.F.)	CMT	Item no5.8.3,Item code 05025AA+ Item no 9.1, Item code 09001H1 General Technical Specification Booklet
29	Providing and laying controlled cement concrete M250 work with curing etc. complete including the cost of form workbut excluding cost of Reinforcement for RCC work in Lintel/Coping (F.F.)	CMT	Item no5.8.3,Item code 05025AA+ Item no 9.1, Item code 09001H1 General Technical Specification Booklet
30	Providing and laying controlled cement concrete M250 work with curing etc. complete including the cost of form workbut excluding cost of Reinforcement for RCC work in Lintel/Coping (S.F.)	CMT	Item no5.8.3,Item code 05025AA+ Item no 9.1, Item code 09001H1 General Technical Specification Booklet
31	Providing and laying controlled cement concrete M250 work with curing etc. complete including the cost of form workbut excluding cost of Reinforcement for RCC work in Lintel/Coping (T.F.)	CMT	Item no5.8.3,Item code 05025AA+ Item no 9.1, Item code 09001H1 General Technical Specification Booklet

32	Providing and laying controlled cement concrete M250 work with curing etc. complete including the cost of from workbut excluding cost of Reinforcement for RCC work in Beam (G.F.)	CMT	it no5.8.3,it code 05025AA + it no 9.1 it code 09001G1A General Technical Specification Booklet
33	Providing and laying controlled cement concrete M250 work with curing etc. complete including the cost of from workbut excluding cost of Reinforcement for RCC work in Beam (F.F.)	CMT	it no5.8.3,it code 05025AA + it no 9.1 it code 09001G1A General Technical Specification Booklet
34	Providing and laying controlled cement concrete M250 work with curing etc. complete including the cost of from workbut excluding cost of Reinforcement for RCC work in Beam (S.F.)	CMT	it no5.8.3,it code 05025AA + it no 9.1 it code 09001G1A General Technical Specification Booklet
35	Providing and laying controlled cement concrete M250 work with curing etc. complete including the cost of from workbut excluding cost of Reinforcement for RCC work in Beam (T.F.)	CMT	it no5.8.3,it code 05025AA + it no 9.1 it code 09001G1A General Technical Specification Booklet
36	Providing and laying controlled cement concrete M250 work with curing etc. complete including the cost of from workbut excluding cost of Reinforcement for RCC work in CHAJJA, (G.F.)	CMT	it no5.8.3,it code 05025AA+ it no 9.1 it code 09001B1 General Technical Specification Booklet
37	Providing and laying controlled cement concrete M250 work with curing etc. complete including the cost of from workbut excluding cost of Reinforcement for RCC work in CHAJJA, (F.F.)	CMT	it no5.8.3,it code 05025AA+ it no 9.1 it code 09001B1 General Technical Specification Booklet
38	Providing and laying controlled cement concrete M250 work with curing etc. complete including the cost of from workbut excluding cost of Reinforcement for RCC work in CHAJJA, (S.F.)	CMT	it no5.8.3,it code 05025AA+ it no 9.1 it code 09001B1 General Technical Specification Booklet
39	Providing and laying controlled cement concrete M250 work with curing etc. complete including the cost of from workbut excluding cost of Reinforcement for RCC work in CHAJJA, (T.F.)	CMT	it no5.8.3,it code 05025AA+ it no 9.1 it code 09001B1 General Technical Specification Booklet
40	Providing and laying controlled cement concrete M250 work with curing etc. complete including the cost of from workbut excluding cost of Reinforcement for RCC work in SLAB (G.F.)	CMT	it no5.8.3,it code 05025AA+ it no 9.1 it code 09001B1 General Technical Specification Booklet
41	Providing and laying controlled cement concrete M250 work with curing etc. complete including the cost of from workbut excluding cost of Reinforcement for RCC work in SLAB (F.F.)	CMT	it no5.8.3,it code 05025AA+ it no 9.1 it code 09001B1 General Technical Specification Booklet
42	Providing and laying controlled cement concrete M250 work with curing etc. complete including the cost of from workbut excluding cost of Reinforcement for RCC work in SLAB (S.F.)	CMT	it no5.8.3,it code 05025AA+ it no 9.1 it code 09001B1 General Technical Specification Booklet
43	Providing and laying controlled cement concrete M250 work with curing etc. complete including the cost of from workbut excluding cost of Reinforcement for RCC work in SLAB (T.F.)	CMT	it no5.8.3,it code 05025AA+ it no 9.1 it code 09001B1 General Technical Specification Booklet
44	Providing and laying controlled cement concrete M250 work with curing etc. complete including the cost of from workbut excluding cost of Reinforcement for RCC work in Staircase (G.F.)	CMT	it no5.8.3,it code 05025AA+ it no 9.1 it code 09001MA General Technical Specification Booklet
45	Providing and laying controlled cement concrete M250 work with curing etc. complete including the cost of from workbut excluding cost of Reinforcement for RCC work in Staircase (F.F.)	CMT	it no5.8.3,it code 05025AA+ it no 9.1 it code 09001MA General Technical Specification Booklet
46	Providing and laying controlled cement concrete M250 work with curing etc. complete including the cost of from workbut excluding cost of Reinforcement for RCC work in Staircase (S.F.)	CMT	it no5.8.3,it code 05025AA+ it no 9.1 it code 09001MA General Technical Specification Booklet
47	Providing TMT Bar FE 500D reinforcement for R.C.C. work including Cutting, bending, binding and placing in position complete upto floor two level (G.F.)	Kg.	Separate sheet attached

48	Providing TMT Bar FE 500D reinforcement for R.C.C. work including Cutting, bending, binding and placing in position complete upto floor two level (F.F.)	Kg.	Separate sheet attached
49	Providing TMT Bar FE 500D reinforcement for R.C.C. work including Cutting, bending, binding and placing in position complete upto floor two level (S.F.)	Kg.	Separate sheet attached
50	Providing TMT Bar FE 500D reinforcement for R.C.C. work including Cutting, bending, binding and placing in position complete upto floor two level (T.F.)	Kg.	Separate sheet attached
51	Brick work using common burnt clay building bricks having crushing strength not less than 35 Kg/ Sq.Cm. In Super Structure above plinth level up to floor two level in cement mortar 1:6 (1 Cement: 6-Fine sand) with curing etc. (b)Conventional. (G.F.)	CMT	it no 6.13 ,it code 06002BA General Technical Specification Booklet
52	Brick work using common burnt clay Building bricks having crushing strength not less than 35 Kg/ Sq.Cm. In Super Structure above plinth level up to floor two level in cement mortar 1:6 (1 Cement: 6-Fine sand) with curing etc. (b)Conventional. for F.F.	CMT	it no 6.13 ,it code 06002BA General Technical Specification Booklet
53	Brick work using common burnt clay Building bricks having crushing strength not less than 35 Kg/ Sq.Cm. In Super Structure above plinth level up to floor two level in cement mortar 1:6 (1 Cement: 6-Fine sand) with curing etc. (b)Conventional. for S.F.	CMT	it no 6.13 ,it code 06002BA General Technical Specification Booklet
54	Brick work using common burnt clay Building bricks having crushing strength not less than 35 Kg/ Sq.Cm. In Super Structure above plinth level up to floor two level in cement mortar 1:6 (1 Cement: 6-Fine sand) with curing etc. (b)Conventional. for T.F.	CMT	it no 6.13 ,it code 06002BA General Technical Specification Booklet
55	Half brick masonry in common brunt clay building bricks having crushing strength not less than 35 Kg/Sq.Cm. in Cement mortar 1:4 (1- Cement : 4 - coarse sand) in foundation and plinth (B) Conventional (upto 10 ton) (for GF)	SMT	it no 6.3 ,it code 06008A2 General Technical Specification Booklet
56	Half brick masonry in common brunt clay building bricks having crushing strength not less than 35 Kg/Sq.Cm. in Cement mortar 1:4 (1- Cement : 4 - coarse sand) in foundation and plinth (B) Conventional (upto 10 ton) (for FF)	SMT	it no 6.3 ,it code 06008A2 General Technical Specification Booklet
57	Half brick masonry in common brunt clay building bricks having crushing strength not less than 35 Kg/Sq.Cm. in Cement mortar 1:4 (1- Cement : 4 - coarse sand) in foundation and plinth (B) Conventional (upto 10 ton) (for SF)	SMT	it no 6.3 ,it code 06008A2 General Technical Specification Booklet
58	Providing and fixing of full height glass partitions (AS PER DRAWINGS) using 19 or 25 mm C-channels in border and edge profile in between with powder coating , 12mm clear toughned glass, film work as per drawing including all hardware items, silicon, etc with all material, labour, cutouts, edge polish , lead and wastage etc. and complete the work satisfactorily as per instruction of architect or Engineer-in charge.	SMT	Separate sheet attached
59	Providing and fixing of 12 mm tk toughned GLASS DOORS using Dorma XI-C 4001 Glass Door PKG EN 3 (Top Patch-1, Bottom patch-1, Floor Spring-1, Corner Lock-1); Dorma XI-C 4003 A Patch fitting for overpanel and sidelight; Dorma XI-C 4004 A Connector for overpanel and Sidelight; Dorma XI-C 4006 Central Connector; Dorma XI-C 4008 Side Connector; Dorma XI-C 3000 H Type Handle 400x22 CTC 300 AND AS PER DRAWING including all accessories, locks, material, silicone, labour, installation, Hole & slote charges etc. and complete the work satisfactorily as per instruction of architect or Engineer-in charge. (APPROX SIZE OF 0.90 X 2.40)	SMT	Separate sheet attached

60	<p>Providing & fixing 35mm.th. Flush Door Solid Double Core type Both Face water proof Ply Vennered & 1.5 mm th.laminate shall be pasted on both side with adhesives as specified by the manufacturers. The laminate shall be as per approved shade & texture, of make incl.. S.S. Hinges with nessary screws & S.S.fixtures & fastenings like handle(10 cm), aldrops(30 cms), stoppers(20 cms) For all Floor etc as per architectural detailed drawing and as directed by engineer in charge.</p>	SMT	Separate sheet attached
61	<p>Providing and fixing FRP frame size 100x50 mm and 28mm thick FRP depress panel shutter having extra reinforcement on sides & edges in Gel coat finish. The core of the shutter & frame is to be filled up with injected fire retardant grade polyurethane foam done in situ alongwith embedded wooden pieces for stiffening & also taking hinges & fintures. The whole FRP frame & shutter is to be water proof weather proof, termite proof & resistance to mild acid/alkali. Rates are to be inclusive of S.S hinges with necessary screws & alluminium fixtures & fastenings & fastener sleeve</p>	SMT	Separate sheet attached
62	<p>Providing and fixing window having extruded aluminum Colour anodized section frame main outer size 95mm x 24mm x 1.17mm @ wt.of 0.738 Kg/mt , horizontal Three track member size 92mm x 31.75mm x 1.30mm,@ Wt.1.07 Kg/mt , vertical member of size 92mm x 31.75mm x 1.50mm @ Wt. 1.06 Kg/mt with sliding shutters of horizontal member size 40 mmx18mm x1.29mm @ wt.of 0.456 Kg/mt, vertical member of size 40mm x 18mm x 1.29 mm @ wt.of 0.456Kg/mt/ with 5 mm thick transparent bronze colour tinted float glass with powder coated aluminum fittings and fixtures and transparent silicon sealant glass fixing to frame as per details etc</p>	SMT	Separate sheet attached

63	Providing and fixing window having extruded aluminum Colour anodized section frame main outer size 63.50 x 38.10 x 1.95 mm,@ Wt 1.094 Kg / Rmt, horizontal two track member size 61.85 mm x 31.75 mm x 1.20mm @ wt.of 0.695 Kg/mt, vertical member of size 61.85 mm x 31.75mm x 1.30 mm @ wt.of 0.659 Kg/mt with sliding shutters of horizontal member size 40mm x 18mm x 1.29mm @ wt.of 0.456Kg/mt, vertical member of size 40mm x 18mm x 1.29mm @ wt.of 0.456Kg/mt, @ Wt. 0.457 Kg/mt with 5 mm thick transparent bronze colour tinted float glass with powder coated aluminum fittings and fixtures and transparent silicon sealant glass fixing to frame as per details etc complete for window.	SMT	Separate sheet attached
64	Providing and fixing standared extruded of alluminium section of size 63.50 x 38.10 x 1.95 mm,@ Wt 1.094Kg / Rmt with colour anodized alluminium frame with 5 mm thick transparent bronze colour tinted float glass as details etc complete for openable shutter window.	SMT	Separate sheet attached
65	Providing and fixing standared extruded of alluminium section of size 63mm x 38.10mm x 1.2mm @ Wt. 0.643 Kg/mt with colour anodized alluminium frame for ventilation with 5 mm thick frosted glass as details etc complete for Ventilation	SMT	Separate sheet attached
66	Providing and fixing M.S. grills of required pattern to marble/granite frames of window etc. with M.s. flats at required spacing and frames around, square or round bars fixed with round headed bolts and nuts or by screws, including oil painting with one coat of primer of approved quality and brand & two coats of synthetic enamel oil paint etc. complete as per detail drawing and as directed by Engineer in charge.	Kg	Separate sheet attached
67	Providing and fixing 0.90 meter wide and 0.80 meter high sand which type platform including supplying and fixing granite stone 18 mm thick mirror polished stones in top and side position and vertical strip at front over 25 mm thick polished kotah stone platform fixing in top and sides and intermediates supports fixing with cement mortar and adhesive and finishing etc complete.	SMT	Separate sheet attached
68	Providing & laying 24"x24" Vitrified tiles 8 MM thick in flooring over 40 mm (Av.) base of C.M. 1:6 (1 Cement : 6 Coarse sand) on new surface or fixing on existing flooring by adhesive materials incldg. Dismanteling of existing flooring & joined with colour cement slurry including finished with flush pointing & cleaning the surface etc. completed Light Shade.	SMT	Separate sheet attached
69	Providing and laying Vitrified tiles 8 to 10 mm thick , 24" x 24" in skirting risers of steps and dedo on 10mm thick cement plaster 1:3 (1-cement : 3-coarse sand) and jointed with white cement slurry	SMT	Separate sheet attached
70	P & L 24" x 24" vitrified 8 mm thick tile flooring over 40 mm (average) base of cement mortar 1:6 (1 cement: 6 coarse sand) on new surface or fixing on existing flooring by adhesive material including Applying spacer of 5mm and not less than 3mm depth and filling groove with epoxy filler material of laticrete , Roff or equivalent. & cleaning the surface etc. complete for light shade	SMT	Separate sheet attached
71	Providing and laying white glazed tiles 6mm thick in flooring treads of steps and landing laid on a bed of 12mm thick cement mortar 1:3 (1-cement : 3-coarse sand) finishing with flush pointing in white cement.	SMT	it no 14.32 ,it code 14008AA General Technical Specification Booklet

72	Providing and laying white glazed tiles 6mm thick in skirting risers of steps and dedo on 10mm thick cement plaster 1:3 (1-cement : 3-coarse sand) and jointed with white cement slurry	SMT	it no 14.32 ,it code 14009AA General Technical Specification Booklet
73	Providing and laying Lather finished granite stone slab 18mm thick in flooring treads of steps and landing laid on a bed of 12mm thick cement mortar 1:6 (1-Cement : 6-Coarse Sand) finishing with full molded round edges, flush pointing in white or colour cement.	SMT	Separate sheet attached
74	Providing and laying polished Granite Slab 18mm thick in Risers of steps Dedo, window sill, jembes and pillars laid 10mm thick Cement Mortar 1:3 (1-Cement : 3 coarse sand and jointed with Grey Cement Slurry including full molded round front edges , rubbing and polishing etc. complete.	SMT	Separate sheet attached
75	Providing and laying polished Kota stone slab flooring over 20mm (Average) thick base of cement mortar 1:6 (1-cement : 6-coarse sand) or L.M. 1.1.5 (1-Lime putty :1.5 - coarse sand) laid over and jointed with grey cement slurry mixed with pigment to match the shade of slab including rubbing and polishing etc. complete. (A) 25mm thick	SMT	Item no:14.43 , it Code 14012AA General Technical Specifications Booklet
76	Providing and laying polished kota stone slab 25mm thick in risers of steps,skirting Dedo and pillars laid on 40mm thick cement mortar 1:3 (1-Cement : 3 coarse sand) and jointed with gray cement slurry mixed with pigment to match the shade of slab including rubbing and polishing etc. complete.	SMT	Item no:14.44 , it Code 14013A General Technical Specifications Booklet
77	Providing 10 mm thick cement mala plaster on ceiling and soffits of stairs for interior upto floor two level, in cement mortar (1:4) (1 cement : 4 sand) etc complete. Ground floor	SMT	Item no:17.58, it Code 17001A + 17.91, it Code 17006 General Technical Specifications Booklet
78	Providing 10 mm thick cement mala plaster on ceiling and soffits of stairs for interior upto floor two level, in cement mortar (1:4) (1 cement : 4 sand) etc complete. First floor	SMT	Item no:17.58, it Code 17001A + 17.91, it Code 17006 General Technical Specifications Booklet
79	Providing 10 mm thick cement mala plaster on ceiling and soffits of stairs for interior upto floor two level, in cement mortar (1:4) (1 cement : 4 sand) etc complete. Second floor	SMT	Item no:17.58, it Code 17001A + 17.91, it Code 17006 General Technical Specifications Booklet
80	Providing 10 mm thick cement mala plaster on ceiling and soffits of stairs for interior upto floor two level, in cement mortar (1:4) (1 cement : 4 sand) etc complete. Terrace floor	SMT	Item no:17.58, it Code 17001A + 17.91, it Code 17006 General Technical Specifications Booklet
81	Providing 15 mm thick cement mala plaster in single coat on fair side bricks/concret walls for interior plastering up to floor two level finished even and smooth in cement mortar 1:4 (1 cement : 4 sand) etc complete. Ground Floor	SMT	Item No.17.61(II),it Code 17003B General Technical Specifications Booklet Provide 15mm thickness instead of 20mm .
82	Providing 15 mm thick cement mala plaster in single coat on fair side bricks/concret walls for interior plastering up to floor two level finished even and smooth in cement mortar 1:4 (1 cement : 4 sand) etc complete. First Floor	SMT	Item No.17.61(II),it Code 17003B General Technical Specifications Booklet Provide 15mm thickness instead of 20mm .
83	Providing 15 mm thick cement mala plaster in single coat on fair side bricks/concret walls for interior plastering up to floor two level finished even and smooth in cement mortar 1:4 (1 cement : 4 sand) etc complete. Second Floor	SMT	Item No.17.61(II),it Code 17003B General Technical Specifications Booklet Provide 15mm thickness instead of 20mm .
84	Providing 15 mm thick cement mala plaster in single coat on fair side bricks/concret walls for interior plastering up to floor two level finished even and smooth in cement mortar 1:4 (1 cement : 4 sand) etc complete. Third(Terace) Floor	SMT	Item No.17.61(II),it Code 17003B General Technical Specifications Booklet Provide 15mm thickness instead of 20mm .
85	20mm.thick sand faced cement plaster on walls upto height 10 meters above ground level consisting of 12mm. Thick backing coat of CM.1:3 (1-cement:3-sand) and 8mm.thick finishing coat of C.M. 1:1 (1-cement:1-sand) etc. complete.	SMT	Item no:17.95, it Code 17009 General Technical Specifications Booklet

86	Providing and laying 20 mm thick water proof cement plaster using water proofing powder 1Kg/1bag of cement for all floors on brick / concrete wall work using water proofing materials in C M 1: 4 (1 cement 4 coarse sand) including finishing with a floating coat of neat cement slurry etc complete for all floor.	SMT	it no 17.19 it code e 17003B + it no 5.7.5 it code e 5022 General Technical Specifications Book .
87	Providing throating or plaster drip and moulding to R.C.C. Chajja etc.comp	RMT	it no 0 it code 5.4.18 General Technical Specifications Booklet
88	Prov.20mm deep finished groove etc.comp	RMT	Separate sheet attached
89	Providing and fixing chicken wiremesh jali at R.C.C. masonry joints at any height with all labour & material etc. complete.	SMT	Separate sheet attached
90	Applying two coats of birla(White cement based) or Asian (acrylic lappy putty) or equivalent two coats of primer of approved brand and manufacture on new wall surface to give an even shade including thoroughly brushing the surface free from mortar dropping and other matter foreign and sand papered smooth.	SMT	Separate sheet attached
91	Wall painting (three coats) with plastic emulsion paint of approved brand and manufacture on undecorated wall surface to give an even shade including thoroughly brushing the surface free from mortar droppings and other foreign matter and sand papered smooth.	SMT	Separate sheet attached
92,93	Wall painting (two coats) with plastic emulsion paint of approved brand and manufacture on ceiling and slopping roofs to give an even shade including thoroughly brushing the surface free from mortar droppings and other foreign matter and sand papered smooth.For All Floors.	SMT	Separate sheet attached
94	Finising wall with weatherproof exterior emulsion paint on wall surface (two coats) to give and required shape even shade after thoroughly brushing the surface to remove all dirts , and remains of loose powdered materials etc. complete. including two Coats of primer has to be applied.	SMT	it no 18.51 it code 18027 General Technical Specifications Booklet but use weatherproof exterior emulsion paint instead of water proofing cement paint
95	Providing & applying single coat of textured finish at external surface at all floor levels with three coats of weather proof cement exterior paint of approved standard brands make t at outer side of the building on RCC or Masonary walls. Including all labour, materials, staging, scaffolding, cleaing, curing etc. application of texture after thoroughly brushing the surface to give an even shade free from mortar dropping/other foreign matter etc. complete. application of texture finish & paints must be as per company's standard instructions. Texture and colour selection as per approved by engineer in charge.	SMT	Separate sheet attached
96	Providing cement vata, 10 cm. x 10 cm. size, quarter round in cement mortar 1:1 including neat cement finishing, watering, etc. complete.	SMT	it code 17015 General Technical Specifications Book .
97	Providing and laying chaina mosaic water proofing treatment on terrace including applying neat cement slurry 2.75 Kg./Sqm. Of cement admixed with water proofing compound after cleaning the surface (b) laying cement concrete usig brick bats 25 to 100 mm size with 50% C.M. 1:5 (1 cement : 5 coarse sand) admixed with water proofing compound over 20 mm thick layer of C.M. 1:5 to required slope including rounding of junction of walls and slabs (a) after two days of proper curing applying a second with 20 mm thick C.M. 1:4 and china mosaic tiling and finally finishing the surface with trowel white cement slurry (e) after finishing the whole terrace shall be flooded with water for two weeks.	SMT	Separate sheet attached

98	Supply & Fixing of Broken Glazed (China Mosaic) tiles size 5-6 mm thick of different size and shade (approved crazy pattern) in Cement:Mortar 1:2 and joint filling with White Cement / Coloured Cement with water proofing component including Ramping, Watering, Curing etc. complete (FOR ALL FLOOR)	SMT	Separate sheet attached
99	Steel work welded in built up sections framed work including cutting, hoisting, fixing in position and applying a priming coat of red lead paint. [A.] In beams and joists, channels angles tees, flats with connecting plates or angle cleats as in main and cross beams, Hip and jack rafters, purlins connected to common rafters and the like.	Quintal	Separate sheet attached
100	Steel work, welded in built up sections framed work including cutting, hoisting, fixing in position and applying two coat priming of red lead paint and two coats of synthetic enamel paint . (A)In beams and joists, channels angles Tees, flats, with connecting plates or angle cleats as in main and cross beams. Hip and jack rafters, purlins conneted to common rafters and the like for for Main entry gate & compound wall grill.	Kg.	Separate sheet attached
101	Providing and Fixing 90 cm high stainless steel railing made from anticorrosive 304 grade S.S. Staircase Railing modular type welded fitting (S-Rail SR11 Square Type Steel Baluster),Main hand Rail pipe (DASA Pipe) 50mm outer dia 1.6 mm Thickness SS 304 Grade, Balustar steel square type 32X32mm outer dia. 1.6mm thickness ss 304 pipe, 3 pipe below main dasa pipe 16 mm outer dia. 1.6mm thickness ss304 grade as a vertical support fixed in RCC S.S. pipe with steel modular type fitting baluster including all type accessories as per detailed drawing as directed etc. complete for all floors.	RMT	Separate sheet attached
102	The providing & fixing of Fix louvered work. The main frames both verticals and horizontals have to be Aluminium pipes of 100 mm x 50 x 3.0 mm with colour anodized 20 micron (silver) thick, including All hardware, labour,scaffolding,fixtures,fastners transport and all other taxes included etc. complete as per architect's details at all floor levels.	SMT	Separate sheet attached
103	Providing and fixing Semi unitized vision panel with glazed units (SGU) of size as per design and consisting of 6 mm thick (toughened)glass approved by the architect. with mullion(101mmx57mmx1.8mm,8.9 kg/12 rft) ,transum(63mmx57mmx1.8mm,5.8 kg/12 rft),sub frame(54mmx22mmx1.25mm,2.4kg/12 rft),with anodizing,with m.s. hot deep galvanized bracket,with s.s. hardware The glazed panel to be formed by means of imported special structural quality silicon adhesive sealant layer manufactured by M/S. Dow Corning 995 USA with material:- silicone dowcorring 789weather silicone in 995 dow corring.It includes cost of labour, materials, accessories, adhesives,all required M.S FABRICATIONS, scaffolding, wastages, transport, taxes, fixing into a neat finish in aesthetic point of view, without any undulations in facias all complete as per drawing and Instruction of engineer in-charge	SMT	Separate sheet attached

104	(Top hung Openable part) Providing and fixing openable hardware for glazing as per detail , It includes cost of labour, materials, accessories,all required M.S FABRICATIONS,adhesives, scaffolding, wastages, transport, taxes, fixing into a neat finish in aesthetic point of view, without any undulations in facias all complete as per drawing and Instruction of engineer in-charge	No.	Separate sheet attached
105	Providing & fixing in position collapsible steel shutters with vertical channels 20 x10 x 2 mm. Braced with flat iron diagonals 20 x5mm size with top & bottom rails of T-iron 40x40x6mm. with 38mm dia. steel pulleys comp. with bolts, locking arrangements, stoppers, handles incl. applying a priming coat of Redlead paint etc. comp.		it no 11.60 it code11003A General Technical Specifications Book .
106	Providing and laying and fixing 50mm thick expansion joint by hydro cell semi rigid UV resistance with high performance laminated closed cell polythene foam joint filler in sheet foam as directed, etc. complete.	SMT	Separate sheet attached
107	Providing and fixing wsh down water closet (European type, W.C. Pan) with integral P or S trap including jointing the trap with soil pipe in Cement Mortar 1:1 (1-Cement : 1-fine sand) (Seal and cover to be measured and paid for separately)(A) vitreous China Pattern :(i) in white colour	No.	it no 23.112 it codee 23010 General Technical Specifications Book .
108	Providing and fixing plastic seat and cover for wash down water closer with C.P. brass hinges and rubber buffers.	No.	Item No.23.112(A), Item code:23010, General Technical Specification Booklet
109	Providing and fixing washbasin with single hole for pillar tap with C.I. or M.S. brackets painted white including sutting holes and making good the same but excluding fittings.(A) Vitreous China:(ii) Flat Back washbasin 550 mm x v 400mm size. (i) In white colour.	No.	Item No.23.127, Item code: 23018, General Technical Specification Booklet
110	Providing and fixing C.P. brass waste for washbasin or sink. (B) 40mm dia	No.	Item No.23.135, Item code: 23020A, General Technical Specification Booklet
111	Providing and fixing M.I. fisher union for washbasin or sink. (B) 40mm dia	No.	Item No.23.136, Item code: 23021B, General Technical Specification Booklet
112	Providing and fixing chromium plated, bottle trap with necessary couplings of approved quality for wash basin.	No.	Item No.0.00, Item code: 23036, General Technical Specification Booklet
113	Providing and fixing Urinal or approved quality including conecing the Urinal with waste pipe , tap etc. complete.(A) White earthenware flat back or corner type size 430mm x 260mm x 350mm.	No.	Item No.23.124, Item code: 23034, General Technical Specification Booklet
114	Providing and fixing 600mm x 450mm bevelled edge mirror of superior glass mounted on 6mm thick A.C. sheet or plywood sheet and fixing to wooden pluge with C.P. brass screws and washers.	No.	it no 23.143 it code23024 General Technical Specifications Book .
115	Providing and fixing C.P. brass towel rail comlete with C.P. brass brackets fixed to wooden plugs with C.P. brass scews.(B) 600mm x 20mm size.	No.	it no 23.144 it code23025 General Technical Specifications Book .
116	Providing and fixing PVC SWR Nahni trap IS 14735 for drain - 100 mm diameter with jali of the following nominal diameter of self cleansing design with C.I scread down or hinged grating including the cost of cutting and making good the walls	No.	it no 23.857 it codee 23008 General Technical Specifications Book .
117	Providing and fixing to wall ceiling and floor 10.0 Kg. F/Cm2 working pressure polythene pipes of the following outside Dia. Low density, complete with special falnge compression type fittings, wall clipsetc. including making good the wall ceiling and floor.(F) 75mm	RMT	Separate sheet attached

118	Providing and fixing to wall ceiling and floor 10.0 Kg. F/Cm2 working pressure poluthene pipes of the following outside Dia. Low density, complete with special falnge compression type fittings, wall clipsetc. including making good the wall ceiling and floor.(G)110 mm	RMT	Separate sheet attached
119	Providing and fixing S.W. gully trap with C.I. grating brick masonry chamber and water tight C.I. cover with frame of 300mm x 300mm size (inside) with standard weight.(i) Square mouth traps.(B) 150mm x 100mm size P or R type	No.	it no 24.19 it codee e 24006AA General Technical Specifications Book .
120	Constructing brick masonry chamber for underground C.I. Inspection chamber and bends with bricks having crushing strength not less than 35Kg/Cm2 in C.M. 1:5 C.I. cover with frame (Light duty) 455mm x 610mm intenal dimensions total weight of cover with frame to be not less than 38Kg. (Wt. of cover 23 Kg.) and Wt. of frame 15Kg.) (R.C.C. top slabe with 1:2:4 mix (1-cement :2- coarse sand :4 graded stone aggregate 20mm size) foundation concrete 1:5:10 inside plaster 15mm thick with cement mortar 1:3 finished smooth with a floating coat of neat cement on walls and bed concrete etc. complete.(i) Inside dimensions 455mmx 610mm and 450mm deep for single pipe line.	No.	Item No.24.44, Item code:24016AA, General Technical Specification Booklet
121	Providing laying and jointing in true line and level 15mm dia. U.P.V.C. Pipe (SCH- 40) for cold water including fittings as approved by Engineer In Charge. Pipe shall be fixed on the wall with the help of clamp at every two metre C/C or shall be concealed as directed including necessary fittings etc. including testing of pipe and joints and fixing the same with adhesive solvent, including cost of all materials	RMT	Separate sheet attached
122	Providing laying and jointing in true line and level 25mm dia. U.P.V.C. Pipe (SCH- 40) for cold water including fittings as approved by Engineer In Charge. Pipe shall be fixed on the wall with the help of clamp at every two metre C/C or shall be concealed as directed including necessary fittings etc. including testing of pipe and joints and fixing the same with adhesive solvent, including cost of all materials.	RMT	Separate sheet attached
123	Providing laying and jointing in true line and level 40mm dia. U.P.V.C. Pipe (SCH- 40) for cold water including fittings as approved by Engineer In Charge. Pipe shall be fixed on the wall with the help of clamp at every two metre C/C or shall be concealed as directed including necessary fittings etc. including testing of pipe and joints and fixing the same with adhesive solvent, including cost of all materials.	RMT	Separate sheet attached
124	Providing and fixing concealed center point to wall ceiling & floor CPVC (SDR 13.5) PIPE having National Sanitation Foundation (NSF) seal for potable water of following dia. nominal bore tube fittings and clamps including making good the wall, ceiling and floor etc. complete.[A] 15 mm	RMT	it no 23.20 it code23001AA to 23001FA General Technical Specifications Book .
125	Providing and fixing concealed center point to wall ceiling & floor CPVC (SDR 13.5) PIPE having National Sanitation Foundation (NSF) seal for potable water of following dia. nominal bore tube fittings and clamps including making good the wall, ceiling and floor etc. complete. [C] 25 mm.	RMT	it no 23.20 it code23001AA to 23001FA General Technical Specifications Book .
126	Providing and fixing screw down bib taps of following size.(A) Brass screw down bib tap polished bright. (i) 15mm dia.	No.	it no 23.92 it code 23028A1 General Technical Specifications Book .
127	5 Providing and fixing pillar tap, capstan head, screw down high pressure with screws, shanks and back nuts. (i) 15mm dia.	No.	it no 23.95 it code 23029A General Technical Specifications Book .

128	Providing and fixing brass screw down stop tap.(A) 15mm dia	No.	it no 23.96 it code 23030A General Technical Specifications Book .
129	Providing and fixing chromium plated brass half trun flush cock of approved quality including fixing in pipe line etc. complete.(ii) 25mm dia.	No.	it no 124 it code 23032A to23032C General Technical Specifications Book .
130	Providing and fixing ball cock of approved. quality as directed.(A) Copper Metal (i) 25mm dia	No.	it no 0.00 it code 23037A1 to23032C General Technical Specifications Book .
131	Providing and fixing in position cowel went to pipes.(B) 75mm dia	No.	Separate sheet attached
132	Providing and fixing in position cowel went to pipes.(C) 100mm dia	No.	Separate sheet attached
133	Providing erecting and fixing double coated ISI water tank of required capacity each with all necessary fittings and connection etc. complete on terrace	Liter	Separate sheet attached
134	Providing and fixing SS Sink Glosy ASIS 304 Grade x 1mm thick with over all size 610x460 mm & bowl size 560x410x200 including Providing and fixing chromium plated, bottle trap with necessary couplings of approved quality and C.P. Pillar cock 15 mm Heavy duty swan neck etc complete as per detail drawing and instruction of EIC.	No.	Separate sheet attached
135	Providing and fixing G.I. Rain water spout of 50mm dia. and 30cm. length.	Nos.	it no 0 it codee 23039 General Technical Specifications Book .
136	Supplying & fixing 0.60x0.45 M size C.I. mahole cover with frame in slab as directed with 2 coats of anti-corrosive shop paint etc. comp. as directed.	Nos.	it no 0.00 it codee 2303B General Technical Specifications Book .
137	Providing and fixing cast iron steps of size 500mm x 150mm x 22.5mm and painting with two coats of Anti-corrosive paint etc. complete.	Nos.	it no 24.33 it codee 24010 General Technical Specifications Book .
138	Box cutting the road surface to proper slope & camber for making a base for road work including removing the excavated stuff, and depositing on the road side slopes as directed up to 50 Mt. Lead	CMT	Separate sheet attached
139	Rolling and Consolidating of soling including filling in depression which occurs during the process with power roller 8 tonne to 12 tonne. and compacting the bed as per specifications to core test 97% compacting complete in all respects to the entire satisfaction of the Engineer-in -charge.	Sqm	Separate sheet attached
140	Providing and fixing pre- cast concrete kerb stone of gray cement based concrete block 30 cm length, 30 cm height and 15cm thick of 250 grade concret as per approved design and including excavation for fixing in proper line and level, fillig the joint with C: M 1:3 (1 Cement : 3 Fine Sand) etc. complete	RMT	Separate sheet attached
141	Providing, laying, spreading and consolidation graded stone aggregate to wet mix macadam 150mm compacted thick as per MORT & H specifications including premixing the material with water at OMC in mechanical plant carriage of mixed material by tippers to site, laying in uniform layers with paver in sub base/ base course on well prepared surface and compacting with vibratory roller to achieve the desired density	CMT	Separate sheet attached

142	Providing & laying of specified compacted thickness Granular sub base (GSB) in specified grading in table 400-1 of the specification MORT&H and compactor to the required density with 8 - 10 tonne vibratory roller with plain drum or heavy pneumatic tyred roller of minimum 200 to 300 KN weight in all seasons as per MORT&H , maintaining the required slope & grade during the operation as approved by the engineer in charge & watering to the proper moisture content and sprinkled with the help of truck mounted water tank fitted with suitable arrangement .(fully saturated having CBR value greater or equal to 30) compacted thickness of 150 mm consisting of Machine crust stone aggregate as per grading 1 in table 400-1 of the specification MORT&H fifth Revision	CMT	Separate sheet attached
143	Providing and fixing pre-cast Rubber Dye / steel Dye inter locking concrete block 60mm thick with grade of concrete M300 pnumatic compressed / vibrated mechanically and as per approved design Confirming to IS 15658 : 2006 including 35 mm Sand layer for levelling and filling the joint with sand in proper line and level as per guidlines of IRC : SP 63-2018 etc. Complete.	SMT	Separate sheet attached
144	Providing and Laying trimix Controlled cement concrete M-250 finishing smooth with curing etc. complete including the cost of formwork but excuding the cost of reinforcement for internal road having thickness of 15 CM.compaction and finishing of road by trimix process surface by using vaccum dewatering, floater surface vibrator etc.Rate are also inclusive of Providing and Mixing Plastisizer of approved make.	CMT	Separate sheet attached
145	Shrubs/Ground covers Supplying and planting healthy shrubs of different species of 450mm to 900 mm height: by using the soil/ manure (either carted or supplied), and watering it immediately. Maintaining(application of liquid manures/ growth regulators/ pesticides as per need, weeding and gap filling regularly so as to keep the plant healthy all the time) it for a period of 3 months from the date of plantation-Ixora Pink,Ixora Red, Ixora Yellow,Ixora White or as per selection of Engg. in charge/Architect.	Nos.	Separate sheet attached
146	Lawn/Grass Supplying and planting of good quality nodes of specified grass for dibbling: It includes the cultivation of dround to a depth of 150mm, Planting (2"-3" apart) of grass as per drawing without disturbing the desired gradient and level, watering, maintaining (forking, mowing, weeding, fertilizer application, pest control etc.) it for a period of 3 months from the date of lawn dibbling/plantation. Doob grass(dibbling)	SMT	Separate sheet attached

Bhavnagar Municipal Corporation

Technical Specifications (Civil)

Name of Work :- Construction Of New PHC In The Area Of Bhavnagar City, Kumbharwada, Bhavnagar(B.M.C.)

Item No: -4

Clearing and grubbing road land including uprooting rank vegetation grass bushes, shrubs, sapling and trees girth up to 300 mm removal of stumps of trees cut earlier and disposal of unserviceable materials (C) By mechanical means in area of light jungle

Scope

Clearing and grubbing shall be performed less than one month in advance of earthwork operations and shall consist of cutting, trimming, removing and disposing of all materials such as trees, tree branches, bushes, shrubs, stumps roots, grass, weeds, ant hills, jungle top organic soil not exceeding 150 mm in thickness, rubbish, loose stones, boulders, etc. which are undesirable and unsuitable for use in the works, from the designated area of land, and such other areas as specified on the drawings or from areas as directed by the Engineer. It shall include grubbing, necessary excavation, backfilling of pits resulting from uprooting of trees and stumps to required compaction, handling, salvaging, removal and disposal of cleared materials in accordance with the requirements of these Specifications.

Re-clearing of the site of any vegetation, grass shrubs before commencement of work shall be carried

out as directed by the Engineer and shall be incidental to the work of clearing and grubbing.

Preservation of Property / Amenities

Roadside trees, shrubs, any other plants, pole lines, fences, signs, monuments, buildings, pipelines, sewers and all highway facilities within or adjacent to the road which are not to be disturbed shall be protected from injury or damage by providing and installing suitable safeguards as shown in the drawing or as approved by the Engineer.

During clearing and grubbing the Contractor shall take all adequate precautions for preservation of all vegetation adjacent to road land against soil erosion, water pollution, etc. and where required, shall undertake additional works to that effect. Before start of operations, the Contractor shall submit to the Engineer for approval, his work plan including the procedure to be followed for disposal of waste materials, etc. and the schedule for carrying out additional work where required.

Conservation of Top-soil

The top-soil removed during clearing and grubbing of site, if suitable for re-use shall be transported, conserved and stacked as directed by the Engineer. This shall be incidental to the work.

Methods, Tools and Equipment

Only such methods, tools and equipment as are approved by the Engineer shall be adopted for the work. If the area has thick vegetation/roots/trees, a crawler or dozer shall be used for clearance

purposes. All trees, stumps, etc. falling within excavation and fill line shall be cut to such depth below ground level that in no case these fall within 500 mm of the sub grade. Also, all vegetation such as roots, under-growth, grass and other deleterious matter unsuitable for re-use in the embankment/sub grade shall be removed between fill lines to the satisfaction of the Engineer. On areas beyond these clearing limits trees and stumps required to be removed shall be cut down to 500 mm below ground level so that these do not present an unsightly appearance. All branches of trees extending above the roadway shall be cut or trimmed so as to provide a clear height of 5 m above the road surface and shoulders. All excavations below the general ground level arising out of the removal of trees, stumps etc. shall be filled with material conforming to prescribed requirements and compacted to specified density, given by the Engineer.

Removal of Ant-hills

Ant-hills both above and below the ground, as are liable to collapse and obstruct free subsoil water flow shall be removed by excavating to a suitable depth as directed by the Engineer. The excavated ant-hills material shall be carted away from the site. Cavities in the ground due to removal of ant-hills shall be filled with approved material and compacted to specified densities, as directed by the Engineer.

Disposal of Materials

All materials including trees, stumps, etc. arising from clearing and grubbing operations shall be the property of Government and shall be disposed off by the Contractor as here-in-after provided or as directed by the Engineer.

Trunks, branches and stumps of trees shall be cleaned of limbs and roots and stacked. Also boulders, stones and other materials usable in road construction shall be neatly stacked as directed by the Engineer. Stacking of stumps, boulders, stones etc. shall be done at specified spots with all lifts and upto a lead of 1000 m.

All products of clearing and grubbing which cannot be used or auctioned shall be cleared away from the roadside in a manner as directed by the Engineer. Care shall be taken to see that unsuitable waste materials are disposed off in such a manner that there is no likelihood of these getting mixed up with the materials meant for embankment, sub grade and road construction or cause undesirable environmental conditions.

Measurements for Payment

Clearing and grubbing shall be measured on area basis in terms of Hectare Cutting of trees upto 300 mm in girth including removal of stumps and roots, and cutting/trimming of branches of trees extending above the roadway shall be considered incidental to the clearing and grubbing operations. Removal of stumps of trees upto 300 mm girth left over after trees have been cut by any other agency of the Contractor or Government shall also be considered incidental to the clearing and grubbing operations. Cutting, including removal of stumps and roots of trees of girth above 300 mm and backfilling to required compaction and removal of stems and roots of trees of girth above 300 mm diameter left over after trees have been cut by any other agency or the government shall be measured in terms of number according to the sizes given below:

- (i) Above 300 mm to 600 mm
- (ii) Above 600 mm to 900 mm
- (iii) Above 900 mm to 1800 mm
- (iv) Above 1800 mm to 2700 mm

(v) Above 2700 mm to 4500 mm

(vi) Above 4500 mm

For this purpose, the girth shall be measured at a height of 1 m above ground or at the top of the stump, if the height of the stump is less than 1 m from the ground.

Where the proposed work site passes through dense forest area, clearing and grubbing including cutting of trees of all girths and removal of their roots and stumps, etc. for construction of road embankment, drains and cross-drainage structures shall be measured on area basis.

Acceptance

Acceptance of clearing and grubbing shall be based on visual inspection of the work for compliance with the above specifications to the satisfaction of the Engineer.

Rate

The Contract unit rates for the various items of clearing and grubbing shall be paid/payable in full for carrying out the required operations including full compensation for all labour, materials, tools, equipment and incidentals necessary to complete the work. These will also include removal of stumps and roots of trees less than 300 mm in girth as well as stumps left over after cutting of trees carried out by another agency of the Contractor or Government, excavation and backfilling to required density, where necessary, and handling, salvaging, piling and disposing of the cleared materials with all lifts and up to a lead of 1000 m.

The Contract unit rate for cutting (including removal of stumps and roots) of trees of girth above 300 mm and removal of stems and roots of trees of girth above 300 mm left over after trees have been cut by any other agency or the government shall include excavation and backfilling to required compaction, handling, salvaging, piling and disposing of the cleared materials with all lifts and up to a lead of 1000 m as directed by the Engineer.

The rate shall be for a unit of one Hectare.

Item No: -5

Dewatering In all sorts of soil and soft murrum,hard murrum and bulders, soft rock, hard rock up to 1.50 mt depth from G.L

Above item shall be executed as per detail item description and shall be get approved by engineer in charge.

- 1 Any water which may accumulate in the excavation during the progress of the work, either, by percolation, seepage, springs, rain or any other cause shall be bailed out by pumping and diverting surface flow if any by earthen binds or by any other means. The bunds shall be removed as soon as the work is completed.
- 2 The Contractor shall provides, maintain and operate sufficient number pumping equipment of approved capacity to keep the. construction free from water and any sub soil water arising during the construction period.
- 3 Pumping shall be so controlled to dispose of water from adequate drainage ditches and shall not be rated so as to make in convenience in constructional operations in general. Precaution shall be taken by the Contractor to prevent any damage to the trench, pipe line of adjustment structure.
- 4 The excavation shall be kept free from water by the contractor (1) During excavation (2) When pipe laying and construction of joints are in progress and till the Engineer-in-charge

considers that the mortar is sufficiently set. (3) During hydraulic testing inspection and measurements.

The rate shall be for a unit of one Cum. Of dewatering done.

Item No: -6

Rammed Rubble soling With Lean Mix cement mortar (CM 1:10) Preferably Joint fill up with lime mortar 1:4 etc. comp.

1.0 Material:

The Lime mortar shall conform to M-10. Stone shall conform to M-16.

2.0 Workmanship:

All the stone shall be sufficiently wetted before laying to prevent absorption of water from mortar. The wall shall be built true to slope of subgrade.

All stone shall be carefully laid, hammered down by a wooden mallet into position and solidly embedded in mortar, chips and spawns of stone may be used wherever necessary to avoid thick mortar bends or joints at the same time ensuring that no hollow space is left any where in the pitching.

All the joints shall be completely filled with mortar and width shall not exceed 25 mm. when plastering of pointing is not required to be done, the joints shall be struck flush and finished simultaneously while laying the stone. Otherwise the joints shall be racked to a minimum depth of 20 mm. by a racking tools, during progress of laying while the mortar is still green.

3.0 Mode of Measurement and Payments:

The rate shall include the cost of all materials and labour involved in all the operations described above. The rate shall be for a unit of one Cubic meter.

Item No: -47,48,49,50

Providing TMT Bar FE 500/500D reinforcement for R.C.C. work including bending, binding and placing in position complete up to plinth level, above floor two level.

1.0 Materials

1.1. High yield Strength Steel Deformed Bars: 1.1.1 High yield strength steel deformed bars are either cold twisted or hot rolled, shall conform to I.S. 1739-1966 and I.S.1139-1966 respectively.

1.2. Mild Steel Binding Wire: 1.2.1 The mild steel wire shall be of 1.63 mm or 1.22 mm. (16 or 18 gauge) diameter and shall conform to I.S. 280-197.

1.2.2 The use of black wire be permitted for binding reinforcement bars. It shall be free from rust, Oil paint, grease, looser mile scale or any other undesirable coating which may prevent adhesion of cement mortar.

2.0. WORKMANSHIP:

2.1. The work shall consist of furnishing and placing reinforcement to the shape and dimensions shows as on the drawings or as directed.

2.2. Steel shall be clean and free from rust and loose mill scale at the time of fixing in position and subsequent concreting.

2.3. Reinforcing steel shall conform accurately to the dimensions given in the bar bending schedules shown on relevant drawings. Bars shall be bent cold to specified shape and dimensions or as directed using a proper bar bender, operated by hand or power to attain proper radius of bends. Bars shall not be bent or straightened in a manner that will injure the material. Bars bent during transport or handling shall be straightened before being used on the work. They shall not be heated to facilitate bending. Unless otherwise specified, a 'U' type hook at the end of each bar shall invariably be provided to main reinforcement. The radius of the bend shall not be less than twice the diameter of the round bar and the length of straight part of the bar beyond the end of the curve shall be at least four times the diameter of the round bar. In case of bars which are not round and in case of deformed bars, the diameter shall be taken as the diameter of circle having an equivalent effective area. The hooks shall be suitably encased to prevent any splitting of the concrete.

2.4. All the reinforcement bars shall be accurately placed in exact position shown on the drawing and shall be securely held in position during, metal hangers, supporting wires or other approved devices at sufficiently close intervals, Bars shall not be allowed to sag between supports nor displaced during concreting or any other operations of the work. All devices used for positioning shall be of non-corrodible

material. Wooden and metal supports shall not extend to the surface of concrete, except where shown on drawings. Placing of broken stone or brick and wooden blocks shall not be allowed. Pieces of broken stone or brick and wooden blocks shall not be used. Layers of bars shall be separated by spacer bars, precast mortar blocks or other approved devices. reinforcement after being placed in position shall be maintained in a clean condition until completely embedded in concrete. Special care shall be exercised to prevent any displacement of reinforcement in concrete already placed. To prevent reinforcement from corrosion, concrete cover shall be provided as indicated on drawings. All the bars producing from concrete and to which other bars are to be spliced and which are likely to be exposed for a period exceeding 10 days shall be protected by a thick coat of neat cement grout.

2.5. Bars crossing each other where required shall be secured by binding wires (annealed) of size not less than 1 mm in such manner that they do not slip over each other at the time of fixing and concreting.

2.6. As far as possible, bars of full length shall be used. In case this is not possible, overlapping of bars shall be done directed. When practicable, overlapping bars shall not touch each other, but be kept apart by 25 mm or 1.25 mm times the maximum size of the coarse aggregate whichever is greater by concrete between them. Where not feasible, overlapping bars shall be bound with annealed wires not less than 1 mm thick twisted tight. The overlaps shall be staggered for different bears and located at points along the span where neither shear nor bending movement is maximum.

2.7. Whenever indicated on the drawings or desired by the Engineer-in-charge, bars shall be joined by couplings which shall have a cross-section sufficient to transmit the full stresses of bars. The ends of the bars that are joined by coupling shall be upset for sufficient length so that the effective cross section at the base of threads is not less than normal cross-section of the bar. Threads shall be standard threads. Steel for coupling shall conform to I.S. 226

2.8. When permitted or specified on the drawings, joints of reinforcement bars shall be butt-welded so as to transmit their full stresses. Welded joints shall preferably be located at points when steel will not be subject to more than 75 percent of the maximum permissible stresses and welds so staggered that at any one section not more than 20 percent of the rods are welded. Only electric arc welding using a process which excludes air from the molten metal and conforms to any or all other special provisions for the work shall be accepted. Suitable means shall be provided for holding bars securely in position during welding. It shall be ensured that no voids are left in welding and when welding is done in two or three stages, previous surface shall be cleaned properly. Ends of the bars shall be cleaned of all loose scale, rust, grease, paint and other foreign matter before welding. Only competent welders shall be employed on the work. the M.S. electrodes used for welding shall conform to I.S. 814. Welded pieces of reinforcement shall be tested. Specimen shall be taken from the actual site and their number and frequency of test shall be as directed.

2.9. The above specifications shall be followed except that the cold twisted steel bars shall be used with or without hooks and the ends. Deformed bars without hooks shall however comply with however comply with relevant anchorage requirements.

3.0 Mode of Measurement:

3.1 For the purpose of calculation consumption, wastage shall both be permitted beyond 5 percent. Excess consumption over 5 % will be charged at penal rate

3.2 Reinforcement shall be measured as per Paripatra no.-PDW-10-1017-01-C, Dt.-15-02-2017

3.3 The rate shall be for a unit of One Kg.

Item No: -58

Providing and fixing of full height glass partitions (AS PER DRAWINGS) using 19 or 25 mm C-channels in border and edge profile in between with powder coating , 12mm clear toughned glass, film work as per drawing including all hardware items, silicon, etc with all material, labour, cutouts, edge polish , lead and wastage etc. and complete the work satisfactorily as per instruction of architect or Engineer-in charge.

1.0	Specifications
	Providing and fixing of full height glass partitions (AS PER DRAWINGS) using 19 or 25 mm C-channels in border and edge profile in between with powder coating , 12mm clear toughnedglass,film work as per drawing including all hardware items,silicon,etc with all material, labour,cutouts,edge polish , lead and wastage etc. and complete the work satisfactorily as per instruction of architect or Engineer-in charge.
2.0	Materials

1	Hardware (Nail/Screw/silicon/U Channel/EPDM gasket etc) of approved quality
2	12 MM GLASS TOUGHED of AIS,saingobain or modiguard with edge polish
3	18 to 25 mm black u channel as per detail
3	Frosted film as per selection,including cutwork
3.0	Workmanship
1	entire work to be carried out as per drawings,instructions and supervision of the architect
4.0	Mode of measurement & Payment
1	measurement of glass partitions shall be considered from finished floor to finished ceiling level only
2	The rate shall be consolidated for all above items including wastage. The rate shall include cost of all materials,fixtures, joineries etc. & labour to complete the work satisfactorily as per instruction of Engineer-in charge. No Extra payment will be given for any of the reasons. The rate shall be for a unit of One Square meter basis

Item No: -59

Providing and fixing of 12 mm tktoughned GLASS DOORS using Dorma XI-C 4001 Glass Door PKG EN 3 (Top Patch-1, Bottom patch-1, Floor Spring-1, Corner Lock-1); Dorma XI-C 4003 A Patch fitting for overpanel and sidelight; Dorma XI-C 4004 A Connector for overpanel and Sidelight; Dorma XI-C 4006 Central Connector; Dorma XI-C 4008 Side Connector; Dorma XI-C 3000 H Type Handle 400x22 CTC 300 AND AS PER DRAWING including all accessories,locks, material, silicone,labour,installation, Hole &slote charges etc. and complete the work satisfactorily as per instruction of architect or Engineer-in charge.(APPROX SIZE OF 0.90 X 2.40)

1.0	Specifications
	Providing and fixing of 12 mm tktoughned GLASS DOORS using Dorma XI-C 4001 Glass Door PKG EN 3 (Top Patch-1, Bottom patch-1, Floor Spring-1, Corner Lock-1); Dorma XI-C 4003 A Patch fitting for overpanel and sidelight; Dorma XI-C 4004 A Connector for overpanel and Sidelight; Dorma XI-C 4006 Central Connector; Dorma XI-C 4008 Side Connector; Dorma XI-C 3000 H Type Handle 400x22 CTC 300 AND AS PER DRAWING including all accessories,locks, material, silicone,labour,installation, Hole &slote charges etc. and complete the work satisfactorily as per instruction of architect or Engineer-in charge.
2.0	Materials
1	12 MM GLASS TOUGHNED with Edge Polish
2	SLOTE & hole in 12 MM GLASS TOUGHNED as required
3	Dorma XI-C 4001 Glass Door PKG EN 3 Top Patch-1, Bottom patch-1, Floor Spring-1, Corner Lock-1
4	Dorma XI-C 4003 A Patch fitting for overpanel and sidelight
5	Dorma XI-C 4004 A Connector for overpanel and Sidelight
6	Dorma XI-C 4006 Central Connector
7	Dorma XI-C 4008 Side Connector
8	Dorma XI-C 3000 H Type Handle 400x22 CTC 300
9	Frosted film as per selection,including cutwork
3.0	Workmanship
1	entire work to be carried out as per drawings,instructions and supervision of the architect
4.0	Mode of measurement & Payment
1	measurement of DOOR shall be considered per no basis (WITH GLASS SIZE TOLERANCE (PLUS OR MINUS)OF 200 MM IN WIDTH OR HEIGHT)
2	The rate shall be consolidated for all above items including wastage. The rate shall include cost of all materials,fixtures, joineries,transport,FITTING CHARGE, cutting of flooring tiles or granite etc. & labour to complete the work satisfactorily as per instruction of Engineer-in charge. No Extra payment will be given for any of the reasons. The rate shall be for a unit basis, including wastage

Item No :-60

Providing & fixing 35mm.th. Flush Door Solid Double Core type Both Face water proof Ply Vennered& 1.5 mm th.laminate shall be pasted on both side with adhesives as specified by the manufacturers. The laminate shall be as per approved shade & texture, of make incl.. S.S. Hinges with nessary screws &S.S.fixtures& fastenings like handle(10 cm), aldrop(30 cms),

stoppers(20 cms) For all Floor etc as per architectural detailed drawing and as directed by engineer in charge.

1.0. Materials

Flush door shall conform to M-30. Plywood shall conform to M-37.

2.0. Workmanship

2.1. The item covers the requirement of preparation of shutters for doors, windows, clerestory windows, their supply and fixing.

2.2. Shutters:

2.2.1. Paneled shutters shall be constructed in the form of timber frame work of styles and rails with panel inserted of type as specified in the detailed drawings. Panel shall be fixed by providing grooves in the style and rails. The styles and rails shall be joined to each other by mortise and tenon joints at right angles.

2.2.2. All members of the shutters shall be straight without any warp or bow and shall have smooth, well planed faces at right angles to each other.

2.2.3. The size of styles and rails shall be as per drawings or as directed. Styles and rails of shutters shall be made of one piece only.

2.2.4 Door shall be finished with 1.0mm laminated sheet of approved brand on both side and with 6mm thk moulding patti around flush shutter.

2.2.5 Including painting with two coats of synthetic enamel paint over one coat of primer and putty to the door frame including fixing SS hinges, 6 no. - hold fast of size 40 x 6mm flat 300 mm long, wedges, keys, nails, catch screw, lever latches, handle, aldrops, stoppers, etc and cutting/ drilling of necessary holes in masonry/ concrete and grouting of holdfasts with (1:2:4) cement concrete all as per drawing, specification and direction of the Engineer, all materials, tools, plant and labour complete c. (All fixtures & fittings shall be stainless steel of approved quality). approved by architect/Engineer Incharge.

2.3. Timber paneling:

2.3.1. Thickness of the panel shall be as specified in the item as shown in the drawing or as directed. If the panel is made from more than one piece the pieces shall be finished as shown in the detailed drawings and shall be joined with continuous groove with specified size. The end pieces of the panel and the top and bottom of the panel shall be provided with continuous tongue to frame into groove of the frame shutter. An air space of 1.5 mm. shall be left in the groove of frame of shutter while framing the panels in it.

2.3.2. The faces of the panel as well as various pieces of the panel shall be- closely fitted to the sizes of the grooves.

2.3.3. Finishing of the corners of raised panel edges shall be done as shown in drawings or as directed.

2.3.4. The thickness specified shall be finished thickness and no tolerance will be permitted.

3.0. Mode of measurement & payment

3.1. The rate for shutter includes cost of teak wood frame including painting with two coats of synthetic enamel paint over one coat of primer and putty, All fixtures & fittings shall be stainless steel of approved quality as directed.

3.2. The dimension of the shutter shall be measured clear size of the shutter in close position between the grooves of the frame.

3.3. The rate shall be for a unit of one sq. meter.

Item No :-61

Providing and fixing FRP frame size 100x50 mm and 28mm thick FRP depress panel shutter having extra reinforcement on sides & edges in Gel coat finish. The core of the shutter & frame is to be filled up with injected fire retardant grade polyurethane foam done in situ alongwith embedded wooden pieces for stiffening & also taking hinges & fixtures. The whole FRP frame & shutter is to be water proof weather proof, termite proof & resistance to mild acid/alkali. Rates are to be inclusive of S.S hinges with necessary screws & aluminium fixtures & fastenings & fastener sleeve

Refer GTS Booklet Item no.10.12, Page.68 & Item no.10.1, Page.67 Except Frame & shutter FRP material instead of wood frame and paneled shutter.

The rate shall be consolidated for all above item.

The rate includes providing door frame, handles, stoppers and locking arrangements etc. complete Rate shall be for a unit of one Square Meter

ITEM NO:-62

'Providing and fixing window having extruded aluminum Colour anodized section frame main outer size 95mm x 24mm x 1.17mm (of Jindal Section no:2459 @ wt.of 0.738 Kg/mt), horizontal Three track member size 92mm x 31.75mm x 1.30mm (of Jindal Section no:8688,@ Wt.1.07 Kg/mt), vertical member of size 92mm x 31.75mm x 1.50mm (of Jindal Section no:8933,@ Wt. 1.06 Kg/mt) with sliding shutters of horizontal member size 40 mmx18mm x1.29mm (of Jindal Section no:8947@ wt.of 0.456 Kg/mt), vertical member of size 40mm x 18mm x 1.29 mm (of Jindal Section no:8949 @ wt.of 0.456Kg/mt/ with 5 mm thick transparent bronze colour tinted float glass with powder coated aluminum fittings and fixtures and transparent silicon sealant glass fixing to frame as per details etc

Matt anodized aluminium sliding windows shall be made of extruded aluminium sections having thickness not less than 1.5 mm and matt finished colour anodized not less than 20 micron.

The glass 5 mm thick float Saint/Gobain glass white or colour as directed.

All the section for main frame and shutter frame shall be as specified in the item description above.

All the fixture, fastener bearing, locks, handle, gaskets shall be used after getting approved from Engineer-in-charge and architect. The handle section shall be weighing not less than 0.417 Kg/meter. The interlock section shall be weighing not less than 0.464 Kg/mt. and having thickness of 1.5 mm. The glass panel shall be fixed in frame work using EPDM gaskets.

The whole assembly of window shall be fixed in best workman like manner to have smooth operations. All the windows shall be sealed to the R.C.C. or brick work with silicon sealants of dow corning or Wacker Germany as approved by Engineer-in-charge or his consultant.

Item No :-63

Providing and fixing window having extruded aluminum Colour anodized section frame main outer size 63.50 x 38.10 x 1.95 mm,@ Wt 1.094 Kg / Rmt, horizontal two track member size 61.85 mm x 31.75 mm x 1.20mm @ wt.of 0.695 Kg/mt, vertical member of size 61.85 mm x 31.75mm x 1.30 mm @ wt.of 0.659 Kg/mt with sliding shutters of horizontal member size 40mm x 18mm x 1.29mm @ wt.of 0.456Kg/mt, vertical member of size 40mm x 18mm x 1.29mm @ wt.of 0.456Kg/mt, @ Wt. 0.457 Kg/mt with 5 mm thick transparent bronze colour tinted float glass with powder coated aluminum fittings and fixtures and transparent silicon sealant glass fixing to frame as per details etc complete for window.

Matt anodized aluminium sliding windows shall be made of extruded aluminium sections having thickness not less than 1.5 mm and matt finished colour anodized not less than 20 micron.

The glass 5 mm thick float Saint/Gobain glass white or colour as directed.

At bottom drain section shall be used to drain out rain water. The drain track shall be three track 92 mm x 31.55 weighing not less than 1.070 Kg/mt. The end and side tracks shall not be weighing less than 0.933 Kg/meter and thickness shall not be less than 1.5 mm. The work shall be carried out as directed by Engineer-in-charge or consultants.

Shutter Frame Work :- The fully glazed shutter frame shall be made from top and bottom section weighing not less than 0.464 Kg/meter. having bearing of Durlin or Nylon 66. All the fixture, fastener bearing, locks, handle, gaskets shall be used after getting approved from Engineer-in-charge and architect. The handle section shall be weighing not less than 0.417 Kg/meter. The interlock section shall be weighing not less than 0.464 Kg/mt. and having thickness of 1.5 mm. The glass panel shall be fixed in frame work using EPDM gaskets.

The whole assembly of window shall be fixed in best workman like manner to have smooth operations. All the windows shall be sealed to the R.C.C. or brick work with silicon sealants of dow corning or Wacker Germany as approved by Engineer-in-charge or his consultant.

The rate shall be for a unit of one square metre

Item No :-64

Providing and fixing standard extruded of aluminium section of size 63.50 x 38.10 x 1.95 mm,@Wt 1.094Kg / Rmt with colour anodized aluminium frame with 5 mm thick transparent bronze colour tinted float glass as details etc complete for openable shutter window.

General

The item shall consist of preparing and fixing of aluminum ventilators using square aluminum tubes of specified size having 5 mm thick frosted glass louvers as specified and fixing the same in structure at required places in accordance with the details shown on the drawings or as approved by the engineer in charge.

1.0 MATERIAL

1.1 Main outer frame of rectangular tube

Main frame shall be of standard coloured anodized Aluminum hollow sections as described in details in item of schedule B

Aluminum alloy used in the manufacture of extruded Window section shall confirm to I S designation HEA-WP of I S 733-1975 and also Designation WVG –WP of I S 1285-1975 section shall be as specified in the drawing and design

All sections shall be Free from any scratches or holes or any damages on surface. All section shall have finished luster surface on all sides

1.2 5mm thick transparent bronze colour tinted float glass :- The **5mm. thick transparent bronze colour tinted float glass** shall be of approved colour and quality The thickness of glass shall be as per item description The Glass shall conform to M-38.2 Page No. 18 of General technical specification book for building works

1.3. Rubber Gasket

Rubber gasket shall be of approved make and shall be free from any scratches or holes or any damages on surface. and shall have finished luster surface on all sides

2.0 WORKMANSHIP

The Ventilators shall be fabricated as shown in detail architectural drawing and as per instruction of engineer in charge, Only approved material shall be used in Ventilators colour of anodizing shall be approved and shall be anodized up to the satisfaction of engineer in charge. Completed Ventilators shall be fixed in position in true line and level.

3.0 Mode of Measurement & Payment :

4.1. The unit rate of aluminum Ventilator shall include the cost of all materials, cost of anodizing, cost of all necessary fixtures and fastenings, Glass sheet for louvers labour charges for fixing frames and ventilator and fixing the same in wall at the place shown in drawing and as instructed by Engineer in charge.

4.2. The Ventilator shall be measured in square meter

4.3. The rate shall be for a unit of one square meter.

Item No :-65

Providing and fixing standared extruded of alluminium section of size 63mm x 38.10mm x 1.2mm @ Wt. 0.643 Kg/mt with colour anodized alluminium frame for ventilation with 5 mm thick frosted glass as details etc complete for Ventilation

General

The item shall consist of preparing and fixing of aluminum ventilators using square aluminum tubes of specified size having 5 mm thick frosted glass louvers as specified and fixing the same in structure at required places in accordance with the details shown on the drawings or as approved by the engineer in charge.

1.0 MATERIAL

1.1 Main outer frame of rectangular tube

Main frame shall be of standard coloured anodized Aluminum hollow sections as described in details in item of schedule B

Aluminum alloy used in the manufacture of extruded Window section shall confirm to I S designation HEA-WP of I S 733-1975 and also Designation WVG –WP of I S 1285-1975 section shall be as specified in the drawing and design

All sections shall be Free from any scratches or holes or any damages on surface. All section shall have finished luster surface on all sides

1.2 5mm thick frosted glass :- The **5mm. thick frosted glass** shall be of approved colour and quality The thickness of glass shall be as per item description The Glass shall conform to M-38.2 Page No. 18 of General technical specification book for building works

1.3. Rubber Gasket

Rubber gasket shall be of approved make and shall be free from any scratches or holes or any damages on surface. and shall have finished luster surface on all sides

2.0 WORKMANSHIP

The Ventilators shall be fabricated as shown in detail architectural drawing and as per instruction of engineer in charge, Only approved material shall be used in Ventilators colour of anodizing shall be approved and shall be anodized up to the satisfaction of engineer in charge. Completed Ventilators shall be fixed in position in true line and level.

3.0 Mode of Measurement & Payment :

4.1. The unit rate of aluminum Ventilator shall include the cost of all materials, cost of anodizing, cost of all necessary fixtures and fastenings, Glass sheet for louvers labour charges for fixing frames and ventilator and fixing the same in wall at the place shown in drawing and as instructed by Engineer in charge.

4.2. The Ventilator shall be measured in square meter

4.3. The rate shall be for a unit of one square meter.

Item No :-66

Providing and fixing M.S. grills of required pattern to marble/granite frames of window etc. with M.s. flats at required spacing and frames around, square or round bars fixed with round headed bolts and nuts or by screws, including oil painting with one coat of primer of approved quality and brand & two coats of synthetic enamel oil paint etc. complete as per detail drawing and as directed by Engineer in charge.

1.0. Materials

The structural steel shall conform to M-22

2.0. Workmanship

2.1. The M.S. Grill shall be prepared as per the drawing or as directed for fixing to wooden frames of windows etc.

2.2. The grill shall be fabricated to the designs and patterns shown in the drawings and the weight shall be as directed, and the joints shall be reverted or welded as shown in the plan or as directed. The grill so formed shall be fixed into the frames of the windows etc. before they are erected in position. The outside strip frame of the grill shall be housed to its full thickness into the recess cut into the frame of the windows etc. The grill shall be fixed to the frame with number of bolts and nuts or screws viz. bolt nut/screw per 30 cm. of the length of outer strip subject to minimum of 2 Nos. on each side of the frame or as indicated in the drawing or as directed.

2.3. The bolts and nuts or screws shall be counter sunk and shall be fixed with the top of their heads flush with the face of the frame strips.

3.0. Mode of measurements & payment

3.1. No payment shall be made for weight of screws, bolts nuts etc. only weight of grill shall be paid.

3.2. The rate shall be for a unit of one kg.

ITEM NO.67:

Providing and fixing 0.90 meter wide and 0.80 meter high sand which type platform including supplying and fixing granite stone 18 mm thick mirror polished stones in top and side position and vertical strip at front over 25 mm thick polished kotah stone platform fixing in top and sides and intermediates supports fixing with cement mortar and adhesive and finishing etc complete.

In general the work shall be carried out as per the standard specifications of P.W.D. / C.P.W.D./ GWSSB relevant drawings and as per the instructions of Engineer in Charge. The work shall be carried out as per item description.

The Polished kotah stone sandwiched in cement mortar 1:4. Rest of the specification shall be followed for this specification. The work shall be carried out as per standard engineering practice.

Mode of Measurement:

The work shall be measured in sqm.

Item No :-68

Providing & laying 24"x24" Vitrified tiles 8 MM thick in flooring over 40 mm (Av.) base of C.M. 1:6 (1 Cement : 6 Coarse sand) on new surface or fixing on existing flooring by adhesive materials incldg. Dismanteling of existing flooring & joined with colour cement slurry including finished with flush pointing & cleaning the surface etc. completed Light Shade.

VITRIFIED TILE

The tiles shall be of approved make and shall generally conform to IS 15622. They shall be flat, and true to shape and free from blisters crazing, chips, welts, crawling or other imperfections detracting from their appearance. The tiles shall be tested as per IS 13630. Classification and Characteristics of VITRIFIED TILE shall be as per IS 13712.

The tiles shall be square or rectangular of nominal size. Table 1,3,5, and 7 of IS 15622 give the modular preferred sizes and table 2,4,6 and 8 give the most common non modular sizes. Thickness shall be specified by the manufacturer. It includes the profiles on the visible face and on the rear side.

Manufacturer/supplier and party shall choose the work size of tiles in order to allow a nominal joint width upto 2mm for unrectified floor tiles and upto 1mm for rectified floor tiles. The joint in case of spacer lug tile shall be as per spacer. The tiles shall conform to table10 of IS 15622 with water absorption 3 to 6% (Group BII).

The top surface of the tiles shall be double charged. Glaze shall be either glossy or matt as specified. The underside of the tiles shall not have glaze on more than 5% of the area in order that the tile may adhere properly to the base. The edges of the tiles shall be preferably free from glaze. However, any glaze if unavoidable, shall be permissible on only upto 50 per cent of the surface area of the edges.

2 Coloured Tiles

Only the glaze shall be coloured as specified. The sizes and specifications shall be the same as for the

3 Decorative Tiles

The type and size of the decorative tiles shall be as follows :

(i) Decorated white back ground tiles

The size of these tiles shall be as per IS 15622.

(ii) Decorated and having coloured back-ground

The sizes of the tiles shall be as per IS 15622.

4 Preparation of Surface and Laying

4.1 Base concrete or the RCC slab on which the tiles are to be laid shall be cleaned, wetted and mopped. The bedding for the tile shall be with cement mortar 1:4 (1 cement : 4 coarse sand) or as specified. The average thickness of the bedding shall be 20 mm or as specified while the thickness under any portion of the tiles shall not be less than 10 mm.

4.2 Mortar shall be spread, tamped and corrected to proper levels and allowed to harden sufficiently to offer a fairly rigid cushion for the tiles to be set and to enable the mason to place wooden plank across and squat on it.

4.3 Over this mortar bedding neat grey cement slurry of honey like consistency shall be spread at the rate of 3.3 kg of cement per square metre over an area upto one square metre. Tiles shall be soaked in water washed clean and shall be fixed in this grout one after another, each tile gently being tapped with a wooden mallet till it is properly bedded and in level with the adjoining tiles. The joints shall be kept as thin as possible and in straight lines or to suit the required pattern.

4.4 The surface of the flooring during laying shall be frequently checked with a straight edge about 2 m long, so as to obtain a true surface with the required slope. In bath, toilet W.C. kitchen and balcony/verandah flooring, suitable tile drop or as shown in drawing will be given in addition to required slope to avoid spread of water. Further tile drop will also be provided near floor trap.

4.5 Where full size tiles cannot be fixed these shall be cut (sawn) to the required size, and their edge rubbed smooth to ensure straight and true joints. Tiles which are fixed in the floor adjoining the wall shall enter not less than 10 mm under the plaster, skirting or dado.

4.6 After tiles have been laid surplus cement slurry shall be cleaned off.

5 Pointing and Finishing

The joints shall be cleaned off the grey cement slurry with wire/coir brush or trowel to a depth of 2 mm to 3 mm and all dust and loose mortar removed. Joints shall then be flush pointed with white cement added with pigment if required to match the colour of tiles. Where spacer lug tiles are provided, the half the depth of joint shall be filled with polysulphide or as specified on top with under filling with cement grout without the lugs remaining exposed. The floor shall then be kept wet for 7 days. After curing, the surface shall be washed and finished clean. The finished floor shall not sound hollow when tapped with a wooden mallet.

5 Double charge layer

In all double charge tiles the top layer will be coated two times that is top 2 layer of color coated.

6 Measurements

Length and breadth shall be measured correct to a cm after laying flooring and the area calculated in square metre correct to two places of decimal. Where coves are used at the junctions, the length and breadth shall be measured between the lower edges of the coves. No deduction shall be made nor extra paid for voids not exceeding 0.20 square metre. Deductions for ends of dissimilar materials or other articles embedded shall not be made for areas not exceeding 0.10 square metre. Areas, where glazed tiles or different types of decorative tiles are used will be measured separately.

7 Rate

The rate for flooring shall include the cost of all materials and labour involved in all the operations described above, For tiles of sizes upto 0.16 sqm. unless otherwise specified in the description of the item. Nothing extra shall be paid for the use of cut (sawn) tiles in the work.

The rate shall be for a unit of one sq. meter

Item No :-69

Providing and laying Vitrified tiles 8 to 10 mm thick , 24" x 24" in skirting risers of steps and dedo on 10mm thick cement plaster 1:3 (1-cement : 3-coarse sand) and jointed with white cement slurry

Item No :-70

Providing and laying Vitrified tiles 8 to 10 mm thick , 24" x 24" in skirting risers of steps and dado on 10mm thick cement plaster 1:3 (1-cement : 3-coarse sand) including Applying spacer of 5mm and not less than 3mm depth and filling groove with epoxy filler material of laticrete , Roff or equivalent. & cleaning the surface etc. complete

Detail Material specification same as Item no.68 above.

Measurements

Length and breadth shall be measured correct to a cm after laying skirting, dado or wall plaster and the area calculated in square metre correct to two places of decimal. Where coves are used at the junctions, the length and breadth shall be measured between the lower edges of the coves. No deduction shall be made nor extra paid for voids not exceeding 0.20 square metre. Deductions for ends of dissimilar materials or other articles embedded shall not be made for areas not exceeding 0.10 square metre. Areas, where glazed tiles or different types of decorative tiles are used will be measured separately.

Rate

The rate for skirting, dado shall include the cost of all materials and labour involved in all the operations described above, For tiles of sizes upto 0.16 sqm. unless otherwise specified in the description of the item. Nothing extra shall be paid for the use of cut (sawn) tiles in the work.

The rate shall be for a unit of one sq. meter

Item No :-73

Providing and laying Lather finished granite stone slab 18mm thick in flooring treads of steps and landing laid on a bed of 12mm thick cement mortar 1:6 (1-Cement : 6-Coarse Sand) finishing with full molded round edges, flush pointing in white or colour cement.

1.0. Materials

Water shall conform to M-1. Lime mortar shall conform to M-10. Cement mortar shall conform to M-11 Granite river stone shall conform to M-52.

2.0. Workmanship

- 2.1.** Each slab shall be cut to the required size and shape and fine chisel dressed at all the edges. The sides trust dressed shall have a full contract if a straight edge is laid along. The sides shall be table rubbed with coarse sand before paving. All angles and edges of the slabs shall be true square and free from chippings and giving a plane surface. The thickness shall be 25 mm. (Average) as specified in the item but not less than 20 mm. at any place of the slab.
- 2.2.** Bedding for the Granite stone slabs shall be of cement mortar 1:6 (1 cement : 6 coarse sand) or L.M. 1:1.5 of average thickness 20 mm given in the description of the item. Sub grade shall be cleaned, wetted and mopped Mortar of the specified mix and thickness shall then be spread on an area sufficient to receive one kota stone slab. The slab shall be washed clean before laying. It shall be laid on top, pressed, tapped gently to bring it in level with the other slabs. If shall then be lifted and laid aside. Top surface of the mortar shall then be corrected by adding fresh mortar at hollows or depressions. The mortar shall then be allowed to harden bit. Over this surface, cement

slurry of honey-like consistency shall be applied. The slab shall then be gently placed in position and tapped with wooden mallet till it is properly padded in level with and close to the adjoining slab. The joint shall be as fine as possible. The slabs fixed in the floor adjoining, the walls shall enter not less than 10 mm. under the plaster, skirting or dedo. The junction between the wan and floor shall be finished neatly. The finished surface shall be true to levels and slopes as directed.

2.3. The floor shall be kept wet for a minimum period of 7 days so that bedding and joints set properly.

2.4. Polishing shall be normally commenced after 14 days of laying the stone slab. First polishing shall be done with carborundum stones of 120 grade grit fitted in the heavy machine and then second polishing shall be done with carborundum stone of 220 to 350 grade grit fitted in heavy machine. Water shall be properly used during polishing. The stone shall then be washed clean with water when directed by the Engineer-in-charge, wax polish of approved quality shall be applied on the surface with the help of soft cloth over a clean and dry surface. Then the polishing machine fitted with bobs shall be run over it.

2.5. The holes required for Nahni traps, pipes and any other fittings shall be made, without any extra cost.

3.0. Measurement & payment:

3.1. The rate shall include the cost of all materials and labor involved in all the operations described above. The Granite stone flooring shall be measured in square meters correct to two places decimal, length and breadth shall be measured correct to a centimetre and between the finished face of skirting dedo plaster and no deduction shall be made nor extra paid for any opening in floor of areas up to 0.1 sq. m.

3.2. The rate shall be for a unit of one sq. meter.

Item No :-74

Providing and laying polished Granite Slab 18mm thick in Risers of steps Dedo, window sill, jems and pillars laid 10mm thick Cement Mortar 1:3 (1-Cement : 3 coarse sand and jointed with Grey Cement Slurry including full molded round front edges , rubbing and polishing etc. complete.

Detail specification of materials same as Item no.71 above.

Measurements

Length and breadth shall be measured correct to a cm after laying skirting, dado or wall plaster and the area calculated in square metre correct to two places of decimal. Where coves are used at the junctions, the length and breadth shall be measured between the lower edges of the coves. No deduction shall be made nor extra paid for voids not exceeding 0.20 square metre. Deductions for ends of dissimilar materials or other articles embedded shall not be made for areas not exceeding 0.10 square metre. Areas, where glazed tiles or different types of decorative tiles are used will be measured separately

Rate

The rate for skirting, dado shall include the cost of all materials and labour involved in all the operations described above, For tiles of sizes upto 0.16 sqm. unless otherwise specified in the description of the item. Nothing extra shall be paid for the use of cut (sawn) tiles in the work.

The rate shall be for a unit of one sq. meter.

Item No :-88

Prov.20mm deep finished groove etc. comp.

In general the work shall be carried out as per the standard practice in the industry.
20mm deep finished groove shall be made as per Relevant drawings and as per the instructions of Engineer in Charge.

The work shall be carried including necessary scaffolding ,tools and labour required.

The rate shall be for a unit of one Running Meter

Item No :-89

Providing and fixing chicken wire mesh jali at R.C.C. masonry joints at any height with all labour & material etc. complete.

Material , Workmanship and Fixtures & Fastening etc. :

The chicken wire mesh shall be provided to prevent cracks appearing between junctions of column /beams and walls, 150 mm wide chicken wire mesh fixed with U nails, 150 mm centre to centre before plastering the junction. The plastering of walls and beam/column in one vertical plane should be carried out in one go.

Mode of measurement & payment :

The rates includes all materials, labor, tools and plants in satisfactory completion of work as specified above.

The rates shall be for unit of one Sq.mt. for actual work done.

Item No :-90

Applying two coats of birla(White cement based) or Asian (acrylic lappy putty) or equivalent two coats of primer of approved brand and manufacture on new wall surface to give an even shade including thoroughly brushing the surface free from mortar dropping and other matter foreign and sand papered smooth.

General :

Scope of work includes cleaning off the entire surface , remove all loose particles, dust, scale, smoke, grease from the surface, sand the surface with Emery paper 180 and wipe clean, applying 2 coats of white birla putty.

Material:

manufacturer's standard guide line Putty Make.

Workmanship:

The Putty shall be of approved brand. Plaster filler to be used for filling up uneven surfaces , small cracks and holes etc and it should be done as per the manufacturer's standard guide line. The whole process of paint required 2 times sand with 180 emery paper wipe off and 1 time sand with 320 emery paper wipe off.

Mode of measurement:

All the measurement shall be taken on net surface area actually painted, deduction will be made from the area for fixtures, grills, ventilation, elect boxes and such obstructions not painted , if they are individually more than 0.05 sq.m.

Rate :

Rate is to include for All materials of putty's, sand paper, etc with labour required for scaffolding, cleaning off the surfaces, cleaning the site after completion of job, etc as directed by engineer in charge. Rate is for the net surface area of Painted surfaces in Square metre.

Item No :-91

Wall painting (two coats) with plastic emulsion paint of approved brand and manufacture on undecorated wall surface to give an even shade including thoroughly brushing the surface free from mortar droppings and other foreign matter and sand papered smooth.

1.0. Materials

Water shall be conform M-1. The plastic emulsion shall conform to I.S.: 5411-1969 (part-1).

2.0. Workmanship

2.1. Scaffolding : The relevant specifications of item-No. 18.11 Para 2.1 shall be followed.

2.2. Preparation of surface : The relevant specification of item No. 18.44 Para 2.2 shall be followed.

2.3. Preparation of Mix :

This shall be done as per manufacturer's instructions. The thinning of emulsion is to be done with water and not with turpentine. The quantity of thinner to be added shall be as per manufacturer instructions.

2.4. Application :

2.4.1. Before pouring into small containers for use, the paint shall be stirred thoroughly in item container. When applying also, the paint shall be continuously stirred in the smaller container, so that its consistency is kept uniform.

2.4.2. The paint shall be laid on evenly and smoothly by means of crossing and laying off the crossing and consist of covering the area over with paint, brushing the surface hard for the first time over and then, brushing alternately in opposite direction two or three times and then finally brushing lightly in direction at right angles to the same. In this process, no brush Marks shall be left after the laying off is finished. No hair marks from the brush or clogging of paint puddles in the corners of panels, angles of mouldings, etc. shall be left on the work. The full process of crossing and laying off will constitute one coat.

2.4.3. The paint shall be applied with brush or rollers. For undecorated surfaces, the surface shall be treated with minimum two coats of cement water proofing paint. The second or subsequent coat shall not be started until the proceeding coat as become sufficiently hard to resist marking by brushing being used.

2.4.4. The surface on finishing shall present a flat velvety smooth finish. It shall be even and uniform in shade without patches, brush marks, paint drops etc.

2.5. Precautions :

(a) Old brushes if they are to be used with emulsion paints, shall be completely dried of turpentine or oil paint by washing in warm soap water. Brushes shall be quickly washed in water immediately after use and kept immersed in water fusing break periods to prevent the paint from hardening on the brush.

(b) In the preparation of wall for plastic emulsion painting, no oil base petals shall be sued in filling cracks, holes etc.

(c) Splashes on floors etc. shall be cleaned out without delay as they will be difficult to remove after hardening.

(d) Washing or surfaces treated with emulsion paint shall not be done within 3 to 4 weeks of application

3.0. Mode of measurements and payment

3.1. The rate shall be for a unit of One sq. meter.

Item No :-92,93

Wall painting (two coats) with plastic emulsion paint of approved brand and manufacture on ceiling and slopping roofs to give an even shade including thoroughly brushing the surface free from mortar droppings and other foreign matter and sand papered smooth. For All Floors.

Same as **item no.-91** above

Material :

The paint shall be (Textured exterior paint/Acrylic smooth exterior paint/ premium acrylic smooth exterior paint) of approved brand and manufacture. This paint shall be brought to the site of work by the contractor in its original containers in sealed condition. The material shall be brought in at a time in adequate quantities to suffice for the whole work or at least a fortnight's work. The materials shall be kept in the joint custody of the contractor and the

Engineer-in-Charge. The empty containers shall not be removed from the site of work till the relevant item of work has been completed and permission obtained from the Engineer-in-Charge.

Preparation of Surface :

For new work, the surface shall be thoroughly cleaned off all mortar dropping, dirt dust, algae, fungus or moth, grease and other foreign matter of brushing and washing, pitting in plaster shall make good, surface imperfections such as cracks, holes etc., should be repaired using white cement. The prepared surface shall have received the approval of the Engineer-in-Charge after inspection before painting is commenced.

Application :

Base coat of water proofing cement paint.

The solution shall be applied on the clean and wetted surface with brushes or spraying machine. The solution shall be kept well stirred during the period of application. It shall be applied on the surface which is on the shady side of the building so that the direct heat of the sun on the surface is avoided. The method of application of cement paint shall be as per manufacturer's specification. The completed surface shall be watered after the day's work.

The second coat shall be applied after the first coat has been set for at least 24 hours. Before application of the second or subsequent coats, the surface of the previous coat shall not be wetted.

For new work, the surface shall be treated with three or more coats of water proof cement paint as found necessary to get a uniform shade.

For old work, the treatment shall be with one or more coats as found necessary to get a uniform shade.

Before pouring into smaller containers for use, the paint shall be stirred thoroughly in its containers, when applying also the paint shall be continuously stirred in the smaller containers so that its consistency is kept uniform. Dilution ration of paint with potable water can be altered taking into consideration the nature of surface climate and as per recommended dilution given by manufacturer. In all cases, the manufacturer's instructions and directions of the Engineer-in-Charge shall be followed meticulously.

The lids of paint drums shall be kept tightly closed when not in use as by exposure to atmosphere the paint may thicken and also be kept safe from dust.

Paint shall be applied with a brush on the cleaned and smooth surface. Horizontal strokes shall be given, First and vertical strokes shall be applied immediately afterwards. This entire operation will constitute one coat. The surface shall be finished as uniformly as possible leaving no brush marks.

The specifications in respect of scaffolding, protective measures, measurements and rate shall include all material and labour involved in all the operations described above.

The rate shall be for a unit of one sq. meter.

Item No :-95

Providing & applying single coat of textured finish at external surface at all floor levels with three coats of weather proof cement exterior paint of approved standard brands make t at outer side of the building on RCC or Masonary walls. Including all labour, materials, staging, scaffolding, cleaing, curing etc. application of texture after thoroughly brushing the surface to give an even shade free from mortar dropping/other foreign matter etc. complete. application of texture finish & paints must be as per company's standard instructions. Texture and colour selection as per approved by engineer in charge.

Specification as per item description, manufacturer's details instruction and as directed by Engineer- in-charge.

The rate shall be for a unit of one Sq.metre.

Item No :-97

Providing and laying China Mosaic type water proofing treatment on terrace including (a) Applying neat cement slurry 2.75 Kg./Smt. of cement admix with water proofing compound after cleaning the surface (b) 50 mm thk. Cement Concrete flooring 1:2:4 (1-Cement : 2-Coarse sand : 4-graded stone aggregate 20 mm nominal size) laid in admixed with water proofing compound including rounding of junctions of walls and slabs (c) after two days of proper curing applying a second coat of cement slurry (d) finishing the surface with 20mm thick cement mortar 1:4 (1 cement : 4 coarse sand) and china mosaic tilling & finally finishing the surface with trowel with white cement slurry (e) after finishing the whole terrace shall be flooded with water for a period of two weeks.

Item No :-98

Supply & Fixing of Broken Glazed (China Mosaic) tiles size 5-6 mm thick of different size and shade (approved crazy patern) in Cement:Mortar 1:2 and joint filling with White Cement /

Coloured Cement with water proofing component including Ramping, Watering, Curing etc. complete (FOR ALL FLOOR)

Immediately on applying the cement slurry over the surface of the brick bat coba and when the slurry applied is still green, Provide in position 6 mm. thick broken Glazed tiles in size 12 mm to 20 mm, of odd sizes and shapes laid in approved crazy pattern (with one or more color in pattern, as directed) for floor/ dado having plain or curved surfaces, in cement mortar 1:3 proportion with cement, floating, joints finished with white or approved colour cement including tamping, watering, curing, cleaning with oxalic acid, etc. complete as per the Engineer's instructions.

Curing and Testing the Treatment

The entire surface thus treated shall be flooded with water by making ponding arrangement with weak cement mortar, for a minimum period of two weeks.

MODE OF MEASUREMENT AND PAYMENT :

The measurement shall be taken along the finished surface of treatment including the rounded and tapered portion at junction of parapet wall. Length and breadth shall be measured correct to a cm and area shall be worked out to nearest 0.01 sqm. No deduction in measurement shall be made for openings or recesses or chimney stacks, roof lights or khurras of area upto 0.40 sqm., nor anything extra shall be paid for making such openings, recesses etc. For areas exceeding 0.40 sqm., deduction will be made in the measurements for the full openings and nothing extra shall be paid for making such openings.

The rate shall include the cost of all labour and materials involved in all the operations described above.

The rate shall be for a unit of one sq. mt.

Item No :-99

Steel work welded in built up sections framed work including cutting, hoisting, fixing in position and applying a priming coat of red lead paint. [A.] In beams and joists, channels angles tees, flats with connecting plates or angle cleats as in main and cross beams, Hip and jack rafters, purlins connected to common rafters and the like.

LAYING OUT :

The steel structures, as shown in the drawings or as per directions of the Engineer-in-charge, shall be laid out on a level platform to full scale and to full size in parts. A steel type shall be used for measurements to ensure maximum accuracy.

Wooden templates 12 mm to 19 mm thick or steel templates shall be made to correspond to each connecting gusset plate and rivet holes shall be accurately marked on them and drilled. The templates shall be laid on the steel members and holes for revetting and bolting marked on them.

The ends of the steel members shall also be marked for cutting. The base of steel columns and the position of anchor bolts shall be carefully set out.

FABRICATION :

The steel sections as specified shall be straightened and cut square and accurately to correct lengths. The cut ends exposed to view shall be finished smooth. No. two pieces shall be welded or otherwise jointed to make up required length of a member except as indicated in the drawing or otherwise specifically permitted by the Engineer - in - charge. All straightening and shping to form shall be done by application of pressure and not by manning. Any bending or cutting shall be carried out in cold condition (unless otherwise directed) in such a manner as not to impair the strength of the metal.

All stiffeners shall be formed by pressure, and where practicable, the metal shall not be cut and welded in making these. In major works or where so specified, shop drawings giving complete details and information for the fabrication of the component parts of the structure, including the locating, type, size, length and details of rivets, bolts or welds shall be prepared in advanced of the actual fabrication and approved by the Engineer-in-charge. The drawing shall indicate the shop and filed rivets, bolts and welds. The steel members shall be distinctly marked or stencilled with paint with the identifica- tion marks as given in the shop drawings.

The bars shall be thickned at the ends so as to provide for screwed threads and gradually tapered off to meet their normal section.

Great accuracy shall be observed in the fabrication of various members. Do that these can be assembled without being unduly packed strained or forced into position and when built-up shall be true and free from twists, bricks buckles or open joints.

Before making holes in individual mambers, for fabrication the steel work intended to be rivetes or bolted to gather shall be assembled or clamped properly and tightly so as to ensure chose abutting or lapping of the surface of the different members. All stiffeners shall be tightly both at top and bottom without being drawn or caulled. The abutting joints shall be cut of dressed true and straight and fitted close together,

We splice plates and fillers under stiffeners shall be cut to fit within 3 mm of flange angles. We plated or girders which have no cover plates shall have their ends flush with the top of angles forming the flangesunless otherwise required. The we plates,when spliced shall have clearance of not more than 6 mm.

The erection clearance for cleated ends of members connecting steel to steel preferably be not grater than 1.5 mm. The erection clearance at the ends of beams without web cleats shall not be more than 3 mm. at each end but where for prectical reasons, greathercleance is necessary, suitably designed seating shall be provided.

Pins and rollers shall be accurately turned to gauge. These shall be straight and smooth and free from flaws. The roller bearing shall be provided with adequate arrangement for holding the girders or truss resting on it, from lateral displacement.

Expension bed plates shall be planed true and smooth. The planning of bed plates shall be done in the direction of the movement of the girder or truss resting on it.

Column splices and but joints of struts and impression members depending on contract for trees transmission shall be accurately machined and closebutted over the whole section. In column caps and bases, the ends of shafts together with the attached gussets, angles, channales etc. after riveting together shall be accurately machinised so that the parts connected but against each other over the entire surface of contract. Connecting angles or channels shall be fabricated and placed in position with great accuracy so that they are not unduly reduced in thickness by machining.

The ends of all bearing stiffeners shall be machined or ground to fit tightly both at the top and bottom.

All holes shall generally be drilled to the required size and at the required position. Sub-punching shall be permitted, provided it is done 3 mm. less in diameter and reamed thereafter to the required size.

Holes for rivets and black bolts shall be large by 0.4 to 6 mm. as shown in appendix-I under column "Coarse" than the nominal diameter of the rivets or black bolts depending upon the dia of rivets. Holes for turned and fitted bolts shall be drilled or reamed large by 0.2 to 3 mm. depending upon the dia of bolts as shown in Appendix under column "Medium".

When the number of plates or sections to be riveted together exceeds three or when their total thickness is 90 mm or more, holes shall be drilled or reamed in position, after the members are assembled and the parts firmly hold together by clamps. Before riveting or bolting up or welding finally. The members shall be taken part and all burns removed.

Holes shall have their axis perpendicular to the surface bore through. The drilling or reaming shall be free from burrs and the holes shall be clean and accurate.

The work or fabrication shall be completed in the work shop as far as it is practicable to do so. Site jointing shall be done with rivets or turned and fitted bolts, or black bolts or welding as shown in drawings or as directed by the Engineer-in-charge. Generally, the following principles shall govern the use of rivets, turned and fitted bolts and black bolts :-

[i] Rivets or turned and fitted bolts shall be used where the connection is such that slip under load has or be avoided.

[ii] Black bolts may be used very sparingly where a force is carried through a connecting without impact, vibration or reversal of stresses (unless such reversal is due to wind forces.)

In the case of welding, holes shall only be made for the bolts used for temporary fastening as shown in drawings.

WELDING :

Welding shall be generally be done by electric process. The electric arc method being economical, is usually adopted. Where public electricity is not available, a suitable generator shall be arranged. Gas welding shall be resorted to using oxyacetylene flame with specific period approval of the Engineer-in-charge.

Gas welding shall not be permitted for structural steel work. Gas welding requires heating of the members to be welded along with the welding rod and is likely to create temperature stresses in the welded members. Precautions shall therefore be taken to avoid distortion of the members due to these temperature stresses.

The work shall be done as shown in the shop drawings which should clearly indicate various details of the joints to be welded, type of welds, shop and site welds, as well as the types of electrodes to be used. Symbols for welding on plans and shop drawings shall be according to IS : 813-1061. As far as possible, every effort shall be made to limit the welding that must be done after the structure is erected so as to avoid the improper welding that is likely to be done due to heights and difficult positions of scaffolding etc. a part from the aspect of economy.

PREPARATION OF SURFACE :

Surfaces which are to be welded together, shall be free from loose mild-scale, rust, paint, grease or other foreign matter. A Coating of boiled linseed oil shall be permitted.

PRECAUTIONS :

All operations connected with welding and cutting equipment shall conform to the safety requirement given in IS : 818-1968 for "Safety and Health requirements in Electric and Gas welding and Cutting Operations".

The following points shall be borne in mind during the process of welding :-

[a] Welds shall be made in the flat position. Wherever practicable.

[b] Are length, voltage and amperage shall be suited to the thickness of materials, type of groove and other circumstance of the work.

[c] The sequence of welding shall be such that where possible, the members which after the greatest resistance to compression are welded first.

All defective welds which shall be considered, harmful to the structural strength shall be cut out and rewelded.

Finished welds and adjacent parts shall be protected with clean boiled linseed oil and after all slag has been removed. Welds and adjacent parts shall be painted after the same are approved by the Engineer-in-charge.

All the members shall be thoroughly cleaned of rust, scales dust etc. and given a priming coat of lead painting before fixing then in position.

RATE :

The rate shall be for a unit of one quintal.

Item No:-100

Steel work, welded in built up sections framed work including cutting, hoisting, fixing in position and applying two coat priming of red lead paint and two coats of synthetic enamel paint . (A)In beams and joists, channels angles Tees, flats, with connecting plates or angle cleats as in main and cross beams. Hip and jack rafters, purlins conneted to common rafters and the like for Main entry gate & compound wall grill.

The relevant specification of Item no.-99 above shall be followed.

The rate shall be for a unit of one Kg.

Item No :-101

Providing and Fixing 90 cm high stainless steel railing made from anticorrosive 304 grade S.S. Staircase Railing modular type welded fitting (S-Rail SR11 Square Type Steel Baluster),Main hand Rail pipe (DASA Pipe) 50mm outer dia 1.6 mm Thickness SS 304 Grade, Balustar steel square type 32X32mm outer dia. 1.6mm thickness ss 304 pipe, 3 pipe below main dasa pipe 16 mm outer dia. 1.6mm thickness ss304 grade as a vertical support fixed in RCC S.S. pipe with steel modular type fitting baluster including all type accessories as per detailed drawing as directed etc. complete for all floors.

The relevant specification shall be followed as per General Technical specification for Building work booklet It.No.10.100 (A) except the materials used is of ASIS 304 grade. And as per item descriptions.

The consolidated item shall be measured and paid on Rmt.

Item No.102

The providing & fixing of Fix louvered work. The main frames both verticals and horizontals have to be Aluminium pipes of 100 mm x 50 x 3.0 mm with colour anodized 20 micron (silver) thick, including All hardware, labour,scaffolding,fixtures,fastners transport and all other taxes included etc. complete as per architect's details at all floor levels.

The item shall consist of preparing and fixing of aluminum ventilators using square aluminum tubes of specified size having 5 mm thick frosted glass louvers as specified and

fixing the same in structure at required places in accordance with the details shown on the drawings or as approved by the engineer in charge.

1.0 MATERIAL

1.1 Main outer frame of rectangular tube

Main frame shall be of standard coloured anodized Aluminum hollow sections as described in details in item of schedule B

Aluminum alloy used in the manufacture of extruded Window section shall conform to I S designation HEA-WP of I S 733-1975 and also Designation WVG –WP of I S 1285-1975 section shall be as specified in the drawing and design

All sections shall be Free from any scratches or holes or any damages on surface. All section shall have finished luster surface on all sides

1.2 5mm thick frosted glass :- The 5mm. thick frosted glass shall be of approved colour and quality The thickness of glass shall be as per item description The Glass shall conform to M-38.2 Page No. 18 of General technical specification book for building works

1.3. Rubber Gasket

Rubber gasket shall be of approved make and shall be free from any scratches or holes or any damages on surface. and shall have finished luster surface on all sides.

2.0 WORKMANSHIP

The Ventilators shall be fabricated as shown in detail architectural drawing and as per instruction of engineer in charge, Only approved material shall be used in Ventilators colour of anodizing shall be approved and shall be anodized up to the satisfaction of engineer in charge. Completed Ventilators shall be fixed in position in true line and level.

3.0 Mode of Measurement & Payment :

4.1. The unit rate of aluminum Ventilator shall include the cost of all materials, cost of anodizing, cost of all necessary fixtures and fastenings, Glass sheet for louvers labour charges for fixing frames and ventilator and fixing the same in wall at the place shown in drawing and as instructed by Engineer in charge.

4.2. The Ventilator shall be measured in square meter

4.3. The rate shall be for a unit of one square meter.

Item No :-103

Providing and fixing Semi unitized vision panel with glazed units (SGU)of size as per design and consisting of 6 mm thick (toughened)glass approved by the architect. with mullion (101mmx57mmx1.8mm, 8.9 kg/12 rft), transum (63mmx57mmx1.8mm, 5.8 kg/12 rft), sub frame (54mmx22mmx1.25mm, 2.4kg/12 rft), with anodizing,withm.s. hot deep galvanized

bracket,with,s. hardware The glazed panel to be formed by means of imported special structural quality silicon adhesive sealant layer manufactured by M/s. Dow Corning 995 USA with material:- silicone dowcorring 789weather silicone in 995 dowcorring.It includes cost of labour, materials, accessories, adhesives,all required M.S FABRICATIONS, scaffolding, wastages, transport, taxes, fixing into a neat finish in aesthetic point of view, without any undulations in facias all complete as per drawing and Instruction of engineer in-charge.

Above item shall be executed as per detail item description and shall be get approved by engineer in charge prior to procurement of **item description**The system shall be installed as per the **manufacture installation manual**.

The rate shall be for a unit of Sq.Mt.

Item No :-104

(Top hungOpenable part) Providing and fixing openable hardware for glazing as per detail , It includes cost of labour, materials, accessories,all required M.S FABRICATIONS,adhesives, scaffolding, wastages, transport, taxes, fixing into a neat finish in aesthetic point of view, without any undulations in facias all complete as per drawing and Instruction of engineer in-charge.

Above item shall be executed as per detail item description and shall be get approved by engineer in charge prior to procurement of **item description**The system shall be installed as per the **manufacture installation manual**.

The rate shall be for a unit of Nos.

Item No :-106

Providing and laying and fixing 50mm thick expansion joint by hydro cell semi rigid UV resistance with high performance laminated closed cell polythene foam joint filler in sheet foam as directed, etc. complete.

Above item shall be executed as per detail item description and shall be get approved by engineer in charge prior to procurement of **item description**The system shall be installed as per the **manufacture installation manual**.

The rate shall be for a unit of Nos.

Item No :-117

Providing and fixing to wall ceiling and floor 10.0 Kg. F/Cm2 working pressure polythene pipes of the following outside Dia. Low density, complete with special falnge compression type fittings, wall clipsetc. including making good the wall ceiling and floor.(F) 75mm

Specification for this item shall conform to item no. **Ch.23-Item 23.8, page.156** General Technical Specifications for building work. Except that the pipe shall be of **10 Kg/Sqcm instead of 6 kg/Sqcm**.

Rate shall be for a unit of one Running Meter.

Item No :-118

Providing and fixing to wall ceiling and floor 10.0 Kg. F/Cm² working pressure poluthene pipes of the following outside Dia. Low density, complete with special falnge compression type fittings, wall clipsetc. including making good the wall ceiling and floor.(G)110 mm.

Specification for this item shall conform to item no. **Ch.23-Item 23.8, page.156** General Technical Specifications for building work. Except that the pipe shall be of **10 Kg/Sqcm instead of 6 kg/Sqcm.**

Rate shall be for a unit of one Running Meter.

Item No:-121,122,123

Providing laying and jointing in true line and level 15mm dia. U.P.V.C. Pipe (SCH- 40) for cold water including fittings as approved by Engineer In Charge. Pipe shall be fixed on the wall with the help of clamp at every two metre C/C or shall be cancelled as directed including necessary fittings etc. including testing of pipe and joints and fixing the same with adhesive solvent, including cost of all materials.(A) 15mm. dia.,(c) 25mm. dia.,(e) 40mm. dia.

1.0 Materials:

1.1 The pipe (schedule 40) of specified diameter with working pressure shall conform to ASTM –D 1785 (non-threaded). The specials and fittings required shall be of best quality and UV stabilized so as to facilitate open fixation, conforming to ASTM–D-2466 and relevant specifications of plumbing materials.

2.0 Workmanship:

2.1 The uPVC pipes of specified diameter shall be fixed as directed. Due to thermal expansion of uPVC pipes, due allowances, about 10 mm. of thermal gap, shall be made particularly in over the ground pipe lines for any change in length of pipe line which may occur during installation or when pipe line is in serve.

2.2 Above the ground installation of uPVC pipe should be undertaken after precautions are observed for their protection against dirt, sunrays and mechanical damage. uPVC pipes are UV stabilized and shall be adopted.

2.3 The uPVC pipelines should not be kept exposed above the ground when it passes through public place, railway lines, roads, roadside and footpaths.

2.4 Generally, in horizontal runs, uPVC pipes shall be supported at an interval of not more than ten times the outside diameter of the pipe. In vertical lines, uPVC pipes shall be supported at an interval of 1 m. to a maximum of 2 m. Closer support spacing shall be provided, if recommended by the manufacture.

2.5 The guide line indicated by the manufacture regarding handling, transporting, storing, laying and jointing of pipes shall be kept in view, during execution. Provision for expansion joints, air vents and proper anchorage shall be made.

2.6 uPVC pipes shall be fixed on wall with wooden plugs and suitable clamps.

2.7 Jointing the pipes:

2.7.1 The pipes and sockets shall be accurately cut. Care shall be taken to cut the pipe square. The shortened pipe end shall be chamfered to an angle of 15 with a medium file. The ends of the pipes and fittings should be absolutely free from dirt and dust. The outside surface of the pipes and the inside of the fittings shall then be roughened with emery paper, and then solvent cement shall be applied to the matching surface i.e. to the spigot end and the sealing ring and then pass the spigot end in to the socket containing the sealing ring until pushed home fully and joined. Mark the position of the socket edge on the pipe and then withdraw the pipe from the socket for the necessary thermal gap. Since solvent cement is aggressive to uPVC, care must be taken to avoid applying excessive cement to the inside of pipe sockets as any surplus cement cannot be wiped off after jointing. Very old, hard, semi fluid solvent cement shall not be used. Empty solvent cement tins, brushes, rags of paper unpregnated with cement should not be buried in the trenches. They should be gathered, not left scattered about, as they can prove to be a hazard to animals, which may chew them.

2.7.2 Threaded uPVC pipe fittings shall not be over tightened, as the threads may get damaged. The pipes shall never be threaded but suitable threaded fittings shall be used.

2.7.3 If any manufacturer recommends its own methods of jointing the same shall be adopted after necessary approval from the Engineer-in-charge or Architect.

2.8 Laying the pipes in trenches:

2.8.1 The pipes shall be laid over uniform relatively soft fine-grained soil, found to be free from presence of hard objects such as large flints, rocky projections, large tree roots etc. While laying the pipes underground, care shall be taken so that the trench shall be as narrow as possible as required for working and its bottom shall be free of stones, sharp objects etc.

2.8.2 The pipes laid underground shall not be less than 1 meter from the ground level. The pipe shall be positioned in the trenches so as to avoid any induced stresses due to deflection. Any deviation required shall be obtained by using proper type of rubber ring joints.

3.0 Mode of Measurements and payment:

3.1 The relevant specifications of item No. 1.01.a of water supply installations shall be followed except that the uPVC pipes of specified dia. shall be paid under this item.

3.2 The rate shall be for a unit of one rmt.

Item No :-131

Providing and fixing in position P.V.C. cowl vent to pipes of prince, suprim, jain make etc. comp- A) 75 mm dia.

1.0 MATERIALS:

1.1 The cowl vent shall be of 1st quality and make as approved By the Engineer-in-charge & As per Manufacturer's Specifications.

2.0 MODE OF MEASUREMENTS & PAYMENT:

2.1 The rate includes cost of all labour, materials; tools and plant etc. required for satisfactory completion of this item as specified in workmanship.

2.2 The rate shall be for a unit of one number.

Item No :-132

Providing and fixing in position P.V.C. cowl vent to pipes of prince, suprim, jain make etc. comp.(C) 100 mm Dia.

Same as Item no. 129 but done for 100mm dia.
The rate shall be for a unit of one number.

Item No :-133

Providing erecting and fixing double coated Syntex or equivalent PVC (ISI) mark water tank of reqd capacity each with all necessary fitting and connection etc. comp on terrace.

1.1 Approved PVC water tank of specified manufacturer

2.0 WORKMANSHIP:

2.1 The Syntex water tank shall be supplied in Size As per Decided By Engineer In charge and fixed, and fitted on basis of the drawings furnished by the manufacturer, on purchase of the water tank. Whenever, staging is required for installations, designs and drawings for the same up to 2.0 mt. height shall be furnished again placement of order. Installation can also be done through the trained personnel of the dealer. The work shall be carried out in best workman like manner as directed by Engineer-in-charge.

3.0 MODE OF MEASUREMENT AND PAYMENT:

3.1 The rate includes for all labour, materials, tools and equipment required to complete the working satisfactory manner.

3.2 The rate shall be for a unit of liter basis

3.4 The Payment shall be for a unit of liter basis.

Item No :-134

Providing and fixing SS Sink Glosy ASIS 304 Grade x 1mm thick with over all size 610x460 mm & bowl size 560x410x200 including Providing and fixing chromium plated, bottle trap with necessary couplings of approved quality and C.P. Pillar cock 15 mm Heavy duty swan neck etc complete as per detail drawing and instruction of EIC.

Above item shall be executed as per detail item description and shall be get approved by engineer in charge prior to procurement of **item description** **The system shall be installed as per the manufacture installation manual.**

The rate shall be for a unit of Nos.

Item No:-138

Box cutting the road surface to proper slope & camber for making a base for road work including removing the excavated stuff, and depositing on the road side slopes as directed up to 50 Mt. Lead

1. Cutting shall be done in proper grade & camber as per measurements given. Care must be taken the tall slopes are evenly and truly dressed. Cutting shall be done to the exact depth required and shall be as per formation level in proper grade and the camber. If extra depth of cutting is done due to negligence of contractor the same shall be refilled with approved quality of materials duly consolidated to the satisfaction of the Engineer-in-charge (without extra cost) Box cutting for soling and metalling in required width the depth shall be done.
2. The stuff received from the cutting shall be utilized for filling cuts and correcting side slopes of bank with all lead and lift directed. Useful Stuff shall be carefully stacked separately as directed,
3. The measurement shall be taken as per cross section measurement of the cutting based on length, breadth, depth measured with tape at every 25 metres interval.
4. The payment shall be made on Cmt. basis.

Item No.139

Rolling and Consolidating of soling including filling in depression which occurs during the process with power roller 8 tonne to 12 tonne. and compacting the bed as per specifications to core test 97% compacting complete in all respects to the entire satisfaction of the Engineer-in - charge.

1.0 Rolling

Rolling shall be done with a 8-12 tonne power roller. Rolling is continued till the required density achieved is at least 98 % of MDD the material determined by Proctor density as per IS 2720 Pt.VII) and a smooth surface obtained without leaving any roller marks on the surface. During rolling surface should be checked for grade and camber and irregularities corrected.

1.1 Curing

The compacted surface shall be cured for a minimum period of 7days before the next layer is placed.

Curing is done by sprinkling water over the surface five or six times a day. The surface shall not be allowed to dry during the curing period. Curing by ponding shall not be adopted.

1.2 Surface Irregularities

The finish surface should be checked for line, level and grade and surface finish. The maximum

permissible undulation in longitudinal profile shall not exceed 15 mm when checked with 3 meter

straight edge and in cross profile the variation from specified profile shall not exceed 12 mm.

2.0 Measurements and Payment: -

2.1 The length and breadth shall be taken to the nearest centimetre. The consolidated net plane area shall be calculated in square metres, correct to two places of decimals.

2.2 The rate shall be for a unit of one square meter.

2.3 The contract unit rate includes cost of mechanical roller required for consolidation including all labourequipments fuel, hire charges, tolls, and incidentals necessary.

Item No.140

Providing and fixing pre-cast kerb stone of 150mmx300mm size in M250 and embeded in concrete of mix 1:4:8 concrete bed below kerb stone of thickness 50mm shall also have to be provided all along the outer periphery of the track surface.

1.0 Material:

Water shall confirm to M-1, sand shall confirm to M-6, Cement shall confirm to M-3. Pre-cast concrete kerb stone of gray cement based concrete block 35cm length,30cm height and 15cm thick of M250 grade concrete approved shape.

2.0 Workmanship:

Sub grade shall be cleaned, levelled, wetted and rammed as directed. kerb stone of approved colour, shape and size, shall be laid in different pattern/design as shown in the drawing or as directed by Consulting Architect/Engineer in charge as directed on top, pressed, tapped gently to bring it in line and level and inter lock with others. The joint shall be as fine as possible. The finished surface shall be true to levels and slopes as directed. Necessary testing of blocks is to be carried out.

3.0 Mode of Measurement and Payments:

The rate shall include the cost of all materials and labour involved in all the operations described above. The rate shall be for a unit of running meter.

Item No :-141

Providing, laying, spreading and consolidation graded stone aggregate to wet mix macadam 150mm compacted thick as per MORT & H specifications including premixing the material with water at OMC in mechanical plant carriage of mixed material by tippers to site, laying in uniform layers with paver in sub base/ base course on well prepared surface and compacting with vibratory roller to achieve the desired density

1 SCOPE

This work shall consist of laying and compacting clean, crushed, graded aggregate and granular material, premixed with water, to a dense mass on a prepared subgrade sub base/ base or existing pavement as the case may be in accordance with the requirements of these specifications. The material shall be laid in one or more layers as necessary to lines, grades and cross-sections shown on the approved drawings or as directed by the Engineer.

The thickness of a single compacted Wet Mix Macadam layer shall not be less than 75mm. When vibrating or other approved types of compacting equipment are used, the compacted

depth of a single layer of the sub-base course may be increased to 20cm upon approval of the Engineer.

2 MATERIALS

2.1 AGGREGATES

2.1.1 PHYSICAL REQUIREMENTS :

Course aggregates shall be crushed stone. If crushed gravel / shingle is used, not less than 90 percent by weight of the gravel / shingle pieces retained on 4.75 mm sieve shall have at least two fractured faces. The aggregates shall conform to the physical requirements set forth in Table 400-10 below.

TABLE 40-10 PHYSICAL REQUIREMENT OF COARSE AGGREGATES FOR WET MIX MACADAM FOR SUB-BASE / BASE COURSES

Test	Test Method	Requirements
1.*Los Angeles Abrasion value	IS : 2386 (Part-4)	40 percent (Max)
Aggregate impact value	IS : 2386 (Part-4) or IS : 5640	30 percent (Max)
2. Combined Flakiness and Elongation indices (Total)**	IS : 2386(PART-1)	30 percent (Max)

* Aggregates may satisfy requirements of either of the two tests.

** To determine this combined proportion, the flaky stone from a representative sample should first be separated out. Flakiness index is weight of flaky stone metal divided by weight of stone sample only the elongated particles be separated out from the remaining (non flaky stone metal. Elongation index is weight of elongated particles divided by total non flaky particles. The value of flakiness index and elongation index so found are added up.

If the water absorption value of the coarse aggregate greater than 2 percent, the soundness test shall carried out on the material delivered to site as per 2386 (Part – 5).

2.1.2 Grading requirements :

The aggregates shall conform to the grading given in Table 400-11

TABLE 400-11. GRADING REQUIREMENTS OF AGGREGATES FOR WET MIX MACADAM.

Is Sieve Designation	Percent by weight Passing the IS sieve
53.00 mm	100
45.00 mm	95-100
26.50 mm	-
22.40 mm	60-80
11.20 mm	40-60
4.75 mm	25-40
2.36 mm	15-30
600.00 micron	8-12
75.00 micron	0-8

Materials finer than 425 micron shall have plasticity index (P.I) not exceeding 6.

The final gradation approved within these limits shall be well graded from coarse to fine and shall not vary from the low limit on one sieve to the high limit on the adjacent sieve or vice-versa.

3 Construction Operation :

3.1 Preparation of base : Clause 3.1 as below shall apply.

3.1 Preparation of base: The surface of the subgrade/sub-base/base to receive the water bound macadam course shall be prepared to the specification lines and cross fall (camber) and made free of dust and other extraneous material. Any ruts or soft yielding places shall be corrected in an approved manner and rolled unit firm surface is obtained if necessary by sprinkling water. Any sub-base/base/surface irregularities, where predominant, shall be made good by providing appropriate type of profile corrective course (levelling course) to clause 501 of these specifications.

As far as possible, laying water bound macadam course over an existing thick bituminous layer may be avoided since it will cause problems of internal drainage of the pavement at the interface of two courses. It is desirable to completely pick out the existing thin bituminous wearing course where water bound macadam is proposed to be laid over it. However, where the intensity of rain is low and the interface drainage facility is efficient, water bound macadam can be laid over the existing thin bituminous surface by cutting 50 mm x 50 mm furrows at an angle of 45 degrees to the centre line of the pavement at one metre intervals in the existing road. The directions and depth of furrows shall be such that they provide adequate bondage and also serve to drain water to the existing granular base course beneath the existing thin bituminous surface.

3.2 Provision of lateral confinement of aggregates :

While constructing wet mix macadam arrangement shall be made for the lateral confinement of wet mix. This shall be done by laying materials in adjoining shoulders along with that of wet mix macadam layer and following the sequence of operations described in Clause 4.1 as below.

4 Construction Operations:

4.1 Shoulder: The sequence of operations shall be such that the construction of paved shoulder is done in layers each matching the thickness of adjoining pavement layer. Only after a layer of pavement and corresponding layers in paved and earth shoulder portion have been laid and compacted, the construction of next layer of pavement and shoulder shall be taken up.

Where the materials in adjacent layers are different, these shall be laid together and the pavement layer shall be compacted first. The corresponding layer in paved shoulder portion shall be compacted thereafter, which shall be followed by compaction of earth shoulder layer. The adjacent layers having same material shall be laid and compacted together.

In all cases where paved shoulders have to be provided along side of existing carriageway, the existing shoulders shall be excavated in full width and to the required depth as per clause 3.7 under no circumstances, box cutting shall be done for construction of shoulders.

Compaction requirement of earthen shoulder shall be as per table 300-2 in the case of bituminous courses, work on shoulder (earthen/hard/paved), shall start only after the pavement course has been laid and compacted.

During all stages of shoulder (earth/hard/paved) construction, the required cross fall shall be maintained to drain off surface water

Regardless of the method of laying, all shoulder construction material shall be placed directly on the shoulder. Any spilled material dragged on to the pavement surface shall be immediately removed, without damage to the pavement, and the area so affected thoroughly cleaned.

3.4 Preparation of mix :

Wet Mix Macadam shall be prepared in an approved mixing plant of suitable capacity having provision for controlled addition of water and forced / positive mixing arrangement like pug-mil or pan type mixer of concrete batching plant.

Optimum moisture for mixing shall be determined in accordance with IS : 2720 (Part – 8) after replacing the aggregate fraction retained on 22.4 mm sieve with material of 4.75 micron to 22.4 mm size. While adding water, due allowance should be made for evaporation losses. However, at the time of compaction, water in the wet mix should not vary from the optimum value by more than agreed limits. The mixed material should be uniformly wet and so segregation should be permitted.

3.4 Spreading of mix :

Immediately after mixing, the aggregates shall be spread uniformly and evenly upon the prepared sub grade / sub-base / base in required quantities. In no case should these be dumped in heaps directly on the area where these are to be laid nor shall their hauling over a partly completed stretch be permitted.

The mix may be spread either by a paver finisher or motor grader. For portions where mechanical means cannot be used, manual means as approved by the Engineer shall be used. The motor grader shall be capable of spreading the material uniformly all over the surface. Its blade shall have hydraulic control suitable for initial adjustments and maintaining the same so as to achieve the specified slope and grade.

The paver finisher shall be self – propelled, having the following features :

- (i) Loading hoppers and suitable distribution mechanism
- (ii) The screed shall have tamping and vibrating arrangement for initial compaction to the layer as it is spread without rutting or otherwise marring the surface profile.
- (iii) The paver shall be equipped with necessary control mechanism so as to ensure that the finished surface is free from surface blemishes.

The surface of the aggregate shall be carefully checked with templates and all high or low spots remedied by removing or adding aggregate as may be tested by depth blocks during construction.

No segregation of larger and fine particles should be allowed. The aggregates as spread should be allowed. The aggregates as spread should be of uniform gradation with pockets of fine materials.

3.5 Compaction :-

After the mix has been laid to the required thickness, grade and camber the same shall be uniformly compacted, to the full depth with suitable roller. If the thickness of single compacted layer does not exceed 100mm, a smooth wheel roller of 80 to 100 KN weight may be used. For a compacted single layer up to 200mm, the compaction shall be done with the help of vibratory roller of minimum static weight of 80 to 100 KN or equivalent capacity roller. The speed of the roller shall not exceed 5 km/h. In portions having unidirectional

cross fall / super elevation rolling shall commence from the lower edge and progress gradually towards the upper edge. Thereafter, roller should progress parallel to the center line of the road. Uniformly over-lapping each preceding track by at least one fourth width until the entire surface has been rolled. Alternate trips of the roller shall be terminated in stops at least 1 m away from any preceding stop.

In portions in camber, rolling should at the edge with the roller running forward and backward until the edges have been firmly compacted. The roller shall progress gradually towards the center parallel to the center line of the road uniformly overlapping each of the preceding track by at least one – Fourth width until the entire surface has been rolled.

Any displacement occurring as a result of reversing of the direction of a roller or from any other caused shall be corrected at once as specified and / or removed and made good.

Along forms, Kerbs, walls or other places not accessible to the roller, the mixture shall be thoroughly compacted with mechanical tampers or a plate compactor. Skin patching of an area without scarifying the surface to permit proper bonding of the added material shall not be permitted.

Rolling should not be done when the sub grade is soft or yielding or when it caused a wave-like motion in the sub – base/ base course or sub grade. If irregularities develop during rolling which exceed 12mm when tested with a 3 meter straight edge, the surface should be loosened and premixed material added or removed as required before rolling again so as to achieve a conforming to the desired grade and cross fall. In no case should the use of unmixed material be permitted to make up the depressions.

Rolling shall be continued till the density achieved is at least 98 per cent of the maximum dry the material as determined by the method outlined in IS : 2720 (Part-8)

After completion, the surface of any finished layer shall be well-close, free from movement under compaction equipment or any compaction planes, ridges, cracks and loose material. All loose, segregated or otherwise defective areas shall be made good to the full thickness of the layer and re-compacted.

3.6 Setting and drying :

After final compaction of wet mix macadam course, the road shall be allowed to dry for 24 hours.

4 Opening to Traffic :

Preferably no vehicular traffic of any kind should be allowed on the finished wet mix macadam surface till it has dried and the wearing course laid.

5 Surface Finish and Quality control of work

5.1 Surface evenness :

The surface finish of construction shall conform to the requirements of Clause 902 of MORT & H specifications.

5.2 Quality Control :

Control on the quality of materials and works shall be exercised by the Engineer in accordance with section 901 of MORT & H specifications

6 Rectification of Surface Irregularity :

Where the surface irregularity of the wet mix macadam course exceeds the permissible tolerances or where the course is otherwise defective due to subgrade soil getting mixed with the aggregates, the full thickness of the layer shall scarified over the affected area.

Reshaped with added premixed material or removed and replaced with fresh premixed material as applicable and recomputed in accordance with Clause 406.3 of this item . The area treated in the aforesaid manner shall not be less than 5m long and 2m wide. In no case shall depressions be filled up with unmixed and ungraded material or fines.

6.7 Arrangement for Traffic :

During the period of construction, arrangement of traffic shall be done as per Claus 112 of MORT & H specifications

6.8 Measurements for Payment :

Wet mix macadam shall be paid as finished work in position on cross sectional measurements and computing the volume of WMM work in cubic meters by average area method.

6.9 Rate : The Contract unit rate for wet mix macadam shall be payment in full for carrying out the required operations including full compensation for all components listed below.

- i) Making arrangement for traffic to Clause 112 as above Except for initial treatment to verges, shoulders and Construction of diversions :
- ii) Furnishing wet materials o be incorporated in the work including all royalties, fees, rents where necessary and all leads and lifts ;
- iii) All labour, tools, equipment and incidentals to complete the work to the specifications
- iv) Carrying out the work in part widths of road where directed ; and
- v) Carrying out the required tests for quality control.

The payment shall be made on Cum basis.

Item No :-142

Providing & laying of specified compacted thickness Granular sub base (GSB) in specified grading in table 400-1 of the specification MORT&H and compactor to the required density with 8 - 10 tonne vibratory roller with plain drum or heavy pneumatic tyred roller of minimum 200 to 300 KN weight in all seasons as per MORT&H , maintaining the required slope & grade during the operation as approved by the engineer in charge & watering to the proper moisture content and sprinkled with the help of truck mounted water tank fitted with suitable arrangement .(fully saturated having CBR value greater or equal to 30) compacted thickness of 150 mm consisting of Machine crust stone aggregate as per grading 1 in table 400-1 of the specification MORT&H fifth Revision

SCOPE This work shall consist of laying and compacting well-graded material on prepared subgrade in accordance with the requirements of Specifications. The material shall be laid in one or more layers as sub-base or lower sub-base and upper sub-base (termed as sub base hereinafter) as necessary according to lines, grades and cross sections shown on the drawings or as directed by the Engineer.

2 MATERIALS

2.1 The material to be used for the work shall be natural sand, gravel, crushed stone, or combinations thereof depending upon the grading required. The material shall be free from organic or other deleterious constituents and conform to grading (given below). While the gratings in Table -1 are in

respect of close-graded granular sub-base materials, one each for maximum particle size of 75 mm, 53 mm and 26.5 mm, the corresponding gradings for the coarse-graded materials for each of the three maximum particle sizes are given at Table -2. The grading to be adopted for a project shall be as specified in the Contract.

2.2 Physical requirements The material shall have a 10 per cent fines value of 50 kN or more (for sample in soaked condition) when tested in compliance with BS : 812 (Part 111). The water absorption value of the coarse aggregate shall be determined as per IS :2386 (Part 3); if this value is greater than 2 per cent, the soundness test shall be carried out on the material delivered to site as per IS : 383. For Grading II and III materials, the CBR shall be determined at the density and moisture content likely to be developed in equilibrium conditions which shall be taken as being the density relating to a uniform air voids content of 5 per cent.

S. No.	Item	Ref. Code	Frequency
1	Granular Sub Base		
1.1	Gradation	IS:2720 (Part 4)	1 Tests/400 m ³
1.2	Atterberg's limits	IS:2720 (Part 5)	1 Tests/400 m ³
1.3	Moisture Content prior to compaction	IS:2720 (Part 2)	1 Tests/400 m ³
1.4	Field Density of compacted layer	IS:2720 (Part 28)	1 Tests/1000 m ²
1.5	Deleterious content test	IS:2720 (Part 27)	As required
1.6	CBR	IS:2720 (Part 16)	Minimum 30%, as required.

Table 400-1 : Grading for Granular Sub-base Materials

IS Sieve Designation	Percent by Weight Passing the IS Sieve					
	Grading I	Grading II	Grading III	Grading IV	Grading V	Grading VI
75.0 mm	100	-	-	-	100	-
53.0 mm	80-100	100	100	100	80-100	100
26.5 mm	55-90	70-100	55-75	50-80	55-90	75-100
9.50 mm	35-65	50-80	-	-	35-65	55-75
4.75 mm	25-55	40-65	10-30	15-35	25-50	30-55
2.36 mm	20-40	30-50	-	-	10-20	10-25
0.85 mm	-	-	-	-	2-10	-
0.425 mm	10-15	10-15	-	-	0-5	0-8
0.075 mm	<5	<5	<5	<5	-	0-3

3 STRENGTH OF SUBBASE

3.1 It shall be ensured prior to actual execution that the material to be used in the sub-base satisfies the requirements of CBR and other physical requirements when compacted and finished

3.2 When directed by the Engineer, this shall be verified by performing CBR tests in the laboratory as required on specimens remoulded at field dry density and moisture content and any other tests for the “quality” of materials, as may be necessary.

4 CONSTRUCTION OPERATIONS

4.1 Preparation of sub grade Immediately prior to the laying of sub-base, the subgrade already finished as applicable shall be prepared by removing all vegetation and other extraneous matter, lightly sprinkled with water if necessary and rolled with two passes of 8 -10 Ton smooth wheeled roller.

4.2 Spreading and compacting The sub-base material of grading specified in the Contract shall be spread on the prepared sub grade with the help of a motor grader of adequate capacity, its blade having hydraulic controls suitable for initial adjustment and for maintaining the required slope and grade during the operation or other means as approved by the Engineer.

When the sub-base material consists of combination of materials mentioned above, mixing shall be done mechanically by the mix-in-place method.

Manual mixing shall be permitted only where the width of laying is not adequate for mechanical operations. The equipment used for mix-in-place construction shall be a rotator or similar approved equipment capable of mixing the material to the desired degree. If so desired by the Engineer, trial runs with the equipment shall be carried out 9 of 9 to establish its suitability for the work.

Moisture content of the loose material shall be checked in accordance with IS : 2720 (Part II) and suitably adjusted by sprinkling additional water from a truck mounted or trailer mounted water tank

and suitable for applying water uniformly and at controlled quantities to variable widths of surface or other means approved by the Engineer so that, at the time of compaction it is from 1 per cent above to 2 per cent below the optimum moisture content corresponding to IS : 2720 (Part VIII). While adding water, due allowance shall be made for evaporation losses. After water, has been added, the material shall be processed by mechanical or other approved means like disc harrows, rotators until the layer is uniformly wet.

Immediately thereafter, rolling shall start. If the thickness of the compacted layer does not exceed 100 mm, a smooth wheeled roller of 8 to 10 Ton weight may be used. For a compacted single layer upto 225 mm the compaction shall be done with the help of a vibratory roller of minimum 8 to 10 Ton static weight with plain drum or pad foot drum or heavy pneumatic tired roller of minimum 200 to 300 kN weight having a minimum tyre pressure of 0.7 MN/m² or equivalent capacity roller capable of achieving the required compaction. Rolling shall commence at the lower edge and proceed towards the upper edge longitudinally for portions having unidirectional cross fall and super elevation and shall commence at the edges and progress towards the center for portions having cross fall on the both sides.

Each pass of the roller shall uniformly overlap not less than one third of the track made in the preceding pass. During rolling, the grade and camber shall be checked and any high spots or depressions which become apparent corrected by removing or adding fresh material. The speed of the roller shall not exceed 5 km per hour.

Rolling shall be continued till the density achieved is at least 98% of the maximum dry density for the material determined as per IS : 2720 (Part 7). The surface of any layer of material on completion of compaction shall be well closed, free from movement under compaction equipment and from compaction planes, ridges, cracks or loose material. All loose, segregated or otherwise defective areas shall be made good to the full thickness of layer and re-compacted.

4.3 Surface Finish and quality Control of Work

The finished surface shall be checked for lines, levels and regularity. The surface evenness of completed surface in longitudinal and transverse direction shall be within the tolerances specified.

5 MODE OF MEASUREMENTS:

The surface finish of construction shall conform to the requirements. Granular sub-base shall be measured as finished work in position in cubic meters.

Item No. :-143

Providing and fixing pre-cast Rubber Dye / steel Dye inter locking concrete block 60mm thick with grade of concrete M300 pneumatic compressed / vibrated mechanically and as per approved design Confirming to IS 15658 : 2006 including 35 mm Sand layer for levelling and filling the joint with sand in proper line and level as per guidelines of IRC : SP 63-2018 etc. Complete.

1.0 Material:

The concrete pavers should have perpendicularities after release from the mould and the same should be retained until laying.

The surface should be anti skid and anti flare type.

The pavers should have uniform special chamfers to facilitate easy drainage of surface run off.

The pavers should have uniform interlocking space of 2 to 3mm. to ensure compacted sand filling after vibration of the paver surface.

The pavers should have the following Engineering properties when tested as per IS 2185.

Crushing strength - minimum 250 kg. per sq.cm.

% of water absorption - 3% max.

Abrasion resistance - As per relevant IS codes.

The ingredients of pavers shall meet the specifications of relevant IS code (IS 15658-2006).

2.0 Workmanship:

Subgrade shall be cleaned, leveled, wetted and rammed as directed. 75mm thick layer of dry sand shall be spread over it. paver block of approved color, shape and size, shall be laid in different pattern/design as shown in the drawing or as directed by Consulting Architect/Engineer-in-charge as directed on top, pressed, tapped gently to bring it in line and level and inter lock with others. The joint shall be as fine as possible. The finished surface shall be true to levels and slopes as directed. Necessary testing of blocks is to be carried out.

3.0 Mode of Measurement and Payments:

The rate shall include the cost of all materials and labour involved in all the operations described above. The Paver block flooring shall be measured in square meters correct to two places of decimal, length and breadth shall be measured correct to a centimeter.

The rate shall be for a unit of one square meter

Item No. : -144

Providing and Laying trimix Controlled cement concrete M-250 finishing smooth with curing etc. complete including the cost of formwork but excluding the cost of reinforcement for internal road having thickness of 15 CM.compaction and finishing of road by trimix process surface by using vacuum dewatering, floater surface vibrator etc.Rate are also inclusive of Providing and Mixing Plastisizer of approved make.

Scope of Work:

This methodology shall be applicable for construction of dowel jointed or plain cement concrete pavement in accordance with the lines, grades, camber and thickness as shown in the drawings using fixed forms.

1.0 Material:

Cement:

These shall consist of Ordinary Portland Cement from approved source. The minimum cement content shall be 440 Kg/cum. However, optimum cement content shall be determined by carrying out concrete mix design in accordance with IRC: 44-2008 and establishing a job mix formula, approval of which shall be obtained from EIC

Admixtures:

The admixtures shall conform to IS 6925 and IS 9103 shall improve the workability of concrete or extension of time and they will not have any effect on the properties of concrete. The performance of these admixtures will be proved both on laboratory trials and in trial paving works. The admixtures containing calcium chloride shall not be used.

Aggregates:

The aggregates shall be of crushed stone or Crushed gravel, conforming to IS 383. The coarse aggregate shall be clean, hard, strong, dense and durable of crushed stone. The Los Angeles Abrasion value shall not be more than 35%. The fine aggregate shall be of clean natural sand or crushed stone sand or combination of both. These shall be free from clay, shale, loam, mica and other organic matter. The limit of deleterious material content shall not exceed the requirements set out in IS:383. Coarse aggregates and fine aggregates shall satisfy all the requirements specified in Sections 602.2.4.2 and 602.2.4.3 of MORTH (3rd Rev.)

Water:

Water used for mixing and curing of concrete shall be free from oil, salt, acid and other substances, which are harmful to concrete. It shall meet the requirements stipulated in IS: 456.

Mild steel bars for dowel and tie bars:

Dowel bars shall conform to S 240 (with yield strength 840 Mpa) and tie bars (deformed or plain) to grade Fe500 deformed steel bars as per IS: 1786/IS: 432

Pre-Molded joint filler:

This shall be used for expansion joints abutting structures like bridges, culverts and at end of the day work. These shall be of 20-25mm thickness or as shown in drawings, complying to IS 1838. It shall be 25mm less in depth than the thickness of slab provided in suitable lengths, which shall not be less than lane width. Holes shall be made to accommodate dowel bars.

Joint sealing compound:

While carrying out joint sealing, the provision made under codes viz. IRC: 57-2006, IRC: 15-2011 and IRC: 58-2011 shall be taken into consideration. This shall be hot poured Elastomeric type as per AASHTO M282 or cold poured Polysulphide type as per BS 5212-part2 having flexibility, resistance to age hardening and durability.

Separation membrane:

A separation membrane of impermeable plastic sheeting 125 microns thick shall lay between the concrete slab and sub-base by nailing with concrete nails to the lower layer. Where overlap is necessary the same shall be laid by at least 300mm.

2.0 Workmanship:

Mix: M250

The mix shall be designed as per IRC: 44-2008. And the design shall be based on the flexural strength of concrete. The water content shall be minimum required to provide workability for full compaction of the concrete to the required density. The maximum free water cement ratio shall be 0.5. The mix shall be proportioned to give an average strength at 28 days exceeding the specified strength (4.8Mpa) by 1.65 times the standard deviation calculated from the flexural strength of the first 30 beams first during the trial length and then the job control test beams (during the actual execution). The workability requirements at the batching plant and at site shall be established by slump tests while doing trial length. A slump value of 30 ± 15 mm is reasonable for slip form paving and 50 ± 15 mm for fixed form paving.

Avg. strength Ratio \otimes of 7days and 28 days compressive strength of cubes prepared from each batch shall be determined periodically during construction. If R value so obtained is found less than those determined as the time of mix design, 5% extra cement shall be added to the mix.

Mixing:

The materials shall be mixed in a mechanized batching plant consisting air-conditioned centralized control cabin, minimum 4bins, weigh hoppers, separate scales for cement, fine and coarse aggregate with weighing balances calibrated, aggregates being proportioned by automatic weighing devices using load cells. The concrete ingredients shall be mixed thoroughly by a mixer with automatic timing/alarm device to mix and discharge (in case of failure of timing/alarm device concrete shall be mixed as per Manufacturer's recommendations) capable of mixing to get a homogenous mix without being segregated while discharge.

Joints, dowel and tie bars:

The location and type of joint shall be as shown in the drawings.

Contraction Joints

Transverse joints shall be contraction and expansion joints, cut with mechanical saw, could start as early as 6-8 hours, i.e. initial hardening of concrete, after paving. The contraction joints shall consist of mechanical sawn joint groove, 3 to 5mm wide and 1/4 to 1/3 depth of the slab. The expansion joints shall consist of a joint filler board positioned vertically with the prefabricated assemblies along the line of joint.

The dowel bars shall mild steel with details and dimensions as indicated in the drawings. Unless otherwise shown in the drawings the dowel bars shall be positioned at the mid depths of the slab with suitable tools/means within ± 20 mm tolerances. The dowel bars shall be covered with plastic sheath for at least 2/3rd from one end for contraction joint, and 1/2 length +50mm for expansion joint. For expansion joints, a closely fitting cap of 100mm long shall be provided at the sheath end. To block the entry of cement slurry between dowel and cap a compressible sponge may be used.

The dowel bars shall be supported on cradles / chairs in pre-fabricated joint assemblies positioned prior to the construction of slab or mechanically inserted with vibration into the plastic concrete by a method which ensures correct placement of the bars besides full re-compaction of the concrete around the dowel bars.

Longitudinal Joints:

The longitudinal joints shall be saw cut as shown in the drawings. A groove of 1/3rd the depth of the slab may be cut after the final set of the concrete. The tie bars shall be deformed

steel bars of Fe500/500D complying to IS 1786. Tie bars shall be painted with bituminous paint for 75mm at the both ends and positioned with suitable tools/means. Tie bars shall be placed within the middle third of the slab depth.

Tie bars in the longitudinal joints shall be made up into rigid assemblies with adequate supports to remain firmly in position during the construction of slab.

Construction Joints:

Transverse construction joints shall be place whenever concreting is completed for the day's work on is suspended for more than 30 minutes. These shall be provided at regular location of contraction joints using dowel bars as stated above.

Using sealants, not before 14days after construction of slab shall seal all transverse and longitudinal joints, but prior to allowing the traffic ply on the new construction.

Separation membrane:

A separation membrane of impermeable plastic sheeting 125 microns thick shall lay between the concrete slab and the sub base by nailing with concrete nails to the lower layer. Wherever overlap is necessary, the same shall be laid by at least 300mm. Before placing the separation membrane the sub-base shall be swept clean of all extraneous materials using high pressure water jetting or compressed air.

Construction by fixed form:

This shall consist of straight side forms made of steel of thickness not less than 5mm and of minimum 3000mm length. These shall have a depth equal to the prescribed thickness of the pavement. These forms shall be straight and free from bends and warps. Side forms shall be of sufficient rigidity in the form and in the interlocking connection with adjoining form such that springing will not occur under the weight of the sub grade and paving equipment or from pressure of concrete.

The vibrators for concreting shall be either surface pan type or internal type with immersed tube or multiple spuds. The surface vibrators shall a frequency not less than 3500 impulse per minute and the internal type vibrators shall have frequency more than 5000 impulse per minute.

Curing:

Curing shall be done manually by sprinkling water on PQC surface. Wet Jute bags shall be used to cover whole surface. Curing shall be start day after concreting and shall be done everyday up to 14th day.

After the side forms are removed, edges of slabs shall be corrected wherever irregularities have occurred by using fine concrete consisting 1:3 ratio of cement to fine chips and aggregate.

After the final regulation of the slab and before the application of curing membrane, the surface of the concrete shall be brush-textured at right angles to the longitudinal axis. The wire brush used for this purpose shall be made of 32 gauge type wired grouped together in tufts at 10mm centers and of width not less than 450mm.

Joints sealing:

When saw cuts joints are adopted in construction, they are not made to provide the minimum width specified in the drawings, they shall be widened subsequently by sawing before sealing, and the width and depth are controlled by gauges. When sealants are applied, an appropriate primer shall also be used, if recommended by the manufacturer and it shall be applied in accordance with their requirements. The sealant shall be applied within the

minimum and maximum drying time of the primer recommended by the manufacturer. Before sealing, the temporary seal provided for blocking the ingress of dirt, soil, etc. should be removed. A highly compressible heat resistant paper-backed de-bonding strip as shown in drawing shall be inserted in the groove to serve the purpose of breaking the bond between sealant and the bottom of the groove and to plug the joint groove, so that the sealant may not leak through the cracks.

Machinery Requirement:

Batching plant, Transit Miller, Fixed form concrete paver machine with Vibrating screed roller, Water Tanker, Vibrator, Shovels, Broom, Wire brush, Straight edge.

Setting out will be done prior to work demarking the area of execution.

Measurement for Payment

The unit of measurement for M400 pavement cement concrete pavement shall be in cubic metre of concrete placed, based on the net plan area for the accepted thickness shown on the drawings or as directed by the Engineer.

The rate shall be for a unit of one cubic meter.

Item No. : -145

Shrubs/Ground covers

Supplying and planting healthy shrubs of different species of 450mm to 900 mm height: by using the soil/ manure (either carted or supplied), and watering it immediately. Maintaining(application of liquid manures/ growth regulators/ pesticides as per need, weeding and gap filling regularly so as to keep the plant healthy all the time) it for a period of 3 months from the date of plantation-Ixora Pink, Ixora Red, Ixora Yellow, Ixora White or as per selection of Engg. in charge/Architect.

Above item shall be executed as per detail item description and shall be get approved by engineer in charge.

The rate shall be for a unit of No.

Item No. : -146

Lawn/Grass

Supplying and planting of good quality nodes of specified grass for dibbling: It includes the cultivation of dround to a depth of 150mm, Planting (2"-3" apart) of grass as per drawing without disturbing the desired gradient and level, watering, maintaining (forking, mowing, weeding, fertilizer application, pest control etc.) it for a period of 3 months from the date of lawn dibbling/plantation.

Doob grass(dibbling)

Above item shall be executed as per detail item description and shall be get approved by engineer in charge.

Mode of Measurement:

Mode of measurement for this item shall be carried out in the unit of Sqmt..

BHAVANAGAR MUNICIPAL CORPORATION

Name of Work :- Construction Of New PHC In The Area Of Bhavnagar City,Kumbhrwada, Bhavnagar(B.M.C.)					
Cement Consumption					
Item No	Item Description	Unit	Total Qty	Qty of Cement in KG	Total (KG)
10	Providing and laying cement concrete 1:2:4 (1-Cement : 2- Coarse sand : 4- graded stone aggregates 20 mm nominal size) and curing complete excluding cost of formwork in (A) Foundation and Plinth	Cum.	212.50	290.00	61625.00
11,12	Providing and laying controlled cement concrete M250 work with curing etc. complete including the cost of from workbut excluding cost of Reinforcement for RCC work in (A) Foundation footing base of columns and mass concrete.	Cum.	99.00	380.00	37620.00
13	Providing and laying controlled cement concrete M250 work with curing etc. complete including the cost of from workbut excluding cost of Reinforcement for RCC work in Column upto Plinth Level.	Cum.	29.00	380.00	11020.00
14	Providing and laying controlled cement concrete M250 work with curing etc. complete including the cost of from workbut excluding cost of Reinforcement for RCC work in RCC Wall upto Plinth Level.	Cum.	25.00	380.00	9500.00
15	Providing and laying controlled cement concrete M250 work with curing etc. complete including the cost of from work but excluding cost of Reinforcement for RCC work in Beam. .GB/PB	Cum.	66.00	380.00	25080.00
16	Brick work using common burnt clay building bricks having crushing strength not less than 35 kg./Sq.Cm. in foundation and plinth in Cement Mortar 1:6 (1-Cement : 6 -fine sand)(B) Conventional	Cum.	24.50	60.00	1470.00
20	Providing and laying controlled cement concrete M250 work with curing etc. complete including the cost of from work but excluding cost of Reinforcement for RCC work in Column (G.F.)	Cum.	35.00	380.00	13300.00

21	Providing and laying controlled cement concrete M.250 work with curing etc. complete including the cost of formwork but excluding the cost of reinforcement for RCC work in Column (F.F.)	Cum.	20.00	360.00	7200.00
22	Providing and laying controlled cement concrete M.250 work with curing etc. complete including the cost of formwork but excluding the cost of reinforcement for RCC work in Column (S.F.)	Cum.	20.00	380.00	7600.00
23	Providing and laying controlled cement concrete M.250 work with curing etc. complete including the cost of formwork but excluding the cost of reinforcement for RCC work in Column (T.F.)	Cum.	7.00	380.00	2660.00
24	Providing and laying controlled cement concrete M250 work with curing etc. complete including the cost of from work but excluding cost of Reinforcement for RCC work in RCC Wall (G.F.)	Cum.	4.00	380.00	1520.00
25	Providing and laying controlled cement concrete M.250 work with curing etc. complete including the cost of formwork but excluding the cost of reinforcement for RCC work in RCC Wall (F.F.)	Cum.	4.00	380.00	1520.00
26	Providing and laying controlled cement concrete M.250 work with curing etc. complete including the cost of formwork but excluding the cost of reinforcement for RCC work in RCC Wall (S.F.)	Cum.	4.00	380.00	1520.00
27	Providing and laying controlled cement concrete M.250 work with curing etc. complete including the cost of formwork but excluding the cost of reinforcement for RCC work in RCC Wall (T.F.)	Cum.	3.00	380.00	1140.00
28	Providing and laying controlled cement concrete M250 work with curing etc. complete including the cost of from workbut excluding cost of Reinforcement for RCC work in Lintel/Coping (G.F.)	Cum.	17.50	380.00	6649.85
29	Providing and laying controlled cement concrete M250 work with curing etc. complete including the cost of from workbut excluding cost of Reinforcement for RCC work in Lintel/Coping (F.F.)	Cum.	2.00	380.00	760.00

30	Providing and laying controlled cement concrete M250 work with curing etc. complete including the cost of from workbut excluding cost of Reinforcement for RCC work in Lintel/Coping (S.F.)	Cum.	2.00	380.00	760.00
30	Providing and laying controlled cement concrete M250 work with curing etc. complete including the cost of from workbut excluding cost of Reinforcement for RCC work in Lintel/Coping (T.F.)	Cum.	4.00	380.00	1520.00
31	Providing and laying controlled cement concrete M250 work with curing etc. complete including the cost of from workbut excluding cost of Reinforcement for RCC work in Beam (G.F.)	Cum.	24.00	380.00	9120.00
32	Providing and laying controlled cement concrete M250 work with curing etc. complete including the cost of from workbut excluding cost of Reinforcement for RCC work in Beam (F.F.)	Cum.	23.00	380.00	8740.00
33	Providing and laying controlled cement concrete M250 work with curing etc. complete including the cost of from workbut excluding cost of Reinforcement for RCC work in Beam (S.F.)	Cum.	19.00	380.00	7220.00
34	Providing and laying controlled cement concrete M250 work with curing etc. complete including the cost of from workbut excluding cost of Reinforcement for RCC work in Beam (T.F.)	Cum.	4.00	380.00	1520.00
34	Providing and laying controlled cement concrete M250 work with curing etc. complete including the cost of from workbut excluding cost of Reinforcement for RCC work in CHAJJA, (G.F.)	Cum.	15.50	380.00	5890.00
35	Providing and laying controlled cement concrete M250 work with curing etc. complete including the cost of from workbut excluding cost of Reinforcement for RCC work in CHAJJA, (F.F.)	Cum.	14.00	380.00	5320.00
36	Providing and laying controlled cement concrete M250 work with curing etc. complete including the cost of from workbut excluding cost of Reinforcement for RCC work in CHAJJA, (S.F.)	Cum.	13.00	380.00	4940.00

37	Providing and laying controlled cement concrete M250 work with curing etc. complete including the cost of from workbut excluding cost of Reinforcement for RCC work in CHAJJA, (T.F.)	Cum.	1.00	380.00	380.00
38	Providing and laying controlled cement concrete M250 work with curing etc. complete including the cost of from workbut excluding cost of Reinforcement for RCC work in SLAB (G.F.)	Cum.	53.93	380.00	20493.40
39	Providing and laying controlled cement concrete M250 work with curing etc. complete including the cost of from workbut excluding cost of Reinforcement for RCC work in SLAB (F.F.)	Cum.	38.00	380.00	14440.00
40	Providing and laying controlled cement concrete M250 work with curing etc. complete including the cost of from workbut excluding cost of Reinforcement for RCC work in SLAB (S.F.)	Cum.	38.00	380.00	14440.00
41	Providing and laying controlled cement concrete M250 work with curing etc. complete including the cost of from workbut excluding cost of Reinforcement for RCC work in SLAB (T.F.)	Cum.	6.00	380.00	2280.00
42	Providing and laying controlled cement concrete M250 work with curing etc. complete including the cost of from workbut excluding cost of Reinforcement for RCC work in Staircase (G.F.)	Cum.	5.00	380.00	1900.00
43	Providing and laying controlled cement concrete M250 work with curing etc. complete including the cost of from workbut excluding cost of Reinforcement for RCC work in Staircase (F.F.)	Cum.	5.00	380.00	1900.00
44	Providing and laying controlled cement concrete M250 work with curing etc. complete including the cost of from workbut excluding cost of Reinforcement for RCC work in Staircase (S.F.)	Cum.	5.00	380.00	1900.00
51	Brick work using common burnt clay building bricks having crushing strength not less than 35 Kg/Sq.Cm. In Super Structure above plinth level up to floor two level in cement mortar 1:6 (1 Cement: 6-Fine sand) with curing etc. (b)Conventional. (G.F.)	Cum.	180.50	60.00	10830.00

52	Brick work using common burnt clay Building bricks having crushing strength not less than 35 Kg/Sq.Cm. In Super Structure above plinth level up to floor two level in cement mortar 1:6 (1 Cement: 6- Fine sand) with curing etc. (b)Conventional. for F.F.	Cum.	60.50	60.00	3630.00
53	Brick work using common burnt clay Building bricks having crushing strength not less than 35 Kg/Sq.Cm. In Super Structure above plinth level up to floor two level in cement mortar 1:6 (1 Cement: 6- Fine sand) with curing etc. (b)Conventional. for S.F.	Cum.	35.00	60.00	2100.00
54	Brick work using common burnt clay Building bricks having crushing strength not less than 35 Kg/Sq.Cm. In Super Structure above plinth level up to floor two level in cement mortar 1:6 (1 Cement: 6- Fine sand) with curing etc. (b)Conventional. for T.F.	Cum.	25.00	60.00	1500.00
53	Half brick masonry in common burnt clay building bricks having crushing strength not less than 35 Kg/Sq.Cm. in Cement mortar 1:4 (1- Cement : 4 - coarse sand) in foundation and plinth (B) Conventional (upto 10 ton) (for GF)	Sqm.	73.00	10.64	776.72
54	Half brick masonry in common burnt clay building bricks having crushing strength not less than 35 Kg/Sq.Cm. in Cement mortar 1:4 (1- Cement : 4 - coarse sand) in foundation and plinth (B) Conventional (upto 10 ton) (for FF)	Sqm.	70.00	10.64	744.80
55	Half brick masonry in common burnt clay building bricks having crushing strength not less than 35 Kg/Sq.Cm. in Cement mortar 1:4 (1- Cement : 4 - coarse sand) in foundation and plinth (B) Conventional (upto 10 ton) (for SF)	Sqm.	44.00	10.64	468.16
68	Providing & laying 24"x24" Vitrified tiles 8 MM thick in flooring over 40 mm (Av.) base of C.M. 1:6 (1 Cement : 6 Coarse sand) on new surface or fixing on existing flooring by adhesive materials incldg. Dismanteling of existing flooring & joined with colour cement slurry including finished with flush pointing & cleaning the surface etc. completed Light Shade.	Sqm.	3.00	40.00	120.00

69	Providing and laying Vitrified tiles 8 to 10 mm thick , 24" x 24" in skirting risers of steps and dedo on 10mm thick cement plaster 1:3 (1-cement : 3-coarse sand) and jointed with white cement slurry	Sqm.	1.00	11.61	11.61
70	P & L 24" x 24" vitrified 8 mm thick tile flooring over 40 mm (average) base of cement mortar 1:6 (1 cement: 6 coarse sand) on new surface or fixing on existing flooring by adhesive material including Applying spacer of 5mm and not less than 3mm depth and filling groove with epoxy filler material of laticrete , Roff or equivalent. & cleaning the surface etc. complete for light shade	Sqm.	533.00	11.61	6188.13
71	Providing and laying white glazed tiles 6mm thick in flooring treads of steps and landing laid on a bed of 12mm thick cement mortar 1:3 (1-cement : 3-coarse sand) finishing with flush pointing in white cement.	Sqm.	182.00	11.61	2113.02
72	Providing and laying white glazed tiles 6mm thick in skirting risers of steps and dedo on 10mm thick cement plaster 1:3 (1-cement : 3-coarse sand) and jointed with white cement slurry	Sqm.	1192.00	9.52	11347.84
70	Providing and laying Vitrified tiles 8 to 10 mm thick , 24" x 24" in skirting risers of steps and dedo on 10mm thick cement plaster 1:3 (1-cement : 3-coarse sand) including Applying spacer of 5mm and not less than 3mm depth and filling groove with epoxy filler material of laticrete , Roff or equivalent. & cleaning the surface etc. complete	Sqm.	1138.00	10.44	11880.72
73	Providing and laying Lather finished granite stone slab 18mm thick in flooring treads of steps and landing laid on a bed of 12mm thick cement mortar 1:6 (1-Cement : 6-Coarse Sand) finishing with full molded round edges, flush pointing in white or colour cement.	Sqm.	56.00	10.60	593.60

74	Providing and laying polished Granite Slab 18mm thick in Risers of steps Dedo, window sill, jembs and pillars laid 10mm thick Cement Mortar 1:3 (1-Cement : 3 coarse sand and jointed with Grey Cement Slurry including full molded round front edges , rubbing and polishing etc. complete.	Sqm.	243.00	10.60	2575.80
75	Providing and laying polished Kota stone slab flooring over 20mm (Average) thick base of cement mortar 1:6 (1-cement : 6-coarse sand) or L.M. 1.1.5 (1-Lime putty :1.5 - coarse sand) laid over and jointed with grey cement slurry mixed with pigment to match the shade of slab including rubbing and polishing etc. complete. (A) 25mm thick	Sqm.	39.00	12.00	468.00
76	Providing and laying polished kota stone slab 25mm thick in risers of steps,skirting Dedo and pillars laid on 40mm thick cement mortar 1:3 (1-Cement : 3 coarse sand) and jointed with gray cement slury mixed with pigment to match the shade of slab including rubbing and polishing etc. complete.	Sqm.	6.00	12.52	75.12
77	Providing 10 mm thick cement mala plaster on ceiling and soffits of stairs for interior upto floor two level, in cement mortar (1:4) (1 cement : 4 sand) etc complete. Ground floor	Sqm.	284.00	4.33	1229.72
78	Providing 10 mm thick cement mala plaster on ceiling and soffits of stairs for interior upto floor two level, in cement mortar (1:4) (1 cement : 4 sand) etc complete. First floor	Sqm.	294.00	4.33	1273.02
79	Providing 10 mm thick cement mala plaster on ceiling and soffits of stairs for interior upto floor two level, in cement mortar (1:4) (1 cement : 4 sand) etc complete. Second floor	Sqm.	299.00	4.33	1294.67
80	Providing 10 mm thick cement mala plaster on ceiling and soffits of stairs for interior upto floor two level, in cement mortar (1:4) (1 cement : 4 sand) etc complete. Terrace floor	Sqm.	26.00	4.33	112.58

81	Providing 15 mm thick cement mala plaster in single coat on fair side bricks/concret walls for interior plastering up to floor two level finished even and smooth in cement mortar 1:4 (1 cement : 4 sand) etc complete. Ground Floor	Sqm.	969.00	6.27	6075.63
82	Providing 15 mm thick cement mala plaster in single coat on fair side bricks/concret walls for interior plastering up to floor two level finished even and smooth in cement mortar 1:4 (1 cement : 4 sand) etc complete. First Floor	Sqm.	752.00	6.27	4715.04
83	Providing 15 mm thick cement mala plaster in single coat on fair side bricks/concret walls for interior plastering up to floor two level finished even and smooth in cement mortar 1:4 (1 cement : 4 sand) etc complete. Second Floor	Sqm.	526.00	6.27	3298.02
84	Providing 15 mm thick cement mala plaster in single coat on fair side bricks/concret walls for interior plastering up to floor two level finished even and smooth in cement mortar 1:4 (1 cement : 4 sand) etc complete. Third(Terace) Floor	Sqm.	74.00	6.27	463.98
85	20mm.thick sand faced cement plaster on walls upto height 10 meters above ground level consisting of 12mm. Thick backing coat of CM.1:3 (1-cement:3-sand) and 8mm.thick finishing coat of C.M. 1:1 (1-cement:1-sand) etc. complete.	Sqm.	1982.00	16.83	33357.06
84	Providing and laying 20 mm thick water proof cement plaster using water proofing powder 1Kg/1bag of cement for all floors on brick / concrete wall work using water proofing materials in C M 1: 4 (1 cement 4 coarsse sand) including finishing with a floating coat of neat cement slurry etc complete for all floor.	Sqm.	234.80	8.51	1998.15
95	Providing cement vata, 10 cm. x 10 cm. size, quarter round in cement mortar 1:1 including neat cement finishing, watering, etc. complete.	Rmt.	644.55	2.55	1643.60

96	Providing and laying china mosaic water proofing treatment on terrace including applying neat cement slurry 2.75 Kg./Sqm. Of cement admixed with water proofing compound after cleaning the surface (b) laying cement concrete using brick bats 25 to 100 mm size with 50% C.M. 1:5 (1 cement : 5 coarse sand) admixed with water proofing compound over 20 mm thick layer of C.M. 1:5 to required slope including rounding of junction of walls and slabs (a) after two days of proper curing applying a second with 20 mm thick C.M. 1:4 and china mosaic tiling and finally finishing the surface with trowel white cement slurry (e) after finishing the whole terrace shall be flooded with water for two weeks.	Sqm.	281.00	40.00	11240.00
97	Supply & Fixing of Broken Glazed (China Mosaic) tiles size 5-6 mm thick of different size and shade (approved crazy pattern) in Cement:Mortar 1:2 and joint filling with White Cement / Coloured Cement with water proofing component including Ramping, Watering, Curing etc. complete (FOR ALL FLOOR)	Sqm.	3.00	40.00	120.00
114	Providing and fixing PVC SWR Nahni trap IS 14735 for drain - 100 mm diameter with jali of the following nominal diameter of self cleansing design with C.I. screed down or hinged grating including the cost of cutting and making good the walls	No	35.00	5.00	175.00
117	Providing and fixing S.W. gully trap with C.I. grating brick masonry chamber and water tight C.I. cover with frame of 300mm x 300mm size (inside) with standard weight.(i) Square mouth traps.(B) 150mm x 100mm size P or R type	No	5.00	20.00	100.00

118	Constructing brick masonry chamber for underground C.I. Inspection chamber and bends with bricks having crushing strength not less than 35Kg/Cm ² in C.M. 1:5 C.I. cover with frame (Light duty) 455mm x 610mm intenal dimensions total weight of cover with frame to be not less than 38Kg. (Wt. of cover 23 Kg.) and Wt. of frame 15Kg.) (R.C.C. top slabe with 1:2:4 mix (1-cement :2-coarse sand :4-graded stone aggregate 20mm size) foundation concrete 1:5:10 inside plaster 15mm thick with cement mortar 1:3 finished smooth with a floating coat of neat cement on walls and bed concrete etc. complete.(i) Inside dimensions 455mmx 610mm and 450mm deep for single pipe line.	No	10.00	113.00	1130.00
138	Providing and fixing pre- cast concrete kerb stone of gray cement based concrete block 30 cm length, 30 cm height and 15cm thick of 250 grade concret as per approved design and including excavation for fixing in proper line and level, fillig the joint with C: M 1:3 (1 Cement : 3 Fine Sand) etc. complete	Rmt.	83	2.50	207.50
142	Providing and Laying trimix Controlled cement concrete M-250 finishing smooth with curing etc. complete including the cost of formwork but exculding the cost of reinforcement for internal road having thickness of 15 CM.compaction and finishing of road by trimix process surface by using vaccum dewatering, floater surface vibrator etc.Rate are also inclusive of Providing and Mixing Plastisizer of approved make.	Cmt	72.00	380.00	27360.00
			Total wt. in KG		444165.74
			Total wt. in MT		444.17
			Say (MT)		445.00

BHAVNAGAR MUNICIPAL CORPORATION

Name of Work :- Construction Of New PHC In The Area Of Bhavnagar City,Kumbharwadar, Bhavnagar(B.M.C.)			
STEEL CONSUMPTION			
Sr No	Description	Unit	Qty.
47	Providing TMT Bar FE 500D reinforcement for R.C.C. work including Cutting, bending, binding and placing in position complete upto floor two level (G.F.)	Kg.	72537.80
48	Providing TMT Bar FE 500D reinforcement for R.C.C. work including Cutting, bending, binding and placing in position complete upto floor two level (F.F.)	Kg.	17815.00
49	Providing TMT Bar FE 500D reinforcement for R.C.C. work including Cutting, bending, binding and placing in position complete upto floor two level (S.F.)	Kg.	16915.00
50	Providing TMT Bar FE 500D reinforcement for R.C.C. work including Cutting, bending, binding and placing in position complete upto floor two level (T.F.)	Kg.	4430.00
Total in kg.			111697.80
Total in Metric Tonne			111.70
SAY (Metric Tonne)			112.00

**MUNICIPAL CORPORATION
BHAVNAGAR**

VENDOR LIST

(A) LIST OF APPROVED VENDORS FOR CIVIL WORKS

Sr. No.	ITEMS	Approved Brands / Quality
1	CEMENT OPC 53 Grade & SULPHATE RESISTANT CEMENT,S.R.C.	Ambuja, Hathi, Ultra Tech, Sanghi, Siddhi, Hi-bond
2	BRICKS	MBM, Arjun, PBM, 555, Kisan, ABM, TRD, Paresh, Dhara, B.R.C., Kiran, BMB, Kirit, Sonal
3	Steel TMT, CRS	TISCO, SAIL, VIZAG, Kamdhenu, NATIONAL, Electrotherm, JSW, Welspun steel, Pollad Steel, DIAMOUND TMT, M. G. Steel, Friends Steel, Crown next TMT, Briskon TMT
4	VITRIFIED TILES	Asian, Kajaria, Jonson, Varmora, Simpolo, OASIS
5	CERAMIC TILES	Asian, Kajaria, Johnson, Varmora, Simpolo, OASIS
6	GLAZED TILES	Asian, Kajaria, Johnson, Varmora, Simpolo
7	ACRYLIC PAINT	ICI, Asian, Nerolac, Burger
8	OIL BOUND DISTEMPER	ICI, Asian, Nerolac, Burger
9	EXTERIOR WEATHER PROOF EMULSION PAINT	ICI, Asian, Nerolac, Burger
10	Oil Paint	ICI, Asian, Nerolac, Burger
11	SANITARY WARE	Cera, Hindware, Parryware
12	CAST IRON PIPES AND FITTINGS.	NECO, Swayarhoo, Bengal, Oriental Castings, Electro steel Castings
13	P.V.C. PIPES AND FITTING (UPVC/CPVC)	Finolex, Supreme, Jain, Kisan, Astral, Dutron, Prince
14	CHROMIUM PLATED WATER SUPPLY FITTINGS	Jaquar, Ess Ess, Plumber ,ESSCO, Crown, Metro, Prince
15	GALVANIZED PIPE	Tata, Essco, Jaquar, Ess Ess, Plumber
16	GALVANIZED FITTINGS	'R' Brand, 'RV' Brand, Kranti
17	C.I. MANHOLE COVER	Manish, Sil, NECO
18	PLUMBING FIXTURES	Jaguar, Plumber, Essco
19	PVC WATER TANK (100% VIRGIN PVC)	Sintex, Aqua
20	ALUMINIUM SHEETS AND ACCESSORIES	Nalco, Jindal, Hindalco, Banko

Sr. No.	ITEMS	Approved Brands / Quality
21	ALUMINIUM EXTRUDED DOOR/ WINDOW SECTION	Jindal, Hindalco, Banko, Ajin India, Aldowin, Alumilite
22	ALUMINIUM HARDWARE	Rajdoot, Belu, Diamond, Glider, Ajin India, Aldowin, Alumilite
23	WATER PROOFING MATERIALS	Zycosil, Dr. Fixit, Kerakoll, Pidilite, Roff
24	DOOR CLOSER	Efficient Gadget, Everite, Hardwin, Aldowin, Ozone
25	DOOR FITTINGS	Godrej, Efficient Gadgets (E.G.) Dunex, Doorset, Suzu, Coral
26	HINGES	Suzu, Yama, E.P.P.W.
27	SCREW AND BOLTS	Nettle Folds, GKW, Stud
28	BOLTS & FASTENERS	Hilti, Fisher
29	LIFT	Top, Express, Omega, OTIS, Schander, TRIO, Aegis Elevator, Mitsubishi, Aditya, Siemens slider
30	ROOFING MATERIAL – Galvalume sheets	TATA, Essar, Jindal
31	Slag Cement	SANGHI CEMENT Sanghipuram
32	CPVC PIPES FOR AUTOMATIC SPRINKLER FIRE EXTINGUISHING SYSTEM	ASTRAL POLY TECHNIK LIMITED પાર્કિંગ એરિયા, બેઈઝમેન્ટ એરિયા જેવા વિસ્તારો સિવાય માત્ર કન્સીલ્ડ પાઈપીંગ માટે આ કંપનીના CPVC pipe નો ઉપયોગ fire sprinkler piping માટે કરવાની મંજૂરી આપવામાં આવે છે.
33	AAC Blocks	NXTBLOC
34	Jointing Mortar	NXTFIX Block
35	Ready Mix Plaster	NXTPLAST
36	Block joining Masonry Mortar	Unifix
37	Tile adhesive	Unifix
38	RCC bench	Sardar Pre cast
39	Rubber mould garden curbin	Sardar Pre cast

Sr. No.	ITEMS	Approved Brands / Quality
40	Rubber mould Paver block	Sardar Pre cast
41	Fencing Pole	Sardar Pre cast
42	RCC Masonry block	Sardar Pre cast
43	Pre cast wall	Sardar Pre cast

(B) LIST OF APPROVED VENDORS FOR MECHANICAL & ELECTRICAL WORKS

Sr. No.	Description	Name of Manufacturer
1	HSCF Pump	Crompton Greaves Ltd
		Kirloskar Brothers Limited (KBL)
		JASCO
		Mather & Platt Pumps Ltd.
		Jyoti Ltd.
2	Electric Motor	Lubi Industries LLP
		Bharat Bijlee Ltd.
		Jyoti Ltd.
		JSL Industries Ltd.
		Jeumont Electrical India Pvt. Ltd.
3	Electrical Panel	LHP
		Crompton Greaves Ltd
		Bhagyashree Power Control
		Dynamic Control System
		Elembica Services
		JSL Industries Ltd.
4	Kinetic Air Valve	Nutral Power Tech
		Kirloskar Brothers Limited (KBL)
		FOURESS Engineering (India) Limited.
		Durga Valves Pvt.Ltd
		Orbinox
		શ્રી કિલોસ્કાર બ્રાધર્સ લિમિટેડ
5	Expansion Bellows	Precise Engineers
6	Dewatering (Drain) Pump(Submersible/ Horizontal)	KSB Pumps
		Kirloskar Brothers Limited (KBL)
		JASCO
		Crompton Greaves Ltd
		La Gajjar Machinery Pvt Ltd.
		Pullen Pumps Industries Pvt. Ltd.
		MBH
7	Sluice Valves and Sluice Gate	Kirloskar Brothers Limited (KBL)
		DURGA Valves Pvt.Ltd
		L & T Valves
		Jupiter
		SACHDEVA

Sr. No.	Description	Name of Manufacturer
8	UPVC Pipe	Supreme Industries Ltd., Mumbai
		Dutron Polymers Ltd
		Parixit Industries Ltd., A'bad
		Jain Irrigation Systems Ltd., Jalgaon
9	HDPE Pipe	Parixit Industries Ltd., A'bad
		Jain Irrigation Systems Ltd., Jalgaon
		Dutron Polymers Ltd
		Jindal
		Essar Steel
10	C.I. Pipe	Electro Steel, Kejriwal, Oriental Castings, BIC, Jindal, Lanco Industries Ltd., Chennai, Kesins
13	EOT Crane	Grip Engineering Pvt. Ltd., JAPS Project, Brady & Morris Engineering Co. Ltd., Techno Industries
14	Cable & Wires	KEI Industries Ltd.
		Polycab Wires Pvt. Ltd.
		Aerolex Cables Pvt. Ltd.
		Allwin Industries
		Finolex Cables
		L&T Cables
		ULTRA CAB (India) Limited
15	Transformer	Atlanta Electricals Pvt. Ltd.
		Powerlite Electricals
		Voltamp Transformers Ltd.
		SKP Transformers
		Arya Electronics
16	Components for MCC :	
	Switch	L&T, Siemens
	HRC Fuse	L&T, Siemens
	Timer	L&T, Siemens
	Relay	L&T, Siemens
	Push Button Stations	L&T, Siemens
	Indicating Lamp	L&T, Siemens
	Cable Jointing Kit	CCI, M. Seal
	MCB/DB's	MDS, Siemens, Indokupp
17	Capacitors	L&T, Crompton, Khatau Note: Capacitors shall be oil fill type
18	KWH Meter	Simco, Jaipur, GEC
19	Light Fittings: (Indoor & Outdoor Luminaries)	Philips, Crompton, Bajaj, NESSA Illumination
20	Exhaust Fans	Crompton, Bajaj,
21	Ceiling Fans	Crompton, Bajaj, Havells
22	Air Blowers	Everest Ltd.
		Swan Pneumatics (P) Ltd
23	Alum Dosing Pumps	Asia LMI
		VK Pumps
		Swelore
24	Pressure Gauges	General Instruments
		Bells Control
		H. Guru Marketing
25	Level Gauge / Indicator	R K Dutt

Sr. No.	Description	Name of Manufacturer
		Levecon
		S. B. Electromec
26	Clarifier Equipment	Enviro Control Associates
		Voltas Ltd
		Hindustan Dorr-Oliver
		Geomiller/Triveni
27	Chlorination System	Industrial Device (I) Pvt. Ltd
		Metito
		Chloroequip
		Pennwalt
28	Gear Box	Greaves
		Radicon
		Elecon
		Shanti
29	Level Switches	Level-Tech
		Revathi Electronics
		Levec
30	Refrigerator	LG, Samsung, Kelvinator
31	PVC Pipes for Fluid	Finolex, Jain Irrigation
32	PVC Conduits for Electricals	Precision, Shakti
33	Butterfly Valve	KIRLOSKAR Brothers Limited(KBL), DURGA valves Pvt Ltd, L & T valves, R&D MULTIPLE, Jupiter, श्री कृष्णा एन्जिनीयर्स IVC, IVI, Audco, R & D multiple, Jupiter, Cair, Orbit Engineers
34	Check Valve (Dual Plate check Valve)	KIRLOSKAR Brothers Limited(KBL), DURGA valves Pvt Ltd, Orbinox, R&D MULTIPLE, Orbit Engineers
35	Metallic Expansion Bellow	Beloflex(B.D. Engineers), Stanfab Engineering Pvt. Ltd., D. Wren Engineering Pvt. Ltd., Sur Industries,
36	Centrifugal / Centrifugal Non Clog Pumps	Beacon Weir, KSB, Mather & Platt (Wilo), Worthington, WPIL, Xylem pumps , Grundfos Pumps Pvt. Ltd., MBH, JASCO
37	Submersible non Clog Pumps / Submersible Centrifugal Pumps	Kirlosker, KSB, ABS, ITT- Flyght, Xylem pumps, Grundfos Pumps Pvt. Ltd. , MBH, JASCO, AQUA, Jyoti, PULLEN PUMPS, Alpha, Het Pump
38	Screw Pump	Roto, Netzsch, Tushaco, Seepex
39	Metering / Dosing Pumps	Swellore, V.K. Pumps, Shapotools
40	Non Return Valves (Single / multi door) / Dual Plate Check Valves	Kirlosker, IVC, IVI, R & D multiple, Durga, Jupiter, Cair, Orbit Engineers
41	Knife Gate valves	Jash, Fouess, Vass (Dezurick), Vag, Orbinox, Orbit Engineers
42	Sluice gates / open Chanel Gates	Jash Engineering, IVC, R & D Multiple, Jupiter
43	Mechanical Fine Screens – Step (Mat) Type / Drum Type	Jash, Huber, Johnson, Savi, Italy, Apollo Screens

Sr. No.	Description	Name of Manufacturer
44	Mechanical Course bar Screen	Jash, Huber, Johnson, HDO, Triveni, Savi, Italy
45	Manual Bar Screen	Jash, Japs, HDO, Triveni, Auric
46	Grit mechanism	EIMCO – KCP, Hindustan Dorr – Oliver, Jash-Shivpad, Triveni, Voltas
47	Diffused Aeration System	EDI, OTT, Rehau
48	Air Blower	Kay, Swam, Everest, Usha Compressors, Gardner Denver
49	Agitator / mixer	Remi, Schurtek, Fibre & Fibre, Milton Roy
50	Gear Boxes	Greaves, Elecon, CPEC, PEPL, Bonfiglioli
51	Centrifuge	Humboldt, Alpha Laval, Hiller
52	HDPE Pipes	Astral, Dutron, Duraline, Narmada, RIL (PIL), Penwalt, Anjney, Jain Irrigation, Sangir
53	Air Compressor	Ingersoll – Rand, Khosla, Kirlosker, CPE, Alpha
54	Bearing For All Equipments	SKF, FAG, Tata
55	Fasteners	Precision, Durakhanawala, Echjay, Tata, Sundaram
56	Mechanical Seals	Eagle Seals (Sealol), Durametallic, Burgman
57	Electric Actuator	Auma, Rotork, Emerson, Pentair
58	(1) CATEGORY III Indoor LED fittings, LED Panel light, LED down light, outdoor LED light (street light, LED flood light, LED Post top lantern, LED bollard) (2) Solar LED Light	NESSA ILLUMINATION TECHNOLOGIES PVT.LTD., Litsun, Nextray
59	STREET LIGHT POLES	AMBICA POLES (for octagonal poles, swage poles, street light poles, high mast poles, decorative poles, conical poles, JETCOTECH Engineering LLP
60	Resilient Seated Slice Valve	Cair
61	Air Valve	Cair, Orbit Engineers
62	Flow Control valve	Cair
63	Altitude Control valve	Cair, Orbit Engineers
64	Pressure reducing valve	Orbit Engineers
65	Pressure relief valve	Orbit Engineers
66	Ball valve	Orbit Engineers
67	Mast pole	JETCOTECH Engineering LLP
68	Earthing material	JETCOTECH Engineering LLP
69	Hot dip galvanizing	JETCOTECH Engineering LLP
70	LED Highbay	Litsun

(C) LIST OF APPROVED VENDOR FOR INSTRUMENTATION SYSTEM

SR NO	DESCRIPTION	Name Of Manufacturer
1	Electromagnetic Flow Meter	E+H, Siemens, Abb, Fuji, Yokogawa, Krohne-Marshall, AAROHI Embedded System Pvt Ltd., Emerson, SBEM
2	Pressure Gauges	Wika, H.Guru, General Instruments Consortium Manometer (India) P. Ltd. , Baumer, Waaree
3	Pressure Switch	Danfoss , Indfoss , Switzer
4	Process Analyzers (pH, DO, Free / Residual Chlorine , BOD / COD)	E+H , Emerson , Hach , Chemitech , Polymetron, Wtw (Forbes Marshall),Yokogawa
5	Ultrasonic transmitter level / diff. level / flow	E+H, Siemens – Milltronics, Krohne, Vega
6	Hydraulic level transmitter	E+H,Siemens, ABB, Forbes- Marshall, Emerson, SBEM
7	Displacer/Float Switches	Levcon, Nivo, Toshbro, Pune Techtrol , SBEM
8	PP Float / Buoyancy switch	Pepprl + Fuchs, Baumer, Waaree, E+H , Pune Techtrol , SBEM
9	Float & Board Type Level Gauge	Levcon, Nivo, Toshbro, Pune Techtrol, SBEM
10	Electromagnetic Flow Meter	E+H, Siemens, ABB, Fuji, Yokogawa, Krohne-Marshall
11	Field Transmitter (P, DP,F, L , T)	ABB, Fuji, Yokogawa, Honeywell, Emerson
12	Pressure Gauges	Wika, H.Guru, General Instruments Consortium Manometer (India) P. Ltd., Baumer, Waaree
13	Panel Mounted Process Indicator & Flow Integrator	Masibus, Nishko, Nivam, Selectron, Radix, Yokogawa, ABB
14	Pressure Switch	Danfoss, Indfoss, Switzer
15	Programmable Logic Controllers	Rockwell (Allen Bradeley), Siemens, Schneider, Fuji, ABB, GE Fanuc
16	Control Panel Enclosure	Rittal, Enklotek, Bartakke, BCH, Eldon
17	Alarm Annunciator	Aplab Ltd., Minilec , IIC
18	Solenoid valves	Asco, Rotex, Schrader
19	Tube Fitting	Excel Hydropneumatic, Multimetel, Placka

20	Instrument Valves , Manifolds	Aptek, Anmol (Superlok), Excel Hydropneumatic, General
21	Fitting	Instrument Consortium , Multimetal, Technomatic, Placka
22	Pneum , Brass Fitting	Swagelok, Multimetal Industries, SMC, Festo
23	Control Panel Accessories / Components	
a.	Miniature Relay	Wago, Omron,Phoenix, Rockwell
b.	Indication Pilot Lamps (LED Type)	Teknic, Schneider, Siemens
c.	Push Button / Selector Switch (with NO/NC Elements)	Teknic, Schneider, Siemens
d.	DC Power Supplies (DIN Rail mounted)	Phoenix, Omron, Schneider, Rockwell
e.	Terminals	Elmex, Phoenix, Wago, Connectwell
f.	Panel Wires	Finolex , Havell's , R R Kabel
g.	Panel Illumination	Philips , Crompton , GE
24	Instrument Cables (Power , Signal , Control)	Associated Cables, Associated Flexible and Wires P.Ltd., Brooks Cables, Thermo Cables, Udey Pyro
25	Cable Glands	Ex- protecta, Braco, Sudhir, Comet, Connectwell
26	Junction Box	Ex- protecta, CEAG, Sudhir, Baliga, FCG
27	Cable Tray	M.M.Engineering, Globe, Jacinth, Equi. Reputed, JETCOTECH Engineering LLP
28	Computer System	HP-Compaq, Dell, IBM, Sony, Samsung
29	UPS	Hirel-Hitachi, Emerson, APC
30	<ol style="list-style-type: none"> 1. PLC (Programmable Logic Controller) 2. SCADA (Supervisory Control and Data acquisition) 3. VFD (Variable Frequency Drive Up to 500 KW) 4. ACB (Air Circuit Breaker up to 	MITSUBISHI ELECTRIC INDIA PRIVATE LIMITED, Emerald House, EL-3, J Block, M.I.D.C., Bhosari, Pune 411026

	<p>6000A)</p> <p>5. MCCB (Moulded Case Circuit Breaker up to – 1600 A)</p> <p>6. MCB (Miniature Circuit Breaker up to – 63 A)</p> <p>7. ELCB (Earth Leakage Moulded Case Circuit Breaker up to 1600 A)</p> <p>8. Contractor up to – 800 A & OLR (Over load Relay) up to 630 A</p> <p>9. Multi Functional Meters</p> <p>10. MPCB (Motor Protection Circuit Breaker up to 32 A)</p>	
--	---	--

**(D) LIST OF APPROVED VENDORS FOR MATERIALS RELATED TO WATER
SUPPLY AND SEWERAGE NETWORK**

SR. NO.	ITEMS	NAME OF AGENCIES
1	A C Pressure pipe MAZZA process	Lotus, Kirti
2	A C Pressure pipe MEGHNANI process	Lotus, Kirti, Hindustan
3	Sluice Valve	Durga, kartar, Kirloskar, Jupiter, SACHDEVA (C.I. & D.I.), શ્રી કિર્તિ ઇન્જિનીયર્સ, Cair, Orbit Engineers
4	DI Pipe	Electrotherm (I) Ltd.,Ahmedabad, Lanco Industries Ltd.,Chennai, Electrsteel, Jindal Saw Ltd.,Ahmedabad, Kesins, Welspun
5	R.C.C. PIPE (COLLAR JOINT & SOCKET SPIGOT JOINT) CLASS NP3 & NP4, & R.C.C. COLLARS	VIPUL SPUN PIPES (SIHOR & LATHIDAD,BOTAD), KATARIYA & CO. (DHASSA), OMKARESHVAR PIPES (NAVAGAAM), OMKAR PIPES (LATHIDAD, BOTAD), MARUTI PIPES (BAGODARA ,AHMEDABAD), KALATHIYA PIPES(BAGODARA ,AHMEDABAD), R. S. PIPES (BODELI), UMA HUME PIPES (KALOL, GANDHINAGAR), SIDHDHIVINAYAK (KARDEJ ,BHAVNAGAR)
6	R.C.C. MACHINEOLE FRAME & COVER, INLET FRAME COVER 10T.(600*450 MM.) , 20T.,35T., & 50T.	SONI CEMENT PRODUCT , VIPUL SPUN PIPES, KATARIYA & CO., OMKARESHVAR PIPES, OMKAR PIPES, MARUTI PIPES, KALATHIYA PIPES , R. S. PIPES, UMA HUME PIPES, SIDHDHIVINAYAK , S.K. Corporation, Laxmi Price Industries, S.J.Corporation, Sardar pre cast

7	Stone ware PipeManufacturer having BIS Certificate for ISI marking	Krishna Pipe, j.K. Pipe, Taya ceramic, Burn & co., perfect Potteries, Navroji Vakil, Kashmira
8	D.I. & C.I. FITTINGS	RG BRAND, ESSEM Engineering Industries, Bikaners Engineers works
9	CID Joints	ESSEM Engineering Industries
10	Valves & Graded Castings	ESSEM Engineering Industries
11	Pipe Fittings	ESSEM Engineering Industries, Bikaners Engineers works
12	CI/DI/MS graded castings	Bikaners Engineers works
13	Scraper machine hole	Sardar Pre cast

Note: The vendor list changes from time to time. The vendor list of that time has to be followed during the work. Any material not as per the prescribed specification and included in the vendor list shall be rejected and action taken to remove such material from the vendor list.

રસ્તા, પુલો તથા મકાનોના બાંધકામની વિગતો તથા
સ્પેશીફિકેશન અંગેના કામના સ્થળ પર બોર્ડ મુકવા બાબત.

ગુજરાત સરકાર
જાહેર બાંધકામ વિભાગ
પરિપત્ર ક્રમાંક બીડીજી/૩૨૭૭/(૧૬૫૭)સ
સચિવાલય, ગાંધીનગર.
તા. ૨૬/૪/૧૯૭૮

પરિપત્ર:-

જાહેર બાંધકામ વિભાગ મારફત થતાં રસ્તા, પુલો તથા મકાનોના બાંધકામની વિગતો તથા સ્પેશીફિકેશનની માહિતી જાહેર જનતાને જે તે કામના સ્થળ ઉપર આ માટે મળી શકે તેથી જાહેર જનતા તે અંગે યોગ્ય સુચનો કરી શકે. તે માટે કામ સાઈટ ઉપર સરળ ભાષામાં બોર્ડ મુકવા અંગેની બાબત સરકારશ્રીની વિચારણામાં હતી. સરકારે આ અંગે યોગ્ય વિચારણા કરી ઠરાવેલ છે કે આ વિભાગ તરફથી કરવામાં આવતાં રસ્તા, પેલો તથા મકાનોના કામો માટેની નીચે જણાવ્યા મુજબની વિગતો દર્શાવતા બોર્ડ કામના સ્થળ ઉપર જાહેર જનતાની જાણ માટે મુકવા :-

જાહેર વિજ્ઞપ્તિ

આ રસ્તાનું / પુલનું મકાનનું કામ ગુજરાત રાજ્યના જાહેર
બાંધકામ વિભાગ હેઠળના વિભાગ હેઠળ
..... પેટાવિભાગ હસ્તક ચાલે છે.

આ કામના સામાન્ય સ્પેશીફિકેશન નીચે પ્રમાણે છે.

૧. રસ્તા અંગેના સ્પેશીફિકેશન :-
ઓવરસાઈઝ મેટલનું સે.મી. દર્શાવેલ જાડો થર
૨. મેટલ સે.મી. દર્શાવેલ જાડો થર.
૩. પેટીનું નામ સે.મી.નું ભરવામાં આવે છે.

(૨) પુલનું કામ :-

૧. પુલના ગાળા દરેક મીટર લંબાઈનો
૨. પીયર કેપનું ક્રોક્કીટ ૧:૨:૪ ના પ્રમાણમાં.
૩. સ્લેબનું ક્રોક્કીટ ૧:૨:૪ હાઈગ્રેડ કે વીલીટી કન્ટ્રોલ ૧૫૦ કે ૨૦૦ એમએમ.
૪. પુલના પાયાનો ક્રોક્કીટ ૧:૩:૬ ના પ્રમાણમાં થાંભલા અને એબટમેન્ટનું ક્રોક્કીટન ૧:૩:૬ ના પ્રમાણમાં.

(૩) મકાનો :-

૧. પાયાનું ક્રીકીટ પત્થરનું ૧:૩:૬ નું

૨. ઈટોનું ચણતર અને ૧ અને ૬નું પ્રમાણ

૩. ભોંયતળીયુ ૧:૨:૩ નું ચુનાનું ક્રીકીટ કે ૧:૪:૭ સીમેન્ટનો ક્રીકીટ ઉપર ૧ ઈંચ સાઈઝની મોઝેક ટાઈલ્સ.

૪. બારી બારણા સાગી લાકડાના.

૫. આર.સી.સી.કામ ૧:૨:૪ કે ૧૫૦ એમ.કે. ૨૦૦૦ એમ.નું

આ કામની વિગતે સ્પેશીફિકેશન નાયબ ઈજનેરશ્રી પેટા વિભાગની કચેરીએ ઓફીસના સમય દરમ્યાન કોઈપણ સમયે જોઈ શકાશે.

તો માહિતી માટે તે અધિકારીનો સંપર્ક સાંધવો.

આ કામની માહિકી જાહેર જનતાની છે અને કામમાં જોઈ ક્ષતિ કે અનિયમિતતા જણાય તો તે બાબતમાં જાહેર બાંધકામ વિભાગના અધિક્ષક ઈજનેરશ્રી જેની કચેરી સ્થળે છે તેમનું ધ્યાન કરવા વિનંતી છે.

કાર્યપાલક ઈજનેર
માર્ગ અને મકાન વિભાગ

રસ્તા, પુલો તથા મકાનોના બાંધકામની વિગતો તથા
સ્પેશીફિકેશન અંગેના કામના સ્થળ પર બોર્ડ મુકવા બાબત.

ગુજરાત સરકાર
માર્ગ અને મકાન વિભાગ
ઠરાવ ક્રમાંક ટીએનસી/૧૦૯૨/૨૧/સ
સચિવાલય, ગાંધીનગર.
તા. ૧૮/૧૧/૧૯૯૧

સંદર્ભ: સરકારશ્રીની સરખા ક્રમાંકની તા. ૨૦/૧૨/૯૦ નો ઠરાવ.

આમુખ: રસ્તા, પુલો તથા મકાનોના બાંધકામની વિગતો તથા સ્પેશીફિકેશન અંગેના કામના સ્થળ પર બોર્ડ મુકવા અંગેની બાબત
સરકારશ્રીની વિચારણા હેઠળ હતી.

ઠ રા વ :-

પુખ્ત વિચારણાને અંતે આથી ઠરાવવામાં આવે છે કે, રસ્તા, પુલો મકાનો વર્કઓર્ડર મળ્યા પછી તુર્તજ કામના સ્થળે
કરવાના કામના સ્પેશીફિકેશન અંગેનું બોર્ડ કોન્ટ્રાક્ટરે પોતાના ખર્ચે મુકવાના રહેશે.

ઉપરોક્ત શરત ટેન્ડરના ભાગ તરીકે ગણવાની રહેશે અને ટેન્ડરમાં તેનો સમાવેશ કરવાનો રહેશે.

આ હુકમોનો અમલ હુકમો રવાના થયાના તારીખથી કરવાનો રહેશે.

આ હુકમો આ વિભાગના સરખા ક્રમાંકની ફાઈલ પર નાણાં સલાહકારશ્રીની તા. ૧૧/૯/૯૧ ના મળેલ સંમતિથી બહાર
પાડવામાં આવેલ છે. આ હુકમો માર્ગ અને મકાન વિભાગના બધા જ કામોને લાયુ પડશે.

ગુજરાતના રાજ્યપાલશ્રીના હુકમથી અને તેમના નામે,

(એ. જે. દોશી)
નાયબ સચિવ
માર્ગ અને મકાન વિભાગ

રસ્તા પુલો તથા મકાનો બાંધકામની વિગતો તથા સ્પેશીફીકેશન અંગેના કામના સ્થળ પર બોર્ડ મુકવા બાબત.

ગુજરાત સરકાર
માર્ગ અને મકાન વિભાગ
ઠરાવ ક્રમાંક ટીએનસી/૧૦૮૦/૨૪/સ
સચિવાલય, ગાંધીનગર.
તા. ૨૭/૧૧/૧૯૯૦

સંદર્ભ: જા.બાં.વિ.ના પરિપત્ર ક્રમાંક બીકે/૩૨૭૭/(૧૬૫)ન, તા. ૨૬/૪/૭૮

ઠ રા વ :-

રસ્તા, પુલો તથા મકાનોના બાંધકામની વિગતો તથા સ્પેશીફીકેશન અંગેના કામના સ્થળ ઉપર બોર્ડ મુકવા અંગેની સંદર્ભમાં દર્શાવેલ પરિપત્રથી જરૂરી સુચનાઓ આપવામાં આવેલ છે. આવા કામની વિગત દર્શાવતા બોર્ડ મુકવા અંગેનો ખર્ચ વિભાગ તરફથી કરવામાં આવતો હતો. કામ પુર્ણ થયા બાદ આવા બોર્ડ બીન જરૂરી પડી રહેતા હતા. આવો ખર્ચ નિવારવાની બાબત સરકારશ્રીની વિચારણામાં હતી. પુર્નવિચારણા અંગે આથી ઠરાવવામાં આવે છે કે જ્યારે રસ્તા / પુલ / મકાનનું કામ હાથ ધરવાનું નક્કી કરવામાં આવે ત્યારે આવું બોર્ડ કામ રાખનાર ઠેકેદારે તેમના ખર્ચે મુકવાનું રહેશે. કામ ચાલુ કરવાનો હુકમ આપવામાં આવે તે પહેલા આ બાબતની જરૂરી સંમતિ સંબંધીત ઈજારદાર પાસેથી લેખિતમાં મેળવી લેવી. તેમજ કોન્ટ્રાક્ટ ધ્વારા આવું બોર્ડ મુકવામાં આવે તે અંગે પુરતી કાળજી રાખવી.

આ હુકમો આ વિભાગની સરખા ક્રમાંકની ફાઈલ ઉપર નાણાંકીય સલાહકારશ્રીની તા. ૧૫/૨/૯૧ ની નોંધથી મળેલ સંમતિથી બહાર પાડવામાં આવેલ છે.

ગુજરાતના રાજ્યપાલશ્રીના હુકમથી અને તેમના નામે,

(પ્ર. ર. ચોકસી)
ખાસ ફરજ પરના અધિકારી
માર્ગ અને મકાન વિભાગ

ક્રમાંક : ૫૨૪-૬૧૦૪-૨૨૨ રેઈટ-ડીટીપી-૩૯૭૧-ન,

ગુજરાત સરકાર
માર્ગે અને મકાન વિભાગ,
બ્લોક નં. ૧૪/૨, સરદારભવન,
સચિવાલય, ગાંધીનગર
તા. ૨૯-૦૭-૨૦૦૪

પ્રતિ,
અધિક્ષક ઈજનેરશ્રી (સર્વે),
રાજ્ય વિભાગ,

વિષય :- ટેન્ડરમાં સ્ટાર રેઈટ તથા ડી.ટી.પી. મંજૂરીના માસ અને વર્ષે દર્શાવવા બાબત.

સંદર્ભ :- ઠરાવ ક્રમાંક ટીએનસી - ૧૦૮૯/૪-સી, તા. ૩૧-૦૮-૧૯૯૧.

જે ટેન્ડરમાં સીમેન્ટ / સ્ટીલ ઈજારદારે ખરીદવાનો હોય અને તેઓને આ માલસામાનના ભાવો તથા ટેન્ડરમાં દર્શાવેલ સ્ટાર રેઈટના ભાવોનો તફાવત સરભર કરી આપવાનો હોય તેવા ટેન્ડરમાં આ માલસામાનના સ્ટાર રેઈટની જોગવાઈ નીચે મુજબ કરવાની ટેન્ડરના કલોઝ પલ A માં જોગવાઈ છે.

૧. જે માસ તથા વર્ષમાં ડી.ટી.પી. મંજૂર થયા હોય તે માસ અને વર્ષે કોરા ટેન્ડર ઈસ્યુ કરતી વખતે તેમાં દર્શાવવાના રહેશે.
૨. સીમેન્ટ માટેના ભાવો જે માસમાં ડી.ટી.પી. માં મંજૂર થયું હોય તે માસના અધિકત વિક્રેતા પાસેથી મેળવી કોરા ટેન્ડર ઈસ્યુ કરતી વખતે તેમાં દર્શાવવાના રહેશે.
૩. સ્ટીલ તથા એચ.વાય.એસ.ડી.બાર માટે સેઈલ કંપની માંથી જે માસમાં ડી.ટી.પી. મંજૂર થયું હોય તે માસનો ભાવ મેળવી કોરા ટેન્ડર ઈસ્યુ કરતી વખતે તેમાં દર્શાવવાનો રહેશે.
- ૨/- એવું જણાય છે કે આ જોગવાઈનો યુક્ત પછે અમલ થતો નથી અને સ્ટાર રેઈટમાં વિવિધ વિભાગો ધ્વારા એક સુત્રતા જળવાતી નથી.
- ૩/- આથી સર્વેને આજ્ઞાનુસાર સુચના આપવામાં આવે છે કે કોરા ટેન્ડર પેપર્સ ઈસ્યુ કરતી વખતે આ જોગવાઈ મુજબના ભાવો અને ડી.ટી.પી. મંજૂર થયાનું માસ, વર્ષે અવશ્ય દર્શાવવા ટેન્ડરો મંજૂર કરવા દરખાસ્ત કરવામાં આવે ત્યારે આ દરખાસ્તમાં, દર્શાવેલ સ્ટાર રેઈટ અંગેના આધાર / પુરાવા રજૂ કરવા અને આ જોગવાઈ મુજબ જ ટેન્ડર પેપર્સમાં ભાવો દર્શાવેલ છે તે મતલબનું કા.ઈ.શ્રી.નું પ્રમાણપત્ર પણ રજૂ કરવું. વધુમાં આ સ્ટાર રેઈટ અને અંદાજી ભાવોના, ભાવ તફાવતને કારણે ટેન્ડરની અંદાજી રકમ સંબંધે ઈચા / નીચાની પરિસ્થિતિ પણ ટેન્ડર મંજૂરીની દરખાસ્તમાં અવશ્ય કરવી.
- ૪/- આ સુચનાઓનો યુક્તપછે અમલ કરવા વિનંતી છે અને આ અંગેની યુક્તની ગંભીર નોંધ લેવામાં આવશે તેની નોંધ લેવા વિનંતી છે.

(સં. મ. ભટ્ટ)
ઉપસચિવ (મકાનો)
માર્ગે અને મકાન વિભાગ.

નકલ રવાના :
સર્વે કાર્યપાલક ઈજનેરશ્રી,
રાજ્ય વિભાગ,

**રાજ્ય સરકારના બાંધકામ માટે વપરાતા ગૌણ
ખનીજની રોયલ્ટી ભરવા બાબત.**

ગુજરાત સરકાર
ઉદ્યોગ અને ખાણ વિભાગ.
ઠરાવ ક્રમાંક : એમએમઆર/૧૧૨૦૦૦/૨૦૧૩/છ
સચિવાલય, ગાંધીનગર
તારીખ :- ૧-૯-૨૦૦૪

વંચાણે લીધા :-

- (૧) ઉદ્યોગ ખાણ અને ઉર્જા વિભાગનો ઠરાવ ક્રમાંક : એમસીઆર- ૨૧૬૮-૭૩૮૦-છ તા.૧૨/૧૨/૧૯૬૯
- (૨) ઉદ્યોગ ખાણ અને ઉર્જા વિભાગનો ઠરાવ ક્રમાંક : એમસીઆર- ૨૧૬૮-૮-૬૬૮૫-છ તા.૧/૧/૧૯૮૭
- (૩) ઉદ્યોગ ખાણ અને ઉર્જા વિભાગનો ઠરાવ ક્રમાંક : એમસીઆર- ૨૧૮૮-(૮)૬૫-છ તા.૨૫/૧/૧૯૯૧
- (૪) ઉદ્યોગ અને ખાણ વિભાગનો ઠરાવ ક્રમાંક:એમસીઆર-૧૦૯૭-૨૮૫૬-છ, તા.૬/૧૧/૧૯૯૭
- (૫) માન.મુખ્યમંત્રીશ્રીના અધ્યક્ષપણા હેઠળ યોજાયેલ એમ્પ્રાવર્ડ કમીટીની તા.૧૮/૬/૨૦૦૪ ની બેઠકની કાર્યવાહી નોંધ.

ઠરાવ :-

ઉદ્યોગ, ખાણ અને ઉર્જા વિભાગના સંદર્ભ - (૩) હેઠળના ઠરાવથી એવી જોગવાઈ કરવામાં આવેલ કે રાજ્ય સરકારના , પંચાયતોના અને સરદાર સરોવર નમોદા નિગમના બાંધવામાં આવતાં રસ્તાઓના કે સિંચાઈ વગેરેના કામો માટે જ્યારે સાદી માટી (ઓર્ડીનરી ક્લે-અર્થ) અને (સોફ્ટ) મુરમ વાપરવામાં આવે ત્યારે ગુજરાત ગૌણ ખનિજ નિયમ , ૧૯૬૬ મુજબ રોયલ્ટી લેવાના નિયમો લાગુ પડશે નહીં. એટલે કે આ કામો માટે કોન્ટ્રાક્ટરો પાસે સાદી માટી (ઓર્ડીનરી ક્લે- અર્થ) અને (સોફ્ટ) મુરમ માટે રોયલ્ટી લેવાથી થશે નહીં તથા સંદર્ભ- (૪) હેઠળના વિભાગના તા.૬/૧૧/૯૭ ના ઠરાવથી ગુજરાત વિદ્યુતબોર્ડ દ્વારા હાથ ધરવામાં આવતાં કામો માટે પણ ઉપર મુજબ રોયલ્ટી મુક્તિનો લાભ આપવામાં આવેલ.

ઉપરોક્ત જોગવાઈના કારણે રાજ્યમાં ગેરકાયદેસર રીતે આ ખનીજોનો વપરાશ થતો હોવાનું જણાયેલ છે. જેના પરિણામે રાજ્ય સરકારે રોયલ્ટીની આવક ગુમાવવી પડે છે માટે ઉપરોક્ત હુકમોની જોગવાઈની સમીક્ષા કરી તે દૂર કરવાની બાબત સરકારશ્રીની વિચારણા હેઠળ હતી. તા.૧૮/૬/૨૦૦૪ ના રોજ માન.મુખ્યમંત્રીશ્રીના અધ્યક્ષપણા હેઠળ

યોજાયેલ એમ્પ્રાવર્ડ કમીટીની બેઠકમાં નક્કી થયા મુજબ સંદર્ભ-૩ તથા સંદર્ભ-૪ હેઠળના વિભાગના તા.૨૫/૧/૯૧ તથા તા.૬/૧૧/૯૭ ના ઠરાવો આથી રદ કરવામાં આવે છે.

ગુજરાતના રાજ્યપાલશ્રીના હુકમથી અને તેમના નામે.

(આર.બી.વ્યાસ)
નાય.બ સચિવ
ઉદ્યોગ અને ખાણ વિભાગ

ગુજરાત સરકાર
માર્ગ અને મકાન વિભાગ
પરિપત્ર ક્રમાંક : ટીએનસી-૧૦-૨૦૦૨-(૧૪)-સ,
સચિવાલય, ગાંધીનગર
તારીખ :- ૨૭-૪-૨૦૦૫

વિષય :- રાજ્ય સરકારના બાંધકામ માટે વપરાતા ગૌણ ખનિજની રોયલ્ટી ભરવા બાબત.
સંદર્ભ :- ઉદ્યોગ અને ખાણ વિભાગનો ઠરાવ ક્રમાંક : એમએમઆર-૧૧૨૦૦૦-૨૦૧૩-૧૭, તા.૧-૯-૨૦૦૪

પરિપત્ર :-

ઉદ્યોગ, ખાણ અને ઉજ્જૉ વિભાગના તા.૨૫-૧-૯૧ ના ઠરાવ ક્રમાંક : એમસીઆર-૨૧૮૮-(૮) -૬૫-૧૭ અન્વયે રાજ્ય સરકારના, પંચાયતના અને સરદાર સરોવર નમૅદા નિગમના બાંધવામાં આવતાં રસ્તાઓના કે સિંચાઈ વગેરેના કામો માટે જ્યારે સાદી માટી (ઓડીનરી કલે-અર્થ) અને (સોફ્ટ) મુરમ વાપરવામાં આવે ત્યારે ગુજરાત ગૌણ ખનિજ નિયમ-૧૯૬૬ મુજબ રોયલ્ટી લેવાનો નિયમ લાગુ પડશે નહીં. એટલે કે આ કામો માટે કોન્ટ્રાક્ટરો પાસે સાદી માટી (ઓડીનરી કલે -અર્થ) અને (સોફ્ટ)મુરમ માટે રોયલ્ટી લેવાની થશે નહીં તેવી જોગવાઈ કરવામાં આવેલ. હવે ઉપર સંદર્ભમાં દર્શાવેલ ઉદ્યોગ અને ખાણ વિભાગના તા.૧-૯-૨૦૦૪ ના ઠરાવથી તા. ૨૫-૧-૯૧ ના ઠરાવ રદ કરવામાં આવેલ છે.

આથી હવે બી-૧ ટેન્ડર ફોર્મ માં ખંડ - ૩૬ અને બી-૨ ટેન્ડર ફોર્મમાં ખંડ-૩૫ માં નીચે મુજબ સુધારો કરવામાં આવે છે.

રાજ્ય સરકારના બાંધકામ માટે વપરાતા ગૌણ ખનિજની રોયલ્ટી બાબત.

(૧) તા.૧-૩-૯૧ ના ઠરાવ મુજબ મુરમ સિવાયના

અન્ય સુધીના શબ્દો રદ કરી ફક્ત નીચે મુજબ જોગવાઈ અમલમાં રહેશે.

ગૌણ ખનિજ બાબતમાં રા.ગૌ.ખ.નિ.૧૯૬૬ અને તેના અનુસંધાનમાં વખતોવખત બહાર પાડવામાં આવેલ ઠરાવો લાગુ પડશે, અને તે મુજબ લીઝ કે પરમીટ લેવાનું અને રોયલ્ટી ભરવાની રહેશે.(ઉદ્યોગ અને ખાણ વિભાગ ઠરાવ ક્રમાંક એમએમઆર-૧૧-૨૦૦૦-૨૦૧૩-૧૭ તા.૧-૯-૦૪)

(અશોક પંડ્યા)
ઉપસચિવશ્રી,
માર્ગ અને મકાન વિભાગ

પ્રતિ,

સર્વે અધિક્ષક ઈજનેરશ્રી,

(મા.મ.વર્તુળો/ પંચાયત (મા.મ.)વર્તુળો/ એક્સપ્રેસ વે વર્તુળ / રાજ્ય માર્ગ યોજના વર્તુળ /
રાષ્ટ્રીય ધોરી માર્ગ વર્તુળો / પાટનગર યોજના વર્તુળ સહિત)

સર્વે કાર્યપાલક ઈજનેરશ્રીઓ (ઉપરોક્ત વર્તુળો હેઠળના તમામ વિભાગો સહિત)

નકલ રવાના :-

- ઉદ્યોગ અને ખાણ વિભાગ, સચિવાલય, ગાંધીનગર
- નમૅદા , જળસંપત્તિ , પાણી પુરવઠા અને કલ્પસર વિભાગ,સચિવાલય, ગાંધીનગર
- નિયામકશ્રી, ઈજનેરી સંશોધન સંસ્થા, વડોદરા
- નિયામકશ્રી, એન્જીનીયરીંગ સ્ટાફ કોલેજ, ગાંધીનગર
- મેનેજીંગ ડીરેક્ટરશ્રી, ગુજરાત રાજ્ય બાંધકામ નિગમ લી., ગાંધીનગર
- મેનેજીંગ ડીરેક્ટરશ્રી, ગુજરાત રાજ્ય માર્ગ વિકાસ નિગમ લી., ગાંધીનગર
- સર્વે તાંત્રિક અધિકારીશ્રીઓ (ના.કા.ઈ.સહિત) મા.મ.વિ.વિભાગ,સચિવાલય,
- સર્વે પ્રોજેક્ટ શાખાઓ, મા.મ.વિ.સચિવાલય,
- સીલેક્ટ કાઈલ.

મશીન ક્રશ્ડ સ્ટોન એગ્રીગેટના ફલેકીનેશ
અને ઈલોન્ગેશન ઈન્ડેક્સના સંયુક્ત ધોરણો
અપનાવવા બાબત.

ગુજરાત સરકાર
માર્ગ અને મકાન વિભાગ
પરિપત્ર ક્રમાંક - એસઓઆર. - ૧૦૨૦૦૬ / ૧૦૪ / સ. ૧
સચિવાલય, ગાંધીનગર.
તા. ૨૧/૧/૨૦૦૭

પ્રસ્તાવના :-

'મશીન ક્રશ્ડ સ્ટોન એગ્રીગેટ' એ બાંધકામમાં વપરાતું મુખ્ય મટીરીયલ્સ છે. આ 'મટીરીયલ્સ' માટેના ગુણવત્તાના વિવિધ ધોરણો પૈકીનો એક 'ફલેકીનેશ અને ઈલોન્ગેશન ઈન્ડેક્સ (સંયુક્ત)' છે જે મીનીસ્ટ્રી ઓફ રોડ ટ્રાન્સપોર્ટ એન્ડ હાઈવેઝ (MORT & H) દ્વારા પ્રકાશીત સ્પેશીફિકેશન ફોર રોડ એન્ડ બ્રીજ વર્કની ચોથી આવૃત્તિમાં દર્શાવ્યા અનુસાર ૩૦ % થી વધુ ન હોવો જોઈએ. જ્યારે અગાઉ મીનીસ્ટ્રી ઓફ સરકેઈસ ટ્રાન્સપોર્ટની બીજી આવૃત્તિમાં ફક્ત ફલેકીનેશ ઈન્ડેક્સનું ધોરણ વધુમાં વધુ ૩૫ % સુધીનું હતું. આમ સંશોધનો / અનુભવ તેમજ અર્થતંત્ર મશીનરીની ઉપલબ્ધીનો વ્યાપ / સરળતા તેમજ આર્થિક પાસાઓને ધ્યાને લઈને ગુણવત્તાનાં ધોરણોમાં પણ નવા સુધારા / વધારા કરવામાં આવે છે. અગાઉના ફલેકીનેશ ઈન્ડેક્સના ધોરણોમાં હવે ઈલોન્ગેશન ઈન્ડેક્સ પણ જોડી સંયુક્ત ધોરણ દાખલ કરવામાં આવેલ છે. પરંતુ હાલ ગુજરાત રાજ્યમાં આવેલ ક્રશર યુનિટો પૈકીના મોટા ભાગના યુનિટો પરંપરાગત પધ્ધતિથી કાર્યરત છે. તેમાંથી નવા સંયુક્ત ધોરણો પરિપુર્ણ કરે તેવો ઉત્પાદિત માલ મળી શકતો નથી. જે એક વ્યવહારીક મુશ્કેલી છે. પરંપરાગત પધ્ધતિનાં ક્રશરમાં આ પ્રકારની મુશ્કેલીઓ આવે છે. તે બાબતનો ઉલ્લેખ ટેકનીકલ જર્નલમાં પ્રસિધ્ધ થતા ટેકનીકલ પેપર્સમાં પણ થયેલ છે. આથી સંયુક્ત ધોરણો મેળવવા હાલના ક્રશર યુનિટોમાં સારા એવા પ્રમાણમાં સુધારા વધારા કરવા આવશ્યક બને તેમ છે. જેમાં વધારાનું નાણાંકીય રોકાણ પણ કરવું પડે તેમજ સમય પણ વ્યતિત થાય આથી ફલેકીનેશ તેમજ ઈલોન્ગેશન ઈન્ડેક્સના સંયુક્ત ધોરણોનો અમલ કરવા (ઈજારદારોને) પૂરતો સમય આપવો પણ જરૂરી છે. તે ધ્યાને લઈ નીચે મુજબની સૂચનાઓ આપવામાં આવે છે.

મીનીસ્ટ્રી ઓફ રોડ ટ્રાન્સપોર્ટ એન્ડ હાઈવેઝ દ્વારા સ્પેશીફિકેશન ફોર રોડ એન્ડ બ્રીજ વર્કની સને ૨૦૦૧ ની ચોથી આવૃત્તિ અનુસાર મશીન ક્રશ્ડ સ્ટોન એગ્રીગેટ માટે ફલેકીનેશ તેમજ ઈલોન્ગેશન સંયુક્ત ઈન્ડેક્સની મહત્તમ ૩૦ % ની મર્યાદાનું ધોરણ અપનાવવાનું નક્કી કરવામાં આવેલ છે.

માર્ગ અને મકાન વિભાગ હસ્તક ચાલતા કામોમાં પ્રવર્તમાન સ્પેશીફિકેશન પ્રમાણે ફલેકીનેશ અને ઈલોન્ગેશનના સંયુક્ત ઈન્ડેક્સની મહત્તમ મર્યાદા ૩૦ % રાખવામાં આવે છે.

ગુજરાત રાજ્યમાં મોટા ભાગના ક્રશીંગ યુનિટો ખાનગી માલિકીના છે અને તેમાં જરૂરી યાંત્રિક ફેરફારો કરવામાં આવે તો સંયુક્ત ઈન્ડેક્સના ધારાધોરણો જળવાઈ રહે તેવાં માલ મળી શકે.

ગુજરાત રાજ્યમાં ચાલતા ખાનગી ક્રશીંગ મશીનોમાં જરૂરી યાંત્રિક સુધારા વધારા તા.૩૦/૯/૦૭ સુધીમાં કરવામાં આવે તો જ તા.૧/૧૦/૦૭ પછીથી માર્ગ અને મકાન વિભાગના રસ્તાઓમાં વપરાતા એગ્રીગેટની ગુણવત્તા ધારાધોરણ મુજબની મળી રહે. આથી નીચે મુજબની સુચનાઓ આપવામાં આવે છે.

- (અ) માર્ગ અને મકાન વિભાગમાં ચાલતા કામોના ઈજારદારોએ જે તે ક્રશીંગ યુનિટોમાં જરૂરી યાંત્રિક સુધારા વધારા થઈ ગયેલ છે અને ધારા ધોરણ મુજબની ગુણવત્તાનાં એગ્રીગેટ મળી રહે છે તેવું પ્રમાણપત્ર અધિક્ષક ઈજનેરશ્રી (યાંત્રિક) અમદાવાદ મા.મ. વર્તુળ, અમદાવાદનું હોય તેની પાસેથી જ માલસમાન ખરીદ કરવાનો રહેશે. આ પ્રમાણિત થયેલ ક્રશીંગ યુનિટ સિવાયના કોઈપણ ક્રશર પાસેથી માલસમાન સપ્લાય ન થાય તેની કાળજી લેવાની રહેશે. અધિક્ષક ઈજનેરશ્રી (યાંત્રિક) દ્વારા સર્ટીફાઈડ ન થયેલ ક્રશીંગ યુનિટ પાસેથી આવેલ ધારાધોરણ વગરનો માલસમાન આઉટરાઈટ રીજેક્ટ કરવામાં આવશે.
- (બ) માર્ગ અને મકાન વિભાગના એસ.ઓ.આર. માં તથા અંદાજોમાં એગ્રીગેટના ભાવમાં જરૂરી સુધારા વધારા કરીને તા.૧/૧૦/૦૭ થી અમલમાં લાવવાના રહેશે.
- (ક) દરેક વિભાગીય કચેરીઓએ તેઓના તાબામાં જે જે ઈજારદારોની નોંધણી થયેલ છે તેઓને સદરહુ સુચનાઓ અમલ કરવા માટે લેખિત જાણ કરવાની રહેશે તથા ખાનગી ક્રશીંગ યુનિટોને પણ આની લેખિત જાણ કરવાની રહેશે. સદરહુ સુચનાના અમલ માટે ખાનગી ક્રશર યુનિટો તેમજ ઈજારદારો સાથે દરેક વિભાગીય કચેરીએ એક સંયુક્ત બેઠક કરીને સમજ આપવાની રહેશે જેથી તા.૧/૧૦/૦૭ પછી માર્ગ અને મકાન વિભાગ હસ્તક ચાલતા કોઈપણ કામોમાં ધારા ધોરણ મુજબની ગુણવત્તા સિવાયનો માલસમાન વાપરવામાં ન આવે તેની તકેદારી રાખવાની રહેશે.

ઉપરોક્ત સુચનાઓનો અમલ યુસ્તપણે કરવાનો રહેશે.

(એસ.એ.ભટ્ટ)
ઉપસચિવ મુ.મ.
માર્ગ અને મકાન વિભાગ.

મશીન ક્રશ્ડ સ્ટોન એગ્રીગેટના ફલેક્રીનેશ
અને ઈલોન્ગેશન ઈન્ડેક્સના સંયુક્ત ધોરણો
અપનાવવા બાબત.

ગુજરાત સરકાર
માર્ગ અને મકાન વિભાગ
પરિપત્ર ક્રમાંક - આરજીએન - ૧૦૨૦૦૬ - ૧૦૪ - સ.૧,
સચિવાલય, ગાંધીનગર.
તા. ૧૭/૧૦/૨૦૦૭

સંદર્ભ :- સરખા ક્રમાંકના પરિપત્ર તા.૨૫/૧/૨૦૦૭.

પ્રસ્તાવના :-

ગુજરાત સરકારશ્રીના માર્ગ અને મકાન વિભાગ દ્વારા સંદર્ભીત પરિપત્ર ક્રમાંક : એસ.ઓ.આર. ૧૦૨૦૦૬ / ૧૦૪ / સ.૧, તા.૨૫/૧/૨૦૦૭ થી બાંધકામમાં વપરાતા મશીન ક્રશ્ડ સ્ટોન એગ્રીગેટ માટે ફલેક્રીનેશ તેમજ ઈલોન્ગેશન સંયુક્ત ઈન્ડેક્સની મહત્તમ ૩૦% મર્યાદાનું ધોરણ અપનાવવાનું નક્કી થયેલ હતું. જે માટે ગુજરાત રાજ્યમાં ચાલતા ખાનગી ક્રશીંગ યુનીટોમાં જરૂરી તાંત્રિક સુધારા વધારા તા.૩૦/૯/૨૦૦૭ સુધીમાં કરવા અને તા.૧/૧/૨૦૦૭ પછી થી માર્ગ અને મકાન વિભાગના રસ્તાઓના કામ વપરાતા એગ્રીગેટ ધારા ધોરણ મુજબની ગુણવત્તા વાળો વાપરવામાં આવે તેમ જણાવેલ હતું.

ક્રશર યુનીટોમાં જરૂરી સુધારા વધારા સુચવેલ સમયગાળામાં થઈ શકેલ ન હોવાથી વારંવાર સમય મર્યાદા વધારવા માટેની રજુઆતો થયેલ હતી.

ઉપરોક્ત બાબતે સરકારશ્રી દ્વારા પુખ્ત વિચારણાને અંતે ક્રશીંગ યુનીટોમાં જરૂરી સુધારા વધારા કરવા માટેની અંતિમ તા.૩૦/૯/૨૦૦૭ ને બદલે તા.૩૧/૧૨/૦૮ કરવામાં આવેલ છે.

ઉપરોક્ત સુચનાઓનો અમલ ચુસ્તપણે કરવાનો રહેશે.

(એસ.એ. ભટ્ટ)
ઉપસચિવશ્રી (મુ.મ.)
માર્ગ અને મકાન વિભાગ.

નકલ રવાના :-

- સચિવશ્રી (મા.મ) ના . અંગત સચિવશ્રી, મા.મ. વિભાગ, સચિવાલય, ગાંધીનગર.
- સર્વે મુખ્ય ઈજનેરશ્રીઓ અને અ.સ. શ્રીઓ, મા.મ. વિભાગ, સચિવાલય, ગાંધીનગર.
- સર્વે અધિક્ષક ઈજનેરશ્રીઓ
- સર્વે તાંત્રિક અધિકારીશ્રી, મા.મ. વિભાગ, સચિવાલય, ગાંધીનગર.
- ફાઈલ ક્રમાંક :- એસ.ઓ.આર. / ૧૦૨૦૦૬ / (૧૦૪) / સ.૧ માં રાખવા સારૂ.
- સિલેક્ટ ફાઈલ.

Instruction on implementation of
the building and other Construction
workers Act 1996
and building and other Construction
workers Welfare Cess Act, 1996.

Government of Gujarat
Labour & Employment Department
G.R. No. CWA-2004-841-M3
Sachivalaya, Gandhinagar,
Dated : 30 January 2006.

Read : Labour & Employment Department, Gandhinagar GR.No.CWA-2004-1831-M(3) Dated : 9-12-2005.

RESOLUTION

Building and other construction workers are one of the largest and most vulnerable segments of the unorganized labour. Their work is characterized by by inherent risk to life and limb of the work and also by the casual nature, temporary relationship between employer and employee, uncertain working hours, lack of basic amenities and inadequate welfare facilities.

Government of India has decided to constitute. Welfare boards for such workers in every state and accordingly, the Building and other Construction Workers (Regulation of Employment & conditions of Service) Act, 1996 was enacted by parliament and brought into force from 19th August, 1996. implementation of the Act. Including cess collection has already commenced in Karnataka, tamil nadu and dilhi. Under the side Act. Government of Gujarat has constituted a board under section 18. The stat Government has been powers to make rules for carrying out the provisions of this Act.

Accordingly, Government of Gujarat made Gujarat Building and other Construction Workers (Regulation of Employment and condition of Service) Rules, 2003 and published these Rules vide Notification No.GHR-2003-111-CWA-2000-1869-M(3), dated 18th August, 2003. Government of Gujarat has also constituted the Gujarat Building and other Construction workers Welfare Board vide Notification No. GHR/2004/163/CWA/2004/3743-M(3), dated 18th December, 2004. Secretary (Labour) has been appointed as Chairman.

Government of India has also enacted the Building and other construction workers welfare cess Act. (hereinafter called as cess Act) and brought it in force from 19th August, 1996. the cess Act provided for the levy and collection of cess on the cost of construction incurred by the employers, for increasing the resources of the welfare board. Section 3 of the Cess Act provides that cess shall be levied and collected at a rate not less than 1 % of the cost of construction incurred by an employer. Rule 5 of the Building and other construction worker welfare cess Rules, 1998 reads as fallows :-

- (1) The proceeds of the cess collected under Rule 4 shall be transferred by such Government office, public sector Undertaking, local authority. Or cess collector, to the Board along with the from of Challan prescribed (and in the head of account of the Board) under the accounting provedures of the state, by whatever name they are known.

- (2) Such Government office or public sector undertaking may deduct from the cess collected or claim from the Board, as the case may be, actual collection expenses not exceeding one per cent of the total amount collected.
- (3) The amount collected shall be transferred to the board within thirty days of its collection.

Moreover, under Rule 6, every employer, within thirty days of commencement of his work of payment of cess, as the case may be, has to furnish information in form 1 to the assessing Officer. Under Rule 12, the Assessing Officer, in cases where the employer has pay the cess or has paid less cess, can impose it penalty upto the amount of cess payable.

By Government of Gujarat Notification No. GHR/2005/04/CWA/2004/841/M3, dated 3rd January, 2005, all heads of the department of the Government of Gujarat, all Executive heads of public sector undertaking and all Executive head of local Authorities (except Gram panchayat and Nagar Panchayat) are declared as cess Collectors and Assessing Officers.

The Building and other Construction workers Welfare board has passed the necessary resolution to collect the cess with effect from 18th December, 2004.

According, the cess is payable by Government offices, public sector undertaking, local Authority or cess collector to the board in challan proscribed, in the following head / sub head :

Major Head :- 0230 – Labour and Employment

Minor Head :- 106-Fees under Contract Labour (Regulation and abolition) Rules

Sub Head :- (04)-Income from cess levied under Gujarat Building & other Construction worker's Welfare cess Act, 1996.

Approval of the Finance Department, Government of Gujarat has been taken for meeting the expenditure to be included for the various welfare activities by the Gujarat Building & other construction workers welfare board and the opening of the accounting Head / Sub –Head in file No 2004-1831-M3 on 1st December, 2005 (Copy of Resolution dated 9/12/2005 is enclosed)

All Government, public sector undertaking and local authorities are instruction to pay the above cess as per the Act. All Department Public sector Undertaking and local authorities are also advised to incorporate the 1 % cess in their estimates for all new works.

By order and in the name of Government of Gujarat.

(Vinod Babbar)
Principal Secretary Government
Labour & Employment Department

:: પરિપત્ર ::

“Demand Draft for E.M.D. & Tender fee shall be submitted in electronic format only through online (by Scanning) while uploading the bid. This submission shall mean that EMD & tender fee are received electronically. However for the purpose of realization of D.D. bidder shall send the D.D. in original through R.P.A.D. so as to reach to Executive Engineer, R&B Division, Porbandar within 7 days from the last date of uploading. Penaltiative action for not submitting D.D. in original to E.E. by bidder shall be initiated. D.D. for exemption Certificate is not necessary. However Exemption Certificate shall have to be submitted electronically through online.

Any documents in supporting of tender bid shall be submitted in electronic format only through online (by scanning etc.) & hard copy will not be accepted separately.”

“ટેન્ડર માટે બાનાની રકમ (ઈ.એમ.ડી.) તથા ટેન્ડર ફીના ડીમાન્ડ ડ્રાફ્ટ ઓન લાઈન સ્કેન કરી ઈલેક્ટ્રોનિક ફોરમેટમાં ટેન્ડર અપલોડ કરવાના રહેશે. આ પ્રકારે રજૂ થયેલ વિગતે બાનાની રકમ અને ટેન્ડર મળ.લ ગણવાની રહેશે અને તદઅનુસાર ટેન્ડર ખોલવામાં આવશે તે અનુસાર ઈલેક્ટ્રોનિક ફોરમેટમાં રજીસ્ટ્રેશન, બેંક સોલવંશી, બાનાની રકમ અને ટેન્ડર ફી મળેલ હોય તેની જ ઓફર ખોલવામાં આવશે. ખરેખર ચુકવણા માટે ટેન્ડર ભરનારે ડીમાન્ડ ડ્રાફ્ટ અસલમાં રજીસ્ટર્ડ પોસ્ટ એ.ડી. થી કાર્યપાલક ઈજનેરશ્રી, માર્ગ અને મકાન વિભાગ, પોરબંદર ને અપલોડીંગની છેલ્લી તારીખ થી દિવસ-૭ માં મળે તે અનુસાર રજૂ કરવાનો રહેશે. અસલમાં ડીમાન્ડ ડ્રાફ્ટ નહી મોકલનાર સામે શિક્ષાત્મક પગલા શરૂ કરવામાં આવશે. બાના મુક્તિ માટે ડીમાન્ડ ડ્રાફ્ટ જરૂરી બનશે નહિ, પરંતુ બાના મુક્તિ પ્રમાણપત્ર ઈલેક્ટ્રોનિકલી ઓન લાઈન રજૂ કરવાનું રહેશે.”

ટેન્ડર બીડનાં માટે જરૂરી આધાર માટેના કોઈપણ ડોક્યુમેન્ટ ઓન લાઈન ઈલેક્ટ્રોનિક ફોરમેટમાં સ્કેન કરી મોકલવાના રહેશે અને હાડ કોપી અલાયદી રીતે સ્વીકારવામાં આવશે નહિ.

ગુજરાત રાજ્યપાલશ્રીના હુકમથી અને તેમના નામે.

સહી/-
ઉપસચિવ
માર્ગ અને મકાન વિભાગ

ઇ-ટેન્ડરીંગમાં ટેન્ડર ફી અને અન્ય
ડોક્યુમેન્ટસ રજૂ કરવા અંગે.

ગુજરાત સરકાર
માર્ગ અને મકાન વિભાગ,
પરિપત્ર ક્રમાંક :- પરચ - ૧૦૨૦૦૮-૫-સ (પાર્ટફાઇલ)
સચિવાલય, ગાંધીનગર,
તા. ૨૭-૧૧-૨૦૦૮

વંચાણે લીધા :- તા. ૧૮/૧/૦૮ નો પરિપત્ર ક્રમાંક : પરચ - ૧૦૨૦૦૮-૫-સ

પરિપત્ર :-

માર્ગ અને મકાન વિભાગમાં હાલમાં ટેન્ડરો ઇ-ટેન્ડર પધ્ધતિથી સ્વીકારવામાં આવે છે. તે અન્વયે સમાન ક્રમાંકના તા. ૧૮/૧/૦૮ના પરિપત્રમાં ટેન્ડર ફી અને બાનાની રકમ જે તે કાર્યપાલક ઇજનેરને ખરેખર ચુકવવા માટે દિન-૭માં અસલમાં રજીસ્ટર્ડ પોસ્ટ એ.ડી.થી મોકલવાની તેમજ અસલમાં ડીમાન્ડ ડ્રાફ્ટ નહિ મોકલનાર સામે શિક્ષાત્મક પગલા લેવાની જોગવાઈ હતી.

ઉપરોક્ત પરિપત્રમાં નીચે મુજબ અંશતઃ સુધારો કરી આ શરતનો સમાવેશ ટેન્ડર નોટીસ / ટેન્ડરના મુસદ્દામાં Through R.P.A.D. so as to reach to E.E. Division - Within 7 days from the last date of uploading ને બદલે to S.E. at the time of tender opening or send the same through R.P.A.D. so as to reach to E.E. Division - Within 7 days from the last date of opening." સુધારો કરવામાં આવે છે. તેમજ ખરેખર ટેન્ડર ફી તેમજ બાનાની રકમ નિયત સમયમાં ઇજારદાર ન ભરે તો ઇજારદારની નોંધણી એક વર્ષ માટે એબેન્સમાં રાખવાની કાર્યવાહી કરી ઇ-ટેન્ડરીંગ નો કોડ એક વર્ષ માટે રદ કરાશે.

ગુજરાત રાજ્યપાલશ્રીના હુકમથી અને તેમના નામે.

(આર. કે. ચૌહાણ)
ખાસ ફરજ પરના અધિકારી
માર્ગ અને મકાન વિભાગ

ટેન્ડરમાં ભરેલ અસામાન્ય ઉંચા ભાવોના સંદર્ભે કામ પર પડતા ખર્ચ પર નિયંત્રણ રાખવા તથા કામની નાણાકીય પ્રગતિ ભૌતિક પ્રગતિ સાથે સુમેળમાં રહે તે માટે જરૂરી જોગવાઈ કરવા બાબત

ગુજરાત સરકાર
માર્ગ અને મકાન વિભાગ,
પરિપત્ર ક્રમાંક :- પરચ - ૧૦૨૦૦૮-(૬૧)-સ
તા. ૨૭-૧૧-૨૦૦૮

પરિપત્ર :-

ટેન્ડરમાં અસામાન્ય ઉંચા કે નીચા ભાવો ઇજારદારશ્રીઓ દ્વારા ઘણી વાર ભરાતા હોવાનું સરકારશ્રીના ધ્યાન પર આવેલ છે. આવા કિસ્સાઓમાં કામની નાણાકીય પ્રગતિ અને ભૌતિક પ્રગતિનો સુમેળ ન રહેવાની સંભાવના રહેલી છે. આથી કામની ભૌતિક પ્રગતિ પ્રમાણે નાણાકીય પ્રગતિ રહે કે જેથી સરકારશ્રી પર સમય પહેલા અયોગ્ય નાણાકીય બોજ ન પડે તે માટે નીચે મુજબની જોગવાઈ ટેન્ડરમાં કરવાનો નિર્ણય કરવામાં આવેલ છે. આ જોગવાઈ તમામ કામોના આ પરિપત્રની તારીખ પછી મંજૂર થતાં ડી.ટી.પી. માં અચૂક પણ કરવાની રહેશે.

જોગવાઈ :-

જે કોઈ આઈટમનો ભરેલ ભાવ. તે આઈટમના ટેન્ડરમાં મુકેલ અંદાજી ભાવ કરતા ટેન્ડરમાં મુકેલ અંદાજી રકમથી સમગ્ર ટેન્ડર જેટલા ટકા ઉંચુ કે નીચુ મંજૂર થયુ હોય તે ટકાવારીથી ૧૦% થી વધુ ઉંચો રહેતો હોય તેવી આઈટમનું ચકવણું રનીગ બિલ વદતે જે તે આઈટમના અંદાજી ભાવ + / - મંજૂર ટેન્ડરની ટકાવારી + તે આઈટમના અંદાજી ભાવની ૫% ની મર્યાદામાં કરવામાં આવશે. આ રીતે વીથહેલ્ડ રાખેલ રકમ કામ સંતોષકારક રીતે પુર્ણ થયે ફાઈનલ બિલ મંજૂર કરતી વતખે વ્યાજભારણ વગર છુટી કરવામાં આવશે.

ઉદાહરણ :-

ઉક્ત જોગવાઈની સ્પષ્ટ સમજણ માટે આ સાથે આપેલ ઉદાહરણ ધ્યાને લેવું

૧	ટેન્ડરમાં મુકેલ અંદાજી રકમ	:	રૂ. ૧૦૦/-
૨	મંજૂર થયેલ ટેન્ડરની રકમ	:	રૂ. ૧૧૦/-
૩	ટેન્ડરમાં મુકેલ અંદાજી રકમ સામે ખરેખર મંજૂર થયેલ ટેન્ડરની ટકાવારી	:	૧૦%
૪	ટેન્ડરની એક આઈટમનો ટેન્ડરમાં મુકેલ અંદાજી ભાવ	:	રૂ. ૧૦/-
૫	તે આઈટમનો ભરેલ ભાવ	:	રૂ. ૧૪/-
૬	તે આઈટમમાં ભરેલ ઉંચા ભાવની ટકાવારી	:	૪૦%
૭	તે આઈટમ માટે રનીગ બિલ વખતે ચુકવવાપાત્ર ભાવ	:	રૂ. ૧૦/- કો. ૩ પ્રમાણ ૧૦% ઉંચા અંદાજી ભાવના ૫% રૂ. ૧૧.૫૦
૮	ફાઈનલ બિલ વખતે વ્યાજ ભારણ વગર ચુકવવાપાત્ર થતો વીથહેલ્ડ રાખેલ ભાવ.	:	રૂ. ૧૪.૦૦-૧૧.૫૦ રૂ. ૨.૫૦

જો સદર આઈટમના ભાવ રૂ. ૧૨.૦૦ કે તેથી નીચો ભરેલ હોત તો રનીગ બિલમાં ભાવ કપાત આ જોગવાઈ મુજબ કરવાની રહેત નહીં.

(આર. કે. ચૌહાણ)
ખાસ ફરજ પરના અધિકારી
માર્ગ અને મકાન વિભાગ

બાંધકામના મટીરીયલ્સ તેમજ કોમ્પોનેન્ટ્સ સેમ્પલની ગુણવત્તા માટે પરીક્ષણ પૈકીના ૮૦% પરીક્ષણ સ્થળ પર તથા ૧૦% પરીક્ષણ સરકાર માન્ય લેબોરેટરી / ગેરી ધ્વારા તથા ૧૦% ગેરી લેબોરેટરીમાં કરાવવા બાબત

ગુજરાત સરકાર
માર્ગ અને મકાન વિભાગ
પરિપત્ર ક્રમાંક : ૫૨૪/૧૦૨૦૦૭/૨૮/સ
સચિવાલય, ગાંધીનગર
તારીખ : ૩૧/૧૨/૨૦૦૮

પરિપત્ર

બાંધકામના મટીરીયલ્સ તેમજ કોમ્પોનેન્ટ્સના સેમ્પલની ગુણવત્તા માટેના પરીક્ષણ હાલ ગેરી કે સરકાર માન્ય સંસ્થા (લેબોરેટરી) મારફતે કરવામાં આવે છે. કામોની પ્રગતિની સમીક્ષા દરમ્યાન ક્ષેત્રીય અધિકારીઓ તરફથી જાણવા મળેલ છે કે ઉક્ત હયાત પ્રક્રિયામાં ટેસ્ટીંગના પરિણામો વિલંબથી મળે છે, જેમાં સમય પણ ખૂબ વ્યતિત થાય છે. ઇજારદાર એસોસિએશન તરફથી આવી રજૂઆતો મળે છે, આથી આ મુશ્કેલી ધ્યાને લેતા ઇજારદારશ્રી ધ્વારા જે તે કામ માટે સ્થાપવામાં આવતી લેબોરેટરીમાં સ્થળ પર જ પરીક્ષણ કરવામાં આવે તો વિલંબ નિવારી શકાય તે બાબત વિચારણા હેઠળ હતી, પુખ્ત વિચારણાના અંતે નીચે મુજબની નીતિ હાલના તબક્કે અનુસરવા નક્કી કરવામાં આવ્યું છે.

નીચે જણાવેલ પરીક્ષણોમાં પ્રવર્તમાન પદ્ધતિમાં ફેરફાર કરી ફીક્વન્શી અનુસાર જરૂરી પરીક્ષણો પૈકી ૧૦% સરકાર માન્ય લેબોરેટરી / ગેરી તથા ૧૦% ગેરી લેબોરેટરી અને ૮૦% ફીલ્ડ લેબોરેટરી ધ્વારા કરાવવાના રહેશે. પરંતુ ગેરીમાં નીચેના દરેક પૈકી ઓછામાં ઓછું ૧(એક) પરીક્ષણ ગેરી લેબોરેટરીમાં કરવાનું રહેશે તથા ઓછામાં ઓછું એક પરીક્ષણ ગેરી / સરકાર માન્ય લેબોરેટરીમાં કરાવવાનો રહેશે. જેમાં નીચે દર્શાવેલ પરીક્ષણો સ્થળ પર કરવાના રહે છે.

એ	એગ્રીગેટ	(૧) ગ્રેડેશન (૨) ફલેક્રીનેશ અને ઈલોગેશન વેલ્યુ (૩) ઇમ્પેક્ટ વેલ્યુ (૪) વોટર એબસોર્પશન
બી	માટી	(૧) ફિલ્ડ એફડીડી અને એફએમસી (૨) સીવ એનાલીસીસ
સી	રેતી	(૧) ગ્રેડેશન
ડી	ઇટો	(૧) ડાયમેનશન અને ટોલરન્સ ટેસ્ટ (૨) વોટર એબસોર્પશન
ઇ	કોક્રીટ	(૧) નોન ડીસ્ટ્રીક્ટીવ ટેસ્ટ (એલ્ટ્રા સોનીક ટેસ્ટીંગ પદ્ધતિથી) (૨) સ્લમ્પ ટેસ્ટ (૩) કોમ્પ્રેસીવ સ્ટ્રેન્થ
એફ	બીટયુમીનસ મીક્સ	(૧) ડામરની ટકાવારી
જી	ડ્રાય મીક્ષ મટીરીયલ	(૧) ગ્રેડેશન

શરતો :-

- (૧) ઇજારદારે કામની ગુણવત્તા માટે ધારા ધોરણ પ્રમાણેની અને ઉપર જણાવેલ પરિક્ષણો માટે પ્રમાણિત થયેલ જરૂરી તમામ સાધનો સહિતની ફિલ્ડ ટેસ્ટીંગ લેબોરેટરી સ્વ ખર્ચે કામના સ્થળે યોગ્ય જગ્યા ઉપર સ્થાપવાની રહેશે. રસ્તાના કામ માટે લાગુ પડતા પ્લાન્ટના સ્થળને કામનું સ્થળ ગણી શકાય. પરંતુ કામનું સ્થળ લેબોરેટરીથી દૂર હોય તો ઇજારદારશ્રી ધ્વારા મોબાઇલ લેબોરેટરીની જરૂરી વ્યવસ્થા રાખવાની રહેશે.
- (૨) કાર્યપાલક ઇજનેરશ્રી જ્યારે સ્થળ પર તેઓનું ચેકીંગ કરવા જાય ત્યારે ટેસ્ટીંગ તેઓએ તેમની રૂબરૂમાં પણ કરાવવાનું રહેશે.
- (૩) ધારા ધોરણ પ્રમાણેના પરીક્ષણોની સંખ્યા પૈકી ૮૦% પરીક્ષણ ફિલ્ડ લેબોરેટરીમાં ઇજારદારના અધિકૃત ક્વોલીફાઇડ ઇજનેર કે જેઓને સંબંધિત કાર્યપાલક ઇજનેરશ્રીએ આઇ-કાર્ડ આપેલ હોય તેમનાં ધ્વારા ખાતાના ના.કા.ઇ./મ.ઇ./અ.મ.ઇ.ની હાજરીમાં જ કરવાના રહેશે અને પરિણામોમાં સંયુક્ત સહીઓ કરવાની રહેશે જ્યારે ૧૦% પરિક્ષણ ગેરી/સરકાર માન્ય લેબોરેટરી (ઓછામાં ઓછું એક પરીક્ષણ) અને ૧૦% ગેરી લેબોરેટરી (ઓછામાં ઓછું એક પરીક્ષણ) મારફતે કરાવવાના રહેશે.
- (૪) કુલ પરિક્ષણોના ૮૦% પરિક્ષણ એક જ સ્થળે એકજ સમયે એકજ તબક્કામાં નહીં કરતાં કામની પ્રગતિ મુજબ જે તબક્કાએ જે તે કામગીરીને અનુરૂપ જે મટીરીયલ્સ વાપરવાનું થતુ હોય તુદાનુસાર શરૂઆતના તબક્કામાં રાખવું વચ્ચેના તબક્કામાં તેમજ આખરી તબક્કામાં કરાવવાનું રહેશે. આમ છતાં આ બાબતે સ્થાનિક કક્ષાએથી ના.કા.ઇ.શ્રીએ જરૂરીયાત મુજબ તબક્કાવાર પરીક્ષણો તકકી કરવાના રહેશે.
- (૫) ગુણવત્તા નિયમન ધારા-ધોરણ પ્રમાણેના બધા જ રજીસ્ટર નિયમિત રીતે નિભાવવાના રહેશે અને તે જે તે સ્થળે લેબોરેટરીમાં ઉપલબ્ધ રહે તેમ રાખવાના રહેશે.
- (૬) જો કોઈ કારણોસર ટેસ્ટીંગના સાધન અપ્રાપ્ય હોય અથવા વસાવવામાં સમય જાય તેમ હોય કે વ્યવહારુ ન હોય (જેમ કે ઇલેક્ટ્રોમેટ્રિક બેરીંગ) તો આવા પરીક્ષણો ગેરી/સરકાર માન્ય સંસ્થાઓમાં કરાવી શકાશે. અને આ બાબતનો નિર્ણય સંબંધિત કા.ઇ.શ્રી / ના.કા.ઇ.શ્રીએ કરવાનો રહેશે. ગેરીમાં ન થઈ શકે તેવા ટેસ્ટ સરકાર માન્ય લેબોરેટરીમાં કરાવી શકાય.
- (૭) વિભાગના ક્ષેત્રિય તાંત્રિક સ્ટાફે ના.કા.ઇ./મ.ઇ./અ.મ.ઇ.એ તેમજ ઇજારદારના તાંત્રિક સ્ટાફ ધ્વારા ગેરીમાં પરીક્ષણ જાતે કરવાનો સંતોષકારક અનુભવ મેળવી આ બાબતનું ગેરીનું પ્રમાણપત્ર પણ મેળવવાનું રહેશે. જે તે જિલ્લા/પ્રાદેશિક સ્તરે ગેરીની લેબોરેટરીમાં કોર્પ કન્ડક્ટ કરવા માટે જરૂરી ફી જે તે વિભાગના કા.ઇ.શ્રીએ ચુકવવાની રહેશે અને આ કાર્યવાહી સમયબદ્ધ પૂર્ણ થાય તે માટે સંબંધિત અ.ઇ.શ્રીએ આ કામગીરીની વખતોવખત સમીક્ષા કરવાની રહેશે.
- (૮) આ પરિપત્રથી ઉપર જણાવેલા પરીક્ષણો પૈકી ૮૦% પરીક્ષણો ક્ષેત્રિય લેબોરેટરીમાં કરવાનો સમય તા.૧/૧/૨૦૧૦ થી કરવાનો રહેશે.
- (૯) ગેરીમાં ટેસ્ટીંગ કરાવતાં સમયે ગેરીનો ટેસ્ટીંગ ચાર્જ ત્વરીત ભરવાનો રહેશે. જેથી પરીક્ષણના પરીણામો સમયસર મેળવી શકાય.

સહી/-

(આર. કે. ચૌહાણ)

ખાસ ફરજ પરના અધિકારી (વિ.યો.)

માર્ગ અને મકાન વિભાગ

ટેન્ડર ફોર્મ બી-૨ ના કોન્ટ્રાક્ટરોની
માર્ગદર્શન માટે સામાન્ય નિયમો
અને સૂચનોના સૂચન નં.૧૮ માં
સ્પષ્ટતા કરવા બાબત

ગુજરાત સરકાર
માર્ગ અને મકાન વિભાગ
ક્રમાંક:- ટીએનસી-૧૦-૨૦૧૩-(૦૨)-સી
સચિવાલય, ગાંધીનગર
તા. ૧૦-૦૫-૨૦૧૩

સંદર્ભ:- મા.મ.વિભાગના ઠરાવ ક. ટીએનસી-૧૦૯૦-(આઈબી-૨૨)-(૧૦)-સી તા.૨૪-૦૫-૧૯૯૦

આમુખ:-

ઉપરોક્ત વિષય અન્વયે ના સંદર્ભિત ઠરાવ માં સૂચન નં.૧૮ માં "આ કામ માટે
ટેન્ડરો રજીસ્ટર ટપાલ દ્વારા રવાના કરવામાં આવે ત્યારબાદ ટેન્ડર પર સ્વિકારવાની
સૂચિત તારીખથી ૯૦/૧૨૦ દિવસ સુધી ઓફર ખુલ્લી રહેશે." તેમ દર્શાવેલ છે.

હવે ઉદ્યોગ અને ખાણ વિભાગના ઠરાવ નં. એસપીઓ-૧૦૨૦૦૫-૧૪૦૭-સીએચ
તા.૨૨-૧૧-૨૦૦૬ ના સંદર્ભે કામોના ટેન્ડર Online માંગવામાં આવે છે અને ઉપરના
સૂચન નં. ૧૮ માં "ટેન્ડર પર સ્વિકારવાની સૂચિત તારીખથી ૯૦/૧૨૦ દિવસ સુધી
ઓફર ખુલ્લી રહેશે" તેવી જોગવાઈ ના કારણે ટેન્ડર ની વેલીડીટીમાં વિસંગતતા ઉભી
થવા બાબતની ગુજરાત કોન્ટ્રાક્ટર એસોસીએશન ની વિવિધ સ્તરે રજુઆતો મળેલ છે.
આ રજુઆતો પર પુખ્ત વિચારણાને અંતે આ બાબતે નીચે મુજબની સ્પષ્ટતા કરવામાં
આવે છે.

સ્પષ્ટતા

" Online Tender System માં સીગલ કવર સીસ્ટમ વાળા ટેન્ડરોમા ટેન્ડર વેલીડીટી નો
સમય ટેન્ડર ઓનલાઈન ખોલ્યા તારીખથી જ્યારે ટુ કવર બીડ સીસ્ટમમાં ટેન્ડર
વેલીડીટીનો સમય ટેકનીકલ બીડ ખોલ્યા તારીખથી ગણવાનો રહેશે."

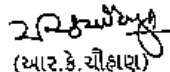
(આર.કે.ચૌહાણ)
ખાસ ફરજ પરના અધિકારી(વિ.વો.)
માર્ગ અને મકાન વિભાગ

ટેન્ડરમાં ભરેલ અસામાન્ય ઊંચા ભાવોના સંદર્ભે કાઠ પર પડતા પ્રાર્થ પર નિયંત્રણ રાખવા તથા કામને નાણાકીય પ્રગતિ સારી સુમેળમાં રહે તે માટે જરૂર જોગવાઈ કરવા બાબત

ગુજરાત સરકાર
માર્ગ અને મકાન વિભાગ
પરિપત્ર ક્રમાંક:- પરચ-૧૦૨૦૦૮-(૬૧)-સી
તા. ૦૩-૦૫-૨૦૧૩

વંચાણે લીધા:- પરિપત્ર ક્રમાંક:- પરચ-૧૦૨૦૦૮-(૬૧)-સી તા. ૨૭-૧૧-૨૦૦૮

સામાન્ય:-

ટેન્ડર માં ઈજારદારશ્રીઓ દ્વારા ભરાતા Imbivalatce ભાવો વાળા ટેન્ડરના કિસ્સાઓમાં ઈજારદારશ્રીઓ દ્વારા ઊંચા ભાવની આઈટમોની કામગીરી થયા બાદ નીચા ભાવની આઈટમોની કામગીરી ન કરવામાં આવે તેવી પરિસ્થિતિ પર નિયંત્રણ રાખવા માટે તા. ૨૭-૧૧-૨૦૦૮ નો પરિપત્ર જરૂરી જોગવાઈ સાથે બહાર પાડવામાં આવેલ. આ પરિપત્ર અંગે વિવિધ સ્તરોએ થયેલ રજૂઆતોને ધ્યાને લેતાં અને તેના પર પુખ્ત વિચારણાના અંતે આ પરિપત્રના બીજા ફકરાની છેલ્લી લીટી "આ રીતે વીથહેલ રાખેલ રકમ કામ સંતોષકારક રીતે પૂર્ણ થયે કાર્યનલ બીલ મંજૂર કરતી વખતે વ્યાજભારણ વગર છૂટી કરવામાં આવશે" તેની જગ્યાએ નીચે મુજબનો સુધારો કરવામાં આવે છે.

સુધારો:-

"આ રીતે વીથહેલ રાખેલ રકમ અસાધારણ નીચા ભાવ ભરેલ હોય તેવી આઈટમની નાણાકીય પ્રગતિનાં પ્રમાણસર રનીંગ બીલમાંથી છૂટી કરવાની રહેશે. જે કિસ્સામાં અસાધારણ નીચા ભાવ ભરેલ કોઈપણ આઈટમ ન હોય તેવા કિસ્સામાં અસાધારણ ભાવો ભરેલ આઈટમની સામે વીથહેલ રાખેલ રકમ બાકી રહેતી કામગીરી થાય તેના પ્રમાણસર રનીંગ બીલમાંથી છૂટી કરવાની રહેશે."

વધુમાં વંચાણે લીધેલ પરિપત્ર ના ઉદ્દેશ્યમાં દર્શાવેલ ક્રમાંક-૮ રદ કરવામાં આવે છે.

ઉપરોક્ત સુધારાનો અમલ આ પરિપત્રની તારીખ પછી મંજૂર થતા ડી.ટી.પી. માં અચૂકપણે કરવાનો રહેશે.

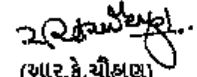

(આર.કે.ચૌહાણ)

ખાસ ફરજ પરના અધિકારી(વિ.ઓ.)
માર્ગ અને મકાન વિભાગ

પ્રતિ,

સર્વે અધિક્ષક ઈજનેરશ્રીઓ, મા.મ. વિભાગ (પાટનગર મોજના વર્તુળ, નેશનલ હાઈવે વર્તુળ, સહિત).
સર્વે અધિક્ષક ઈજનેરશ્રીઓ (પંચાયત) મા.મ. વિભાગ.
સર્વે કાર્યપાલક ઈજનેરશ્રીઓ, મા.મ. વિભાગ.
સર્વે કાર્યપાલક ઈજનેરશ્રીઓ, (પંચાયત), મા.મ. વિભાગ.

નકલ રવાના:-

૧. અગ્ર સચિવશ્રીના અંગત મદદનીશશ્રી, મા.મ. વિભાગ, સચિવાલય, ગાંધીનગર
૨. સર્વે મુખ્ય ઈજનેર અને અ.શ્રીઓ, મા.મ. વિભાગ.
૩. સર્વે તાંત્રિક ઉપ સચિવશ્રીઓ, મા.મ. વિભાગ.
૪. ના.કા.ઈ.શ્રીઓ, મા. મ. વિભાગ.
૫. નાણાં શાખા, મા.મ. વિભાગ.
૬. ના.સે.અ, સી શાખા, મા.મ. વિભાગ., સિલેક્ટ ડાઈલ.
૭. શાખા સિલેક્ટ ડાઈલ -૨૦૧૩

Modification in Defect Liability
Clause 17 A of Tenders for
Building works

Government of Gujarat
Roads & Buildings Department
Circular No. PRCH-102013-207/2759/N
Sachivalaya, Gandhinagar
Date :- 27-05-2013

Ref :- Circular No. PRCH-102008-(2076) – N Dt. 3-12-2009

R&B Department had issued a circular as referred above where in following provision has been made for building works.

The Defects Liability period shall be as under for original building works:

Three years of elapse of three monsoon periods following date of possession of building taken over by user agency OR Four years of elapse of four monsoon periods following the certified date of completion, Whichever is earlier.

After due considerations on the representations received at various levels from the Gujarat Contractor Associations the above clause is now modified as under

The defects Liability period shall be as under for original building works:

" One year or elapse of one monsoon period from the certified date of completion whichever is greater "

The other conditions in the above said circular will remain as it is.

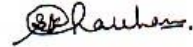

(R.K. Chauhan)

Officer on Special Duty(S.P.)

Road & Buildings Department

To,

All , Superintending Engineers, State, Ahmedabad city, Capital, Project and Panchayat Circles, R & B Department,

All, Executive Engineers under above circles.

Copy To:

1. PA to Principal Secretary(R&B), Sachivalaya, Gandhinagar.
2. All Chief Engineers & Additional Secretaries (R&B), Sachivalaya, Gandhinagar.
3. Select File.

પરફોર્મન્સ બોન્ડ તથા જામીન અનામત પેટે બેંક
ગેરેન્ટી મેળવવા બાબત

ગુજરાત સરકાર

માર્ગ અને મકાન વિભાગ

પરિપત્ર ક્રમાંક: ટી.એન.સી-૧૦-૨૦૧૩-૩૨(ભાગ-૧)-સ

સચિવાલય, ગાંધીનગર

તા.૧૯-૧૧-૨૦૧૩

વંચાણે લીધો પરિપત્ર ક્રમાંક:- ટી.એન.સી-૧૦૯૧/આઈ.બી/૧૦/૧૧/સ તા.૩૧-૩-૧૯૯૯

આમુખ:-

વંચાણે લીધેલ પરિપત્ર મુજબ હાલમાં ૧૫ લાખ કે તેથી વધુ રકમની કામો માં ઈજારદારશ્રી પાસેથી પરફોર્મન્સ બોન્ડ લેવાની જોગવાઈ છે. પરંતુ હવે મોટા ભાગના કામો ૧૫ લાખ થી વધુ રકમના હોય છે અને ચાલુ મરામતના કામો પણ હવે ૧૫ લાખ થી વધુ રકમના હોય છે. આ બાબતે કોન્ટ્રાક્ટસ ઓસોસીએશન તરફથી પણ પરફોર્મન્સ બોન્ડ માટે કામની રકમ ની મર્યાદા વધારવા માટેની રજુઆત કરવામાં આવેલ છે. આથી વહીવટી સરળતા અને અનુકૂળતા જાળવાય તે હેતુસર પરફોર્મન્સ બોન્ડ માટે કામની રકમમાં ફેરફાર કરવાનું સરકારશ્રીની વિચારણા હેઠળ હતું

પરિપત્ર:-

પુખ્ત વિચારણાને અંતે નક્કી થયેલ છે કે હવે ૩.૧૫ લાખ કે તેથી વધુ રકમને બદલે ૩.૩૦ લાખ કે તેથી વધુ રકમ ના સરકારી કામોમાં ઈજારદારશ્રી પાસેથી પરફોર્મન્સ બોન્ડ લેવાના રહેશે.

આ પરિપત્ર વિભાગની સરખા ક્રમાંકની કાંઈલ પરની નોંધ પર નાણાંવિભાગની તા.૨૨-૯-૧૩ ના રોજથી પ્રતોલ સંમતીથી બહાર પાડવામાં આવે છે.

ગુજરાત ના રાજ્યપાલશ્રીના હુકમથી અને તેમના નામે.



(આર.કે.ચૌહાણ)

ખાસ ફરજ પરના અધિકારી(રિ.ચો.)

માર્ગ અને મકાન વિભાગ

બાંધકામના કોન્ટ્રાક્ટર પાસેથી સી.યુ.રી.ટી ડીપોઝીટ
સ્વિકારવાની પ્રથામાં અંશતઃ ફેરફાર કરવા બાબત

ગુજરાત સરકાર
માર્ગ અને મકાન વિભાગ
ઠરાવ ક્રમાંક: ટીએનસી-૧૦-૨૦૧૩-૩-(બાગ-૨)-સી
સચિવાલય, ગાંધીનગર
તા.૨૦-૧૧-૨૦૧૩

વંચાણે લીધો ઠરાવ ક્રમાંક:- ટીએનસી-૧૦૮૮/આઈબી/૧૮/(૧૩)/સ તા.૩૧-૮-૧૯૪

આમુખ:-

કોન્ટ્રાક્ટરોને આપવામાં આવતા કામો માં સીક્યુરીટી ડીપોઝીટ અંગેની હાલની પદ્ધતિ પ્રમાણે એગ્રીમેન્ટ સમયે ૫% પરફોર્મન્સ બોન્ડ બેંક ગેરંટી સ્વરૂપે, ૨.૫% સીક્યુરીટી ડીપોઝીટ નર્મદ બોન્ડ અથવા એન.એસ.એસ. સ્વરૂપે લેવામાં આવે છે તેમજ ૨.૫% રકમ ઈજારદારશ્રીના રનોંગ બીલમાંથી કપાત સ્વરૂપે વસુલ કરવામાં આવે છે. કોન્ટ્રાક્ટર્સ એસોસિએશન દ્વારા નાણાકીય તરલતા હેઠળ તે માટે ૨.૫% લેખે કાપવામાં આવતી સીક્યુરીટી ડીપોઝીટની રકમ બેંક ગેરંટી સામે છુટી કરવાની રજુઆત કરવામાં આવેલ હતી. જે બાબત વિચારણા હેઠળ હતી.

ઠરાવ:-

પુખ્ત વિચારણાને અંતે સરકારી કામોના કોન્ટ્રાક્ટ માટે સીક્યુરીટી ડીપોઝીટ સ્વિકારવાની હાલની પ્રથામાં નીચે મુજબ નો ફેરફાર કરવામાં આવે છે.

૧. હાલમાં પ્રથમ તબક્કે લેવામાં આવતી ૨.૫% સીક્યુરીટીની રકમ જે નર્મદા બોન્ડ/ એન.એસ.એસ. સ્વરૂપે લેવાની જોગવાઈ છે, તે કવે નર્મદા બોન્ડ/ એન.એસ.એસ. તેમજ શીક્વલ બેંકની એફ.ડી.આર. સ્વરૂપે પણ લઈ શકાયો.
૨. રનોંગ બીલમાંથી કપાત થતી ૨.૫% સીક્યુરીટી ડીપોઝીટની રકમ ઈજારદારશ્રી દ્વારા શીક્વલ બેંકની બેંક ગેરંટી રજુ કર્યોથી નીચે જણાવ્યા મુજબ રીલીઝ કરવાની રહેશે.

ક્રમ	નાણાકીય પ્રગતિ	રનોંગ બીલમાંથી ૨.૫% લેખે સીક્યુરીટી ડીપોઝીટ પેટે કાપવામાં આવેલ રકમ માંથી છુટી કરવા પાત્ર રકમ	બેંક ગેરંટીની રકમ
૧	ટેન્ડરની રકમના ૨૫%	રનોંગ બીલમાંથી કાપવામાં આવેલ રકમ અથવા કામની અંદાજિત કિંમતના ૦.૬૨૫%, બેમાંથી જે ઓછી રકમ હોય તે.	રીલીઝ કરવામાં આવેલ રકમ જે લી
૨	ટેન્ડરની રકમના ૫૦%	રનોંગ બીલમાંથી કાપવામાં આવેલ રકમ અથવા કામની અંદાજિત કિંમતના ૧.૨૫%, બેમાંથી જે ઓછી રકમ હોય તે.	રીલીઝ કરવામાં આવેલ રકમ જે લી
૩	ટેન્ડરની રકમના ૭૫%	રનોંગ બીલમાંથી કાપવામાં આવેલ રકમ અથવા કામની અંદાજિત કિંમતના ૧.૮૭૫%, બેમાંથી જે ઓછી રકમ હોય તે.	રીલીઝ કરવામાં આવેલ રકમ જે લી

ઉપરોક્ત બેંક ગેરંટીની મુદત કામ પુર્ણ થવાની ખરેખર તારીખથી છ(છા)માસ વધુ સમયની લેવાની રહેશે તથા ઈજારદારશ્રી પાસેથી બાંહેધરીપત્ર મેળવવાનો રહેશે કે, જે કામ પુર્ણ કરવાની સમયમર્યાદામાં વધારો થશે તો વધારેલ સમયમર્યાદાની તારીખથી ૬ માસ વધુ સમયમર્યાદા વાળી બેંક ગેરંટી નેઓશ્રી દ્વારા પુરી પાડવામાં આવશે.

કામ પુર્ણ થાય ત્યાં સુધી ઈજારદારશ્રી પાસેથી લેવાની થતી ૧૦% સીક્યુરીટી ડીપોઝીટનું પ્રમાણ કોઈપણ સ્વરૂપે જળવાઈ રહે તેની અચૂક કાળજી રાખવાની રહેશે.

આ ઠરાવ વિભાગનો સરખા ક્રમાંકની ફાઇલ પરની નોંધ પર નાણાવિભાગની તા.૬-૧૦-૧૩ ના રોજથી મળેલ સંમતીથી બહાર પાડવામાં આવે છે.

ગુજરાત ના રાજ્યપાલશ્રીના હુકમથી અને તેમના નામે.

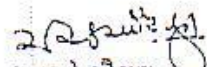
(આર.કે.ચૌહાણ)
પાસ ફેરફારના અધિકારી(વિ.વો.)
માર્ગ અને મકાન વિભાગ

પ્રતિ,

(૧) સર્વે અધિકષક ઈજનેરશ્રીઓ, મા.મ. વિભાગ

(૨) સર્વે કાર્યપાલક ઈજનેરશ્રીઓ, મા.મ. વિભાગ

હા. ઈ. શ્રી,
મા. અને મા. વિભાગ

વિભાગ

સમગ્ર

પાટણ

જાણી

સી.ઓ.એસ.પી.વી.કે.સી.

વિષય : ઈજારદારના કારણોસર કામ પૂર્ણ થવામાં થયેલ વિલંબ દરમ્યાન સ્ટારરેટના ચુકવણા / વસુલાત બાબત.

સંદર્ભ : (૧) પરીપત્ર ક્રમાંક : એસ.ટી.આર./૧૦૨૦૦૧/મં.૩૪/૨૯/૬, તા.૨/૨/૦૭

(૨) બી-૨ ફોર્મ કલોલ નં.પલ એ.

સીમેન્ટ, સ્ટીલ તથા ડામરના ભાવ તફાવત અંગેની જોગવાઈ કરવામાં આવેલ છે. જેમાં ડી.ટી.પી.જે માસમાં મંજૂર થયેલ હોય તે સમયના સીમેન્ટ, સ્ટીલ તથા ડામર (રીફાઈનરી)ના તે સમયના ભાવો મુકવાની તથા ખરેખર કામ દરમ્યાન ઈજારદાર તે માલસામાન લાવે તે ધ્યાને લઈ ભાવ તફાવતની વધ/ઘટ મુજબ ભાવ તફાવત આપવાનો કે પરત લેવાની જોગવાઈ કરેલ છે.

આ બાબતે સ્પષ્ટતા કરવાની કે સદર કલોલમાં વધુમાં " CONDITION FOR VARIATION IN RATES OF ASPHALT ONLY " હેઠળ સરકારશ્રીના અલગ અલગ પરીપત્રોના અમલ માટે જરૂરીયાત પ્રમાણે ક્રમ-૧થી ૧૧ ની શરતો મુકવામાં આવેલ છે. આ પરીપત્રો પૈકી પરીપત્ર ક્રમાંક : એસ.ટી.આર. - ૧૦૨૦૦૧ માં ૩૪-૨૯-૬, તા.૦૨/૦૨/૨૦૦૭ અન્વયે જણાવવાનું કે, સદર પરીપત્રમાં ડામરના ભાવ તફાવત બાબતે વિગતવાર સ્પષ્ટતાઓ આપવામાં આવેલ છે. જેમાં મુળ સમય મર્યાદા, સરકારી કારણોને લીધે વધારેલી સમય મર્યાદા તથા ઈજારદારના કારણોના લીધે વધેલ સમય મર્યાદામાં ભાવ તફાવતનું ચુકવણુ / વસુલાત કરવાની પધ્ધતિ સ્પષ્ટ દર્શાવેલ છે. આ પૈકી કામ પૂર્ણ કરવામાં ઈજારદારના કારણોથી થયેલ વિલંબના કિસ્સામાં સમય મર્યાદા વધારવામાં આવે તે દરમ્યાનનો ભાવ તફાવત મળવાપાત્ર થશે નહીં. પરંતુ કરારની મુળ સમય મર્યાદામાં વધારેલ જથ્થાનો ભાવ તફાવત મળવાપાત્ર થશે એમ જણાવેલ છે. આમ વધારાના સમયગાળા માટે ભાવ તફાવત ચુકવવાનો રહેતો નથી. પરંતુ ડામરની આઈટમોમાં જો વસુલાત કરવાની થતી હોય તો તે વસુલાત કરવાની થાય છે. પરંતુ કેટલાક વિભાગો દ્વારા આ પ્રકારની વસુલાત કરવામાં આવતી નથી, તેવું ધ્યાને આવેલ છે. તો આ બાબતે

સ્પષ્ટતા કરતા જણાવવાનું કે, ટેન્ડર કલોઝ નં. પલ્એની મુળ જોગવાઈ જે પ્રથમ ત્રણ પંક્તિમાં જણાવેલ છે તેમાં સ્પષ્ટ જણાવેલ છે કે, ".....SHALL BE ADJUSTED FOR INCREASE OR DECREASE IN THE RATES OF THESE MATERIALS AS UNDER" આમ આ કલોઝની આ જોગવાઈ હેઠળ જ આગળની કાર્યવાહી તે પ્રમાણે કરવાની થાય છે.

આમ, ઉપરોક્ત બાબતે સર્વે કાર્યપાલક ઈજનેરશ્રી તેમજ એકાઉન્ટન્ટશ્રીઓનું ધ્યાન દોરવું જરૂરી છે અને આવા વસુલાતપાત્ર કિસ્સામાં વસુલાત કરવામાં આવે તે બાબતે ધ્યાન આપવા તાકીદ કરવામાં આવે છે. જો આમ કરવામાં ચુક થશે તો સંબંધિત નાયબ કાર્યપાલક ઈજનેરશ્રી, કાર્યપાલક ઈજનેરશ્રી, વિભાગીય સિસાબનીશ / અધિકારીની સીધી જવાબદારી રહેશે.

સદર બાબતે સર્વે અધિક્ષક ઈજનેરશ્રીઓને સુચના આપવામાં આવે છે કે, તેઓના હસ્તકના વિભાગોમાંથી આ પ્રકારના કામો જુદા તારવી તેમાં વસુલાત કરવામાં આવી છે કે નહીં તે બાબતે યોગ્ય ચકાસણી કરી લેવી અને જો વસુલાત કરવામાં ના આવી હોય તો તે અંગે ત્વરિત જરૂરી વસુલાત કરવા જરૂરી સુચના સંબંધિત કાર્યપાલક ઈજનેરશ્રીને આપવી.

(અન.જી. પરમાર)
ખાસ ફરજ પરના અધિકારી (વિ.યો.)
માર્ગ અને મકાન વિભાગ

S.E. RAJKOT
R & B Circle No. II

INWARD 306
DATE: 3/3

મકાનો તથા પુલોના આર.સી.સી. કામોમાં લોખંડના સળીયાના માપો લખવા તથા ચૂકવણામાં લેપ લેન્થ ની લંબાઈ ગણતરીમાં નહીં લવા બાબત

ગુજરાત સરકાર
માર્ગ અને મકાન વિભાગ
સચિવાલય, ગાંધીનગર
પરિપત્ર ક્રમાંક:- PDW-10-2017-01-C
તા.૧૫-૦૨-૨૦૧૭

પરિપત્ર:-

મકાન, રસ્તા અને પુલોના કામોમાં આર.સી.સી. આઇટમોમાં સમાવિષ્ટ સ્ટીલ રેઇનફોર્સમેન્ટના માપો લખવા અને ચૂકવણા દરમ્યાન લેપની લંબાઈ ગણતરીમાં લેવામાં આવે છે. રેઇનફોર્સમેન્ટમાં લેપની વધુ સંખ્યાને પ્રોત્સાહન ન આપતા સળંગ રેઇનફોર્સમેન્ટ (સળીયા) જ મહદઅંશે વપરાય એ તાંત્રિક રીતે વધુ યોગ્ય છે.

MORT&H સ્પેશીફિકેશનના પ્રવર્તમાન ધારાધોરણ મુજબ રેઇનફોર્સ (સળીયા)ના ચૂકવણામાં લેપની લંબાઈના માપો ગણતરીમાં લેવામાં આવતા નથી. (Section 1608)

MORT&H સ્પેશીફિકેશનના પ્રવર્તમાન ધારાધોરણ મુજબ માર્ગ અને મકાન વિભાગ હેઠળ મકાન, રસ્તા અને પુલના રેઇનફોર્સ (સળીયા)ના સ્પેશીફિકેશનમાં Mode of Measurement & Payment માં હવે પછી નીચે મુજબના ફેરફાર કરવા આથી સુચના આપવામાં આવે છે.

<u>EXISTING ITEM</u>	<u>PROPOSED AMENDMENT</u> (As per MORT&H Specification Item No.1608)
<u>મકાનના સ્પેશીફિકેશન</u>	<u>મકાનના સ્પેશીફિકેશન</u>
5.4.10 Providing an Mild Steel reinforcement for R.C.C. work including bending binding and placing in position etc. complete up to floor two level.	5.4.10 Providing an Mild Steel reinforcement for R.C.C. work including bending binding and placing in position etc. complete up to floor two level.
5.4.11 High yield deform bars steel reinforcement for R.C.C. work including bending, binding and placing in position complete up to floor two level.	5.4.11 High yield deform bars steel reinforcement for R.C.C. work including bending, binding and placing in position complete up to floor two level.
3.2 Reinforcement shall be measured in length including overlaps, separately for different diameters as actually used in the work. Where welding or coupling is resorted to in place lap joints, such	3.2 Reinforcement shall be measured in length including hooks, if any, separately for differnent diameters as actually used in work, excluding overlaps. From the length so

Ext. DTP ની
Incompletable
BY
E

2

<p>joints shall be measured for payment as equivalent length of overlap as per design requirement. From the length so measured, the weight of reinforcement shall be calculated in tones on the same basis of as per M-18 even though steel is supplied to the contractor by the department on actual weight. Length shall include hooks at the ends Wastage and annealed steel wire for binding shall not be measured and the cost of these items shall be deemed to be included in the rate for reinforcement.</p>	<p><i>measured, the weight of reinforcement shall be calculated in tonnes on the basis of IS: 1732. Wastage, overlaps, couplings, welded joints, spacer bars, chairs, stays, hangers and annealed steel wire or other methods for binding and placing shall not be measured and cost of these items shall be deemed to be included in the rates for reinforcement.</i></p>
<p><u>EXISTING ITEM</u></p>	<p><u>PROPOSED AMENDMENT</u> (As per MORT&H Speciafication Item No.1608)</p>
<p><u>रस्ताला स्पेशलीकेशन</u> Item No. 39 : Providing steel reinforcement. a) Providing and placing in position mild steel bar reinforcement including cutting, bending, hooking and tying complete as per details. b) High yield strength deformed bars reinforcement. (10) Reinforcement shall be measured in length seperealy for different diameters as actually used in the work, from the length so measured the weight of reinforcement shall be calculated in tones on the same basis of IS : 1732 even though steel is supplied to the contractor by the Department on actual wieghment. Length shall ilcude hooks at ends. Wastage and annealed steel wire for binding shall not be measured and cost of thes items shall be deemed to be</p>	<p><u>रस्ताला स्पेशलीकेशन</u> Item No. 39 : Providing steel reinforcement. a) Providing and placing in position mild steel bar reinforcement including cutting, bending, hooking and tying complete as per details. b) High yield strength deformed bars reinforcement. (10) Reinforcement shall be measured in length including hooks, if any, separately for differenct diameters as actually used in work, excluding overlaps. From the length so measured, the weight of reinforcement shall be calculated in tonnes on the basis of IS: 1732. Wastage, overlaps, couplings, welded joints, spacer bars, chairs, stays, hangers and annealed steel wire or</p>

3

included in the rates for reinforcement.	<i>other methods for binding and placing shall not be measured and cost of these items shall be deemed to be included in the rates for reinforcement.</i>
<p><u>પુલના સ્પેશીફિકેશન</u> Item: 21 –Providing (A) Mild Steel Reinforcement (B) High Yield Strength Deformed bars, reinforcements. (10) Reinforcement shall be measured in length including overlaps, separately for different diameter, as actually used in the work, where welding or coupling is restored to, in place of lap-joints, such joints shall be measured for payment as the equivalent length of over lap as per design requirement. From the length so measured the weight of reinforcement shall be calculated in tones on the same basis of IS 1732 even though steel is supplied to the contractor by the Department on actual weight. Length shall include hooks at ends. Wastage and annealed steel wire for binding shall not be measured and cost of these items shall be deemed to be included in the rates for reinforcement.</p>	<p><u>પુલના સ્પેશીફિકેશન</u> Item: 21 –Providing (A) Mild Steel Reinforcement (B) High Yield Strength Deformed bars, reinforcements. (10) Reinforcement shall be measured in length including hooks, if any, separately for different diameters as actually used in work, excluding overlaps. From the length so measured, the weight of reinforcement shall be calculated in tonnes on the basis of IS: 1732. Wastage, overlaps, couplings, welded joints, spacer bars, chairs, stays, hangers and annealed steel wire or other methods for binding and placing shall not be measured and cost of these items shall be deemed to be included in the rates for reinforcement.</p>

aydun
(એન. જી. પરમાર)
ખાસ ફરજ પરના અધિકારી (વિ.યો.)
માર્ગ અને મકાન વિભાગ

વિભાગીય સહાયક
અધિકારી
15/10/2017

માર્ગ અને મકાન વિભાગના કામોમાં ડીફેક્ટ
લાયેબીલીટી પીરીયડમાં ફેરફાર કરવા બાબત

ગુજરાત સરકાર
માર્ગ અને મકાન વિભાગ
ઠરાવ ક્રમાંક: ટીએનસી/૧૦/૨૦૧૬/કલોઝ-૧૭ એ/સુધારો/(૧)/સ
સરદાર ભવન, બ્લોક નં.૧૪
સચિવાલય, ગાંધીનગર
તા.૧૨/૦૫/૨૦૧૬

સંદર્ભ:- માર્ગ અને મકાન વિભાગના કામો માટે નિયત કરેલ ટેન્ડર ફોર્મ બી-૧ અને બી-૨ ના કલોઝ-૧૭ એ માંની
જોગવાઈ

આમુખ:-

ગુજરાત સરકાર માર્ગ અને મકાન વિભાગ દ્વારા હાથ ધરવામાં આવતા કામો માટે નિયત કરેલ ટેન્ડર ફોર્મ
બી-૧ અને બી-૨ નો ઉપયોગ કરવામાં આવે છે. આ કામોમાં ડીફેક્ટ લાયેબીલીટી પીરીયડ માટે નિયત કરેલ ટેન્ડર
ફોર્મ બી-૧ અને બી-૨ ના કલોઝ-૧૭ એ મુજબની કાર્યવાહી કરવામાં આવે છે. આ ડીફેક્ટ લાયેબીલીટી પીરીયડની
જોગવાઈઓમાં ફેરફાર કરવાની બાબત સરકારશ્રીની સક્રિય વિચારણા હેઠળ હતી.

ઠરાવ:-

ઉપરોક્ત બાબતે પુખ્ત વિચારણાના અંતે માર્ગ અને મકાન વિભાગના કામો માટે નિયત કરેલ ટેન્ડર ફોર્મ
બી-૧ અને બી-૨ માંના ડીફેક્ટ લાયેબીલીટી પીરીયડ અંગેના કલોઝ-૧૭ એ માંની જોગવાઈઓમાં નીચે મુજબનો
ફેરફાર કરવામાં આવે છે.

Clause	Existing Provision	Modified Provision
17 A (b)	For all works costing more than Rs.50,000/- and up to Rs.1 crore (amount put to tender), period shall be 6 months from the certified date of completion or one monsoon, whichever is later.	For all works costing more than Rs.50,000/- and up to Rs.1 crore (amount put to tender), period shall be 12 months from the certified date of completion or one monsoon, whichever is later.
17 A (c)	For major projects costing more than Rs. 1 crore , period shall be 12 months from the certified date of completion which should include one monsoon	For major projects costing more than Rs. 1 crore, (amount put to tender) , period shall be 36 months (thirty six) from the certified date of completion or three monsoons, whichever is later.

ઉપરોક્ત ઠરાવ સરખા ક્રમાંકની ફાઇલ પરની નોંધમાં માનનીય મંત્રીશ્રી (મા.મ.)ની તા.૧૦/૦૫/૨૦૧૬ના
રોજ મંજૂરી મેળવી બહાર પાડવામાં આવેલ છે. આ ઠરાવના ઇસ્યુ તારીખથી ઉપરોક્ત સુધારેલ જોગવાઈઓનો
ચુસ્તપણે અમલ કરવાનો રહેશે.

ગુજરાતના રાજ્યપાલશ્રીના હુકમથી અને તેમના નામે,

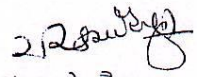
(આર.કે.ચૌહાણ)
ખાસ ફરજ પરના અધિકારી (વિ.ચો.)
માર્ગ અને મકાન વિભાગ
ગાંધીનગર

**INVITATION OF TENDER ON PERCENTAGE
RATE (B-1) TENDER CONTRACT FORM**

Government of Gujarat
Road & Buildings Department
No.TNC-1088-D-347-(7)-C
Schivalaya, Gandhinagar
Date:- 11/07/2017

Reference:-

1. R & B Department Resolution No.CON-1269-PAC-(52)-C, Dated 05/06/1985
2. R & B Department Resolution No.TNC-1088-D-347-(7)-C dated 22/04/1988
3. R & B Department Resolution No. TNC-1088-D-347-(7)-C dated 05/08/1988
4. R & B Department Resolution No. TNC-1088-D-347-(7)-C dated 15/12/2003

RESOLUTION

1. The question of raising monetary limit for B-1 tender form from Rs.50.00 lakhs (Rupees Fifty Lakhs only) was under consideration of Government. Government is pleased to order that the monetary limit of Rs.50.00 lakhs (Rupees Fifty Lakhs only) for B-1 tender form (fixed under aforesaid G.R. dated 15/12/2003) is hereby enhanced to Rs.12.00 Crore (Rupees Twelve Crore only) for Road works, and Rs.10.00 Crore (Rupees Ten Crore only) for Bridge and Building works. This enhanced monetary limit shall be applicable to the tenders to be invited hereafter with the strict application of a condition that tenders for the works amount put to tender upto Rs.12.00 Crore (Rupees Twelve Crore only) for Road works, and Rs.10.00 Crore (Rupees Ten Crore only) for Bridge and Building works should invariably be invited on B-1 tender form only.
2. Other safeguards and instructions in the G.Rs. mentioned in reference should be strictly followed.
3. These orders are issued with the concurrence of Finance Department dated 27/06/2017 on this Department's file No. TNC-102013-731236-04-C

By order and in the name of the Governor of Gujarat,

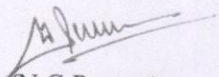
(N.G.Parmar)
Officer on Special Duty (S.P)
R&B Department
Gandhinagar

ટેન્ડરમાં જથ્થાવધારા તથા
જથ્થાવધારાના ભાવના માપદંડમાં
સુધારણા કરવા બાબત

ગુજરાત સરકાર
માર્ગ અને મકાન વિભાગ
બ્લોક નં.૧૪/૨, સરદાર ભવન,
સચિવાલય, ગાંધીનગર
ઠરાવ ક્રમાંક: TNC-10-2017-01-C
તા.૧૧/૦૭/૨૦૧૭

ઠરાવ

ટેન્ડરમાં જથ્થાવધારા તથા જથ્થાવધારાના ભાવના માપદંડ બાબતે બી-૧ અને બી-૨ ટેન્ડરના કલોઝ-૧૪.૨ માં જણાવ્યા મુજબ જથ્થાવધારા માટે ૩૦ ટકા સુધીનો જથ્થો ટેન્ડરના ભાવથી અને ૩૦ ટકાથી વધુ જથ્થામાં વધારો હોય તો જે તે વર્ષમાં કામગીરી કરેલ હોય તે વર્ષના એસ.ઓ.આર.થી કરવાની જોગવાઈ છે.

સદરહુ જોગવાઈમાં સુધારણા કરવા બાબતે સરકારશ્રીમાં ઘણા લાંબા સમયથી વિચારણા હેઠળ હતું. જે અન્વયે નીચે મુજબનો સુધારો કરવામાં આવે છે.

EXISTING CLAUSE	AMENDMENT
Form B-1 Clause- 14.2 Form B-2 Clause- 14.2 Except that when the quantity of any item exceeds the quantity as in the tender by more than 30% the contractor will be paid for the quantity in excess of 30% at the rate entered in the SOR of the year during which the excess in quantity is first executed and for the material consumed in excess quantity the rate for the material to be charged would be basic rate taken into account for fixing the rate for the SOR above instead of the rate stipulated in Schedule-A.	Form B-1 Clause- 14.2 Form B-2 Clause- 14.2 Except that when the quantity of any item exceeds the quantity as in the tender by more than 10% the contractor will be paid for the quantity in excess of 10% at the rate entered in the SOR of the year during which the excess in quantity is first executed or tender rate whichever is less.

ઉપરોક્ત તમામ સુચનાનો અમલ ચુસ્તપણે તાત્કાલિક અસરથી કરવાનો રહેશે.

ગુજરાત રાજ્યના રાજ્યપાલશ્રીના હુકમથી અને તેમના નામે,

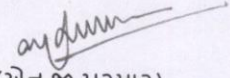
(એન.જી.પરમાર)

ખાસ ફરજ પરના અધિકારી (વિ.યો.)

માર્ગ અને મકાન વિભાગ

ગાંધીનગર

**STANDARDS FOR CEMENT
CONSUMPTION FOR DIFFERENT
ITEMS OF WORK**

Government of Gujarat
Roads & Building Department,
Circular No. PRC/10/2017/Cement Consumption/16/C
14, Sardar Bhavan, 2nd Floor,
Sachivalaya, Gandhinagar
Date:- 11/05/2017

Read:- Government of Gujarat, Road & Building Department, Sachivalaya, Gandhinagar Circular No. SOR/1085/7/H(1) dated 08/12/1986.

CIRCULAR

The uniform rate of cement consumption for various item was prepared and circulated vide No. SOR/1085/7/H(1) dated 08/12/1986.

At the outset, current practice of estimating cement consumption in concrete item of various Building, Bridge and Road project is based on above circular. However, it is generally observed that the cement consumption derived by actual mix design is lower than the standard cement consumption. Some of provision of the said circular become obsolete due to subsequent revisions in the relevant IS code and IRC code. The maximum cement consumption as per IS : 456-2000 and IRC : 112-2011 is 450 Kg./m³. Also cement industry and aggregate crushing industry have involved better quality of cement and aggregate over the years which have far reaching impact on mix design of the present day concrete.

Mix design report of GERI reflecting entire Gujarat region have been considered in averaging the cement consumption in various grade of design mix concrete. To minimize the difference between standard cement consumption of cement and actual consumption derived by mix design by GERI and the cement consumption as per provision of IS and IRC code falling cement consumption is proposed for estimation purpose.

Looking the above facts, the cement consumption mentioned in circular vide No. SOR/1085/7/H(1) dated 08/12/1986 is required to modify as per below:

EXISTING ITEM			AMENDMENT		
Item	Unit	Quantity of cement to be used per unit quantity of work in Kg	Item	Unit	Quantity of cement to be used per unit quantity of work in Kg.
Building, Road & Bridge Items					
Providing & casting in situ ordinary cement concrete M75 for PCC work	Cu.m.	160	Providing & casting in situ ordinary cement concrete M7.5 for PCC work	Cu.m.	160
Providing & casting in situ ordinary cement concrete M100 for PCC work	Cu.m.	220	Providing & casting in situ ordinary cement concrete M10 for PCC work	Cu.m.	220
Providing & casting in situ ordinary cement concrete M150 for PCC work	Cu.m.	320	Providing & casting in situ ordinary cement concrete M15 for PCC work	Cu.m.	290
Providing and casting situ control cement concrete M200 for RCC work	Cu.m.	400	Providing and casting situ control cement concrete M20 for RCC work	Cu.m.	360
Providing and casting situ control cement concrete M250 for RCC work	Cu.m.	450	Providing and casting situ control cement concrete M25 for RCC work	Cu.m.	380
Providing and casting situ control cement concrete M350 for RCC work	Cu.m.	500	Providing and casting situ control cement concrete M35 for RCC work	Cu.m.	425
Providing and casting situ control cement concrete M400 for RCC work	Cu.m.	525	Providing and casting situ control cement concrete M40 for RCC work	Cu.m.	440
Providing and casting situ control cement concrete M450 for RCC work	Cu.m.	540	Providing and casting situ control cement concrete M45 for RCC work	Cu.m.	450
New Item					
-	-	-	Providing and casting situ control cement concrete M30 for RCC work	Cu.m.	410

The cement consumption of other than above concrete item and other details mentioned in circular vide No. SOR/1085/7/H(1) dated 08/12/1986 will be remain same.

(N.G. Parmar)
Officer on Special Duty (S.P.)
R&B Department
Gandhinagar

To,

- 1) The Personal Secretary, Office of the Secretary, Road & Building Department, Sachivalaya, Gandhinagar
- 2) The Personal Secretary, Office of the Secretary, Narmada, Water Resources, Water Supply and Kalpsar Department, Sachivalaya, Gandhinagar
- 3) The Personal Secretary, Office of the Principal Secretary, Health & Family Welfare Department, Sachivalaya, Gandhinagar
- 4) The Personal Secretary, Office of the Additional Chief Secretary, Urban Development and Urban Housing Department, Sachivalaya, Gandhinagar
- 5) The Personal Secretary, Office of the Principal Secretary, Panchayat, Rural Housing and Rural Development Department, Sachivalaya, Gandhinagar
- 6) Accountant General, Rajkot/Ahmedabad
- 7) All the Chief Engineers, Road & Building Department, Sachivalaya, Gandhinagar
- 8) All the Chief Engineers, Narmada, Water Resources, Water Supply and Kalpsar Department, Sachivalaya, Gandhinagar
- 9) The Managing Director, Gujarat State Road Development Corporation, Nirman Bhavan, Gandhinagar
- 10) The Chief Engineer & Director, Staff Training College, Gandhinagar
- 11) The Director, Gujarat Engineering Research Institute (GERI), Vadodara
- 12) The Under Secretary, Gujarat Vigilance Commission, Vigilance Bhavan, Gandhinagar
- 13) All the Superintending Engineers, Road & Building Department (State, Panchayat, National Highway, Capital Project Circle, Electric Circle)
- 14) All the Executive Engineers, (as above circles)
- 15) All Technical Officers, Road & Building Department, Sachivalaya, Gandhinagar
- 16) All Technical Branches, Road & Building Department, Sachivalaya, Gandhinagar
- 17) President, Gujarat Contractors Association, Gajjana Hall, Law Garden, Law College Road, Ahmedabad
- 18) Branch Select file-2017.

રસ્તા, પુલો અને મકાનોની ગુણવત્તા
ચકાસણી માટેના નિયતપત્રકોનો ઉપયોગ
ઇન્સ્પેક્શન નોંધ માટે કરવા બાબત

ગુજરાત સરકાર
માર્ગ અને મકાન વિભાગ
બ્લોક નં.૧૪/૨, સરદાર ભવન,
સચિવાલય, ગાંધીનગર
ક્રમાંક: PRC-10-2017-31-C
તા.૨૬/૦૫/૨૦૧૭

પરિપત્ર

માર્ગ અને મકાન વિભાગના રસ્તા, પુલ અને મકાનના કામો ઇજારદારશ્રી મારફત કરાવવામાં આવે છે. આ કામોની ગુણવત્તા ચકાસણી કરવાનું કામ ગુણવત્તા નિયમન (મા.મ.) વિભાગ દ્વારા કરવામાં આવે છે. કામોની ચકાસણી માટે ગુણવત્તા નિયમન (મા.મ.) વિભાગ હેઠળ ગુજરાત રાજ્યમાં કુલ-૬ (છ) કાર્યપાલક ઇજનેરશ્રીઓની નિમણૂક કરવામાં આવેલ છે. કામોની ગુણવત્તા ચકાસણી કરી તેનો સ્થળસ્થિતિ મુજબનો ઇન્સ્પેક્શન રીપોર્ટ કાર્યપાલક ઇજનેરશ્રી દ્વારા તૈયાર કરી જે તે સંબંધિત કાર્યપાલક ઇજનેરશ્રીને પૂર્તતા અર્થે સાદર કરવામાં આવે છે અને એની જાણ જે તે વિભાગના સંબંધિત અધિક્ષક ઇજનેરશ્રી અને મુખ્ય ઇજનેરશ્રીને કરવામાં આવે છે. ગુણવત્તા નિયમનના કાર્યપાલક ઇજનેરશ્રીઓ દ્વારા રજુ કરવામાં આવતા ઇન્સ્પેક્શન રીપોર્ટની વિગતોમાં એકસરખા ફોર્મેટ વિભાગ દ્વારા નિયત કરેલ ન હોવાથી એકસૂત્રતા રહેતી નથી.

મુખ્ય ઇજનેરશ્રીઓની કમિટીમાં નક્કી થયા મુજબ ઇન્સ્પેક્શન રીપોર્ટમાં એકસૂત્રતા રહે અને પી.એમ.જી.એસ.વાય.માં “ગ્રેડ સિસ્ટમ” વાળો રીપોર્ટ સાદર કરવામાં આવે છે એ પદ્ધતિએ ઇન્સ્પેક્શન રીપોર્ટનું ફોર્મેટ બનાવવા જણાવવામાં આવેલ હતું. માર્ગ અને મકાન વિભાગના રસ્તા, પુલ અને મકાન માટેના ગુણવત્તા ચકાસણી કરવા માટેના ઇન્સ્પેક્શન રીપોર્ટના ફોર્મેટ ગ્રેડ સિસ્ટમવાળા આ સાથે તૈયાર કરવામાં આવેલ છે. હવે પછી ગુણવત્તા વિભાગના મુખ્ય ઇજનેરશ્રી, અધિક્ષક ઇજનેરશ્રી, કાર્યપાલક ઇજનેરશ્રી, સંબંધિત અધિક્ષક ઇજનેરશ્રી તથા જે કોઇ પણ અધિકારીશ્રી ગુણવત્તા ચકાસણીની કામગીરી કરે તેમણે આ ફોર્મેટનો ઇન્સ્પેક્શન રીપોર્ટ માટે ઉપયોગ કરવાનો રહેશે.

કામની ચકાસણી કર્યા બાદ કામનો એકંદરે ગ્રેડ “S (Satisfactory), SRI (Satisfactory but require improvement) કે U (Unsatisfactory)” આપવાનો રહેશે.

(૧) જો ગુણવત્તા ચકાસણીમાં કામનો એકંદરે ગ્રેડ “S” મળશે તો એ કામ Satisfactory કક્ષાનું હોય કોઇ પૂર્તતા કરવાની રહેતી નથી.

(ર) જો ગુણવત્તા ચકાસણીમાં કામની એકંદરે ગ્રેડ "SRI" (Satisfactory but require improvement) મળશે તો જે તે આઉટમમાં "SRI U" ગ્રેડ મળેલ છે એ આઉટમની સુધારણા ટેન્ડરમાં જણાવેલ સ્પેશીકીકેશન મુજબ કરી એનો "ATR" (Action Taken Report) સંબંધિત કાર્યપાલક ઇજનેરશ્રીએ તૈયાર કરી જે તે ગુણવત્તા નિયમન વિભાગના કાર્યપાલક ઇજનેરશ્રીની કરીથી સ્થળ મુલાકાત કરાવશે અને ગુણવત્તા નિયમન વિભાગના કાર્યપાલક ઇજનેરશ્રી પૂર્તતા સાથે સહમત હોય તો અહેવાલ અધિક્ષક ઇજનેરશ્રી, ગુણવત્તા નિયમન વિભાગને સાદર કરશે. અધિક્ષક ઇજનેરશ્રી, ગુણવત્તા નિયમન વિભાગ પૂર્તતા અહેવાલ યોગ્ય હશે તો રીગ્રેડ એટલે "SRI U" માંથી "S" માટે ભલામણ કરશે. ત્યારબાદ સદરહુ પૂર્તતા અહેવાલ સંબંધિત અધિક્ષક ઇજનેરશ્રી મારફત સંબંધિત મુખ્ય ઇજનેરશ્રીને સાદર કરવાનો રહેશે. સંબંધિત મુખ્ય ઇજનેરશ્રીએ સદરહુ "ATR" મુખ્ય ઇજનેરશ્રી ગુણવત્તા નિયમન વિભાગને પૂર્તતા ગ્રાહ્ય રાખી "S" ગ્રેડીંગ આપવા માટે ભલામણસહ સાદર કરવાનો રહેશે. ગુણવત્તા નિયમન વિભાગમાંથી પૂર્તતા ગ્રાહ્ય રાખી "S" ગ્રેડીંગનું પ્રમાણપત્ર મુખ્ય બાદ જ આ આઉટમનું બાકીનું ચૂકવણ કરવાનું રહેશે.

(૩) ગુણવત્તા ચકાસણીમાં કામની એકંદરે ગ્રેડ "U" (unsatisfactory) મળશે તો જે તે આઉટમમાં "SRI U" મળેલ છે એ આઉટમમાં સુધારણા અથવા Reconstruction (આઉટમ કરીદો કરવી) ટેન્ડરમાં જણાવેલ સ્પેશીકીકેશન મુજબ કરી એનો "ATR" સંબંધિત કાર્યપાલક ઇજનેરશ્રીએ તૈયાર કરી જે તે ગુણવત્તા નિયમન વિભાગના કાર્યપાલક ઇજનેરશ્રીની કરીથી સ્થળ મુલાકાત કરાવશે અને ગુણવત્તા નિયમન વિભાગના કાર્યપાલક ઇજનેરશ્રી પૂર્તતા સાથે સહમત હોય તો અહેવાલ અધિક્ષક ઇજનેરશ્રી, ગુણવત્તા નિયમન વિભાગને સાદર કરશે. અધિક્ષક ઇજનેરશ્રી, ગુણવત્તા નિયમન વિભાગ પૂર્તતા અહેવાલ યોગ્ય હશે તો રીગ્રેડ એટલે "SRI U" માંથી "S" માટે ભલામણ કરશે. ત્યારબાદ સદરહુ પૂર્તતા અહેવાલ સંબંધિત અધિક્ષક ઇજનેરશ્રી મારફત સંબંધિત મુખ્ય ઇજનેરશ્રીને સાદર કરવાનો રહેશે. સંબંધિત મુખ્ય ઇજનેરશ્રીએ સદરહુ "ATR" મુખ્ય ઇજનેરશ્રી ગુણવત્તા નિયમન વિભાગને પૂર્તતા ગ્રાહ્ય રાખી "S" ગ્રેડીંગ આપવા માટે ભલામણસહ સાદર કરવાનો રહેશે. ગુણવત્તા નિયમન વિભાગમાંથી પૂર્તતા ગ્રાહ્ય રાખી "S" ગ્રેડીંગનું પ્રમાણપત્ર મુખ્ય બાદ જ સમગ્ર કામનું બાકીનું ચૂકવણ કરવાનું રહેશે.

કોન્ટ્રોલન સુચનાની આમલ ધુન્નપણે તત્કાલિક અસરથી કરવાનો રહેશે.

વિ.કે.કે.-

- (૧) રસ્તા, પુલ અને મકાનના કામોની ગુણવત્તા ચકાસણી માટેના નિયત પત્રકો
(૨) એ.ટી.આર.નું નિયત પત્રક

(એન.જી.પરમાર)
ખાસ કરજ પરના અધિકારી (વિ.યો.)
માર્ગ અને મકાન વિભાગ
ગાંધીનગર

TECHNICAL SPECIFICATIONS FOR CCTV SYSTEMS

Material specification CAMERA

Indoor IR Dome Varifocal Camera , IP Indoor IR Dome Fixed Camera, IP Outdoor IR Bullet Varifocal Camera		
Sr.No.	Feature	Vendor Compliance (Yes/No)
1	The camera shall incorporate a 1/2.8" progressive CMOS/MOS sensor	Yes
2	The camera shall support 1280(H) x 960(V) pixels effective with 2.8 mm lens (2048 x 1536)	Yes
3	The camera shall have a minimum illumination of 1 lux in color mode.	Yes
4	Supported Resolution shall be 1280 x 960 at 25 fps and 720p at 30 fps or better (2048 x 1536)	Yes
5	The Camera shall use H.264/H.265 and MJPEG compression.	Yes
6	Camera should support minimum simultaneous MJPEG and two independent H.264/H.265 high profile streams which are different resolutions	Yes
7	Camera shall incorporate bandwidth management per stream by selecting the particular area in the given field of view of camera to enhance bandwidth optimization.	Yes
8	Angular field of View of camera shall be Horizontal : 185 deg or more	Yes
9	The camera shall feature to transform shadows and dark areas into natural and crisp images in real time.	Yes
10	The camera shall reproduce The camera shall also feature intelligent digital back light compensation, digital wide dynamic range circuit, digital noise reduction and electronic sensitivity-up for real surveillance purposes under severe conditions.	Yes
11	The power source for the camera shall be PoE IEEE 802.3af (2.8W) compliant power device.	Yes
12	The camera shall be able to support uni-cast and multi-cast transmissions.	Yes

13	The camera shall have a built-in web server so that access to the IP video stream can be obtained using Internet Explorer Version 6.0 or better.	Yes
14	The Bandwidth Limit shall be adjustable to from 64 kbps to 4096kbps or unlimited.	Yes
15	The camera shall be capable of being configured to automatically transmit alarm images transfer via FTP file transfer and/or e-mail. In addition the camera shall support the scheduled transfer of image data via FTP to an FTP server.	Yes
16	The camera shall support following protocols: TCP/IP, UDP/IP, HTTP, RTSP, RTP, RTP/RTCP, FTP, SMTP, DHCP, DNS, DDNS, NTP and SNMP.	Yes
17	The camera shall support IPV4 and IPV6 network addressing.	Yes
18	The camera shall be capable of operating at an Ambient Temperature of 0 degrees C ~ +40 deg Celsius and IP66 rated	Yes
19	Safety/Regulation: CE/FCC	Yes
20	Approve make : Hikvision, Panasonic, Honeywell	Yes
21	The bidders have to submit project specific manufacturer authorization letter (MAF) stating support and right to bid on OEM's behalf for this project. Generic MAF will not be acceptable. Bidders failing to submit the MAF are liable for disqualification.	Yes

Material

Rack mountable 1.5U NVR: Supports up to 32 cameras at 1080p resolution video recording & video playback at real time, with 4 SATA HDD capacity, HDMI & VGA output

Video Recording Hardware		
Sr.No.	Feature	Vendor Compliance (Yes/No)
1	Main Processor : Dual Core	Yes

2	O.S. : Linux/Windows	Yes
3	Should support min 32 IP cameras	Yes
4	Audio : 1channel Input (RCA), 1channel Output (RCA)	Yes
5	Display Interface : 1 HDMI,1 VGA	Yes
6	Display Resolution: 1920 × 1080, 1280 × 1024, 1280×720 1024×768	Yes
7	OSD : Camera title, Time, Video loss, Camera lock, Motion detection, Recording	Yes
8	Compression: H.264/H.265 MJPEG	Yes
9	Resolution: 3Mp (2048 × 1536) / 1080p (1920 × 1080) / 720p (1280 × 720) / D1 (704 × 480) / VGA (640 × 480) / CIF (Yes
10	Record Mode: Manual, Schedule {Regular (Continuous), VMD, Alarm}, Stop	Yes
11	Recording Interval : Recording duration: 1~120 min (default: 60 min), Pre-record: 1~30 sec, Post-record: 10~300 sec	Yes
12	Alarm Action:Recording, PTZ, Tour, Alarm, Video Push, Email, FTP, Buzzer & Alarm pop-up	Yes
13	Analytics: Video Motion Detection, Video Loss & Camera Blank	Yes
14	Alarm Inout : 4 channel Relay Outputs : 2 channel	Yes
15	Search Mode: Time/Date, Alarm, VMD & Exact search (accurate to second), Smart search	Yes
16	Playback : Play, Pause, Stop, Rewind, Fast play, Slow play, Next le, Previous le, Next camera, Previous camera, Full screen, Repeat, Backup selection, Digital zoom	Yes
17	Backup mode: USB device/Network	Yes
18	Ethernet: 1RJ45 port(10/100/1000Mbps)	Yes
19	Network function: HTTP, TCP/IP, IPv4/IPv6, UPnP, RTSP, UDP, SMTP, NTP, DHCP, DNS, IP Filter, PPPoE, DDNS, FTP, Alarm Server	Yes
20	Max Users : 120	Yes
21	Smart Phone Support should be available	Yes
22	Internal HDD : upto 8TB with min 2 slots	Yes
23	External Interface :	Yes

	USB :2 ports (1 Rear USB3.0,1 Front USB2.0) RS232: 1 port, For PC communication & Keyboard RS485: 1 port, For PTZ control	
24	Safety / EMS Standard : Safety -CE, IEC60950-1 EMC-55022 Class B, EN55024	Yes
25	Operating Temp: -10°C ~ +55°C / Operating Humidity: 10% ~ 90%RH	Yes
26	Approve make : Hickvision, Panasonic, Honeywell, HP, IBM	Yes
27	The bidders have to submit project specific manufacturer authorization letter (MAF) stating support and right to bid on OEM's behalf for this project. Generic MAF will not be acceptable. Bidders failing to submit the MAF are liable for disqualification.	Yes

Client PC		
Sr.No.	Feature	Vendor Compliance (Yes/No)
1	Intel Core i7 or higher	Yes
2	8 GB of RAM DDR3,	Yes
3	4 SATA HDD hard drive (8TB SATA)	Yes
4	1 GB PCI-Express x16 dual-head video adapter, 100/1000 Ethernet Network Interface Card	Yes
5	16x DVD+/- RW Drive along with appropriate Operating System	Yes
6	Approve make : HP, Dell	Yes
42"LED		
Sr.No.	Feature	Vendor Compliance (Yes/No)
1	Type : LED	Yes
2	Size : 42" Flat Screen at high resolution	Yes
3	16:9 Aspect control	Yes
4	Viewing Angle : 178 deg	Yes
5	Resolution : 1920 x 1080 Full HD IPS LED	Yes

6	Input : Composite video / AV/ VGA/HDMI	Yes
7	Contrast Ration: 20000: 01	Yes
8	Approved Make: Samsung, Sony, Panasonic	Yes

Material

24p 10/100/1000 MBPS PoE Network Layer 2 manageable Switch

28 port 10/100 L2 managed POE switch with 4 nos 10/100/1000 gigabit ports (if required)			
S.N.	Features	Required Parameter	Vendor Compliance (Yes/No)
1	10/100 base port	28	Yes
2	10/100/1000 T port	2	Yes
3	Combo 10/100/1000T/SFP port	2	Yes
4	Switch capacity	17 Gbps	Yes
5	Flash	16MB	Yes
	CPU Memory	128MB	
6	POE Power	375W	Yes

7	Certifications	UL (UL 60950), CSA (CSA 22.2), CE mark, FCC Part 15 (CFR 47) Class A	Yes
15	Approved Make	Cisco, Avaya, HP	Yes

Material

12u Network / AV Rack

- It should be able to house all the network switches and recording hardware.
- Approved make : Valrack, APW, Rittal

Material

LAN cable of following size in existing pipe as per direction'[C]

CAT - 6

CAT 6 UTP Cables			
Sr. no.	Parameter	Tender requirement	Vendor Compliance (Yes / No)
1	ISO/IEC-11801 (2 edition) Class D, UL-94V0 rated plastics, RoHS compliance, ANSI/TIA/EIA-568-B.2-1 Category 6, Extrapolates up to 600 Mhz	Must Comply	Yes
2	Outer diameter: 6.0mm	Must comply	Yes
3	Cable shield	Unshielded	Yes
4	Number of conductors	8	Yes
5	Stranding	4 twisted Pair	Yes
6	Conductor type	23AWG bare annealed copper	Yes
7	Cable jacket material	PVC	Yes

8	Approved Make	Cisco, R & M, Nortel, 3Com,Digilink	Yes
---	---------------	--	-----

Material

PVC Conduit

- 25mm ISI mark
- Approved make : BPE or Equivalent

7. TECHNICAL SPECIFICATIONS FOR SUPPLY OF EARTHING SYSTEM

1.0 SCOPE OF WORK

- 1.1 Design, assembling, testing, painting, supply, delivery at site with all related accessories as per the specifications as specified below. Compliance with the provisions of this specification shall not relieve the Bidder of the responsibility of furnishing apparatus and accessories of proper design, electrically and mechanically suited to meet the operating requirements under the specified service conditions and be suitable for the purpose of which they are intended.

2.0 CODES & STANDARDS

- 2.1 The design, material, assembling, inspection and testing shall comply with all currently applicable statutes, regulations and safety codes in the locality where the system will be installed. The equipment shall also conform to the latest applicable standards and codes of practice as mentioned below.

2.2

Sr.	Item	Relevant IS / IEC
1	Code of Practice for Earthing	IS 3043
2	Insulation Co-ordination Application Guide	IS 3716
3	Code of Practice for Protection of Buildings and Allied Structures against Lightning	IS 2309
4	Indian Electricity Rules, 1956	
5	Indian Electricity Act, 1910	
6	National Electrical Code	
7	Low Voltage Electrical Installations-Part 5-54: Selection & Erection of Electrical equipment- Earthing arrangement & protective conductors.	IEC 60364
8	Protection Against Lightning –Part 3: Protection of structures & life Hazards	IEC 62305

TECHNICAL REQUIREMENTS

- 4.1 The earth grid shall consist of main grounding grid conductors forming a closed ring network with required number of Rod type earthing stations connected to it to provide a common earth for electrical equipments and metallic structures. Two distinct connections shall be made from each earthing station to the main grounding/earthing mat through GI/Cu. flat.
- 4.2 Earthing system should offer a resistance of less than 2 ohms throughout the year. In places where Soil resistivity is more, total length of the earthing rod has to be increased by adding 1m length rods (one over the other) to achieve low and stable resistance value. In rocky places, multiple earth rods have to be installed and inter-connected to get the required value.
- Minimum length for each earthing station to be 3 meters.
- 4.3 The earth bus in required numbers shall be installed in various plant open areas and rooms. Each earth bus shall be provided two distinct connections by GI/Cu flats / Cu. Flexible cable from the main grounding grid conductors available nearby. The plant/building equipment, metallic structures, tanks, etc. shall be brought to earth by providing two distinct connections between earth bus installed nearby and that equipments, tank, apparatus, etc.
- 4.4 Solid Copper coated rods are recommended as earth electrode than a pipe due to the fact that solid rods have much longer life and can be easily driven by electric/hydraulic hammers. Copper has much longer life than all other materials as explained in IS 3043.

4.5 GENERAL CONSTRUCTIONAL DETAILS

4.5.1 Pipe Electrode Earth Station

1. Copper coated Solid steel Rods shall be made of high tensile low carbon steel rod, molecularly bonded with 99.9% electrolytic copper with minimum coating thickness of 250 microns as per IEC 62561 part -2: Requirement for Conductor & Earth Electrodes.
 2. The length of the earth rod shall be 1 meter at least or as per manufacturer's recommendation, so that driving into the ground is easier. For dry areas, length of the rods can go up to several meters by driving the rods one over the other.
 3. For all the installation minimum length of the earthing rods shall be 3 mts minimum by adding similar rods.
 4. Earth rods should be of diameter 20 mm minimum. Additional rods should be added without external couplers. The earth rods should have peg & bore arrangement or similar such arrangement so that additional rods are added without external couplers.
 5. Interconnecting Strips / Earthing Conductor: Copper coated steel strips / tapes should be used to interconnect different earthing rods as well as horizontal earthing (Ring earthing). These strips should have a coating thickness of minimum 70 microns.
 6. The earth resistance shall be maintained with a suitable soil treatment.
-

-
7. The earth lead shall be fixed to the pipe with a nut and safety set screws. The clamp shall be permanently accessible
 8. Connectors/fasteners for connecting Electrode with Earthing conductor/strip should be of Stainless Steel as it is compatible with all other materials viz Copper, GI etc. Fasteners should be made of Stainless steel

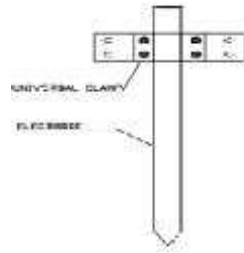

9. The depth of an earth electrode pipe shall be in approximately in accordance with the drawing as well as on nature of soil. However as per general guidelines, the pipe electrode shall have to be placed at depth where soft earth is available. This is to reduce the effect of earth resistance.

10. *Inspection Chamber :*

Should have an inner dimension of 250 mm X 250 mm X 250 mm made of FRP material. Flush Mounted, removable cover of the earth pit should be able to withstand moderate loads.

The area inside the inspection chamber should be such that, the UNIVERSAL CLAMP/EBB/Bus bars not too deep inside the inspection chamber or projecting out of inspection chamber.

The chamber should have facility for marking earth resistance and latest testing date by paint at the cover and previous recorded values inside the cover.

If the earthing is shown in road ways subject to vehicular movement, the Inspection Chamber to be of Cast Iron Type to absorb the vehicular loads without any deformation / damage.

11. Earth Enhancement material:

This is a conductive mineral compound to provide low resistance to the earth termination system. Earth enhancing compound should contain minerals which in normal use is reliable and without creating any hazards to persons and the surroundings.

The material shall be chemically inert to sub soil and shall not pollute the environment. It shall provide a stable environment in terms of physical and chemical properties and exhibit low resistivity. It shall not be corrosive to the earth electrode itself. The material should have low resistivity less than 50 Ohm meter

4.4 EQUIPMENT EARTHING

All apparatus and equipment transmitting or utilizing power shall be earthed in the following manner. Copper/G.I. Earth strips/wires shall be used unless other-wise indicated.

4.5 ELECTRICAL AND PERFORMANCE REQUIREMENTS

4.5.1 Power Transmission Apparatus

1. Metallic conduit shall not be accepted as an earth continuity conductor. A separate insulated continuity conductor of size 100% of the phase conductor subject to the minimum shall be provided.
2. Non metallic conduit shall have an insulated earth continuity conductor of the same size for metallic conduit. All metal junction and switch boxes shall have an inside earth stud to which the earth conductor shall be connected. The earth conductor shall be distinctly coloured (Green or Green / Yellow) for easy identification
3. Armoured cable shall be earthed by two distinct earth connections to the armouring at both the ends and the size of connection being as for the metallic conduit.
4. In the case of unarmoured cable, an earth continuity conductor shall either be run outside along with the cable or should form a separate insulated core of the cable
5. Three phase power panel and distribution boards shall have two distinct earth connections of the size correlated to the incoming cable size. In case of single phase DB's a single earth connection is adequate

5.0 DRAWINGS & INFORMATION

5.1 Drawing for Plate Type Earthing Station – Annexure-1

6.0 INSPECTION AND TESTING

6.1 The entire earthing installation shall be tested as per requirements of Indian Standard Specification IS: 3043

6.2 The following earth resistance values shall be measured with an approved earth megger and recorded.

1. Each earthing station
2. Earthing system as a whole
3. Earth continuity conductors

6.3 Earth conductor resistance for each earthed equipment shall be measured which shall not exceed 1 ohm in each case.

6.4 Measurements of earth resistance shall be carried out before earth connections are made between the earth and the object to be earthed

6.5 All tests shall be carried out in presence of the consultant / client

7.0 METHOD OF MEASUREMENT

7.1 Provision of earthing station complete with excavation, electrode, watering pipe, soil treatment, chamber with cover etc. shall be treated as one unit of measurement

7.2 The following items of work shall be measured and paid per unit length covering the cost of the earth wires / strips, clamps, labour etc.

1. Main equipment earthing grid and connection to the earthing station.
 2. Connection to the switch board, power panels, DB etc
-

- 7.3 The cost of earthing the following items shall become part of the cost of the item itself and no separate payment for earthing shall be made.
1. Motors - earthing forming part of the cabling / wiring for the motors.
 2. Isolating switches and starters should form part of mounting frame, switch starter etc.
 3. Light fittings - form part of installation of the light fittings.
 4. Conduit wiring, cabling - should form part of the wiring or cabling.
 5. Street lighting - should form part of the street light poles
- 8.0 TRANSPORT, DELIVERY AND STORAGE
- 8.1 The prices shall be F.O.R. site basis including packing & forwarding charges. The quoted price must include all the costs for necessary mode of transportation up to the final location of earthing system or site store. All incidental expenses during transportation shall be part of quoted prices including transit insurance. The charges for loading and unloading of equipments at site should form part of offer.
- 9.0 GUARANTEE & WARRENTY
- 9.1 The Bidder shall stand guarantee for the performance of entire equipment and components for twelve (12) months from the date of commissioning or eighteen (18) months from the date of dispatch, whichever is earlier, as agreed up on and as reproduced in the purchase order within the tolerance specified or as permitted by the relevant standards for the equipment in his scope of supply.
- 10.0 SPARES
- 10.1 Not applicable
- 11.0 MATERIALS REQUIRED
- 11.1 All required hardware such as bolts, nuts, washers (round and spring type), anchor fasteners, screws, etc. of sizes and type as required shall be conforming to relevant IS. All hardware shall be hot-dip galvanized or zinc passivated /cadmium plated as per requirement of work either mechanical fabrication or electrical jointing.
- 11.2 All other items required for installation shall be as approved by site in-charge.
- 12.0 INSTALLATION OF SYSTEM
- 12.1 The plate/pipe electrode, as far as practicable, shall be buried below permanent moisture level but in no case less than 3 M below finished ground level
- 12.2 The plate/pipe electrode shall be kept clear of the building foundation and in no case, it shall be nearer by less than 2 M from outer face of the respective building wall / column
- 12.8 Construction of the earthing station shall in general be as shown in the drawing and shall conform to the requirement on earth electrodes mentioned in the latest edition of Indian Standard IS: 3043, Code of Practice for Earthing Installation.
- 12.9 The earth conductors (Strips / Wires, Hot dip G.I. / copper) inside the building shall properly be clamped / supported on the wall with Galvanized Iron clamps and Hot Dip GI screws / bolts. The conductors outside the building shall be laid at least 600 mm. below the finished ground level/
-

-
- 12.10 The earth conductors shall either terminate on earthing socket provided on the equipment or shall be fastened to the foundation bolt and / or on frames of the equipment. The earthing connection to equipment body shall be done after removing paint and other oily substances from the body and then properly be finished
- 12.11 Over lapping of earth conductors during straight through in joints, where required, shall be of minimum 75mm. long and bitumen coated.
- 12.12 The earth conductors shall be in one length between the earthing grid and the equipment to be earthed
- 12.13 Minimum distance of 2 mtr shall be maintained between other electric conductor, earthing conductor and the conductor laid for the lightning protection system. Earthing and lightning protection system conductors shall be bonded to each other to prevent side flashover in case of non-availability of adequate clearance.
- 12.14 The earthing met conductors, risers, earthing cables, etc. passing through walls shall be covered with galvanized iron sleeves for the passage through wall. Water stop sleeves shall also be provided wherever the earthing conductor enters the building from outside.
-

Earthing Auguring Method

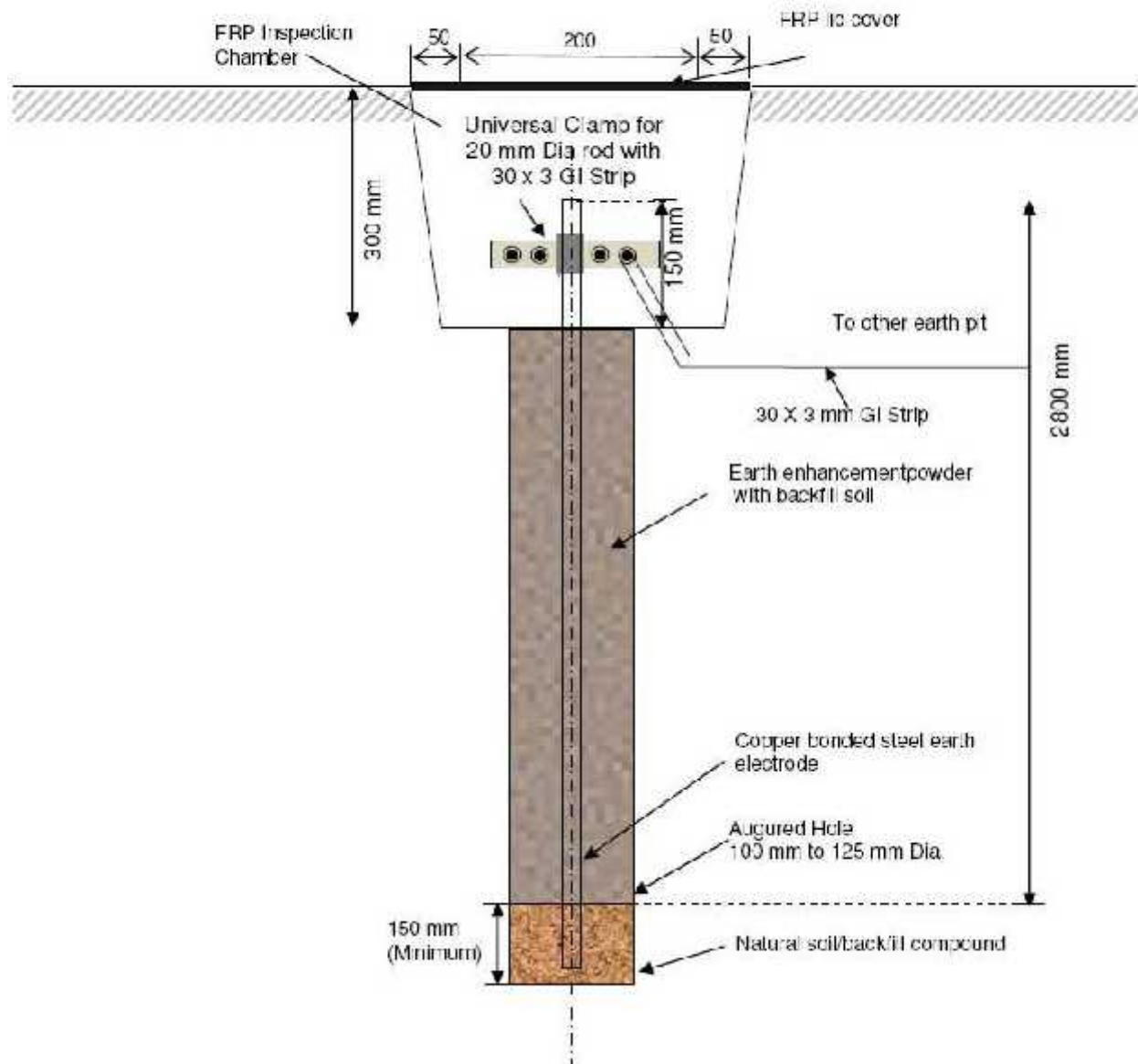

GENERAL PARTICULARS AND REQUIREMENTS ELECTRICALS

1. GENERAL

These specifications shall be read in conjunction with Condition of Contract, Bill of Quantities and Drawings to cover the Supply, Erection, Testing, and Commissioning of Electrical work.

1.1 Scope of work

The general character and the scope of work to be carried out under this contract are illustrated in Drawings, Specifications and Schedule of Quantities. The Contractor shall carry out and complete the same work under this contract in every respect in conformity with the contract documents and with the direction of and to the satisfaction of the Engineer. The contractor shall supply all labor, materials and equipment as required and specified for supply, Installation, Testing, Commissioning and Handing Over of the complete Electrical System. This also includes any material, equipment, appliances and incidental work not specifically mentioned herein or noted on the Drawings / Documents as being furnished or installed but which is necessary and customary to be performed under this Contract.

The Supply Authority will terminate their supply feeder in the HT metering panel from where the scope of this tender starts including installation of the Metering Panel.

The electrical Work mainly comprises of but not limited to –

- LT Power Distribution
- Light, FAN & Plug Point
- Cables and Wires
- SITC of Section Pillar, PCC Panel etc.
- Earthing System
- Light Design As per Lux Level Requirement & Execute accordingly.
- Get Permission of Concern Authority to Finished Work
- Liasoning Work for Power Supply

For execution of entire system, following are included in the Contractor's scope of

commencement of work to completion of work shall be borne by the contractor except the statutory fees for permanent work.

2.2 Shop Drawings / As-Built Drawings

Shop drawings / As-built drawings are to be prepared by the Contractor as stated in Scope of Work.

2.3 Material and Equipment

All materials and equipment shall in general have ISI Mark whichever available. The valid ISI certificate wherever available along with manufactures test certificate to be submitted before or along with dispatch of materials. Make shall be strictly in conformity with the list of approved manufacturers.

2.4 Manufacture Instructions

Where manufacturer has furnished specific instructions, relating to the material and equipment used in this project covering points not specifically mentioned in these documents, such instructions shall generally be followed in call cases. The specific requirement should be brought in to the notice of Engineer for their decisions.

3. Inspection and Testing

The Owner may carry out inspection and testing at manufacturer's works for this contract. NO equipment shall be delivered without prior written confirmation from Architect / Engineer. In case factory inspection is carried out, then all traveling and lodging expenses shall be borne by the Owner. However, all expenses related to testing shall be to Contractors account. Tests on site of complete works shall demonstrate the following among others.

That the equipment installed complies with specification in all respects and is of the correct rating for the duty and site conditions.

That all items operate efficiently and quietly to meet the specified requirements. That all electrical circuits are correctly protected and that protective devices are properly co-ordinate.

The contractor shall provide all necessary instruments and labor for testing shall make adequate records of test procedures and readings shall repeat any tests requested by the Architect / Engineer and shall provide test certificate signed by a property authorized person. Such test shall be conducted on all materials and equipment and tests on completed work as called for by the Architect / Engineer at

contractor's expenses unless otherwise called for.

If it is observed that the installation or part thereof is not satisfactorily carried out. Then the contractor shall be liable for the rectification and re testing of the same as called for by the Architect / Engineer decision as to what constitutes a satisfactory test shall be final.

The above general requirement as to testing shall be read in conjunction with any particular requirements specified elsewhere. All tests shall be carried out by a test house approved by the Architect / Owner.

3.1 Samples

The Contractor shall be required to have samples of various materials to be kept at site after approval by the Architect / Engineer.

4. Measurements

All measurements shall be as specified in Technical Specification or BOQ. In absence of any such method of measurement in the said documents, relevant IS Codes or any other approved standard shall be followed.

4.1 Bidders shall furnish the Technical Data Sheet as specified hereinafter.

TECHNICAL SPECIFICATION ELECTRIC WORK

SR NO 1. LT SWITCHGEAR PANEL

1.1 Scope

This specification covers the design, material, construction features, manufacture, supply, inspection and testing at the manufacturer's works, delivery and performance testing of L.T. Switchgear panel of voltage not exceeding 1000 V AC.

The switchgears would comprise of LT switch boards, power panels, control panels and Distribution Boards (DBs) required for the supply of power to the medium voltage equipment.

1.2 Codes & Standards

The design, construction, manufacture and performance of equipment shall conform

to latest applicable standards and comply with all currently applicable statutes, regulations and safety codes in the locality where the equipment will be installed. Nothing in this specification shall be construed to relieve the VENDOR of this responsibility.

Equipment shall conform to the latest applicable Standards as mentioned. In case of conflict between the Standards and this specification, this specification shall govern.

All components shall be of reputed/ approved make and subject to Client's approval.

1.3 Tests

- A. All tests shall be conducted in accordance with the latest edition of IS:2834 and as applicable for the controls.
- B. Type test certificates for similar capacitor units shall be furnished.

1.4 Constructional Features

- A. Switchgear panel shall be
 - (a) of the metal enclosed, indoor, floor mounted modular type
 - (b) made up of the requisite vertical sections
 - (c) of dust and vermin proof construction
 - (d) provided with a degree of protection
 - (e) easily extendable on both sides by the addition of vertical section after removing the ends covers.
 - (f) provided with a metal sill frame made of structural steel channel section property drilled for mounting the Switchgear along with necessary mounting hardware. Hardware shall be zinc plated and passivated.
 - (g) provided with labels on the front indicating the switchgear designation.
 - (h) provided with cable entry facilities at top and bottom with 3 mm thick removable gland plates and necessary cable glands.
 - (i) of uniform height of not more than 2200 mm
 - (j) of single front execution
 - (k) provided with gaskets all round the perimeter of adjacent panels, panel and base frame, removable covers and doors.
 - (l) provided with busbars running at the top or bottom, as required, all along the length of the switchgear in a separate sheet steel enclosure.

- B. Operating devices shall be incorporated only in the front of the Switchgear.
- C. The switchgear shall be provided into distinct vertical sections each comprising :
 - (a) A completely metal enclosed busbar compartment running horizontally.
 - (b) Individual feeder modules arranged in multi tier formation.
 - (c) Enclosed vertical bus bars serving all modules in the vertical section.
 - (d) A vertical cable alley covering the entire height.
 - (e) A horizontal separate enclosure for all auxiliary power and control buses, as required, shall be located so as to enable easy identification, maintenance and segregation from the main power buses. Tap-off connections from these buses shall be arranged separately for each vertical section.
 - (f) Each vertical section shall be equipped with space heaters which may be located in the cable alley.

Current transformers shall not be directly mounted on the buses. Current transformers on circuit breaker controlled circuits shall be mounted on the fixed portion of the compartment.

In breaker compartments, suitable barriers shall be placed between circuit breakers and all control, protective and indication circuit equipment including instrument transformers. External cable connections shall be carried out in separate cable compartments for power and control cables.

After isolation of power and control connections of a circuit, it shall be possible to safely carry out maintenance in a compartment with the bus bars and adjacent circuits live.

Cable alleys shall be provided with suitable hinged doors. It shall be possible to safely carry out maintenance of cable connections to any one circuit with the bus bars and adjacent live circuits. Adequate number of slotted cable support arms shall be provided for dressing the cables.

The withdraw able chassis housing circuit breakers shall be of the fully draw out type.

1.5 Sheet Metal Work

The switchgear frame shall be fabricated using suitable white CIRCA sheets of thickness not less than 2.5 mm.

Frames shall be enclosed by white CRCA sheet of thickness not less than 2 mm smoothly finished, levelled, and free from flaws. Doors and covers shall be made of white CIRCA sheets of thickness not less than 2mm. Stiffeners shall be provided wherever necessary.

The complete structure shall be rigid, self-supporting, free from vibration, twists and bends.

1.6 Painting

All sheet steel parts shall undergo rust proofing process to include degreasing, descaling and phosphating process with 7 tanks process. The steel works shall then be painted with the two coats of zinc chromate primer, final paint shall be powder coated in approved shade as per relevant IS. Thickness of powder coating shall be 65 microns.

MODE OF MEASUREMENT: AS PER MENTIONED IN SCHEDULE – B

Description

Mode of Payment: The rate shall be for a Unit of One Sq Mtr.

SR NO 2. CIRCUIT BREAKERS

2.1 General

Circuit Breaker shall be :-

- A. of the air break draw out type, electrically operated & mounted along with its operating mechanism on a wheeled carriage moving on guides, designed to align correctly and allow easy movements.
- B. of the shunt trip type
- C. provided with mechanically operated targets to show 'Open', 'Closed', 'Service' and 'Test' positions of the circuit breaker.
- D. provided with mechanically operated, red 'trip' push button, shrouded to prevent accidental operation.
- E. provided with locking facilities in the 'Service', 'Test', and 'Isolated', positions. In test position the breaker will be tested without energising the power circuits. The breaker shall remain fully housed inside the compartment in the test position.

- F. provided with 6 NO and 6NC potential free auxiliary contacts, rated 10A at 240V A.C. and 1A (inductive breaking) at 220 V D.C.
- G. provided with 'red', 'green' and 'amber' indicating lamps to show 'closed', 'open' and 'Auto-trip' conditions of the circuit breaker when breaker operation is controlled by a control switch.
- H. Circuit breaker closing and trip coils shall be rated for satisfactory operation on a control supply system.
- I. Closing and trip coil shall operate satisfactorily under the following conditions of supply voltage variation:
 - (a) Closing coils-85% to 110% of rated voltage
 - (b) Trip coils - 50% to 110% of rated voltage
- J. Conforming to IEC 947 1 & 2.

Circuit breakers shall be provided with the following interlocks.

- K. It shall not be possible to plug-in a closed circuit breaker, or to draw out a circuit breaker in the closed position.
- L. It shall not be possible to operate a circuit breaker unless it is in the fully plugged-in, test, or fully isolated position.

2.2 Operating Mechanism

- A. Power operated mechanism shall be of the motor wound spring charging stored energy type. The closing action of the circuit breaker shall charge the tripping spring ready for tripping. Speed of closing of contacts shall be independent of the speed with which the handle is operated. All stored energy mechanisms shall be provided with mechanical indicators to show the 'charged' and 'discharged' conditions of the spring.
- B. Circuit breakers provided with stored energy operating mechanisms shall be provided with the following interlocks. The circuit breaker shall not close unless the spring is fully charged. Shocks, vibrations, or failure of springs shall not operate the breaker or prevent intended tripping.
- C. Power operated mechanism shall be provided with a universal motor suitable for operation on DC. control supplies with voltage variation from 85% to 110% rated voltage, designed to enable a continuous sequence of closing and opening operation as long as power is available and at least one opening

operation on power supply failure, provided with emergency manual charging facilities, provided with facilities for remote panel Closing & opening operations.

- D. The control scheme will be as follows for remote control:
- E. All spare potential free contacts of all ACBs, MCCBs and contactors in main LT panel shall be wired up to the terminal block of individual module.
- F. Spring charging time for power operated mechanism shall not exceed 15 seconds. Power operating mechanism shall be provided with the following additional features. Closing of the circuit breaker shall automatically initiate recharging of the spring ready for the next closing stroke. The motor shall be mechanically decoupled as soon as the emergency manual charging handle is coupled. The circuit breaker mechanism shall make one complete closing operation once the control switch has been operated and the first device in the control scheme has responded even though the control switch is released before the closing operation is complete provided there is no counter trip impulse. Closing controls shall be so arranged that only one closing operation of the circuit breaker shall result from each close initiating impulse, even if the breaker trips while the initiating device is held in the 'close' position. An electrical anti pumping relay shall be provided on the circuit breaker chassis for this purpose, in addition to the mechanical anti pumping feature incorporated in the circuit breaker.

2.3 Protection Coordination

The circuit breaker shall be provided with microprocessor based overload, short circuit and earth fault protection releases, each with a wide setting range integrated in one module.

The microprocessor based trip units shall be provided with following features:-

- A. designed to withstand tough industrial environments i.e. high ambient temperatures, switching surges, electromagnetic interferences, vibrations and switching areas.
- B. reliably self-powered by built in current transformers.
- C. Motor setting shall be provided with 20 m sec delay to eliminate nuisance tripping caused by high peaks during motor start. It shall also provide single

phasing protection.

- D. LED display indication of each of over load, short circuit and earth fault.
- E. Integrated test button to check the healthiness of trip unit electronics and associated CT circuits without tripping the breakers.
- F. Alarm display for microprocessor fault.
- G. Query feature to indicate tripping cause upto 48 hours after instant of tripping without back up supply.
- H. Other features such as switchable zone scheme memory, opto-coupled outputs for remote signaling of a trip cause, switchable thermal memory, over temperature indication, communication capability.

It shall be the responsibility of the VENDOR to fully co-ordinate the overload and short circuit tripping of the circuit breakers with the upstream and downstream circuit breakers/fuses/motor starters. to provide satisfactory discrimination.

2.4 Moulded Case Circuit Breaker

MCCB shall be capable of breaking short-circuit currents up to levels as specified in Bill of Quantities / Drawing.

Moulded case circuit breakers shall be made of insulating case and cover made of high strength, heat resistant and flame-retardant thermosetting insulating material conforming to IEC 947 Part 2 of 1989, BS 3871, 1965 or other applicable standards.

The switching mechanism shall be quick make/quick-break type with double break contact system utilizing a trip free toggle mechanism. The handle position shall give positive indication of whether the breaker is ON (top), OFF (down) or TRIP (midway). For overload protection, three bimetal magneto-thermal release and electromagnetic releases for short circuit protection to be provided. The magneto-thermal release shall be variable and direct acting. All releases shall operate on a common trip bar so that all phases are disconnected in the event when fault occurs even on only one of them. The tripping mechanism shall be of an inverse time characteristics to prevent tripping on temporary overloads and shall not be affected by normal variation in ambient temperature.

The terminals shall have sufficiently large dimensions to accept links or cable lugs of suitable sizes. These shall be of a reputable manufacturer.

2.5 Switches /Miniature Circuit Breakers (MCB)

- A. Switches/MCBs shall be hand operated, air break, quick make, quick break type conforming to applicable standards.
- B. The switch shall be protected by fuse and the MCB shall be provided with overload/short-circuit protective device for protection under overload and short-circuit conditions. The switch action shall be trip free to inhibit closing under fault conditions. All brass parts shall be electroplated and all steel parts cadmium plated and all contacts silver plated. The minimum breaking capacity of MCBs shall be 10 kA r.GI. at 415V/220V D.C.
- C. Switch shall have provision for locking in both fully open and closed positions. MCBs shall be provided with locking facility.
- D. The connections between switch and fuse shall be insulated and all live connections shall be shrouded.
- E. Miniature circuit breakers shall be as specified elsewhere or approved. Each miniature circuit breaker shall be provided with spring-washer at each cable termination.

MODE OF MEASUREMENT: AS PER MENTIONED IN SCHEDULE – B

Description

Mode of Payment: The rate shall be for a Unit of One No.

SR NO 3 CABLE TRAYS & RACEWAYS

3.1 Scope

This specification covers the design, manufacture, testing at works, inspection and delivery at site of cable trays.

3.2 General

It is proposed that cables to be laid in the basement and vertical service shafts but not within lift shafts) will be laid on suitable cable trays.

Power and data wiring to Workstation receptacles shall be through conduits up to the

nearest wall. It shall drop to FFL concealed in ceiling or boxed in an aesthetically pleasing enclosure. Wiring up to workstation shall run in raceways.

3.3 Constructional Features

3.3.1 Material

The cable trays are to be manufactured from 2mm thick cold rolled sheet steel. The same shall be shaped and cut using power driven dies/ cutters/ presses to the specified sizes and bolted/ together to form a standard length of cable tray and its accessories.

3.3.2 Finishing

The manufactured trays and all the accessories should undergo seven tank treatments and should be hot-dip galvanized as per BS-2629 The zinc coating of 60 microns has to be uniformly guaranteed The trays will be tested for this at site at random and the contractor should make available at site Alcometer (or approved equivalent meter) for carrying Out the test at site. The owners reserve the right to at random inspect the trays being manufactured at the manufactures factory.

The width of the cable trays is specified in the schedule of quantities. The other details will be as shown in the drawings.

GI coupler plates with GI Jointing hardware is to be included in the rates of the contractor.

In case of GI perforated tray of width 150mm the height of the side walls shall be 50mm.

The following accessories are also to be supplied and installed by the contractor and the cost of the same is to be included in the rates for straight lengths to be quoted in the schedule of quantities.

Couple plates and hardware (as stated above).

- (a) Vertical elbow up
- (b) Reducer
- (c) Horizontal Tee
- (d) Horizontal Cross Piece
- (e) Horizontal Elbow
- (f) Vertical Elbow Down

- (g) Providing cold galvanized paint touch up at site wherever trays, accessories and supports are cut/ drilled after hot dip galvanizing.

3.3.3 Bends

The trays should have radius so as to enable a bending radius of 12 x Dia. of largest cable to be laid in the tray.

3.3.4 Supporting Steel Work For Trays

Supporting structural steel members to be made from 50mm x 50mm x 6mm GI. angles, 50mm x 6mm GI. flats for trays of width 600mm & above and 40mm x 40mm x 6mm GI. angles, 40mm x 6mm GI. flats for trays of width less than 600mm and GI. channels duly hot dip galvanized. In general on horizontal runs cable trays of width > 600mm & above will be supported at every 1 Mtr. and trays of smaller width be supported at 1.2 Mtr intervals. In vertical runs the trays should be supported at every 1 Mtr interval. Every horizontal bend will also be given an extra support.

3.3.5 Measurement

The installed trays and accessories will be measured at the central axis of the tray and bends. Bends, reducers, elbows, coupler plates, hardware & steel supports will not be measured separately.

3.3.6 Floor Raceway

Floor raceway of hot dip galvanised / aluminium sheet of 14 g / 2.0 mm shall be used and the dimensions for the same shall be as per the BOQ. The raceways shall be as per the make specified in the tender, The raceways shall be free of any sort of welding edges or other sharp edges to protect cutting of wires during pulling. The raceways shall be laid with use of junction boxes fabricated from 14 g hot dip GI as per drawing.

MODE OF MEASUREMENT: AS PER MENTIONED IN SCHEDULE – B

Description

Mode of Payment: The rate shall be for a Unit of One Rmtr.

SR NO 4 EARTHING

4.1 Scope

This specification covers the supply, installation testing and commissioning of the Earthing system.

4.2 Standards

- A. IS 62305 2010 - Code of Practice for the protection of buildings and allied structures against lightning
- B. IS: 3043 (1987) - Code of Practice for earthing
- C. Indian Electricity Rules 1956
- D. Indian Electricity Act 1910
- E. CEIG Regulations

4.3 General Requirement

Complete earthing system comprising earth electrodes in conjunction with earth grid shall be provided for the substation and control room for achieving a safe step and touch potential.

The exact location of Earth Bus/conductor, earth electrodes and earthing points on the equipment shall be determined at site in consultation with the contractor. Any change of methods, routing and size of conductor shall be subject to approval by the contractor.

4.3.1 Details of Earthing System:

- A. Main Earth Grid - 50 x 6mm GI Flat
- B. Power Transformer Neutral - 50 x 6mm Cu. Flat
- C. Transformer Body - 50 x 6mm GI Flat
- D. Equipment to Main Grid - 25 x 6mm CI Flat
- E. DBs/Junction Boxes - 8 SWG GI Wire
- F. Lightning Protection - 1 x 70 mm Cu flexible

4.3.2 Earth Electrodes in Earth Pits

Plate Earthing

Plate electrodes of G.I. shall be 600 x 600 x 6mm. thick and of copper shall be 600 x 600 x 3mm. thick unless otherwise specified.

Earth bus is a Copper/G.I. strip or flat of specified size interconnecting all earth electrodes. This will be laid throughout the length of electrical shaft (2 nos. per shaft).

Chemical Earthing Electrode

Supplying & erecting earth pit of minimum bore dia.150mm size approved make

Earthing Electrode consisting Pipe-in-Pipe Technology as per IS 3043-1987 made of corrosion free G.I.Pipes having Outer pipe dia of 50mm having 80-200 Micron galvanising, Inner pipe dia of 25 mm having 200-250 Micron galvanising, connection terminal dia of 12mm with constant ohmic value surrounded by highly conductive compound with high charge dissipation.

Length of Pipe : As per mentioned in BOQ

Back filling Compound : As per mentioned in BOQ or Required to achieve desire resistance level.

4.3.3 Artificial Treatment of Soil

If the earth resistance is too high and the multiple electrode earthing does not give adequate low resistance to earth, then the soil resistivity immediately surrounding the earth electrodes shall be reduced by adding sodium chloride, sodium carbonate, copper sulfate, salt and soft coke or charcoal in suitable proportions.

4.3.4 Resistance to Earth

The resistance to each earthing system shall not exceed 1.0 ohm.

4.3.5 Earthing Station

Plate Electrode Earthing

- A. Earthing electrodes shall consist of a galvanized iron plate not less than 600mm x 600mm x 6mm thick or copper plate not less than 600mm x 600mm x 3mm thick, as called for in the schedule.
- B. The plate electrode shall be buried as far as practicable below permanent moisture level but in any case not less than 2.5 mtrs. below ground level.
- C. Earth Electrode shall not be installed in proximity to a metal fence. It shall be kept clear of the building foundations and in no case shall it be nearer than 2 mtrs. from the outer face of the wall.
- D. The earth plate shall be set vertically and surrounded with 150 mm. thick layer of charcoal dust and salt mixture. 20mm.G.I. pipe shall run from the top edge of the plate to the ground level.

- E. The top of the pipe shall be provided with funnel and a mesh for watering the earth through the earth. The main earth conductors shall be connected to the electrode just below the funnel, with proper terminal lugs and check nuts. The funnel over the G.L pipe and earth connections houses in a masonry chamber, approximately 350mm. length x 300mm. wide and 300mm. deep. The masonry chamber shall be provided with a cast iron cover resting over a C.I. frame embedded in masonry.

4.4 Earthing Layout

Earthing conductors in outdoor areas shall be buried at least 600mm below finished grade level unless stated otherwise.

Wherever earthing conductors cross cable trenches, underground service ducts, pipes, tunnels, etc. it shall be laid minimum 300 mm below and shall be re-routed in case it fouls with equipment structure foundations.

Tap-connections from the earthing grid to the equipment/structure to be earthed shall be terminated on earthing terminals of the equipment/structure, if the equipment is available at the time of laying the grid, otherwise "earth riser" shall be provided near the equipment foundation, pedestal for future connections to the equipment earthing terminals.

Earthing conductors along their run on cable trench ladder columns, beams, walls, etc. shall be supported by suitable cleating at intervals of 750 mm. Earthing conductors along cable trenches shall be cleated to the wall nearer to the equipment.

Cable trays and supports shall be connected to the earth mat at every 30 meters interval. Wherever it passes through walls, floors, etc. GI sleeves shall be provided for the pasGMCE of the conductor.

Earthing conductor around the building shall be buried in earth at a minimum distance of 2000 mm from the outer boundary of the building.

4.5 Jointing

Earthing connections with equipment earthing pads shall be bolted type. Contact surface shall be free from scale, paint enamel, grease, rust or dirt. Two bolts shall be

provided for making each connection. Bolted connections, after being checked and tested shall be taped with PVC tape.

Resistance of the joint shall not be more than the resistance of the equivalent length of the conductor.

MODE OF MEASUREMENT: AS PER MENTIONED IN SCHEDULE – B

Description

Mode of Payment: The rate shall be for a Unit of One No.

SR NO 5 WIRING

5.1 Point Wiring

5.1.1 Scope

Providing specified size of FRLS insulated, copper conductor, 1.1kV grade, ISI marked of required color coding of approved make both for supply and earthing and drawing these wires through already laid Medium duty PVC conduits with fish wire, ferruling by coding tags as per relevant drawings and duly connecting with lugs, complete finishing, removing debris from site; testing the installations for safety and beneficial use.

5.1.2 Wires: Mains I Sub-mains I Circuit Mains (comprising phase and neutral wires):

The wires shall be 650 / 1100 V, PVC insulated, FRLS unarmored with stranded copper conductors, unless otherwise specified. The wires shall conform to IS:694.

The minimum area of conductors shall be 1.5 sq. mm for light fittings; 2.5 sq.mm for receptacles rated 6 A receptacles and 4 sq.mm for 16 A and above.

The wires shall be coated red, yellow, and blue for R, Y, B phase and black for neutral. Unless otherwise specified, external lighting cables shall be of 1.1 kV grade, 3C, PVC insulated and armoured type fed from main distribution boards.

Lugs:

Copper lugs of required size and type.

Glands:

Glands at terminating end of required size and type.

Other Material:

Rubber grommet, bush, harnessing material, etc.

5.1.3 Drawing of Wires

Wires shall be drawn with adequate care. Correct color coding as per shall be used for phase, neutral and earth. Wires shall not have intermediate joint in between terminals of the accessories. Earth-wire and Return wire (neutral may be looped only within circuit. For lighting load or single phase distribution wires of two different phases shall not be drawn in single pipe. Lead wires of sufficient extra length shall be provided and shall be terminated in the terminals of accessories only, with correct type of and correct size of tugs.

Bush shall be used at pipe opening to protect wire insulation from getting damaged due to burrs I sharp edges.

5.1.4 Testing:

Insulation resistance test:

All wiring shall be tested with 500V meggar between phases, phase-neutral and to Earth. IR value shall not be less than 1 M-ohm.

Polarity test:

Polarity test shall be carried out for ensuring correct polarity plug and switch.

5.1.5 Table No- I

Colour Code for Wires

Type	Colour
Phase	Red, Yellow, Blue
Neutral	Black
Earth	Green

MODE OF MEASUREMENT: AS PER MENTIONED IN SCHEDULE – B

Description

Mode of Payment: The rate shall be for a Unit of One No.

SR NO 6 SWITCHES & SOCKETS

6.1 Switches

The switches shall be single pole, single or two way as shown in respective internal

lighting drawings. They shall be of moulded type rated for 250 volt, and of full 6 / 16 A capacity. They shall be provided with insulated dollies and covers.

The switches shall be rocker operated with a quiet operating mechanism with bounce free snap action mechanism enclosed in an arc resistant chamber. The switches shall have pure silver and silver cadmium contacts. The switches shall be flush modular type. The make of the switches shall be as indicated in the drawings or BOQ or make of material or as suggested and approved by the client. The switches installed in outdoor area shall be industrial, metal clad type, and shall be provided in weather proof enclosures, complete with weather proof gasket covers.

6.2 Sockets

Each socket shall be provided with control switch of appropriate rating. The sockets shall be moulded type, rated for 250 volts, and either of full 6 A or 16 A capacity, as mentioned on the drawings.

Sockets shall be of three pin type, the third in being connected to earth continuity conductor. The socket shall be flush modular type. The sockets installed in machine room, plant room or wet / damp area shall be metal clad weather proof type. The finishing and make of all the sockets shall be same as light switch. The socket shall have fully sprung contacts and solid brass shrouded terminals to ensure positive electrical connections.

The sockets shall be provided with automatic shutters, which open only when earth pit of the plug inserts in the socket.

The socket shall be provided with three pin plug top suitable to the socket and of the same make as socket.

6.3 Boxes

The boxes for switches and sockets shall be 18 gauge galvanised sheet steel as manufactured by the switch manufacturer and suitable to accommodate grid type switches. The size of enclosure boxes shall be chosen to accommodate the number of switches to be installed at the particular location.

Separate screwed earth terminal shall be provided in the box for earthing purpose. All boxes shall have adequate no. of knock out holes of required diameter for conduit entry. Switch boxes to receive switches, socket outlets, power outlets, Telephone outlets, fan regulators, etc. shall be fabricated to the approved shape and size to accommodate all the devices without overcrowding. Outlet boxes to receive ceiling fan shall be fitted with adequately sized rod I hook to fix ceiling fan. The boxes shall be of minimum depth of 65 mm.

MODE OF MEASUREMENT: AS PER MENTIONED IN SCHEDULE – B

Description

Mode of Payment: The rate shall be for a Unit of One No.

SR NO 7 CONDUITS

7.1 Scope

Providing specified rigid PVC conduit and laying I erecting in RCC work, such as slab, beam, column before casting, surface, wall, ceiling, etc including entries through wall as per requirement and as per approved method of construction. The scope also includes supply and installation of accessories for the PVC pipes of same make as that of pipe; such as spacers, saddles, couplers, bends, inspection or non-inspection type elbows, tees, junction boxes of required ways and resin I adhesive to make all joints rigid, duly finishing, removing debris from site. Hardware like sheet metal screws of specified sizes, washers, raw/ PVC/ fill type plugs, wooden gutties.

7.2 Material

All conduits, fittings & accessories shall be rigid PVC conduit as indicated in the BOQ and shall comply with IS:9537. All pipes shall have ISI mark on each length of conduit. The minimum size of conduit shall be 20 mm.

The conduits shall be uniformly circular in cross section. The nominal length of conduit used shall be 3 or 4 meter. Joints shall be avoided as far as possible in the conduits. The interior of conduit shall be free from obstruction which might interfere with ready introduction I withdrawal of maximum no. of cables permitted. The ends of conduits shall be reamed and filed to remove rough edges and inside surface shall be smooth and free from burrs and other defects. All conduits shall be provided with approved type of fish wire.

7.3 Method of Construction

7.3.1 General:

Work shall be done in co-ordination with civil work to suit final approved layout. Conduit shall be duly clamped and size of conduit shall be correct depending on number of wires to be drawn. Separate pipe shall be used for each phase in single phase distribution and also for wiring other utilities like data, telephone. TV cabling, etc, for which distance between pipes shall be not less than 300mm or anti electrostatic partition is to be provided. Adequate use of conduit accessories shall be made at required locations. Entries in wall shall be at level of corresponding conduit with color coding. (For visual identification). Flexible conduits shall be used at expansion joints. Erection shall be done as per the layout finalized, with minimum sharp bends, with junction boxes at angular junctions and for straight runs at every 425m, in such manner so as to facilitate drawing of wires. All bending of conduits shall be done in approved manner without changing the cross-section.

Table No. 2. Colour Coding for Conduits in Wall Entry

Conduit for	Colour
Light / Power Circuit	Black
Security wiring	Blue
Fire Alarm wiring	Red
Low Voltage circuits	Brown

MODE OF MEASUREMENT: AS PER MENTIONED IN SCHEDULE – B

Description

Mode of Payment: The rate shall be for a Unit of One Mtr.

SR NO 8 TESTING AND COMMISSIONING

8.1 General

The testing and commissioning for all electrical equipment at site shall be according to the procedures laid down below:

All electrical equipment shall be installed, tested and commissioned in accordance with the latest relevant Standards and Codes of Practices published by Indian Standards Institution wherever applicable and stipulations made in relevant general specifications.

The testing of all electrical equipment as well as the system as a whole shall be carried out to ensure that the equipment and its components are in satisfactory

condition and will successfully perform its functional operation. The inspection of the equipment shall be carried out to ensure that all materials, workmanship and installation conform to the accepted design, engineering and construction standards as well as accepted codes of practice and stipulations made in the relevant general specifications.

All tests shall be carried out by the contractor using his own instruments, testing equipment as well as qualified testing personnel. The results of all tests shall be conforming to the specification requirements as well as any specific performance data guaranteed during finalization of the contract. Test sheets shall be prepared & submitted to contractor for approval within 1 month of award.

8.2 Preparation of the Plant for Commissioning

After completion of the installation at site and for the preparation of plant commissioning, the contractor shall carry out check and testing of all equipment and installation in accordance with the agreed standards, Codes of Practice of Indian Standards Institution and specific instruction furnished by the particular equipment suppliers as well as contractor.

Checking required to be made on all equipment and installations at site shall comprise, but not be limited to the following. The following checks shall be made on all equipment and installations at site:

Physical inspection for removal of any foreign bodies, external defects, such as damaged insulators, loose connecting bolts, loose foundation bolts etc-

Check for grease, insulating/lubricating oil leakage and its proper quantity
Check for the free movement of mechanism for the circuit breakers, rotating part of the rotating machines and devices.

Check for tightness of all-cable, busbar at termination/joints ends as well as earth connections in the main earthing network.

Check for clearance of live busbar and connectors from the metal enclosure.
Check for proper alignment of all draw out device like draw out type circuit-breakers. Continuity check in case of power cables
Checking of all mechanical and electrical interlocks including tripping of breakers using manual operation of relay.

Checking of alarm and annunciation circuits by manual actuation of relevant relays like Buchholz relay in case of transformer.

Check and calibrate devices requiring field adjustment calibration like

adjustment of relay settings etc.

Check proper connection to earth network of all non-current carrying parts of the equipment and installation.

Tests reports for all meters are to be furnished.

The tests that shall be carried out on the equipment shall include but not be limited to the following:

8.3 Low Voltage Switchgear (up to 1000V AC or 1200V DC)

Insulation resistance test with 1000V megger for main circuits. The minimum value of insulation resistance shall be 1 mega ohm.

Insulation resistance test with 500V megger for control metering and relaying circuits. The minimum value of insulation resistance shall be mega ohm. Relay operation test by primary & secondary injection method.

Functional tests of control circuit.

Checking of settings of all relay / releases as per single line diagram/specification.

ON/OFF operation of breakers both manually and electrically in "Test" as well as "Service" positions.

8.4 Cables

Insulation resistance test with 2,500 V megger for high voltage power cables rated above 1.1 KV grade and 1,000 V megger for cables rated up to 1.1 KV grade.

All cables of 1.1 KV and all HV cables shall be subjected to high voltage test after joining and terminating but before commissioning as per relevant standards.

In each test, the metallic sheath/screen/armor should be connected to earth.

Continuity of all the cores, correctness of all connections as per wiring diagram, correctness of polarity and phasing of power cables and proper earth connection of cable glands, cable boxes, armor and metallic sheath, shall be checked.

Power frequency withstand test.

Operational tests to know the correct functioning of all devices associated with the transformer

8.5 Earthing System

Tests to ensure continuity of all earth connections.

Tests to obtain earth resistance of the complete network by using earth tester.

The test values obtained shall be within the limits.

All documents / records regarding test data, oscillo graphs and other measured values of important parameters finalized after site adjustment shall be handed over to the Contractor in the form of test reports for their future use and reference.

All Checks/tests etc. to be carried out in presence of contractor's representative.

SR NO 9. GI POLE

Supplying & erecting Galvanized iron pipe post "B" class 88.9 mm O.D 6 mtr. Long duly painted with two coats of aluminum paint complete with metallic base- plate of 300 mm x 300 mm x 4mm thick for using as a compound light pole with approx. weight 47 Kg.

DETAILED TECHNICAL DATA SHEET FOR GI POLE

GI POLE

- Height of POLE : 6 Mtr
- Raw material : B CLASS GI PIPE
- Approx Weight : 47 Kg
- No. of section : ONE
- Metal protection treatment : HOT DIP GALVANIZED As Per BS

729 or Equivalent. Both Internally &

externally

- Thickness of Galvanization : As per IS 2629 / IS 2633 / IS 4759
- Terminal box power control : Sheet metal box of suitable size in
2mmThick to accommodate required

MCB

- Thickness of Galvanization : Average 85 Microns
- Outer Diameter : 88.9 mm

(TEST TO BE CARRIED OUT AT OEM END / FACTORY)

Dynamic Loading as per Prevailing at Site

- Max. wind speed : 180 Kms Per Hour as per IS 875-1987 Part III
- Max. gust speed time : 3 seconds
- Height above ground level (These above two levels are measured) : 6 Mtr
- Factor of Safety for wind load : 1.25
- Factor of Safety for other load : 1.15 (as per TR No. 7)

(Test report shall be produced)

Foundation Details

- size of foundation : As per Manufacturer's design
- Design safety Factor : As per IS :456
- Considered Wind pressure (Kg. /Sq. mm) : As per IS :875-1987
- Considered Wind speed (KM. /hrs.) : As per IS :875-1987
- Average Soil bearing capacity : As per site requirement
- Number of foundation bolts : 4 Nos.

(Test report shall be produced)

LUMINARIES

- Type : LED, OUTDOOR
- Quantity : As Per Light Design

(Test report shall be produced)

EARTHING

- Earthing : Suitable size earth termination shall be provided to connect with the proposed earth pit.
- No. of connection : ONE
- Final length : 150 Cm

General

- The POLE, Foundation and electrical drawing should be approved before commencement of work
- All safety measures shall be adopted while execute (E & C) the work

GUARANTY & WARRANTY

- One-year GUARANTY & WARRANTY certificate shall be provided by the Manufacturer of POLE and free service for first year shall be provided as when required for attending the breakdown etc

- For Light Fixtures there are two years of warranty from the dispatch date of materials.
- **MODE OF MEASUREMENT: AS PER MENTIONED IN SCHEDULE – B**
- **Description**
- **Mode of Payment: The rate shall be for a Unit of One No.**

SR NO 10. LED LIGHT

10.1 CODES & STANDARDS: -

IEC 60529 Classification of degree of protections provided by enclosures (IP Codes)

EN 55015, CISPR15 Limits and methods of measurement of radio disturbance characteristic of electrical lighting and similar equipment.

IEC 62031 LED modules for general lighting-Safety requirements

IEC 61547-EMC Immunity requirement

IEC 60598-2-1 Fixed general purpose luminaries

IEC 60598-1 Luminaries - General requirement and tests

IEC 61000-3-2 Electro Magnetic compatibility (EMC)- Limits for Harmonic current emission -- (equipment input current ≤ 16 A per phase.

IEC 60068-2-38 Environmental Testing: Test Z- AD: composite temperature/ humidity cyclic test

IEC 61347-2-13 Lamp control gear: particular requirements for DC or AC supplied electronic control gear for LED modules.

IS 10322 Specification for the luminaries

IS 4905 Method for random sampling

LM 79 LED luminary photometry measurement.

LM 80 Lumen Maintenance

IEC 62384 DC or AC supplied electronic control gear for LED modules performance requirements

IEC/ PAS 62612 Self-ballasted LED lamps for general lighting services- Performance requirements

10.2 ENVIRONMENTAL CONDITIONS: -

The average atmospheric condition during the year is mentioned below. The equipment shall be designed to work in such environmental conditions:

- (i) Maximum ambient air temperature: **50° C**
- (ii) Minimum ambient air temperature: **10° C**
- (iii) Max. Relative humidity: **90%**
- (iv) Average Rainfall: **55 inches**
- (v) Atmosphere: **Dusty and Heavy chemical smoke at times in certain areas.**
- (vi) Coastal area: The equipment shall be designed to work in coastal area in humid, salt laden and corrosive atmosphere.

10.3 CONSTRUCTIONAL FEATURES:

10.3.1 General:

- a) Luminaries shall be made of die cast aluminum/ extruded Aluminum body with powder coated finish having safety.
- b) Heat sink used should be aluminum extrusion having high conductivity. Heat sink should be integrated within luminaries and efforts shall be made to keep the overall outer dimensions
- c) optimum such that it permits sufficient heat dissipation through the body itself so as to prevent abnormal temperature inside the luminaries and consequential damage to cover, gasket material, LEDs, lenses and drivers.
- d) LED must be mounted on Metal core PCB with suitable large area surface by means of fins to dissipate the conduct heat. The fins must be exposed to ambient flowing air.
- e) All luminaries shall be provided with toughened glass of min. 0.8 mm thickness of sufficient strength. UV stabilized Poly carbonate material is also acceptable. High efficiency prismatic diffuser/Lens under the LED chamber to protect the LED and luminaries shall be provided.
- f) The minimum IK protection of optic cover shall be IK 05. The test material certificate shall be provided.
- g) Suitable number of LED lamps shall be used in the luminaries. The manufacturer shall submit the proof of procurement of LEDs from OEMs at the time of testing.
- h) Suitable reflector/ lenses may also be provided to increase the illumination uniformity and distribution.

- i) The electrical component of the LED and LED driver must be suitably enclosed in sealed unit to function in environment conditions mentioned earlier.
- j) The connecting wires used inside the luminaries, shall be low smoke halogen free, fire retardant e-beam cable and fuse protection shall be provided in input side.
- k) Design of the thermal management shall be done in such a way that it shall not affect the properties of the diffuser.
- l) The equipment should be compliant to IEC 60598-1, IEC 62031 and IEC/PAS 62612 depending on the type of luminary.
- m) The LED Module(s), Driver gear, etc. shall be designed in such a way so that temperature of heat sink shall not exceed 70° C.
- n) All the material used in the luminaries shall be halogen free and fire retardant confirming to standard.
- o) The infrastructure for Quality Assurance facilities to verify/ test/ prove above specifications must be available at the manufacturing facility. The compliance shall be indicated clearly in the tender itself.
- p) All fasteners must be of stainless steel.
- q) All glands inside/ outside luminaries must be metallic
- r) Heat sink must be thermally connected to MCPCB/ LED light source.

10.3.2 High power and high lumen efficient LEDs suitable for following features shall be used:

- a) The working life of the lamp at junction temperature of 85° C (max) at operating current shall be more than 50,000 working hours of accumulative operation and shall be suitable for continuous operation of 24 hours per day. These features shall be supported with datasheet.
- b) Adequate heat sink with proper thermal management shall be provided.
- c) Lumen maintenance report as per LM 80 guidelines shall be produced for the power LEDs used.
- d) Thermal management shall be in such a way that LED soldering point temperature shall not go beyond 75° C.
- e) The LED luminaries shall be free of glare.

10.3.3 LED DRIVER specification used for light:

- a) Current waveform should meet relevant nation and international standard.

- b) LED Driver shall withstand, withstand voltage up to level mentioned elsewhere in tender and restore once normal working when normal voltage is applied.
- c) The life of the driver should more than 25000 Hrs.
- d) Maximum Temperature rise $\leq 30^{\circ} \text{C}$ @ 45°C T_{amb} . With safety margin of 10°C .
- e) The control gear should be compliant to IEC 61347-2-13, IEC 62031 and IEC 62384 as per the requirements.
- f) The driver of the luminaries should have Short Circuit, Over Voltage, over current, over temperature, Under Voltage, String Open protections.

10.3.4 The electronic components used shall be as follows:-

- a) The protective cum adhesive coating used on PCBs should be cleared and transparent and should not affect colour code of electronic components or the product code of the company.
- b) The construction of PCBs and the assembly for components for PCBs should be as per IS standards.

10.4 Illumination Level:

The luminaries shall be so designed that the illumination level shall be evenly distributed and shall be free from glare. The lux distribution curve/ graph/ spatial distribution shall be submitted.

GENERAL DATA SHEET

Sr. No.	Parameter	Value/Detail
4.1.1	Rated Supply Voltage	230 V ~, 50 Hz
4.1.2	Input supply voltage range	120-270 V
4.1.3	Expected Input Frequency	50 Hz +/- 3%
4.1.4	Working Temperature	+5° to +50° C
4.1.5	Working Humidity	10% - 90% RH

4.1.6	UGMCE hours	Dusk to dawn
4.1.7	Power Factor	≥ 0.90
4.1.8	Index of Protection Level	IP 66 as per IEC 60529.
4.1.9	Surge Protection	4 KV
4.1.10	LED Chip efficacy	≥ 120 lm/ W
4.1.11	Driver Efficiency	$> 85\%$
4.1.12	Junction Temperature of LED	$< 85^{\circ}$ C
4.1.13	Rated Life @ L70	50,000 burning hours at 35° C ambient
4.1.14	Nominal Correlated Colour Temperature	5000° K to 6000° K
4.1.15	Dispersion Angle	Minimum 120°
4.1.16	Tilting angle	Adjustable
4.1.17	Maintenance factor of	0.85
4.1.18	Colour Rendering Index	≥ 85
4.1.19	Total Harmonic Distortion	$< 10\%$ (EMI/ EMC Certification)
4.1.20	LED MAKE	Cree/ Osram/ Nichia/ Philips Lumileds

Particulars and Details to be submitted by the bidder:

In order to properly assess and due diligence on submissions, the Bidder should provide following information on the quality and photometric of proposed luminaries.

1. **General Description**
2. **Electrical specifications**
3. **LED chip and driver information**
4. **Photometric information to be submitted**

10.5 TESTS & CERTIFICATES:

Tests are classified as:-

Type test

Acceptance test

Routine test.

The luminaries' should be tested as per IEC 60598-2-3: 2002 standards and following test reports should be submitted: -

- (i) Heat Resistance Test
- (ii) Thermal In SITU Test
- (iii) Ingress Protection Test
- (iv) Drop Test
- (v) Electrical/ Insulation Resistance Test,
- (vi) Endurance Test,
- (vii) Humidity Test,
- (viii) Electrical and Photometric Measurements Test Report (IES LM 79)
- (ix) LED Lumen Maintenance Test Report (IES LM 80)
- (x) Vibration test as per ANSI

10.5.1 Type Test: -

Type test certificates for both the luminaries' shall be provided with the technical-bid.

10.5.2 Acceptance Tests: -

These tests are carried out by an inspecting authority at the supplier's premises on sample taken from a lot for the purpose of acceptance of a lot. Acceptance tests shall not be carried out from particular size from the lot on which type tests have already been conducted. Recommended sampling plan is given below.

Sample size and criteria for conformity

The luminaries shall be selected from the lot at random. In order to ensure randomness of selection, procedures given in IS 4905-1968 (Reaffirmed 2001) may be followed.

10.5.3 Routine Tests:

These tests shall be performed by the manufacturer on each complete unit of the same type and the results shall be submitted to the inspecting agency, prior to offering the lot for acceptance test. The firm shall maintain the records with traceability.

Method of Testing: -

Visual and Dimensional Check:

The unit shall be checked visually for all dimensions as per approved design and

drawing.

General workmanship should be good; all the components properly secured and sharp edges shall be rounded off. Check the marking and quality of the workmanship visually. Check the rating and make of electronic/ electrical items.

Checking of documents of purchase of LED

Check Document of purchase of LED lamps of approved sources viz. NICHIA/ OSRAM/ PHILIPS LUMILEDS/ CREE.

Resistance to humidity test

This is carried out by suspending the painted panels in corrosion chamber maintained at 100% RH and temperature cycle of 42 to 48° C for 7 days and examining it for any sign of deterioration and corrosion of metal surface.

Insulation resistance test

The insulation resistance of the unit between earth and current carrying parts shorted together shall not be less than 2 MΩ when measured with 500 V megger.

HV test

Immediately after insulation resistance test, an AC voltage of 1.72 KV rms (1500 + 2 x rated voltage) of sine wave form of 50 Hz shall be applied for one minute between the live parts and frame. There shall not be any kind of break down, flashover or tripping of supply.

Over voltage protection

The LED Driver Shall be cut off once voltage exceeds 288 V AC. It shall be reconnected when supply comes within limit.

Surge protection

It shall withstand a surge of 4 KV at the input terminals for all types.

Reverse polarity

The Luminaries' shall withstand polarity reversal. It shall be operated with reverse voltage for Min. 1 minute at maximum value of voltage range. At the end of this period, the supply shall be made correct polarity and Luminary shall operate in a normal way.

Temperature rise Test:

Temperature rise Test shall be conducted at 100 V ~ with full load. The temperature rise shall be recorded by temperature detectors mounted at the specified reference points on the body of semiconductors, capacitors and other components as agreed between purchaser and manufacturer. The maximum-recorded temperature under worst conditions shall be corrected to 55° C and compared with maximum permissible temperature (for power devices at junction). Under loading conditions as specified above, the corrected temperature of the power devices shall have a safety margin of minimum 10° C.

Temperature at junction shall not exceed 100° C when corrected to 55° C. The Luminaries' shall also be subjected for short time rating after continuous loading to ensure the temperature rise is within the permissible limit. The maximum temperature rise of the electronics devices on the PCBs shall be in limit for industrial grade components suitable for 85° C environment. In case of exceeding limit, use of MIL-grade component shall be considered keeping RDSO informed.

Ra (Colour Rendering Index) measurement test

The lumen is the unit of luminous flux, which is equal to the flux emitted in a solid angle of one steradian by a uniform point source of one candela.

The initial reading of the chromaticity co-ordinates x & y shall be within 5 SDCM (Standards Deviation for Colour matching) from the standardised rated value as per Annex: D of IEC 60081- 1997.

The initial reading of the general colour-rendering index (Ra) shall not be less than the rated value decreased by 3.

The lumen maintenance of the lamp shall not be less than 80% of the initial lumen after 20,000 burning hours and 70% of the initial lumen after 50,000 hours. The initial lumen will be taken after 100 hours aging.

Photometric test shall be conducted as per Annexure: B of IEC 60081-97.

The lumen maintenance test shall be done as per Annexure: C of IEC 60081-97.

Fire retardant Test

Fire Retardant test shall be conducted as per IEC 60332-1 of the wire used in the luminaries.

Test for IP 65 protection

This test shall be conducted as per IEC 60529.

Environmental tests (Prototype Test)

The Luminaire shall meet the following tests as prescribed in IEC-60571.

- (i) Dry heat test.
- (ii) Damp heat test
- (iii) Test in corrosive atmosphere
- (iv) Combined dust, humidity and heat test

Reliability Test

The reliability can only be determined in actual service. However, the following tests shall be carried out on the prototype to simulate as close as possible, the service conditions.

There shall be no failure during this test.

- (i) The light unit shall be mounted in an oven maintained at 45° C.
- (ii) The light will be operated at the specified maximum voltage and at 45° C for a period of 100 hours.

10.5.4 Photometry Test: -

The test shall be carried out for Total Luminous Flux, Luminous Intensity Distribution, Electrical Power, Luminous Efficacy (calculation), Color Characteristics- Chromaticity, CCT & CRI etc. as per IES LM 79.

Life Test

The lumen maintenance & life test shall be done as per IES LM 80 for LEDs.

Endurance Test

The Luminaire shall be kept "ON" with input voltage of 250 V ~ for 200 hours. After this the Luminaire is subjected to 20,000 cycles of "ON" and "OFF", each cycle consisting of 3 seconds "ON" and 10 seconds "OFF" period. Luminaire should survive this test. Test is to be continued for 20,000 cycles, followed by

performance test.

Safety:

The Luminaire shall comply with the safety requirements as per IEC 61195.

All Tests defined for acceptance other than LM 79 and LM 80 are allowed to carry out at Manufacturer works.

10.6 MARKING:

The following information shall be distinctly and indelibly marked on the housing:

Year of manufacture/ Batch Number/ Serial Number

Name of Manufacturer (Engraving only, stickers not allowed)

Rated watt and voltage

Input frequency

**MODE OF MEASUREMENT: AS PER MENTIONED IN SCHEDULE – B
Description**

Mode of Payment: The rate shall be for a Unit of One No.

11. Water Purifier

Brand Name	Eureka Forbes
Item Weight	6.50 kilograms
Manufacturer Series Number	Aquaguard
Model Number	GWPDAG20010000
Number of Items	1
Part Number	AG 200
Special Features	UV , Gravity

12. LIFT

Supplying, Erecting, Testing & Commissioning the Automatic passenger / stretcher lift having following main features:\

[1] GEAR LESS LIFT DRIVE comprising of High Starting torque Lift duty 3 phase 440 V A. C. Permanent magnetic synchronous motor of proper rating with high efficiency shall be used.

[2] Micro processor based / PLC, ACVVF, vector control drive with encoder feedback closed loop system shall be used for lift car and door operation which shall be full collective selective operation hall call demand response, UP/DOWN hall stops, Main, Up/ Down Contactor with overload and phase reversal relay and safety controls.

[3] Car with M S platform with bracings of adequate size and to sustain the impact load cabin + passenger with safety factor of fire for steel and side panels of Stainless steel of sheet of grade 304 duty. Car ceiling will be S.S. finishes with aesthetic appearance with LED ceiling lights. Car flooring shall be of anti skid PVC with choice of colour of engineer in charge. Car doors shall be of stainless steel grade 304, hairline finish with centre opening / telescopic automatic doors. Car panel will also be S.S. 304 finished with emergency stop device, mechanical door safety device, facility of auto/ attended mode. All car panel buttons and all floor switches must be with brail language as per lift act.

[4] All landing doors shall be fully automatic centre opening/ telescopic opening made of hairline finish steel grade of 304 with key holes and infrared curtains with Unlocking facility from outside.

[5] Appropriate battery operated emergency light in the car along with alarm switch shall be provided.

[6] Digital scrolling indicator system for up-down arrow along with floor position indicator shall be provided inside the car and at all floors.

[7] Full height infra red curtain with multiple criss / crossing light beams shall be provided.

[8] Automatic Rescue Device (ARD) shall be provided accordingly of passenger capacity.

[9] Audio visual indication in the lift car showing over loading shall be provided such that doors kept open till excess load is removed.

[10] Spring buffers/PU Buffers shall be provided.

[11] Car fan with automatic sleep timer shall be provided.

[12] Voice annunciator with suitable music shall be provided in lift car.

[13] Self diagnostics system for operational and safety parameters shall be provided in control panel.

[14] Mechanical over speed governor, door key holes in the floor doors, fireman switch shall be provided.

[15] Lift machine hoisting arrangement in the lift machine room and monkey ladder for lift pit should be provided by the lift agency, along with the other steel structure works, foundations for the machine etc...

[16] In the hoist way fascia plate shall be provided without any extra cost, where ever required as / if directed by engineer in charge.

[17] Permanent wiring in lift machine room and lift well with proper numbers of light points, with fixtures, exhaust fan and plug points shall be provided by the agency. Power supply of 3 phase 440 V shall be made available by department in lift machine room.

[18] Any civil/ electrical works for additional and alteration in lift shaft and machine room related to erection of lift shall be made by lift agency without any extra cost.(granite/marble fixing around all landing door openings are not in lift agency's scope.)

[19] Agency has to provide all working drawings and documents and liaison services for obtaining all necessary permission from lift inspector and other authorities.

[20] As per statutory requirement of Got. Of Gujarat lift & escalator act 2000, lift agency has to provide

1. Car top safety barricade
2. Push & talk communication system.
3. Fireman's switch operation at Ground Floor

1. ABOUT SPECIFICATIONS:

1. This specification covers the requirement of design, manufacture, supply, erection, testing and commissioning of Passenger/Fire lift as specified.
2. It is not the intent to specify completely herein all details of the equipment. Nevertheless, the equipment shall be complete and operative in all aspects and shall conform to highest standard of engineering, design and workmanship.
3. Any material or accessory which may not have been specifically mentioned but which is necessary or usual for satisfactory and trouble free operation and maintenance of the equipment shall be furnished without any extra charge.

2. CODES & STANDARDS:

1. All equipment and materials shall be designed, manufactured and tested in accordance with the latest applicable Indian Standards (IS) except where modified and/or supplemented by this specification. Generally, the equipment should meet the requirements of the following standards and rules :
 - a) IS : 14566 – Electric Traction Lifts
 - b) Gujarat Lifts and escalator act (2001)
 - c) National Building Code 2005 with latest amendments.
 - d) Indian Electricity Acts and Rules.
2. In addition, other national/international rules and regulations as applicable to the equipments/work shall be followed. In case of any discrepancy, the more restrictive rule shall be binding.

3. BRIEF SCOPE OF WORK

- I. Supply, installation, testing and commissioning the elevator of required specifications
- II. To provide all necessary scaffolding
- III. Minor and Major civil works like creating holes in the walls, grouting of all bolts, fixing of steel members, indicators, button boxes etc.
- IV. Supplying, fabricating and installation of all kinds of steel works required installing and commissioning the elevators including machine rooms
- V. Providing and fixing necessary electrical works, wiring etc for elevators, hoist way and machine room.
- VI. Supply and erection of shaft reducer steel channels, if necessary.
- VII. All necessary approval from government authorities.
- VIII. All inclusive maintenance and breakdown service from the date of handing

over.

4. DESIGN AND CONSTRUCTIONAL FEATURES:

Supplying, Erecting, Testing & Commissioning the passenger/Fire lift having following main features:

- [1] GEAR LESS LIFT DRIVE comprising of High Starting torque Lift duty 3 phase 440 V A. C. Permanent magnetic synchronous motor of proper rating with high efficiency shall be used.
- [2] Micro processor based / PLC, ACVVVF, vector control drive with encoder feedback closed loop system shall be used for lift car and door operation which shall be full collective selective operation hall call demand response, UP/DOWN hall stops, Main, Up/ Down Contactor with overload and phase reversal relay and safety controls.
- [3] Car with M S platform with bracings of adequate size and to sustain the impact load cabin + passenger with safety factor of fire for steel and side panels of Stainless steel of sheet of grade 304 duty. Car ceiling will be S.S. finishes with aesthetic appearance with LED ceiling lights. Car flooring shall be of anti skid PVC with choice of colour of engineer in charge. Car doors shall be of stainless steel grade 304, hairline finish with centre opening / telescopic automatic doors. Car panel will also be S.S. 304 finished with emergency stop device, mechanical door safety device, facility of auto/ attended mode. All car panel buttons and all floor switches must be with brail language as per lift act.
- [4] All landing doors shall be fully automatic centre opening/ telescopic opening made of hairline finish steel grade of 304 with key holes and infrared curtains with Unlocking facility from outside.
- [5] Appropriate battery operated emergency light in the car along with alarm switch shall be provided.
- [6] Digital scrolling indicator system for up-down arrow along with floor position indicator shall be provided inside the car and at all floors.
- [7] Full height infra red curtain with multiple criss / crossing light beams shall be provided.
- [8] Automatic Rescue Device (ARD) shall be provided accordingly of passenger capacity.
- [9] Audio visual indication in the lift car showing over loading shall be provided such that doors kept open till excess load is removed.
- [10] As per statutory requirement of Got. Of Gujarat lift & escalator act 2000, lift agency has to provide
 - Car top safety barricade
 - Push & talk communication system.
 - Fireman's switch operation at Ground Floor

5. DETAILED SCOPE OF WORKS:

1. Design, manufacture, supply, erection, testing and commissioning of Passenger/Fire lift as specified.

2. Schedule of Materials

- 1 The contractor shall be responsible for unloading, storage, safe custody, accountability, testing etc.

2 The quantity for measurement will be actual and invisible loss; wastage etc shall not be paid or billed.

- I) The contractor shall bear all incidental charges for the storage and safe custody of the materials at site at his own responsibility.
- II) The contractor shall make arrangement at the site to protect from damage by rain, dampness, fire, theft etc.
- III) In case any materials get damaged the contractor shall replace the same at his own cost.
- IV) The contractor shall maintain a day-to-day account of the material supplied by Owner/Contractor in the prescribed Performa and it should be submitted along with RA bills.

6. Clearance of site on completion.

On completion of the works, the contractor shall clear away and remove from the site, all surplus materials, rubbish and temporary works of every kind and leave the whole site and works clean and in workman like condition to the satisfaction of Owner at his own cost. If the contractor fails to clear the site within 15 days after virtual completion/ submission of final bill whichever is earlier, it shall forfeit all his claims and the owner may get the site cleared at contractor's cost..

7. Statuary Approval

The contractor shall obtain necessary statutory approval from relevant government agency / lift inspector / electrical inspector. The statutory fees shall be paid by the contractor initially and same shall be reimbursed by SMC on submission of supporting document.

8. Submission of the license or Commissioning certificate by TPI shall be treated as the final completion date , whichever is later.

9. Submission of the preliminary and final layout drawings and technical details

The contractor shall submit the preliminary layout and technical details based on the Surat Municipal Corporation drawings for approval and shall submit the final layouts incorporating all comments. Execution will be allowed only after approval of the drawings. Prior approval from Surat Municipal Corporation shall be required for installation of each elements / accessories going to be installed inside CAR i.e. light fitting, floor mat, hand rail etc.

Drawing, Document to be submitted, in general:

- Outline dimensional drawing showing general arrangement, space requirements
- Bill of Materials.
- Typical installation plan.
- Technical leaflets on & complete specifications & OEM address for bought out items.
- QAP
- Any other details furnished by manufacturer

10. Supervision

The work shall have to be carried out in best workman like manner and supervised by competent erection engineers having adequate experience in the similar kind of work.

11. Insurance & Indemnification

The contractor shall take adequate insurance cover for his equipment, material, installation and personnel for transport and storage, till the completion of the project;

and indemnify the Surat Municipal Corporation against any claims or liabilities that may arise due to any cause whatsoever. The indemnification shall cover, but not be limited to, accidents, injuries, loss, theft, etc. of items, properties and human beings.

12. Free Maintenance

The contractor shall provide free maintenance service for the period of 12 months from the date of handing over. Contractor shall supply the electrical cable, with necessary protective switch gears for the elevator as per requirement

13. Necessary Steel Channels for reduction of shaft (if required) shall also be in scope of the bidder. No extra payment shall be made for this to bidder.

14. Testing and commissioning:

The installation, testing and commissioning of the equipment AT SITE shall be carried out in accordance with IS: 14665.

Quality Assurance Plan shall be got approved. The safety gear equipment and other parts as per approved QAP shall be tested as per relevant IS specifications AT THE MANUFACTURERS FACILITY in the presence of authorized representative of TPI and Surat Municipal Corporation, prior to dispatch for site. All the expenses incurred for the same shall be borne by the contractor. At least 15 days prior notice should be given to TPI and Surat Municipal Corporation so as to enable them to depute a representative for the work. The above testing procedure does not relieve the contractor from his commitment/ contractual obligation / guarantee etc.

15. Operation and maintenance manual:

Operation and maintenance manual and drawings IN SOFT COPY AND HARD COPY (IN TRIPLICATE) shall be submitted.

16 . Announcing System :

Lift Announcing solid state system in the Passenger/ Stretcher lifts having AC2/ACVV/ACVF drives & automatic doors only. The system comprising following features & facilities.

- (i) Announcing floor message, message to close period
- (ii) Announcing 'Emergency Message' when lift is stuck between floors due to power failure or any other reason.
- (iii) Instrumental Music between floor announcing.
- (iv) Announcement in English / Hindi & Gujarati Languages..
- (v) Flexible to accommodate special pre-programmed message such as name of the building /office.
- (vi) Volume adjustment control

17. Overload Protection

Providing & erecting approved make overload non-start feature & overload warning Indicator system in the lift with making use of sound isolated floating platform & micro switches on SI frame to get sensation of live load inside lift cage at any given moment, with provides new fixtures of overload warning inside lift cage with new relay in the existing control panel to activate 'Overload Non-Start Function' with carrying out additional wiring including laying of new travelling cable, include minor civil work & without changing the existing capacity speed stops, travel & operation of the desired lift

18. ARD (Automatic Rescue Device):

Supplying and erecting approved make, solid stat inbuilt emergency rescue Device, for

automatically rescues Passengers trapped in the lift car in between floors in the event of power failure having following features.

(i) Automatic operation & immediate action in the event of mains failure capable to move the lift to

the nearest landing, opens the automatic doors of the lift car & floor.

(ii) Sealed, maintenance free battery back-up of suitable size with automatic charging unit & auto

change over device on mains failure.

(iii) RESCUE OPERATION message indicator in the lift car

(iv) Applicable to Passenger, Goods cum Passenger, Stretcher cum Passenger lifts with AC2, ACVV, ACVVVF drives & automatic doors.

19 GENERAL TERMS AND CONDITIONS:

1. Tenderers are requested to submit necessary documents to prove their eligibility. Surat Municipal Corporation reserves right to accept or reject any offer without giving any reason.
2. Contractor shall furnish the test certificates for Machine, Motor, Motor Generator Set, Ropes, Safeties, Controller, selectors, Governors, Buffers, etc.
3. If there is any deviation, the bidder shall have to submit a deviation sheet along with technical bid only. If there shall not be any deviation sheet along with the technical bid, it shall be presume that bidder is agree with terms, conditions & specifications demanded by Surat Municipal Corporation.
4. Detail technical specifications of all parts of the elevators shall be submitted along with the technical bid of the tender.
5. Make and Manufacturer's name for all major items and parts shall be specified and submitted along with the tender.
6. Finished sizes of all members shall be as per the drawing and should fit with site conditions wherever specified.
7. Unless otherwise specified, all metal surfaces shall be treated with zinc chromate primer.
8. The rates are inclusive of necessary scaffolding, tools and tackles, taxes, duties, levies, transportation etc. No other payment shall be made other than rates quoted in the price bid.
9. Electricity & water required for executing this work shall be in scope of contractor.
10. The rates shall be firm and not subject to exchange variations, labour conditions, fluctuations in railway freights or any conditions whatsoever. It shall also include for sales tax, VAT, excise duty, octroi and any other taxes/duty or other levy levied by the Central or State Governments or local authorities, sales tax on works contract if applicable. No claim in respect to the above mentioned shall be entertained by the Surat Municipal Corporation except the statutory taxes.
If there is an upward revision of statutory taxes, Corporation will reimburse the additional expenses on providing of necessary proof/receipts. Similarly, if there is a downward revision, Corporation will deduct the amount equivalent to the difference from the bills submitted for payment.
11. During defect liability period, if any fault occurs in the lift, the contractor shall have to attend the lift within 2 hours from intimation and clear the fault at earliest.
12. The corporation shall not be responsible to any accident/injury to the staff of the

contractor during work. No compensation shall be paid in such incidences by SMC. The contractor is responsible for the safety of his staff members working at corporation's site.

DATA SHEET FOR PROPOSED PASSENGER/FIRE LIFT

DUCT SIZE MUST BE		AS PER IS 14665
SR. NO	DESCRIPTION	As per Tender Specification
A	Standard Applicable	IS 14665
B	Passengers/ Load	6/420 Kg & 8/ 544 Kg (For Fire)
C	Speed	1.0 mps up to 8 floors. 1.5 mtr above 8 floors.
D	Leveling Accuracy	+/- 10 mm to 15 mm
E	Entrance Position	All on one side
F	Power Supply	AC 400/440V, 3P/1P, 50 Hertz
G	Operation/Control	Simplex full collective with advanced microprocessor technology
H	Type	Passenger lift to be used in residential complex.
I	Car Size	Suitable
J	Car Entrance	Min. 800 mm (W) x Min.2000 mm (H). Exact dimensions to be decided during detailed engineering.
K	Car Operating Panel and Landing Operating Panel	Full Height SS with Square / Round buttons with all control buttons. Bidder may offer touch sensitive panel instead.
L	Car Door Operation	Fully Automatic with Center opening.
M	Car Wall	SS Hairline finish
N	Flooring	Anti skid Flooring/Granite Flooring to be decided during detailed engineering.
O	Car Door Protection	Multi-Beam Full Height Infra-Red Detector
P	Position indicators	To be provided at all floors
Q	Direction indicator on floor	To be provided at all floors
R	Lighting	LED Lighting
S	Type of Ventilation	To be suggested by supplier. To be decided during detailed engineering.
T	Other features	Alarm, Emergency Light, Overload Indicator, Telephone, ARD, Hand Rails

SPECIAL NOTE: Contractor has to refer & implement - Gujarat Lifts and escalator act (2001) , Chapter III -Lifts, Clause No 37 – Lift Cars, Sub Clause – 19 (a) (with latest amendments, if any),for provision of Fire Lift in case of building heights more than 24 Mtr.

SR NO 13. SPECIFICATIONS FOR MEDIUM AND HIGH VOLTAGE CABLES AND ACCESSORIES

1.0 SCOPE

This specification along with data sheets covers requirements for design, manufacture, testing at works and supply of Flame Retardant PVC/XLPE cables and cable jointing / terminating accessories for medium and high voltage systems.

2.0 STANDARDS

The cables and cables jointing & terminating accessories shall comply with the latest edition of the following standards as applicable:

IS: 1554	PVC insulated (heavy duty) electric cables.
IS: 7098	Cross-linked polyethylene insulated PVC sheathed.
IS: 8130	Conductors for insulated electric cables and flexible cords.
IS: 5831	PVC insulation and sheath of electric cables.
IS: 3975	Mild steel wires, strips and tapes for armouring of cables.
10810(Part 41)	Methods of test for cables: Mass of zinc coating on steel armour.
IS: 209	Specification for zinc.
IS: 3961(Pt-2)	Recommended current ratings for cables: Part - 2 PVC Insulated and PVC sheathed heavy-duty cables.
IS: 10418	Drums for electric cables.
IS: 10462 (Pt-I)	Fictitious calculation method for determination of Dimensions of protective coverings of cables: Part - I Electrometric and thermoplastic insulated cables.
IS: 10810 (Pt-58)	Oxygen Index test.
IS: 10810 (Pt 61)	Flame Retardant test.
IS: 10810 (Pt 62)	Fire resistance test for bunched cables.
IS: 13573	Joints and terminations for polymeric cables for working Voltages from 6.6 KV up to and including 33 KV.
IEC: 60332-3	Tests on electric cables under fire conditions.

IEC: 60502	Extruded solid dielectric insulated power cables for rated Voltages from 1 KV. up to 30 KV.
IEC: 60540 & 60540A	Test methods for insulation and sheaths of electric Cables.
ASTM: D2863	Standard method of test for flammability of plastics using oxygen index method.
ICEAS-61-402 NEMA-WC5	Thermoplastic insulated wire and cable for transmission and distribution of electrical energy.
ICEA S-66-524 NEMA-WC7	Cross-linked thermosetting polyethylene insulated wire and cable for transmission and distribution of electrical energy.

- 2.2 The cables and accessories shall also conform to the provisions of Indian Electricity Rules and other statutory regulations, as applicable.
- 2.3 In case of any contradiction between various referred standard/ specification/data sheet and statutory regulations, the following order of priority shall govern:

Statutory Regulations, Data Sheets, Job Specifications

This Specification Codes and Standards

3.0 GENERAL CONSTRUCTION

- 3.1 The cables shall be suitable for laying in trays, trenches, ducts, and conduits and for underground-buried installation with uncontrolled backfill and possibility of flooding by water and chemicals.
- 3.2 Outer sheath of all PVC and XLPE cables shall be black in colour and the minimum value of oxygen index shall be 29 at $27 + 2^{\circ}$ C. In addition suitable chemicals shall be added into the PVC compound of the outer sheath to protect the cable against rodent and termite attack.
- 3.3 All cables covered in this specification shall be flame retardant (FR) unless specified otherwise in the data sheet. The outer sheath of PVC and XLPE cables shall possess flame propagation properties meeting requirements as per IS-10810 (Part-62) category AF.
- 3.4 Sequential marking of the length of the cable in meters shall be provided on the outer sheath at every one meter. The embossing /engraving shall be legible and indelible.
- 3.5 The overall diameter of the cables shall be strictly as per the values declared by the manufacturer in the technical information subject to a maximum tolerance of ± 2 mm up to overall diameter of 60mm and ± 3 mm for beyond 60mm.
- 3.6 PVC / Rubber end caps shall be supplied free of cost for each drum with a minimum of eight per thousand meter length. In addition, ends of the cables shall be properly sealed with caps

to avoid ingress of water during transportation and storage.

3.7 PVC cables

- 3.7.1 All power/control cables for use on medium voltage systems shall be heavy-duty type, 650/1100 V grade with aluminium / copper conductor, PVC insulated, inner-sheathed, armoured and overall PVC sheathed unless specified otherwise in data sheet.
- 3.7.2 The conductors shall be solid for conductor of nominal area up to and including 6mm^2 and stranded beyond 6mm^2 . Conductors of nominal area less than 16mm^2 shall be circular only. Conductors of nominal area 16mm^2 and above may be circular or shaped as per IS 8130. Cables with reduced neutral conductor shall have sizes as per Table 1 of IS 1554 (Part-1).
- 3.7.3 The core insulation shall be with PVC compound applied over the conductor by extrusion and shall conform to the requirements of type 'A' compound as per IS: 5831. The thickness of insulation and the tolerance on thickness of insulation shall be as per Table 2 of IS: 1554 (Part-1). Control cables having 6 cores and above shall be identified with prominent and indelible Arabic numerals on the outer surface of the insulation. Colour of the numbers shall contrast with the colour of insulation with a spacing of maximum 50 mm between two consecutive numbers. Colour coding for cables up to 5 cores shall be as per Indian standard.
- 3.7.4 The inner sheath shall be applied over the laid-up cores by extrusion and shall be of PVC conforming to the requirements of Type ST-1 PVC compound as per IS: 5831. The minimum thickness of inner sheath shall be as per IS: 1554 (Part-1). Single core cables shall have no inner sheath.
- 3.7.5 If armouring is specified for multicore cables in the data sheet, the same shall be by single round galvanized steel wires where the calculated diameter below armouring does not exceed 13 mm and by galvanized steel strips where this dimension is greater than 13 mm. Requirement and methods of tests for armour material and uniformity of galvanization shall be as per IS - 3975 and IS -10810 (Part 41). The dimensions of Armour shall be as per method (b) of IS - 1554 (Part -1). If armouring is specified for single core cables in the data sheet, the same shall be with H4 grade hard drawn aluminium round wire of 2.5 mm diameter. For mining cables, the size and type of armour shall be such that the combined conductance of armour shall be equivalent to 75 percent of the conductance of the largest conductor of the cable.
- 3.7.6 The outer sheath for the cables shall be applied by extrusion and shall be of PVC compound conforming to the requirements of type ST-1 compound as per IS: 5831. The minimum and average thickness of outer sheath for un armoured cables and minimum thickness of outer sheath for armoured cables shall be as per IS: 1554 (Part -1).
- 3.7.7 If heat resisting PVC cables are specified in the data sheet, the following shall be the requirements:

It shall be possible to continuously operate the cable at a maximum conductor temperature of 85 ° C. PVC compounds used for HR PVC cables shall be as follows:

- a. Conductor insulation - Type C
- b. Inner sheath - Type ST 2
- c. Outer sheath - Type ST 2

3.8 XLPE Cables

- 3.8.1 Power cables for 3.3 KV up to and including 33 KV systems shall be Aluminium/ copper conductor, XLPE insulated, sheathed, armoured and overall PVC sheathed.
- 3.8.2 The conductors shall be stranded and compacted circular for all cables.
- 3.8.3 All cables rated 3.8 / 6.6 kV and above shall be provided with both conductor screening and insulation screening. The conductors shall be provided with non-metallic extruded semi conducting screen.
- 3.8.4 The core insulation shall be with cross linked polyethylene insulating compound dry cured, applied by extrusion. It shall be free from voids and shall withstand all mechanical and thermal stresses under steady state and transient operating conditions. It shall conform to the properties given in Table-1 of IS: 7098 (Part -2).
- 3.8.5 The insulation screen shall consist of non-metallic extruded semi-conducting compound in combination with a non-magnetic metallic copper screen. Unless specified otherwise, the copper screen for all the three cores together shall be capable of carrying the single line to ground fault current value and the duration specified in the data sheet.
- 3.8.6 The conductor screen, XLPE insulation and insulation screen shall all be extruded in one operation by 'Triple Extrusion' process to ensure perfect bonding between the layers. The core identification shall be by coloured strips or by printed numerals.
- 3.8.7 The inner sheath shall be applied over the laid up cores by extrusion and shall conform to the requirements of type ST 2 compound of IS: 5831. The extruded inner sheath shall be of uniform thickness. In case of single core cables, there shall be extruded inner sheath between insulation metallic screen and armouring.
- 3.8.8 For multicore cables, the armouring shall be by galvanized steel strips as per method (b) of IS-7098 (Part-2). If armouring is specified for single core cables in the data sheet, the same shall be with H4 grade hard drawn aluminium round wire of 2.5 mm diameter.
- 3.8.9 The outer sheath of the cables shall be applied by extrusion over the armouring and shall be of PVC compound conforming to the requirements of Type ST 2 compound of IS: 5831. The minimum and average thickness of outer sheath for un armoured cables and minimum thickness of outer sheath for armoured cables shall be as per IS: 7098 (Part-2)
- 3.8.10 The thickness of the insulation, inner sheath shall be governed by values given in IS: 7098

(Part-2).

- 3.8.11 Where specified, 1100V grade power cables shall also be XLPE insulated and shall meet the requirement specified in IS-7098 (Part-1).

4.0 CABLE ACCESSORIES

- 4.1** The termination and straight through jointing kits for use on the systems shall be suitable for the type of cables offered as per this specification.
- 4.2** The accessories shall be supplied in kit form. Each component of the kit shall carry the manufacturer's mark of origin.
- 4.3** The kit shall include all stress grading, insulating and sealing materials apart from conductor fittings and consumable items .An installation instruction sheet shall also be included in each kit.
- 4.4** The contents of the accessories kit including all consumable shall be suitable for storage without deterioration at a temperature of 45° C, with shelf life extending to more than 5 years.

4.5 Terminating kits

The terminating kits shall be suitable for termination of the cables to an indoor switchgear or to a weatherproof cable box of an outdoor mounted transformer / motor. For outdoor terminations, weather shields / sealing ends and any other accessories required shall also form part of the kit. The terminating kits shall be from one of the makes / types mentioned in the data sheet.

4.6 Jointing kits

The straight through jointing kits shall be suitable for installation on overhead trays, concrete lined trenches, and ducts and for underground burial with uncontrolled backfill and possibility of flooding by water and chemicals. These shall have protection against any mechanical damage and suitably designed to be protected against rodent and termite attack. The inner sheath similar to that provided for cables shall be provided as part of straight through joint. The jointing kits shall be from one of the makes / types mentioned in the data sheet.

5.0 INSPECTION, TESTING AND ACCEPTANCE

The cables shall be tested and inspected at the manufacturer's works. All the materials employed in the manufacture of the cable shall be subjected, both before

and after manufacture, to examination, testing and approval by SRE / owner. Manufacturer shall furnish all necessary information concerning the supply to SRE / owner's inspectors. The inspector shall have free access to the manufacturer's works for the purpose of inspecting the process of manufacture in all its stages and he will have the power to reject any material, which appears to him to be of unsuitable description or of unsatisfactory quality. The vendor shall give at least 2 weeks advance notice to the purchaser, regarding the date of testing to enable him or his representative to witness the tests.

5.1 **Cables**

- 5.1.1 After completion of manufacture of cables and prior to dispatch, the cables shall be subjected to type, routine, acceptance and special tests as detailed below. SRE/ Owner reserves the right to witness all tests with sufficient advance notice from vendor. The test reports for all cables shall be got approved from the Engineer before dispatch of the cables.
- 5.1.2 All routine tests, acceptance tests, type tests and additional type tests for improved fire performance shall be carried out as listed in IS: 1554 (Part-1), and IS: 7098 (Part-2) on PVC and XLPE insulated cables respectively.
- 5.1.3 The test requirements for PVC insulation and sheath of cables shall be as per latest revision of IS: 5831.
- 5.1.4 Test for Resistance to Ultra Violet Radiation: This test shall be carried out as per DIN 53387 or ASTM-G-53 on outer sheath. The retention value of tensile strength and ultimate elongation after the test shall be minimum 60 % of tensile strength and ultimate elongation before the test. Test certificates with respect to this test (not older than one year) from recognized testing laboratory to be furnished for review by SRE before dispatch clearance of cables. In case test certificates are not available, test is to be conducted by vendor at his own cost in any recognized test laboratory or in house testing laboratory, before dispatch clearance of cables. Sampling for this test is to be done randomly once for each order, provided outer sheath remains same.
- 5.1.5 Acceptance tests as per IS-1554 (Part-1) and IS-7098 (Part-2) and the following special tests to be performed on the cables as per sampling plan. These tests are required to be witnessed by SRE/owner before dispatch of cables.

- 5.1.6 Accelerated water absorption test for insulation as per NEMA - WC - 5. (For PVC insulated cables) and as per NEMA WC - 7 (for XLPE insulated cables). Test certificates with respect to this test (not older than one year) from recognized testing laboratory to be furnished for review by SRE before dispatch clearance of cables. In case test certificates are not available, test is to be conducted by vendor at his own cost in any recognized test laboratory or in house testing laboratory, before dispatch clearance of cables. Sampling for this test is to be done randomly once for each order, provided type of insulation remains same.
- 5.1.7 Dielectric Retention Test: The dielectric strength of the cable insulation tested in accordance with NEMA WC - 5 at $75 \pm 1^\circ \text{C}$ shall not be less than 50 % of the original dielectric strength. (For PVC insulated cables). Test certificates with respect to this test (not older than one year) from recognized testing laboratory to be furnished for review by SRE before dispatch clearance of cables. In case test certificates are not available, test is to be conducted by vendor at his own cost in any recognized test laboratory or in house testing laboratory, before dispatch clearance of cables. Sampling for this test is to be done randomly and once for each order.
- 5.1.8 Oxygen Index Test: The test shall be carried out as per ASTM D2863 or applicable Indian Standard specifications. Sampling to be done for every offered lot/size as per sampling plan.
- 5.1.9 Flammability Test: The test shall be carried out on finished cable as per IS – 10810 (part 61 & 62). Sampling for these tests is to be done randomly once for each order, provided outer sheath remains same. The acceptance criteria for tests conducted shall be as under:
- Part-61-The cable meets the requirement if there is no visible damage on the test specimen within 300 mm from its upper end
- Part-62-The maximum extent of the charred portion measured on the test sample should not have reached a height exceeding 2.5 m above the bottom edge of the burner at the front of the ladder.
- 5.1.10 Test for rodent and termite repulsion property: The vendors shall furnish the test details to analyze the property by chemical method. Sampling to be done for every offered lot / size as per sampling plan.

5.2 Cable Accessories

Type tests should have been carried out to prove the general qualities and design of a given type of termination / jointing system as per IS-13573. The type test certificates from independent testing laboratory shall be submitted before dispatch.

6.0 PACKING AND DESPATCH

6.1 Cables shall be dispatched in non-returnable wooden or steel drums of suitable barrel diameter, securely battened, with the take-off end fully protected against mechanical damage. The wood used for construction of the drum shall be properly seasoned, sound and free from defects. Wood preservatives shall be applied to the entire drum. Ferrous parts used shall be treated with a suitable rust preventive finish or coating to avoid rusting during transit or storage.

6.2 On the flange of the drum, necessary information such as project title, manufacturer's name, type size, voltage grade of cable, length of cable in metres, drum no., cable code, and BIS certification mark, gross weight etc. shall be printed. An arrow shall be printed on the drum with suitable instructions to show the direction of rotation of the drum.

6.3 Unless otherwise specified, Cables shall be supplied in drum.

A tolerance of plus or minus 3 % shall be permissible for each drum. However overall tolerance on each size of cable shall be limited to $\pm 2\%$. Offers with short / non-standard lengths are liable for rejection. If non-standard drum lengths are specified in the data sheet, the same shall be supplied.

7.0 CABLE LAYING

7.1 General

7.1.1 Cable installation shall include power, control, lighting, fire alarm, telephone and communication cables. These shall be laid in trenches/ cable trays /Duct as detailed in the cable layout drawings. Cable routing given on the cable layout drawings shall be checked in the field so as to avoid interference with structures, heat sources, drains, piping, air-conditioning duct etc. Any change in routing shall be done to suit the field conditions wherever deemed necessary, after obtaining approval of Engineer-in-charge.

High voltage, medium voltage power and control cables shall be separated from each other by adequate spacing or by running through independent pipes, trenches or

cables trays, as shown on layout drawings/installation standards. Details of cable routes and cable spacing not shown in detail on these drawing shall be determined by the contractor and approved by the engineer- In-charge.

When single core cables are laid in flat formation, the individual cable fixing clamps and spacers shall be of non-magnetic material. As a general practice, the sheath of single core cables shall be earthed at one point to keep sheath at earth potential unless otherwise stated. Single core cables, when laid in trefoil formation shall be braced by suitable clamps at a distance, not exceeding 3 meters along the cable routing.

If straight through joints are required to be provided on single core cables, armour shall be broken at joints as per manufacturer's recommendations. For single core cables, armour shall be earthed at one end for the cable run length as per manufacturer's recommendation.

The Telephone, Communication and Fire alarm cables shall run on instrument trays/ducts/ trenches in the units. Wherever these are not available, cables shall be taken in a separate trench/tray with a minimum spacing of 300 mm from power and control cables

Telephone, fire alarm and plant communication cables shall be directly buried in road berm area, (unless otherwise specified in cable layout drawings). These cables shall cross power cables preferably at right angles. Street lighting cables shall be laid on the other side of road berm area

- 7.1.2 The lengths indicated in the cables schedule are only approximate. The contractor shall ascertain the exact length of cable for a particular feeder by measuring at site. All cable routes shall be carefully measured. Before the start of cable laying, the contractor shall prepare cable drum schedule and get that approved by Engineer-in-charge to minimize/avoid straight through joints and then the cables cut to the required lengths, leaving sufficient lengths for the terminations of the cable at both ends. The various cable lengths cut from the cable reels shall be carefully selected to prevent undue wastage of cables. Extra loop length shall be given for feeder cables where required as per the directions of Engineer-in-charge to meet contingencies

Cables shall be laid in directly buried trench or in RCC trench (underground trench) or in cable tray along pipe sleepers or in over head trays as shown on cable layout drawings.

Overhead trays shall be installed 2700 mm (minimum) above grade level and 300mm above FGL in case cable trays are installed along with pipe sleepers. At road crossings overhead trays shall be installed at 7000 mm (minimum) above grade level or cables shall be routed cable tray culvert/ Electrical road crossings as per layout drawings.

Sufficient care shall be taken while laying cables to avoid formation of twist, sharp bend etc. in order to avoid mechanical injuries to cables. Rollers shall be used for pulling of cables.

Cable installation shall provide minimum cable bending radii as recommended by cable manufacturer.

7.1.3 Cables shall be neatly arranged in the trenches / trays in such a manner that criss-crossing is avoided and final take off to the motor / switchgear is facilitated. Arrangement of cables within the trenches / trays shall be in line with cable layout drawings. Cable routing between cable trench and equipment/motors shall be taken through GI pipe sleeves of adequate size. Pipe sleeves shall be laid at an angle of maximum 45 to the trench wall. Bending radii of pipes shall not be less than 8D. It is to be ensured that both the ends of GI pipe sleeves shall be sealed with approved weather proof sealing plastic compound after cabling. In places where it is not possible, cables shall be laid in smaller branch trenches. Different rows of cable trays in cable cellar below the cutout shall be fixed so that the trays don't obstruct cable entry to the panels.

7.1.4 All cables shall be identified close to their termination point by cable tag numbers as per cable schedule. Cable tag numbers shall be punched on aluminium /Lead straps (2mm thick, 20 mm wide and of enough length) securely fastened to the cable and wrapped around it.

Each underground cable shall be provided with cable tags of lead /Aluminium securely fastened every 30 m of its underground length with at least one tag at each end before the cable enters/leaves the ground. In unpaved areas, cable trenches shall be identified by means of cable markers as per installation drawing. These cable markers shall be placed at location of changes in the direction of cables and at intervals of not more than 30 m and also at cable straight through joint locations.

7.1.5 All temporary ends of cables must be protected against dirt and moisture to prevent damage to the insulation. For this purpose, ends of cables shall be taped with an approved PVC end cap or rubber insulating tape.

7.1.6 Each row of cables shall be laid in place and before covering with sand. All wall

openings/pipe sleeves shall be effectively sealed after installation of cables to avoid seepage of water inside building/lined trench. Every cable shall be given an insulation test in presence of Engineer-in-charge/Owner before filling the cable trench with sand Any cable which is found defective shall be replaced.

7.1.7 Where cables pass through foundation walls, the necessary openings shall be provided in advance for the same by another agency. However, should it become necessary to cut holes in existing structures for example floor slab etc., the electrical contractor shall determine their location and obtain approval of the Engineer-in-charge before carrying out the same.

7.1.8 Cables for road crossings shall be taken through ERC (Electrical Road Crossing) as shown in the cable layout drawings.

At road crossing and other places where cables enter pipe sleeves adequate bed of sand shall be given so that the cables do not slack and get damaged by pipe ends.

7.1.9 Wherever cable trench crosses storm water, waste water channel/drain, cables shall be taken through PVC/RCC pipes. Where cables are required to cross drains of depth more than 1200 mm, cables shall be taken over the drain on cable trays supported suitably using ISMC 150/200 sections.

7.1.10 Ends of cables leaving trench shall be coiled and capped and provided with protective cover till such time the final termination to the equipment is completed.

7.2 Cables Laid Direct in Ground

Cables shall be laid underground in excavated cable trenches where specified in cable layout drawings. Trenches shall be of sufficient depth and width for accommodation of all cables. Cables shall be properly spaced as per installation standards. Maximum number of cable layers in trench shall be preferably limited to 6 layers.

Minimum depth of directly cable trench shall be 750 mm, for medium voltage and 900 mm for HV Cables. The depth and the width of the trench shall vary depending upon the number of layers of cables as per SRE installation Standards. The depth and the width of the trench shall vary depending upon the number of layers of cables as per SRE installation Standards

Cables shall be laid in buried trenches at depth as shown in the cable layout drawings. It is to be ensured by the contractor that the bottom of buried trenches shall be cleared of all rocks, stones and sharp objects before cables are placed. The trench

bottom shall be filled with a layer of sand or stone dust. This sand /stone dust shall be leveled and cables laid over it. These cables shall be covered with 150 mm of sand on top of the largest diameter cable and sand shall be lightly compacted. A flat protective covering of 75 mm thick second class red bricks or concrete tiles as per specification shall then be laid and the remainder of the trench shall then be back - filled with soil, rammed and leveled.

7.3 Cables Laid in Concrete Trench

Cables shall be laid in 5 or 6 tiers in concrete trench as shown on layout drawings. Concrete cables trenches shall be filled with sand /stone dust in hazardous area to avoid accumulation of hazardous gases and oil. RCC covers of trenches shall be effectively sealed to avoid ingress of chemical and oil in process area. Removal of concrete covers where required for the purpose of cable laying and reinstating them in their proper position after cables are laid shall be done by electrical contractor.

Minimum depth of RCC cable trench shall be 500mm for all voltage grades with 300mm clearance between the bottoms of the trench cover and top of the cable. The depth and the width of the trench shall vary depending upon the number of layers of cables and bending radius required for cables as per SRE installation Standards

All wall openings/pipe sleeves shall be effectively sealed after installation of cables to avoid seepage of water

7.4 Above Ground Cables

7.4.1 Cables installed above grade shall be run in cable trays, clamped on walls, ceiling or structures and shall be run parallel or at right angles to beams, walls or columns. Cable routing shall be planned to be away from heat sources such as hot piping, gas, water, oil drainage piping, air-conditioning duct etc. Each cable tray shall contain only one layer of cables as far as possible for power cables. However control cables may be laid in double layer in the cable trays.

7.4.2 Individual cable or small group of cables (up to 3 cables) which run along structures / walls etc. shall be clamped by means of 16 SWG GI saddles on 25 x 6 mm saddle bars. Alternatively small group of cables can be taken through 60/100/150 mm slotted channel tray or channel ISMC-75/100. Cables shall be supported so as to prevent Sagging. In general, distance between supports shall be approximately 300 mm for cables up to 25 mm diameter and maximum 450 mm for cables larger than 25 mm dia. to prevent the Sagging of cables.

7.4.3 Cable laid on supporting angle in cable trenches, structures, columns and vertical run of

cable trays shall be suitably clamped by means of GI saddles / clamps, whereas cables in horizontal run of cable trays shall be tied by means of nylon cords. Distance between supporting angles shall not exceed 600 mm. All cable trays (other than galvanized trays) and supporting steel structures shall be painted before laying of cables. The under surfaces shall be properly degreased, derusted, descaled and cleaned. The painting shall be done with one coat of red oxide zinc chromate primer. Final painting shall be done with two coats of approved bituminous aluminium paint unless otherwise specified.

- 7.4.4 Where cables rise from trench to motor, lighting panel, control station, junction box etc., they shall be taken in GI pipe for mechanical protection up to a minimum of 300 mm above grade for outdoor area. Cable ends shall be carefully pulled through conduit to prevent damage to cable.
- 7.4.5 AH GI Pipes shall be laid as per layout drawings and site conditions. Before fabrication of various profiles of pipes by hydraulically operated bending machine (which is to be arranged by the contractor) all the burrs from the pipes shall be removed. GI Pipes having bends shall be buried in soil / concrete in such a way that the bend shall be totally concealed. For G.I. pipes buried in soil, bitumen coating shall be applied on the buried lengths, Installation of G.I. pipes shall be undertaken well before paving is completed and necessary co ordination with paving agency shall be the responsibility of Electrical Contractor.

Following guide shall be used for sizing of GI. pipe.

- a) 1 cable in a pipe -53% of pipe cross-sectional area occupied by cables.
 - b) 2 cables in a pipe -31% of pipe cross-sectional area occupied by cables.
 - c) 3 cables in a pipe - 43% of pipe cross-sectional area occupied by cables.
 - d) 4 & above cables in a pipe - 40% of pipe cross-sectional area occupied by cables.
- 7.4.6 After the cables are installed and all testing is complete, conduit ends above grade shall be plugged with a suitable weatherproof plastic compound/bitumen/suitable sealing compound. Alternatively rubber bushes shall be employed for the purpose of sealing.
- 7.4.7 Fire proofing of end of power cables at least 1 meter at each end as per OISD norms for the refinery and Petroleum industry, shall be carried out as per the recommendation of the paint supplier .Rates for the fire proofing of cables shall be included in the cable installation and no separate payment shall be made for the painting.

MODE OF MEASUREMENT: AS PER MENTIONED IN SCHEDULE – B
Description
Mode of Payment: The rate shall be for a Unit of One Mtr.

SR NO 12. Solderless crimping type Aluminium lugs

Solderless crimping type Aluminium lugs conforming to IS suitable for cable of following size evenly crimped with high pressure tool & connected to switchgear terminals with brass/cadmium plated nut bolts in an approved manner.

(F) 70 Sq.mm.

(H) 120 Sq.mm.

MODE OF MEASUREMENT: AS PER MENTIONED IN SCHEDULE – B

Description

Mode of Payment: The rate shall be for a Unit of One No.

SR NO 13. Heavy duty flange type brass cable gland

Providing and, fixing heavy duty flange type brass cable gland with rubber ring for PVC insulated armoured cable complete with out going tails, insulating tape etc for following size of cables.

(B) 3 & 1/2 core 35/50 Sq. mm

(C) 3 & 1/2 core 70 Sq. mm

(E) 3 & 1/2 core 120 Sq. mm

MODE OF MEASUREMENT: AS PER MENTIONED IN SCHEDULE – B

Description

Mode of Payment: The rate shall be for a Unit of One No.

SR NO 14. TIMER & CONTACTOR

14.1 Programmable Timer Unit

General

Timer input voltage shall be powered by AC 100 - 240 Volts AC (+10% / -15%, 50 hertz), conforms to:

Noise Immunity:	IEC 6100-4-4, 2kV (Power supply line)
Ambient operating temperature:	0°C to 55°C

Humidity: 10% - 90%

The Timer shall have the following programmable features:

- (a) Programmable: With 3 inputs and 1 output conditions per line.
- (b) Basic CPU Input / Output: Minimum 6 inputs and 4 outputs.

All outputs should have a relay switching capacity of 8 Amps at 250 Volts AC with independent common.

The Timer Central Processing Unit (CPU) shall be provided with built-in real-time clock and calendar functions. The real time clock should have an accuracy of ± 15 sec per month. The data of real time clock, calendar, holding bits, holding timers and counter present value shall be held by a non-battery system for a minimum of 48 hours for prolonged power interruptions.

The timer program and system setting data shall be stored in internal EEPROM to prevent loss of setting / program during power failure.

The Timer shall have the following features and functions:

- (a) Front panel LCD display with backlight. Backlight can be automatically cut-off through adjustable settings to save the life span of backlight.
- (b) Input filters settings to prevent noise-related malfunctions such as false triggering of inputs.
- (c) Password protection function to prevent unauthorised modification of Timer programs and settings.

Timer shall incorporate a communication port or infrared port for downloading of program and setting.

Timer shall support communications to host devices such as computers and Personal Digital Assistant (PDA).

The Timer system shall be equipped with the Windows Based software programming tools and drivers for the set-up of communication between Timer and host devices.

The Timer shall be provided with an application software tool running on Windows CE powered PDAs to allow setting of programs and the download / upload of the settings.

All Timer technical details and full communication protocols shall be provided.

The Timer shall have self-diagnostic functions and shall be displayed on the CPU LCD. All errors shall be able to communicate back to host communication port or infrared port.

The timer shall have minimum 16 programmable On / Off period within a year. Weekly timings and minimum 16 programmable calendar timings.

The On / Off switching timing of the timer shall be programmed based on the local sunrise and sunset time. It shall be programmed with at least eight (8) different segments of switching timing as follows:

S/No	From	To	Time On	Time Off
1	10-Jan	31-Mar	1910	0721
2	01-Apr	17-Jun	1903	0708
3	18-Jun	28-Aug	1907	0711
4	29-Aug	15-Sep	1859	0706
5	16-Sep	07-Oct	1853	0701
6	08-Oct	06-Dec	1847	0658
7	07-Dec	23-Dec	1855	0707
8	24-Dec	09-Jan	1903	0715

The timer shall have a Mean Time Between Failure (MTBF) of at least 300,000 hours and a stored programmed calendar year/month/day of equivalent length of time.

The timer shall be protected with an enclosure and a micro surge suppressor to prevent external adverse conditions such as high humidity, pests' infestation or frequent sudden power surges from the incoming power supply.

The size of the timer enclosure box shall measure 125mm(W) x 125mm(L) x 100mm(D) in dimension and rated at **IP 66**. The temperature rating is -40°C to 80°C of the box. The material used shall be Acrylonitrile Butadiene Styrene (ABS) for body, clear PolyCarbonate (PC) for cover.

The micro surge suppressor shall comply fully with the Transient Immunity EMC requirements (Norms EN 61000-4-4 & EN 61000-4-5), while providing effective transient voltage protection to the timer.

The micro surge suppressor shall design and manufactured to the safety standards: CE, UL, VDE, IEC, EN. The housing shall be made of compact plastic according to UL-VO.

V nominal	440 Volts, three-phase
Frequency	50 hertz
Max Operating Voltage	500 Volts (L-L)
Max Surge Current	4.5 KA
EMI / RFI noise rejection	20 dB
Response Time	1 ns

14.2 Electro-Magnetic Contactor

General

The contactor shall be manufactured in accordance with the latest edition of IEC 60158-1 and BS 5424 Part I. This contactor shall be suitable for use in the tropical climate and it is intended to be mounted in an enclosure. They shall be provided with main contacts capable of at least 105 switching operations and at least two auxiliary contacts for remote control (230 Volts, AC). Contactors for lighting control shall be of Utilisation Category AC2, Class 3.

The rated operating current shall be 60 Amps when used on 400 Volts, 50 hertz (rated operating voltage and frequency) and for uninterrupted duty. It shall be suitable for switching on high intensity discharge Mercury or Sodium Vapour lamps with power factor improvement capacitors connected across the incoming circuits of the lamps.

The contactors shall have at least 900 Amps making capacity and 720 Amps breaking capacity to prevent contact welding during switching on and off.

The rated operating magnetic coil voltage shall be 230 Volts $\pm 6\%$, 50 hertz $\pm 1\%$, single-phase. The coil shall be preferably encapsulated type.

Contactor Enclosure Box

The box shall be designed to contain a 60 Amps three-phase contactor. Its size shall be:

LENGTH	WIDTH	DEPTH
190mm - 200mm	190mm - 200mm	130mm - 135mm

The box shall be dust-protected and preferably be constructed of thermoplastic self-extinguishable material. The cover of the box shall be transparent.

Mounting rails or similar attachments shall be provided on the base of the box for easy mounting of a contactor.

The box shall be provided with eight (8) nos. holes on the top side for entry of 16mm^2 single-core and three (3) holes on the bottom side for entry of 35mm^2 single-core (box mounted in a vertical position). 11 nos. of entry seals (grommets) are to be provided for the entry holes.

MODE OF MEASUREMENT: AS PER MENTIONED IN SCHEDULE – B

Description

Mode of Payment: The rate shall be for a Unit of One No.

SR NO 15. CAT-6 CABLE

No.	Technical Specification
1.	Category 6 UTP Cable
	<ul style="list-style-type: none"> ➤ Cable should meet or exceeds Category 6/Class E attenuation. ➤ Should meet Cat 6 / Class E NEXT requirements in ISO/IEC 11801 and TIA/EIA 568B. ➤ Should be UL verified as Category 6. ➤ Should have Star filler (No bisector tape) cable construction for improved performance. ➤ Insulation material should be polyethylene. ➤ Performance guaranteed to meet or exceed Category 6/Class E Channel Specifications to 250 MHz. ➤ Category 6/Class E NEXT, PSNEXT, FEXT, ELFEXT, PSELFEXT and return loss extrapolated to 250 MHz. ➤ Cable should capable of delivering potentially in excess of 1 Gbps to the workstation in accordance with application standards. ➤ Should support IEEE 802.3 1000BASE-T, TIA-854-A 1000BASE-TX, plus other legacy LANs and applications as well as Video also.
	<p>Electrical / Mechanical Specification:</p> <p>Conductor DC resistance @ 20°C (max): 9.38 Ω /100m</p> <p>DC resistance Unbalance (max): 5%</p> <p>Mutual Capacitance @ 20°C (max): 5.6 nF/100m</p> <p>Nominal Velocity of Propagation: 70%</p> <p>Attenuation at 250 MHz: 32.8 dB</p> <p>Return Loss at 250 MHz: 17.3 dB</p> <p>ACR at 250 MHz: 5.5 dB</p> <p>PSACR at 250 MHz: 3.5 dB</p> <p>NEXT at 250 MHz: 38.3 dB</p> <p>PSNEXT at 250 MHz: 36.3 dB</p> <p>ELFEXT at 250 MHz: 19.8 dB</p> <p>PSELFEXT at 250 MHz: 16.8 dB</p> <p>Minimum Bending Radius: During Installation (50 mm) & After Installation (25 mm)</p> <p>Maximum Pulling Tension: 108 N (11 Kg)</p> <p>Operating Temperature: -15°C to 70°C</p> <p>Gauge: 24 AWG</p>

MODE OF MEASUREMENT: AS PER MENTIONED IN SCHEDULE – B
Description

Mode of Payment: The rate shall be for a Unit of One Mtr.

SPECIAL CONDITION

- (1) Point wiring shall be from the distribution box or fuse board, No sub main shall be measured.
- (2) Samples of materials shall be given to Engineer-in-charge and approval should be taken in writing before its use.
- (3) Fabrication drawing should be get approved from the Engineer-in -charge prior to Manufacturer.
- (4) Pipe laying lay out shall be as per consultants drawings.
- (5) There shall be no junction in wiring out let box shall be used after bond.
- (6) Electrical contractor shall make good the civil work if chased or damaged.
- (7) Electrical Engineer-in-charge opinion shall be final and binding on contractor.
- (8) Qualified labor and supervisors shall work at site.
- (9) Electrical Contractor shall not permit unqualified labor contractor to work at site. He shall observe Govt. rules regarding control of labor. He shall submit test report and carry out tests as required and furnish detailed drawings on completion of work. The responsible authorized person by the contractor should be available at site daily when work is in progress.
- (10) The work shall be carried out during working days between 8.00 A.M. to 6.00 P.M. only. The cable trench should not remain open for more than 24 hours after excavation. If contractor intends to work on holiday or outside working hours specified, he shall take prior permission from the Engineer-in-charge. In that case overtime to the staff shall have to be paid by the Contractor. The Electrical appliance-materials shall bear the ISI mark or declaration indicating manufacturer's names and appliances material used having been manufactured in accordance with the manufacturer's certificate issued by the Government of Gujarat and confirming to the standard specified by the I.S.I. shall be given by the contractor.
- (11) Cost of all test should be borne by contractor/ Tenderer, carried out for Electrical related equipment in presence of TPI/PMC/SDCB's representative.

ELECTRIFICATION WORKS – TECHNICAL SPECIFICATION

The conditions laid down under House Hold Electrical appliances (Quality control Act 1981) shall be followed.

I/We agree to carry out the above work at rates indicated above at _____ percentage above/below the rates indicated above i.e. I/We agree to carry out the above work at a total cost of Rs. _____ .

The Contractor shall provide test report and get the installation approved from Govt. Elect. Authority is required.

CONTRACTORS STAMP AND SIGNATURE.

[EQ. TO SOR 2012-2013 CAT-III]

8. TECHNICAL
SPECIFICATIONS FOR
ELV WIRING

TECHNICAL SPECIFICATIONS FOR ELV WIRING

1.0 SCOPE OF WORK

- 1.1 This section relates to specification for the supply, installation, connection, testing and commissioning of the wiring for Telephone / Computer / Fire detection / Music & Signage & wiring installation including supply of telephone cables, Multiple flexible wires, Shielded Wire, CAT-5 UTP computer signal wire, Junction boxes, Outlet boxes, and other related accessories required to complete the wiring and installation.
- 1.2 The main hardware of the systems shall be supplied by the client

2.0 CODES & STANDARDS

- 2.1 The cables shall be conforming to the following standards of latest revision :

Sr.	Item	Relevant IS	Relevant IEC
1	PVC insulated (heavy duty) electric cable.	IS : 1554 (Part I)	
2	Copper conductors in insulated cables and cords.	IS : 8130	
3	Mild steel wires, strips and tapes.	IS : 3975	

- 2.2 For Armoured Cables,

Sr.	Item	Relevant IS	Relevant IEC
1	PVC insulated and sheath of electric cables	IS : 5831	
2	Recommended current rating for cables.	IS : 3961 (Part I)	

- 2.3 Cables shall also meet the requirement of Indian Electricity rules, Fire Insurance Association and Electrical Inspector.

The wire for the systems shall confirm to IS: 694, 1554, 624 and local fire department.

The CCTV & Security Access System cable shall confirm to BS : 2316 and American Military standard MIL -C - 17 / JSS - 51100 and of Radio frequency co-axial type (RG - 11)

3.0 DESIGN BASIS & SITE CONDITIONS

- 3.1 The extra low voltage system wiring installation shall be carried out in the manner as approved by the local Authority. If found necessary, the drawing for installation shall be got approved by the local sanctioning authorities before commencement of the work.
- Separate conduits of 25 mm. diameter (minimum) shall be laid for extra low voltage system cables / wires.
- 3.3 The installation of conduits shall be carried out as per detailed specification given under section "INTERNAL WIRING".
- 3.4 All cables, lay on cable racks / trays shall be neatly stitched together.
- 3.5 Extra low voltage system wires / cable terminations both at the junction boxes and at

the socket outlets shall be done as per method approved by consultants and in conformity with their rules and regulations.

- 3.6 The final branch connections with single / twin pair cables in conduits and the minimum number of cables in each conduit shall be as follows:

Conduit dia. in mm.	Max. No. of cables
20	2 Nos. single pair
25	6 Nos. single pair
32	12 Nos. single pair
40	18 Nos. single pair

All the cables/wires provided shall be suitably designed for installation and satisfactory operation as specified below.

Site conditions	
Location Gujarat	Site altitude 81M above mean sea level
Ambient temperature	Relative humidity
Maximum 45 ° C	Maximum 85 %
Minimum 13 ° C	Minimum 25 %
Design 50 ° C	Design 90 % at 50 ° C
Electrical system data:	
Power supply for Equipment	
Voltage 12V to 90V ± 15 %	Frequency 10Hz to 300Hz ± 3 %
Permissible combined voltage & frequency variation ± 6 %	

4.0 TECHNICAL REQUIREMENTS

4.1 SYSTEM:

	<u>Voltage</u>	<u>Frequency</u>
4.1.1		
	Fire alarm, Security	12 V DC
	Music & P.A. system	10 Hz. -100 KHz
	Telephone system	30 V AC
		20 Hz. - 20 KHz.
		90 V AC
		300 Hz. - 5 KHz.

- 4.1.2 The extra low voltage system cables will be terminated on the tag block / junction box located at each floor.

- 4.1.3 From this tag block / junction boxes, separate M.S. conduits shall run for individual outlet connections to each area through tag boxes / junction boxes.

- 4.1.4 The conduits shall run in the surface manner in the vertical shaft and shall run in surface / concealed manner at every floor between shaft and the outlet box through tag box / junction boxes located on each floor.

- 4.1.5 Extra low voltage system cables / multi pair telephone cables shall be pulled through the above conduits and then be connected at both ends.

4.2 MATERIAL OF CONSTRUCTION

4.2.1 Conduit:

M.S. conduit, conduit accessories, steel junction boxes, etc. to be used for telephone wiring system shall have material specifications as described in section under title

“INTERNAL WIRING “ of this tender document.

4.2. 2 Cables & Wires:

The type of cables and the services shall be as follows :

4.3 TELEPHONE CABLE

4.3.1 Telephone multipart cable shall confirm to P & T specifications.

4.3.2 Annealed tinned bare copper conductor 0.6 mm. dia.

4.3.3 Cores twisted into pairs, pairs laid - up, fully filled and taped with suitable absorbent tape.

4.3.4 Armouring of galvanized steel wire.

4.3.5 PVC insulated, PVC inner sheathed and outer sheathed.

4.3.6 Aluminium Mylar tape with drain wire

4. 4 FIRE DETECTION & ALARM SYSTEM :

4.4.1 The wire for the systems shall confirm to IS: 694, 1554, 624 and local fire department.

4.4.2 Annealed tinned copper conductor 1.5 mm²

4.4.3 2 core twisted into pair

4.4.4 Shielded Al. Mylar tape.

4.4.5 PVC insulated, PVC inner sheathed and outer FRLS sheathed

4. 5 C.C.T.V. & SECURITY ACCESS SYSTEM :

4.5.1 The system cable shall confirm to BS : 2316 and American Military standard MIL -C - 17 / JSS - 51100 and of Radio frequency co-axial type (RG - 11)

4.5.2 Annealed tinned copper conductor.

4.5.3 Polyethylene insulated.

4.5.4 Annealed bare copper braiding.

4.5.5 PVC sheathing

4.5.6 Characteristic impedance - 75 ohm \pm 3

4. 6 INSTRUMENT CABLES :

4.6.1 Multi pair cables shall be used for transferring digital / analog signals from electrical meters to PLC.

4.6.2 Cable shall be capable of withstanding normal and short circuit condition of various systems to which it is connected, without damage, transportation to site, installation at site and operation.

4.6.3 Cable shall be capable of performing satisfactorily when laid in trenches, trays and directly buried in the ground.

- 4.6.4 All overhead wiring shall be supported in cable trays. The shield shall be grounded at one location only. All the wiring, cables, and termination points shall be suitably identified as per applicable codes and practices.
- 4.6.5 The vendor shall provide detailed cable scheduling mentioning the make, standard followed and other necessary details so as to satisfy the specified requirements.
- 4.7 SIGNAL CABLES :
- 4.7.1 Multi core twisted cables shall be rated for 660 / 1100 volts.
- 4.7.2 The cable shall be 1.0 mm.² multi stranded, PVC coated, high conductivity annealed tinned copper conductor with PVC insulation and sheathing, 100% aluminium Mylar shielding with copper drain conductor, galvanized steel armouring and overall PVC sheathing. Ripcord shall also be provided.
- 4.7.3 Multi core cables shall have the following additional features :
- 4.7.4 Pair identification by color coding / numbering.
- 4.7.5 Individual pair shielding and testing, apart from overall shielding and twisting. All the cables shall be of flame-retardant type. All the cables shall be terminated using Siemens type gland.
- 4.8 JUNCTION BOXES FOR EXTRA LOW VOLTAGE SYSTEM :
- 4.8.1 The junction boxes / the telephone tag blocks shall be suitable for the multi pair wires / cables and shall have two terminal blocks, cross connect type. All incoming and outgoing cables shall be terminated on separate terminal blocks. The cross connecting jumpers shall be insulated wires of same diameter and connected in same manner.
- 4.8.2 The junction boxes shall be mounted inside fabricated sheet steel boxes with removable hinged covers and lockable type and shall be painted as specified in section "Painting".
- 5.0 DRAWINGS & INFORMATION
- Not applicable
- 6.0 INSPECTION AND TESTING
- Performance of each equipment in coordination with other systems to prove the functional requirement.
- 7.0 METHOD OF MEASUREMENT
- 7.1 The extra low voltage system cable shall include supply, laying, connection, testing and commissioning of multi pair cable / wire on ceiling / wall on cable trays / racks including all supports and shall be measured and paid on running length basis. Cable trays / racks shall be paid for separately.
- 7.2 The multi pair junction boxes for extra low voltage system shall consist of strip, jumpered interconnections enclosure etc. and shall be measured and paid as one unit.
- 7.3 The conduit wiring for extra low voltage system outlet point shall include wire / cable in M.S. conduits and shall include junction boxes, pull boxes, 2A two pair connector / socket in M.S. box, outlet plate etc. from the floor tag blocks to the outlet point.
- 8.0 TRANSPORT, DELIVERY AND STORAGE

The prices shall be F.O.R. site basis including packing & forwarding charges. The quoted price must include all the costs for necessary mode of transportation up to the final location or site store. The ELV Wiring cables/wires should be supplied with required storage arrangements suitable for placing in open storage space. All incidental expenses during transportation shall be part of quoted prices including transit insurance. The charges for loading and unloading of equipments at site should form part of offer.

9.0 GURANTEE OF PERFORMANCE

The Bidder shall stand guarantee for the performance of entire wiring for twelve (12) months from the date of commissioning or eighteen (18) months from the date of dispatch, whichever is earlier, as agreed up on and as reproduced in the purchase order within the tolerance specified or as permitted by the relevant standards for the wiring in his scope of supply.

11.0 ATTACHEMENTS

- Datasheet

DATASHEET

Sr. No.	Particular	Description
1.1	Category 6 UTP Cable	
1.1.1	Class	E attenuation
1.1.2	Stander	ISO/IEC 11801, CENELEC EN50173 and TIA/EIA 568B.
1.1.3	Certify	UL
1.1.4	Performance guaranteed	6 connections in any length channel configuration up to 100 mtr
1.1.5	Support	Category 6/Class E NEXT, PSNEXT, FEXT, ELFEXT, PSELFEXT and return loss extrapolated to 250 MHz
1.1.6	Capability	Excess of 1 Gbps to the workstation in accordance with application standard
1.1.7	Supportive standard	IEEE 802.3 1000BASE-T, TIA-854-A 1000BASE-TX, ATM Forum CB1G plus other legacy LANs and applications as well as Video also.
1.1.8	Physical Specifications :	
	Weight	not more than 11.88 kg/305 m
	Nominal Jacket Thickness	not more than 0.022 in (0.559 mm)
	Nominal Outside Diameter	not more than 0.232 in (5.89 mm)
	Operating Temperature	-4°F to 140°F (-20°C to 60°C)
	Gauge:	23 AWG
1.2	Category 6 information outlet	
1.2.1	General	Category 6 outlets shall meet or exceed Category 6 transmission requirements for connecting hardware, as specified in TIA/EIA 568-B Commercial Building Telecommunications Cabling Standard and ISO/IEC 11801:21002 Second Edition, CENELEC EN 50173, and TIA/EIA568B
1.2.2	Standard	TIA/EIA 568-B Commercial Building Telecommunications Cabling Standard and ISO/IEC 11801:2002 Second Edition, CENELEC EN 50173, and TIA/EIA568B
1.2.3	Compatible with	Category 5E, 5 and 3 cords and cables
1.2.4	Design	Supporting to T568 A & B wiring
1.2.5	Capabilities	Being in a modular patching situation or as a modular telecommunication outlet (TO) supporting current 10BASE-T, Token Ring, 100 Mbps TP-PMD, 155 Mbps ATM, 622 Mbps ATM using parallel transmission schemes and evolving high-speed, high-bandwidth applications, including Ethernet, 1000BASE-T and 1 Gbps ATM
1.2.6	Supports	Category 6/Class E NEXT, PSNEXT, FEXT, ELFEXT, PSELFEXT and return loss extrapolated to 250 MHz
1.2.7	Certified	UL & cUL

Sr. No.	Particular	Description
1.2.8	Physical Specifications	
A	Dimensions	HxWxD: 2.0 cm x 2.0 cm x 3.1 cm - Universal
B	A/B labeling	
C	Plastic Material	High-impact, flame retardant, thermoplastic
D	Flammability Rating	UL-rated 94 V-0
E	Operating Temperature	14°F to 140°F (-10°C to 60°C)
F	Storage Temperature	40°F to 158°F (-40°C to 70°C)
G	Humidity	95% (non-condensing)
H	TIE/EIA Category	6
I	TIE/EIA Category	6
1.3	Category 6 Patch Panel (24/48 port)	
1.3.1	Electrical performance guaranteed	To meet or exceed TIA/EIA 568-B.2-1 Category 6 & ISO/IEC Category 6/Class E specifications.
1.3.2	Standard	ISO/IEC 11801, CENLEC EN 50173 and TIA/EIA
1.3.3	Certified	UL
1.3.4	Capabilities	network line speeds in excess of 1 gigabit per second
1.3.5	Back ward compatible	Category 5 e, 5 & 3 cords and cables
1.3.6	Panel configuration	24/48 port with A/B labeling & 110IDC connector terminations on rear of panel.
1.3.7	Physical Specifications	
A	Plastic Material	High-impact, flame retardant, thermoplastic
B	Flammability Rating	UL-rated 94 V-0
C	Operating Temperature	14°F to 140°F (-10°C to 60°C)
D	Storage Temperature	-40°F to 158°F (-40°C to 70°C)
E	Humidity	95% (non-condensing)
F	TIA/EIA Category	6
1.4	Category 6 Patch Cord	
1.4.1	Standard	TIA/EIA & ISO/IEC Category 6/Class E specifications
1.4.2	Performance guaranteed	Meet or exceed the channel specifications of the TIA "Category 6" up to 250 MHz
1.4.3	Supports	Complies Category 6/Class E NEXT, PSNEXT,FEXT, ELFEXT, PSELEFEXT and return loss extrapolated to 250 MHz
1.4.4	Protection	Antsnag features which provide protection from snagging during moves and re arrangements
1.4.5	Backward compatible	Category 5 and category 5E
1.4.6	Physical Specifications	
A	Contact Material	Phosphor Bronze
B	Contact Plating	Gold 50 micro-inch (1.27 microns), nickel 100 micro inch (2.54 microns)

Sr. No.	Particular	Description
C	Insertion Life	750 minimum
D	Plug Material	Polycarbonate UL-rated 94 V-O
E	Operating Temperature	14°F to 140°F (-10°C to 60°C)
F	TIA/EIA Category	6
G	UL and cUL	CM (cordage)
1.5	Face Plate for Information Outlet	
1.5.1	Contains	Slots that cover the screws to house labels and covers Two labels and covers included
1.5.2	Numbering	Both side for installation & maintenance identification
1.5.3	Provision	Blank to fill the unused outlet openings
1.5.4	Material	High impact, flame retardant, UL rated 94V-0 thermoplastic
1.6	Network Rack -12U (each per floor)	
1.6.1	Height	12U
1.6.2	Size	600 mm wide x 450mm deep
1.6.3	Cover	Top
1.6.4	Horizontal Cable Manager	2
1.6.5	Front section	Glass door & lock
1.6.6	MS door & glass door	Powder coated
1.6.7	Bottom/Upper cover	Suitable for sufficient cable opening (30-40 Cat 6 cable)
1.6.8	Fan	Single fan position with loaded fan
1.6.9	Distribution boxes	One 4 port (5 Amp x 4 socket)
1.6.10	Front & rear angles	19 °
1.7	Network Rack-42U (for server room)	
1.7.1	Height	42U
1.7.2	Size	600 mm wide x 1000 mm deep
1.7.3	Front door	Toughened glass
1.7.4	Cover	Top
1.7.5	Rear MS doors	With venting options
1.7.4	Horizontal Cable Manager	4
1.7.5	Front section	Glass door & lock
1.7.6	MS door & glass door	Powder coated
1.7.7	Bottom/Upper cover	Suitable for sufficient cable opening (00-400 Cat 6 cable)
1.7.8	Fan	4 fan position with 4 cooling fans
1.7.9	Distribution boxes	One vertical box on back side(5/15Amp x 10 socket)
1.7.10	Front & rear angles	19''

Sr. No.	Particular	Description
1.8	24 port Layer 2 data switch (each floor)	
1.8.1	Port	24 port 10/100 Mbps RJ45 Ethernet port
1.8.2	10/100/1000 Mbps	2 dual purpose
1.8.3	Power supply redundancy	1 serial port for control and RPS adaptor
1.8.4	Switch	Stackable
1.8.5	Capacity	Minimum 12Gbps Switching capacity 100 Gbps Stacking capacity 9 Mpps Packet Forwarding capacity 75 Mpps total stack packet forward capacity
1.8.6	Features	Protocol and Port based VLAN, 802.1X authentication, MAC based port authentication, Multilayer packet processing, 802.3ad, IGMP snooping, 4 priority queues per port, Jumbo Frame Support, One to One & One to Many port mirroring, SSH2 and SSL support
1.8.7	Foot print	1 RU
1.9	24 port Layer 2+ data switch (each floor)	
1.9.1	Port	24 port 10/100 Mbps RJ45 Ethernet port 4 combo 1000 Base SFP shared with RJ45 Ethernet port
1.9.2	Switch	Stackable switch with dedicated stacking port at back plane
1.9.3	Power supply redundancy	1 serial port for control and RPS adaptor
1.9.4	Capacity	Minimum 94 Gbps aggregate switching throughput capacity Minimum 35 Mpps Packet Forwarding capacity, 230 Mpps total stack packet forward capacity
1.9.5	Features	Protocol and Port based VLAN, 802.1X authentication, MAC based port authentication, Web based authentication, Multilayer packet processing, 802.3ad, IGMP snooping, 8 priority queues per port, Dynamic VLAN assignment, Jumbo Frame Support, One to One & One to Many port mirroring, SSH2 and SSL support
1.9.6	Upgradeable options	Suitable for layer 3 features such as static routes, RIP V2, inter VLAN routing, VRRP
1.9.7	Upgradeable options	Suitable for layer 3 features such as static routes, RIP V2, inter VLAN routing, VRRP

[EQ. TO SOR 2012-2013 CAT-III]

3. TECHNICAL SPECIFICATIONS
FOR
ERECTION, TESTING & COMMISSIONING
OF ELECTRICAL INSTALLATIONS

ERECTION, TESTING & COMMISSIONING OF ELECTRICAL INSTALLATIONS

1.0

SCOPE OF WORK

- 1.1 The intent of this specification is to define the requirements for the installation, testing and commissioning of the electrical system like H.T VCB panel, transformer, L.T. panels, Cables, earthing network, Internal and External lighting, Light fixtures etc.. Requirement of this project shall be as specified in bill of quantities / approved drawings / general specifications or as per the battery limits fixed by the owner / consultant.

2.0

STANDARDS

- 2.1
1. The work shall be carried out in the best workman like manner in conformity with this specification, the relevant specification / codes of practice of the Indian Standards Institution, approved drawings and the instructions issued by the authorised representative, from time to time. Some of the relevant Indian Standards are listed elsewhere in this tender document.
 2. In addition to the standards mentioned in 2.1, all works shall also conform to the requirement of the following :
 3. Indian Electricity Act and Rules framed there under.
 4. Fire Insurance Regulations.
 5. Regulations laid down by the Chief Electrical Inspector of the State / State Electricity Board / Union Territory.
 6. Regulations laid down by the Factory Inspector of the State / Union Territory.
 7. Any other regulations laid down by the local authorities.
 8. Installation & operation manuals of original manufacturers of equipment.

3.0

ERECTION

- 3.1 The contractor shall make his own arrangement for safe transportation of all the items to the erection site and also carry out complete loading / unloading during transportation. Equipment shall not be removed from packing cases unless the floor has been made ready for installing them. The cases shall be opened in presence of the client / consultant or his authorised representative. The empty packing cases shall be returned to the stores and any document if found with the equipment shall be handed over to the client's representative. Any damage or shortage noticed shall be reported to the client / consultant in writing immediately after opening of packing cases.

- 3.2 ONAN TYPE TRANSFORMER

1. Erection

Transformer complete with radiators, bushings, conservator and miscellaneous accessories shall be thoroughly inspected and any damage noticed shall be reported to the client / consultant. Before erection of transformer, the level of rails on foundation shall be checked and minor corrections if necessary shall be carried out. After the completion of erection, necessary stoppers shall be provided at the wheels. All loosely supplied fittings / accessories shall be cleaned and mounted on the transformer and connections made. After completely assembling & installation, the transformer shall be cleaned and touched up with a paint supplied by the manufacturer applied wherever necessary. All cover bolts shall be checked for proper tightness. (The foundation of transformer and rail fixing will be made by some other agency).

2. Testing

Winding insulation resistance shall be measured from primary and secondary to ground and between primary and secondary.

Test the operation of thermister type sensor relay in accordance with the manufacturer's instructions.

Check the polarity of terminals and the phase sequence.

Proforma for transformer tests :

3. Proforma for transformer tests :

- Transformer name plate.
- Insulation resistance test with 1000 V meagre.
 - a) between primary to earth
 - b) between secondary to earth
 - c) between primary and secondary
- Operation of the tap changer.
 - Operation of the tap at tap No. 1
 - Operation of the tap at tap No. 2
 - Operation of the tap at tap No. 3
 - Operation of the tap at tap No. 4
 - Operation of the tap at tap No. 5
- Polarity marking and phase sequence.
- Earth resistance: Body & Neutral tank.

[This proforma shall be jointly signed by the CLIENT/ CONSULTANT and the contractor in duplicate].

3.3 POWER CONTROL CENTER / MOTOR CONTROL CENTER, DISTRIBUTION BOARDS

1. Erection

Electrical panels and bus duct shall be delivered in convenient shipping section by the manufacturer. The contractor shall make his own arrangement for safe transportation of all the items to the erection site and also carry out complete loading / unloading during transportation. The contractor shall be responsible for final assembly and interconnection of busbars / wiring. Foundation channel shall be grouted in the flooring by the contractor. Switchgear shall be aligned and levelled on their base channels and bolted to them as per the instructions of the client / consultant. The earth bus shall be made continuous throughout the length. Loosely supplied relays and instruments shall be mounted and connected on the switchgear. The contacts of the drawout circuit breaker shall be checked for proper alignment and interchangeability.

After erection, the switchboard shall be inspected for dust and vermin proof. Any hole which might allow dust or vermin etc. to enter the panel shall be plugged suitably at no extra cost. If the instrument transformers are supplied separately, they shall be erected as per the direction of the client / consultant. The contractor shall fix the cable glands after drilling the bottom / top plates of all switchboards with suitable holes at no extra cost.

Range of overload relays / timers etc. shall be checked with requirement of motor actually to be connected at site and if the same is undersized / oversized, it shall be brought to the notice of the client / consultant, who shall arrange procurement of corrected components. However, the contractor shall not charge anything extra for

labour for such replacements.

The busduct shall be suitably supported between switchgear and transformer. The opening in the wall where the duct enters, the switchgear room shall be sealed to avoid rain water entry. The foundation of the switchgear shall be raised suitably for minor adjustment to ensure proper alignment and connection of the busduct at no extra cost. Expansion joints, flexible connection, etc. supplied by the manufacturer / contractor of the busduct shall be properly connected.

2. Testing

Before electrical panel is energised, the insulation resistance of each bus shall be measured from phase to ground. Measurement shall be repeated with circuit breakers in operating positions and contacts open.

Before switchgear is energised, the insulation resistance of all control circuits shall be measured from line to ground.

The following tests shall be performed on all circuit breakers during erection.

- Contact alignment and wipe shall be checked and adjustment where necessary in accordance with the breaker manufacturer's instructions.
- Each circuit breaker shall be drawn out of its cubicles, closed manually and its insulation resistance measured from phase to phase and phase to ground.
- All adjustable direct acting trip devices shall be set using values given by the consultant/ manufacturer.
- The dielectric strength of insulating oil wherever applicable, shall be checked.
- Before switchgear is energised, the following tests shall be performed on each circuit breaker in its test position.
- Close and trip the circuit breaker from its local control switch push button or operating handle. Switchgear control bus may be energised to permit test operation of circuit breaker with A.C. closing with prior permission of the client / consultant.
- Test tripping of the electrically operated circuit breaker by operating mechanical trip device.
- Test proper operation of circuit breakers latch, check carriage limit switch if provided. Test proper operation of lockout device in the closing circuit. Wherever provided by simulating conditions which would cause a lockout to occur.
- Trip breaker either manually or by applying current or voltage to each of its associated protective release.
- Before switchgear is energised, the tests covered above shall be repeated with each breaker in its normal operating position.
- Capacitor banks shall be tested as per manufacturer's instructions. In addition, test for output and/or capacitance, insulation resistance test and test for efficiency of discharge device shall be carried out.
- All electrical equipment alarms shall be tested for proper operation by causing alarms to sound under simulated abnormal conditions.

3. Performa For PCC, MCC, DB, Control Panel Test

- Circuit breaker or contactor module designation / bus no.
- Insulation resistance test (contacts open, breaker racked in position)
 - a) between each phase of bus : Mega ohm
 - b) between each phase and earth : Mega ohm
 - c) DC and AC control and auxiliary circuits : Mega ohm

d) between each phase of CT / PT and between
CT & PT circuit if any : Mega ohm

- CT checks
 - a) CT ratio
 - b) CT secondary resistance
 - c) CT polarity check
- Check for contact alignment and wipe.
- Check / test all releases / relays.
- Check mechanical interlocks.
- Check electrical interlocks.
- Check switchgear / control panel wiring.
- Check breaker / contactor circuit for :
 - a) Closing - local & remote (wherever applicable)
 - b) Tripping - local & remote (wherever applicable)
- Opening time of breaker / contactor.
- Closing time of breaker / contactor.

[This proforma shall be jointly signed by the CLIENT / CONSULTANT and the contractor in duplicate].

3.4 INSTALLATION OF CABLE NETWORK

Cable network shall include power, control and lighting cables which shall be laid in underground trenches, hume pipe open trenches, cable trays, G.I. pipes, or on building structures as detailed in the relevant drawings, cable schedules or as per the client / consultant's instructions. Supply & installation of cable trays, G.I. pipes / conduits, cable glands and sockets of both end isolators, junction boxes, remote push button stations, etc. shall be under the scope of the contractor.

1. General requirements for handling cables :

- Before laying cables, this shall be tested for physical damage, continuity, absence of cross phasing, insulation resistance to earth and between conductors. Insulation resistance tests shall be carried out with 500 / 1000 V megger.
- The cables shall be supplied at site, wound on wooden drums as far as possible. For smaller length and sizes, cables in properly coiled form can be accepted. The cables shall be laid by mounting the drum of the cable on drum carriage. Where the carriage is not available, the drum shall be mounted on a properly supported axle, and the cable laid out from the top of the drum. In no case the cable will be rolled on as it produces kinks which may damage the conductor.
- Sharp bending of cable shall be avoided. The bending radius for PVC insulated and sheathed, armoured cable shall not be less than 10 D, where "D" is overall diameter of the cable.
- While drawing cables through G.I. pipes, conduits, RCC pipes, ensure that size of pipe is such that, after drawing cables, 40% area is free. After drawing cables, the end of pipe shall be sealed with cotton / bituminous compound.
- High voltage (11 KV and above), medium voltage (240 V and above) and other control cables shall be separated from each other by adequate spacing or running through independent pipes / trays.

- Armoured cables shall never be concealed in walls / floors / roads without G.I. pipes, conduits or RCC pipes.
- Joints in the cable throughout its length of laying shall be avoided as far as possible and if unavoidable, prior approval of site engineer shall be taken. If allowed, proper straight through epoxy resin tight joint shall be made, without any additional cost.
- A minimum loop of 3 mtr. shall be provided on both ends of the cable, and on both ends of straight through cable joint. This additional length shall be used for fresh termination in future. Cable for this loop shall be paid for supply and laying.
- Cable shall be neatly arranged in the trenches / trays in such manner so that criss-crossing is avoided and final take off to the motor / switchgear is facilitated. Arrangement of cable within the trenches / trays shall be the responsibility of the contractor.
- All cable routes shall be carefully measured and cable cut to the required lengths and undue wastage of cables to be avoided. The routes indicated in the drawings is indicative only and the same may be rechecked with the client / consultant before cutting of cables. While selecting cable routes interference with structures, foundations, pipelines, future expansion of buildings etc. should be avoided.
- All temporary ends of cables must be protected against dirt and moisture to prevent damage to the insulation. For this purpose, ends of all PVC insulated cables shall be taped with an approved PVC or rubber insulating tapes. Use of friction type or other fabric type tape is not permitted. Lead sheathed cables shall be plumbed with lead alloy.
- Wherever cable rises from underground / concrete / masonry trenches to motors / switchgears / push buttons, these shall be taken in G.I. pipes of suitable size, for mechanical protection upto 300 mm. distance of concerned cable gland or as instructed by the client / consultant.
- The cable pass through foundation / walls of other underground structures, the necessary ducts for opening will be provided in advance for the same. However, should it become necessary to cut holes in existing foundation of structures the electrical contractor shall determine the location and obtain approval of the client / consultant before cutting is done.

2. LAYING OF CABLES (UNDERGROUND SYSTEM)

Cables shall be so laid in trench that this will not interfere with other underground structure. All water pipes, sewage lines or other structures which become exposed by excavation shall be properly supported and protected from injury until the filling has been rammed solidly in places under and around them. Any telephone or other cables coming in the way are to be properly shielded / diverted as directed by the owner / consultant.

- Cable shall be laid at minimum depth of 750 mm. in case of L.T. and 1200 mm. in case of H.T. from ground level. Excavation will be generally in ordinary alluvial soil. The width of trench shall be sufficient for laying of required no. of cables.
- Sand bedding 75 mm. thick shall be made below and above the cables. Layer of bricks (full size) shall be laid above sand bedding on the sides and above the of cables to cover cable completely. More than one cable can be laid in the same trench by providing a brick on edge between two cables. However, the relative location of cables in trench shall be maintained till termination. The surface of the ground after back filling the earth shall be made good so as to conform in all respects to the surrounded ground and to the entire satisfaction of the client / consultant.
- For all underground cables, route markers should be used :

- a) Separate route markers should be used for LT, HT and telephone cables.
 - b) Route markers should be grounded in ground with 1:2:4 cement concrete pedestal size 230 x 230 x 300 mm..
 - c) Cable markers should be installed at an interval not exceeding 30 mtr. along the straight routes of cables at a distance of 0.5 mtr. away from centre of cable with the arrow marked on the cable markers plate indicating the location of cable. Cable markers should also be used to identify change in direction of cable route and for location of every joint in underground cable.
- RCC hume pipe for crossing road in cable laying shall be provided by employer. No deduction shall be made for cable laying in hume pipe for not providing bricks, sand and excavation. RCC hump pipe at the ends shall be sealed by bituminous compound after laying and testing of cables by electrical contractor without any extra charge.

3. LAYING OF CABLE IN MASONRY TRENCHES

- Masonry / concrete trenches for laying of cables shall be provided by employer. However, steel members such as M.S. angles / flats etc. shall be provided and grouted by electrical contractor to support the cables without any extra charge. Cables shall be clamped to these supports with minimum saddles / clamps. More than one tier of cables can be provided in the same trench if the no. of cables are more.
- Entry of cables in trenches shall be sealed with bituminous MASTIC compound to stop entry of water in trenches.

4. LAYING OF CABLES IN CABLE TRAYS

- Cable trays and steel members such as M.S. angle / channel / flats etc. shall be provided and fixed by the erector.
- Cable shall be fixed in cable trays in single tier formation and cables shall be clamped with aluminium flat clamps and galvanised bolts / nuts.
- Earthing flat / wire can also be laid in cable tray alongwith cables.
- After laying of cables, minimum 20% area shall be spare.

5. TERMINATION AND JOINTING OF CABLES

- a) For HT cables suitable size of Reychem termination kit shall be used.
- b) Use of glands :

All PVC cables upto 1.1 KV grade, armoured or unarmoured shall be terminated at the equipment / junction box / isolators / push buttons / control accessories, etc. by means of suitable size double compression type cable glands. Armour of cable shall be connected to earth point. The contractor shall drill holes for fixing glands wherever necessary. Wherever threaded cable gland is to be screwed into threaded opening of different size, suitable galvanised threaded reducing bushing shall be used of approved type.

In case of termination of cables at the bottom of the panel over a cable trench having no access from the bottom, a close fit holes should be drilled in the bottom plate for all the cables in one line, then bottom plate should be split in two parts along the centre line of holes. After installation of bottom plate and cables with glands, it shall be sealed with cold sealing compound.

- **USE OF LUGS / SOCKETS**

All cable leads shall be terminated at the equipment terminals, by means of crimped type solderless connectors unless the terminals at the equipment ends are suitable for direct jointing without lugs / sockets.

The following is the recommended procedure for crimped joints and the

same shall be followed :

- a) Strip off the insulation of the cable and with every precaution, not in severe or damage any strand. All insulation's to be removed from the stripped portion of the conductor and ends of the insulation should be clean and square.
- b) The cable should be kept clean as far as possible before assembling it with the terminal / socket. For preventing the ingress of moisture and possibility of re-oxidation after crimping of the aluminium conductors, the socket should be filled with corrosion inhibiting compound. This compound should also be applied over the stripped portion of the conductor and the palm surface of socket.
- c) Correct size and type of socket / ferrule / lug should be selected depending on size of conductor, and type of connection to be made.
- d) Make the crimped joint by suitable crimping tool.
- e) If after crimping the conductor in socket / lug, some portion of the conductor remains without insulation the same should be covered sufficiently with PVC tape.
- f) For HT cable upto 11 KV the manufacturer's recommendation should be followed.

- DRESSING OF CABLE INSIDE THE EQUIPMENT

After fixing of cable glands, the individual cores of cable shall be dressed and taken along the cable ways (if provided) or shall be fixed to the panels with polyethylene straps. Cable shall be dressed in such a manner that small loop of each core is available inside the panel.

For motors of 20 HP and above, terminal box if found not suitable for proper dressing of aluminium cables, the erector shall modify the same without any additional cost.

Cables inside the equipment shall be measured and paid for.

- IDENTIFICATION OF CABLES / WIRES / CORES

Power cables shall be identified with red, yellow and blue PVC tapes. For trip circuits identification, additional red ferrules shall be used only in the particular cores of control cable at the termination points in the switchgear / control panels and control switches.

In case of control cables all cores shall be identified at both ends by their wire numbers by mean of PVC ferrules or self sticking cable markers, wire numbers shall be as per schematic / connection drawing. For power circuit also, wire numbers shall be provided if required as per the drawings of switchgear manufacturer / supplier.

6. TESTING OF CABLES

- Before energising, the insulation resistance of every circuit shall be measured from phase to ground. This requires 3 measurements if one side is grounded and 6 measurements for 3 phase circuits.
- Where splices or terminations are required in circuits rated above 650 volts, measure insulation resistance of each length of cable before splicing and/or terminating. Repeat measurements after splices and/or terminations are complete.
- DC high voltage test shall be made after installation on the following :
 - a) All 1100 volts grade cables in which straight through joints have been made.
 - b) All cables above 1100 V grade.

and shall conform to the requirement on earth electrodes mentioned in the latest edition of Indian Standard IS: 3043, Code of Practice for Earthing Installation.

8. The earth conductors (Strips / Wires copper / Hot dip G.I.) Inside the building shall properly be clamped/ supported on the wall with Galvanised Iron clamps and Mild Steel Zinc Passivated screws / bolts. The conductors outside the building shall be laid atleast 600 mm. below the finished ground level.
9. The earth conductors shall either terminate on earthing socket provided on the equipment or shall be fastened to the foundation bolt and / or on frames of the equipment. The earthing connection to equipment body shall be done after removing paint and other oily substances from the body and then properly be finished.
10. Over lapping of earth conductors during straight through in joints, where required, shall be of minimum 75mm. long.
11. The earth conductors shall be in one length between the earthing grid and the equipment to be earthed

4.2 EARTH LEADS AND CONNECTIONS

1. Earth lead shall be bare copper or Galvanised steel as specified with sizes shown on drawings. Copper lead shall have a phosphor content of not over 0.15 %. G.I. strip buried in the ground shall be protected with bitumen and hessian wrap or polythene faced hessian and bitumen coating. At road crossing necessary hume pipes shall be laid. Earth lead run on surface of wall or ceiling shall be fixed on saddles so that strip is atleast 8 mm away from the wall surface.
2. The complete earthing system shall be mechanically and electrically bonded to provide an independent return path to the earth source.

4.3 TEST

1. The entire earthing installation shall be tested as per requirements of Indian Standard Specification IS: 3043.
2. The following earth resistance values shall be measured with an approved earth megger and recorded.
 - 1) Each earthing station
 - 2) earthing system as a whole
 - 3) Earth continuity conductors
3. Earth conductor resistance for each earthed equipment shall be measured which shall not exceed 5 ohm in each case.
4. Measurements of earth resistance shall be carried out before earth connections are made between the earth and the object to be earthed.
5. All tests shall be carried out in presence of the Pmc

5.0 CONCEALED / SURFACE CONDUIT WORKS

5.1 LAYING OF CONDUITS

1. Conduits shall be laid before casting in the upper portion of a slab / in PCC if below flooring or otherwise, as may be instructed in accordance with approved drawings, so as to conceal the entire run of conduits and ceiling outlet boxes. Conduits shall be so laid that they are interconnected. This is required to facilitate pulling of wires from different openings in case of any of the outlet is outlet is blocked during slab casting. Vertical drops shall be cut by the contractor to sufficient depth to allow full thickness of plaster over conduits. The width of the chases will be made to accommodate the required number of conduits. The chases will be filled with cement, coarse
2. When the conduit is to be embedded in a concrete member it shall be adequately

tied to the reinforcement to prevent displacement during casting. Tie wire to be supplied by the contractor.

3. Cutting of chases in any RCC member / finished floor / already finished surface is not allowed unless prior approval of Site Engineer is taken in site instruction book. If a chases is cut in an already finished surface, the contractor shall fill the chases and finish it to match the existing finish including painting at his cost to Site Engineer's satisfaction.
4. Contractor shall not cut any iron bars to fix the conduits. Puncher of wooden / steel shuttering for RCC slab / beams / column etc. for conduit work is also not allowed, unless Site Engineer permits in site instruction book under special conditions.
5. Run of conduit pipe through expansion joints in RCC members should be avoided as far as possible and if unavoidable, flexible conduit pipe should be used with ceiling outlet box on both sides of expansion joints.
6. Conduit on surface of RCC walls / RCC members shall be avoided as far as possible and if unavoidable prior approval of Site Engineer on sample saddles, clamps screws and a minimum 5 mtr. conduit laid on surface shall be taken, to achieve best possible workmanship. Distance between 2 consecutive clamps for fixing conduit on surface shall not exceed 900 mm. wooden patties for fixing saddles / clamps shall be used. Use of roll plug / steel fastener with hard setting / sealing compound is recommended.
7. In case of stone masonry, necessary conduits with M.S. boxes should be placed as the masonry is in progress, since after completing masonry, it is very difficult to cut chases in wells. Special location of cement concrete shaft is also recommended to conceal conduit in stone masonry and the same shall be provided by client / consultant.
8. In ground floor conduiting below the flooring should be avoided. Wherever it is unavoidable G.I. pipe should be used with prior approval of Site Engineer.

5.2 CEILING / WALL OUTLET BOXES FOR LIGHTS / FANS

1. Outlet boxes shall be of steel with aluminium cover and so installed as to maintain continuity throughout. These shall be protected at the time of laying by filling with jute / earth / cotton etc. so that no cement mortar finds its way inside during concreting or plastering etc. Typical sketches for such outlet boxes shall be supplied alongwith other working draws. In beams conduit socket shall be provided in place of outlet boxes. The same shall be used for installation of luminaire.
2. For fixing light fixtures / brackets, outlet boxes complete with check nut for holding conduits shall be used. For lighting fixture suitable for 20 watts fluorescent tubes / incandescent lamps / mercury vapour lamps, only one outlet box is required. For fixing lighting suitable for 40 watts fluorescent lamps, two numbers outlet boxes should be provided at a distance of 300 mm. away from the centre in the longitudinal direction of the fixture, so that the use of patties / roll plug etc. may be avoided, as well as wiring from outlet box to the light fitting is to be installed in RCC beam and due to heavy reinforcement at the bottom of beam it is not possible to provide outlet boxes simple conduit should be provided. However alternative fixing arrangement shall be made in consultation with client / consultant.
3. For fixing ceiling fans, circular outlet boxes, 100 mm. diameter, complete with 12 mm. dia. Mild Steel rod 300 mm. long, for holding 12 mm. dia. Mild Steel cover 125 mm. dia. at bottom shall be used.

5.3 DRAW OUT JUNCTION BOXES

Steel drawout boxes at angle dimensions shall be provided at a convenient points on walls / ceilings to facilitate pulling of long runs of cables / wires. These shall be completely concealed with Anodised Aluminium, flush with plaster works. These draw boxes should be five sided. The location of these boxes is to be decided prior to fixing, as per site requirement and following should be treated as general

guidance for deciding the location of these :

1. These should be provided at a place where these are not in direct view. Recommended place is 400 / 450 mm. below ceiling, if conduits are running vertically.
2. Junction box in the offset of bottom of RCC beam and vertical wall should not be provided.
3. If junction boxes are coming side by side for two or more conduits, one common M.S. box of proper size can be used to act as junction box.
4. If junction box is to be provided in ceiling, its position should be so located that it is in line with other light / fan points.
5. Junction boxes should never be used for splitting one conduit into two or more. Junction box for such functions is avoidable and for this, number of conduits to be connected to one switch board should be calculated correctly as per drawing before laying conduits in ceiling.
6. Locating junction boxes on outer surface of exterior walls of building should be avoided as these are in direct view and are also exposed to weather.
7. Junction boxes should never be closed permanently by plaster. Removable covering of aluminium should be provided for conduit junction boxes for M.S. junction boxes removable hylem plate should be provided. This cover may be painted with wall colour.
8. Junction boxes in important areas should be avoided and can be located in toilets / corridors / service shafts and stores etc.

5.4 SWITCH BOXES

Steel boxes of required sizes, shall be provided to house speed regulators of fans, switches for lights, fans, plug sockets etc. as per requirement of drawings. These should be so designed that accessories on Anodised aluminium sheet could be mounted with tapped holes and brass machine screws, leaving ample space at the back and on the sides for accommodating wires and check nuts at conduit entries. These shall be attached to conduits by means of check nuts on all walls of the boxes through which the conduits are entering. These shall be completely connected leaving edges flush with finished wall surfaces. Anodised aluminium cover should be fixed to these switch boxes by means of brass chrome plated machine screws and cup washers. Utmost care shall be taken by contractor to ensure that all switch boxes are in line and level.

Inside each switch box, one bolt shall be welded to receive earthing wire.

5.5 SWITCH AND SOCKET

Switches shall be installed at 900 mm above finished floor level unless otherwise indicated on the drawings.

The switch controlling the light point or fan shall be connect on to the phase wire of the circuit and neutral shall be continuous, having no fuse or switch installed in the line except at the D.B. All fan regulators shall be fixed inside the switch boxes on adjustable flat M.S. strips / plates with tapped holes and brass machine screws, leaving ample space at the back and side for accommodating wires.

The cover plates to the switch box shall be fixed by means of sunk head brass cadmium screws.

Where two or more switches and fan regulators are installed together, they shall be provided with one gang cover plate with knockouts to accommodate required number of switches, sockets and regulators.

The switch controlling the socket outlet shall be on the phase wire of the circuit. The third pin of the socket shall be connected to the earth continuity conductor of the circuit

The switch boxes, installed back-to-back in the same wall shall be offset from each other, 150 mm horizontally, to preclude noise transmission.

5.6 CLEANING AND PROTECTION OF CONDUIT SYSTEM

The entire conduit system including outlet boxes, junction boxes and switch boxes shall be thoroughly cleaned after completion of erection and tested for not blockage by air / sound or steel wire prior to finishing of building by air / sound or steel wire prior to finishing of building and before drawing in of cables / wires to safeguard conduit system against filling up with the plaster / cement slurry / water etc. all the outlet and switch boxes will have to be provided with temporary jute / cotton filling, covers and plugs etc.. Within tendered cost which shall be replaced later on by hylem / sheet cover after wiring as required.

5.7 TESTING OF INSTALLATION

Before a completed installation is put into service, the following tests shall be complied with:

1. INSULATION RESISTANCE

The insulation resistance shall be measured by applying 500 volt megger with all fuses in places, circuit breaker and all switches closed.

The insulation resistance in gegohms of an installation, measured shall not be less than 50 megohms divided by the number of points on the circuit.

The insulation resistance shall be measured between

EARTH TO PHASE

EARTH TO NEUTRAL

PHASE TO NEURAL

PHASE TO PHASE

2. EARTH CONTINUITY PATH

The earth continuity conductors shall be tested for electrical continuity and the electrical resistance of the same along with the earthing lead but excluding any added resistance or earth leakage circuit-breaker, measured from the connection, with the earth electrode to any point in the earth continuity conductor in the completed installation and shall not exceed one ohm.

3. POLARITY OF SINGLE POLE SWITCHES

A test shall be made to verify that every no-linked, single pole switch is connected to one of the phase of the supply system.

4. COMPLETION CERTIFICATES

All the above tests shall be carried out in presence of client and the results shall be recorded in prescribed forms. Any default during the testing shall be immediately rectified and that section of the installation shall be re tested. The completed test result from shall be submitted to the client for approval.

On completion of an electric installation a certificate shall be furnished by the contractor, countersigned by the certified supervisor under whose direct supervision the installation was carried out. This certificate shall be in a prescribed form as required by the local electric supply authority.

6.0 INSTALLATION OF LIGHTING FIXTURES / FANS

6.1 INSTALLATION OF LIGHTING FIXTURES

Scope of work under this item shall start from light point, with a 5 A bakelite connector, 2 core 1.5 mm.² PVC insulated wires from this connector to the

connector inside the lighting fixture, connections, fixing of lighting fixture complete with all accessories, lamps on wall / roof / steel truss etc. testing the lighting fixture and commissioning. If wire length of light point is enough to reach connector of light fitting, connector in light point can be deleted.

6.2 INSTALLATION OF EXHAUST FANS

Scope of work under this system shall start from exhaust fan point, with a ceiling rose, 2 core 2.5 mm.² PVC insulated wire from ceiling rose to connector of exhaust fan, connections, making fan opening in walls including repair / finishing fixing of exhaust fan complete with accessories and louvers on walls with hold-fasts, testing the exhaust fans and commissioning.

7.0 INSTALLATION OF EXTERNAL LIGHT FIXTURES

7.1 BRACKET FOR STREET LIGHT FITTINGS

The brackets shall be made of 38 mm. NB MS class "B" pipe approx. 1.8 mtr. long bent at the centre at an angle 120° C. with necessary holding brackets, hold fasts etc. with special reducer at the end to accommodate type of street light fitting to be fixed. Bracket shall have 1 coat of anti-corrosion paint before despatch to site and 2 coats of approved make and shade of aluminium paint. This bracket shall also be provided with one M.S. water tight box complete with the connector, neutral link, rewirable fuse etc.. See enclosed drawings of street light poles.

7.2 INSTALLATION OF POLES

Installation of poles shall be done as per enclosed drawings of street light poles. The depth of pole to be buried in ground shall be 1/5th of the total pole length or as specified in drawing, whichever is more. Special care shall be taken in erecting poles so that these are not strained or damaged during erection and are firmly stayed till the foundation are secured. The pole shall be grouted inside ground pit (cross-section 600 x 600 mm.) with cement concrete 1:2:4. Before the placement of concrete around pole in the pit, necessary conduit pipes (not less than 25 mm. dia.) shall be placed for facilitating drawing of cables. Separate conduit shall be provided for incoming and outgoing cables. The cement concrete shall be protected from prematured drying by curing for atleast 7 days after pouring. All concrete surface from 150 mm. below ground level to top shall be finished smooth with cement mortar 1:4.

7.3 INSTALLATION OF STREET LIGHT FIXTURES

This includes fixing of street light fittings complete with accessories and lamps at the end of the pole / bracket, connecting it with 3 x 2.5 mm.² aluminium conductor, PVC insulated cable from water tight M.S. box, testing, commissioning. Third core shall be connected with earthing point of light fitting at one end and earthing point of marshalling box at the other end.

7.4 GENERAL NOTES FOR STREET LIGHTING

1. For supplying and laying of cables, technical specification (wiring) shall be applicable reference shall be made under heading Cable Work elsewhere in the tender.
2. For street light poles along roads, nearest finished road level shall be taken as ground level and for poles along compound wall / away from roads, existing ground / finished ground shall be taken as ground level.
3. Distance of 1 mtr. shall be maintained between centre of pole and centre of curb of road. For compound wall poles, distance between compound wall and poles shall be 3 mtrs.
4. A loop of 1.5 mtr. of cable shall be provided near each street light pole for all incoming and outgoing cable.

8.0

COMPLETION TESTS

- 8.1 After supply and installation of complete project or a particular building / area, following tests shall be carried out by the contractor before switching on the power to installation and the results shall be recorded and submitted to the Site-Engineer. If results are not satisfactory / as per standards set herewith, the contractor shall identify the defects / short coming and shall rectify the same. Nothing extra shall be paid for carrying out these tests and contractor has to arrange all necessary instruments.

8.2 INSULATION RESISTANCE TO EARTH

This is to be measured with all fuse links in place, all switches ON, all lamps and appliances in position by applying a voltage not less than twice the working voltage (subject to a limit of 500 V). Insulation resistance of the whole or any part of the installation to earth must not be less than 50 mega-ohms divided by the number of outlets (points and switch positions) except that it need not exceed one mega-ohm for the whole installation.

8.3 INSULATION RESISTANCE BETWEEN CONDUCTORS

Tests to be made between all the conductors connected to one pole or phase conductor of the supply and all the conductors connected to the middle wire or neutral or the other pole or phase conductors of the supply. For this test, all lamps shall be removed and all switches put ON. The result of the test must be 50 mega-ohms divided by the number of outlets (points and switch positions) but need not exceed 1 mega-ohm for the whole installation.

8.4 POLARITY OF SINGLE POLE SWITCHES

Tests shall be made to verify that all non-linked single pole switches are on phase conductor (live) and not on neutral or earth conductor. This can be done by connecting test lamps between two terminals of switch and earth. If the lamp lights up when switch is ON and either terminal is touched, the switch is correctly installed.

8.5 RESISTANCE OF METAL CONDUITS / SHEETS (EARTH CONTINUITY TEST)

In case of cables encased in metal whether conduit of metallic sheathing, the total resistance of the conduit or sheathing from the earthing point any other position in the completed installation shall not exceed 2 ohms. This can be carried out by following circuit :

One end of the load is connected to the ECC and its connection with the electrode and the other to the farthest point of the ECC. First, current through the circuit is measured with the resistance of 2 ohms short circuited by the link. Next, current is measured through the two ohms resistance by disconnecting the two leads from the ECC and joining them together. If current is more in the first case, the resistance of ECC is less than 2 ohms.

9.0

HANDING OVER / TAKING OVER

- 9.1 After completion of works and tests specified above, the various building of the project can be taken over by the employer as and when these are ready in all respects. However, the defect liability period of 12 months would start from the date, when all the buildings of the project have been completed and handed over, unless employer agrees for defect liability period in phased due to non-completion of civil work of few buildings for which electrical contractor is not responsible.

10.0

HANDING OVER / TAKING OVER

- 10.1 The Tenderer shall indicate the makes of tools, test equipment and other item listed below:

1. TOOLS

A. Set of spanners of sizes 6 mm to 32 mm width across flat

- Adjustable wrench of 36 mm jaw width
- Adjustable wrench of 23 mm jaw width

B. Heavy duty screw driver with full size insulated handle and blade length of

- 100 mm
- 50 mm
- 200 mm

2. TEST EQUIPMENT

A. 2500 V megger motor operated

B. 500 V megger hand operated

C. Multimeter (Battery operated) satisfying the following

- With 0-1 mA, 0-100 mA, 0-1A and 0-5A, AC & DC current ranges
- With 0-100 mV, 0-3V, 0-30 V, 0-300 V and 0-1000V AC & DC voltage ranges
- The resistance ranges shall be atleast five (0-100) m ohm, (0-1) Ohm, (0-10) Ohm, (0-100) Ohm, (0-100) mega ohm
- The Input impedance shall not be less than one mega Ohms for voltage ranges

3. LADDERS

Ladder shall be made out of light aluminium alloy of good strength. They shall be of step ladder, foldable, self supporting type with spreader of metallic angles or high strength nylon straps. The ladder shall be provided with shoes on bottom of legs. Rugs shall be flat type having thickness of 30 mm in case of 3 meters long ladders and 60 mm for 6 metres long ladder.

- 3 metres long
- 6 metres long

4. Tong tester - ammeter range 0 to 30, 150 & 300 Amps AC and voltmeter (0-600) V, class 1.0 with leads and leather case.

[EQ. TO SOR 2012-2013 CAT-III]

11. TECHNICAL
SPECIFICATIONS FOR
EXTERNAL LIGHTNING

Technical Specifications For External Decorative Lighting with Data Sheet

TECHNICAL SPECIFICATIONS FOR EXTERNAL STREET LIGHT POLE

1.0

SCOPE OF WORK

This section relates to specifications for Design, Supply (wherever called for), Installation, Connection, Testing and Commissioning of Decorative STREET LIGHT Luminaire

The Scope includes:

1. Loading-Unloading at site
2. Unpacking
- 1.1 3. Assembling
4. LED street light luminaire c/w Driver and Pressure Die Cast Aluminum Decorative Poles.
5. Decorative LED luminaire
6. Fixing and connecting wiring to the fixture
7. Testing and commissioning

2.0

CODES & STANDARDS

Sr.	Item	Relevant IS	Relevant IEC
1	General and safety requirements for light fittings	IS 1913	
2	Code of practice for lighting public thoroughfares	IS 1944	
3	Water proof electric lighting fittings	IS 3528	
4	Water tight electric lighting fittings	IS 3553	
5	M.S. tubular and other wrought steel pipe fittings	IS 1239	
6	Luminaries for street lighting. (Parts/Sec. 3)	IS 10322	
2.1 7	Classification of degree of protections provided by enclosures.		IEC 60529
8	Fixed general purpose luminaries		IEC 60598-2-1
9	General requirement and tests		IEC 60598-1
10	Limits for Harmonic current emission --THD < 10%		IEC 61000-3-2
11	Specification for Permitted Humidity Test		IEC 60068-2-38
12	Method for random sampling	IS 4905	
13	LED luminaire photometry measurement.	LM 79	
14	Lumen Maintenance	LM 80	

3.0

DESIGN BASIS & SITE CONDITIONS AND DESIGN CRITERIA FOR VENDORS

- 3.1 All the equipment and components provided and accessories shall be suitably designed for installation and satisfactory operation as specified below.

Site conditions	
Location Gujarat	Site altitude 81 M above mean sea level
Ambient temperature	Relative humidity
Maximum 45⁰ C	Maximum 85 %
Minimum 13⁰ C	Minimum 25 %
Design 50⁰ C	Design 98 % at 50⁰ C
Seismic factor Zone III as per IS:1893	Environmental Tropical/humid/corrosive/Dusty conditions
Electrical system data:	
Power supply for Equipment	
Voltage 230 V ± 5 %	Frequency 50 Hz ± 3 %

3.2 DESIGN CRITERIA FOR VENDORS

- The lighting calculations are to be carried out using the computer programme DIALUX 4.10 OR AGI 32 and shall include the average horizontal illuminance on the pathway, the average horizontal illuminance for ROAD on either side of the POLE / luminaire location, the glare, and the uniformity ratios including the average to minimum and the maximum to minimum.

- 3.2.2 The following parameters are to be specifically adhered to:

1. The average horizontal and vertical illuminance on the pathway shall be 10-12 LUX uniformly distributed when measured between poles located at spacing between poles shown in drawings and similar distance on perpendicular either side of the post top location.
2. Uniformity ratio maximum to minimum shall not exceed 5:1.
3. Uniformity ratio average to minimum shall not exceed 3:1.
4. Glare shall be minimum almost No Glare.

- 3.2.2 The lighting calculations will be based on a light loss factor (or) Maintenance Factor of 0.8 and a calculation grid of 1 metre intervals along the pathway and 0.5 metre intervals across the pathway.

- 3.2.3 The pole spacing will be governed by the drawings provided along with the tenders. In general the design shall be based on pole spacing as shown in tender drawings between each pole.

4.0 TECHNICAL REQUIREMENTS

4.1 SYSTEM

- 4.1.1 The lighting installation for the project shall be carried out by use of outdoor type, weather proof luminaries, to be mounted on pole and as shown in drawings.

- 4.1.2 Fitting including all accessories having IP66 protection Class (Optics Compartment)

- 4.1.3 The control gear shall be designed in such a way so that temperature rise of heat sink shall not be more than 40 Deg. C with respect to ambient temperature.

- 4.1.4 For External street lighting, luminaire shall be low glare such that it shall not cause inconvenience to the public viewed directly.

4.1.5 In general all luminaires shall be Dark Sky Compliant as required by ECBC / Green Building Norms.

4.1.6 Variation in illumination level shall be $\pm 1\%$ is allowed in input voltage range from 120 V AC to 270 V AC.

4.1.7 Electric power supply at 415 volt, three phase, four wire, 50 Hz. to be tapped from the lighting panel / or 230 V will be available at each pole foundation.

4.1.8 The electric power shall be distributed to the lighting poles through electric cables and shall be distributed equally on three phase of the electric power supply system.

4.1.9 Wherever required and suiting to aesthetic value Individual control fuse with junction box shall be provided on each poles. The junction box shall be weather proof (IP-66, IK-10), having gasketed lockable hinged cover.

4.1.10 The light poles shall be earthed individually with coil type earth station using 8 SWG G.I wire.

4.1.11 Electric cable required for the street lighting installation shall be 1100 volt grade, PVC insulated and sheathed, armoured cable having stranded Al/Cu. conductor of rating as mentioned in the drawing / BOQ.

4.1.12 Technical details of the fixtures IP & IK etc should be clearly mentioned in catalogue on website. Any deviation in the technical criteria must be supported by test from UL or ERDA lab and must be presented at the time of tender submission

4.2 LED LUMINAIRES:

4.2.1 High power and high lumen efficient LEDs suitable for following features shall be used:

a The working life of the lamp at junction temperature of 110 Deg. Centigrade for 350 mA to 700 mA current shall be more than 50,000 hours of accumulative operation and shall be suitable for continuous operation of 24 hours per day .these features shall be supported with datasheet. After 50,000 burning hours, the luminaire intensity shall be at least 70%.

b Adequate heat sink with proper thermal management shall be provided.

c Color temperature of the proposed white color LED shall be 3000k – 3500 k.

d The direct output of LED shall be more than 115 lumen per watt at minimal operating current and shall ensure guaranteed operation life of 50,000 burning hours with Controlled junction temperature of 110 Deg. Centigrade.

e System Efficiency including all LED, driver electronics etc. shall be more than 85%.

f Power factor of complete fitting shall be more than 0.95.

g The driver card shall withstand 440V and shall resume normal working when nominal voltage is applied again.

h Thermal management shall be designed in such a way that the LED junction temperature shall not exceed beyond 40 Deg. Centigrade over ambient temperature. Design ambient conditions are mentioned above in the specifications.

i The manufacturer will have to submit the LM-79, LM-80, L70 and B50 life expectancy performance reports to support the above compliance.

j LEDs should be fitted with wide angle low glare and high transmittance lenses and zero upward light ratios with full cut off beyond 80°.

- k Ambient Operating temperature - 10°C to + 50°C.
- l The system should also be provided with suitable protections against voltage peaks/ surges.
- 4.2 LIGHTING POLES / CONSTRUCTION
- 4.2.1 DECORATIVE LED STREET LIGHT LUMINAIRE
- 4.2.1.1 The quality and performance is expected to be of EN60598-1 CEI 34-21 (European) standards & degree of protection should be according to EN 60529 European standards.
- 4.2.1.2 Street light fitting should Providing Street light pole bracket consisting of" B" Class MS .pipe of 4.2 cms. outside dia. complete with suitable MS sleeve tubing of required size and length suitable for 76.5mm/80mm/require size of pole top having nuts and bolts for fixing the brackets and having spread of 0.5 mtr. Length with 110 deg. with vertical plane and suitable welded stiffener reducer and nipple with check knut complete painted with one coat. of Red oxide / PU base primer and two coats of Aluminum / PU paint. paint The luminaries shall be generally having direct type but low glare considering public promenade.
- 4.2.1.3 Street light pole shall be tropicalised for local conditions as defined in the specifications above and vendor shall guarantee the performance requirements are met as per defined in the tender documents.
- 4.2.1.4 The luminaire housing shall be completely made of pressure die cast aluminum with higher thermal conductivity, corrosion resistant pressure die cast body with suitable epoxy powder coated / PU painted. The color in general shall be Dark Grey / Graphite Black.
- 4.2.1.5 The luminaire complete with LED section, Optics etc shall be dust and Weather proof (Min IP-66) protection as per IEC – 60529.
- 4.2.1.6 The complete assembly along with optics and diffuser shall be Vandal proof; minimum of IK-08 protection is required for post top luminaires. The diffuser shall be made from high quality, UV stabilized and Non-Yellowing Polycarbonate / PMMA.
- 4.2.1.7 The street lightluminaire shall be suitable for direct mounting on pole bracket
- 4.2.1.8 The gasket shall be EPDM or Silicon Rubber Gaskets only; all screws shall be Allen-Key type or requires special tools for opening of the housing / control gear box and shall be of Stainless Steel.
- 4.2.1.10 The base compartment (Control Gear Compartment) shall be provided with wooden back board and enough space to terminate 4 Core 16 Sq. mm Aluminum Armored cable with loop in and loop out multi way connectors strips; 2 A DP MCB along with the Driver fixed on the wooden back board, 2 nos. Earthing Studs etc
- 4.2.1.11 The compartment door shall be secured with tamper resistant special bolts requiring special tools and shall be provided with suitable gasket to comply with IP 66 requirements.
- 4.2.1.12 The pole shall be complete with all mounting accessories, switchgear and connector strips.
- 4.2.1.13 The poles shall conform to the drawings and where such drawing is not available, the contractor shall make such drawing and have it approved before fabricated.
- 4.2.1.14 The poles shall be PU painted; the color of the paint shall match the post top luminaire with 2 coats of epoxy primer applied before painting.
- 4.2.1.15 The luminaire lumen output shall be enough at minimum system wattage so as to cover

wide area.

- 4.2.1.16 The luminaire Color Temperature to be as per datasheet.
- 4.2.1.17 Vendor to submit the detailed calculation for lux level with uniform distribution including the lux distribution curve /graph/spatial distribution with dimension.
- 4.2.1.18 Supplier will be solely responsible for testing and performance compliance of the luminaries after installation and shall also ensure the specified and uniform illumination and comfort level on the horizontal plane at plaza level.

- 4.3 CABLE LAYING (NOT APPLICABLE)
 - 4.3.1 Electric cable for the street lighting installation shall follow specification under the heading “LT XLPE cable”.
 - 4.3.2 Cable shall be terminated in a 4-way terminal block inside the pole or to the attached junction box as shown on drawings.
 - 4.3.3 Cable route shall be as shown on the drawings or the contractor shall mark out the route and lay the cables only upon approval of the route.
 - 4.3.4 Cable laying shall be done with excavation, backfilling of trench with sand & bricks at bottom & top.
- 4.4 EARTHING
 - 4.4.1 All light fixtures and poles shall be earthed as specified under section “EARTHING”.
 - 4.4.2 Earth electrode shall be of 8 SWG coil type and shall otherwise meet to the specification given under heading “Earthing”.

5.0 INSTALLATION OF SYSTEM

Lighting installation shall be carried out as per details shown in the drawing.

The poles shall be erected in perfect plumb with concrete foundation at a location shown in the drawing. The foundation shall be designed to withstand the static load as well as wind velocity and bending moment of the pole and shall be approved by the client prior to execution.

The civil foundation will be provided by Civil Contractor. The Cables will be provided at the foundation; based on the distribution luminaire vendor to install the pole and connect the power and earthing cables.

The luminaries shall also be installed on the pole and be electrically wired to the respective driver at base compartment..

Earthing installation shall follow the details for the same shown in the drawing.

On completion of the installation, the street light poles shall be painted with two coats of metal primer (Red Oxide) followed by two coats of Synthetic enamel of the shade as approved by the Engineer-in-charge.

6.0 DRAWING & INFORMATION

- 6.1 On award of the contract, the contractor shall submit the fully dimensioned general arrangement drawings complete with plan, elevation and sectional views. As built drawing should be submitted indicating cable rout, exact position of light fixtures.
-

7.0

INSPECTION & TESTING

Test certificate should be produced for IR test carried out on all LT cables and panels. All the lamps should be controlled as per required control logic. Operation of timer, contactor circuits should be tested.

Tests are classified as:-

- 7.1 Prototype test
- Type test
- Acceptance test
- Routine rest.

Report of actual Lux level should be submitted.

8.0

METHOD OF MEASUREMENT

- 8.1 Supply, Installation, connection, testing and commissioning of each light fitting with lamp, control gear, earthing etc. shall be considered as one unit for measurement and payment.

Supply, installation, connection, testing and commissioning of each lighting pole, concrete coping/foundation, base plate, junction box/access panel, internal connection from fuse to the light fixture with 2.5 mm.² copper conductor wire, earthing etc. shall be considered as one unit for measurement and payment.

All cabling work shall be measured on the basis of unit length and the cost shall include, cost of cable, excavation, laying, back filling, cable terminations and connection in junction box or pole terminal box etc.

9.0

TEST

- i) Visual and Dimensional Check:

The unit shall be checked visually for all dimensions as per approved design and drawing. General workmanship should be good; all the components properly secured and sharp edges shall be rounded off. Check the marking and quality of the workmanship visually. Check the rating and make of electronic / electrical items.

- ii) Checking of documents of purchase of LED
- iii) Check Document of purchase of LED lamps of approved sources
- iv) Resistance to humidity test

This is carried out by suspending the painted panels in corrosion chamber maintained at 100% RH and temperature cycle of 42 to 48 deg. C for 7 days and examining it for any sign of deterioration and corrosion of metal surface.

- v) Insulation resistance test

The insulation resistance of the unit between earth and current carrying parts shorted together shall not be less than 2 M when measured with 500V megger.

- vi) HV test

Immediately after insulation resistance test, an AC voltage of 1.72 KV RMS (1500 + 2x rated voltage) of sine wave form of 50 Hz shall be applied for one minute between the live parts and frame. There shall not be any kind of break down, flashover or tripping of supply.

- vii) Over voltage protection

The Luminaire shall withstand at 300V AC for two minutes.

- viii) Surge protection

It shall withstand a surge of 1.5kV 3% for 50 microsecond's 20 % at the input terminals for all types. (Tests shall comply with Clause 5.4 of latest IEC 60571-1).

ix) Temperature rise Test:

Temperature rise Test shall be conducted at 180VAC with full load. The temperature rise shall be recorded by temperature detectors mounted at the specified reference points on the body of semiconductors, capacitors and other components as agreed between purchaser and manufacturer. The maximum-recorded temperature under worst conditions shall be corrected to 55°C and compared with maximum permissible temperature (for power devices at junction). Under loading conditions as specified above, the corrected temperature of the power devices shall have a safety margin of minimum 100 C.

Temperature at junction shall not exceed 100 0 C when corrected to 55°C. The Luminaire shall also be subjected for short time rating after continuous loading to ensure the temperature rise is within the permissible limit. The maximum temperature rise of the electronics devices on the PCBs shall be in limit for industrial grade components suitable for 85°C environment.

x) Ra (Colour Rendering Index) measurement test

The lumen is the unit of luminous flux, which is equal to the flux emitted in a solid angle of one Steradian by a uniform point source of one candela.

The initial reading of the chromaticity co-ordinates x & y shall be within 5 SDCM (Standards Deviation for Colour matching) from the standardised rated value as per Annex. D of IEC 60081 - 1997.

The initial reading of the general colour-rendering index (Ra) shall not be less than the rated value decreased by 3.

The lumen maintenance of the lamp shall not be less than 80% of the initial lumen after 20000 burning hours and 70% of the initial lumen after 50000 hours. The initial lumen will be taken after 100 hours aging.

Photometric test shall be conducted as per annexure B of IEC 60081-97.

The lumen maintenance test shall be done as per annexure C of IEC 60081-97.

xi) Lux measurement

Lux measurement with the help of Lux meter shall be done at a distance as shown above. Value obtained shall not be less than the Lux specified in the table therein, considering 10% Lumen is absorbed by the reflector.

xii) Fire retardant Test

Fire Retardant test shall be conducted as per IEC 332-1 of the wire used in the fittings.

xiii) Test for IP66 protection

This test shall be conducted as per IEC

xiv) Environmental tests

The Luminaire shall meet the following tests as prescribed in IEC – 60571.

- a) Dry heat test.
 - b) Damp heat test
 - c) Test in corrosive atmosphere
 - d) Combined dust, humidity and heat test
- xv) Reliability Test

The reliability can only be determined in actual service. However, the following tests shall be carried out on the prototype to simulate as close as possible, the service conditions. There shall be no failure during this test.

- a) The light unit shall be mounted in an oven maintained at 75°C.
-

b) The light will be operated at the specified maximum voltage and at 75°C for a period of 100 hours.

xvi) Life Test

The lumen maintenance & life test shall be done as per annexure C of IEC 60081-97.

xvii) Endurance Test

The Luminaire shall be kept "ON" with input voltage of 250VAC for 200 hours. After this the Luminaire is subjected to 20,000 cycles of "ON" and "OFF", each cycle consisting of 3 seconds "ON" and 10 seconds "OFF" period. Luminaire should survive this test. Test is to be continued for one lakh cycles, followed by Performance test.

xviii) Safety:

The Luminaire shall comply with the safety requirements as per IEC 61195.

9.0 TRANSPORT, DELIVERY & STORAGE

9.1 The prices shall be F.O.R. site basis including packing & forwarding charges. The quoted price must include all the costs for necessary mode of transportation up to the final location or site store. All incidental expenses during transportation shall be part of quoted prices including transit insurance. The charges for loading and unloading of equipments at site should form part of offer.

10.0 GUARANTEE & WARRENTY

10.1 The Bidder shall stand un-conditional guarantee for the performance of entire luminaire equipment and control gear components with LED lamp for 5 years from the date of commissioning

DATASHEET

SR. NO.	PARTICULARS	REQUIRED DATA FROM VENDOR FOR POST TOP LANTERN
1.	Over all Power Consumption	
2.	Power Factor	
3.	Frequency	
4.	Type of LED	
5.	Lumen/LED	
6.	Driver Voltage Range	
	No Load Power Consumption of Driver	
	Full Load Efficiency of Driver	
	Load Regulation of Driver	
	Driver Voltage withstand capacity in hours	
8.	Driver Current (should be variable voltage constant current) (120 Volt AC to 270 Volt AC)	
9.	Type of Heat Sink	
10.	Temperature capacity of Heat Sink	
11.	Protection Class of Lamp Compartment	
12.	Protection Class of Control Gear	
	IK RATING- (IK 08)	
13.	Material Of Fitting	
14.	Material Of Housing	
15.	Material Of Pole	
16.	Luminous Flux (lm)	
17.	Color temperature (K) – 3000k OR 3500k	
18.	Color Rendering Index	
19.	THD in %	
19.	Average life time with a flux maintained at 70% of initial flux.E.g.-L70- X hours- 50,000 hours min.	
20.	Unified Glare Ration(UGR)	
21.	Vendor be a original manufacturer of LED post of lantern worldwide or collaboration and since	
22.	Replacement Guarantee years(min. 5 years)	

SPECIFICATIONS FOR HORIZONTAL OPENWELL SUBMERSIBLE PUMP SET COMPLETE WITH ACCESSORIES

The SITC (Supply, Installation, Testing & Commissioning) of proposed pump sets shall be high discharge completely submersible type water pump of horizontal version and shall be mounted in Under Water Tank. These pump sets shall deal the raw water.

I. SCOPE OF SUPPLY:

- 1) Pump & Motor set
(Pump & Motor set shall be mounted in Under Water Tank and secured with proper clamping arrangement for handling purpose)
- 2) DOL or Star Delta Starter suitable to the pump set
- 3) 50 to 40 mm dia. delivery hose of approximately 40 metres length
- 4) Suitably rated, PVC insulated Flexible copper cables for Power & control applications - Keep the length of the pump set cable such that there is no joint allowed in Under Water Tank.

II. TECHNICAL DETAILS OF PUMP & MOTOR:

S.No	PARAMETER	Details
1.	Nature of liquid to be handled	raw water
2.	Density of liquid to be handled	1.00 Kg/ Cm ³
3.	PH value of the liquid	6 (min)
4.	Maximum size of solids allowed	5 mm
5.	Ambient temperature	50 Degree C. max.
6.	Relative humidity	Upto 100%
7.	Working hours per day	8 hours
8.	Pump shall be able to within the head of	- 25% to + 15% of rated head
9.	Discharge outlet size	50 mm
10.	Service life of bearings shall be	25,000 hours (minimum)
11.	Motor Type	3 Phase totally enclosed type squirrel cage induction Motor
12.	Supply Voltage	415V, +15% / -10%, 3 Ph., 50Hz.
13.	Degree of Protection	IP-68
14.	Duty	S-1 (continuous)
15.	Class of Insulation	'B' Class
16.	Thermistors	-
17.	Moisture Sensor	-
18.	Dry run protection	Shall be provided

-2-

III. RATING OF SUBMERSIBLE PUMP SETS REQUIRED:

S.No.	Head in metres	Discharge in LPM
1	18	276 LPM
2	30	210 LPM
3	36	120 LPM
4		
5		

MATERIAL OF CONSTRUCTION

Impeller : Cast Iron
Motor Body : Cast Iron
Delivery Casing : Cast Iron
Shaft : Stainless Steel

APPLICATIONS

Industrial service water supply schemes.
Domestic and community water supply.
Construction Site.
Irrigation in horticulture & agriculture.
Water supplies for high rise building.

Note: * Marked pumps are ISI certified and ** Marked pumps are star rated. Performance applicable to liquid of specific gravity 1 and Viscosity as of water.

FEATURES

Wide Voltage Design

The motor is designed to withstand wide voltage fluctuations from 200 to 400 volts and reduces motor burning in low voltage.

Flatter Efficiency Curve

Minimum variations in efficiency during entire operating range increases the utility of pump set for variable conditions.

Dynamically balanced rotating parts

Minimum vibrations protect components from damages during the operations, consistent performance as concentricity is maintained

Replaceable Wearing Parts

All wearing parts within the pumps are easily accessible and replaceable which provides ease of maintenance thereby extending the life of the pump.

Easy maintainable designs

Easy maintainable design and better interchangeability of components so that pump can be serviced even at remote locations by semi-skilled technicians.

CED – Cathode Electro Deposition Coating

CED is the latest coating technology for corrosion resistance with uniform coating, provides 5 times more protection over conventional painting, resulting in longer life

High efficiency and energy saving design

Innovative design manufactured at state of art plant, delivers optimum efficiency at lower energy consumption resulting in significant cost savings.

Advanced Water Cooled Motors Designs

The motor is filled with potable water, protects from overheating and facilitates smoother and trouble free operation for the years

Accessories:

Submersible pump set complete with all accessories like portable stand, Cable size according to pump rating and cable length should be such that no joint is made inside the underground water tank. submersible copper cable without joint and 30 Mtr. Long runs required , enclosed with suitable pipe minimum 50 mm dia or next higher size recommend by the pump mfg. with special /fittings /clamps/base plate etc. shall be provided.

Material of construction shall be as below:

- **Pump impeller** : Stainless Steel /Graded Cast Iron & Dynamically balanced.
- **Casing** : High Grade cast iron.
- **Wear Rings** : High quality abrasion resistance Bronze.
- **Shaft** : Stainless Steel of adequate diameter to ensure rigidity and ground to close tolerances.
- **Cable Sealing Arrangement** : Designed so that no bore well water with sand can enter the motor.
- **Motor Body** : Cast Iron /Stainless Steel
- **Journal Bearings** : Leaded Bronze and Stainless Steel, Water Lubricated, having high load bearing capacity.
- **Thrust Bearing** : Carbon Vs Stainless steel and water lubricated to withstand high axial thrust loads.
- **Fasteners**: Stainless Steel
- **Portable Stand (Skirt Base)** :M.S. fabricated & epoxy coated

HANDING OVER DOCUMENTS

The supplier shall submit following:

1. GA drawing
2. Foundation layout
3. Rating and Diagram Plate
4. Data sheet indicating results of tests
5. Test reports
6. O & M manuals

METHOD OF MEASUREMENT

Supply of the D.G Set including transport to site, loading and unloading etc. as specified will be treated as one unit for measurement and payment.

TRANSPORT, DELIVERY & STORAGE

The prices shall be F.O.R. site basis including packing & forwarding charges. The quoted price must include all the costs for necessary mode of transportation up to the final location of PUMP SET or site store. All incidental expenses during transportation shall be part of quoted prices including transit insurance. The charges for loading and unloading of equipments at site should form part of offer(Included).

The transportation for any auxiliary item or detachable part of equipment should be simultaneous and carry necessary instructions for assembling and storage requirements.

All metal surfaces shall be thoroughly cleaned of scale, rust and grease etc. Prior to painting. Cleaned surfaces shall be given two coats of primer and prepared for final painting. Final finish shall be free from all sorts of blemishes.

The equipment shall be shipped to site suitably packed to prevent any damage. Each package shall have labels to show purchaser's name, purchase order and equipment no. suitable lifting lugs etc. shall be provided and lifting points shall be clearly marked on the package. Packing shall be suitable for storage at site for a minimum period of 6 months

GUARANTEE & WARRANTY

The Bidder shall stand guarantee for the performance of entire equipment and components for the period mentioned earlier (min 1 Year) from the date of handover. The Purchaser also reserves the right to use the rejected equipment or part thereof until the new equipment meeting the guaranteed performance is supplied by the Bidder.

[EQ. TO SOR 2012-2013 CAT-III]



TECHNICAL SPECIFICATIONS
FOR
INSTALLATION OF INTERNAL WIRING

TECHNICAL SPECIFICATIONS FOR INSTALLATION OF INTERNAL WIRING

1.0

SCOPE OF WORK

- 1.1 This section covers, definition of point wiring, system of wiring and, installation, connection, testing and commissioning of point wiring for light points, ceiling fan points, exhaust fan points, convenience socket outlet points, power socket outlet points, bell outlet points etc. including fixing of light fixtures, ceiling fan, exhaust fan, wall fan, bell etc.

2.0

CODES & STANDARDS

- 2.1 The following standards and rules shall be applicable :

IS: 732	Code of practice for electrical wiring installation (System voltage not exceeding 650 V)
IS: 1646	Code of practice for fire safety of buildings (General) Electrical installation.
IS: 9537 (Part - 2)	Rigid steel conduits for electrical wiring.
IS: 2667	Fittings for rigid steel conduits for electrical wiring.
IS: 3480	Flexible steel conduits for Electrical wiring.
IS: 3837	Accessories for rigid steel conduit for electrical wiring.
IS: 694	PVC insulated cables.
IS: 9537 (Part - 3)	Rigid non-metallic conduits for electrical wiring.
IS: 6946	Flexible (Pliable) non-metallic conduits for electrical installation.
IS: 1293	3 pin plugs and sockets.
IS: 8130	Specifications of conduits for electrical installation.
IS: 3854	Switches for domestic purpose.
IS: 3419	Fittings for rigid non-metallic conduits.
IS: 4648	Guide for electrical layout in residential buildings Indian electricity act and rules

All standard and codes mean the latest.

3.0

MATERIALS REQUIRED

- 3.1 REFER SUPPLY SPECS

4.0

INSTALLATION OF THE SYSTEM

4.1 CONCEALED INSTALLATION WITH RIGID PVC CONDUIT

- 4.1.1 All the rigid PVC conduit used for concealed installation shall be as per IS ; 9537 and its accessories shall be as per IS: 3419 (Small Wire Ropes).
- 4.1.2 Whenever necessary bends or diversion may be achieved by bending the conduits with the help of bending spring. No other method of bending is allowed
- 4.1.3 Conduit pipes shall be joined with the help of plain coupler fixed at the end with the help of vinyl solvent cement. No other method of joining is permissible
- 4.1.4 All other methods, no wires through conduit, bunching, etc. Shall be as specified in the concealed installation
- 4.1.5 Prior to fixing the conduits, the complete route shall be marked on site for the approval of consultant

4.2 CONCEALED WIRING SYSTEM WITH RIGID PVC CONDUIT

- 4.2.1 The rigid PVC conduits shall be used for concealed wiring system. The conduits shall be concealed in the concrete slab, floor, walls, beams, columns etc
- 4.2.2 FIXING OF CONDUIT

1. Conduits embedded in concrete shall be installed in the frame work before pouring concrete. The conduits shall be installed above the bottom reinforcing bars, and shall provide positive wire fastening of the conduit to the reinforcing rods at an interval of not more than one meter, but on either side of couplers or bends or putlet/pull/junction boxes or similar fittings, proper hold fast shall be fixed at a distance of 30 cm from the center of such fittings. Conduits embedded in the wall shall be fixed inside the chase . The chase in the wall shall be neatly made and be fixed in the manner desired. In the case of building under construction, chase shall be provided in the wall at the time of their construction and shall be filled up neatly with cement mortar 1:4 after erection of conduit and brought to the original finish of the wall. Cutting of horizontal chases in walls is prohibited. The conduits shall be fixed inside the chase by means of staples or by means of saddles not more than 60 cm apart.
2. Conduits shall be so arranged as to facilitate easy drawing of wires through them. Entire conduit layout shall be done in such a way as to avoid additional junction boxes other than light points. The wiring shall be done in a looping manner. All the looping shall be done in either switch boxes or outlet boxes. Looping in junction or pull boxes are strictly not allowed. Where conduits cross building expansion joints, adequate expansion fittings or other approved devices shall be used to take care of any relative movement
3. All conduits shall be installed so as to avoid steam and hot water pipes
4. Conduits shall be installed in such a way that the junction, derivation and pull boxes shall always be accessible for repairs and maintenance work. The location of junction/pull boxes shall be marked on the shop drawings and approved by the client
5. A separation of 200 mm shall be maintained between electrical conduits and hot water lines in the building
6. No run of conduit shall exceed ten mtr. between adjacent draw in points nor shall it contain more than two right angle bends, or other derivation from the straight

line

7. Caution shall be exercised in using the PVC conduits in location where ambient temperature is 50 degree cel. or above. Use of PVC conduits in places where ambient temperature is mote than 60 deg. cel. Is prohibited. The entire conduit system including boxes shall be thoroughly cleaned after completion of installations and before drawing of wires. Conduit system shall be erect and straight as far as possible. Traps where water may accumulate from condensation are to be avoided and if unavoidable, suitable provision for draining the water shall be made
8. All jointing method shall be subject to the approval of the client
9. Separate conduits shall be provided for the following system.
 - 15 A power outlets.
 - 5 A outlets and lighting system.
 - Low voltage system.
 - Telephone/intercom system.
 - C.C.T.V. system
 - Sound system
 - Computer data cabling system
 - Equipment wiring

4.3 CONDUIT JOINT

- 4.3.1
 1. Conduits shall be joined by means of plain couplers vinyl and/or solvent cement. Where there are long runs of straight conduit, inspection type couplers shall be provided at intervals , as approved by the client
 2. The conduits shall be thoroughly cleaned before making the joints
 3. In case of plain coupler joints, proper jointing material like a vinyl solvent cement (gray in color) or any material as recommended by the manufacturer shall be used.

4.4 BENDS IN CONDUIT

- 4.4.1 Wherever necessary, bends or diversions may be achieved by bending the conduits or by employing normal bends. No bends shall have radius less than 2.5 times outside dia. of the conduit
- 4.4.2 Heat may be used to soften the PVC conduit for bending, but while applying heat to conduit, the conduit shall be filled with sand to avoid any damage to the conduit

4.3 OUTLETS

- 4.3.1 All the outlets for fittings, switches etc. shall be boxes of substantial construction
- 4.3.2 In order to minimize condensation or sweating inside the conduits, all outlets of conduit system shall be properly drained and ventilated, but in such a manner as to prevent the entry of insects , etc.

- 4.3.3 Fixing between conduit and boxes, outlet boxes, switch boxes and the like must be provided with entry spouts and smooth PVC bushes.
- 4.3.4 Joints between conduit and any type of boxes shall be affected by means of conduit couplers in to each of which shall be coupled smooth PVC bush from inside the box. In any case all the joints shall be fully water tight.

4.4 BUNCHING OF CABLES

- 4.4.1 Cables of AC supply of different phase shall be bunched in separate conduits
- 4.4.2 The number of insulated wires/ cables that may be drawn into the conduits shall be as per the following table. In this table, the space factor does not exceed 40%. However, in any case conduits having lesser than 19 mm dia. shall not be used.

MAXIMUM PERMISSIBLE NUMBER OF 650 VOLT GRADE SINGLE CORE CABLES THAT MAY BE DRAWN IN TO RIGID PVC CONDUITS.

CABLE SIZE IN MMSQ.	SIZE OF CONDUITS (MM)			
	MAXIMUM NO. OF CABLES			
	25	32	38/40	51/50
1.5	8	15	---	---
2.5	6	10	---	---
4.0	4	8	12	---

4.5 WIRING WITH RIGID STEEL CONDUIT

- 4.5.1 All conduits and it's accessories shall be of threaded type and under no circumstances pin grip type or clamp type accessories be used

4.6 FIXING OF CONDUIT

- 4.6.1 Conduit pipes shall be fixed by heavy gauge spacer bar saddles. The saddles shall be of 3 mm x 19 mm galvanized mild steel flat, properly treated and securely fixed to support by means of nuts and bolts raw bolts, brass machine screws, as mentioned, at an interval of not more than one meter but on either side of couplers, or bends, or junction/pull/outlet boxes or similar fittings, saddles shall be fixed at a distance of 30 cm from the centre of such fittings.
- 4.6.2 Draw boxes shall be located at convenient location for easy drawing of wires
- 4.6.3 Every mains and sub mains shall run in independent conduits with an independent earth wire of specified capacity along the entire length of conduit
- 4.6.4 The conduits to be installed shall be of ample cross section area to facilitate the drawing of wires. The diameter of the conduit shall be selected as per table specified in these specifications. But in no case it shall be less than 25 mm diameter
- 4.6.5 Entire conduit layout shall be done such as to avoid additional junctions boxes other than for outlet points. Conduits shall be free from sharp edge and burrs. Conduits shall be laid in a neat and organized manner as directed and approved by the client. Conduit runs shall be planned so as not to conflict with any other services pipe,

lines/duct

- 4.6.6 The entire conduit system shall be electrically and mechanically continuous and shall be bonded, together by means of approved type earthing clamp and earthed through a bare copper conductor of 14 SWG to the earthing terminals on the nearest distribution board
- 4.6.7 If required, connection between PVC and steel conduits shall be through a junction box. Direct connection between PVC and steel conduits are not allowed
- 4.6.8 Where exposed conduits are suspended from the structure, they shall be clamped firmly and rigidly to hangers of design to be approved by client. Where hangers are to be anchored to reinforced concrete, appropriate inserts and necessary devices for their fixing shall be left in position at the time of concreting, making holes and opening in the concrete will generally not be allowed. In case, it is unavoidable, prior permission of the client shall be obtained

4.7 CONDUIT JOINTS

- 4.7.1 Conduit pipes shall be joined by means of screwed couplers and screwed accessories, as per IS: 2667
- 4.7.2 The threads shall be free from grease or oil
- 4.7.3 In long distanced straight runs of conduit, inspection type couplers two way junction boxes at reasonable intervals shall be provided or running threads with couplers and lock nuts shall be provided. The bare threaded portion shall be treated with anti-corrosive paints. Threads on conduit pipes in all cases shall be between 11mm to 27mm long, sufficient to accommodate pipes to full threaded portion of couplers or accessories. Cut ends of conduit pipes shall have no sharp edges nor any burrs left, to avoid damage to the insulation of conductors while pulling them through such pipes
- 4.7.4 Brass female bushes shall be used in each conduit termination in a switch box, outlet box, electrical panel or any other box
- 4.7.5 Conduit shall be secured in each outlet box switch box, electrical panel or any other ox by means of one brass hexagonal lock nut and bush, outside and inside the box
- 4.7.6 At each building, expansion joints approved oil tight double wire wound flexible steel conduit or any other approved method shall be used. This shall be united on both sides with the rigid conduits by suitable union
- 4.7.7 Conduits installed in the plant room for mechanical equipment shall be properly clamped with the mechanical supports, but in no case, it shall be fixed with the body of the equipment
- 4.7.8 The connection of conduit to the mechanical equipment shall be through oil tight double wire wound flexible steel conduit. In any case the length of the flexible conduit shall not exceed one meter. The flexible conduit shall be properly clamped with the body of the equipment. They shall not in any case be clamped with any cover or any removable parts of the equipment

4.8 BENDS IN CONDUIT

- 4.8.1 All necessary bends in the system including diversion shall be done by bending pipes or by inserting suitable solid or circular inspection type normal box or similar fittings.

Conduit fittings shall be avoided as far as possible on conduit system exposed to weather, where necessary, solid type fittings shall be used. Radius of such bends in conduit pipes shall be not less than 75 mm. No length of conduit shall have more than the equivalent of four quarter bends from outlet, the bends at the outlets not being counted

4.9 PROTECTION AGAINST DAMPNES

4.9.1 In order to minimize condensation or sweating inside the conduit, all outlets of conduit system shall be properly drained and ventilated, but in such a manner as to prevent the entry of insects, as far as possible

4.10 PROTECTION OF CONDUIT AGAINST RUST

4.10.1 The outer surface of the conduits including bends, junction boxes, etc., forming part of the conduit system shall be adequately protected against rust, particularly when such system is exposed to weather. In all cases, no bare/threaded portion of conduit pipe shall be allowed unless such bare threaded portion is treated with anti-corrosive coating or covered with approved plastic compound

4.11 BUNCHING OF CABLES

4.11.1 Unless otherwise specified, insulated conductors of different phases shall be bunched in separate conduit.

Wires carrying current shall be so bunched in the conduit that the out going and return wires are drawn into the same conduit. Wires originating from two different phases shall not be run in the same conduit

4.11.2 The number of insulated wires/cables that be drawn into the conduits shall be as per the following table.

MAXIMUM PERMISSIBLE NUMBER OF 650/1100 VOLTS GRADE SINGLE CORE CABLE THAT CAN BE DRAWN INTO RIGID STEEL CONDUITS.

CABLE SIZE IN MM SQ.	SIZE OF CONDUITS (MM)			
	MAXIMUM NO. OF CABLES			
	25	32	38	51
1.5	10	14	---	---
2.5	8	12	---	---
4.0	6	10	---	---

4.12 SWITCH AND SOCKET

4.12.1 Switches shall be installed at 900 mm above finished floor level unless otherwise indicated on the drawings

4.12.2 The switch controlling the light point or fan shall be connected on to the phase wire of the circuit and neutral shall be continuous, having no fuse or switch installed in the line except at the D.B. All fan regulators shall be fixed inside the switch boxes on adjustable flat M.S. strips/plates with tapped holes and brass machine screws, leaving

ample space at the back and side for accommodating wires

- 4.12.3 The cover plates to the switch box shall be fixed by means of sunk head brass cadmium screws
- 4.12.4 Where two or more switches and fan regulators are installed together, they shall be provided with one gang cover plate with knockouts to accommodate required number of switches, sockets and regulators
- 4.12.5 The switch controlling the socket outlet shall be on the phase wire of the circuit. The third pin of the socket shall be connected to the earth continuity conductor of the circuit
- 4.12.6 The switch boxes, installed back-to-back in the same wall shall be offset from each other, 150 mm horizontally, to preclude noise transmission

4.13 DRAWING OF CONDUCTORS

- 4.13.1 The drawing and joining of copper conductor or wires shall be executed with due regard to the following precautions. While drawing insulated wires into the conduits, care shall be taken to avoid scratches and kinks which may cause breakage of conductors. There shall be no sharp bends
- 4.13.2 Insulation shall be shaved off for a length of 15 mm at the end of wire like sharpening of a pencil and it shall not be removed by cutting it square or ringing
- 4.13.3 FRLS insulated copper conductor wire ends before connection shall be properly soldered (at least 15 mm length) with soldering flux/copper solder, for copper conductor. Strands of wires shall not be cut for connecting to the terminals. All strands of wires shall be soldered at the terminals. All strands of wires shall be soldered at the end before connection. The connecting brass-screws shall have flat ends. All looped joints shall be soldered and connected through terminals block/connectors. The pressure applied to tighten terminal screws shall be just adequate, neither too much nor too less. Conductors having nominal cross section exceeding 4 sq. mm shall always be provided with crimping type cable sockets. At all bolted terminals, brass flat washer of large area and approved steel spring washers shall be used. Brass nuts and bolts shall be used for all connections
- 4.13.4 Only certified wire men and cable jointers shall be employed to do joining work
- 4.13.5 For all internal wiring FRLS insulated wires of 650/1100 volts grade shall be used. The sub-circuit wiring for point shall be carried out in looping system and no joint shall be allowed in the length of the conductors. No wire shall be drawn in to any conduit, until all work of any nature that may cause injury to wire is completed. Care shall be taken in pulling the wires so that no damage occurs to the insulation of the wire. Before the wires are drawn into the conduits the conduits shall be thoroughly cleaned of moisture, dust, and dirt or any other obstruction by forcing compressed air through the conduits

4.14 JOINTS

- 4.14.1 The wiring shall be by looping back system, and hence all joints shall be made at main switches, distribution boards, socket outlets, lighting outlets and switch boxes only. No joints shall be made inside conduits and junction boxes.
- 4.14.2 Contractors shall be continuous from outlet to outlet. For joints where unavoidable,

due to any specified reasons, prior permission in writing shall be obtained from the client before making such connections. Joints by twisting conductors are prohibited.

4.15 LOADBALANCING

4.15.1 Balancing of circuit in three phase installation shall be planned before the commencement of wiring and shall be strictly adhered to

4.16 EARTHING

4.16.1 All earthing systems shall be in accordance with IS: 3043 - 1985 code of practice for earthing

LED LIGHT SPECIFICATIONS

SUPPLY, LAYING, TESTING AND CONNECTING UNARMoured CABLE:

The item includes supply, laying, testing and commissioning of round 3 X 1.5 sq. mm for LED luminaries flexible unarmoured single PVC insulated copper conductor cable 1100 V grade to be laid through the pole from luminaries to junction box by experienced technician without any damage. The cable joint shall not be allowed. Termination glands/lugs etc shall be included in the item.

SITC OF LED LIGHT LUMINAIRES:-

TECHNICAL SPECIFICATION FOR ENERGY EFFICIENT LED BASED LUMINAIRE UNIT FOR LED LIGHT: -

This specification is for technical and general requirements design, development, manufacturing, testing and supply of energy efficient LED luminaire complete with all accessories, LED lamps with suitable current control driver circuit and required optics including mounting arrangement.

CODES & STANDARDS: -

IEC 60529 Classification of degree of protections provided by enclosures (IP Codes)
EN 55015, CISPR15 Limits and methods of measurement of radio disturbance characteristic of electrical lighting and similar equipment.
IEC 62031 LED modules for general lighting-Safety requirements
IEC 61547-EMC Immunity requirement
IEC 60598-2-1 Fixed general purpose luminaries
IEC 60598-1 Luminaries - General requirement and tests
IEC 61000-3-2 Electro Magnetic compatibility (EMC)- Limits for Harmonic current emission -- (equipment input current ≤ 16 A per phase.
IEC 60068-2-38 Environmental Testing: Test Z- AD: composite temperature/humidity cyclic test
IEC 61347-2-13 Lamp control gear: particular requirements for DC or AC supplied electronic control gear for LED modules.
IS 10322 Specification for the luminaries
IS 4905 Method for random sampling
LM 79 LED luminaire photometry measurement.
LM 80 Lumen Maintenance
IEC 62384 DC or AC supplied electronic control gear for LED modules performance requirements
IEC/ PAS 62612 Self-ballasted LED lamps for general lighting services- Performance requirements

CONSTRUCTIONAL FEATURES:

General:

- a) Luminaries shall be made of die cast aluminium/ extruded Aluminium body with powder coated finish having safety.
- b) Heat sink used should be aluminium extrusion having high conductivity. Heat sink should be integrated within luminaries and efforts shall be made to keep the overall outer dimensions
- c) optimum such that it permits sufficient heat dissipation through the body itself so as to prevent abnormal temperature inside the luminaries and consequential damage to cover, gasket material, LEDs, lenses and drivers.
- d) LED must be mounted on Metal core PCB with suitable large area surface by means of fins to dissipate the conduct heat. The fins must be exposed to ambient flowing air.
- e) All luminaries shall be provided with toughened glass of min. 0.8 mm thickness of sufficient strength. UV stabilized Poly carbonate material is also acceptable. High efficiency prismatic diffuser/Lens under the LED chamber to protect the LED and luminaries shall be provided.
- f) The minimum IK protection of optic cover shall be IK 05. The test material certificate shall be provided.
- g) Suitable number of LED lamps shall be used in the luminaries. The manufacturer shall submit the proof of procurement of LEDs from OEMs at the time of testing.
- h) Suitable reflector/ lenses may also be provided to increase the illumination uniformity and distribution.
- i) The electrical component of the LED and LED driver must be suitably enclosed in sealed unit to function in environment conditions mentioned earlier.
- j) The connecting wires used inside the luminaries, shall be low smoke halogen free, fire retardant e-beam cable and fuse protection shall be provided in input side.
- k) Design of the thermal management shall be done in such a way that it shall not affect the properties of the diffuser.
- l) The equipment should be compliant to IEC 60598-1, IEC 62031 and IEC/PAS 62612 depending on the type of luminary.
- m) The LED Module(s), Driver gear, etc. shall be designed in such a way so that temperature of heat sink shall not exceed 70° C.
- n) All the material used in the luminaries shall be halogen free and fire retardant confirming to standard.
- o) The infrastructure for Quality Assurance facilities to verify/ test/ prove above specifications must be available at the manufacturing facility. The compliance shall be indicated clearly in the tender itself.
- p) All fasteners must be of stainless steel.
- q) All glands inside/ outside luminaries must be metallic
- r) Heat sink must be thermally connected to MCPCB/ LED light source.

High power and high lumen efficient LEDs suitable for following features shall be used:

- a) The working life of the lamp at junction temperature of 85° C (max) at operating current shall be more than 50,000 working hours of accumulative operation and shall be suitable for continuous operation of 24 hours per day. These features shall be supported with datasheet.
- b) Adequate heat sink with proper thermal management shall be provided.
- c) Lumen maintenance report as per LM 80 guidelines shall be produced for the power LEDs used.
- d) Thermal management shall be in such a way that LED soldering point temperature shall not go beyond 75° C.
- e) The LED luminaries shall be free of glare.

LED DRIVER specification:

- a) Current waveform should meet relevant nation and international standard.
- b) LED Driver shall withstand, withstand voltage up to level mentioned elsewhere in tender and restore once normal working when normal voltage is applied.
- c) The life of the driver should more than 25000 Hrs.
- d) Maximum Temperature rise $\leq 30^{\circ} \text{C}$ @ 45°C T_{amb} . With safety margin of 10°C .
- e) The control gear should be compliant to IEC 61347-2-13, IEC 62031 and IEC 62384 as per the requirements.
- f) The driver of the luminaries should have Short Circuit, Over Voltage, over current, over temperature, Under Voltage, String Open protections.

The electronic components used shall be as follows:-

- a) The protective cum adhesive coating used on PCBs should be cleared and transparent and should not affect colour code of electronic components or the product code of the company.
- b) The construction of PCBs and the assembly for components for PCBs should be as per IS standards.

Illumination Level:

The luminaries shall be so designed that the illumination level shall be evenly distributed and shall be free from glare. The lux distribution curve/ graph/ spatial distribution shall be submitted.

GENERAL DATA SHEET

Sr. No.	Parameter	Value/Detail
•	Rated Supply Voltage	230 V ~, 50 Hz
•	Input supply voltage range	120-270 V
•	Expected Input Frequency	50 Hz +/- 3%

•	Working Temperature	+5° to +50° C
•	Working Humidity	10% - 90% RH
•	Usage hours	Dusk to dawn
•	Power Factor	≥0.90
•	Index of Protection Level	IP 66 as per IEC 60529.
•	Surge Protection	4 KV
•	LED Chip efficacy	≥ 120 lm/ W
•	Driver Efficiency	> 85%
•	Junction Temperature of LED	< 85° C
•	Rated Life @ L70	50,000 burning hours at 35° C ambient
•	Nominal Correlated Colour Temperature	5000° K to 6000° K
•	Dispersion Angle	Minimum 120°
•	Tilting angle	Adjustable
•	Maintenance factor of	0.85
•	Colour Rendering Index	≥75
•	Total Harmonic Distortion	< 10 % (EMI/ EMC Certification)
•	LED MAKE	Cree/ Osram/ Nichia/ Philips Lumileds

Particulars and Details to be submitted by the bidder:

In order to properly assess and due diligence on submissions, the Bidder should provide following information on the quality and photometric of proposed luminaries.

1. General Description

Following details of the proposed luminary shall be submitted

2. Electrical specifications

Electrical ratings of the proposed luminary product shall be submitted

3. LED chip and driver information

LED chip and driver information of the proposed luminary product shall be submitted

4. Photometric information to be submitted

TESTS & CERTIFICATES:

Tests are classified as:–

Type test

Acceptance test

Routine rest.

The luminaries' should be tested as per IEC 60598-2-3: 2002 standards and following test reports should be submitted: -

- (i) Heat Resistance Test
- (ii) Thermal In SITU Test
- (iii) Ingress Protection Test
- (iv) Drop Test
- (v) Electrical/ Insulation Resistance Test,
- (vi) Endurance Test,
- (vii) Humidity Test,
- (viii) Electrical and Photometric Measurements Test Report (IES LM 79)
- (ix) LED Lumen Maintenance Test Report (IES LM 80)
- (x) Vibration test as per ANSI

Type Test: -

Type test certificates for both the luminaries' shall be provided with the technical-bid.

Acceptance Tests: -

These tests are carried out by an inspecting authority at the supplier's premises on sample taken from a lot for the purpose of acceptance of a lot. Acceptance tests shall not be carried out from particular size from the lot on which type tests have already been conducted. Recommended sampling plan is given below.

Sample size and criteria for conformity

The luminaries shall be selected from the lot at random. In order to ensure randomness of selection, procedures given in IS 4905-1968 (Reaffirmed 2001) may be followed.

Routine Tests:

These tests shall be performed by the manufacturer on each complete unit of the same type and the results shall be submitted to the inspecting agency, prior to offering the lot for acceptance test. The firm shall maintain the records with traceability.

Test Scheme & Quality Assurance

Method of Testing: -

Visual and Dimensional Check:

The unit shall be checked visually for all dimensions as per approved design and drawing.

General workmanship should be good; all the components properly secured and sharp edges shall be rounded off. Check the marking and quality of the workmanship visually. Check the rating and make of electronic/ electrical items.

Checking of documents of purchase of LED

Check Document of purchase of LED lamps of approved sources viz. NICHIA/ OSRAM/ PHILIPS LUMILEDS/ CREE.

Resistance to humidity test

This is carried out by suspending the painted panels in corrosion chamber maintained at 100% RH and temperature cycle of 42 to 48° C for 7 days and examining it for any sign of deterioration and corrosion of metal surface.

Insulation resistance test

The insulation resistance of the unit between earth and current carrying parts shorted together shall not be less than 2 MΩ when measured with 500 V megger.

HV test

Immediately after insulation resistance test, an AC voltage of 1.72 KV rms (1500 + 2 x rated voltage) of sine wave form of 50 Hz shall be applied for one minute between the live parts and frame. There shall not be any kind of break down, flashover or tripping of supply.

Over voltage protection

The LED Driver Shall be cut off once voltage exceeds 288 V AC. It shall be reconnected when supply comes within limit.

Surge protection

It shall withstand a surge of 4 KV at the input terminals for all types.

Reverse polarity

The Luminaries' shall withstand polarity reversal. It shall be operated with reverse voltage for Min. 1 minute at maximum value of voltage range. At the end of this period, the supply shall be made correct polarity and Luminary shall operate in a normal way.

Temperature rise Test:

Temperature rise Test shall be conducted at 100 V ~ with full load. The temperature rise shall be recorded by temperature detectors mounted at the specified reference points on the body of semiconductors, capacitors and other components as agreed between purchaser and manufacturer. The maximum-recorded temperature under worst conditions shall be corrected to 55° C and compared with maximum permissible temperature (for power devices at junction). Under loading conditions as specified above, the corrected temperature of the power devices shall have a safety margin of minimum 10° C.

Temperature at junction shall not exceed 100° C when corrected to 55° C. The Luminaries' shall also be subjected for short time rating after continuous loading to

ensure the temperature rise is within the permissible limit. The maximum temperature rise of the electronics devices on the PCBs shall be in limit for industrial grade components suitable for 85° C environment. In case of exceeding limit, use of MIL-grade component shall be considered keeping RDSO informed.

Ra (Colour Rendering Index) measurement test

The lumen is the unit of luminous flux, which is equal to the flux emitted in a solid angle of one steradian by a uniform point source of one candela.

The initial reading of the chromaticity co-ordinates x & y shall be within 5 SDCM (Standards Deviation for Colour matching) from the standardised rated value as per Annex: D of IEC 60081- 1997.

The initial reading of the general colour-rendering index (Ra) shall not be less than the rated value decreased by 3.

The lumen maintenance of the lamp shall not be less than 80% of the initial lumen after 20,000 burning hours and 70% of the initial lumen after 50,000 hours. The initial lumen will be taken after 100 hours aging.

Photometric test shall be conducted as per Annexure: B of IEC 60081-97.

The lumen maintenance test shall be done as per Annexure: C of IEC 60081-97.

Fire retardant Test

Fire Retardant test shall be conducted as per IEC 60332-1 of the wire used in the luminaries.

Test for IP 65 protection

This test shall be conducted as per IEC 60529.

Environmental tests (Proto type Test)

The Luminary shall meet the following tests as prescribed in IEC-60571.

- (i) Dry heat test.
- (ii) Damp heat test
- (iii) Test in corrosive atmosphere
- (iv) Combined dust, humidity and heat test

Reliability Test

The reliability can only be determined in actual service. However, the following tests shall be carried out on the prototype to simulate as close as possible, the service conditions.

There shall be no failure during this test.

- (i) The light unit shall be mounted in an oven maintained at 45° C.

(ii) The light will be operated at the specified maximum voltage and at 45° C for a period of 100 hours.

Photometry Test: -

The test shall be carried out for Total Luminous Flux, Luminous Intensity Distribution, Electrical Power, Luminous Efficacy (calculation), Color Characteristics– Chromaticity, CCT & CRI etc. as per IES LM 79.

Life Test

The lumen maintenance & life test shall be done as per IES LM 80 for LEDs.

Endurance Test

The Luminaire shall be kept “ON” with input voltage of 250 V ~ for 200 hours. After this the Luminaire is subjected to 20,000 cycles of “ON” and “OFF”, each cycle consisting of 3 seconds “ON” and 10 seconds “OFF” period. Luminaire should survive this test. Test is to be continued for 20,000 cycles, followed by performance test.

Safety:

The Luminaire shall comply with the safety requirements as per IEC 61195.

All Tests defined for acceptance other than LM 79 and LM 80 are allowed to carry out at Manufacturer works.

4. INFRINGEMENT OF PATENT RIGHTS

Client shall not be responsible for infringement of patent rights arising due to similarity in design, manufacturing process, use of the components, used in design, development and manufacturing of these light luminaires and any other factor which may cause such dispute. The responsibility to settle any issue rises with the manufacturer.

5. MARKING:

The following information shall be distinctly and indelibly marked on the housing:

Year of manufacture/ Batch Number/ Serial Number
Name of Manufacturer (Engraving only, stickers not allowed)
Rated watt and voltage
Input frequency

6. METHOD OF MEASUREMENT

Supply of the fixture including transport to site, loading and unloading etc. as specified will be treated as one unit for measurement and payment.

7. TRANSPORT, DELIVERY AND STORAGE

The prices shall be F.O.R. site basis including packing & forwarding charges. The quoted price must include all the costs for necessary mode of transportation up to the final location of fixture or site store. The fixture should be supplied with required storage arrangements suitable for placing in open storage yard. All incidental expenses during transportation shall be part of quoted prices including transit insurance. The charges for loading and unloading of equipments at site should form part of offer.

8. GUARANTEE AND WARRENTY

The Bidder shall stand guarantee for the performance of entire fixtures and components for twenty four (24) months from the date of commissioning or from issuance date of completion certificate, whichever is earlier, as agreed up on and as reproduced in the purchase order within the tolerance specified or as permitted by the relevant standards for the equipment in his scope of supply. The Purchaser also reserves the right to use the rejected equipment or part thereof until the new equipment meeting the guaranteed performance is supplied by the Bidder.

9. SPARES

The bidder shall quote for minimum spares required for two years safe operation of light fixtures along with the offer separately.

[EQ. TO SOR 2012-2013 CAT-III]

2. TECHNICAL SPECIFICATIONS
FOR
INSTALLATION OF LIGHTING DB's

TECHNICAL SPECIFICATIONS FOR INSTALLATION OF LIGHTING DBs

1.0 SCOPE

- 1.1 This section relates to specifications for installation, connection, testing and commissioning of lighting distribution board (LDB) using TPN/FP/DP/SP MCB isolator & ELMCB, Earthing terminal, connector strip for phase neutral and earth for each circuit, CRCA sheet steel housing and complete the item installation. Common banking of neutral and earth conductor is not allowed.

2.0 CODES & STANDARDS

- 2.1 Refer Supply specs

3.0 MATERIALS REQUIRED

- 3.1 Refer Supply specs

4.0 INSTALLATION OF SYSTEM

- 4.1 The DB's shall be assembled and aligned together and be installed at site as per installation manual/instruction of the DB manufacturer.
- 4.2 The DB shall be installed in surface manner at the various location.
- 4.3 All minor electrical and mechanical work required to be attended to on the DB shall be completed in an approved manner after installation but before energizing the DB's.
- 4.4 The M.S. angle/channel iron frame used for installation of D.B. shall be hot dip galvanized (816 g/m²).
- 4.5 The DB shall be mounted on angle/channel frame with Anchor fastening only. Civil grouting is not acceptable.

5.0 EARTHING INSTALLATION

- 5.1 Refer Earthing Specs

6.0 INSPECTION & TESTING

- 6.1 Prior to commissioning of the DB's following tests shall be carried out.
- 6.1.1 Mechanical endurance test shall be carried out by closing and opening of all the MCB's, switches etc.
- 6.1.2 Insulation resistance test shall be carried out between phases and between phase to earth bus, keeping the isolating switch in open position. Similar test shall be carried out keeping the isolating switch in closed position.
- All the interlocks, controls and tripping mechanism of the switch gears shall be tested for their proper functioning.

[EQ. TO SOR 2012-2013 CAT-III]

12. TECHNICAL
SPECIFICATIONS FOR
MEDIUM VOLTAGE PANEL

TECHNICAL SPECIFICATIONS FOR MEDIUM VOLTAGE PANEL

1.0 SCOPE OF WORK

- 1.1 This scope shall cover design, manufacture, check test, and supply of medium and low voltage motor/power control Panel boards, MCB distribution boards etc. as described in this specification, as per drawings and schedule of quantities.

2.0 CODES & STANDARDS

- 2.1 The Panels shall comply with the latest edition of relevant Indian Standards and Indian Electricity Rules and Regulations. The following Indian standards shall be complied with:

Sr.	Item	Relevant IS	Relevant IEC
1	General requirements for switchgear and control gear for voltages not exceeding 1000 V AC or 1200 V DC	IS: 4237	
2	Switchgear bus bars, main connection and auxiliary wiring, marking and arrangement.	IS: 375	
3	Degree of protection provided by enclosures for Low voltage switch gear and control gear.	IS: 2147	
4	Terminal marking for electrical measuring instrument and their accessories.	IS: 8197	
5	Danger notice plates	IS: 2551	
6	Code of Practice for selection, installation and maintenance of switchgear and control gear.	IS: 10118	
7	Specification for factory built assemblies of switchgear and control gear for voltage up to and including 1000 V AC and 1200 V D.C.	IS: 8623	
8	Miniature circuit breakers.	IS: 8828	
9	Current transformers	IS: 2705	
10	Voltage transformer	IS: 3155	
11	Electrical relay for protection	IS: 3231	
12	Indicating instruments	IS: 1248	
13	Integrating instruments	IS: 722	
14	Control switches and push buttons	IS: 6875	
15	AC motor starters of voltage not exceeding 1000 V	IS: 1822	

The Panels also require approval of the client/consultant at various stage of their manufacture such as design, selection, construction, testing, shipping etc.

3.0

DESIGN BASIS & SITE CONDITIONS

Site conditions		
Location Gujarat		Site altitude 81M above mean sea level
Ambient temperature		Relative humidity
Maximum 45 ° C	Maximum 85 %	
Minimum 13 ° C	Minimum 25 %	
Design 50 ° C	Design 90 % at 50 ° C	
Seismic factor Zone III as per IS:1893		Rainfall 618mm/year
Environmental Tropical conditions		Location of Equipment Indoor
Electrical system data:		
Power supply for Equipment		
Voltage 415 kV ± 5 %		Frequency 50 Hz ± 3 %
Permissible voltage & variation	combined frequency ± 6 %	System design level (Symmetrical) 15 kA for 1 sec. max.
System earthing LV side neutral solidly earthed		Wiring 3 phase, 4 wire on 415V system
Auxiliary power supply :-----		
Power supply		240V AC, 1-Ph, 50Hz
Control Supply		-----
Space heater power supply		240V AC, 1-Ph, 50Hz
Illumination power supply		240V AC, 1-Ph, 50Hz
Plug-socket power supply		240V AC, 1-Ph, 50Hz

4.0

TECHNICAL REQUIREMENTS

All the Panels shall be metal clad, totally enclosed, rigid, floor mounting, air insulated, cubicle type suitable for operation on three phase/single phase, 415 V/240 V, 50 Hz., neutral effectively grounded at transformer and short circuit level as mentioned in the drawings.

All the outdoor panel shall be double door type with IP54 protection class construction.

All the indoor panel shall have IP51 protection class construction.

The painting of all the metal part shall be as per the painting specification defined in the datasheet.

The Panels shall be designed to withstand heaviest condition at site, with maximum expected ambient temperature of 45°C, 90% humidity and salty, dusty weather.

CUBICAL TYPE PANELS:

4.1 STRUCTURE

4.1.1 The Panels shall be metal clad enclosed and be fabricated out of high quality CRCA sheet, suitable for indoor installation having dead front operated and floor mounting type.

4.1.2 All CRCA sheet steel used in the construction of Panels shall be 2 mm. thick and shall be folded and braced as necessary to provide a rigid support for all components. Joints of any kind in sheet steel shall be seam welded, all welding slag grounded off and welding pits wiped smooth with plumber metal.

- 4.1.3 The Panels shall be totally enclosed, completely dust and vermin proof and degree of protection being not less than IP: 51. Gaskets between all adjacent units and beneath all covers shall be provided to render the joints dust proof. All doors and covers shall be fully gasketed with foam rubber and/or rubber strips and shall be lockable.
- 4.1.4 All panels and covers shall be properly fitted and secured with the frame and holds in the panel correctly positioned. Fixing screws shall enter into holes, taped into an adequate thickness of metal or provided with bolts and nuts. Self-threading screws shall not be used in the construction of Panels.
- 4.1.5 A base channel of 100 mm. x 50 mm. shall be provided at the bottom. A clearance of 300 mm. between the floor of the Panels and the bottom of the lower most units shall be provided.
- 4.1.6 Panels shall be preferably arranged in multi-tier formation. The Panels shall be of adequate size with a provision of 20% spare space to accommodate possible future additional switchgear. The size of the Panels shall be designed in such a way that the internal space is sufficient for hot air movement and the electrical component does not attain temperature more than 45^oc. The entire electrical component shall be derated for 50^oc. The ratings indicated in the drawing are derated for 50^oc.
- 4.1.7 Knock out holes of appropriate size and number shall be provided in the Panels in conformity with the number, and the size of incoming and outgoing conduits/cables.
- 4.1.8 Alternately, the Panels shall be provided with removable sheet steel plates at top and bottom to drill holes for cable/conduit entry at site.
- 4.1.9 The Panels shall be designed to facilitate easy inspection, maintenance and repair.
- 4.1.10 The Panels shall be sufficiently rigid to support the equipment without distortion under normal and under short circuit condition. They shall be suitably braced for short circuit duty.
- 4.2 PROTECTION CLASS:
- 4.2.1 All the indoor Panels shall have protection class of IP 51 for indoor installation and IP 54 for outdoor installation.
- 4.3. PAINTING:
- 4.3.1 The painting shall be with 2 coats of epoxy primer along with two coats of PU paint [Anti-corrosive paint]. Paint shade shall be confirmed with the client.
- 4.4 CIRCUIT COMPARTMENTS:
- 4.4.1 Each circuit breaker and switch fuse unit shall be housed in separate compartments and shall be enclosed on all sides. Sheet steel hinged lockable door shall be duly interlocked with the breaker/switch fuse unit in 'ON' and 'OFF' position. Safety interlocks shall be provided for air circuit breaker to prevent the breaker from being drawn out when the breaker is in 'ON' position.
- 4.4.2 The door shall not form an integral part of draw out position of the circuit breaker. All instruments and indicating lamp shall be mounted on the compartment door. Sheet steel barriers shall be provided between the tiers in a vertical section.
- 4.5 INSTRUMENT COMPARTMENTS:
- 4.5.1 Separate adequate compartment shall be provided for accommodating instruments, indicating lamps, control contactors/relays and control fuses etc. These components shall be accessible for testing and maintenance without any danger of accidental contact with live parts of the circuit breaker/switch fuse unit, busbar and connections.

4.6 BUS-BARS:

- 4.6.1 The busbar shall be air insulated and made of high quality, high conductivity, high strength Aluminum.
- 4.6.2 The busbar shall be of 3 phases and neutral system with separate neutral and earth bar. The bus bar and interconnection between bus bars and various components shall be of high conductivity Aluminum. The busbar shall be of rectangular cross-section designed to withstand full load current for phase bus bars and half rated current for neutral bus bars and shall be extensible on either side. The busbar size shall be as per drawing. The busbar shall have uniform cross-section throughout the length.
- 4.6.3 The bus bars and interconnections shall be insulated with heat shrinkable PVC sleeve and be colour coded in red, yellow, blue and black to identify the 3 phases and neutral of the system if specified in datasheet. The busbar shall be supported on unbreakable, non-hydrscopic SMC/DMC insulated supports at sufficiently close intervals to prevent bus bars sag and shall effectively withstand electromagnetic stresses in the event of short circuit capacity of 15 KA RMS symmetrical for 1 sec. and a peak short circuit withstand of 31.5 KA minimum.
- 4.6.4 The bus bar shall be housed in a separate compartment. The bus bar shall be isolated with 3 mm. thick Bakelite sheet to avoid any accidental contact. The bus bar shall be arranged such that minimum clearance between the bus bars to be maintained as below:
- | | | |
|----------------------------|---|----------------|
| Between phases | : | 25 mm. minimum |
| Between phases and neutral | : | 25 mm. |
| Between phases and earth | : | 25 mm. |
| Between neutral and earth | : | 20 mm. minimum |
- 4.6.5 All bus bar connections shall be done by drilling holes in bus bars and connecting by chromium plated or tinned plated brass bolts and nuts. Additional cross-section of bus bar shall be provided in all Panels to cover up the holes drilled in the bus bar. Spring and flat washers shall be used for tightening the bolts.
- 4.6.6 All connections between bus bars and circuit breakers/switches and cable terminals shall be through aluminum strips of proper size to carry full rated current. These strips shall be insulated with insulating tapes.

4.7 ELECTRICAL POWER AND CONTROL WIRING CONNECTION:

- 4.7.1 Terminal for both incoming and outgoing cable connections shall be suitable for 1100 V grade, aluminum/copper conductor PVC insulated and sheathed, armoured cable and shall be suitable for connections of solder-less sockets for the cable size as indicated on the appended drawings for the Panels.
- 4.7.2 Power connections for incoming feeders of the main Panels shall be suitable for 1100 V grade aluminum conductor (LT XLPE) cables.
- 4.7.3 Both control and power wiring shall be brought out in cable alley for ease of external connections, operation and maintenance.
- 4.7.4 Both control and power terminals shall be properly shrouded.
- 4.7.5 10% spare terminals shall be provided on each terminal block. Sufficient terminals shall be provided on each terminal block, so that not more than one outgoing wire is connected per terminal.
- 4.7.6 Terminal strips for power and control shall preferably be separated from each other by suitable barriers of enclosures.

- 4.7.7 Wiring inside the modules for power, control, protection and instruments etc. shall be done with use of 660/1100 V grade, PVC insulated copper conductor cables conforming to IS: 694 and IS: 8130. Power wiring inside the starter module shall be rated for full current rating of respective contactor, but not less than 4.0 sq.mm. cross-section area. For current transformer circuits, 2.5 sq.mm. copper conductor wire shall be used. Other control wiring shall be done with 1.5 sq.mm. copper conductor wires. Wires for connections to the door shall be flexible. All conductors shall be crimped with solderless sockets at the ends before connections are made to the terminals.
- 4.7.8 Control power for the Motor starter module shall be taken from the respective module switchgear outgoing. Control power wiring shall have control fuses, (HRC fuse type) for circuit protection. All indicating lamps shall be protected by HRC fuses.
- 4.7.9 Particular care shall be taken to ensure that the layout of wiring is neat and orderly. Identification ferrules shall be fitted to all the wire termination for ease of identification and to facilitate checking and testing.
- 4.7.10 Spring type washers shall be used for all copper and aluminium connections.
- 4.7.11 Final wiring diagram of the Panels power and control circuit with ferrules numbers shall be submitted along with the Panels as one of the documents against the contract.
- 4.8 TERMINALS:
- 4.8.1 The outgoing terminals and neutral link shall be brought out to a cable alley suitably located and accessible from the panel front. The current transformers for instruments metering shall be mounted on the disconnecting type terminal blocks. No direct connection of incoming or outgoing cables to internal components of the distribution board is permitted; only one conductor may be connected in one terminal.
- 4.9 WIRE-WAYS:
- 4.9.1 A horizontal PVC wire way with screwed covers shall be provided at the top to take interconnecting control wiring between different vertical sections.
- 4.10 CABLE COMPARTMENTS:
- 4.10.1 Cable compartments of adequate size shall be provided in the Panels for easy termination of all incoming and outgoing cables entering from bottom or top. Adequate supports shall be provided in the cable compartments to support cables. All outgoing and incoming feeder terminals shall be brought out to terminal blocks in the cable compartment.
- 4.11 EARTHING:
- 4.11.1 Copper earth bus of 40 X 6 mm shall be provided in the Panels for the entire length of the panel. The frame work of the Panels shall be connected to this earth bar. Provisions shall be made for connection from this earth bar on both sides of the panels to the main earthing bar coming from the earth pit. Door earthing shall be provided for all the compartments.
- 4.11.2 The earth continuity conductor of each incoming and outgoing feeder shall be connected to this earth bar. The armour shall be properly connected with earthing clamp, and the clamp shall be made for connection from this earth pit on both sides of the Panels.
- 4.11.3 The earth continuity conductor of each incoming and outgoing feeder shall be connected to this earth bar. The armour shall be properly connected with earthing clamp, and the clamp shall be ultimately bonded with the earth bar.

- 4.12 LABELS:
- 4.12.1 Engraved metal labels shall be provided on all incoming and outgoing feeders. Single line circuit diagram showing the arrangements of circuit inside the distribution board shall be pasted on inside of the panel door and covered with transparent laminated plastic sheet.
- 4.13 NAME PLATE:
- 4.13.1 A name plate with the Panel's designation in bold letters shall be fixed at top of the central panel. A separate name plate giving feeder details shall be provided for each feeder module door.
- 4.13.2 Inside the feeder compartments, the electrical components, equipments, accessories like switchgear, control gear, lamps, relays etc. shall suitably be identified by providing stickers.
- 4.13.3 Engraved name plates shall preferably be of 3 ply,(Red-White-Red or Black-White-Black) lamicold sheet. However, black engraved Perspex sheet name plates shall also be acceptable. Engraving shall be done with square groove cutters.
- 4.13.4 Name plate shall be fastened by counter sunk screws and not by adhesives.
- 4.14 DANGER NOTICE PLATES:
- 4.14.1 The danger notice plate shall be affixed in a permanent manner on operating side of the Panels.
- 4.14.2 The danger notice plate shall indicate danger notice both in Hindi and English and with a sign of skull and bones.
- 4.14.3 The danger notice plates, in general, meet the requirements of local inspecting authorities.
- 4.14.4 Overall dimensions of the danger notice plate shall be 200 mm. wide x 150 mm. high.
- 4.14.5 The danger notice plate shall be made from minimum 1.6 mm. thick mild steel sheet and after due pre-treatment to the plate, the same shall be painted white with vitreous enamel paint on both front and rear surface of the plate.
- 4.14.6 The letters, the figures, the conventional skull and bones etc. shall be positioned on plate as per recommendation of IS: 2551-1982.
- 4.14.7 The said letters, the figures and the sign of skull and bones shall be painted in signal red colour as per IS: 5-1978.
- 4.14.8 The danger plate shall have rounded corners. Location of fixing holes for the plate shall be decided to suit design of the Panels.
- 4.14.9 The danger notice plate, if possible, be of ISI certification mark. Suitable Voltage rated rubber mates to be provided.
- 4.15 INTERNAL COMPONENTS:
- 4.15.1 The Panels shall be equipped complete with all types of required number of auto transformer starters, switch fuse units, contactors, relays, fuses, meters, instruments, indicating lamps, push buttons, equipment, fittings, bus bars, cable boxes, cable glands etc. and all the necessary internal connections/wiring as required and as indicated on relevant drawings. Components necessary for the proper and complete functioning of the Panels but not indicated on the drawings shall be supplied and installed on the Panels.

- 4.15.2 All parts of the Panels carrying current including the components, connections, joints and instruments shall be capable of carrying their specified rated current continuously, without temperature rise exceeding the acceptable values of the relevant specifications at the part of the Panels.
- 4.15.3 All units of the same rating and specifications shall be fully interchangeable.

COMPONENTS

4.16 GENERAL:

- 4.16.1 The type, size and rating of the components shall be as indicated on the relevant drawings.
- While selection of the capacity of the components resulting from the prevailing conditions like ambient temperature shall be allowed for. The thermal and magnetic trip rating shall be compensated for the ambient temperature.
- The ratings indicated on the drawing are ratings anticipated at prevailing site conditions.

4.17 MINIATURE CIRCUIT BREAKERS:

- 4.17.1 Miniature Circuit breakers shall be current limiting type conformed with British standard BS: 3871 (Part I) 1965 and IS: 8825. The housing of MCBs shall be heat resistant and having a high impact strength. The fault current of MCBs shall not be less than 9000 A at 230 V. The MCBs shall be flush mounted and shall be provided with trip free manual operating mechanism with mechanical 'ON' and 'OFF' indications.
- 4.17.2 The circuit breaker dollies shall be of the trip free pattern to prevent closing the breaker on a faulty circuit.
- 4.17.3 The MCB contacts shall be silver nickel and silver graphite alloy and tip coated with silver. Proper arc chutes shall be provided to quench the arc immediately. MCBs shall be provided with magnetic fluid plunger release for over current and short circuit protection. The overload or short circuit device shall have a common trip bar in the case of DP and TPN miniature circuit breakers. All the MCBs shall be tested and certified as per Indian Standards, prior to installation.

4.18 FUSE:

- 4.18.1 Fuses shall be of high rupturing capacity (HRC) fuse links and shall be in accordance with IS: 2000-1962 and having high rupturing capacity of not less than 35 MVA at 415 V. The back-up fuse rating for each motor/equipment shall be so chosen that the fuse does not operate on starting of motors/equipment. HRC fuses shall be of the make as specified in Make of Material.

4.19 AIR CIRCUIT BREAKER:

4.19.1 Construction:

The ACBs shall have following features:

1. Motorized with 230 V A.C. motor.
2. 230 V A.C closing and shunt trip coil
3. Draw out type with "service", "test", "isolated" and "maintenance" position.
4. Safety shutter of Fibre glass/polycarbonate sheet of 2mm thickness shall be provided
5. Mechanically trip free plus anti-pumping feature is to be provided.
6. Electrical trip free plus anti pumping shall be provided with relay ONLY and not by contactors.

7. Electrical/Mechanical operation counter shall be provided.
8. Door interlock with defeat features to be provided.
9. ACB shall be lockable in isolation position.

4.19.2 Release:

1. Thermal Magnetic release shall be direct acting type, tripping ACB mechanically.
2. Short circuit, overload and earth fault protection shall be provided.
3. Vendor to suggest release type for feeders of supply range characteristic and accuracy.

4.19.3 ACB Performance:

1. ACB performance inside panels at ambient 50 Degree.
2. Ith Symmetrical breaking, 35KA
3. Making capacity peak 87.5 KA
4. Short time rating, 1sec. 35KA

4.20 CONTACTORS:

4.20.1 The contractors shall meet with the requirements of IS: 2959 and BS: 775.

The contractors shall have minimum making and breaking capacity in accordance with utilisation category AC3 and shall be suitable for minimum Class II intermittent duty.

If the contractor forms part of a distribution board then a separate enclosure is not required, but the installation of the contractor shall be such that it is not possible to make an accidental contact with live parts.

4.21 CURRENT TRANSFORMER:

4.21.1 Where ammeters are called for C.T.s shall be provided for current measuring. Each phase shall be provided with separate current transformer of accuracy Class I and suitable VA burden for operation of associated metering and controls. Current transformer shall be in accordance with IS: 2705 - 1964 as amended upto date.

4.22 PUSHBUTTONS:

4.22.1 The push button unit shall comprise of the contact element, a fixing holder, and a push button actuator. The push button shall be momentary contact type. The contacts shall be of silver alloy and rated at 10 Amps. continuous current rating. The actuator shall of standard type and colour as per its usage for ON, OFF and TRIP.

4.23 INDICATING LAMPS:

4.23.1 Indicating lamps shall be transformer operated low voltage rated and shall be supplied complete with translucent covers to diffuse the lamp light.

Colour shade for the indicating lamps shall be as below – the LED shall be 22.5 mm and self coloured:

ON indicating lamp	:	Red
OFF indicating lamp	:	Green
TRIP indicating lamp	:	Amber
PHASE indicating lamp	:	Red, Yellow, and Blue

4.24 DIGITAL MULTI FUNCTION METER

- 4.24.1 The load manager shall be digital type with RS485 port. It should measure KW, KVA, KVAR, V, I, PF etc.

5.0 DRAWING & INFORMATION

- 5.1 Prior to fabrication of the Panels the supplier/contractor shall submit for consultant's approval the shop/vendor drawing consisting of G.A. drawing, sectional elevation, single line diagram, bill of material etc. and design calculations indicating type, size, short circuiting rating of all the electrical components used, busbar size, internal wiring size, Panels dimension, colour, mounting details etc.. The contractor shall submit manufacturer's catalogues of the electrical components installed in the Panels.

6.0 INSPECTION & TESTING

- 6.1 At all reasonable times during production and prior to transport of the Panels to site, the supplier/contractor shall arrange and provide all the facilities at their plant for inspection.
- 6.2 Testing of Panels shall be carried out at factory and at site as specified in Indian standards in the presence of consultant. The test results shall be recorded on a prescribed form. The test certificate for the test carried out at factory and at site shall be submitted in duplicate to the consultant for approvals.

7.0 METHOD OF MEASUREMENT

- 7.1 All the items will be measured as mentioned in Bill of quantity.

8.0 TRANSPORT, DELIVERY & STORAGE

- 8.1 The prices shall be F.O.R. site basis including packing & forwarding charges. The quoted price must include all the costs for necessary mode of transportation up to the final location of site or site store. All incidental expenses during transportation shall be part of quoted prices including transit insurance. The charges for loading and unloading of equipments at site should form part of offer.

9.0 GUARANTEE & WARRENTY

- 9.1 The Bidder shall stand guarantee for the performance of entire equipment and components for twelve (12) months from the date of commissioning or eighteen (18) months from the date of dispatch, whichever is earlier.

10.0 SPARES

- 10.1 The bidder shall quote for minimum spares required for **two years** safe operation of transformer along with the offer separately.

11.0 ATTACHMENTS

- 11.1
- Data Sheet

NOTE: VENDOR MUST HAVE CPRI APPROVED LICENSE FOR ELECTRICAL PANEL MANUFACTURING.

TECHNICAL DATA SHEET FOR MEDIUM VOLTAGE DISTRIBUTION BOARD

SR. NO.	PARTICULARS	DESCRIPTION
1.0	SITE CONDITION	
1.1	Type	Indoor
1.2	Mounting	Floor, Indoor
1.3	Ambient Temperature	50° C.
1.4	Atmosphere	Corrosive, Humid & Dusty
2.0	OPERATIVE CONDITION	
2.1	Voltage	415 V ± 10 %
2.2	No. Of Phase	3
2.3	System	3 Ø , 4 WIRE
2.4	Frequency	50 HZ, + 3 % / - 6 %.
2.5	Fault Level	18 MVA
2.6	Fault Current	As per SLD
3.0	CONTROL SYSTEM	
3.1	Voltage	230 V A.C.
	For Indication	230 V A.C.
	For Metering	230 V A.C.
	For Protection	230 V A.C.
3.2	Control Supply Through Control Transformer	230 V A.C. only
3.3	Control Wiring	2.5 MM ² FRLS Cu. Wire 4.0 MM ² FRLS cu. Wire for CT ckt.
4.0	BUSBAR	
4.1	Phase Bus bar	
A.	Material	Copper
B.	Support	SMC/DMC
C.	Insulation	Epoxy Moulded (Resin)
D.	Insulating Barriers	Fibre Glass / Poly Carbonate Of Minimum 1.5 Mm Thick And To Be Of Fr4 Class
E.	Current Density	1.0 Amp. / mm ²
4.2	Neutral Bus bar Material	Copper
4.3	Earth Bus bar Material	GI
5.0	Source changeover System	Not Required
6.0	PAINTING	
6.1	Sheet Should Be 7 Tank Processed, Oven Baked At 310°C. With Powder coating.	
6.2	Type Of Primer	EPOXY PRIMER
6.3	Type Of Paint	RAL 7032
6.4	Shade	Shall be confirmed with client
	Exterior	Shall be confirmed with client
6.5	Interior	IP 51
6.6	Degree Of Protection	35 ° C. above ambient
	Max. Temperature Rise Inside The Panel (°C.)	
7.0	CONTROL WIRING	
7.1	Wire Size	According to Load
8.0	HARDWARE (ZINC PLATED)	YES
9.0	SPACE HEATER	230 V A.C. With thermostat control
10.0	POCKET FOR DRAWINGS AT DOOR	YES
11.0	Illumination and switched power plug	YES

[EQ. TO SOR 2012-2013 CAT-III]

5. TECHNICAL
SPECIFICATIONS FOR
LT XLPE CALBE

TECHNICAL SPECIFICATIONS FOR LT XLPE CABLE

1.0 SCOPE OF WORK

1.1 This section shall cover supply, laying, testing and commissioning of medium voltage XLPE cables.

1.2 This specification gives the general requirement of cables. However, it is the responsibility of the vendor to take the joint measurement and obtain client's approval before the placement of orders to the main supplier / manufacturer.

2.0 CODES & STANDARDS

2.1 The following standards and rules shall be applicable :

Sr. No	Item	Relevant IS	Relevant IEC
1	XLPE insulated electric cables (heavy duty).	IS : 7098 Part I	
2	Recommended current ratings for cables.	IS : 3961	
3	Aluminium conductors for insulated cables	IS : 8130	Indian Electricity Act and Rules.

3.0 DESIGN BASIS & SITE CONDITIONS

3.1 All equipment and materials will be selected and rated for use at the following site conditions.

Site conditions			
Location : Gujarat		Site altitude 81M above mean sea level	
Ambient temperature		Relative humidity	
Maximum 45 ° C		Maximum 85 %	
Minimum 13 ° C		Minimum 25 %	
Design 50 ° C		Design 90 % at 50 ° C	
Seismic factor Zone III as per IS:1893		Rainfall 618mm/year	
Environmental Tropical conditions		Location of Equipment Indoor	
Electrical system data :			
Power supply for Equipment			
Voltage 415 V ± 5 %		Frequency 50 Hz ± 3 %	
Permissible combined voltage & frequency variation	± 6	System design faults level (Symmetrical)	15 kA for 1 sec. max.
System earthing LV side neutral solidly earthed		Wiring 3 phase, 4 wire on 415V system	

ply	
Power supply	240V AC, 1-Ph, 50Hz
Control Supply	-----
Space heater power supply	240V AC, 1-Ph, 50Hz
Illumination power supply	240V AC, 1-Ph, 50Hz
Plug-socket power supply	240V AC, 1-Ph, 50Hz

4.0

TECHNICAL REQUIREMENTS

4.1 GENERAL CONSTRUCTIONAL FEATURES

4.1.1 The medium voltage cables shall be supplied, laid, connected, tested and commissioned in accordance with the drawings, specifications, relevant Indian

Standards specifications, manufacturer's instructions. The cables shall be delivered at site in original drums with manufacturer's name, size, and type, clearly written on the drums.

4.2 MATERIAL :

Medium voltage cable shall be XLPE insulated. PVC sheathed, aluminium or copper conductor, armoured conforming to IS: 7098 Part I.

4.2.1 Type:

The cables shall be circular, multi core, annealed copper or aluminium conductor, XLPE insulated and PVC sheathed, armoured or unarmoured.

4.2.2 Conductor:

Uncoated, annealed copper / aluminium, of high conductivity upto 4 mm.² size, the conductor shall be solid and above 4 mm.², conductors shall be concentrically stranded as per IEC: 228.

4.2.3 Insulation:

XLPE rated 70° c. extruded insulation

4.2.4 Core Identification:

Two core	:	Red and Black
Three cor	:	Red, Yellow and Blue
Four core	:	Red, Yellow, Blue and Black
Single core	:	Green, Yellow for earthing

Black shall always be used for neutral.

4.2.5 Assembly:

Two, three or four insulated conductors shall be laid up, filled with non-hygroscopic material and covered with an additional layer of thermoplastic material.

4.2.6 Armour:

Galvanised steel flat strip / round wires applied helicaly in single layers complete with covering the assembly of cores.

For cable size upto 25 Sq. mm. : Armour of 1.4 mm dia G.I. round wire

For cable size above 25 Sq. mm. : Armour of 4 mm wide 0.8 mm thick G.I strip

4.2.7 Sheath:

XLPE 70 deg.c. rated extruded.

Inner sheath shall be extruded type and shall be compatible with the insulation provided for the cables.

Outer sheath shall be of an extruded type layer of suitable PVC material compatible with the specified ambient temp. 50 deg. C and operating temperature of cables. The sheath shall be resistant to water, ultraviolet radiation, fungus, termite and rodent attacks. The colour of outer sheath shall be black.

Sequential length marking required at every 1.0 mtr. interval on outer sheath

Vendor has to furnish resistance / reactance / capacitances of the cable

4.2.8 Rating:

Up to and including 1100 Volts.

5.0 DRAWINGS & INFORMATION

5.1 Contractor shall submit the as built drawing of the cable laying drawing.

5.2 HANDINGOVER DOCUMENTS

The supplier shall submit following:

1. Data sheet indicating results of tests

2. Test reports

6.0

INSPECTION AND TESTING

6.1 All cables shall be adequately protected against any risk of mechanical damage to which they may be liable in normal conditions of handling during transportation, loading, unloading etc.

The cable shall be supplied in single length i.e. Without any intermediate joint or cut unless specifically approved by the client.

The cable ends shall be suitably sealed against entry of moisture, dust, water etc. with cable compound as per standard practice.

6.2 Finished Cable Tests at Manufacturer's Works:

The finished cables shall be tested at manufacturer's works. Following routine tests for each and every length of cable and copy of test results shall be furnished for each length of cable alongwith supply. If specified, the cables shall be tested in presence of client's representative.

6.2.1 Voltage Test:

Each core of cable shall be tested at room temperature at 3 KV A.C. R.M.S. for duration of 5 minutes.

6.2.2 Conductor Resistance Test:

The D.C. Resistance of each conductor shall be measured at room temperature and the results shall be corrected to 20° c. to check the compliance with the values specified in IS 8130 - 1976.

6.3 Cable Test Before and After Laying of Cables at Site

6.3.1 Insulation Resistance test between phases and phase to Neutral and phase to earth.

6.3.2 Continuity test of all the phases, neutral and earth continuity conductor.

6.3.3 Sheathing continuity test.

6.3.4 Earth resistance test of all the phases and neutral.

7.0

METHOD OF MEASUREMENT

7.1 The cables will be measured in meters. The unit rate shall include cutting the cable into required lengths, packing, loading, unloading, insurance, transportation, delivery to stores/site as per work order, stocking in stores, testing of cables at stores etc. of medium voltage cable. Total quantity in meters shall be measured lug to lug basis.

8.0

TRANSPORT, DELIVERY AND STORAGE

8.1 The cable shall be supplied in the actual length as per detailed purchase order

8.2 The cable shall be dispatched at client's stores or at site as per detailed instructions given by client at later stage.

8.3 The cable shall be loaded from the main vendor's store and properly stacked as per instruction of client's local representative. All such labour and transportation charges shall be clearly mentioned in the offer.

9.0

GUARANTEE OF PERFORMANCE

9.1 The quotes values of parameters shall be within given tolerance for given period of service life.

Detail Specification for PVC Pipe & DWC Pipe

ITEM NO. 1 P.V.C. Pipes (RIGID) - 6 Kg.

1. Providing & Fixing P.V.C. Pipes (RIGID) - 6 Kg. ISI marked 110 MM DIA.& 90 MM DIA including fittings make or equivalent as approved by engineer-in-charge . Pipe shall be fixed on the help of clamp at every two meter C/C or shall be concealed as directed including necessary fittings etc. including testing of pipe and joints and fixing the same with adhesive solvent ,including cost of all materials including hydraulic testing as directed by engineer-in-charge

(A) 110 mm dia. (B) 90 mm etc. dia.

The P.V.C. pipe shall be approved quality and make of as per IS 13592 : 1992 of appropriate class for sewage, rain water and waste water and shall got approved before use by consultant / Engineer in charge. They shall be fixed by means of approved claims or embedded in the structure as instructed by Consultant. The rates inclusive all necessary special such as bends YS,TS, Plug, bends, off sets, shoes, cowl etc. all special fittings shall be of standard make of first class quality and shall in all respect comply with relevant ISS. Nothing extra shall be paid for cutting the pipes for required length or for collar. The overlap of pipes will not be paid. The joints of the pipe shall be filled by properly and it should be watertight.

INSTALLATION

General

- (a) All pipe and accessories shall be handled in such manner as to insure delivery to the trench in sound, undamaged condition. Particular care shall be taken not to injure pipe coating, if coating or lining of any type of pipe or fitting is damaged, repair shall be made prior to installation. No other pipe or material shall be placed inside of a pipe or fitting after coating has been applied. Pipe shall be placed inside of a pipe or fitting after coating has been applied. Pipe shall be carried into immediately shall be stored in cool, dark place and out of the sun. installation procedures shall provide for safe conduct of the work, careful removal and disposition of materials, protection of property, which is to remain undisturbed, coordination with other work in progress, and protection of utility services.
- (b) Joints shall not be covered until approved. Pipe, pipefitting or appurtenances found defective after installation shall be replaced. Pipe shall be laid true to line and grade to form a close concentric joint with adjoining pipe and to prevent offsets of the flow line. Sections of pipe shall be so laid and fitted together that when complete, the sewer shall have a smooth and uniform invert. As the work progresses, the interior of the sewer shall be cleaned of all dirt and superfluous materials, where cleaning after laying is difficult because of small pipe size, a suitable swab or drag shall be kept in the pipe and pulled forward past each joint immediately after the jointing has been completed. Pipe cutting where necessary shall be done neatly, without damage to the pipe. Unless otherwise authorized, cutting shall be done by means of an approved cutter.
- (c) Each pipe and fitting shall be carefully inspected before and after installation and those found defective shall be rejected. Proper facilities shall be provided for lowering sections of pipe into trenches. Any pipe or fitting that does not allow sufficient space

for proper caulking or installation of joint material shall be closed temporarily with wood blocks.

- (d) For rain water / waste water pipes shall be covered through masonry wall of brick partition and 20 mm thick sand faced cement plaster.

Tests

- (a) Tests of completed piping systems shall be conducted in strict accordance with testing procedures and requirements of ASTM C8282 or AWWA C600 as applicable.
- (b) Do not backfill piping (more than minimum required to hold in place for testing) prior to receipt of acceptance from Owner's Representative for results of tests.
- (c) Conduct repair and retests when required to UN accepted test results at no cost to Owner.

MODE OF MEASUREMENT: AS PER MENTIONED IN SCHEDULE – B

Description

Mode of Payment: The rate shall be for a Unit of One Mtr.

ITEM NO 2. DOUBLE WALL CORRUGATED PIPE

Providing & laying approved make Double walled corrugated pipes (DWC) of polyethylene(conforming to IS 14930 II)with necessary connecting accessories of same material at required depth for laying of cable. below ground / road surface for enclosing cable and back filling the same to make ground as per original.

FOREWORD

This specification is issued under the fixed serial number followed by the year of adoption as standard or in case of revision, the year of latest revision.

This specification requires reference to the following specifications.

- (i) IS:14930 Pt.-I : General requirements of Conduit system for Electrical and Communication installation
- (ii) IS:14930 Pt.-II : Particular requirements of Conduit system for Electrical and Communication installation
- (iii) IS:2530 : Method for test for Polyethylene moulding materials and polyethylene compounds.
- (iv) IS:7328 : HDPE materials for moulding and extrusion
- (v) IS:12063 : Classification of degrees of protection provided by enclosures of electrical equipment
- (vi) IS:11000(Pt2/Sec1) : Glow-Wire Test and Guidance, Test Methods for Fire Hazard Testing
- (vii) ASTM D 1693 : Test method for environmental stress – cracking of ethylene plastics
- (viii) ASTM D 638 : Standard test method for tensile properties of plastic
- (ix) ASTM D 790 : Test method for flexural properties of Unreinforced and Reinforced Plastics and Electrical Insulating Materials.
- (x) ASTM D 2240 : Standard Test method for Rubber property.

(xi) ASTM D 648 : Standard Test method for deflection temperature of plastic under flexure load in the Edgewise Position.

Whenever reference to any specification appears in this document, it shall be taken as a reference to the latest version of that specification unless the year of issue of the specification is specifically stated.

1.0 SCOPE

This document specifies the requirement and testing for Double Walled Corrugated (DWC) HDPE Ducts buried underground including ducts & duct fittings for protection wherever required for all types Cables.

2.0 TERMINOLOGY

Terminology as defined in IS: 14930 shall be followed.

3.0 ABBREVIATIONS

- ASTM : American Society for Testing & Materials.
- CC : Cubic Centimeter.
- DSC : Differential Scanning Calorimeter
- DTA : Differential Thermal Analyzer
- DWC : Double Walled Corrugated
- ESCR : Environmental Stress Crack Resistance
- FTIR : Fourier Transform Infrared Spectroscopy
- g : Gram • HDPE : High Density Polyethylene.
- Hr : Hour
- IS : Indian Standard.
- Kg : Kilograms
- MFI : Melt Flow Index.
- mm : Millimeter
- OIT : Oxidation Induction Test
- SPN : Specification Provisional Number.
- UV : Ultra Violet.

4.0 GENERAL REQUIREMENTS

4.1 The DWC Duct shall consist of two layers, the outer layer will be corrugated and the inner layer shall be plain and smooth.

4.2 DWC Duct and conduit fittings within the scope of this specification shall be so designed and constructed that in normal use their performance is reliable and without danger to the user or surroundings.

4.3 When assembled in accordance with manufacturer's instruction as part of a conduit system, they shall provide mechanical protection to Cables contained therein.

4.4 Within the conduit system there shall be no sharp edge, burrs or surface projections which are likely to damage insulated conductors or cables or inflict injury to the installer or user.

4.5 The protective properties of the joint between conduit and conduit fittings shall be not less than that declared for the conduit system.

4.6 The DWC Duct and fittings shall withstand the stresses likely to occur during transport, storage, recommended installation practice and application.

4.7 The DWC duct shall be supplied in continuous length in coil form or straight length, suitable for shipping and handling purpose.

4.8 For conduit systems that are assembled by means other than threads, the manufacturer shall indicate whether the system can be disassembled and if, so, how this can be achieved.

5.0 REQUIREMENTS OF RAW MATERIALS USED FOR THE DWC HDPE DUCTS

5.1 The base HDPE resin used for the outer and inner layer of the DWC HDPE Duct shall conform to any designation of IS:7328 or to any equivalent standard meeting the requirements given in Table No. 1, when tested as per the standards given therein. However, the manufacturers shall furnish the designation for the HDPE resin as per IS: 7328 as applicable.

5.2 The anti-oxidants used shall be physiologically harmless.

5.3 None of the additives shall be used separately or together in quantities as to impair long term physical and chemical properties of the duct.

5.4 Single pass rework material of the same composition produced from the manufacturer's own production may be used and it shall not exceed 10% in any case.

5.5 The raw material used for extrusion shall be dried to bring the moisture content to less than 0.1%. 5.6 Suitable UV stabilizers shall be used only for manufacture of the non black coloured HDPE duct to protect against UV degradation, when stored in open. The purchaser may ask for UV content test. The test result for UV Content test by FTIR method from any recognized laboratory shall be accepted and the Hindered Amine Light Stabiliser shall be minimum 0.15 %. UV Content test need not to be conducted in case of UV Stabilized raw material is used.

6.0 REQUIREMENT OF DWC HDPE DUCTS

6.1 Visual Requirement: The ducts shall be checked visually for ensuring good workmanship that the ducts shall be free from holes, breaks and other defects. The ends shall be cleanly cut and shall be square with axis of the ducts.

6.2 Colour: The colour of the duct viz. Black, Red, Green, Blue, Orange, Violet, Grey, Brown and Yellow. The purchaser shall specify the colour of the duct at the time of ordering.

6.3 Dimensions: The dimensions of the DWC HDPE Ducts shall be as given in table- 2. Any other sizes other than those mentioned in Table- 2 shall be as per the agreement between the buyer and the seller. Compliance shall be checked as per procedure given in Annexure- A

6.4 Standards Length: Duct up to 50 mm OD nominal size shall be supplied in standard length of 100 mtr. $\pm 1\%$ or 6 mtr $\pm 1\%$ and all other sizes will be supplied in standard length of 6 mtr. $\pm 1\%$

6.5 Compression Strength: The conduit system shall have adequate mechanical strength. Conduits when bent or compressed either during, or after, installation according to manufacturer's instructions, shall not crack and shall not be deformed to such an extent that introduction of the insulated conductors or cables becomes difficult or that the installed insulated conductors, or cables are likely to be damaged while being drawn in. Compliance may be checked with the application of force which shall be at least 450 N, when reaching the deflection of 5%. Test shall be conducted in accordance to the method given in Annexure- B

6.6 Impact Strength: The conduit system shall have adequate mechanical strength. Conduits when exposed to impact either during, or after, installation according to manufacturer's instructions, shall not crack and shall not be deformed to such an extent that introduction of the insulated conductors or cables becomes difficult or that the installed insulated conductors, or cables are likely to be damaged while being drawn in. Compliance may be checked by ensuring there shall be no crack allowing the ingress of light or water between the inside and outside after the test. Test shall be conducted in accordance to the method given in Annexure- C

6.7 Bending Strength: The conduit system shall have adequate mechanical strength. Conduits when bend either during, or after, installation according to manufacturer's instructions, shall not crack and shall not be deformed to such an extent that introduction of the insulated conductors or cables becomes difficult or that the installed insulated conductors, or cables are likely to be damaged while being drawn in. During the test sample shall not flatten Compliance shall be checked by passing a ball having a diameter equal to 95% minimum inner diameter of the sample declared by the manufacturer, through the sample whilst it is bent around the test apparatus. Test shall be conducted in accordance to the method given in Annexure- D

6.8 Oxidation Induction Test (OIT): The OIT in a qualitative assessment of the level (or degree) of stabilization of material. The induction time in oxygen when tested with an Aluminum pan as per method given in Annexure- E shall not be less than 30 minutes.

6.9 Resistance To Flame Propagation: Non flame propagating ducts shall have adequate resistance to flame propagation. Samples of DWC HDPE Ducts shall be checked by applying a 1KW flame. Test shall be conducted in accordance to the method given in Annexure- F Combustion shall stop within 30 Seconds.

6.10 Carbon Black Content: In case of black coloured duct Carbon Black Content by weight should be between 2 % and 3 %. Test shall be conducted in accordance to the IS: 2530

6.11 Anti Rodent Properties: Safety of ducts from the direct attack of subterranean organism anti rodent material is of utmost importance. These ducts shall be evaluated for their safety against rodents before laying them in the fields. Test shall be conducted in accordance to the method given in Annexure- G

6.12 Resistance to External Influences on DWC HDPE Duct Accessories: The accessories in Clause 7.0 shall be tested for external influences as per IS-12063 for ingress of dust & ingress of water. DWC Duct systems when assembled in accordance with the manufacturer's instructions shall have adequate resistance to external influences according to the classification declared by the manufacturer with a requirement of IP 67. Test shall be conducted in accordance to the method given in Annexure- H

6.13 Marking Identification: The conduit shall be prominently marked at regular intervals along their length of preferably 1m but not longer than 3m using indelible ink with following.

- Manufacturers name
- Specification No.
- Name of the duct with size
- Lot No. of the Product
- Date of manufacture
- Product Length
- Purchaser's Name/ symbol

7.0 DWC DUCT ACCESSORIES

7.1 The following accessories are required for jointing the ducts and shall be supplied along with the ducts against specific orders. The manufacturers shall provide complete procedure and method for installation of the accessories. The required quantities of accessories are to be mentioned by the purchasing authority in the purchase order.

7.1.1 Plastic Coupler: The coupler shall be of Push-fit type with O-ring. It is used for jointing two or more ducts. The design of this shall be simple, easy to install and shall provide air tight and water tight joint between the two ducts. The coupler shall insure that the two ducts are butted smoothly without any step formation in the inner surface. The coupler may be straight, bands, T-joints type as per requirements of purchaser.

7.1.2 End Cap: This cap made of suitable plastic material shall be fitted on the both ends of duct, coil after manufacturing the duct. This shall avoid entry of dust, mud and rainwater into the duct during the transit & storage.

7.2 The dimensions of accessories shall be suitable for joining the ducts of dimension as per Cl: 6.3

8.0 PACKING REQUIREMENT

Stores shall be supplied in standard size for delivery and shall be so packed as to permit convenient handling and to protect against loss or damage during transit and storage.

9.0 TYPE TESTS

9.1 Complete DWC Duct systems for each offered size of the duct on fresh samples shall be subjected to following tests minimum after 240 hrs of manufacture.

- a) Visual Requirement (Cl. No. 6.1)
- b) Color (Cl. No. 6.2)

- c) Dimension (Cl. No. 6.3)
- d) Standards length (Cl. No. 6.4)
- e) Compression Strength (Cl. No. 6.5)
- f) Impact Strength (Cl. No. 6.6)
- g) Bending Strength (Cl. No. 6.7)
- h) Oxidation Induction Test (Cl. No. 6.8)
- i) Resistance to Flame Propagation (Cl. No. 6.9)
- j) Carbon Black Content (Cl. No. 6.10)
- k) Anti rodent (Cl. No. 6.11)
- l) Resistance to External Influences on DWC HDPE Duct accessories (Cl. No. 6.12)

9.2 The Oxidation Induction Test, Resistance to Flame Propagating Test, Carbon Black Content Test, Anti Rodent Test on the DWC duct and Resistance to External Influences on DWC HDPE Duct accessories given in Cl. No. 6.8, 6.9, 6.10, 6.11 & 6.12 respectively may be conducted at the manufacturer's laboratory by inspecting authority or at any recognized laboratory.

9.3 The raw material tests of the DWC duct given in Cl. No. 5.0 Table-1 for each grade of raw material shall be conducted. Test may be conducted at the manufacturer's laboratory by inspecting authority or at any recognized laboratory.

9.4 Unless otherwise specified each tests shall be made on three new samples.

10.0 ACCEPTANCE TESTS

10.1 The following test shall be carried after 240 hrs of manufacture on samples selected from the lot as per sampling plan given in Cl 13.0

- a) Visual Requirement (Cl. No. 6.1)
- b) Color (Cl. No. 6.2)
- c) Dimension (Cl. No. 6.3)
- d) Standards length (Cl. No. 6.4)
- e) Compression test (Cl. No. 6.5)
- f) Impact test (Cl. No. 6.6)
- g) Bending test (Cl. No. 6.7)
- h) Resistance to Flame Propagation (Cl. No. 6.9)

10.2 The Resistance to Flame Propagating Test on DWC HDPE Duct given in Cl. No. 6.9 may be conducted at the manufacturer's laboratory by inspecting authority or at any recognized laboratory.

10.3 Unless otherwise specified each tests shall be made on three new samples.

11.0 ROUTINE TESTS

11.1 The following tests be carried out by the manufacturer after 240 hrs of manufacture:-

- a) Visual Requirement (Cl. No. 6.1)
- b) Color (Cl. No. 6.2)

- c) Dimension (Cl. No. 6.3)
- d) Standards length (Cl. No. 6.4)
- e) Compression test (Cl. No. 6.5)
- f) Impact test (Cl. No. 6.6)
- g) Bending test (Cl. No. 6.7)
- h) Resistance to Flame Propagation (Cl. No. 6.9)

11.2 The Resistance to Flame Propagating Test on DWC HDPE Duct given in Cl. No. 6.9 may be conducted at the manufacturer's laboratory by inspecting authority or at any recognized laboratory.

11.3 The Density and Melt Flow Index tests on raw material of the DWC duct given in Cl. No. 5.0 Table-1 for each grade of raw material shall be conducted.

12.0 INSPECTION

12.1 All the gauges/ test & measuring instruments shall be under calibration control at the time of inspection and proof to this office shall be produced.

12.2 Inspection and testing shall be carried out by the inspecting authority nominated by the purchaser to ensure that all the requirements of this specification are complied with for the acceptance of the materials offered by the supplier for inspection.

12.3 The purchaser or his nominee shall have free access to the works of the manufacturer and to be present at all reasonable times and shall be given facilities by the manufacturer to inspect the manufacturing of the duct at any stage of manufacture. He shall have the right to reject whole or part of any work or material that does not conform to the terms of this specification or any equivalent specification or requirement applicable and may order the same to be removed / replaced or altered at the expense of the manufacturer. All reasonable/complete facilities considered necessary by the inspecting authorities for the inspection of the ducts shall be supplied by the manufacturer free of cost.

12.4 The manufacturer shall supply the duct samples and samples of the raw materials free of charge as required by the inspecting authority and shall at his own cost prepare and furnish the necessary test pieces and appliances for such testing as may be carried out at his own premises in accordance with this specification. Failing the existence of facilities at his own premises for the prescribed tests, the manufacturer shall bear the cost of carrying out the tests in an approved laboratory, workshop or test house.

13.0 SAMPLING

13.1 All the length of same nominal size, similar construction and class manufactured from the same material under essentially similar conditions of production shall be grouped together to constitute a lot.

13.2 For judging the conformity of a lot to the requirements of the acceptance tests, sampling shall be done for each lot separately. For this purpose, the number of lengths to be selected at random from the lot shall be in accordance with Table 3.

13.3 These lengths will be selected at random from the lot for taking samples. From each of these lengths, sample of duct shall be taken. The length of the sample shall be sufficient so as to provide test pieces of required lengths as laid down in various test clauses.

14.0 WARRANTY

The manufacturer shall warrant the material covered by this specification to be free from defects in design, material and workmanship under ordinary use and service, his obligation under this warranty being limited to replace free of cost those parts which shall be found defective.

15.0 REJECTION

In case the duct tested and inspected in accordance with this specification, fail to pass the tests or comply with the requirement of the specification, the whole consignment shall be rejected subject to the discretion of the purchaser or his nominee.

16.0 INFORMATION TO BE SUPPLIED BY THE PURCHASER

16.1 Normally the duct will be supplied as per the standard dimensions and length as mentioned in this document. However purchaser may specify his own dimensions/lengths/packing requirements etc. In such cases necessary tolerance shall also be specified by the purchaser.

16.2 Adequate quantity & type of duct accessories shall be supplied along with each lot. Purchasers may specify additional requirement.

16.3 Inspecting agency for acceptance of material. 16.4 Colour of the Duct.

MODE OF MEASUREMENT: AS PER MENTIONED IN SCHEDULE – B

Description

Mode of Payment: The rate shall be for a Unit of One Mtr.

ANNEXURE – A

DIMENSION OF THE DWC DUCT

1.0 Compliance of the outside diameter shall be checked using a ring gauge or vernier caliper or any suitable method.

1.1 Compliance of the minimum inside diameter shall be checked by measurement according to two perpendicular diameters on the same section and calculating the average value.

1.2 Outside diameter specified are nominal dimensions.

1.3 Outside diameter maximum is nominal outside diameter + (0.018 x nominal outside diameter values) rounded off to + 0.1 mm.

1.4 For sizes other than specified in table-2 minimum inside diameter is nominal outside diameter divided by 1.33

ANNEXURE - B

COMPRESSION TEST

1.0 Conduits are subjected to a compression test as per IS: 14930 (Pt-II). The tests for conduits shall not be started until 240 hrs after manufacture.

1.1 Samples shall be 200 ± 5 mm long.

1.2 Before the test the outside and inside diameters of the samples shall be measure as described in clause 6.3

1.3 The samples shall be compressed between two flat steel plates having minimum dimensions (100x200x15mm), the length 200 mm being along the length of the sample. The sample shall be compressed at a rate of 15 ± 0.5 mm/min and the load recorded at the vertical deflection equivalent to 5% of the average value of the original inside diameter of the sample.

1.4 When reaching the deflection of 5%, the applied force shall be at least 450 N

1.5 After the test there shall be no crack allowing the ingress of light or water between the inside and the outside.

1.6 The deflection is calculated with the inner diameter but the measurement of the outside diameter may be sufficient. In case of doubt, it will be necessary to measure the inner diameter.

ANNEXURE – C

IMPACT TEST

1.0 Twelve samples of the duct each 200 ± 5 mm in length or fittings are subjected to an impact test as per IS: 14930 (Pt-II).

1.1 The test apparatus shall be placed on a firm flat surface. The samples shall be conditioned in a cold chamber at a temperature of $-5 \pm 1^\circ\text{C}$ for 2 h. The samples shall be removed from the cold chamber and placed on the v-block holder of the impact tester.

1.2 The striker shall fall once on each sample. The time between removal of the sample from the cold chamber and completion of impact shall not exceed 10 seconds. The impact height and mass shall be as follows.

Nominal Size of Conduit	Mass of Striker (+1% /-0%) kg	Fall Height (+0% /- 1%) (mm)	Energy Joules
Up to 60 mm	5	300	15
61 to 90 mm	5	400	20
91 to 140 mm	5	570	28
Above 140 mm	5	800	40

1.3 The test sample shall be made on the weakest part of the Duct fittings except that it shall not be applied within 5 mm of any sample entry. Samples of ducts are tested on the center of their length.

1.4 After the test, at least in nine of the samples, there shall be no crack allowing the ingress of light or water between the inside and the outside.

ANNEXURE – D

BENDING TEST

1.0 This test shall be carried out on pliable conduits.

2.0 The test is made on six samples having an appropriate length as per IS: 14930 (Pt-II). Three samples shall be tested at room temperature; the other three shall be tested at $-5 \pm 1^\circ\text{C}$. For the test at -5°C , the sample shall be conditioned in a cold chamber for 2 hours. The test apparatus as shown in Figure-2 shall allow to bend the duct with a bending radius equal to the

minimum bending radius values specified by the manufacturer. One of the ends of the samples shall be fixed on the test apparatus by means of an appropriate device. The sample is then bent to approximately 90 degree (right angle) and hold.

2.1 During the test, the sample shall not flatten. Compliance shall be checked by passing a ball having a diameter equal to 95% minimum inner diameter of the sample declared by the manufacturer, through the sample whilst it is bent around the test apparatus.

ANNEXURE – E

OXIDATION INDUCTION TEST PROCEDURE

1.0 A short length of completed duct (approximately 30 cm) shall be sealed at the ends and placed in an oven at temperature of 68 ± 1 °C for 8 hours. The sample shall then be allowed to cool at room temperature for at least 16 hrs. The samples shall be clean and dry. The sample shall then be tested by means of a Differential Scanning Calorimeter (DSC) or by Differential Thermal Analyzer (DTA).

2.0 Instrument Test Procedure:

2.1 Cell Cleaning: The cell shall be held at approximately 400 °C for 10 minutes in Nitrogen. The cell shall be cleaned after standing over night and between testing of different formulations.

2.2 Temperature Calibration: This has to be done according to the instrument manual. The temperature scale should be adjusted until the determined melting point of pure Indium metal is 156.6 °C at a heat rate of 5°C per minute or any other heat rate as indicated in the manual of the equipment is permitted.

2.3 Aluminum Pan Preparation: Standard aluminum DSC pans as per ASTM D 4565 are required to hold specimens during testing. A fresh pan shall be used for each test.

2.4 Sample preparation: Take the sample weighing about 5 mg from the duct conditioned as indicated above. Position the sample in the center of the pan.

2.5 Nitrogen Purge: Place the sample pan and reference pan in instrument cell. Flush for 5 minutes with cylinder of nitrogen (99.6% extra dry grade) at 60 ± 10 cc per minute.

2.6 Oxidation Test: Rapidly increase the temperature of the sample (20 °C/min or greater) from 100 °C or lower initial temperature to 199 ± 1 °C. After thermal equilibrium is obtained (steady recorder signal) switch to 80 ± 20 cc per minute oxygen flow and simultaneously start time-base recording. The oxygen used for the test should be equivalent to or better than 99.6% extra dry grade.

2.7 Induction Period: The oxygen induction point shall be recorded as time zero, and the chart speed shall be sufficient to provide a clearly discernible slope at the start of the exothermic reaction. The test in the pure dry oxygen atmosphere shall continue until the exothermic peak is produced. The intersection of the tangent of the exothermic sloped line

with the extended base line will be drawn. The time from time zero to its intersection point is read from the base line and recorded as the oxidative induction time.

ANNEXURE – F

RESISTANCE TO FLAME PROPAGATION TEST PROCEDURE

1.0 Samples of DWC HDPE Ducts shall be checked by applying a 1KW flame.

1.1 A sample of length 675 ± 10 mm is mounted vertically in a rectangular metal enclosure with one open face, as shown in Figure-3-2 in an area substantially free from draughts. The general arrangement is shown in Figure-3. Mounting is by means of two metal clamps approximately 25mm wide spaced 550 ± 10 mm apart and approximately equidistant from the ends of the sample. A steel rod of 16 ± 0.1 mm is passed through the sample. It is rigidly and independently mounted and clamped at upper end to maintain the sample in a straight and vertical position. The means of mounting is such as not to obstruct drops from falling onto the tissue paper. A suitable piece of white pinewood board, approximately 10 mm thick, covered with single layer of white tissue paper is positioned on the lower surface of the enclosure. The assembly of sample, rod and clamping apparatus is mounted vertically in the center of the enclosure, the upper extremity of the lower clamp being 500 ± 10 mm above the internal lower surface of the enclosure.

1.2 The burner is supported so that its axis is 45 ± 20 to the vertical. The flame is applied to the sample so that the distance from the top of the burner tube to the sample measured along the axis of the flame is 100 ± 10 mm and the axis of the flame intersects with the surface of the samples at a point 100 ± 5 mm from the upper extremity of the lower clamp, and so that the axis of the flame intersects with the axis of the sample.

1.3 The test is carried out on three samples. The flame is applied to the sample for the period specified in Table -4 and is then removed. During the application of the flame, it shall not be moved except to remove it at the conclusion of the period of the test. After the conclusion of the test and after any burning of the sample has ceased, the surface of the sample is wiped clean by rubbing with a piece of cloth soaked with water.

1.4 All three samples shall pass the test. If the sample is not ignited by the flame, it shall be deemed to have passed the test.

If the sample burns, or is consumed without burning, the sample shall be deemed to have passed the test if after burning has ceased, and after the sample has been wiped in accordance with , there is no evidence of burning or charring within 50 mm of the lower extremity of the upper and also within 50 mm of the upper extremity of the lower clamp.

If the sample burns, it shall be deemed to have failed the test if combustion is still in progress 30 seconds after removal of the flame.

If the tissue paper ignites, the sample shall be deemed to have failed the test. For the parts of the same below the burner, the presence of molten material on the internal or external surfaces shall not entail failure if the sample itself is not burned or charred.

2.0 Compliance of DWC HDPE Duct fittings is checked by using the glow wire test IS:11000 (Part 2/Sec 1). The glow wire shall be applied once to each sample in the most unfavorable position of its intended use, with the surface tested in vertical position, at a temperature of 750°C. The sample is deemed to have passed this test if there is no visible flame or sustained glowing or if flames or glowing extinguishes within 30s of the removal of the glow wire.

ANNEXURE – G

ANTI RODENT TEST PROCEDURE:

The test against rodent may be conducted as per following procedures:

The ducts are to be laid underground in fields and also near urban or rural settlements. Therefore they should be exposed to 3-4 most predominant rodent species inhabiting these locations. The test rodent species may include the lesser bandicoot rat, *Bandicota bengalensis*, The Indian gerbils, *tatera indica*, the soft furred field rats, *Millardia meltada* and the house rats, *Rattus rattus*.

The test ducts should be exposed to these rodent species housed individually in iron mesh cages under laboratory conditions. Only freshly capture rodent are to be utilized for the study. The rodents are first acclimatized in laboratory cages for 7-10 days and then the tests be initiated. For each trial, 3-4 rodents of uniform body weight are to be used for the trial. Two different types of testes may be undertaken for all the ducts.

Choice Tests: In this trial the ducts of 15-30 cm length (one sample each of treated and untreated /control sample) are exposed to the test rodents along with food, thus the rodent had a choice between the food and the test duct. This test may be run for longer periods (30-45 days). Tap water should be provided ad libitum to the rodents.

NO Choice Test: The rodents are exposed to the test ducts only and no food is given to the rodents during the period of trial. The test ducts (one sample each of treated and untreated /control sample) are to the exposed to the test rodents. This trail may be run for 5-7 days depending upon the health status of starved test rodents. Tap water should be provided ad libitum to the rodents.

Observation on tooth marks, rodent behavior toward exposed ducts, relative extent of damage in treated and untreated samples should be computed for both types of ducts. Health status of test animals in choice and no choice test must also be monitored for the record any ill effect of exposure of treated / control ducts on these animals. Number of cases and the extent of rodent bites / scratch marks in control and anti rodent treated ducts may indicate the relative deterrent/repellent properties of the test ducts.

ANNEXURE – H

EXTERNAL INFLUENCES TEST PROCEDURE

1.0 The accessories in Clause 7.0 shall be tested for external influences as per IS-12063 for ingress of dust & ingress of water. DWC Pipes systems when assembled in accordance with the manufacturer's instructions shall have adequate resistance to external influences according to the classification declared by the manufacturer with a requirement of IP 67.

2.0 Degree of Protection – Ingress of Foreign Solid Objects.

2.1 An assembly is made of DWC Pipes fittings with a short length of DWC Pipes assembled in each entry. Where necessary, the open ends of the assembly are plugged or are not part of the test.

2.2 The assembly shall be tested in accordance with the appropriate test of IS 12063. 2.3 The assembly tested for numeral 6, shall be deemed to have passed the test if there is no ingress of dust visible to normal or corrected vision without magnification.

3.0 Degree of Protection – Ingress of Water.

3.1 An assembly is made of a DWC Pipe fittings with a short length of DWC Pipes assembled in each conduit entry. Where necessary, the open end of the DWC Pipe is plugged, or is not part of the test.

3.2 The assembly shall be tested in accordance with the appropriate test of IS 12063.

3.3 The assembly tested for numeral 7 shall be deemed to have passed the test, if there is not sufficient ingress of water to form a drop visible to normal or corrected vision without magnification.

Table-1
RAW MATERIAL REQUIRMENT
(Cl. 5.0)

S. No.	Parameter	Specified Limit	Test Method
1.	Density	0.940 to 0.958 g/cc at 27°C	IS:2530 or IS:7328 2.
2.	Melt Flow Index	0.2 to 1.1 g/10 min at 190°C, 5 kg load	IS:2530
3.	Tensile Strength at Yield	20 N/mm ² Minimum	ASTM D 638-IV
4.	Elongation at Break	600 % Minimum	ASTM D 638-IV
5.	Hardness Shore D	Between 60 and 65 units	ASTM D 2240
6.	Environmental Stress Crack Resistance	No cracking after 96 hrs.	ASTM D 1693
7.	Flexural modulus at 1 % strain	690 N/mm ² minimum	ASTM D 790
8.	Heat Deflection Temperature at 45 g/mm ²	650C minimum	ASTM D 648
9.	OIT (in Aluminum Pan)	30 minutes minimum	As per Annexure-E

Table-2
DIMENSIONS
(Cl. 6.3)

Sr. No	DWC PIPE ELECTRIES SIZES IN MM			
	Duct Size	Nominal OD	Nominal ID	Nominal Delivery Length (Mtrs)
1	40/32	40	32	100
2	50/39	50	39	100
3	63/50	63	50	100
4	78/63	78	63	6
5	90/76	90	76	6
6	110/96	110	96	6
7	120/103.5	120	103.5	6
8	160/136	160	136	6

9	180/152	180	152	6
10	200/175	200	175	6
11	250/217	250	217	6
12	300/260	300	260	6
13	315/275	315	275	6

Table-3
SCALE OF SAMPLING
(Clause-13.0)

Lot Size	For dimensional requirements		Other Acceptance tests
	Sample size	Permissible Number of Defectives of Defectives	
(1)	(2)	(3)	(4)
Up to 300	13	0	2
301 to 500	20	0	3
501 to 1000	32	1	4
1001 to 3000	50	2	5
3001 and above	80	3	7

Table-4
TIME OF EXPOSURE OF THE SAMPLE TO THE FLAME
(Clause-6.9)

Material	Thickness (mm)	Flame Application (Tolerances +1 sec.)
Over	Up to	
(1)	(2)	(3)
-	0.5	15
0.5	1.0	20
1.0	1.5	25
1.5	2.0	35
2.0	2.5	45
2.5	3.0	55
3.0	3.5	65
3.5	4.0	75
4.0	4.5	85

4.5	5.0	130
5.0	5.5	200
5.5	6.0	300
6.0	6.5	500

Application : Telecom, Electrical Industry

**13. TECHNICAL SPECIFICATION
FOR
FIRE FIGHTING (PROTECTION) SYSTEM**

1.0 SCOPE OF WORK

The scope includes fire protection system only, the detection is covered under separate tender

- 1.1 Fire Hydrant system
- 1.2 Fire Sprinkler System for basement
- 1.3 Fire Extinguishers

The detailed scope is described in the chapter "Extent of Work. "

2.0 FIRE EXTINGUISHERS

2.1 GENERAL:

The scope of work under this part of the specification covers supply and installation of internal appliances as per requirements specified in schedule & marked on drawings and instructions of engineer-in-charge.

Makes of all the appliances supplied and installed shall be as per the 'List of Approved Make ' or as approved by LFA and shall be of identical design for the entire premises.

Mounting accessories, indicator boards etc are part of the scope of supply of internal appliances.

2.2 SPECIFICATIONS:

Internal appliances with various fire extinguishing medium shall conform to the following specifications and shall be installed and maintained as per IS: 2190 / NFPA 10

Portable Extinguishers of the following types shall be installed.

- 1. Dry chemical Powder type
- 2. Co2 type
- 3. Water / Foam type
- 4. ABC type

2.2.1 DRY CHEMICAL POWDER TYPE:

The Dry chemical powder type shall be of 5 Kg. Capacity and shall have the IS mark 2171 or latest Indian standard complete with powder and charged including with fixing bracket, fitted with gunmetal cap, and discharge hose and open grip nozzle.

2.2.2 CO2 TYPE:

The Co2 Extinguisher shall be ISI mark, with initial charge with high pressure cylinder, complete with wheel type valve, internal discharge tube, with high pressure discharge hose with horn and suspension brackets. The extinguisher shall have ISI mark of 2878 or latest Indian standard and capacity shall be 2 Kgs.

2.2.3 WATER / FOAM TYPE :

The water type extinguisher shall conform to IS 15683 or latest Indian Standard having 9 ltr. capacity & will be with fixing arrangement with all accessories.

- 2.2.4 ABC (Powder) TYPE : 6 Kg ABC (Powder) type fire extinguisher shall conform to IS 15683 or latest Indian Standard & will be with all accessories & mounting arrangement.

However, type & capacity of fire extinguishers are to be provided according to local CFO requirement

3.0 PIPE WORK

3.1 GENERAL REQUIREMENTS:

- 3.1.1 All the materials shall be of TAC/LFA approved, best quality conforming to the specifications and subject to the approval of the Client or his representative. If so directed, materials shall be tested in an approved testing laboratory & the contractor shall produce the test certificate in original to the Engineer-in-charge & the entire charges for original as well as repeated tests shall be borne by the Contractor.
- 3.1.2 Before welding, the pipe faces shall be cleared & then shall be welded conforming to IS : 9595 – 1980. The electrodes used for welding shall comply with IS:814. the laying of welded pipe shall also comply to IS 5822 – 1986. The welding joints shall be tested in accordance to IS:3600, Part 1973.
- 3.1.3 Pipes and fittings shall be fixed truly vertical, horizontal or in slopes as required in a neat workman like manner.
- 3.1.4 Pipes shall be fixed in a manner as to provide easy accessibility for repair and maintenance and shall not cause obstruction in shafts, passages etc.
- 3.1.5 Pipes shall be securely fixed to walls, and ceilings by suitable clamps or supported at every 3 mtr. & at change of direction as required. Only approved type of anchor fastners shall be used for RCC ceiling and walls.
- 3.1.6 Valve and other appurtenances shall be so located that they are easily accessible for operations, repairs and maintenance.

3.2 PIPING

Pipes of the following types are to be used:

- 3.2.1 M.S. pipes as per IS: 1239, heavy duty (for pipes of sizes 150 mm N.B. and below) suitably lagged on the outside to prevent soil corrosion. M.S. pipes buried below ground shall be lagged as per IS: 10211.
- 3.2.2 MS pipe lines upto 150 mm dia. shall have all fittings as per IS: 1239, Part-II (heavy grade) while pipelines above 150 mm dia shall be fabricated from IS: 3589 Gr.320 pipes as applicable or from steel plates.
- 3.2.3 For MS pipelines upto 50 mm dia screwed jointing shall be adopted, while for pipelines above 50 mm dia welded or flanged construction is to be carried out or as specified in Schedule of quantities.
- 3.2.4 Hangers and supports shall be capable of carrying the sum of all concurrently acting loads. They shall be designed to provide the required supporting effects and allow pipeline movements as necessary. All guides, anchor, braces, dampener, expansion joint and structural steel to be attached to the building structure trenches etc. shall be provided. Hangers and components for all piping shall be approved by the Consultant / Client / Architect.
- 3.2.5 The piping system shall be capable of withstanding 150% of the working pressure including water hammer effects.

- 3.2.6 Flanged joints shall be used for connections to vessels, equipment, flanged valves and also on suitable straight lengths of pipeline of strategic points (@ at every 15-20 mtr.) to facilitate erection and subsequent maintenance work.
- 3.2.7 Excavation for pipe line shall be in open trenches. Pipes shall be buried atleast one meter below ground level and shall have 230 mm x 230 mm masonry supports atleast 300mm high at 3m intervals. Masonry work to have plain cement concrete foundation (1 cement: 4 coarse sand: 8 stone aggregate) of size 380 x 380 x 75 thick resting on firm soil.
- 3.2.8 Wherever required Contractor shall support all trenches or adjoining structures with adequate supports to prevent land slides.
- 3.2.9 On completion of testing and painting trenches shall be refilled with excavated earth in 15 cm layers and compacted.
- 3.2.10 Contractor shall dispose off all surplus earth within the site.
- 3.2.11 Contractor shall provide suitable cement concrete anchor blocks for overcoming pressure trusts in underground / external pipes. Anchor blocks shall be of cement concrete 1:2:4 mix.

4.0 VALVES

- 4.1 Valves shall be used to start, stop or control flow. Non-return valves shall be provided unidirectional flow.
- 4.2 Butterfly valve conforming to BS 5155 or as indicated in BOQ will be used for isolation of flow in pipelines. Optionally, gate valves having outside screw rising spindle shall be used and shall be as per IS: 780 / 14846 PN 1.0/1.6, as applicable. For sizes 50mm to 200mm, Butterfly valve shall be as per IS: PN = 1.6 or as specified in Schedule of quantities. Non-return valves shall be swing check/spring operated type. An arrow mark in the direction of flow shall be marked on the body of the valve. These valves shall conform to IS:5312 for swing type or API 596/598 for spring type check valves
- 4.3 Valves below 50 mm size shall have screwed ends while those of 50 mm and higher sizes shall have flanged connections. Drain lines will have locks for draining.

5.0 INTERNAL HYDRANT:

Internal hydrant shall be provided at each landing or at suitable location consisting of single / twin headed gunmetal landing valve as indicated in BOQ with 63 mm dia oblique female instantaneous pattern with caps & chains. Outlet and 80 mm inlet (IS: 5290-1969) with separate shut off valve. Landing valves shall be 63 mm dia. oblique female instantaneous pattern with caps and chains. Landing valves shall be of gunmetal and fitted with instantaneous coupling conforming to IS: 901. The valve body, stop valve, check valve, nut, instantaneous female outlet and blank cap shall be of leaded-tin bronze conforming to Grade-II of IS: 318-1962. The valve spindle shall be of brass rod conforming IS: 320 - 1962. The hand wheel shall be mild steel or cast iron washers gaskets shall be of rubber conforming to IS:638 - 1965 or leather conforming to IS:581 : 1969. The coupling shall be fitted with an internal plug secured by chain landing valves shall be installed on hydrant riser at a height of 1.0 to 1.2 meter from the floor level.

Each internal hydrant shall be provided with two nos. 63 mm. Diameter 15 mtr. Long hose pipe with gunmetal male and female instantaneous type coupling, machined wound with G.I. wire hose of IS 636 type A and couplings to IS:903 with IS certification, gunmetal branch pipe with nozzle conforming to IS:903.

6.0 HOSES

Hoses pipes shall be of fabric reinforced rubber lines as per IS:636 Type II or canvas hose as per IS:4927, with nominal size of 63 mm and lengths of 15 meter or 7.5 meter, as per quantities specified for in schedule or bill of quantity.

All hose pipes shall carry ISI marking on the body of the hose.

The hose shall have instantaneous spring lock-type coupling on ends. The instantaneous coupling shall be as per IS: 901. It shall be fixed to each other by copper rivets and galvanized M.S. wires and leather bands. All coupling shall be interchangeable with each other, and shall bear ISI markings.

7.0 HOSE CABINETS (HOSE BOX)

Each hydrant shall be housed in a Hose cabinet of suitable size. The hydrant cabinet shall hold double / single headed hydrant as specified, 2 hoses and one branch pipe as required. Internal hydrants shall normally fit the size of the niche made for it. The cabinet shall be of minimum 16 SWG M.S. sheet with centre opening, double glass front doors (cleat glass of 4mm thickness). The glass shall be firmly fixed by means of steel clips and screw with rubber beading. Hinges shall also be screwed and not welded. The corner members (frame) shall be of 25 x 25 x 3 mm thick angle. The hose box shall be firmly fixed to the wall/support by means of brackets and dash fasteners. The steel work shall have one coat of primer and two coats of red paint. The words "Yard Hydrant", "Hydrant" etc. should be painted in white or red on the glass in 75 mm high letters. The hose box shall be lockable for internal hydrant installation.

8.0 HOSE REEL

The hose reel shall be directly tapped from the riser through a 25 / 32 mm dia pipe, the drum and the reel being firmly held against the wall by use of dash fasteners. The hose reel shall be swinging type (180degrees) and the entire drum, reel etc. shall be as per IS: 3876 and IS: 884. The rubber tubing shall be of best quality and the nozzle shall be shut off type.

9.0 BRANCH PIPES

Branch pipe shall be of either gun metal or aluminium and should conform to IS: 903. One end of the branch pipe will receive the coupling while the other end shall have a nozzle screwed to it. It shall bear ISI marking.

10.0 YARD / EXTERNAL HYDRANT

Yard or External Hydrants shall be as per IS: 908 and the valve as per IS:5290. The hydrant shall consist of stand post assembly and a masonry base 200 mm X 200 mm X 200 cm high and shall be made at the point where it comes out of the soil. The valve shall complete with hand wheel, quick coupling connection spring and blank cap. The hydrant shall be laid on 150 dia. or as mentioned in BOQ.

Yard or External hydrant shall be controlled by a cast iron sluice valve. Hydrant shall have oblique female instantaneous pattern 63 mm diameter outlets with caps and chains. The hydrant shall be of gunmetal and flange inlet and single outlet conforming to IS: 5290, a duck foot bends and flanged riser of required height to bring the hydrant to level above ground. The valve body, stop valve, check valve, nut, instantaneous female outlet and blank cap shall be of leaded-tin bronze conforming to Grade-II of IS:318-1962. The valve spindle shall be of brass rod conforming IS:320 - 1962. The hand wheel shall be mild steel or cast iron washers gaskets shall be of rubber conforming to IS:638 - 1965 or leather conforming to IS:581 : 1969.

Each external hydrant shall be provided with two nos. 63 mm. Diameter 15 mtr. Long hose pipe with gunmetal male and female instantaneous type coupling, machined wound with G.I. wire hose of IS 636 type A and couplings to IS:903 with IS certification, gunmetal branch pipe with 20 mm nozzle conforming to IS:903.

11.0 VALVE CHAMBERS

A valve chamber shall be brick masonry chamber in cement mortar 1:5 (1 cement: 5 coarse sand) on cement concrete foundation 150 mm thick foundation 1:5:10 mix (1 cement: 5 fine sand: 10 graded stone aggregate 40 mm nominal size), 15 mm thick cement plaster inside and outside finished with a floating coat of neat cement inside with cast iron surface box approved by fire brigade including excavation, back filling, complete. The wall shall be 230 mm thick with heavy duty ISI marked C.I. manhole covers.

12.0 FIRE BRIGADE INLET CONNECTION

A fire brigade inlet connection with a non-return valve shall be provided to facilitate the fire brigade to pump water into the installation by the use of their own equipment. Four way or 150 mm dia connection to the system shall comprise of four instantaneous pattern 63 mm dia. male inlets shall be with caps and chains complete with 150 mm dia. sluice valves, non-return valve housed in a M.S. cabinet with glass fronted door. The cabinet shall be suitable for recess mounting.

Two way or 100 mm fire brigade inlet connection to the system shall comprise of two instantaneous pattern 63 mm dia. male inlets shall be with caps and chains complete with 100 mm dia sluice valve, non-return valve housed in a M.S. cabinet with glass fronted door. The cabinet shall be suitable for recess mounting.

13.0 SYSTEM DRAINAGE

The systems shall be provided with suitable drainage arrangements with MS piping of 50 mm dia. complete with all accessories, and provided with drain valve.

14.0 HYDRANT SYSTEM

14.1 The hydrant system shall comprise of AC motor driven pump sets. Diesel pump, Jockey pump etc. with all required accessories including valves, appurtenances, instrumentation and controls etc. complete in all respects. The system shall cover the entire area from independent pipe work from the fire water pump set. The hydrant work shall remain pressurized through the proposed Jockey pump taking care of any leakages in the system pipelines and valve glands. All pumps / motors / engines to be of makes approved by local Fire Authority.

14.2 The hydrant system shall be kept charged by pressurized water at approximately 7.5 Kg/cm² at all times. In the event of fire when any of the hydrant valves in the net work is opened, the resultant fall in header pressure should enable starting the Electric Motor driven fire water pumping set through pressure switches automatically. One Diesel Engine / DG set driven pump shall be a stand-by pump serving hydrant system & sprinkler both. In case of failure of electricity or failure of Elec. Pump to start on demand, the stand-by DG set operated pump shall automatically take over. Apart from the automatic starting of the pump sets, provision shall be kept for manual starting also. However shifting down of the pump sets shall be manual.

14.3 The hydrant system in the yard shall be furnished with external hydrants consisting of landing valves (positioned approx. one meter above ground level) fitted M.S. (Heavy) flanged single headed stand pipes installed on underground hydrant headers distributed 45 M apart approximately or as marked on the plan.

The entire system including all pumps, motors, diesel pump set and panels shall be of approved make by TAC / Local Fire Authority.

15.0 SPECIFICATION FOR PUMPS AND ANCILLARY EQUIPMENT

15.1 SCOPE OF WORK

15.1.1 Work under this section shall consist of furnishing all labour, materials, equipment and appliances necessary and required to completely install electrically operated pumps for fire hydrant installations as required by the drawings and specified hereinafter or given in the schedule of quantities.

15.1.2 Without restricting to generality of the foregoing the pumps and the ancillary equipment and shall include the following:

- a) Electrically operated pumps having twin outlets with motors base plate and accessories.
- b) Pump suction and delivery headers, valves, air vessel and connections.
- c) Pressure gauges / pressure switch.
- d) Only single point 3 phase supply will be made available to the Contractor. From there, all provision viz. Electrical switchboard, wiring, cabling, cable tray, control panel, earthing, etc. shall be made.

15.1.3 GENERAL REQUIREMENT

- a) Pumps shall be installed true to level on suitable concrete foundations. Base plate shall be firmly fixed by foundation bolts properly grouted in concrete foundations.
- b) Pumps and motors shall be truly aligned with suitable instruments.
- c) The pump shall have single suction & twin discharge connection
- d) All pump connections shall be standard flanged type with appropriate number of bolts.
- e) Manufacturer instructions regarding installation connections and commissioning shall be followed with respect to all pumps, switchgear and accessories.

15.1.4 FIRE AND JOCKEY PUMPS

- a) The main Fire hydrant & Sprinkler pumps shall be End Suction Back Pull Out type while Jockey pumps shall be of Centrifugal Monoblock Pump type having following specifications.
- b) Shut off head should not exceed 140% of rated head. Pump shall not develop less than 65% of rated head at 150% of rated capacity.

MATERIALS OF CONSTRUCTION

Part	Material
Casing	Cast Iron
Impeller	Bronze IS:318, Gr. LTB 2
Casing Wearing	SS
Shaft	AISI – 410 / Stainless Steel
Shaft Sleeve	S.S. 316
Stuffing Box	Gland Packed

- c) Pumps shall be provided with pressure gauge with isolation cock on the delivery side.
- d) In case of motor driven pump the motor rating should be adequate to drive the pump at 150% of rated discharge.
- e) The pump and its prime mover (Electric motor or Diesel Engine) shall comply with all the equipment of the Rules of the Traffic Advisory Committee.
- f) All pumps shall have positive suction & shall be provided with suction strainer of SS & CI bell mouth. In case of negative suction suitable priming arrangement shall be provided.
- g) All the pumps shall have single suction & twin discharge connections i.e. low pressure & high pressure to serve designated lower & higher floors respectively as per drawing.

A) JOCKEY PUMP

Starting and stopping of Jockey Pump set shall be automatic at predetermined levels through pressure switch. However, arrangements for manual start and stop of the pump shall also be made. Jockey Pump shall take care of small leakages in the piping system and pumps cushion tanks. Jockey pump shall have also single suction & twin discharge connections.

B) ELECTRIC DRIVEN

Electrically driven pumps shall be provided with totally enclosed fan cooled, foot mounted, squirrel cage induction motors suitable for fire pumps with IP-55 enclosure.

The motors should be rated not to draw more than 4.5 times the starting current.

Motors shall be at least equivalent to the horse power required to drive the pump at 150% of its rated discharge.

The motors shall be wound for class-F insulation and windings shall be vacuum impregnated with heat and moisture resisting varnish, glass fiber insulated.

C) DIESEL ENGINE

- a) Diesel engine shall have suitable no. of cylinders with individual heat assemblies. The engine shall be water cooled and shall include heat exchanger and connecting piping strainer, isolating pressure reducing valves, bye-pass line, exhaust pipe, silencer, day tank for fuel all interconnected piping etc., complete in all respects.
- b) Engine shall be direct injection type with low noise and exhaust omission levels,
- c) The speed of engine shall match the pump speed for direct drive.
- d) The engine shall be capable of being started without the use of the wicks, cartridge heater plugs or either at engine room temperature of 4°C and shall take full load within 15 seconds from the receipt of the signal to start.
- e) The engine shall effectively operate at 46°C ambient temperature at 150 meter above mean sea level.
- f) Engine shall be suitable for running on high speed diesel oil.
- g) The system shall be provided with a control panel with push button starting arrangement also wired to operate the engine on differential pressure gauge.

- h) The entire system shall be mounted on a common structural base plate with anti-vibration mounting, Dunlop make, and flexible connections on the suction and delivery piping.
- i) Contractor provide one fully mounted and supported Day Oil Tank fabricated from 6mm thick MS sheet electrically welded for 8 hours working load and having suitable capacity of oil. Provide level indicators – low level and full level in the Day Oil Tank on the control panel through float switches and an breather. Day Oil Tank shall also be provided with filling connection (Threaded) with cap, gauge glass indication and cocks, drain cock, inspection / cleaning cover with gasket and nuts / bolts. MS dyke to hold 150% of the Day Tank capacity to be built around the Day Tank.
- j) Contractor to provide one exhaust pipe with suitable muffler (residential type) to discharge the engine gasses to outside in open air as per site conditions (Contractor to check the site).
- k) Contractor to provide all accessories, fittings and fixtures necessary and required for a complete operating engine set. The exhaust pipe shall be taken outside the building with minimum number of bends (approx. length 30 Meters) and shall be duly heat insulated with 50mm thick glass wool covered with 24 gauge aluminum cladding.
- l) Contractor shall indicate special requirements, if any, for the ventilation of the Pump Room.

Noise & Vibration level of the pump driven by motor/engine shall be within the acceptable limits of ISO 2372, IS 11727.

15.1.5 BOOSTER PUMP (Not Applicable)

A booster pump shall be provided at terrace to pressurize the wet riser system. The pump shall be centrifugal end suction / monoblock type.

15.1.6 BASE PLATE

Pumps and motors shall be mounted on a common structural base plate and installed as per manufacturer's instructions.

16.0 CUBICLE TYPE SWITCH BOARD/L.T. PANEL

Cubicle type switchboards and components shall conform to the requirements of the latest revision including amendments of the following codes and standards.

IS: 8623	Specification for factory built assemblies of switchgear and control gear for voltage upto and including 1000V AC / 1200V DC.
IS: 4237	General requirements for switch-gear and control-gear for voltage not exceeding 1000-V.
IS: 2147	Degree of protection provided by enclosure for low voltage switch-gear and control-gear.
IS: 1018	Switch-gear and control-gear selection/installation and maintenance.
IS: 6005	Code of Practice for phosphating of iron and steel.
IS: 13947-1993/ IEC 947 - 1989	Air circuit breaker / moulded case circuit breaker.
IS: 1248	Direct acting indicating analogue electrical measuring instruments and testing accessories.

IS: 2705
Part - I,
II & III 1964

Current transformers for metering and protection with classification burden and insulation.

17.0 AIR CUSHION TANK

Every wet riser shall be provided with an air cushion tank at its top most point. The air cushion tank shall be provided with an automatic air release cock, 20 mm dia. drain pipe, drain valve and shut off valve.

18.0 PRESSURE GAUGE

All pressure gauges shall be dial type with Borden tube element of SS 316. The dial size shall be of 150 mm diameter and scale division shall be in metric units marked clearly in black on a white dial. The range of pressure gauge shall be 0-10 kg.sq.cm or as specified in BOQ. The pressure gauges shall be complete with isolation cock, siphon tubing, etc.

19.0 PRESSURE SWITCHES

19.1 The pressure switch shall be industrial type single pole double throw electric pressure switch designed for starting or stopping of equipment when the pressure in the system drops or exceeds pre set limits. It shall comprise of a single pole change over switch, below element assembly and differential spindle.

19.2 All pressure switches shall have ¼" BSP (F) inlet connection and screwed cable entry for fixing cable gland. All control cabling shall be provided.

20.0 SPRINKLER HEADS

Sprinkler heads shall be provided at approximate spacing so as to cover 12 sq.mtr. per sprinkler head in case of ordinary hazard for basement having car parking area. The spacing shall however be in uniformity with the drawings and properly coordinated with electrical fixtures, ventilation ducts and grilles and other services along the ceiling. Sprinkler heads shall be gunmetal quartz bulb type with a temperature rating of 68°C. Sprinkler heads shall be of upright conventional type with fusible link for operation. Sprinkler head shall be approved by the under writers Laboratories (U.L.) or Fire Officers Committee (FOC). The finish shall be as specified in bill of quantities.

Contractor shall install cabinet (fabricated from 16 Gauge M. S. sheets with lockable glass shutters. Shelves for keeping spare sprinklers and spanner at locations approved by the Engineer-in-Charge and given in the schedule of quantities. The contractor shall also give required tools for removing and fixing of different types of sprinkler free of cost as directed by Engineer-in- Charge.

21.0 SPRINKLER SYSTEM

21.1 GENERAL:

To supply, install, testing and commissioning of sprinkler system as per drawing and Sprinkler heads spacing shall be in conformity with the drawings and properly coordinated in reflected ceiling with electrical fixtures, ventilation ducts and grills and other services along the ceiling.

Sprinkler heads shall be brass / gunmetal with quartz bulb with temperature rating of 68 degree celsius. Sprinkler heads shall be of type and quality approved by the local fire brigade authority. The inlet shall be screwed. Sprinkler heads shall be pendent, recessed or special side type. All sprinklers shall conform to the specifications given by TAC, IS, NFPA, FOC, UL & FM.

21.2 UPRIGHT TYPE SPRINKLER HEAD

Sprinkler heads shall be quartzite bulb type with bulb, valve assembly, yoke and the deflector. The sprinkler shall be of approved make and type with 15 mm nominal diameter outlets.

The bulb shall be made of corrosion free material strong enough to withstand any water pressure likely to occur in the system. The bulb shall be shatter when the temperature of the surrounding air reaches at 68 c. Upright sprinklers shall be considered for basement.

The nominal bore shall 15 mm diameter and colour of liquid shall be as per temperature rating.

21.3 FLOW SWITCH

Flow switch shall have a paddle made up of flexible material of the width to fit within the pipe bore. The terminal box shall be mounted over the paddle / pipe through a connecting socket. The switch shall be potential free in either NO or NC position as required. The switch shall be able to trip and make/ break contact on the operation of a single sprinkler head. The terminal box shall have connections for wiring to the Fire alarm panel. The seat shall be of stainless steel. The flow switch shall have IP: 55 protections.

The flow switch shall work at a minimum flow rate of 100 LPM. Further, it shall have a retard to compensate for line leakage or intermittent flows.

21.4 BUTTERFLY VALVE

The Butterfly valve shall be suitable for waterworks and tested to minimum of 16 kg/sq cm Pressure. The valves shall fulfill the requirements of BIS(Indian Standard)BS: 5155 or AWWA C 504, API 609 and MSS-SP-67.

The body shall be of cast iron to IS: 210 in circular shape and of high strength to take the minimum water pressure of 10 kg/sq cm. The disc shall be heavy-duty cast iron with anti-Corrosive epoxy or nickel coating.

The valve seat shall be high grade elastomer or nitrile rubber. The valve in closed position shall have complete contact between the seat and the disc throughout the perimeter. The elastomer rubber shall have a long life and shall not give away on continuous applied water pressure. The shaft shall be of ENB grade carbon steel.

The valve shall be fitted between two flanges on either side of pipe flanges. The valve edge rubber shall be projected outside such that they are wedged within the pipe flanges to prevent leakages.

The valve shall be supplied with manual gear operated opening/ closing system by lever.

21.5 DRAIN VALVE

50 MM / or as specified in SOQ diameter MSpice conforming to I.S.:1239 (heavy grade) with 50 mm diameter / or as specified in SOQ gunmetal full way valve shall be provided for drainage of any water in the system in low pockets.

22.0 TESTING OF THE HYDRANT SYSTEM:

22.1 All air shall be trapped from the pipeline through hydrants & air valves. Each section of the pipe shall be slowly filled with the water & allow to stand the water for 2 hours minimum with the ends closed. No joints / connection shall be leaked within this duration. The hydraulic test pressure shall be 1.5 times the design pressure.

22.2 Flushing of underground connections: Underground mains and lead-in connections to system risers shall be flushed before connections made to piping in order remove foreign

materials which may have entered the underground during the course of installation. For hydrant system the flushing operation shall be continued until water is clear.

22.3 Underground mains and lead-in connection shall be flushed at a flow rate of not less than 480 ltrs. per minute.

22.4 Provision shall be made for the disposal of water issuing from test outlets to avoid property damage.

22.5 Acceptance Test

At the time of taking over, the hydrant system shall fulfill the following acceptance tests:-

22.5.1 Starting up of the pressure suction (Jockey Pump) : The pressure switch shall be set at 3.5 kg/cm² at the lower limit and 7.5 kg/cm² at the upper limit. The system drain shall be opened to cause a drop in the pressure. The Jockey Pump shall start as soon as the pressure gauge needle falls down to 3.5 kg. The Jockey pump shall also stop automatically when the system has been pressurised again upto 7.5kg/cm².

22.5.2 The main electrical pump shall be set to start at 3.5 kg/cm². An external hydrant valve using a single length of hose and branch pipe shall be fully opened to cause a drop of pressure in the system. At first, the jockey pump shall start when the pressure drops from 7 kg. Further, drop in the pressure from 3.5 kg should be allowed to test automatic start-up of the electrical pump. The electrical pump shall continue to run atleast for 5 minutes and register rise in the pressure upto 3.5 kg the Jockey Pump shall be automatically start at this. The electrical pump shall be stopped manually by pressuring the stop button.

22.5.3 After having the system got fully charged at 7.5 kg/cm² the external hydrant valve using hose and branch pipe at (ii) above shall be opened. When the pressure has dropped from 3.5 kg/cm², the electric main pump shall come into operation automatically. After the main pump has run for 5 minutes, the power supply in the pump house shall be switched off. The diesel pump shall automatically come into operation immediately.

22.5.4 All these tests mentioned above shall be repeated after one hour interval. The result of all the tests shall be identical again. After the system has satisfactorily withstood the above tests, it can be taken over from the contractor.

23.0 START-UP/SYSTEM TESTING

It will be the responsibility of the tenderer to cause interim/stage inspection by the Local Fire Authority LFA/ Chief Fire Officer C.F.O during execution of the work as and when so called for by the Employer / Consultant and shall carry out any rectification / modification as may be suggested by the Local Fire Authority (LFA), Chief Fire Officer (CFO).

Soon after the work is completed, the contractor shall inform the LFA/CFO in writing with a copy to the Consultant/Employer for getting the complete system including all sub system and instrumentation, control etc. thoroughly inspected and tested for satisfactory performance. After satisfactory completion of tests of the systems by the LFA / CFO, the contractor shall be required to submit as built drawings to the Consultant / OWNER which have been so approved.

24.0 COMMISSIONING OF SYSTEM

24.1 Pressurised the fire hydrant system by running the main fire pump and after attai required pressure shut off the pump.

24.2 Open bye-pass valve and allow the pressure to drop in the system. Check that the jockey pumps cuts-in and cuts-out at the pre-set pressure. If necessary adjust the pressure switch for the jockey pump. Close bye-pass vavle.

- 24.3 Open bye-pass valve and allow the water to flow into the fire water tank in order to avoid wastage of water. The main fire pump should cut-in at the preset pressure and should not cut-out automatically on reaching the normal line pressure. The main fire pump should stop only by manual push button. However, the jockey pump should cut out as soon as the main pump starts.
- 24.4 Switch off the main fire pump and test check the diesel engine driven pump in the same manner as the electrically driven pump.
- 24.5 When the fire pumps have been checked for satisfactory working on automatic controls, open fire hydrant simultaneously and allow the hose pipe to discharge water into the fire tank to avoid wastage. The electrically driven pump should run continuously for eight hours so that its performance can be checked.
- 24.6 Diesel engine / DG set driven pump should also be checked in the same manner as given in clause above by running for 8 hours.
- 24.7 Check each landing valve, male and female couplings and branch pipes for compatibility with each other. Any fitting which is found to be incompatible and does not fit into the other properly, shall be replaced by the Contractor. Landing valves shall also be checked by opening and closing under pressure.

25.0 HANDING OVER

- 25.1 All commissioning and testing shall be done by the Contractor to the complete satisfaction of the Engineer-in-Charge / Consultants, and the job handed over to the Client.
- 25.2 Contractor shall also hand over to the Client all maintenance and operation manuals and all items as per the terms of the contract.

CONSTRUCTION OF NEW PRIMARY HEALTH CENTER-PHC AT KUMBHARWADA DIS.- BHAVNAGAR

COPY FOR ESTIMATE

CLIENT	CONTRACTOR	PMC/T.P.I.

ESTIMATE DRAWING

REVISION NOTES

NO.	DATE	REVISION DETAILS
R1		

IMP NOTE:

TOTAL PLOT AREA= 1076.53 SQ.MT

BUILT UP AREA CALCULATION

SR.NO	FLOOR	AREA	UNIT
01.	GROUND FLOOR	270.33	SQ.MT
02.	FIRST FLOOR	278.72	SQ.MT
03.	SECOND FLOOR	270.33	SQ.MT
04.	STAIR CABIN + LMR	67.04	SQ.MT
TOTAL BUILT UP AREA		886.42	SQ.MT

ISSUE STAMP

DEPUTY ENGINEER

EXECUTIVE/ CITY/ CHIEF ENGINEER

ARCHITECTURE/ ENGINEER
STRUCTURE CONSULTANT SIGNATURE

REVISION DATE : -	DATE : - 21-10-2024
SCALE : - N.T.S.	TYPE : - P.H.C.

MASTER LAYOUT PLAN

AGENCY -

CLIENT - BHAVNAGAR MUNICIPAL CORPORATION(BMC)

PROJECT:-
CONSTRUCTION OF NEW PRIMARY HEALTH CENTER-PHC
AT KUMBHARWADA DIS.- BHAVNAGAR

JAYESH A DALAL
Planning & Engineering Services Pvt Ltd

JALARAM SHAKTI, BESIDE DHAWAL GRI APARTMENT, NR.LORD'S CONVENT SCHOOL,ATHWALINES,SURAT.



DRAWN BY	REVISED BY	CHECKED BY	DRG NO	PROJ NO
VELSI	---	---	---	12PY24

EXISTING ROAD

12.00 MT WIDE APPROACH ROAD

MAIN ENTRY

MAIN EXIT

LANDSCAPED GARDEN
11.72 X 4.07

DP STRUCTURE

4.50 MT WIDE INTERNAL ROAD

4.50 MT WIDE INTERNAL ROAD

4.50 MT WIDE INTERNAL ROAD

4.50 MT WIDE INTERNAL ROAD

MAIN ENTRY/
EXIT

2 WHEELER PARKING
21-NOS

GREEN AREA

4 WHEELER PARKING
06-NOS

GREEN AREA

GREEN AREA

2 WHEELER PARKING
18-NOS

SITE LAYOUT PLAN

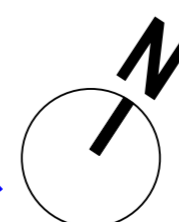

CONSTRUCTION OF NEW PRIMARY HEALTH CENTER-PHC AT KUMBHARWADA DIS.- BHAVNAGAR

COPY FOR ESTIMATE

CLIENT CONTRACTOR PMC/T.P.I.

ESTIMATE DRAWING

REVISION NOTES

NO. DATE REVISION DETAILS

R1

IMP NOTE:

SCHEDULE OF DOORS

SR NO.	NAME	SIZE (OPENING)	GR. FL.	1ST. FL.	2ND. FL.	TER. FL.	TOTAL	SILL	LINTEL	REMARK
1	MD	1.50 X 2.40	01	-	01	-	02	-	2.40	FLUSH DOOR
2	D1	1.385 X 2.40	02	-	-	-	02	-	2.40	FLUSH DOOR 2 SHUTTER
3	D2	1.35 X 2.40	-	02	-	-	02	-	2.40	FLUSH DOOR 2 SHUTTER
4	D3	1.20 X 2.10	01	01	01	-	03	-	2.10	PVC DOOR & ALUMN.FRAME
5	D4	1.00 X 2.40	07	05	02	02	14	-	2.40	FLUSH DOOR [FRP @ TER,LMR]
6	D5	0.90 X 2.40	07	02	03	-	12	-	2.40	FLUSH DOOR
7	D6	0.75 X 2.10	05	09	05	-	19	-	2.10	PVC DOOR & ALUMN.FRAME

SCHEDULE OF WINDOWS

SR NO.	NAME	SIZE (OPENING)	GR. FL.	1ST. FL.	2ND. FL.	TER. FL.	TOTAL	SILL	LINTEL	REMARK
1	W	1.80 X 1.50	04	08	08	-	20	0.90	2.40	3-TRACK SLIDING WINDOW
2	W1	1.50 X 1.50	10	07	07	-	24	0.90	2.40	3-TRACK SLIDING WINDOW
3	W2	1.00 X 1.50	03	-	-	-	03	0.90	2.40	2-TRACK SLIDING WINDOW
4	W3	0.75 X 1.50	03	-	-	-	03	0.90	2.40	2-TRACK SLIDING WINDOW

SCHEDULE OF VENTILATIONS

SR NO.	NAME	SIZE (OPENING)	GR. FL.	1ST. FL.	2ND. FL.	TER. FL.	TOTAL	SILL	LINTEL	REMARK
1	V1	4.00 X 0.90	01	01	01	-	03	-	-	LINTEL LEVEL
2	V2	1.50 X 0.90	-	02	01	-	03	-	-	LINTEL LEVEL
3	V3	0.75 X 0.90	04	01	01	-	06	-	-	LINTEL LEVEL

ISSUE STAMP

DEPUTY ENGINEER

EXECUTIVE/ CITY/ CHIEF ENGINEER

ARCHITECTURE/ ENGINEER
STRUCTURE CONSULTANT SIGNATURE

REVISION DATE : - DATE : - 21-10-2024

SCALE : - N.T.S. TYPE : - P.H.C.

GROUND FLOOR PLAN

AGENCY -

CLIENT - BHAVNAGAR MUNICIPAL CORPORATION(BMC)

PROJECT:-
CONSTRUCTION OF NEW PRIMARY HEALTH CENTER-PHC
AT KUMBHARWADA DIS.- BHAVNAGAR

JAYESH A DALAL

Planning & Engineering Services Pvt Ltd

*JALARAM SHAKTI, BESIDE DHAWALGIRI APARTMENT, NR. LOURD'S CONVENT SCHOOL,ATHWALINES,SURAT.

DRAWN BY VELSI REVISED BY --- CHECKED BY --- DRG NO --- PROJ NO 12PY24

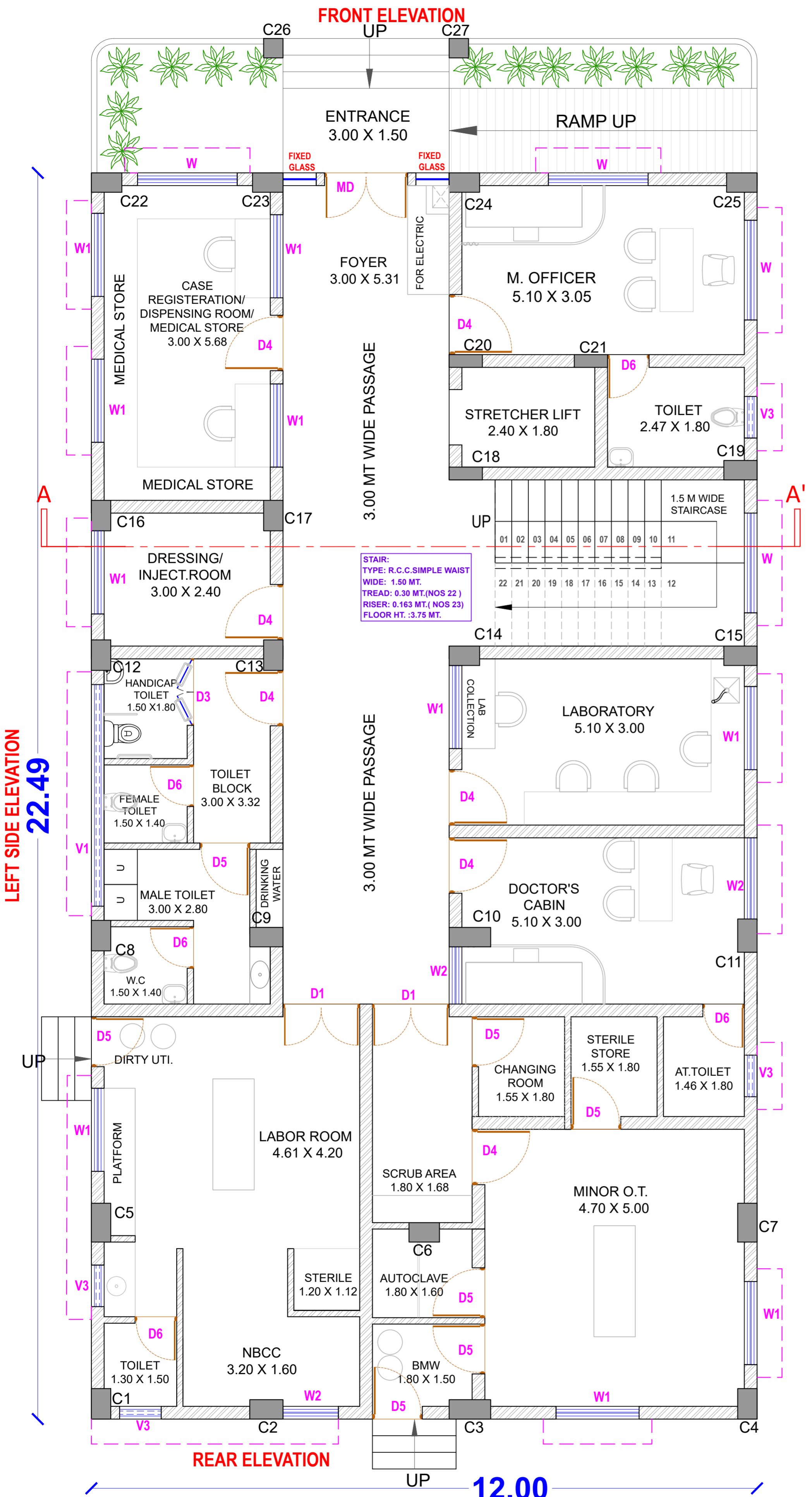

GROUND FLOOR PLAN

TOTAL PLOT AREA= 1076.53 SQ.MT

BUILT UP AREA CALCULATION

SR.NO	FLOOR	AREA	UNIT
01.	GROUND FLOOR	270.33	SQ.MT
02.	FIRST FLOOR	278.72	SQ.MT
03.	SECOND FLOOR	270.33	SQ.MT
04.	STAIR CABIN + LMR	67.04	SQ.MT
TOTAL BUILT UP AREA		886.42	SQ.MT

CONSTRUCTION OF NEW PRIMARY HEALTH CENTER-PHC AT KUMBHARWADA DIS.- BHAVNAGAR

COPY FOR ESTIMATE

CLIENT CONTRACTOR PMC/T.P.I.

ESTIMATE DRAWING

REVISION NOTES

NO. DATE REVISION DETAILS

R1

IMP NOTE:

SCHEDULE OF DOORS

SR NO.	NAME	SIZE (OPENING)	GR. FL.	1ST. FL.	2ND. FL.	TER. FL.	TOTAL	SILL	LINTEL	REMARK
1	MD	1.50 X 2.40	01	-	01	-	02	-	2.40	FLUSH DOOR
2	D1	1.385 X 2.40	02	-	-	-	02	-	2.40	FLUSH DOOR 2 SHUTTER
3	D2	1.35 X 2.40	-	02	-	-	02	-	2.40	FLUSH DOOR 2 SHUTTER
4	D3	1.20 X 2.10	01	01	01	-	03	-	2.10	PVC DOOR & ALUMN.FRAME
5	D4	1.00 X 2.40	07	05	02	02	14	-	2.40	FLUSH DOOR [FRP @ TER.LMR]
6	D5	0.90 X 2.40	07	02	03	-	12	-	2.40	FLUSH DOOR
7	D6	0.75 X 2.10	05	09	05	-	19	-	2.10	PVC DOOR & ALUMN.FRAME

SCHEDULE OF WINDOWS

SR NO.	NAME	SIZE (OPENING)	GR. FL.	1ST. FL.	2ND. FL.	TER. FL.	TOTAL	SILL	LINTEL	REMARK
1	W	1.80 X 1.50	04	08	08	-	20	0.90	2.40	3-TRACK SLIDING WINDOW
2	W1	1.50 X 1.50	10	07	07	-	24	0.90	2.40	3-TRACK SLIDING WINDOW
3	W2	1.00 X 1.50	03	-	-	-	03	0.90	2.40	2-TRACK SLIDING WINDOW
4	W3	0.75 X 1.50	03	-	-	-	03	0.90	2.40	2-TRACK SLIDING WINDOW

SCHEDULE OF VENTILATIONS

SR NO.	NAME	SIZE (OPENING)	GR. FL.	1ST. FL.	2ND. FL.	TER. FL.	TOTAL	SILL	LINTEL	REMARK
1	V1	4.00 X 0.90	01	01	01	-	03	-	LINTEL LEVEL	-
2	V2	1.50 X 0.90	-	02	01	-	03	-	LINTEL LEVEL	-
3	V3	0.75 X 0.90	04	01	01	-	06	-	LINTEL LEVEL	-

ISSUE STAMP

DEPUTY ENGINEER

EXECUTIVE/ CITY/ CHIEF ENGINEER

ARCHITECTURE/ ENGINEER
STRUCTURE CONSULTANT SIGNATURE

REVISION DATE : - DATE : - 21-10-2024

SCALE : - N.T.S. TYPE : - P.H.C.

FIRST FLOOR PLAN

AGENCY -

CLIENT - BHAVNAGAR MUNICIPAL CORPORATION(BMC)

PROJECT:-
CONSTRUCTION OF NEW PRIMARY HEALTH CENTER-PHC
AT KUMBHARWADA DIS.- BHAVNAGAR

JAYESH A DALAL
Planning & Engineering Services Pvt Ltd

DRAWN BY REVISED BY CHECKED BY DRG NO PROJ NO
VELSI --- --- --- 12PY24

FRONT ELEVATION

ENTRANCE CANOPY

LEFT SIDE ELEVATION
22.49

RIGHT SIDE ELEVATION

REAR ELEVATION

FIRST FLOOR PLAN

TOTAL PLOT AREA= 1076.53 SQ.MT

BUILT UP AREA CALCULATION

SR.NO	FLOOR	AREA	UNIT
01.	GROUND FLOOR	270.33	SQ.MT
02.	FIRST FLOOR	278.72	SQ.MT
03.	SECOND FLOOR	270.33	SQ.MT
04.	STAIR CABIN + LMR	67.04	SQ.MT
TOTAL BUILT UP AREA		886.42	SQ.MT

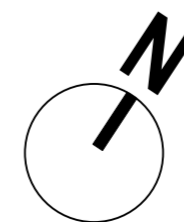

CONSTRUCTION OF NEW PRIMARY HEALTH CENTER-PHC AT KUMBHARWADA DIS.- BHAVNAGAR

COPY FOR ESTIMATE

CLIENT CONTRACTOR PMC/T.P.I.

ESTIMATE DRAWING

REVISION NOTES

NO.	DATE	REVISION DETAILS
R1		

IMP NOTE:

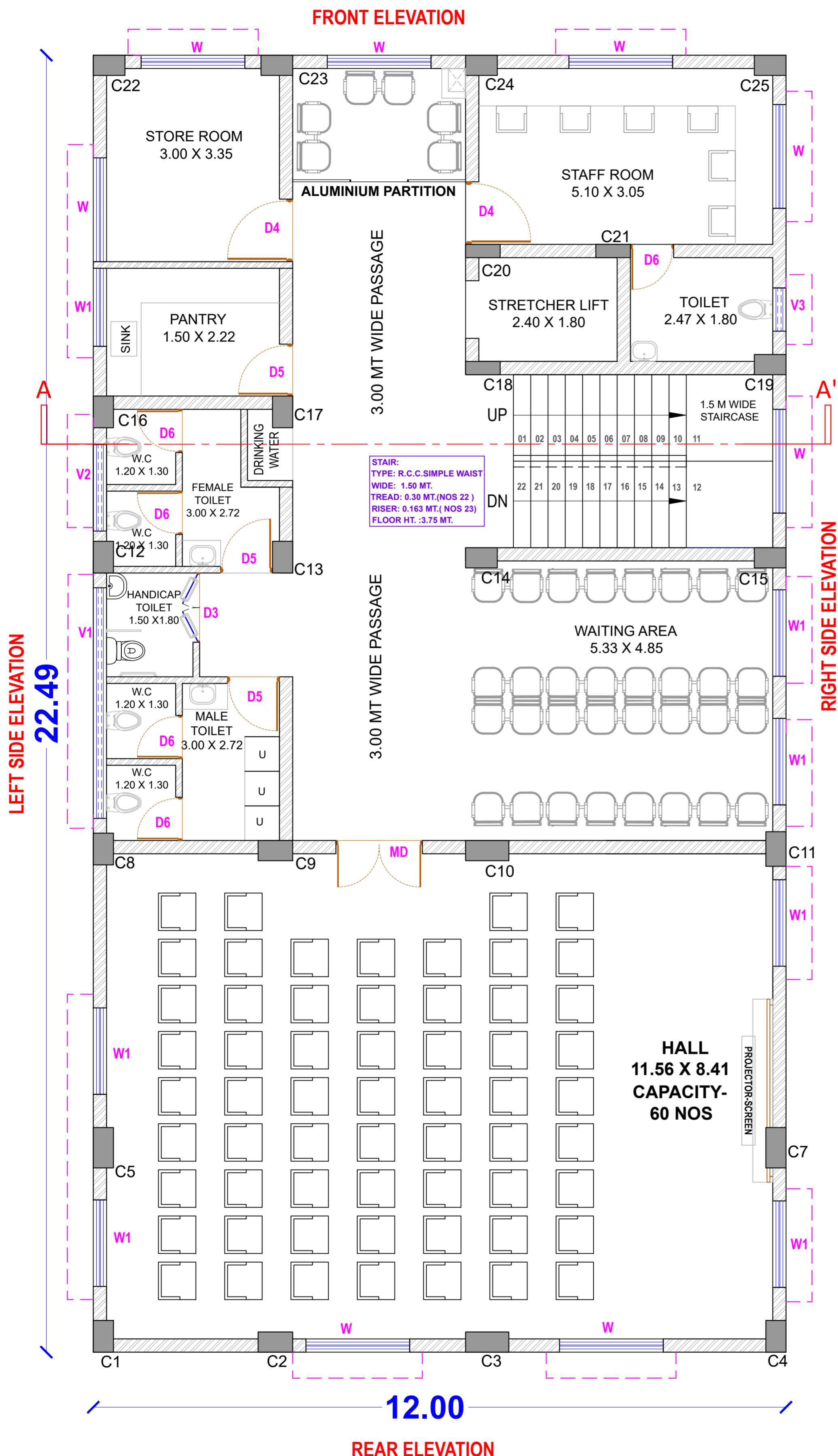

SCHEDULE OF DOORS

SR NO.	NAME	SIZE (OPENING)	GR. FL.	1ST. FL.	2ND. FL.	TER. FL.	TOTAL	SILL	LINTEL	REMARK
1	MD	1.50 X 2.40	01	-	01	-	02	-	2.40	FLUSH DOOR
2	D1	1.385 X 2.40	02	-	-	-	02	-	2.40	FLUSH DOOR 2 SHUTTER
3	D2	1.35 X 2.40	-	02	-	-	02	-	2.40	FLUSH DOOR 2 SHUTTER
4	D3	1.20 X 2.10	01	01	01	-	03	-	2.10	PVC DOOR & ALUMN.FRAME
5	D4	1.00 X 2.40	07	05	02	02	14	-	2.40	FLUSH DOOR [FRP @ TER.LMR]
6	D5	0.90 X 2.40	07	02	03	-	12	-	2.40	FLUSH DOOR
7	D6	0.75 X 2.10	05	09	05	-	19	-	2.10	PVC.DOOR & ALUMN.FRAME

SCHEDULE OF WINDOWS

SR NO.	NAME	SIZE (OPENING)	GR. FL.	1ST. FL.	2ND. FL.	TER. FL.	TOTAL	SILL	LINTEL	REMARK
1	W	1.80 X 1.50	04	08	08	-	20	0.90	2.40	3-TRACK SLIDING WINDOW
2	W1	1.50 X 1.50	10	07	07	-	24	0.90	2.40	3-TRACK SLIDING WINDOW
3	W2	1.00 X 1.50	03	-	-	-	03	0.90	2.40	2-TRACK SLIDING WINDOW
4	W3	0.75 X 1.50	03	-	-	-	03	0.90	2.40	2-TRACK SLIDING WINDOW

SCHEDULE OF VENTILATIONS

SR NO.	NAME	SIZE (OPENING)	GR. FL.	1ST. FL.	2ND. FL.	TER. FL.	TOTAL	SILL	LINTEL	REMARK
1	V1	4.00 X 0.90	01	01	01	-	03	-	-	LINTEL LEVEL
2	V2	1.50 X 0.90	-	02	01	-	03	-	-	LINTEL LEVEL
3	V3	0.75 X 0.90	04	01	01	-	06	-	-	LINTEL LEVEL

ISSUE STAMP

DEPUTY ENGINEER

EXECUTIVE/ CITY/ CHIEF ENGINEER

ARCHITECTURE/ ENGINEER
STRUCTURE CONSULTANT SIGNATURE

REVISION DATE : - DATE : - 21-10-2024
SCALE : - N.T.S. TYPE : - P.H.C.

SECOND FLOOR PLAN

AGENCY -

CLIENT - BHAVNAGAR MUNICIPAL CORPORATION(BMC)

PROJECT:-
CONSTRUCTION OF NEW PRIMARY HEALTH CENTER-PHC
AT KUMBHARWADA DIS.- BHAVNAGAR

JAYESH A DALAL
Planning & Engineering Services Pvt Ltd



DRAWN BY VELSI REVISED BY --- CHECKED BY --- DRG NO --- PROJ NO 12PY24

TOTAL PLOT AREA= 1076.53 SQ.MT

BUILT UP AREA CALCULATION

SR.NO	FLOOR	AREA	UNIT
01.	GROUND FLOOR	270.33	SQ.MT
02.	FIRST FLOOR	278.72	SQ.MT
03.	SECOND FLOOR	270.33	SQ.MT
04.	STAIR CABIN + LMR	67.04	SQ.MT
TOTAL BUILT UP AREA		886.42	SQ.MT

REAR ELEVATION
SECOND FLOOR PLAN

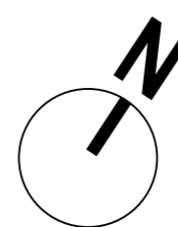

CONSTRUCTION OF NEW PRIMARY HEALTH CENTER-PHC AT KUMBHARWADA DIS.- BHAVNAGAR

COPY FOR ESTIMATE

CLIENT CONTRACTOR PMC/T.P.I.

ESTIMATE DRAWING

REVISION NOTES

NO. DATE REVISION DETAILS

R1

IMP NOTE:

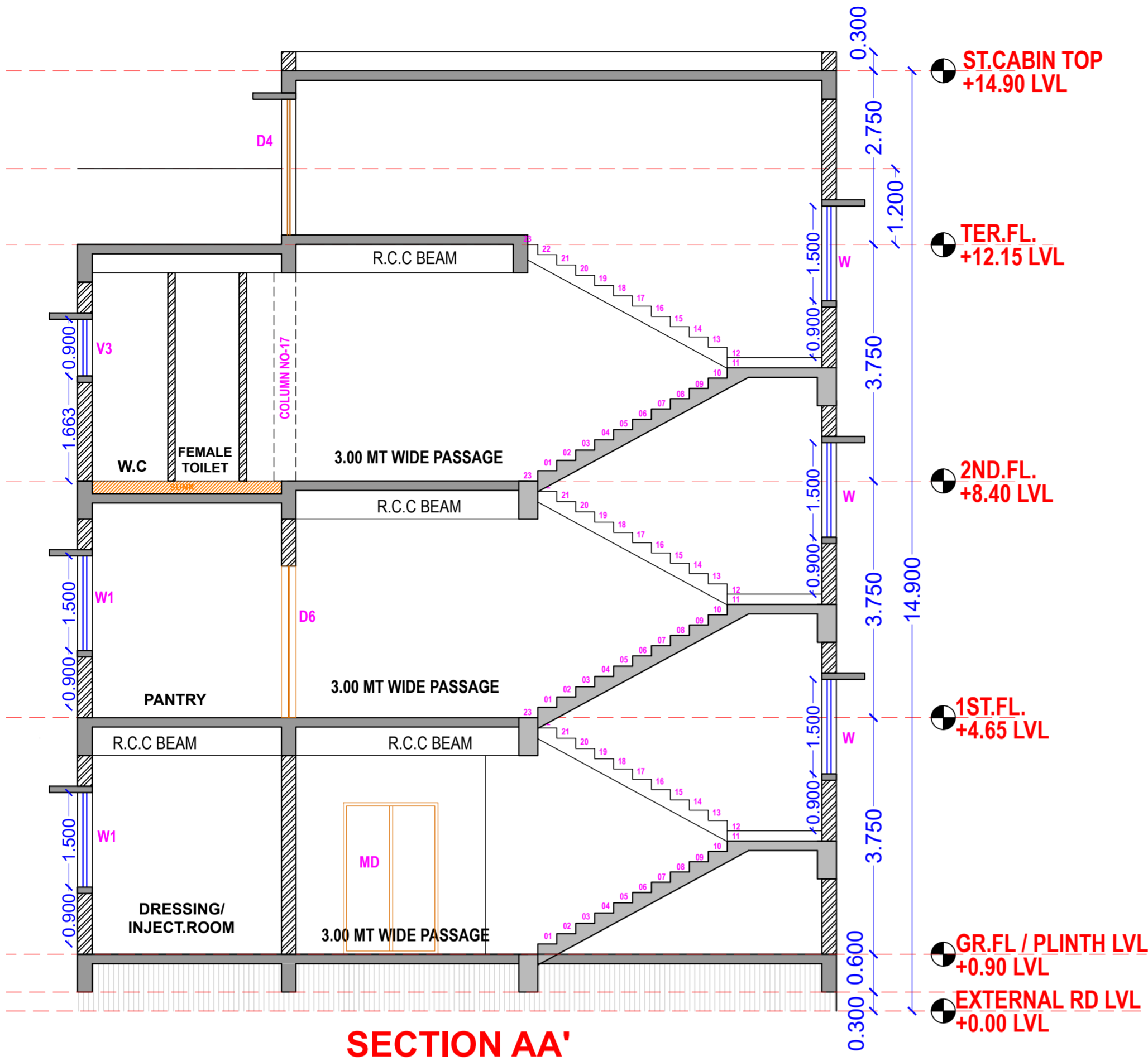

SECTION AA'

SCHEDULE OF DOORS

SR NO.	NAME	SIZE (OPENING)	GR. FL.	1ST. FL.	2ND. FL.	TER. FL.	TOTAL	SILL	LINTEL	REMARK
1	MD	1.50 X 2.40	01	-	01	-	02	-	2.40	FLUSH DOOR
2	D1	1.385 X 2.40	02	-	-	-	02	-	2.40	FLUSH DOOR 2 SHUTTER
3	D2	1.35 X 2.40	-	02	-	-	02	-	2.40	FLUSH DOOR 2 SHUTTER
4	D3	1.20 X 2.10	01	01	01	-	03	-	2.10	PVC DOOR & ALUMN.FRAME
5	D4	1.00 X 2.40 1.00 X 2.10	07	05	02	-	14	02	2.10	FLUSH DOOR [FRP @ TER.LMR]
6	D5	0.90 X 2.40	07	02	03	-	12	-	2.40	FLUSH DOOR
7	D6	0.75 X 2.10	05	09	05	-	19	-	2.10	PVC.DOOR & ALUMN.FRAME

SCHEDULE OF WINDOWS

SR NO.	NAME	SIZE (OPENING)	GR. FL.	1ST. FL.	2ND. FL.	TER. FL.	TOTAL	SILL	LINTEL	REMARK
1	W	1.80 X 1.50	04	08	08	-	20	0.90	2.40	3-TRACK SLIDING WINDOW
2	W1	1.50 X 1.50	10	07	07	-	24	0.90	2.40	3-TRACK SLIDING WINDOW
3	W2	1.00 X 1.50	03	-	-	-	03	0.90	2.40	2-TRACK SLIDING WINDOW
4	W3	0.75 X 1.50	03	-	-	-	03	0.90	2.40	2-TRACK SLIDING WINDOW

SCHEDULE OF VENTILATIONS

SR NO.	NAME	SIZE (OPENING)	GR. FL.	1ST. FL.	2ND. FL.	TER. FL.	TOTAL	SILL	LINTEL	REMARK
1	V1	4.00 X 0.90	01	01	01	-	03	-	-	LINTEL LEVEL
2	V2	1.50 X 0.90	-	02	01	-	03	-	-	LINTEL LEVEL
3	V3	0.75 X 0.90	04	01	01	-	06	-	-	LINTEL LEVEL

ISSUE STAMP

DEPUTY ENGINEER

EXECUTIVE/ CITY/ CHIEF ENGINEER

ARCHITECTURE/ ENGINEER
STRUCTURE CONSULTANT SIGNATURE

REVISION DATE : - DATE : - 21-10-2024

SCALE : - N.T.S. TYPE : - P.H.C.

FRONT ELEVATION AND SECTION-AA'

AGENCY -

CLIENT - BHAVNAGAR MUNICIPAL CORPORATION(BMC)

PROJECT:-
CONSTRUCTION OF NEW PRIMARY HEALTH CENTER-PHC
AT KUMBHARWADA DIS.- BHAVNAGAR

JAYESH A DALAL

Planning & Engineering Services Pvt Ltd

JALARAM SHAKTI, BESIDE DHAWALGIRI APARTMENT, NR.LOURDS CONVENT SCHOOL,ATHWALINES,SURAT.



DRAWN BY VELSI REVISED BY --- CHECKED BY --- DRG NO --- PROJ NO 12PY24

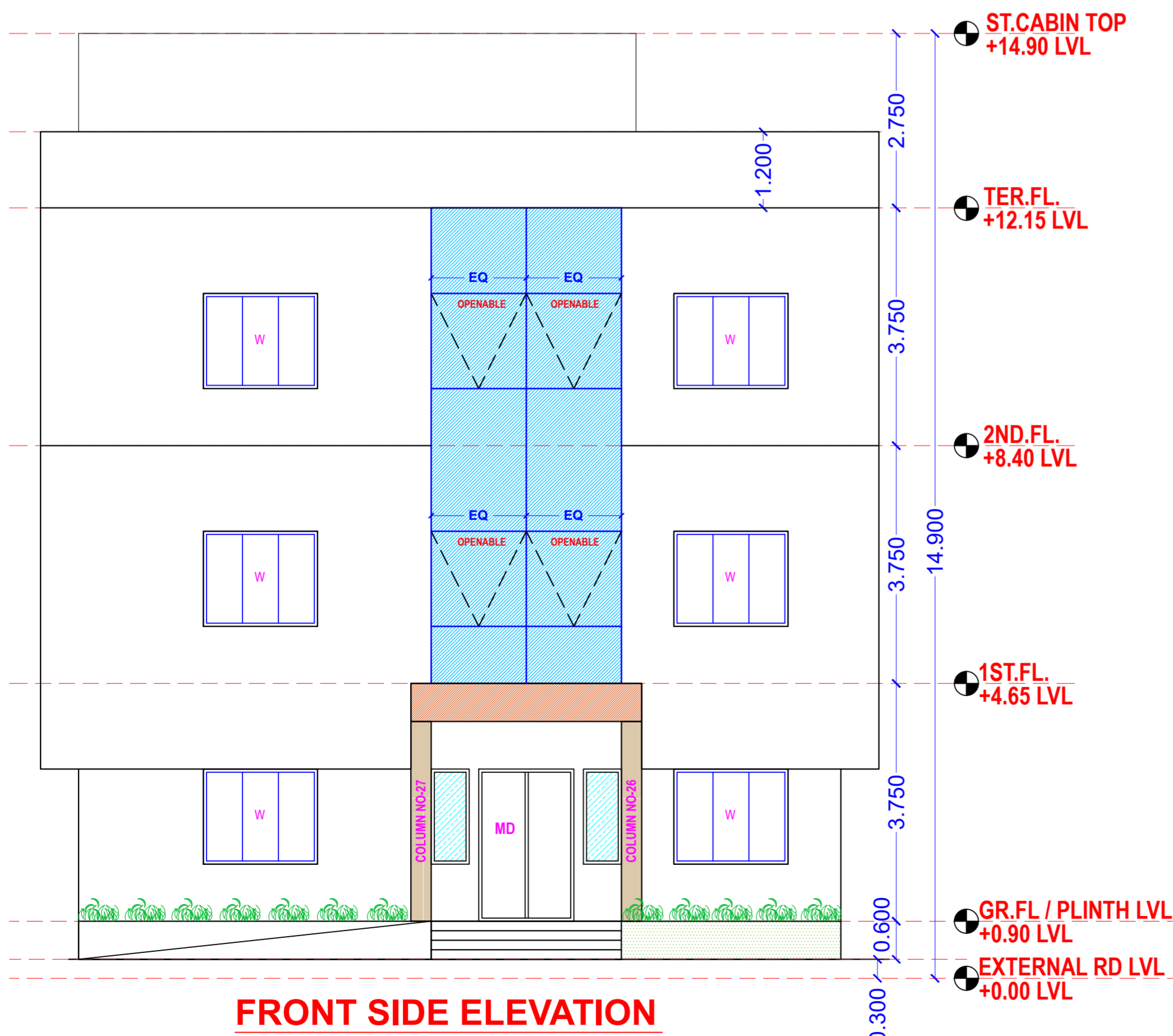

FRONT SIDE ELEVATION

CONSTRUCTION OF NEW PRIMARY HEALTH CENTER-PHC AT KUMBHARWADA DIS.- BHAVNAGAR

COPY FOR ESTIMATE

CLIENT	CONTRACTOR	PMC/T.P.I.

REVISION NOTES

NO.	DATE	REVISION DETAILS
R1		

NOTE :-

- * CONCRETE GRADE : M25
- * STEEL GRADE: Fe500
- * P.C.C. THIKNESS 100 MM (1:2:4)
- * GRADE SLAB 100MM THIK. (1:2:4)
- * SBC CONSIDERED 18 T/SQ. MT AT DEPTH OF 2.5 MT FROM EGL AS PER REPORT NUMBER SMTL/S-2912/SBC-78/2024-25 DATED ON 15-10-2024.
- * ALL DIMENSION ARE IN MM UNLESS OTHERWISE SPECIFIED.

ISSUE STAMP

DEPUTY ENGINEER

EXECUTIVE/ CITY/ CHIEF ENGINEER

ARCHITECTURE/ ENGINEER
STRUCTURE CONSULTANT SIGNATURE

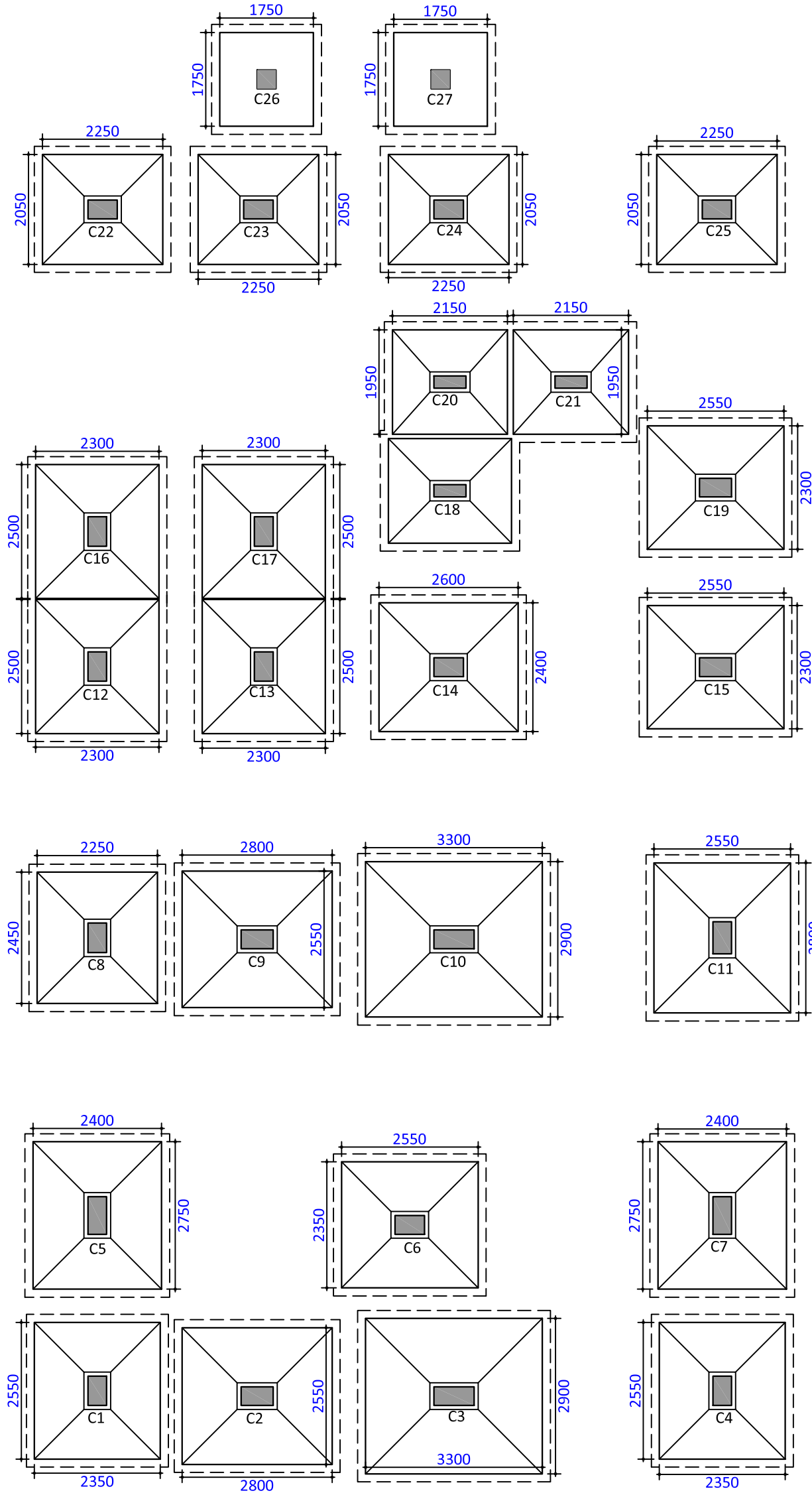

FOOTING SCHEDULE

FOOTING	D/d	725/300	600/300	1025/300	825/300	775/300	750/300	850/300
	RCC	2550 x 2350	2100 x 1900	3300 x 2900	2750 x 2400	2550 x 2350	2450 x 2250	2800 x 2550
	PCC	2850 x 2650	2400 x 2200	3600 x 3200	3050 x 2700	2850 x 2650	2750 x 2550	3100 x 2850
COLUMNS		C1, C4	C2	C3, C10	C5, C7	C6	C8	C9, C11
FOOTING	D/d	775/300	800/300	775/300	675/300	700/300	675/300	300
	RCC	2500 x 2300	2600 x 2400	2550 x 2300	2300 x 1950	2150 x 1950	2250 x 2050	1750 x 1750
	PCC	2800 x 2600	2900 x 2700	2850 x 2600	2600 x 2250	2450 x 2250	2550 x 2350	2050 x 2050
COLUMNS		C12, C13, C16, C17	C14	C15, C19	C18	C20, C21	C22, C23, C24, C25	C26, C27

COLUMN SCHEDULE

SC TOP TO TERRACE SLAB	---	---	---	---	---	350 X 550	350 X 600	230 X 600	---
TERRACE SLAB TO 2ND SLAB	350 X 550	350 X 750	350 X 700	---	---	350 X 550	350 X 600	230 X 600	---
2ND SLAB TO 1ST SLAB	350 X 550	350 X 750	350 X 700	350 X 550	350 X 600	350 X 550	350 X 600	230 X 600	---
1ST SLAB TO GB	350 X 550	350 X 750	350 X 700	350 X 550	350 X 600	350 X 550	350 X 600	230 X 600	350 X 350
GB TO FOUNDATION	350 X 550	350 X 750	350 X 700	350 X 550	350 X 600	350 X 550	350 X 600	230 X 600	350 X 350
COLUMN MARKED	C1, C2, C4, C8, C12, C16, C22, C23, C24, C25	C3, C10	C5, C7	C6	C9, C11	C13, C14, C17	C15, C19	C18, C20, C21	C26, C27

REVISION DATE :-	DATE :- 14-10-2024
SCALE :- N.T.S.	TYPE :- P.H.C.

FOUNDATION DETAIL AND COLUMN SCHEDULE

AGENCY -	
CLIENT - BHAVNAGAR MUNICIPAL CORPORATION(BMC)	

PROJECT:-
CONSTRUCTION OF NEW PRIMARY HEALTH CENTER-PHC AT KUMBHARWADA DIS.- BHAVNAGAR

JAYESH A DALAL
Planning & Engineering Services Pvt Ltd
"SALAM SHANTI" BESIDE CHAWALGIRI APARTMENT, HILCOURT'S CONVENT SCHOOL, ATHVALNES, SURAT.

DRAWN BY	REVISED BY	CHECKED BY	DRG NO	PROJ NO
VRUTIKA	---	---	FO-01	12PY24

CONSTRUCTION OF NEW PRIMARY HEALTH CENTER-PHC AT KUMBHARWADA DIS.- BHAVNAGAR

COPY FOR ESTIMATE

CLIENT	CONTRACTOR	PMC/T.P.I.

REVISION NOTES

NO.	DATE	REVISION DETAILS
R1		

NOTE :-

- * CONCRETE GRADE : M25
- * STEEL GRADE: Fe500
- * P.C.C. THICKNESS 100 MM (1:2:4)
- * GRADE SLAB 100MM THIK. (1:2:4)
- * ALL DIMENSION ARE IN MM UNLESS OTHERWISE SPECIFIED.

ISSUE STAMP

DEPUTY ENGINEER

EXECUTIVE/ CITY/ CHIEF ENGINEER

ARCHITECTURE/ ENGINEER
STRUCTURE CONSULTANT SIGNATURE

REVISION DATE : -	DATE : - 14-10-2024
SCALE : - N.T.S.	TYPE : - P.H.C.

GROUND BEAM

AGENCY -

CLIENT - BHAVNAGAR MUNICIPAL CORPORATION(BMC)

PROJECT:-
CONSTRUCTION OF NEW PRIMARY HEALTH CENTER-PHC
AT KUMBHARWADA DIS.- BHAVNAGAR

JAYESH A DALAL
Planning & Engineering Services Pvt Ltd

*JALARAM SHAKTI, BESIDE CHAWALGIRI APARTMENT, NR.LOURD'S CONVENT SCHOOL,ATHWALNES,SURAT.



DRAWN BY	REVISED BY	CHECKED BY	DRG NO	PROJ NO
VRUTIKA	---	---	GB-02	12PY24

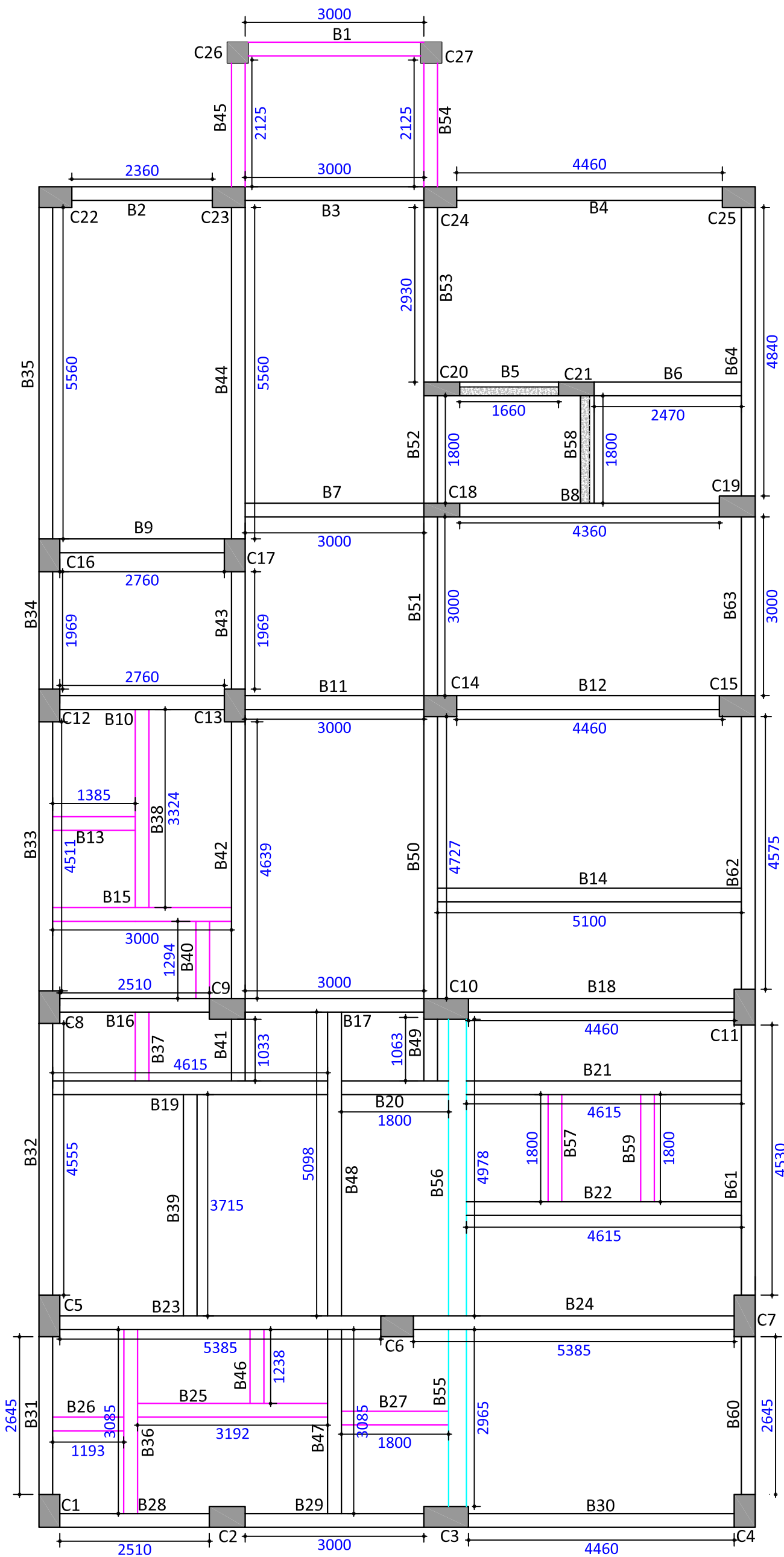

LEGENDS	
	230 X 600
	230 X 450
	300 X 600

CONSTRUCTION OF NEW PRIMARY HEALTH CENTER-PHC AT KUMBHARWADA DIS.- BHAVNAGAR

COPY FOR ESTIMATE

CLIENT	CONTRACTOR	PMC/T.P.I.

REVISION NOTES

NO.	DATE	REVISION DETAILS
R1		

NOTE :-

- * CONCRETE GRADE : M25
- * STEEL GRADE: Fe500
- * P.C.C. THICKNESS 100 MM (1:2:4)
- * GRADE SLAB 100MM THIK. (1:2:4)
- * ALL DIMENSION ARE IN MM UNLESS OTHERWISE SPECIFIED.

ISSUE STAMP

DEPUTY ENGINEER

EXECUTIVE/ CITY/ CHIEF ENGINEER

ARCHITECTURE/ ENGINEER
STRUCTURE CONSULTANT SIGNATURE

REVISION DATE : -	DATE : - 14-10-2024
SCALE : - N.T.S.	TYPE : - P.H.C.

FIRST SLAB BEAM

AGENCY -

CLIENT - BHAVNAGAR MUNICIPAL CORPORATION(BMC)

PROJECT:-
CONSTRUCTION OF NEW PRIMARY HEALTH CENTER-PHC
AT KUMBHARWADA DIS.- BHAVNAGAR

JAYESH A DALAL

Planning & Engineering Services Pvt Ltd

*JALARAM SHAKTI, BESIDE CHAWALGIRI APARTMENT, NR.LORDS CONVENT SCHOOL,ATHWALNES,SURAT.



DRAWN BY	REVISED BY	CHECKED BY	DRG NO	PROJ NO
VRUTIKA	---	---	FS-03	12PY24

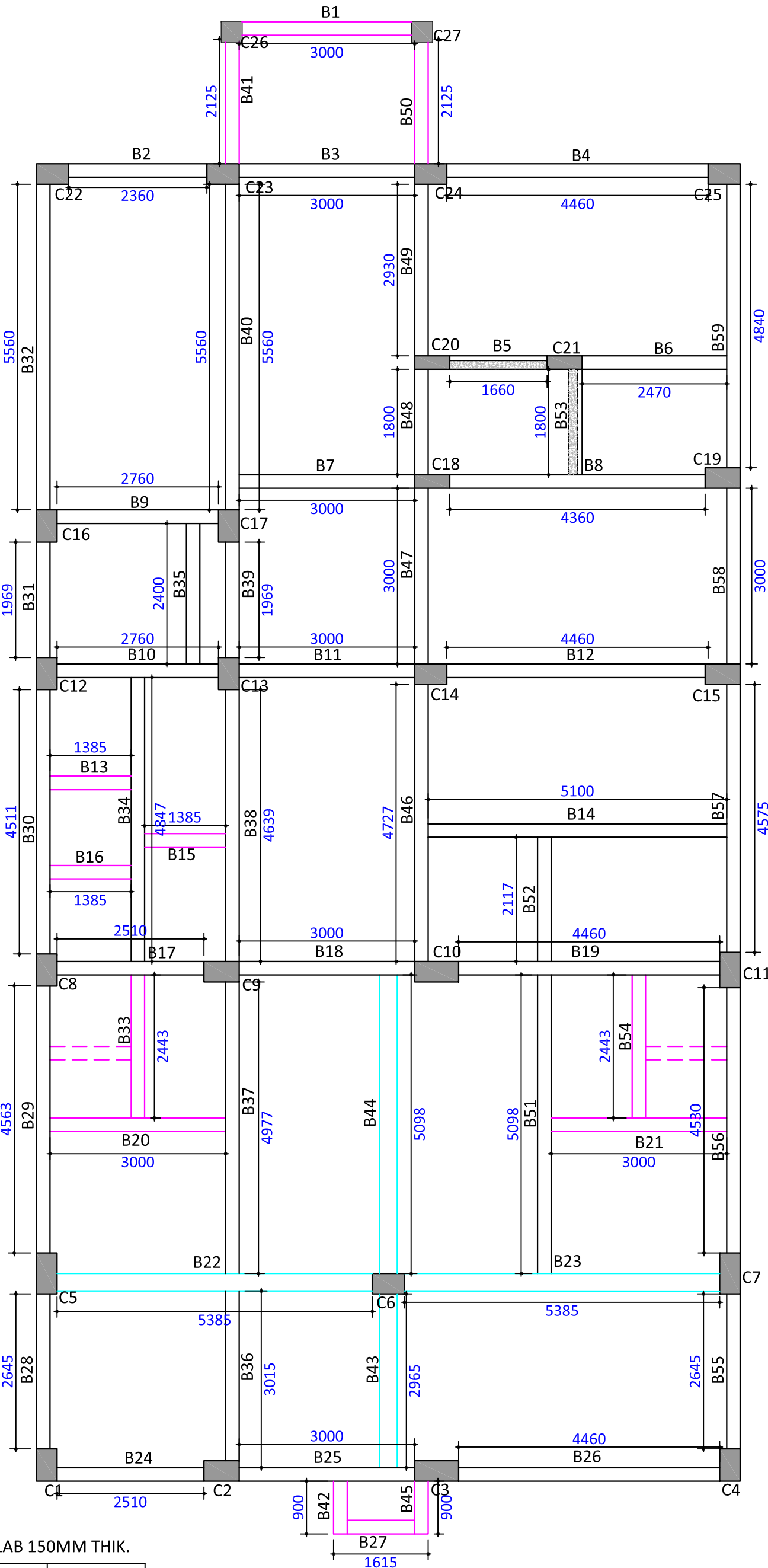

* ALL SLAB 150MM THIK.

LEGENDS	
	230 X 600
	230 X 450
	300 X 600

CONSTRUCTION OF NEW PRIMARY HEALTH CENTER-PHC AT KUMBHARWADA DIS.- BHAVNAGAR

COPY FOR ESTIMATE

CLIENT	CONTRACTOR	PMC/T.P.I.

REVISION NOTES

NO.	DATE	REVISION DETAILS
R1		

NOTE :-

- * CONCRETE GRADE : M25
- * STEEL GRADE: Fe500
- * P.C.C. THICKNESS 100 MM (1:2:4)
- * GRADE SLAB 100MM THIK. (1:2:4)
- * ALL DIMENSION ARE IN MM UNLESS OTHERWISE SPECIFIED.

ISSUE STAMP

DEPUTY ENGINEER

EXECUTIVE/ CITY/ CHIEF ENGINEER

ARCHITECTURE/ ENGINEER
STRUCTURE CONSULTANT SIGNATURE

REVISION DATE : -	DATE : - 14-10-2024
SCALE : - N.T.S.	TYPE : - P.H.C.

SECOND SLAB BEAM

AGENCY -

CLIENT - BHAVNAGAR MUNICIPAL CORPORATION(BMC)

PROJECT:-
CONSTRUCTION OF NEW PRIMARY HEALTH CENTER-PHC
AT KUMBHARWADA DIS.- BHAVNAGAR

JAYESH A DALAL

Planning & Engineering Services Pvt Ltd

*JALARAM SHAKTI, BESIDE DHAWALGIRI APARTMENT, NR.LOURDS CONVENT SCHOOL,ATHWALNES,SURAT.



DRAWN BY	REVISED BY	CHECKED BY	DRG NO	PROJ NO
VRUTIKA	---	---	SS-04	12PY24

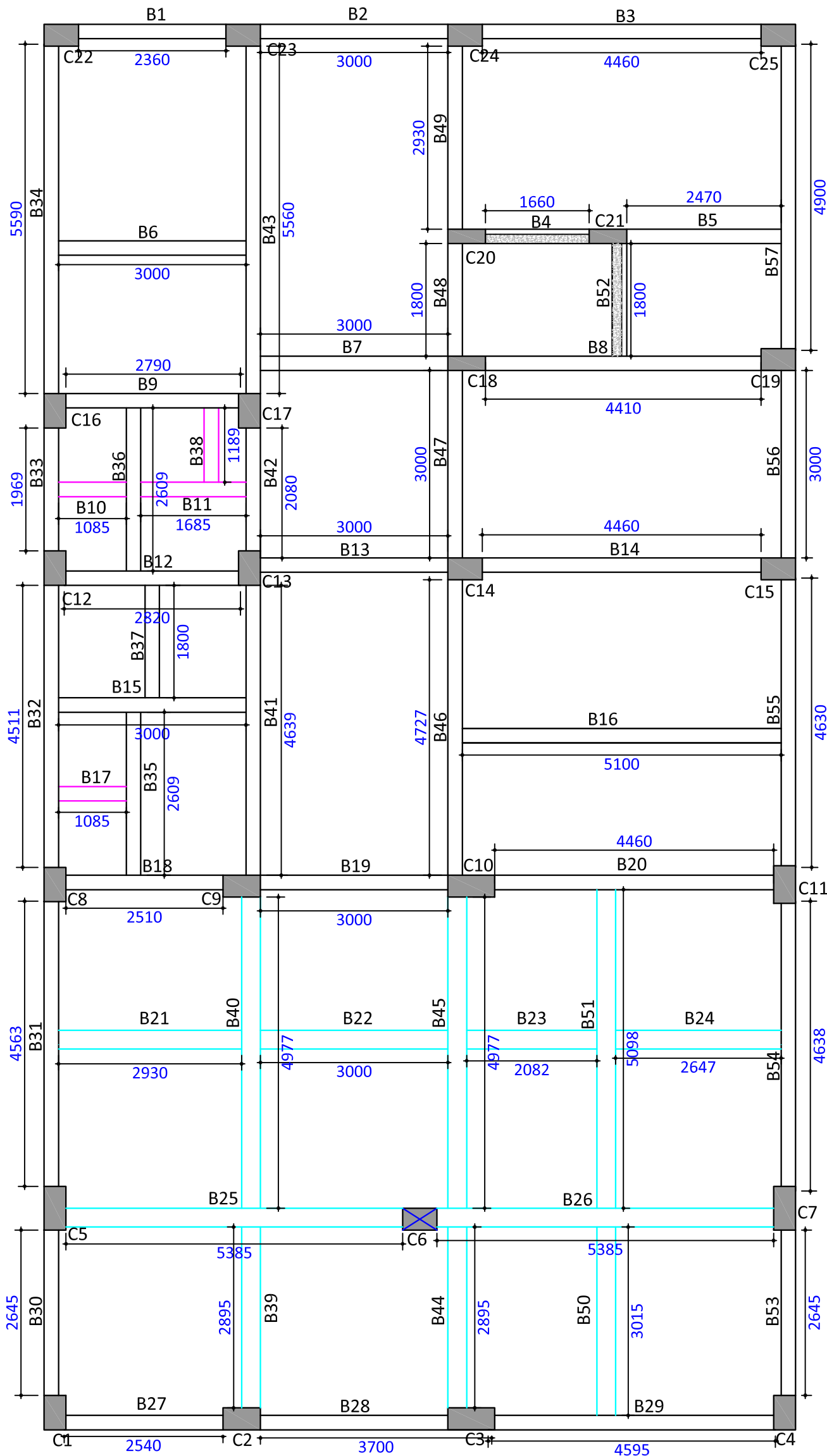

* ALL SLAB 150MM THIK.

LEGENDS	
	230 X 600
	230 X 450
	300 X 600

CONSTRUCTION OF NEW PRIMARY HEALTH CENTER-PHC AT KUMBHARWADA DIS.- BHAVNAGAR

COPY FOR ESTIMATE

CLIENT	CONTRACTOR	PMC/T.P.I.

REVISION NOTES

NO.	DATE	REVISION DETAILS
R1		

NOTE :-

- * CONCRETE GRADE : M25
- * STEEL GRADE: Fe500
- * P.C.C. THICKNESS 100 MM (1:2:4)
- * GRADE SLAB 100MM THIK. (1:2:4)
- * ALL DIMENSION ARE IN MM UNLESS OTHERWISE SPECIFIED.

ISSUE STAMP

DEPUTY ENGINEER

EXECUTIVE/ CITY/ CHIEF ENGINEER

**ARCHITECTURE/ ENGINEER
STRUCTURE CONSULTANT SIGNATURE**

REVISION DATE : -	DATE : - 14-10-2024
SCALE : - N.T.S.	TYPE : - P.H.C.

TERRACE SLAB BEAM

AGENCY -

CLIENT - BHAVNAGAR MUNICIPAL CORPORATION(BMC)

PROJECT:-
CONSTRUCTION OF NEW PRIMARY HEALTH CENTER-PHC
AT KUMBHARWADA DIS.- BHAVNAGAR

JAYESH A DALAL

Planning & Engineering Services Pvt Ltd

*JALARAM SHAKTI, BESIDE DHAWALGIRI APARTMENT, NR.LOURD'S CONVENT SCHOOL,ATHWALNES,SURAT.



DRAWN BY	REVISED BY	CHECKED BY	DRG NO	PROJ NO
VRUTIKA	---	---	TS-05	12PY24

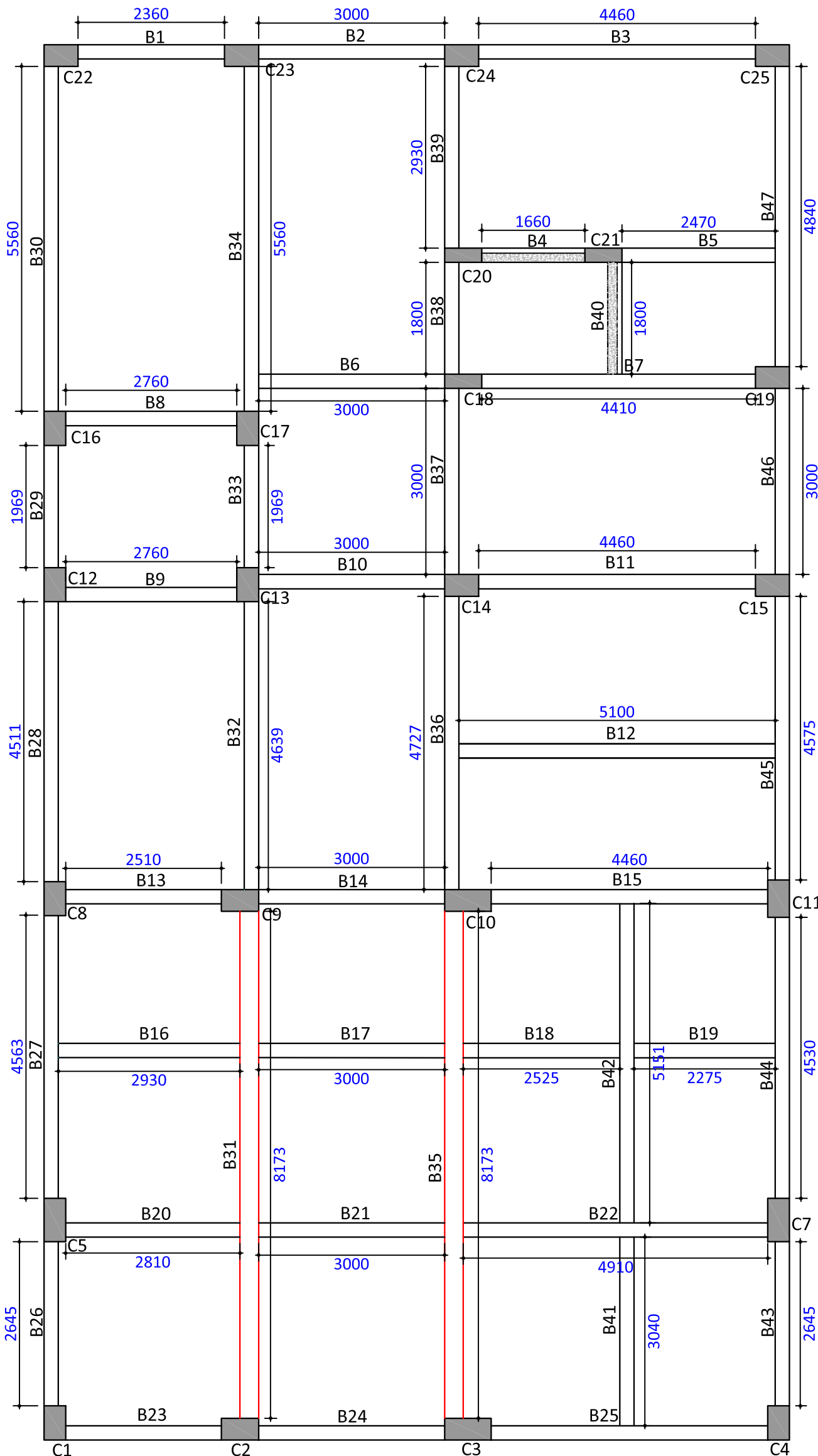

* ALL SLAB 150MM THIK.

LEGENDS	
	230 X 600
	230 X 450
	300 X 600
	300 X 650

CONSTRUCTION OF NEW PRIMARY HEALTH CENTER-PHC AT KUMBHARWADA DIS.- BHAVNAGAR

COPY FOR ESTIMATE

CLIENT	CONTRACTOR	PMC/T.P.I.

REVISION NOTES

NO.	DATE	REVISION DETAILS
R1		

NOTE :-

- * CONCRETE GRADE : M25
- * STEEL GRADE: Fe500
- * P.C.C. THICKNESS 100 MM (1:2:4)
- * GRADE SLAB 100MM THIK. (1:2:4)
- * ALL DIMENSION ARE IN MM UNLESS OTHERWISE SPECIFIED.

ISSUE STAMP

DEPUTY ENGINEER

EXECUTIVE/ CITY/ CHIEF ENGINEER

ARCHITECTURE/ ENGINEER
STRUCTURE CONSULTANT SIGNATURE

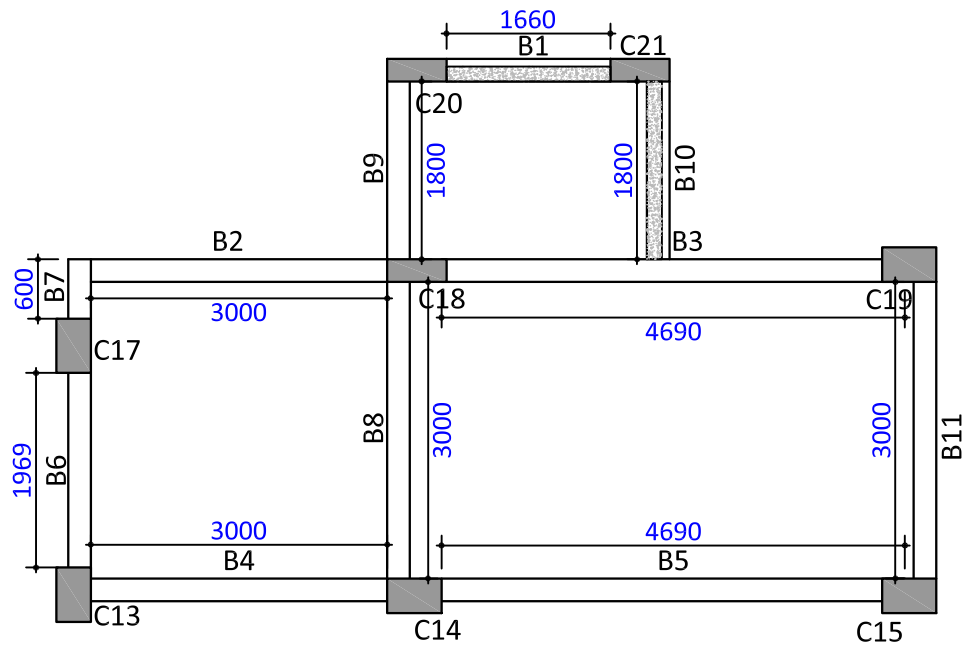

* ALL SLAB 150MM THIK.

LEGENDS	
	230 X 600
	230 X 450
	300 X 600

REVISION DATE : -	DATE : - 14-10-2024
SCALE : - N.T.S.	TYPE : - P.H.C.

STAIR CABIN AND MRL TOP SLAB BEAM

AGENCY -

CLIENT - BHAVNAGAR MUNICIPAL CORPORATION(BMC)

PROJECT:-
CONSTRUCTION OF NEW PRIMARY HEALTH CENTER-PHC
AT KUMBHARWADA DIS.- BHAVNAGAR

JAYESH A DALAL

Planning & Engineering Services Pvt Ltd

*JALARAM SHAKTI, BESIDE DHAWALGIRI APARTMENT, NR.LLORDS CONVENT SCHOOL,ATHWALNES,SURAT.



DRAWN BY	REVISED BY	CHECKED BY	DRG NO	PROJ NO
VRUTIKA	---	---	LS-06	12PY24

CONSTRUCTION OF NEW PRIMARY HEALTH CENTER-PHC AT KUMBHARWADA DIS.- BHAVNAGAR

COPY FOR TENDER

CLIENT	CONTRACTOR	PMC/T.P.I.

TENDER DRAWING

REVISION NOTES

NO.	DATE	REVISION DETAILS

SYMBOL	DESCRIPTION
	BRACKET STREET LIGHT FITTING
	STREET LIGHT POLE FITTING
	BULLET CAMERA

ISSUE STAMP

DEPUTY ENGINEER

EXECUTIVE/ CITY/ CHIEF ENGINEER

ARCHITECTURE/ ENGINEER
STRUCTURE CONSULTANT SIGNATURE

REVISION DATE : -	DATE : - 29-08-2024
SCALE : - N.T.S.	TYPE : - P.H.C.

MASTER LAYOUT PLAN

AGENCY -

CLIENT - BHAVNAGAR MUNICIPAL CORPORATION(BMC)

PROJECT:-
CONSTRUCTION OF NEW PRIMARY HEALTH CENTER-PHC
AT KUMBHARWADA DIS.- BHAVNAGAR

JAYESH A DALAL
Planning & Engineering Services Pvt Ltd
*JALARAM SHAKTI, BESIDE DHAWALGIRI APARTMENT, N.R.LOURD'S CONVENT SCHOOL,ATHWALINES,SURAT.

DRAWN BY	REVISED BY	CHECKED BY	DRG NO	PROJ NO
VELSI	---	---	---	12PY24

EXISTING ROAD

12.00 MT WIDE APPROACH ROAD

MAIN ENTRY

MAIN EXIT

LANDSCAPED GARDEN
11.72 X 4.30

4.50 MT WIDE INTERNAL ROAD

4.50 MT WIDE INTERNAL ROAD

4.50 MT WIDE INTERNAL ROAD

4.50 MT WIDE INTERNAL ROAD

2 WHEELER PARKING
21-NOS

GREEN AREA

4 WHEELER PARKING
06-NOS

GREEN AREA

GREEN AREA

2 WHEELER PARKING
18-NOS

OPTION 1 - SITE LAYOUT PLAN

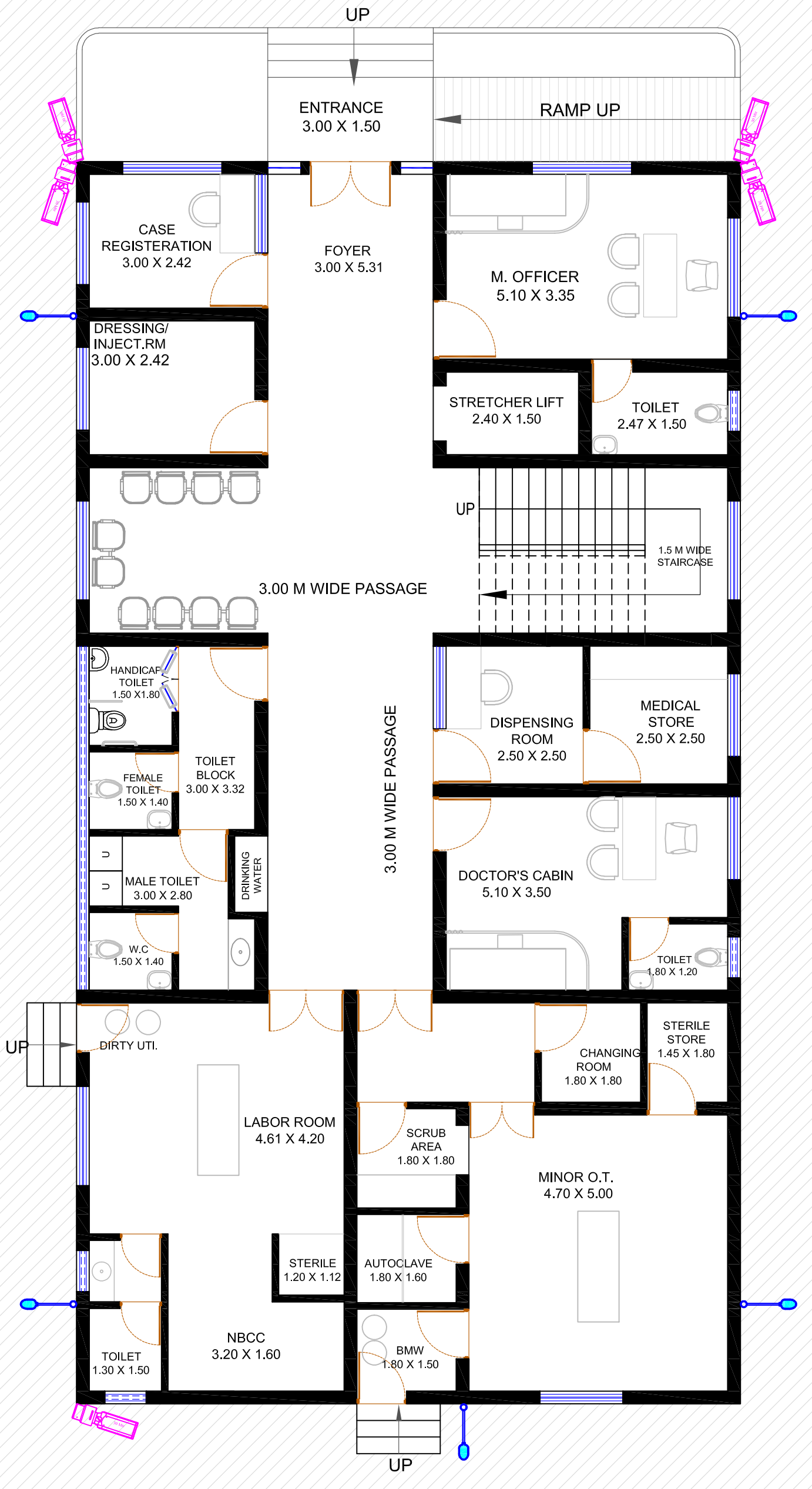
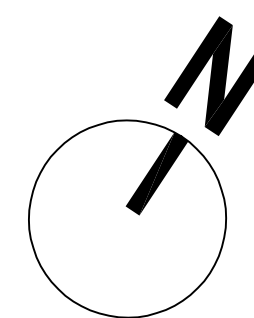

CLIENT	CONTRACTOR	PMC/T.P.I.

TENDER DRAWING

REVISION NOTES

NO.	DATE	REVISION DETAILS
R1		

SYMBOL	DESCRIPTION	MOUNTING HEIGHT
	LIGHTING DISTRIBUTION BOARD(LDB)	2100mm
	6A SWITCH SOCKET OUTLET	1500mm
	SWITCH BOARDS	1200mm
	6 A / 16 A LOOPED PLUG POINT	1200mm
	15A SWITCH SOCKET OUTLET	1200mm
	TUBE LIGHT ON CEILING	CEILING
	TUBE LIGHT ON WALL	2100mm
	18W BRACKET LIGHT	2100mm
	48 " Ø CEILING FAN	CEILING
	SMOKE DETECTOR	CEILING
	EXHAUST FAN	-
	BULLET CCTV CAMERA	-
	DOME CCTV CAMERA	-

ISSUE STAMP

DEPUTY ENGINEER

EXECUTIVE/ CITY/ CHIEF ENGINEER

ARCHITECTURE/ ENGINEER
STRUCTURE CONSULTANT SIGNATURE

REVISION DATE : -	DATE : - 21-10-2024
SCALE : - N.T.S.	TYPE : - P.H.C.

GROUND FLOOR ELECTRICAL PLAN

AGENCY -
CLIENT - BHAVNAGAR MUNICIPAL CORPORATION(BMC)
PROJECT:- CONSTRUCTION OF NEW PRIMARY HEALTH CENTER-PHC AT KUMBHARWADA DIS.- BHAVNAGAR

JAYESH A DALAL
Planning & Engineering Services Pvt Ltd
JALARAM SHAKTI, BESIDE DHANWALGRI APARTMENT, N.R.LOURD'S CONVENT SCHOOL,ATHWALINES,SURAT.



DRAWN BY	REVISED BY	CHECKED BY	DRG NO	PROJ NO
HAZIM	---	---	---	12PY24

LEFT SIDE ELEVATION

RIGHT SIDE ELEVATION

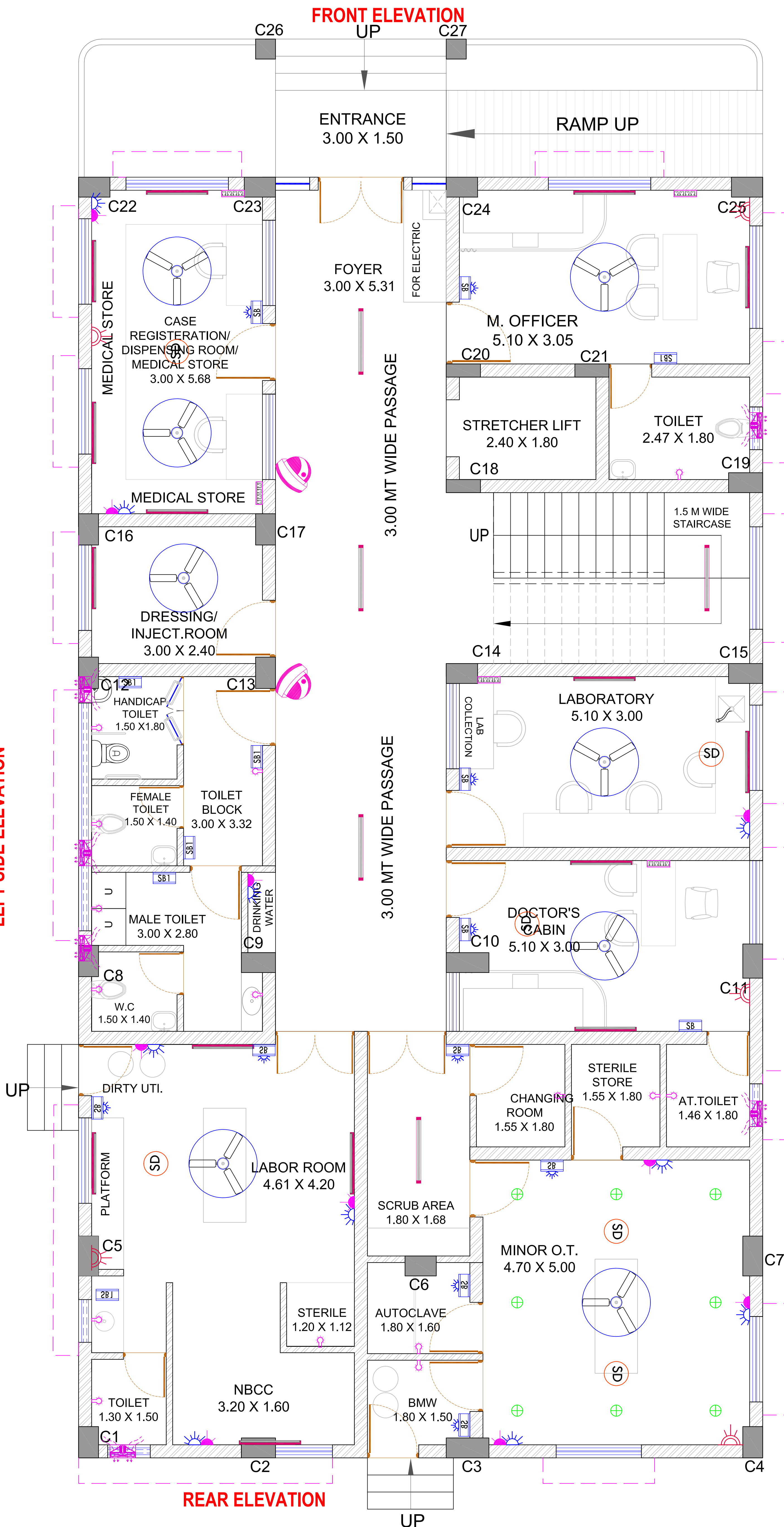

GROUND FLOOR PLAN

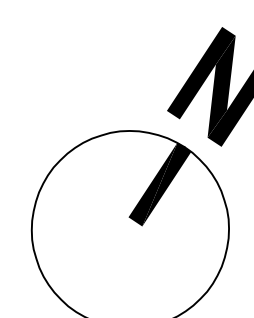

CONSTRUCTION OF NEW PRIMARY HEALTH CENTER-PHC AT KUMBHARWADA DIS.- BHAVNAGAR

FRONT ELEVATION

ENTRANCE CANOPY

LEFT SIDE ELEVATION

RIGHT SIDE ELEVATION

REAR ELEVATION

FIRST FLOOR PLAN

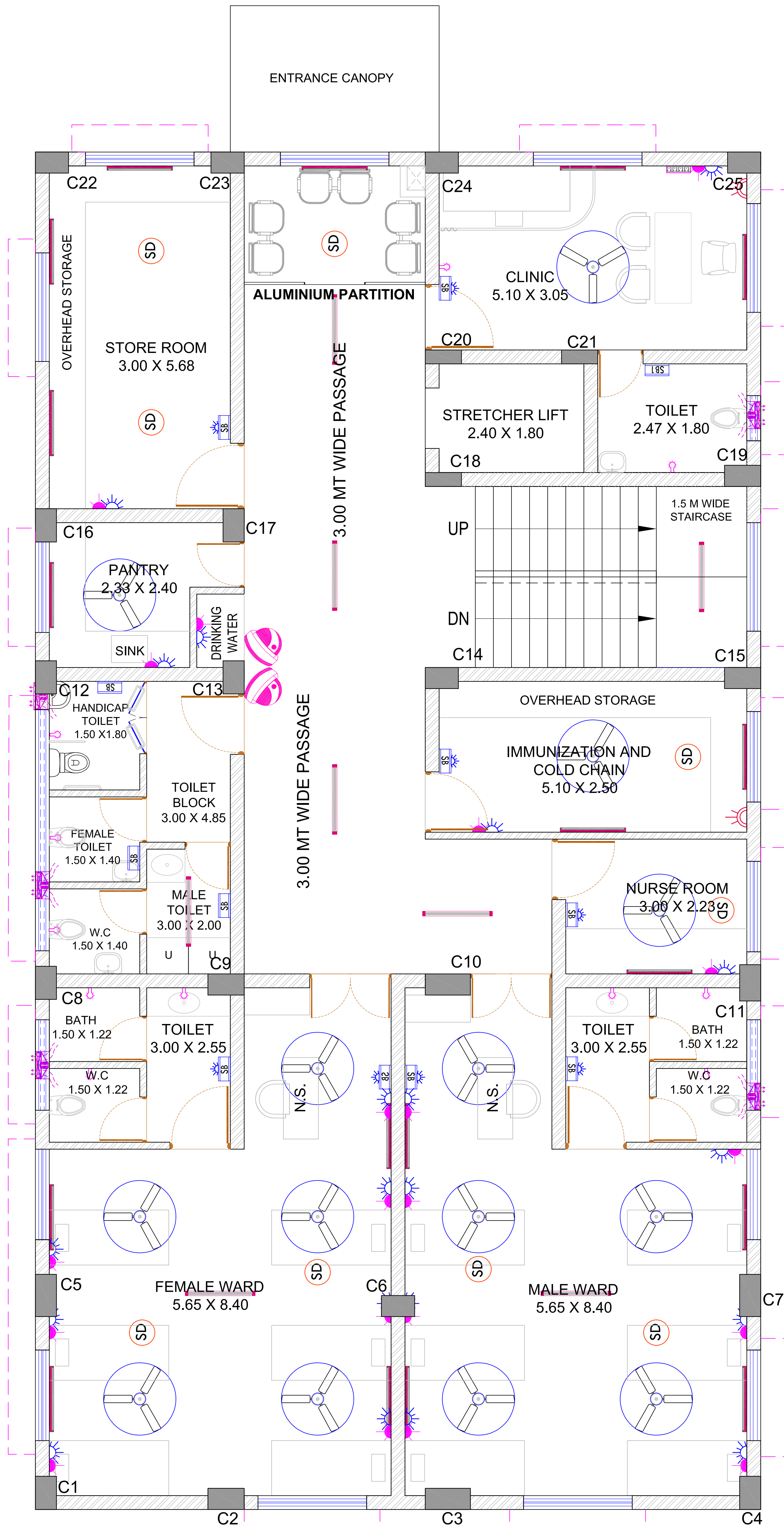

COPY FOR TENDER

CLIENT	CONTRACTOR	PMC/T.P.I.

TENDER DRAWING

REVISION NOTES

NO.	DATE	REVISION DETAILS
R1		

SYMBOL	DESCRIPTION	MOUNTING HEIGHT
	LIGHTING DISTRIBUTION BOARD(LDB)	2100mm
	6A SWITCH SOCKET OUTLET	1500mm
	SWITCH BOARDS	1200mm
	6 A /16 A LOOPED PLUG POINT	1200mm
	15A SWITCH SOCKET OUTLET	1200mm
	TUBE LIGHT ON CEILING	CEILING
	TUBE LIGHT ON WALL	2100mm
	18W BRACKET LIGHT	2100mm
	48 " Ø CEILING FAN	CEILING
	SMOKE DETECTOR	CEILING
	EXHAUST FAN	-
	BULLET CCTV CAMERA	-
	DOME CCTV CAMERA	-

ISSUE STAMP

DEPUTY ENGINEER

EXECUTIVE/ CITY/ CHIEF ENGINEER

ARCHITECTURE/ ENGINEER
STRUCTURE CONSULTANT SIGNATURE

REVISION DATE : -	DATE : - 21-10-2024
SCALE : - N.T.S.	TYPE : - P.H.C.

FIRST FLOOR ELECTRICAL PLAN

AGENCY -
CLIENT - BHAVNAGAR MUNICIPAL CORPORATION(BMC)
PROJECT:-
CONSTRUCTION OF NEW PRIMARY HEALTH CENTER-PHC
AT KUMBHARWADA DIS.- BHAVNAGAR

JAYESH A DALAL
Planning & Engineering Services Pvt Ltd



DRAWN BY	REVISED BY	CHECKED BY	DRG NO	PROJ NO
HAZIM	---	---	---	12PY24

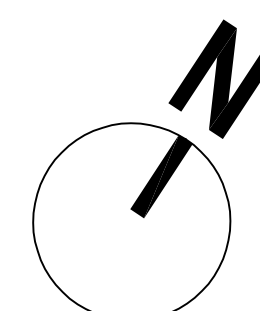

CLIENT	CONTRACTOR	PMC/T.P.I.

TENDER DRAWING

REVISION NOTES

NO.	DATE	REVISION DETAILS
R1		

SYMBOL	DESCRIPTION	MOUNTING HEIGHT
	LIGHTING DISTRIBUTION BOARD(LDB)	2100mm
	6A SWITCH SOCKET OUTLET	1500mm
	SWITCH BOARDS	1200mm
	6 A /16 A LOOPED PLUG POINT	1200mm
	15A SWITCH SOCKET OUTLET	1200mm
	TUBE LIGHT ON CEILING	CEILING
	TUBE LIGHT ON WALL	2100mm
	18W BRACKET LIGHT	2100mm
	48 " Ø CEILING FAN	CEILING
	SMOKE DETECTOR	CEILING
	EXHAUST FAN	-
	BULLET CCTV CAMERA	-
	DOME CCTV CAMERA	-

ISSUE STAMP

DEPUTY ENGINEER

EXECUTIVE/ CITY/ CHIEF ENGINEER

ARCHITECTURE/ ENGINEER
STRUCTURE CONSULTANT SIGNATURE

REVISION DATE : -	DATE : - 21-10-2024
SCALE : - N.T.S.	TYPE : - P.H.C.

SECOND FLOOR ELECTRICAL PLAN

AGENCY -
CLIENT - BHAVNAGAR MUNICIPAL CORPORATION(BMC)
PROJECT:-
CONSTRUCTION OF NEW PRIMARY HEALTH CENTER-PHC
AT KUMBHARWADA DIS.- BHAVNAGAR

JAYESH A DALAL

Planning & Engineering Services Pvt Ltd
*JALARAM SHAKTI, BESIDE DHAWALGIRI APARTMENT, NR.LOURDS CONVENT SCHOOL,ATHWALINES,SURAT.



DRAWN BY	REVISED BY	CHECKED BY	DRG NO	PROJ NO
HAZIM	---	---	---	12PY24

FRONT ELEVATION

LEFT SIDE ELEVATION

RIGHT SIDE ELEVATION

REAR ELEVATION

SECOND FLOOR PLAN

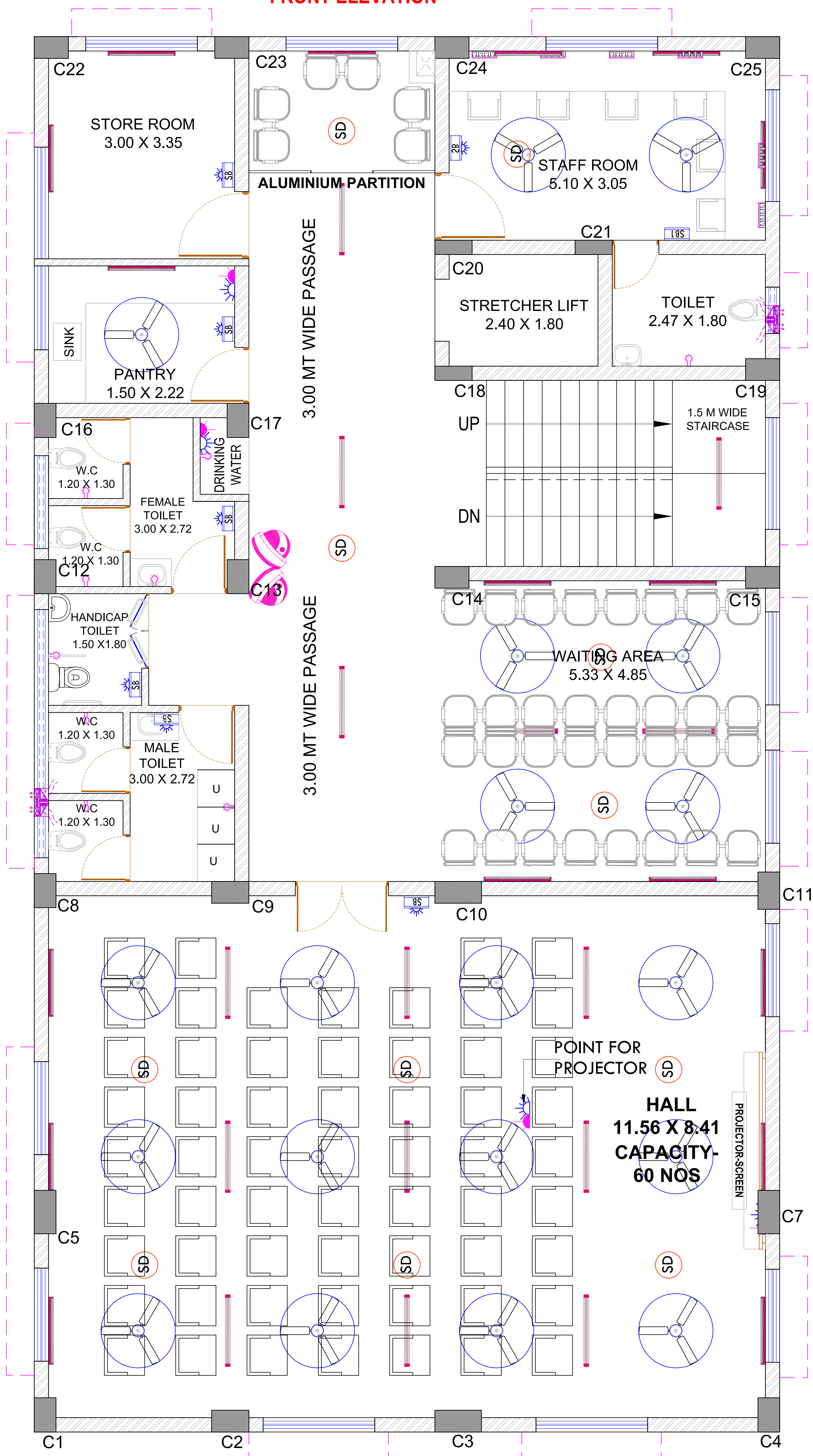
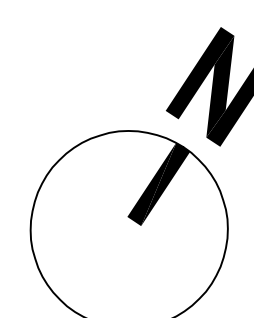

CLIENT	CONTRACTOR	PMC/T.P.I.

TENDER DRAWING

REVISION NOTES

NO.	DATE	REVISION DETAILS
R1		

LEGEND	
	UNDER GROUND FIRE HYDRANT PIPE
	FLOW DIRECTION
	FIRE HYDRANT PIPE
	4 WAY FIRE BRIGADE INLET
	2 WAY FIRE BRIGADE INLET
	M.S. FABRICATED HOSE BOX
	HYDRANT VALVE
	BUTTERFLY VALVE
	NON RETURN VALVE
	AIR RELEASE VALVE
	FIRE HY. VALVE & WASH PIPE
	HOSE REEL
	Co2 TYPE (FIRE EXTINGUISHER)
	POWDER TYPE (FIRE EXTINGUISHER)
	FOOT VALVE
	Y STRAINER
	ON/OFF SWITCH
	FIRE ALARM SWITCH
	FIRE ALARM CONTROL PANEL
	HOOTER

DEPUTY ENGINEER

EXECUTIVE/ CITY/ CHIEF ENGINEER

ARCHITECTURE/ ENGINEER
STRUCTURE CONSULTANT SIGNATURE

REVISION DATE : -	DATE : - 21-10-2024
SCALE : - N.T.S.	TYPE : - P.H.C.

GROUND FLOOR FIRE PLAN

AGENCY -
CLIENT - BHAVNAGAR MUNICIPAL CORPORATION(BMC)
PROJECT:-
CONSTRUCTION OF NEW PRIMARY HEALTH CENTER-PHC
AT KUMBHARWADA DIS.- BHAVNAGAR

JAYESH A DALAL
Planning & Engineering Services Pvt Ltd



DRAWN BY	REVISED BY	CHECKED BY	DRG NO	PROJ NO
HAZIM	---	---	---	12PY24

LEFT SIDE ELEVATION

RIGHT SIDE ELEVATION

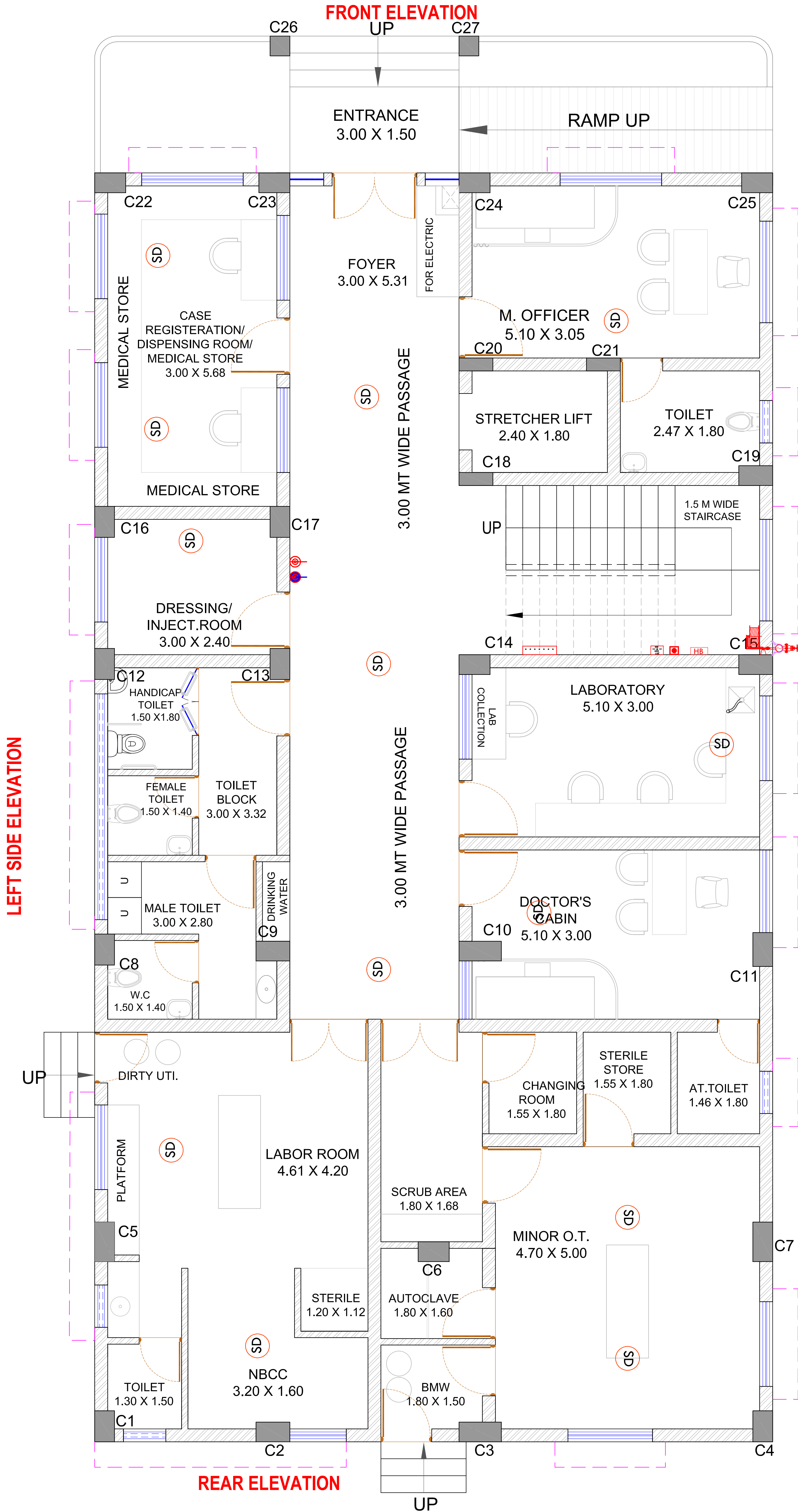

GROUND FLOOR PLAN

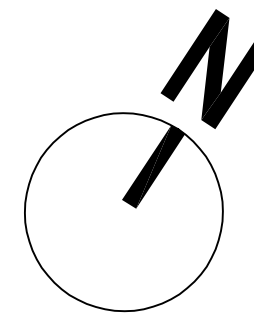

CONSTRUCTION OF NEW PRIMARY HEALTH CENTER-PHC AT KUMBHARWADA DIS.- BHAVNAGAR

FRONT ELEVATION

ENTRANCE CANOPY

LEFT SIDE ELEVATION

RIGHT SIDE ELEVATION

REAR ELEVATION

FIRST FLOOR PLAN

COPY FOR TENDER

CLIENT	CONTRACTOR	PMC/T.P.I.

TENDER DRAWING

REVISION NOTES

NO.	DATE	REVISION DETAILS
R1		

LEGEND

	UNDER GROUND FIRE HYDRANT PIPE
	FLOW DIRECTION
	FIRE HYDRANT PIPE
	4 WAY FIRE BRIGADE INLET
	2 WAY FIRE BRIGADE INLET
	M.S. FABRICATED HOSE BOX
	HYDRANT VALVE
	BUTTERFLY VALVE
	NON RETURN VALVE
	AIR RELEASE VALVE
	FIRE HY. VALVE & WASH PIPE
	HOSE REEL
	Co2 TYPE (FIRE EXTINGUISHER)
	POWDER TYPE (FIRE EXTINGUISHER)
	FOOT VALVE
	Y STRAINER
	ON/OFF SWITCH
	FIRE ALARM SWITCH
	FIRE ALARM CONTROL PANEL
	HOOTER

DEPUTY ENGINEER

EXECUTIVE/ CITY/ CHIEF ENGINEER

ARCHITECTURE/ ENGINEER
STRUCTURE CONSULTANT SIGNATURE

REVISION DATE :-	DATE :- 21-10-2024
SCALE :- N.T.S.	TYPE :- P.H.C.

FIRST FLOOR FIRE PLAN

AGENCY -
CLIENT - BHAVNAGAR MUNICIPAL CORPORATION(BMC)
PROJECT:-
CONSTRUCTION OF NEW PRIMARY HEALTH CENTER-PHC
AT KUMBHARWADA DIS.- BHAVNAGAR

JAYESH A DALAL
Planning & Engineering Services Pvt Ltd



DRAWN BY	REVISED BY	CHECKED BY	DRG NO	PROJ NO
HAZIM	---	---	---	12PY24

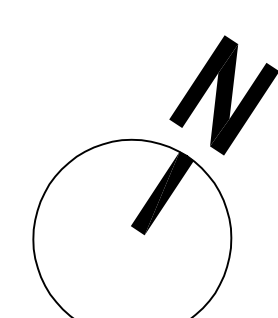

CLIENT	CONTRACTOR	PMC/T.P.I.

TENDER DRAWING

REVISION NOTES

NO.	DATE	REVISION DETAILS
R1		

LEGEND

	UNDER GROUND FIRE HYDRANT PIPE
	FLOW DIRECTION
	FIRE HYDRANT PIPE
	4 WAY FIRE BRIGADE INLET
	2 WAY FIRE BRIGADE INLET
	M.S. FABRICATED HOSE BOX
	HYDRANT VALVE
	BUTTERFLY VALVE
	NON RETURN VALVE
	AIR RELEASE VALVE
	FIRE HY. VALVE & WASH PIPE
	HOSE REEL
	Co2 TYPE (FIRE EXTINGUISHER)
	POWDER TYPE (FIRE EXTINGUISHER)
	FOOT VALVE
	Y STRAINER
	ON/OFF SWITCH
	FIRE ALARM SWITCH
	FIRE ALARM CONTROL PANEL
	HOOTER

DEPUTY ENGINEER

EXECUTIVE/ CITY/ CHIEF ENGINEER

ARCHITECTURE/ ENGINEER
STRUCTURE CONSULTANT SIGNATURE

REVISION DATE :-	DATE :- 21-10-2024
SCALE :- N.T.S.	TYPE :- P.H.C.

SECOND FLOOR FIRE PLAN

AGENCY -
CLIENT - BHAVNAGAR MUNICIPAL CORPORATION(BMC)

PROJECT:-
CONSTRUCTION OF NEW PRIMARY HEALTH CENTER-PHC
AT KUMBHARWADA DIS.- BHAVNAGAR

JAYESH A DALAL
Planning & Engineering Services Pvt Ltd



DRAWN BY	REVISED BY	CHECKED BY	DRG NO	PROJ NO
HAZIM	---	---	---	12PY24

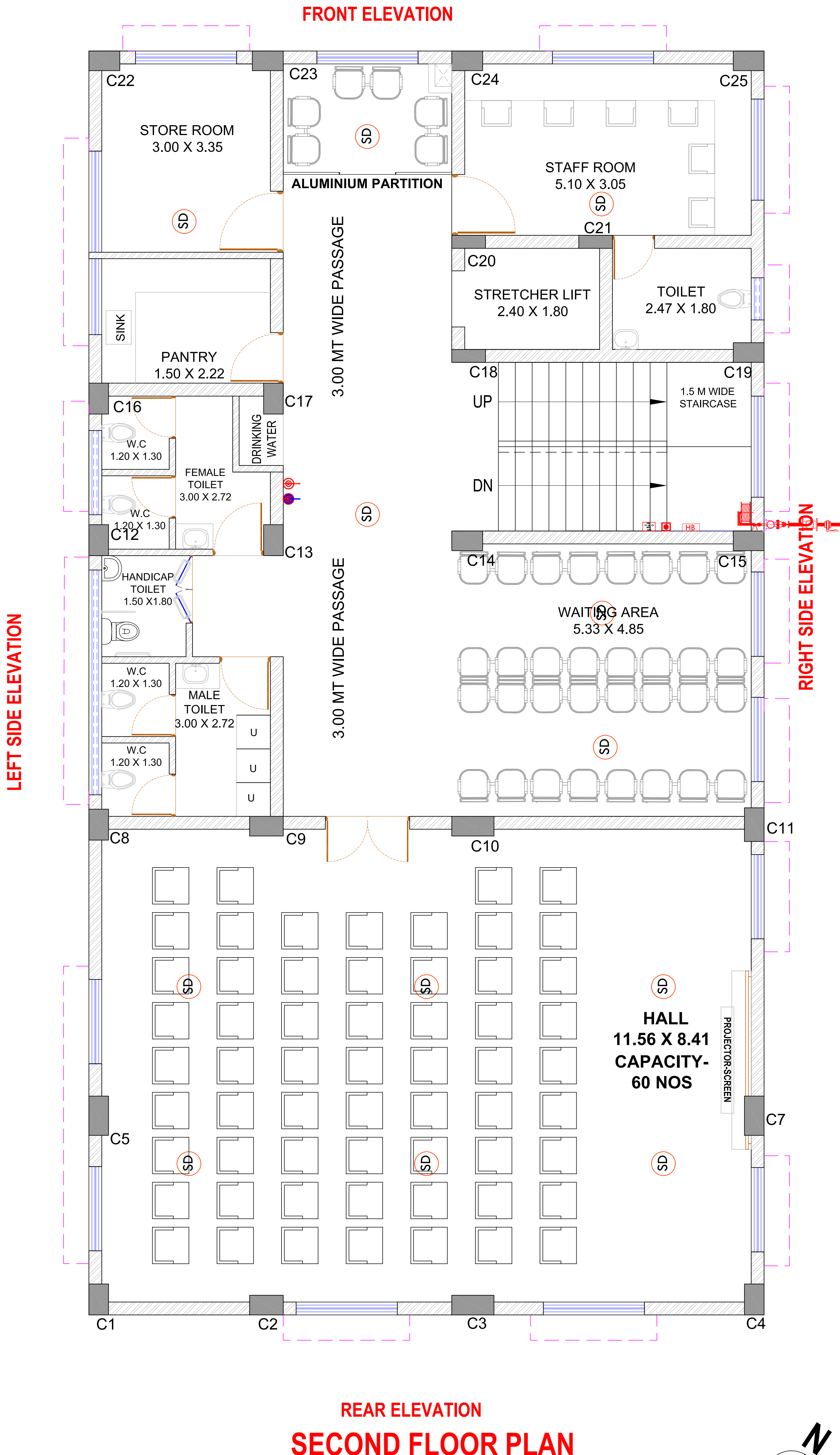

REAR ELEVATION
SECOND FLOOR PLAN

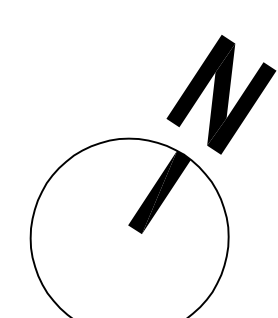

SCHEDULE FOR TESTING OF MATERIALS

Sr.No.	Brief description of materials to be tested	Prescription of test which shall be carried out	Frequency @ which test shall be carried out (As per GERI Q.C. Vol-12002)
1.	Sand	(1) Gradation	1/150 Cmt for concrete or as per requirement of relevant specification.
		(2) Fineness Modulus	
		(3) Specific Gravity	
		(4) Water Absorption	
		(5) Silt Content	
2.	Coarse Aggregate	(1) Gradation	1/150 Cmt for concrete or as per requirement of relevant specification.
		(2) Impact Value	
		(3) Flakiness Index	
		(4) Water Absorption	
		(5) Stripping Value	
3.	C.C.Cube	(1) Compressive Strength	1-5 Cmt. 1-Test 6-15 Cmt. 2-Test 16-30 Cmt. 3-Test 31-50 Cmt. 6-Test for each additional 50 Cmt or part of thereof : 6-Test for every 50 Cmt.
4.	Flush Door	(1) End Immersion Test	Randomly as per IS:7638: 1975
		(2) Glue Adhesion Test	
5.	Tiles	(1)Wet Transverse Strength (2) Water Absorption	Randomly as per Strength IS:4905:1968
6.	Flyash Brick	(1) Compressive Strength (2) Water Absorption	As per IS:5454:1978
7.	Cement	(1) Consistency test (2) Initial Setting time (3) Final setting time (4) Compressive Strenght (5) Fineness by Dry Sieving (6) Fineness by Specific	Every 50 Tons or part thereof

		Surface (7) Soundness by Le-Chatelier (8) Specific Gravity	
8.	Steel	(1) Weight per meter (2) Yield Stress / 0.2 % Proof stress (3) % Elongation (4) Tensile Strength	(a) For Consignment below 100 tons (i) Under 10 mm dia One sample for each 25 tons or part thereof (ii) 10 mm to 16 mm dia One Sample for each 35 tons or part thereof (iii) Over 16 mm dia One Sample for each 45 tons or part thereof. (b) For Consignment over 100 tons (i) Under 10 mm dia One sample for each 40 tons or part thereof (ii) 10 mm to 16 mm dia One Sample for each 45 tons or part thereof

Note:-

- (1) For Sand and Coarse aggregate two Nos. of full bag for one sample shall be supplied by agency.
- (2) For water test 5:00 liters of water shall be supplied by agency in plastic container for each sources.
- (3) Sample from the lot shall be selected by authorized representative along with representative of Project Management Consultant (PMC).
- (4) Selected sample shall be handed over personally by representative of B.M.C. and PMC in sealed condition with letter containing sample No. and sampling date.
- (5) Test report should be received by the department containing reference of department's letter, sample No. sampling date and date of testing.

MAKE LIST FOR ELECTRICAL WORKS		
SR.NO.	ITEM	STANDARD MAKE
1	LT PANELS	CPRI / ERDA APPROVED PANEL BUILDER. 70 KA SHORT CIRCUIT WITHSTAND STRENGTH. ACCESSORIES AS PER MENTIONED IN MAKE LIST. L&T / SIEMENS / PVJ POWER
2	DISTRIBUTION BOARDS	LEGRAND/ SCHNIEDER / HAVELLS / SIEMENS Lauritz Knudsen (L&T)/ HAGER
3	CABLE & WIRE	FINOLEX / POLYCAB / KEI / RR KABEL/ ALLCAB
4	CABLE TRAY (ALL TYPE)	PROFAB/PRECISION/THINKTRECK /UNIVERSAL/ INDIANA / KEW/RUSHAB
5	LT SWITCHGEAR (ALL RANGE)	AS PER SPECIFIED PANEL DISCRIPTION IN BOQ. MODEL AS PER SPECIFIED IN BOQ LEGRAND/ SCHNIEDER/ HAVELLS/ SIEMENS / Lauritz Knudsen (L&T)/ HAGER
6	LT MCCB	LEGRAND/ SCHNIEDER/ HAVELLS/ SIEMENS / Lauritz Knudsen (L&T)/ HAGER
7	LT MCB, ELCB	LEGRAND/ SCHNIEDER/ HAVELLS/ SIEMENS / Lauritz Knudsen (L&T)/ HAGER
8	LT SFU	LEGRAND/ SCHNIEDER/ HAVELLS/ SIEMENS / Lauritz Knudsen (L&T)/ HAGER
9	LT CONTACTORS	LEGRAND/ SCHNIEDER/ HAVELLS/ SIEMENS / Lauritz Knudsen (L&T)/ HAGER
10	CHANGE OVER SWITCH	LEGRAND/ SCHNIEDER/ HAVELLS/ SIEMENS/ Lauritz Knudsen (L&T)/ HAGER
11	STARTER (STAR-DELTA / DOL)	LEGRAND/ SCHNIEDER/ HAVELLS/ SIEMENS/ Lauritz Knudsen (L&T)/ HAGER
12	SUBMERCIBLE MOTOR/ MONOBLOCK PUMP SET	CROMPTON / KIRLOSKAR / KBL / LUBI
13	METERS (DIGITAL)	ENERCON / CONZERVE / SCHNEIDER / AE / SECURE / ABB
14	LOAD MANAGER	ENERCON / SEM / KRYKARD/CONZERVE/ NIPPEN/ Lauritz Knudsen (L&T)
15	RELAYS- EARTH FAULT	LEGRAND/ SCHNIEDER/ HAVELLS/ SIEMENS/ GE
16	LUGS	DOWELL'S / 3M / JAINSON / COMET / HMI / (ISI MARKED)
17	BIMETALLIC LUGS	DOWELL'S / 3M / ISMAL / HMI / (ISI MARKED)
18	CABLE GLAND	DOWELL'S / JAINSON / 3D / COMET / HMI (ISI MARKED)
19	PVC CONDUITS AND ACCESSORIES, UPVC TRUNKING	PRECISION / ANCHOR / POLYCAB / NIHIR
20	CASING CAPING	PRECISION / NIHIR / POLYCAB
21	MODULAR SWITCHES, SOCKETS & OTHER ACCESSORIES	LEGRAND/HAVELLS / GM / ANCHOR / GREAT WHITE
22	PVC JUNCTION BOX	SINTEX / CLIPSAL /MK / PRECISION / ANCHOR / POLYCAB / NIHIR

MAKE LIST FOR ELECTRICAL WORKS		
SR.NO.	ITEM	STANDARD MAKE
23	COAXIAL TV CABLE	DELTON / NATIONAL / HAVELLS / FINOLEX
24	LED LIGHT FIXTURES	LIGHTING TECHNOLOGIES/ PHILIPS / HAVELLS / OSRAM/WIPRO / CROMPTON PER MODEL SPECIFIED IN BOQ
25	CEILING FAN / EXHAUST FAN	CROMPTON/ USHA / HAVELLS / ORIENT AS PER MODEL SPECIFIED IN BOQ
26	GI JUNCTION BOX / UNDER FLOOR TRUNKING & ITS ACCESSORIES	MK / LEGRAND
27	CMS	MK / LEGRAND
28	EARTHING & LIGHTNING ARRESTOR	GREEN WIRE / ASHLOK / E-LINK
29	SMC PRESS BOX	SINTEX / EPP
30	MODULAR LIGHT POINT WITH ACCESSORIES	ANCHOR / HAVELLS / MK / LEGRAND
31	SOLAR WATER HEATER	HONEYWELL / RACOLD / INTER SOLAR
32	SOLAE POWER SYSTEM	TATA / HAVELLS / SOLARSOKO / WARRI
33	DWC PIPE	Rex Poly Extrusion Ltd / VEC Engineering / GEMINI / PRECISION
34	WATER COOLER & RO	VOLTAS / USHA / BLUESTAR / EUREKA FORBS
35	GI POLE	MARUTI / AMBICA / RR ISPAT / BAJAJ / ZENITH / PRIDE
36	CCTV SYSTEM	HICKVISION / PANASONIC / HONEYWELL
37	LED DISPLAY	SAMSUNG / PANASONIC / SONY
38	PoE SWITCH	CISCO / AVAYA
39	CAT-6 CABLE	DIGI LINK / FINOLAX / ANCHOR / D LINK
40	COMPUTER OR SERVER	HP / DELL
41	NETWORK RACK	VALRACK / APW
42	FIRE EXTINGUISHER	SAFEX / MINIMEX / AAAG / NEW AGE
43	LIFT	OTIS / TRIO / TECHNO / ORBIS / KONE / JOHNSONS
Special Note:-		
1	Client have right to check the challans of supplier.	
2	The MCB and MCB DB s must be of same make.	
3	Approve all the make of material from Client / Consultant / PMC before execution.	
4	The Client/ Consultant / PMC reserve the right to select the manufacture or approved make from the above list. No	
5	Any make not mentioned in the above lists must be approved from Client / Consultant before execution.	
6	All the material should be ISI and as per standards mentioned in specifications and BOQ.	



सत्यमेव जयते

भारत सरकार

GOVERNMENT OF INDIA

केन्द्रीय लोक निर्माण विभाग

CENTRAL PUBLIC WORKS DEPARTMENT

वैद्युत कार्यों

के लिए

सामान्य विनिर्देश

(भाग-III-लिफ्ट और एस्कलेटर)

GENERAL SPECIFICATIONS

FOR

ELECTRICAL WORKS

(PART-III-LIFTS & ESCALATORS)

2003

प्रकाशित

निर्माण महानिदेशक, के० लो० नि० वि०, निर्माण भवन, नई दिल्ली - 110 011

PUBLISHED BY

DIRECTOR GENERAL (WORKS) CPWD, NIRMAN BHAWAN, NEW DELHI-110011

मुद्रित एवं विपणित : भैसर्स नाभि प्रकाशन, एन.101, दूसरा तल, मुंशीराम भवन, कर्नाट सर्कस, नई दिल्ली - 110 001

Printed & Marketed by : M/s. NABHI PUBLICATIONS, N-101, 2nd Floor, Munshi Ram Building, Connaught Circus, New Delhi-110 001



150 वर्ष
हंजीभियरी
उत्कृष्टता के
Years of
Engineering
Excellence

© सर्वाधिकार सुरक्षित, निर्माण महानिदेशक, के० लो० नि० वि०, नई दिल्ली की लिखित अनुमति के बिना इस प्रकाशन का कोई भी अंश, किसी भी रूप में, इलैक्ट्रॉनिक, अथवा यांत्रिक, छायाप्रति सहित, रिकाथडग अथवा किसी सूचना भंडारण अथवा पुनः प्राप्ति प्रणाली, किसी भी माध्यम द्वारा उद्धरित नहीं किया जाएगा ।

भारत सरकार प्रकाशन

निर्माण महानिदेशक

के० लो० नि० वि०, निर्माण भवन, नई दिल्ली - 110 011

द्वारा प्रकाशित

एवं

मैसर्स नाभि प्रकाशन

एन.101, दूसरा तल, मुंशीराम भवन

कनॉट सर्कस, नई दिल्ली - 110 001

दूरभाष : 23321251, 23354823 फैक्स : 011-23731117

ई-मेल : sales@jainbookdepot.com

वेबसाईट : www.nabhipublication.com

द्वारा मुद्रित एवं विपणित

प्राप्ति स्थान

मैसर्स जैन बुक डिपो

सरकारी प्रकाशनों के प्राधिकृत विक्रेता

सी -4 & 5, कनॉट प्लेस, नई दिल्ली - 110 001

दूरभाष : 23416101 / 02 / 03, 55307233 फैक्स : 011-23731117

ई-मेल : sales@jainbookdepot.com

वेबसाईट : www.jainbookdepot.com

मैसर्स जैन बुक एजेन्सी

सरकारी प्रकाशनों के प्राधिकृत विक्रेता

सी -9, कनॉट प्लेस, नई दिल्ली - 110 001

दूरभाष : 23416390 / 91 / 92 / 93 / 94

ई-मेल : sales@jainbookagency.com

वेबसाईट : www.jainbookagency.com

मैसर्स जैन बुक एजेन्सी (साउथ एण्ड)

सरकारी प्रकाशनों के प्राधिकृत विक्रेता

1, अरविंद मार्ग, हीज खास, नई दिल्ली - 110 016

दूरभाष : 26567066, 26566113

ई-मेल : sales@jainbookagency.com

वेबसाईट : www.jainbookagency.com

समस्त प्रमुख और प्राधिकृत सरकारी पुस्तक विक्रेता

मूल्य : 275/- रूपए (डाक खर्च और प्रेषण प्रभार आदि को छोड़कर)

© All rights reserved. No part of this publication may be reproduced in any form or by any means, electronic or mechanical, including photocopy, recording or any information storage and retrieval system, without permission, in writing, from the Director General (Works), CPWD, New Delhi

A GOVERNMENT OF INDIA PUBLICATION

Published by :

DIRECTOR GENERAL (WORKS)

CPWD, NIRMAN BHAWAN, NEW DELHI - 110 011

&

Printed & Marketed by

M/s. NABHI PUBLICATIONS

N-101, 2nd Floor, Munshi Ram Building,

Connaught Circus, New Delhi-110 001

Phone : 23321251, 23354823 Fax : 011-23731117

E-mail : sales@jainbookdepot.com

Website : www.nabhipublication.com

Available at :

M/s. Jain Book Depot

C-4 & 5, Connaught Place, New Delhi-110001

Phone : 23416101/02/03, 55307233 Fax : 011-23731117

E-mail : sales@jainbookdepot.com

Webstie : www.jainbookdepot.com

M/s. Jain Book Agency

Authorised Dealers of Govt. Publications

C-9, Connaught Place, New Delhi-110001

Phone : 23416390 / 91 / 92 / 93 / 94

E-mail : sales@jainbookagency.com

Website : www.jainbookagency.com

M/s. Jain Book Agency (South End)

Authorised Dealers of Govt. Publications

1, Aurobindo Marg, Hauz Khas, New Delhi-110016

Phone : 26567066, 26566113

E-mail : sales@jainbookagency.com

Website : www.jainbookagency.com

All leading Booksellers & Authroised Govt. Dealers

Price : Rs. 275/- (excluding postage and forwarding charges etc.)

प्राक्कथन

यह तो सर्वविदित है कि गगनचुम्बी भवनों की निर्माण योजना में लिफ्टों का प्रावधान किया जाता है। के. लो. नि. वि. पिछले छः दशकों से लिफ्टों के अभिकल्पन चरण से लेकर संस्थापन, कमीशनिंग (प्रवर्तन करना), प्रचालन एवं अनुरक्षण का प्रबन्धन कर रहा है। प्रथम लिफ्ट विनिर्देश वैद्युतीय कार्यों के लिए सामान्य विनिर्देश (भाग-3 लिफ्ट) के नाम से पहला संस्करण वर्ष 1981 में प्रकाशित हुआ था। पिछले कई वर्षों में लिफ्ट उद्योग में बहुत तेजी से प्रगति हुई है। अतः इस क्षेत्र में हुए विकास एवं आधुनिकतम प्रौद्योगिकी को सम्मिलित करने के लिए, विद्यमान विनिर्देशों को संशोधित किया गया है। संशोधित विनिर्देशों में विद्युत संकर्षण लिफ्टों के अतिरिक्त द्रवचालित (हाइड्रालिक) लिफ्टों, सेवा लिफ्ट (मूक प्रतीक्षक) एवं चल सोपान (एस्केलेटर्स) आदि को भी सम्मिलित किया गया है।

यह संशोधित संस्करण श्री के. जे. सिंह अधीक्षक अभियंता (वै), श्री आर. के. सिंघल अधीक्षक अभियंता (वै), श्री मुकेश विज अधीक्षक अभियंता (वै) एवं श्री जी. चंचलानी सहायक अभियंता (वै) की समिति द्वारा किए गए प्रयासों का परिणाम है।

इस संबंध में मैं, श्री एस आर सुब्रामनियम मुख्य अभियंता (वै)-1, श्री के. के. जसवाल मुख्य अभियंता (वै)-2 तथा मुख्य अभियंता (वै)-1 के अन्य कर्मचारी वृन्द का भी आभारी हूँ जिनके प्रयासों के बिना यह संशोधित संस्करण संभव नहीं होता। इन विनिर्देशों के बारे में कोई भी सुझाव अथवा आशोधन अधीक्षक अभियंता (एस एण्ड एस) को भेजे जा सकते हैं। अंग्रेजी और हिन्दी संस्करण में किसी भी अन्तर के मामले में अंग्रेजी संस्करण मान्य होगा।

नई दिल्ली
दिनांक 24th जनवरी, 2003

जे. एन. भवानी प्रसाद
निर्माण महानिदेशक
के.लो.नि.वि., नई दिल्ली

The copy of this specification may be procured in any form only by order.

FOREWORD

It is well recognized that high rise buildings are planned with the provision of lifts. CPWD has been handling lift installations for over six decades right from the design stage to installation, commissioning, operation and maintenance. The first lift specification viz General Specifications for electrical works (Part-III lifts) was published in 1981. Over the years the lift Industry has progressed rapidly. To incorporate the latest technology and development, the existing specification has been revised. The revised specification covers hydraulic lifts, dumb waiters and escalators in addition to the electric traction lifts.

This revision is the result of the efforts put in by the committee consisting of Sh. K.J.Singh, SE(E)I, Sh. R.K.Singhal, SE(E), Sh. Mukesh Vij, SE(E) & Sh. G.Chanchlani, AE(E).

In this connection I am also thankful to the efforts put in by Sh. S.R.Subramanian, CE(E)I, Sh. K.K.Jaswal, CE(E)II and other staff of CE(E)I without whose efforts this revision would not have been possible. Any suggestions or modifications in this specifications may be made to SE(S&S). In case of any discrepancy between English and Hindi versions, the English version shall be held valid.

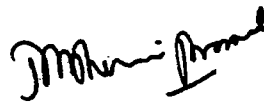

New Delhi
Dated 24th January, 2003

J.N. Bhavani Prasad
Director General (Works)
C.P.W.D., New Delhi

विषय सूची

क्रम संख्या	विषय	पृष्ठ संख्या
खण्ड - I विद्युत संकर्षण लिफ्ट		
अध्याय - I सामान्य		2-6
1.0	विषय क्षेत्र	2
2.0	आवश्यकता, परिमाण और अवस्थिति	2
3.0	सांविधिक नियमों, विनियमों, मानकों और सुरक्षा संहिताओं के अनुरूप	3
4.0	विभाग द्वारा किए जाने वाले कार्य	4
5.0	संविदाकार द्वारा किए जाने वाले कार्य	4
6.0	अन्य एजेंसियों के साथ समन्वय	5
7.0	निविदा की पूर्णता	5
8.0	कार्य अधिनिर्णय के पश्चात् संविदाकार द्वारा प्रदान की जाने वाली सूचना	5
9.0	कार्य प्रारंभ	6
अध्याय - II शब्दावली		7-14
अध्याय - III स्थापत्य और संरचना उपस्कर		15-17
1.0	भवन आरेखों में लिफ्टों के विवरण	15
2.0	स्थापत्य विचार	15
3.0	संरचना विचार	16
4.0	मशीन कक्ष तथा लिफ्ट गर्त तक अभिगम	17
अध्याय - IV तकनीकी		18-34
1.0	विषय क्षेत्र	18
2.0	चालन मशीनरी	18
3.0	नियंत्रणों के प्रकार	19
4.0	अधिष्ठापन पहलू	19
5.0	गाइड रेल	20
6.0	लिफ्ट कार	20
7.0	कार और अवतरण द्वार	22
8.0	समतलन	24
9.0	प्रति भार	24

CONTENTS

Sl. No.	Name of Head	Page No.
SECTION I - ELECTRIC TRACTION LIFTS		
CHAPTER -1 GENERAL		2-6
1.0	Scope	2
2.0	Requirement, Quantity & Location	2
3.0	Conformity with Statutory Rules, Regulations, Standards & Safety Codes	3
4.0	Works to be done by the Department	4
5.0	Works to be done by the Contractor	4
6.0	Co-ordination with other agencies	5
7.0	Completeness of tender	5
8.0	Information to be supplied by the contractor after award of work	5
9.0	Commencement of work	6
CHAPTER - II TERMINOLOGY		7-14
CHAPTER - III ARCHITECTURAL & STRUCTURAL REQUIREMENTS		15-17
1.0	Particulars of lifts in Building Drawings	15
2.0	Architectural Considerations	15
3.0	Structural Considerations	16
4.0	Access to Machine Room & Lift pits	17
CHAPTER -IV TECHNICAL		18-34
1.0	Scope	18
2.0	Drive Machinery	18
3.0	Type of Controls	19
4.0	Installation aspects	19
5.0	Guide Rails	20
6.0	Lift Car	20
7.0	Car and Landing Entrances	22
8.0	Levelling	24
9.0	Counter Weight	24

क्रम संख्या	विषय	पृष्ठ संख्या
10.0	गाइड नाल (शू)	25
11.0	लिफ्ट रज्जु	25
12.0	सुरक्षा उपस्कर	26
13.0	लिफ्ट प्रचालन	28
14.0	नियंत्रण उपस्कर	31
15.0	लिफ्ट रज्जु प्रतिकरण	34
16.0	स्वचालित बचाव साधन	34
खण्ड II - द्रवचालित लिफ्टें		35-43
1.0	द्रवचालित लिफ्टों के प्रकार	36
2.0	शब्दावली	36
3.0	निर्माण आवश्यकताएं	39
4.0	मशीन, जैक और अन्य द्रवचालित उपस्कर	39
5.0	उपेक्ष्य विभीय त्रुटियां	41
6.0	मशीन कक्ष	41
7.0	गाइड रेल, गाइड शू और बफर	42
8.0	लिफ्ट कार और कार ढाँचे	42
9.0	कार दरवाजे, अवतरण दरवाजे और पाशन साधन	42
10.0	मुक्त कार प्रपात, अत्यधिक चाल से अवरोहण और विसर्पण के विरुद्ध सावधानियां	42
11.0	सुरक्षा गियर	42
12.0	निलंबन	43
13.0	नियंत्रक और प्रचालन युक्तियां	43
14.0	टर्मिनल अवरोधन और अंतिम सीमा स्विच	43
खण्ड - III सेवा लिफ्ट (मूक प्रतीक्षक)		44-53
1.0	विषय क्षेत्र	45
2.0	शब्दावली	45
3.0	सामग्रियां	45
4.0	सुरक्षा गुणक	45
5.0	गाइड	45
6.0	बफर	45
7.0	लिफ्ट कार	45
8.0	लिफ्ट कूप	46

Sl. No.	Name of Head	Page No.
10.0	Guide Shoes	25
11.0	Lift Ropes	25
12.0	Safety Equipments	26
13.0	Lift Operations	28
14.0	Controlling Equipments	31
15.0	Lift Rope Compensation	34
16.0	Automatic Rescue Devices	34
SECTION II- HYDRAULIC LIFTS		35-43
1.0	Type of Hydraulic Lifts	36
2.0	Terminology	36
3.0	Construction Requirements	39
4.0	Machine, Jack and other Hydraulic Equipment	39
5.0	Dimensional Tolerances	41
6.0	Machine Rooms	41
7.0	Guide Rails, Guide shoes and Buffers	42
8.0	Lift car and Car frames	42
9.0	Car doors, Landing doors & Locking Devices	42
10.0	Precautions against free fall of car, Descent with excessive speed and creeping	42
11.0	Safety Gears	42
12.0	Suspension	43
13.0	Controller & Operating Devices	43
14.0	Terminal stopping and final Limit Switches	43
SECTION III- SERVICE LIFTS (DUMB WAITERS)		44-53
1.0	Scope	45
2.0	Terminology	45
3.0	Materials	45
4.0	Factor of Safety	45
5.0	Guides	45
6.0	Buffers	45
7.0	Lift Car	45
8.0	Lift Wells	46

क्रम संख्या	विषय	पृष्ठ संख्या
9.0	संरचना-शक्ति और लदान	50
10.0	लोड प्लेट	50
11.0	प्रति भार	50
12.0	सुरक्षा गियर	50
13.0	निलंबन (सस्पेंशन) के उपाय तथा बंधक	51
14.0	चालन मशीन	52
15.0	नियंत्रक और प्रचालन युक्तियाँ	52
16.0	टर्मिनल अवरोधन तथा अंतिम सीमा स्विच	52
17.0	बिजली के तार लगाना और उपकरण	53
18.0	मशीन कक्ष की स्थिति निर्धारण	53
19.0	मशीन कक्ष	53
20.0	अग्नि रक्षण	53
21.0	परीक्षण	53
खण्ड - IV लिफ्ट अधिष्ठापनों का परीक्षण		54-57
1.0	स्थल पर परीक्षण	55
2.0	विनिर्माणकर्ता के कार्यों पर परीक्षण	56
3.0	निष्पादन परीक्षण	57
खण्ड - V - एस्कलेटर (चल सोपान)		58-66
1.0	शब्दावली	59
2.0	एस्कलेटरों का निर्माण अधिष्ठापन, रक्षण, प्रचालन और अनुरक्षण	59
3.0	निर्माण की आवश्यकताएं	59
4.0	चालन मशीन, मोटर और ब्रेक	62
5.0	प्रचालन और सुरक्षा युक्तियाँ	62
6.0	मशीन कक्ष	63
7.0	प्रकाश व्यवस्था, अभिगम और विद्युत कार्य	63
8.0	अतिरिक्त सावधानियाँ और आवश्यकताएं	64
9.0	आग से कैचियों और मशीन अवकाशों का रक्षण	65
10.0	फर्श द्वारों का रक्षण	65
11.0	परीक्षण	65
परिशिष्टियाँ		
I	विद्युत संकर्षण लिफ्टों के कारों और प्रतिभारों के लिए तल रनबाई	67
II	तकनीकी विवरण	69
III	लिफ्टों के संयुक्त निरीक्षण के लिए जाँच सूची	70
IV	बॉम्बे लिफ्ट अधिनियम और नियम	73
V	डिज़ाइन और अभिन्यास	90
VI	अग्नि सुरक्षा संबंधी आवश्यकताएं	99
VII	रोधिका मुक्त आवश्यकताएं	100
VIII	सार्वजनिक भवनों में लिफ्टों की सुरक्षा-सी.वी.सी की रिपोर्ट तथा प्रदर्शित किए जाने वाले अनुदेश	101
IX	लिफ्ट अधिष्ठापनों से संबद्ध भारतीय मानकों की सूची	108
X	नमूना एन आई टी	109

Sl. No.	Name of Head	Page No.
9.0	Structural Strength & Loading	50
10.0	Load plate	50
11.0	Counter Weight	50
12.0	Safety Gear	50
13.0	Means of Suspension and Fastenings	51
14.0	Driving Machine	52
15.0	Controller and Operating Devices	52
16.0	Terminal Stopping and Final limit Switches	52
17.0	Electrical Wiring and Apparatus	53
18.0	Positioning of Machine Room	53
19.0	Machine Room	53
20.0	Fire Protection	53
21.0	Testing	53
SECTION IV- TESTING OF LIFT INSTALLATIONS		54-57
1.0	Tests at site	55
2.0	Test at manufacturer's works	56
3.0	Performance test	57
SECTION V- ESCALATORS		58-66
1.0	Terminology	59
2.0	Construction, Installation, Protection, Operation and Maintenance of Escalators	59
3.0	Construction Requirements	59
4.0	Driving Machine, Motor and Brake	62
5.0	Operating and Safety Devices	62
6.0	Machine Room	63
7.0	Lighting, Access and Electrical Work	63
8.0	Additional Precautions and Requirements	64
9.0	Protection of Trusses and Machine Spaces against Fire	65
10.0	Protection of Floor Openings	65
11.0	Testing	65
APPENDICES		
I	Bottom Runby for Cars & Counter weights for electric traction lifts	67
II	Technical Particulars	69
III	Check List for Joint Inspection of lifts	70
IV	Bombay Lift Act & Rules	73
V	Design & Layouts	90
VI	Fire Safety requirements	99
VII	Barrier Free requirements	100
VIII	Safety of Lifts in Public buildings- CVC report & Instructions to be displayed	101
IX	List of Indian Standards connected with Lift & Escalator Installation	103
X	Specimen NIT	109

संशोधनों का संदर्भ

क्रम सं०	संदर्भ जिसके अधीन जारी हुआ	अध्याय सं०	मद सं०	पृष्ठ

REFERENCES OF AMENDMENTS

Sl. No.	Reference under which issued	Chapter No.	Item No.	Page

खण्ड - I

विद्युत संकषण लिफ्ट

SECTION -I

ELECTRIC TRACTION LIFTS

अध्याय - I

सामान्य

- 1.0 **विषय क्षेत्र**
इन सामान्य विशिष्टियों में पूर्ति किए जाने वाले उपस्कर तथा प्रेषण, स्थल पर सुपुर्दगी, अधिष्ठापन, परीक्षण से पूर्व यथावश्यक निरीक्षण और वैद्युत, द्रवचालित, सेवा लिफ्टों और एस्केलटर्स को चालू दशा में सौंपने से संबंधित विवरण शामिल हैं।
- 1.1 **सम्बंधित दस्तावेज**
इन तकनीकी विशिष्टियों को सभी संशोधन पत्रियों सहित संविदा की सामान्य शर्तों के साथ-साथ अनुसूचियों और आरेखों के साथ मिलाकर पढ़ा जाएगा। इन विशिष्टियों तथा परस्पर-संबंधित संविदा दस्तावेजों के बीच किसी विसंगति के मामले में निविदा विशिष्टियों के अनुसार तकनीकी आवश्यकताओं का अनुकरण किया जाएगा तथा इसे सर्वोपरि महत्व दिया जाएगा।
- 1.2 **शब्दों की परिभाषा**
इन सामान्य विशिष्टियों में प्रयुक्त शब्दों की परिभाषाएं अध्याय-II में दी गयी हैं।
- 2.0 **आवश्यकता, परिणाम और अवस्थिति**
किसी विशेष प्रयोग के लिए लिफ्टों की संख्या, चाल, क्षमता तथा प्रकार तथा किसी विशेष भवन में उनके स्थान का निर्णय आई. एस: 14665 (भाग-1) 2000 के सुझावों के अनुसार किया जाएगा तथापि लिफ्टों की आवश्यकताओं, परिमाण तथा अवस्थिति संबंधी कुछ सामान्य बिंदु आगे के पैराओं में दिए गये हैं।
- 2.1 **आवश्यकता**
सेवा प्रदान किए जाने वाले तलों की संख्या चार से अधिक होने या भवन की ऊँचाई 14.5 मीटर से अधिक होने पर ही सामान्यतः यात्री लिफ्टें उपलब्ध करायी जाएंगी। परन्तु विशेष उद्देश्यों के लिए लिफ्टें, यथा अस्पताल लिफ्ट, माल लिफ्ट, वी. आई. पी लिफ्ट, विशेष आवश्यकता के अनुसार कम तलों वाले भवनों की सेवा के लिए उपलब्ध करायी जा सकती हैं।
- 2.2 **लिफ्टों की संख्या**
- 2.3 किसी विशेष भवन के लिए लिफ्टों की संख्या संबंधी निर्णय संभावित भावी विस्तार को ध्यान में रखकर किया जाएगा। वांछित सेवा के परिमाण और गुणता की विस्तृत जाँच पड़ताल करना महत्वपूर्ण है।
- 2.4 **अवस्थिति और अभिन्यास**
- 2.4.1 यात्री लिफ्टों का स्थान ऐसे स्थान पर होना चाहिए ताकि वहाँ भवन के विभिन्न प्रवेश द्वारों से आसानी से पहुँचा जा सके। अधिकतम क्षमता के लिए वे ग्रुपबद्ध तथा भवन में उचित स्थान पर अवस्थित होनी चाहिए। माल लिफ्टें माल के न्यूनतम क्षैतिज संचलन प्राप्त करने के लिए इसी प्रकार के स्थान पर लगी होनी चाहिए। लिफ्टों की आदर्श व्यवस्था संबंधित भवन में विशेष उपयोग पर निर्भर होती है और इसका निर्णय मामलागत आधार पर किया जाएगा। किसी विशेष भवन में लिफ्ट अधिष्ठापन में स्थान का चयन करते समय स्थानीय नगर के कानूनों के अनुसार अग्नि बचाव पहलू तथा गर्त में जल प्रवेश करने से रोक को भी ध्यान में रखा जाएगा।

CHAPTER-I

GENERAL

1.0 **Scope :**

These general specifications cover the details of equipment to be supplied, inspection as may be necessary before despatch, delivery at site, installation, testing, commissioning and handing over in working condition of Electrical, Hydraulic, Service Lifts and Escalators.

1.1 **Related documents :**

These technical specifications shall be read in conjunction with the General Conditions of contract with all correction slips, as well as schedules and drawings. In the event of any discrepancy between these specifications and inter-connected contract documents, the technical requirements as per the tender specifications shall be followed and deemed to be having overriding value.

1.2 **Definition of terms:**

The definition of terms used in these general specifications are given in Chapter II.

2.0 **Requirement, quantity and location**

Number, speed, capacity and type of lifts for particular usage and their location in a particular building shall be decided in accordance with the recommendations of IS: 14665 (part-I) 2000. However, certain general points regarding the requirements, quantity and location of lifts are given in the following paragraphs.

2.1 **Requirement**

The passenger lifts shall normally be provided only when the number of floors to be served exceeds four or the height of the building exceeds 14.5 meters. However, lifts for special purposes such as hospital lift, goods lift and VIP lift may be provided to serve even a lesser number of floors depending upon the particular requirements.

2.2 **Number of lifts**

2.3 The number of lifts for a particular building shall be decided keeping in view any probable future expansion. It is important to have a thorough investigation of quantity and quality of service desired.

2.4 **Location and Layout :**

2.4.1 The passenger lifts shall be so placed as to be easily accessible from various entrances to the building. For maximum efficiency they should be grouped and located suitably in the building. Goods lifts shall also be similarly placed for achieving least horizontal movement of goods. The ideal arrangement of lifts depends upon the particular use in the respective building and shall be determined in every individual case. In selecting the location for lift installation in any building particular attention shall also be taken to the fire rescue aspect in conformity with the local municipal by laws and prevention of water entry into the pit.

2.5 यात्री लिफ्टें

2.5.1 आवासीय भवन - प्रत्येक तल पर फ्लैटों की संख्या अधिक न होने पर लिफ्ट सुविधाजनक रूप से सीढ़ी के निकट स्थापित की जा सकती है। परन्तु, यदि प्रत्येक तल पर फ्लैटों की संख्या अधिक हो तो लिफ्ट शैफ्ट आसन्न भवन में सुविधाजनक रूप से अवस्थित की जा सकती है।

2.5.2 कार्यालय भवन और अस्पताल - सामान्यतः भवन में एक या अधिक सुविधाजनक बिंदुओं पर सीढ़ी के निकट एक या अधिक के समूह में दो या अधिक सीढ़ियां स्थापित करना सुविधाजनक समझा गया है। लिफ्ट समूह स्थापित करते समय भवन के विभिन्न भागों में आवागमन के पैटर्न को भी ध्यान में रखा जाना चाहिए।

2.5.2.1 दुकानें तथा विभागीय भंडार - इन भवनों में लिफ्टें प्रत्येक तल के लिए यथा सुविधाजनक तथा सुगम स्थान पर स्थापित की जानी चाहिए।

2.6 माल लिफ्ट

2.6.1 कार्यालय भवनों कारखानों, माल गोदामों आदि में माल लिफ्टों की अवस्थिति भवन में की गयी प्रगति की प्रवृत्ति, लदान प्लेटफार्मों की स्थिति, रेलवे साइडिंग आदि को ध्यान में रखते हुए पूरे भवन में माल के प्रगामी संचालन के अनुरूप आयोजित होनी चाहिए। जहाँ भी संभव हो लिफ्टों को धुवाँ या धूल भरे परिवेश में या वहाँ जहाँ इस पर अति अधिक तापक्रम प्रभाव डाल सकता हो अधिष्ठापित करने से बचना चाहिए। जहाँ इस प्रकार का अधिष्ठापन अपरिहार्य हो वहाँ उपस्कर का डिजाइन और निर्माण पर्यावरणीय दशाओं के अनुकूल होना चाहिए।

2.6.2 अस्पताल लिफ्टें

अस्पताल की लिफ्टें वाडों, ऑपरेशन थिएटर और अन्य ऐसे क्षेत्रों जहाँ रोगी को ले जाने की आवश्यकता पड़ती हो, के निकट होनी चाहिए।

3.0 सांविधिक नियमों, विनियमों, मानकों और सुरक्षा संहिताओं के अनुरूप

अधिष्ठापन स्थानीय लिफ्ट अधिनियमों और नियमों के अनुरूप किया जाएगा। उदाहरण स्वरूप मुंबई के लिए बॉम्बे लिफ्ट अधिनियम, पश्चिम बंगाल के लिये पश्चिम बंगाल लिफ्ट और एस्केल्टर अधिनियम, दिल्ली आदि के लिए यथा विस्तारिक बाम्बे लिफ्ट अधिनियम हैं। उन स्थानों पर जहाँ कोई स्थानीय लिफ्ट अधिनियम नहीं है वहाँ बॉम्बे लिफ्ट अधिनियम का पालन किया जाएगा। अधिष्ठापन स्थानीय नगरनिगम की उपविधियों की आवश्यकताओं के भी अनुरूप होगा। दिल्ली के लिए यथा लागू बाम्बे लिफ्ट अधिनियम और नियम का सार परिशिष्ट- 'IV' में दिया गया है।

3.1 भारतीय विद्युत अधिनियम और नियम

विद्युत लिफ्टों के अधिष्ठापन से संबंधित सभी वैद्युत कार्य भारतीय विद्युत अधिनियम, 1910 तथा भारतीय विद्युत नियम, 1956 (अद्यतन यथा संशोधित) के अनुसार निष्पादित किए जाने चाहिए। विद्युत कार्यों के लिए सी. पी. डब्लू. डी. के सामान्य विनिर्देश भाग - I (आंतरिक), 1994 तथा भाग-II (बाह्य), 1994 अद्यतन यथा संशोधित यथा संगत, के भी अनुरूप होना चाहिए।

3.2 सुरक्षा संहिताएं तथा श्रम विनियम

संविदाकार अपने स्वयं के खर्चों पर सांविधिक विनियमों आई एस प्रतिवेदनों, कारखाना अधिनियम के अधीन आने वाले विनियमों आदि, यथा लागू और लिफ्ट अधिष्ठापन के लिए उसके द्वारा प्रत्यक्ष या अप्रत्यक्ष रूप से नियोजित सभी श्रमिकों के संबंध में समय-समय पर जारी अनुदेशों के अनुसार सुरक्षा प्रावधानों के लिए व्यवस्था करेगा।

संविदाकार जहाँ भी आवश्यक हो, बाड़ चैतावनी संकेत तथा अन्य सुरक्षा उपाय आदि उपलब्ध कराएगा ताकि दुर्घटना से बचा जा सके। इसके अलावा परिशिष्ट - 'VI' में दी गयी सभी सुरक्षा प्रक्रियाओं को अपनाया जाएगा।

2.5 **Passenger Lifts**

2.5.1 **Residential buildings**- When the number of flats per floor are not many the lift may be conveniently placed near a stair-case. However, if the number of flats in each floor is substantial the lift may conveniently be located in a shaft adjoining the building.

2.5.2 **Office building and Hospital**- It is generally found convenient to have bank of two or more lifts at one or more convenient points in the building with one or more banks near a stair case. Traffic pattern in various parts of the building shall also be taken into account while locating the lift banks.

2.5.2.1 **Shops and Departmental stores**- Lifts in these buildings shall be so placed as to secure convenient and easy access to each floor.

2.6 **Goods Lifts**

2.6.1 The location of goods lifts in office buildings, factories, warehouses etc., shall be planned to suit the progressive movement of goods throughout the building having regard to the nature of the process carried out in the building, the position of loading platforms, railway sidings etc. The placing of lifts in a fume or dust laden atmosphere and where it may be exposed to extreme temperature shall be avoided wherever possible. Where such an installation is unavoidable the equipment should be of suitable design and construction to suit the environmental conditions.

2.6.2 **Hospital lifts**

Hospital lifts shall be situated near the wards, operation theatre and such other areas where patients are required to be taken.

3.0 **Conformity with statutory Acts, Rules, regulations, Standards and Safety Codes**

The installation shall be carried out in conformity with the local lifts Act and Rules. For example the Bombay Lifts Act for Bombay, the West Bengal Lifts and Escalators Act for West Bengal, the Bombay Lifts Act as extended to Delhi for Delhi etc. At other places where no local Lifts Act is in force the Bombay Lift Act shall be followed. The installation shall also conform to requirements of Local Municipal Bylaws.

Extracts of Bombay Lift Act and Rules as applicable for Delhi are appended at Appendix 'IV'.

3.1 **Indian Electricity Act and Rules**

All electrical works in connection with installation of electric lifts shall be carried out in accordance with the provisions of Indian Electricity Act 1910 and the Indian Electricity Rules 1956 amended upto date. The electrical works shall also conform to CPWD General Specifications for Electrical works Part-I (Internal) 1994 and Part-II (External) 1994 as amended upto date wherever relevant.

3.2 **Safety Codes and labour regulations**

The contractor shall at his own expenses arrange for the safety provisions as per the statutory regulations, IS recommendations, regulations under factory Act etc. , where applicable and instructions issued from time to time in respect of all labour employed by him directly or indirectly for the installation of the lift.

The contractor shall provide necessary barriers, warning signs and other safety measures etc., wherever necessary so as to avoid accident. In addition all safety procedures as outlined in Appendix 'VI' shall be complied with.

चूक के मामले में, विभाग को व्यवस्थाएं करने तथा उपर्युक्त सुविधाएं उपलब्ध कराने तथा संविदाकार से लागत वसूलने की स्वतंत्रता होगी। वह इस संबंध में उसकी उपेक्षा के कारण उत्पन्न होने वाले क्षतिपूर्ति दावों के विरुद्ध सी. पी. डब्ल्यू. डी. को भी क्षतिपूर्ति करेगा।

3.3 आग विनियम

अधिष्ठापन स्थानीय आग विनियमों और इसके नियमों के अनुरूप, यथा लागू यथा प्रवृत्त निष्पादित किया जाएगा।

4.0 विभाग द्वारा किए जाने वाले कार्य

विभाग केवल निम्नलिखित कार्यों के लिए उत्तरदायी होगा और इन्हें सफल निविदाकार के कार्यक्षेत्र में शामिल नहीं किया है:

4.1 प्रत्येक लिफ्ट/एस्कलेटर के लिए लिफ्ट मशीन कक्ष में अलग अलग 3 कला, 4-तार, 50 हर्ट्ज, 415 वोल्ट की ए. सी. विद्युत पूर्ति दी जाएगी साथ ही विद्युत संकर्षण लिफ्टों और एस्कलेटरों के मामलों में उचित आकार की टी पी तथा दोहरी भूसंपर्कन वाली एन स्विच फ्यूज, जैसा भी मामला हो, उपलब्ध कराया जाएगा।

4.2 प्रत्येक विद्युत संकर्षण लिफ्टों के लिए भू-तल पर उचित आकार की टी पी और एन स्विच फ्यूज के लिए भी व्यवस्था की जाएगी।

4.3 उपर्युक्त आकार की एस. पी. और एन. स्विच फ्यूज से अंतकृत (टर्मिनेट की गयी) एक कला 50 हर्ट्ज, 230 वोल्ट ए. सी. विद्युत पूर्ति की व्यवस्था।

4.4 अधिष्ठापन परीक्षण और कमीशन अवधि के दौरान जल और विद्युत की मुफ्त पूर्ति।

4.5 निष्कासक पंखे युक्त समूचित संवातित मशीन कक्ष, लिफ्ट कूप तथा जलरोधी लिफ्ट गर्त।

4.6 उपर्युक्त भंडारण अवकाश की व्यवस्था।

4.7 मशीन कक्ष तथा सभी अवतरणों पर पर्याप्त प्रकाश व्यवस्था।

4.8 लिफ्ट कूप और ट्रेप द्वार के ऊपर बीम और हुक लगाने का प्रावधान।

4.9 मशीन अधिष्ठापन के पश्चात् खुले स्थान को ढकने के लिए लिफ्ट कूप भाग में मशीन कक्ष में आवश्यक फर्श करना।

4.10 लिफ्ट के प्रवेश द्वारों पर प्रस्तसाद कार्य।

4.11 उच्चतम अवतरण से या बरजे से मशीन कक्ष के लिए सीढ़ी।

5.0 संविदाकार द्वारा किए जाने वाले कार्य

विनिर्माण, पूर्ति, अधिष्ठापन, परीक्षण, तथा लिफ्ट कमीशन करने के अलावा जिसमें सहायक उपस्कर भी शामिल हैं, निम्नलिखित कार्यों को संविदाकार द्वारा किए जाने वाले कार्यों की परिधि में शामिल किया जाएगा।

In case of default the department shall be at liberty to make arrangements and provide facilities as aforesaid and recover the cost from the contractor.

He shall also indemnify CPWD against claims for compensation arising out of his negligence in this regard.

3.3 **Fire Regulations**

The installation shall be carried out in conformity with the local fire regulations and rules thereunder wherever they are in force.

4.0 **Works to be done by the Department**

The department shall be responsible for the following works only and these are excluded from the scope of the successful tenderer :

4.1 Provision of 3 phase, 4 wire , 50 Hz, 415 Volts .A.C. power supply terminated in the lift machine room separately for each lift/ escalator with suitable sized TP & N switch fuse with double earthing in case of electric traction lifts and escalators as the case may be.

4.2 Provision shall also be made for suitable size TP&N switch fuse at the ground floor for each electric traction lifts.

4.3 Provision of single phase 50 Hz 230 V A.C. power supply terminated with suitable sized SP& N switch fuse for lighting in the machine room and lift well

4.4 Free water and power supply during installation, testing and commissioning periods.

4.5 Properly ventilated machine room with exhaust fans, lift well and water proof lift pit.

4.6 Provision of suitable storage space.

4.7 Provision of adequate lighting in the machine room and at all landings.

4.8 Provision of hoisting beam or hook above the lift well and trap door.

4.9 Necessary flooring in the lift well portion in the machine room to cover the open areas after installation of machine

4.10 Architrave work at lift entrances.

4.11 Stair case from the top most landing or terrace to machine room.

5.0 **Works to be done by the contractor**

In addition to the manufacture, supply, installation, testing and commissioning of the lift including all auxiliary equipment, following works shall be deemed to be included within the scope of the work to be done by the contractor.

- 5.1 उपस्कर के अधिष्ठापन के लिए आवश्यक सभी छोटे निर्माण कार्य यथा दीवारों / फर्शों में द्वार, या तो आर सी. सी. के या ईट चिनाई आदि के बनाना, तथा मूल दशा और परिष्कृत रूप में वापस लाना। छोटे निर्माण कार्यों की परिधि में आर. एस. जॉयस्ट आलम्बन के लिए बने या बनाए जाने वाले आधार कंक्रीट पैडों की सभी ग्राउटने (अभिपूरण), सभी बोर्डों क्लैपों, आलम्बों आधार बोल्टों की ग्राउटने तथा स्थिरण मशीन कक्ष, लिफ्ट कूप या गर्त में आर. एस. जॉयस्ट की स्थिति अधिष्ठापन शामिल हैं। इसमें मार्बल की कटाई तथा विभाजक दीवार बनाने के कार्य नहीं भी हों, शामिल नहीं हैं।
- 5.2 मशीन कक्ष या आवश्यकतानुसार अन्य स्थलों में लिफ्ट अधिष्ठापन के लिए आवश्यक आर. एस. जॉयस्ट या एंगल लौह आलम्ब ब्रैकेट आदि की पूर्ति उनको स्थिति में अधिष्ठापित करना भी शामिल है।
- 5.3 सभी विद्युत कार्य जिसमें उपयुक्त स्विच फ्यूज यूनिट/बोर्ड पर अंतकृत मशीन कक्ष के लिए मुख्य संयोजन तथा भूसंपर्कन करना शामिल नहीं है। सभी विद्युत कार्य, जिसमें मशीन कक्ष में दिए जाने वाले इस स्विच/बोर्ड से अंतः संयोजन तथा भूमि-छड़ (अर्थ-बार) से लूप भू-संपर्कन शामिल हैं सफल संविदाकार द्वारा किया जाएगा।
- 5.4 लिफ्ट सामग्रियों को अधिष्ठापित किए जाने तक उठाईगिरी और क्षति से बचाव सुनिश्चित करने का उत्तरदायित्व समनुदेशिती को सौंपा जाता है।
- 5.5 सभी पाइंटें, उत्थापन कार्य के दौरान लिफ्ट कूप में यथा आवश्यक और बाद में हटा ली जाती हैं।
- 5.6 प्रत्येक अवतरण पर चेतावनी बोर्डों के साथ अस्थाई बाड़ ताकि कार्य निष्पादन के दौरान दुर्घटना को रोका जा सके।
- 5.7 इस्पात से बनी अवतरण सम्मुख प्लेटें आवश्यक क्लैपों सहित सिल(देहली) आलम्ब एंगल, लिफ्ट अधिष्ठापन के लिए आवश्यक आधार बोल्ट आलम्ब आदि की पूर्ति और अधिष्ठापन।
- 5.8 विनियमों के अधीन यथावश्यक लिफ्ट गर्त अर्थात् पिट तक पहुँचने के लिए इस्पात सीढ़ी उपलब्ध करायी जाएगी।
- 6.0 **अन्य एजेंसियों के साथ समन्वय**
सफल संविदाकार लिफ्ट अधिष्ठापन कार्य को भवन निर्माण में संलग्न अन्य संविदाकारों/एजेंसियों के साथ, यदि कोई हो समन्वित करेगा तथा सभी तकनीकी सूचनाओं का मुक्त रूप से आदान-प्रदान करेगा ताकि संविदा कार्यों के निष्पादन को निर्बाध बनाया जा सके।
- 7.0 **निविदा की पूर्णता**
सभी फिटिंग्स, उपस्कर, यूनिटें, ऐसेम्बली और हिस्से-पुर्जे, हार्डवेयर, आधार बोल्ट, विद्युत संयोजनों के लिए टर्मिनल लग्स, केबिल ग्लैंड जंक्शन बॉक्स तथा कुशल ऐसेम्बली कार्यकरण तथा अधिष्ठापन के लिए उपयोगी और आवश्यक मर्दे कार्य की परिधि में शामिल की गयी समझी जाएंगी। अधिष्ठापन कार्य सभी प्रकार से पूरा किया जाएगा भले ही उनके विवरणों का उल्लेख विशिष्टियों में किया गया हो या नहीं।
- 8.0 **कार्य अधिनिर्णय के पश्चात् संविदाकार द्वारा प्रदान की जाने वाली सूचना**
स्वीकृति पत्र की प्राप्ति की तारीख से 4 सप्ताह की अवधि के भीतर संविदाकार विभाग को प्रारम्भिक आरेख जमा करने

- 5.1 All minor building work necessary for installation of equipment such as making of openings in walls/ floors, either of RCC or brick masonry etc., and restoring them to original condition and finish. The scope of minor building work includes all grouting of foundation concrete pads to be formed or made as base for supporting R.S. joists etc., grouting and anchoring of all boards, clamps, supports, foundation bolts, installation in position of R.S joists in the machine room, lift well or in the pit, Such works shall exclude cutting of marble work and construction of partition wall wherever involved.
- 5.2 Supply of necessary R.S. joists or angle iron supports brackets etc., for installation of the lift, either in the machine room or at other places as may be necessary including their installation in position.
- 5.3 All electrical works except bringing in main connection and earth connection to the machine room terminated on suitable switch fuse unit/ board. All electrical works including inter-connection from this switch/ board and loop earthing from the earth bar to be provided in the machine room shall be done by the successful contractor.
- 5.4 Responsibility to ensure safety of lift materials against pilferage and damage till the installation is handed over to the consignee.
- 5.5 All scaffolding as may be necessary in the lift well during erection work and subsequently removed.
- 5.6 Temporary barricades with caution boards at each landing to prevent accident during execution of work.
- 5.7 Supply and installation of landing facia plates made of steel, car apron plates, sill support angles with necessary clamps, foundation bolts supports etc., as are necessary in connection with the installation of the lift.
- 5.8 Steel ladder to be provided for access to lift pit wherever required under regulations.
- 5.9 **Coordination with other agencies**
The successful contractor shall coordinate lift installation work with other contractor/ agencies engaged in construction of building if any and exchange freely all technical information so as to make the execution of works contract smooth.
- 7.0 **Completeness of tender**
All fittings, equipments, units, assemblies and accessories, hardware, foundation bolts, terminal lugs for electrical connections, cable glands, junction box and items which are useful and necessary for efficient assembly in operation and installation shall be deemed to have been included in the scope of work. The installation shall be complete in all details whether such details have been mentioned in the specifications or not.
- 8.0 **Information to be supplied by contractor after award of work**
Within a period of 4 weeks from the date of receipt of letter of acceptance the contractor shall

उपस्कर विनिर्माण, अधिष्ठापन, परीक्षण, कमीशनिंग तथा हस्तांतरण के लिए अपना कार्यक्रम बार चार्ट उपलब्ध कराएगा । इसे निर्माण समापन कार्यक्रम के साथ परस्पर संबंधित होना चाहिए । संविदाकार के लिए यह आवश्यक है वह 4 सप्ताह की अवधि के भीतर, कार्य प्रारम्भ करने से पहले, विभाग के अनुमोदन के लिए निम्नलिखित आरेख और सूचना तीन प्रतियों में प्रस्तुत करे :

- (क) सभी सामान्य विन्यास आरेख ।
- (ख) उपस्करों के लिए आधारों के विवरण, अन्य एजेंसियों के लिए सामान्यतः आवश्यक विभिन्न संयोजित उपस्करों के लिए लोड डाटा अवास्थिति आंकड़ों में गाइडों पर भंजन भार (ब्रेकिंग लोड) लिफ्ट गतों पर बफर्स की प्रतिक्रिया, मशीन कक्ष तथा लिफ्ट कूप आदि में आलम्ब बिंदुओं पर प्रतिक्रिया शामिल है ।
- (ग) प्रत्येक यूनिट/इनके ग्रुपों के लिए उत्पादन उद्देश्यों के लिए आवश्यक विभाओं सहित, पूर्ण अभिन्यास विभाएं ।
- (घ) ऐसा कोई अन्य आरेख/सूचना जिसका ऊपर उल्लेख नहीं किया है परन्तु संविदाकार द्वारा जॉब के लिए आवश्यक समझा गया है ।
- (ङ) स्वीकृत निविदा के अनुसार विभाग द्वारा निष्पादित की जाने वाली मदों की सूची ।

9.0

कार्य प्रारम्भ

प्रारम्भिक आरेखों के अनुमोदित हो जाने के तुरन्त बाद संविदाकार को कार्य प्रारम्भ कर देना चाहिए । संविदाकार विभाग को अंतिम आरेखों के 7-सेट भी भेजेगा तथा विभाग एक प्रति लौटा देगा ।

provide the department his programme bar chart for submission of preliminary drawing, manufacturing of equipment, installation, testing, commissioning and handing over. This should be corelated with the building completion programme. The contractor shall be required to submit in triplicate the following drawings and information within the above 4 weeks period for approval of the department before commencing the work :

- (a) All general arrangement drawings;
- (b) Details of foundations for equipments, load data location etc. of various assembled equipment as may be needed generally by other agencies for purpose of their work. The data will include breaking load on guides, reaction of buffers on lift pits, reaction on support points in machine room, lift well etc.
- (c) Complete layout dimensions for every unit/ group of units with dimensions required for erection purposes.
- (d) Any other drawing/ information not specifically mentioned above but deemed to be necessary for the job by the contractor.
- (e) List of items to be carried out by the department in accordance with the tender accepted.

9.0 Commencement of work

As soon as the preliminary drawings are approved, the contractor should commence work. The contractor shall also send seven sets of final drawings to the department who shall return one copy.

अध्याय - II

शब्दावली

- 1.0 निम्नलिखित विशिष्टियों की परिभाषाएं निम्नवत होंगी:
- 1.1 **अधस्तल कार रनबाई**
यह, कार को अधस्तल टर्मिनल अवतरण के स्तर पर होने पर कार बफर प्रघातक प्लेट तथा कार बफर के आघाती पृष्ठ के बीच की दूरी है ।
- 1.2 **अधस्तल प्रतिभार रनबाई**
यह, कार को अधस्तल टर्मिनल अवतरण के स्तर पर होने पर प्रतिभार बफर प्रघातक प्लेट तथा प्रतिभार बफर के आघाती पृष्ठ के बीच की दूरी है ।
- 1.3 **बफर**
यह, अवरोही कार या प्रतिभार की गतिज ऊर्जा के एकत्रण या अवशोषण द्वारा तथा क्षय करके कार या प्रतिभार को इसकी यात्रा की सामान्य सीमा से आगे जाने से रोकने के लिए डिजाइन की गयी युक्ति है।
- 1.3.1 **तेल बफर**
अवरोही कार या प्रतिभार की गतिज ऊर्जा को अवशोषित या क्षय करने वाला ऐसा बफर जिसमें तेल का उपयोग माध्यम के रूप में किया जाता है।
- 1.3.1.1 **तेल बफर स्ट्रोक**
यह बफर प्लंजर या पिस्टन की तेल प्रतिस्थापन गति को त्वरित करने की युक्ति है तथा इसमें बफर प्लंजर का प्रगमन शामिल नहीं है ।
- 1.3.1.2 **स्प्रिंग बफर**
एक ऐसा बफर जो अवरोही कार या प्रतिभार की गतिज ऊर्जा को स्प्रिंग में संचित करता है ।
- 1.3.1.3 **स्प्रिंग बफर भार रेटिंग**
यह इसके स्ट्रोक के बराबर स्प्रिंग को दाबित करने के लिए आवश्यक भार है ।
- 1.4 **आह्वान (कॉल) सूचक**
अवतरित हो रही लिफ्ट के परिचर को आह्वान के संबंध में सूचना देने के लिए कार की दृश्य और श्रव्य युक्ति ।
- 1.5 **कारकाय कार्य (बॉडीवर्क)**
इसमें लिफ्ट कार का कायकार्य अंतर्विष्ट है जिसमें कार के पार्श्व तथा छत और वह प्लेट फार्म जिस पर कार निर्मित है शामिल हैं ।
- 1.6 **कार ढांचा**
यह लिफ्ट कार का प्लेटफार्म, इसके सुरक्षा गियर, गाइड शूज और निलंबन रज्जु को संयोजित करने वाला सहायक ढांचा या स्लिंग है ।

CHAPTER-II
TERMINOLOGY

- 1.0 For the purpose of these specifications following definitions shall apply :-
- 1.1 **Bottom Car Runby**
The distance between the car buffer striker plate and the striking surface of the car buffer when the car is in level with the bottom terminal landing.
- 1.2 **Bottom Counter weight Runby**
The distance between the counterweight buffer striker plate and the striking surface of the counterweight buffer when the car is in level with the bottom terminal landing
- 1.3 **Buffer**
A device designed to stop a descending car or counterweight beyond its normal limit of travel by storing or by absorbing and dissipating the kinetic energy of the car or counterweight.
- 1.3.1 **Oil Buffer**
A buffer using oil as a medium which absorbs and dissipates the kinetic energy of the descending car or counterweight.
- 1.3.1.1 **Oil buffer stroke**
The oil-displacing movement of the buffer plunger or piston, excluding the travel of the buffer-plunger accelerating device.
- 1.3.1.2 **Spring-Buffer**
A buffer which stores in a spring the kinetic energy of the descending car or counterweight.
- 1.3.1.3 **Spring- buffer load rating** -
The load required to compress the spring by an amount equal to its stroke.
- 1.4 **Call Indicator**
A visual and audible device in the car to indicate to the attendant the lift landings from which calls have been made.
- 1.5 **Car Bodywork**
The enclosing bodywork of the lift car which comprises the sides and roof and is built upon the car platform.
- 1.6 **Car frame**
The supporting frame or sling to which the platform of the lift car, its safety gear, guide shoes and suspension ropes are attached.

1.7 कार प्लेटफार्म

यह फर्श बनाने तथा भार को सीधे टेक देने वाला लिफ्ट कार का हिस्सा है।

1.8 अवकाश

1.8.1 अधस्तल कार अवकाश

यह गर्त के फर्श से निम्नतम ढांचा या यांत्रिक हिस्सा, उपस्कर या कार प्लेटफार्म ऐग्रन के नीचे अधिष्ठापित युक्ति या 300 मि.मी. के भीतर अवस्थित गाड़ों की स्पष्ट ऊर्ध्वाधर दूरी है जो कार की पूर्णतः दाबित बफर युक्त विराम की स्थिति में कार के प्लेटफार्म के पार्श्व से क्षैतिज रूप से मापी जाती है ।

1.8.2 शीर्ष कार अवकाश

यह, उस समय जब कार फर्श शीर्ष टर्मिनल अवतरण के समतल हो, कार क्रासहेड के शीर्ष, या जहाँ कार क्रासहेड नहीं है का शीर्ष, तथा शिरोपरि संरचना या किसी अन्य अवरोध के निकटतम भाग के बीच की न्यूनतम ऊर्ध्वाधर दूरी है ।

1.8.3 शीर्ष प्रतिभार अवकाश

यह, उस समय जब कार फर्श अधरतल टर्मिनल अवतरण के समतल हो, प्रतिभार संरचना के किसी हिस्से और शिरोपरि संरचना या किसी अन्य अवरोध के निकटतम भाग के बीच की न्यूनतम ऊर्ध्वाधर दूरी है ।

1.9 नियंत्रण

यह सचल भाग के प्रवर्तन, रोकने, गति की दिशा, त्वरण, चाल तथा मंदन को नियंत्रित करने की प्रणाली है ।

1.9.1 एकल - चाल प्रत्यावर्ती धारा नियंत्रण

यह एकल चाल पर चलने के लिए व्यवस्थित प्रेरण मोटर की चालन मशीन के लिए नियंत्रण है ।

1.9.2 इलैक्ट्रॉनिक युक्तियाँ

यह लिफ्ट मोटर को परिवर्ती चाल पर चलाने के लिए इलैक्ट्रॉनिक युक्तियों युक्त एवं नियंत्रण प्रणाली है ।

1.9.3 प्रत्यावर्ती धारा परिवर्ती वोल्टता परिवर्ती आवृत्ति (ए.सी.वी.वी.वी.एफ) नियंत्रण

मशीन प्रेरण मोटर चालन के लिए दी जाने वाली परिवर्तनीय वोल्टता और आवृत्ति द्वारा स्थापित एक चाल नियंत्रण प्रणाली है ।

1.9.4 ठोस अवस्था डी.सी. परिवर्ती वोल्टता नियंत्रण

चालन मशीन डी.सी. मोटर के आर्मेचर को दी जाने वाली परिवर्ती विद्युत पूर्ति की वोल्टता और दिशा द्वारा स्थापित एक ठोस अवस्था चाल नियंत्रण प्रणाली है ।

1.10 प्रति भार

लिफ्ट कार के भार और रेटेड भार के हिस्से को प्रति संतुलित करने के लिए कोई भार या भार श्रृंखला ।

1.11 विक्षेपक चरखी (शीव)

रज्जु लोड की दिशा परिवर्तित करने के लिए प्रयुक्त निष्कर्मक पुली ।

1.12 दरवाजा

1.12.1 दरवाजा मध्य में खुला सरकवाँ

ऐसा दरवाजा जो क्षैतिज रूप से सरकता तथा इसमें मध्य से खुलने वाले दो या अधिक पैनल लगे होते हैं । ये परस्पर जुड़े तथा साथ-साथ गति करते हैं ।

1.7 **Car Platform**

The part of the lift car which forms the floor and directly supports the load.

1.8 **Clearance**

1.8.1 **Bottom Car Clearance**

The clear vertical distance from the pit floor to the lowest structural or mechanical part, equipment or device installed beneath the car platform aprons or guards located within 300mm, measured horizontally from the sides of the car platform when the car rests on its fully compressed buffers.

1.8.2 **Top Car Clearance**

The shortest vertical distance between the top of the car crosshead, or between the top of the car where no crosshead is provided, and the nearest part of the overhead structure or any other obstruction when the car floor is level with the top terminal landing.

1.8.3 **Top Counterweight Clearance**

The shortest vertical distance between any part of the counterweight structure and the nearest part of the overhead structure or any other obstruction when the car floor is level with the bottom terminal landing.

1.9 **Control**

The system governing starting, stopping, direction of motion, acceleration, speed and retardation of moving member

1.9.1 **Single-Speed Alternating Current Control**

A control for a driving machine induction motor which is arranged to run at a single-speed.

1.9.2 **Electronic Devices**

A system of control which is accomplished by the use of electronic devices for driving the lift motor at variable speed.

1.9.3 **Alternating Current Variable Voltage Variable Frequency (ACVVVF) Control**

A system of speed control which is accomplished by varying the voltage and frequency of the power supply to the driving machine induction motor.

1.9.4 **Solid-State d.c. Variable Voltage Control**

A solid-state system of speed control which is accomplished by varying the voltage and direction of the power supply to the armature of driving machine d.c. motor.

1.10 **Counter weight**

A weight or series of weights to counter-balance the weight of the lift car and part of the rated load.

1.11 **Deflector Shieve**

An idler pulley used to change the direction of a rope lead.

1.12 **Door**

1.12.1 **Door, Centre Opening Sliding**

A door which slides horizontally and consists of two or more panels which open from the centre and are usually so interconnected that they move simultaneously.

- 1.12.2¹ **दरवाजा मध्य-बार सिमटवाँ**
सामान्य ऊर्ध्वाधर घटकों के बीच आरोपित ऊर्ध्वाधर छड़ों वाले सिमटवाँ द्वारा ।
- 1.12.3 **दरवाजा एकल सरकवाँ**
क्षैतिज रूप से सरकने वाला एकल पैनल युक्त दरवाजा ।
- 1.12.4 **दरवाजा दोहरी चाल वाला सरकवाँ**
एक ऐसा दरवाजा जो क्षैतिज रूप से सरकता है इसमें दो पैनल लगे होते हैं जिनमें से एक दूसरे की दोगुनी चाल से गति करता है ।
- 1.12.5 **दरवाजा ऊर्ध्वाधर द्वि-विभाजक**
एक ऐसा दरवाजा जो ऊर्ध्वाधर रूप से सरकता तथा इसमें दो पैनल या पैनल सेट लगे होते हैं जो खुलने के लिए परस्पर एक दूसरे से दूर जाते हैं और इस प्रकार संयोजित होते हैं कि वे साथ-साथ गति करें ।
- 1.12.6 **दरवाजा ऊर्ध्वाधर उत्थापक**
एकल पैनल दरवाजा जो खुलते समय उसी दिशा में ऊर्ध्वाधर गति करता है ।
- 1.12.7 **दरवाजा दोलनी**
एकल पैनल युक्त एक ऐसा दरवाजा जो हाथ से खोला जाता है तथा स्प्रिंग क्लोजर मुक्त करके बंद किया जाता है ।
- 1.13 **दरवाजा संवरक (क्लोजर)**
हाथ से खोले गए दरवाजे को स्वचालित रूप से बंद करने की युक्ति ।
- 1.14 **दरवाजा प्रचालक**
दरवाजों को खोलने और बंद करने के लिए पॉवर प्रचालित युक्ति ।
- 1.15 **कार दरवाजा विद्युत संपर्क**
एक ऐसी विद्युत् युक्ति जिसका कार्य, उस समय तक जब तक कार का दरवाजा बंद स्थिति में न हो, सामान्य प्रचालन युक्ति द्वारा चालन मशीन को चालित होने से रोकना है ।
- 1.16 **वैद्युत और यांत्रिक अंतः पाश**
ऊपर और नीचे की, दोनों रिले को एक साथ प्रचालित होने से रोकने के लिए उपलब्ध करायी गयी युक्ति ।
- 1.17 **वैद्युत यांत्रिक पाश**
एक ऐसी युक्ति जो अवतरण और / या कार दरवाजों के लिए संयुक्त रूप से प्रयुक्त वैद्युत संपर्क और यांत्रिक पाश को एक इकाई में मिला देती है ।
- 1.18 **आपात रोक दाब या स्विच**
कार के भीतर प्रदान की गयी ऐसी दाब बटन या स्विच जिसे लिफ्ट कार को आपात स्थिति के दौरान रोकने के लिए नियंत्रण परिपथ को खोलने हेतु डिजाइन किया गया है ।
- 1.19 **फर्श समतलन स्विच**
दोगुनी चाल या परिवर्ती चाल वाली मशीनों के मामले में कार को निम्न चाल पर फर्श पर लाने के लिए स्विच ।
- 1.20 **फर्श-वरक (सेलेक्टर)**
कृत्रिम स्वचालित लिफ्टों में नियंत्रण उपस्कर के अंग के रूप में कार्य करने वाली एक ऐसी यंत्रावली जिसे ऊपेक्षित अवतरणों पर लिफ्ट कार को रोकने के लिए नियंत्रणों को प्रचालित करने के लिए डिजाइन किया गया है ।

1.12.2 **Door, Mid-Bar Collapsible**

A collapsible door with vertical bars mounted between the normal vertical members.

1.12.3 **Door, Single Slide**

A single panel door which slides horizontally.

1.12.4 **Door, Two Speed Sliding**

A door which slides horizontally and consists of two panels, one of which moves at twice the speed of the other.

1.12.5 **Door, Vertical Bi-parting**

A door which slides vertically and consists of two panels or sets of panel that move away from each other to open and are so interconnected that they move simultaneously.

1.12.6 **Door, Vertical Lifting**

A single panel door which slides in the same plane vertically up to open.

1.12.7 **Door, Swing**

A swinging type single panel door which is opened manually and closed by means of a spring closer when released.

1.13 **Door Closer**

A device which automatically closes a manually-opened door.

1.14 **Door Operator**

A power operated device for opening and closing doors.

1.15 **Car door Electric Contact**

An electric device, the function of which is to prevent operation of the driving machine by the normal operating device unless the car door is in the closed position.

1.16 **Electrical and Mechanical Interlock**

A device provided to prevent simultaneous operation of both up and down relays.

1.17 **Electro-Mechanical Lock**

A device which combines in one unit, electrical contact and a mechanical lock jointly used for the landing and/or car doors.

1.18 **Emergency Stop Push or Switch**

A push button or switch provided inside the car designed to open the control circuit to cause the lift car to stop during emergency

1.19 **Floor Levelling Switch**

A switch for bringing the car to level at slow speed in case of double speed or variable speed machines.

1.20 **Floor Selector**

A mechanism forming a part of the control equipment, in certain automatic lifts, designed to operate controls which cause the lift car to stop at the required landings.

- 1.21 **फर्श रोक (स्टॉपिंग) स्विच**
किसी पूर्व चयनित अवतरण पर या उसके निकट कार को स्वचालित रूप से विराम की स्थिति में लाने के लिए व्यवस्थित स्विच या स्विचों का समूह।
- 1.22 **गियर रहित मशीन**
एक ऐसी लिफ्ट मशीन जिसमें प्रचालन शक्ति मध्यवर्ती न्यूनकारी गियर के बिना मोटर से चालन शीव को प्रेषित की जाती है और जिसका ब्रेक ड्रम सीधे मोटर शैफ्ट पर आरोपित होता है।
- 1.23 **माल लिफ्ट**
ऐसी लिफ्ट जा मुख्यतः माल परिवहन के लिए डिजाइन की गयी है परन्तु यह माल लदाई या उतराई के लिए आवश्यक लिफ्ट परिचर या अन्य व्यक्तियों को भी ले जा सकती है।
- 1.24 **गाइड रेल स्थायीकरण**
गाइड रेल ब्रेकिट और इसके बंधनों की पूर्ण एसेम्बली।
- 1.25 **गाइड रेल शू**
लिफ्ट कार या प्रतिभार ढांचे (फ्रेम) को गाइड करने के लिए कार ढाँचे या प्रतिभार का संलगनी।
- 1.26 **अवतरण आह्वान दाब (कॉल पुश)**
लिफ्ट कार का आह्वान करने या आह्वान संकेतक को सक्रिय करने के लिए लिफ्ट अवतरण पर लगा दाब बटन।
- 1.27 **अवतरण दरवाजा**
लिफ्ट अवतरण पर लिफ्ट कार के अभिगम को नियंत्रित करने वाले लिफ्ट कूप संलग्नक का कब्जेदार या सरकवाँ हिस्सा।
- 1.28 **अवतरण जोन**
समतल पर अवतरण के नीचे 40 सेमी० अवतरण से ऊपर 40 सेमी तक का क्षैतिज तल में अवकाश।
- 1.29 **समतलन युक्तियाँ**
- 1.29.1 **समतलन युक्ति, लिफ्ट कार**
ऐसी युक्ति जो स्वचालित या प्रचालक के नियंत्रण में, केवल अवतरण के लिए समतलन जोन के भीतर कार को गतिशील करती है तथा अवतरण पर इसे स्वतः रोक देती है।
- 1.29.2 **समतलन युक्ति, एक तरफा स्वचालित**
ऐसी युक्ति जो केवल कार की अंडर रन की स्थिति में कार के तल को ठीक करती है परन्तु लदाई और उतराई के दौरान समतल नहीं बनाए रखेगी।
- 1.29.3 **समतलन युक्ति दो तरफा स्वचालित पोषित**
एक ऐसी युक्ति जो कार की अंडर रन और ओवर रन, दोनों स्थितियों में कार के तल को ठीक करती है तथा लदाई और उतराई के दौरान भी समतल बनाए रखती है।
- 1.29.4 **समतलन युक्ति, दो तरफा स्वचालित अपोषित**
एक ऐसी युक्ति जो कार की अंडर रन और ओवर रन दोनों, स्थितियों में कार के तल को ठीक करती है परन्तु लदाई और उतराई के दौरान समतल नहीं बनाए रखती।

- 1.21 **Floor-Stopping Switch**
A switch or combination of switches arranged to bring the car to rest automatically at or near any pre-selected landing.
- 1.22 **Gearless Machine**
A lift machine in which the motive power is transmitted to the driving sheave from the motor without intermediate reduction gearing and has the brake drum mounted directly on the motor shaft.
- 1.23 **Goods Lift**
A lift designed primarily for the transport of goods, but which may carry a lift attendant or other persons necessary for the loading or unloading of goods.
- 1.24 **Guide Rails Fixing**
The complete assembly comprising the guide rails bracket and its fastenings.
- 1.25 **Guide Rails Shoe**
An attachment to the car frame or counterweight for the purpose of guiding the lift car or counterweight frame.
- 1.26 **Landing Call Push**
A push button fitted at a lift landing, either for calling the lift car, or for actuating the call indicator.
- 1.27 **Landing Door**
The hinged or sliding parting of a lift well enclosure, controlling access to a lift car at a lift landing.
- 1.28 **Landing zone**
A space extending from a horizontal plane 40 cm below a landing to a plane 40 cm above the landing.
- 1.29 **Levelling Devices**
- 1.29.1 **Levelling Device, Lift Car**
Any mechanism which either automatically or under the control of the operator, moves the car within the levelling zone towards the landing only, and automatically stops it at the landing.
- 1.29.2 **Levelling Device, One way Automatic**
A device which corrects the car level only in case of under-run of the car but will not maintain the level during loading and unloading.
- 1.29.3 **Levelling Device, Two-Way Automatic, Maintaining**
A device which corrects the car level on both under-run and over-run, and maintains the level during loading and unloading.
- 1.29.4 **Levelling Device, Two-Way Automatic Non-maintaining**
A device which corrects the car level on both under-run and over-run but will not maintain the level during loading and unloading.

- 1.30 **समतलन जौन**
लिफ्ट अवतरण के ऊपर या नीचे एक सीमित दूरी जिसके भीतर समतलन युक्ति अवतरण की ओर कार में गति उत्पन्न कर सकती है ।
- 1.31 **लिफ्ट**
दो या अधिक तलों के बीच ऊर्ध्वाधर या पर्याप्त ऊर्ध्वाधर दिशा में गाइडेड कार या प्लेटफार्म के माध्यम से व्यक्तियों या सामग्रियों के परिवहन के लिए डिजाइन किया गया साधन ।
- 1.32 **लिफ्ट कार**
भार वहन इकाई इसमें इसके फर्श या प्लेटफार्म कार फ्रेम या संलग्नीकाय कार्य शामिल हैं ।
- 1.33 **लिफ्ट अवतरण**
निर्माण या संरचना का वह हिस्सा जिसका उपयोग यात्रियों या माल को लिफ्ट कार के भीतर या बाहर ले जाने के लिए किया जाता है ।
- 1.34 **लिफ्ट मशीन**
लिफ्ट उपस्कर का हिस्सा जिसमें, लिफ्ट कार को ऊपर या नीचे करने के लिए, मोटर तथा नियंत्रण गियर के साथ-साथ न्यूनकारी गियर (यदि कोई हो), ब्रेक और कुंडली ड्रम या चरखी शामिल हैं ।
- 1.35 **लिफ्ट गर्त (पिट)**
निम्नतम लिफ्ट अवतरण तल के नीचे लिफ्ट कूप में अवकाश ।
- 1.36 **लिफ्ट कूप**
अहाते के भीतर लिफ्ट कार (कारों) और किसी प्रतिभार (प्रतिभारों) की ऊर्ध्वाधर गति के लिए, इसमें लिफ्ट गर्त तथा शीर्ष अवकाश भी शामिल हैं, प्रदान किया गया बाधारहित अवकाश ।
- 1.37 **लिफ्ट कूप अहाता**
लिफ्ट कूप को इसके परिवेश से पृथक करने वाली कोई संरचना ।
- 1.38 **उत्थापन बीम**
मशीन कक्ष छत के ठीक नीचे लगी एक बीम, जिसमें लिफ्ट मशीन के भागों को ऊपर, या नीचे करने के लिए उत्थापन टैकिल लगाया जा सकता है ।
- 1.39 **प्रचालन**
लिफ्ट मशीन के नियंत्रण को सक्रिय करने की विधि ।
- 1.39.1 **स्वचालित प्रचालन**
प्रचालन की एक ऐसी विधि जिसमें बटन पर क्षणिक दाब लगाकर लिफ्ट कार को चालू किया जाता है तथा अपेक्षित लिफ्ट अवतरण पर स्वतः रोका जाता है ।
- 1.39.2 **गैर-चयनात्मक सामूहिक स्वतः प्रचालन**
प्रत्येक अवतरण तल के लिए कार के भीतर की एक बटन द्वारा तथा प्रत्येक अवतरण पर एक ऐसा बटन जिसमें अवतरण के क्षणिक सक्रियण द्वारा सभी स्टॉप रजिस्टर होते हैं या कार बटन सक्रिय की गयी बटनों की संख्या या बटनों के सक्रियण किए जाने के अनुक्रम को ध्यान में रखे बिना स्वतः प्रचालन । इस प्रकार के प्रचालन से कार उन सभी अवतरणों पर, जिनके लिए बटन को सक्रिय किया गया है तथा उहराव अवतरण के क्रम में, परन्तु यात्रा की दिशा को ध्यान में रखते हुए रुकती है ।

- 1.30 **Levelling Zone**
The limited distance above or below a lift landing within which the levelling device may cause movement of the car towards the landing.
- 1.31 **Lift**
An appliance designed to transport persons or materials between two or more levels in a vertical or substantially vertical direction by means of a guided car or platform.
- 1.32 **Lift Car**
The load carrying unit with its floor or platform, car frame and enclosing body work.
- 1.33 **Lift landing**
That portion of a building or structure used for discharge of passengers or goods or both into or from a lift car.
- 1.34 **Lift Machine**
The part of the lift equipment comprising the motor and the control gear therewith, reduction gear (if any), brake(s) and winding drum or sheave, by which the lift car is raised or lowered.
- 1.35 **Lift Pit**
That space in the lift well below the level of the lowest lift landing served.
- 1.36 **Lift Well**
The unobstructed space within an enclosure provided for the vertical movement of the lift car(s) and any counterweight(s), including the lift pit and the space for top clearance.
- 1.37 **Lift Well Enclosure**
Any structure which separates the lift well from its surroundings.
- 1.38 **Lifting Beam**
A beam, mounted immediately below the machine room ceiling, to which lifting tackle can be fixed for raising or lowering parts of the lift machine.
- 1.39 **Operation**
The method of actuating the control of lift machine.
- 1.39.1 **Automatic Operation**
A method of operation in which by a momentary pressure of a button the lift car is set in motion and caused to stop automatically at any required lift landing.
- 1.39.2 **Non-Selective Collective Automatic Operation**
Automatic operation by means of one button in the car for each landing level served and one button at each landing, wherein all stops registered by the momentary actuation of landing or car buttons are made irrespective of the number of buttons actuated or of the sequence in which the buttons are actuated. With this type of operation, the car stops at all landings for which buttons have been actuated making the stops in the order in which the landings are reached after the buttons have been actuated but irrespective of its direction of travel.

1.39.3 चयनित सामूहिक स्वचालित प्रचालन

कार में प्रत्येक अवतरण के लिए एक बटन द्वारा तथा अवतरणों पर ऊपर और नीचे बटनों द्वारा, जिसमें कार के क्षणिक सक्रियण द्वारा रजिस्टर किए गए सभी स्टॉप गैर-चयनात्मक सामूहिक स्वचालित प्रचालन के अधीन यथा परिभाषित, परन्तु अवतरण बटनों के क्षणिक सक्रियण द्वारा रजिस्टर किए गए स्टॉप यात्रा की प्रत्येक दिशा में, बटनों को सक्रिय किए जाने के पश्चात पहुँचने वाले अवतरणों के क्रम में स्वतः प्रचालन। इस प्रकार के प्रचालन से सभी 'अप' (ऊपर) अवतरण आह्वानों पर कार को ऊपर की ओर यात्रा करते समय तथा सभी 'डाउन' (नीचे) अवतरण आह्वानों पर कार को नीचे की ओर यात्रा करते समय अनुक्रिया होती है परन्तु उच्चतम या निम्नतम आह्वानों के मामले में कार की यात्रा की दिशा को ध्यान दिए बगैर पहुँचने के तुरंत बाद ही अनुक्रिया होती है।

1.39.4 एकल स्वचालित प्रचालन

कार में प्रत्येक अवतरण तल के लिए एक बटन द्वारा तथा प्रत्येक अवतरण पर एक बटन द्वारा स्वचालित प्रचालन इस प्रकार व्यवस्थित किए गए थे कि यदि किसी कार या अवतरण के बटन सक्रिय कर दिए जाएं तो प्रथम बटन की अनुक्रिया पूरी करने से पूर्व किसी अन्य कार या अवतरण बटन का प्रचालन कार की गति पर कोई प्रभाव नहीं डाल सकेगा।

1.39.5 गुप स्वचालित प्रचालन

पॉवर प्रचालित कार या अवतरण दरवाजों से सज्जित दो या अधिक गैर-परिचर वाली लिफ्टों का स्वचालित प्रचालन। कारों का प्रचालन, स्वचालित प्रेषण माध्यम सहित, एक पर्यवेक्षी प्रचालन प्रणाली द्वारा समन्वित होता है, जिसके द्वारा चयनित कारों निर्दिष्ट प्रेषण बिंदुओं पर अपने दरवाजे स्वतः बंद कर लेती हैं तथा नियमित ढंग से अपने रास्ते पर आगे बढ़ जाती हैं। इसमें प्रत्येक कार में प्रत्येक तल के लिए एक बटन तथा प्रत्येक अवतरण पर ऊपर और नीचे (अप और डाउन) बटन (अंतिम अवतरणों पर एक बटन) शामिल है। कार बटनों के क्षणिक सक्रियण द्वारा व्यवस्थित स्टाप यात्रा की दिशा या बटनों के सक्रियण अनुक्रम को ध्यान में रखे बिना कार के संगत अवतरणों पर पहुँचने पर स्वतः ही अनुक्रम में हो जाते हैं। कार बटनों के क्षणिक सक्रियण द्वारा व्यवस्थित स्टॉप किसी भी लिफ्ट द्वारा समूह में (गुप में) स्थापित किया जा सकता है और यह संगत दिशा में अवतरण के लिए आने वाली प्रथम उपलब्ध कार द्वारा स्वतः किया जाता है।

1.39.6 कार स्विच प्रचालन

प्रचालन की वह विधि जिसके द्वारा लिफ्ट कार का संचालन एक हत्ये की सहायता से सीधे परिचर के प्रचालन के अंतर्गत आ जाता है।

1.39.7 सिगनल प्रचालन

यह सामूहिक प्रचालन के समान है, परन्तु दरवाजा बंद करने का कार्य परिचर द्वारा प्रारम्भ किया जाता है।

1.39.8 द्वि बटन(सतत् दाब) प्रचालन

कार में तथा अवतरणों पर बटन या स्विचों के द्वारा प्रचालन, कार या बटन को सतत् दबाए रखते हुए कार के संचालन को नियंत्रित किया जा सकता है।

1.40 प्रचालन युक्ति

नियंत्रण को सक्रिय करने के लिए लगायी गयी कार स्विच, दाब बटन या अन्य युक्ति।

1.41 सिरोपरि बीम

लिफ्ट कूप शीर्ष पर लिफ्ट उपस्कर को सीधी टेक देने वाले, सामान्यतः इस्पात के, अवयव।

1.39.3 Selective Collective automatic Operation

Automatic operation by means of one button in the car for each landing level served and by up and down buttons at the landings, wherein all stops registered by the momentary actuation of the car made as defined under non-selective collective automatic operation, but wherein the stops registered by the momentary actuation of the landing buttons are made in the order in which the landings are reached in each direction of travel after the buttons have been actuated. With this type of operation, all 'up' landing calls are answered when the car is travelling in the up direction and all 'down' landing calls are answered when the car is travelling in the down direction, except in the case of the uppermost or lowermost calls which are answered as soon as they are reached irrespective of the direction of travel of the car.

1.39.4 Single Automatic Operation

Automatic operation by means of one button in the car for each landing level served and one button at each landing so arranged that if any car or landing button has been actuated, the actuation of any other car or landing operation button will have no effect on the movement of the car until the response to the first button has been completed.

1.39.5 Group Automatic Operation

Automatic operation of two or more non-attendant lifts equipped with power operated car and landing doors. The operation of the cars is co-ordinated by a supervisory operation system including automatic dispatching means whereby selected cars at designated dispatching points automatically close their doors and proceed on their trips in a regulated manner. It includes one button in each car for each floor served and up and down buttons at each landing (single buttons at terminal landings). The stops set up by the momentary actuation of the car buttons are made automatically in succession as a car reaches the corresponding landings irrespective of its direction of travel or the sequence in which the buttons are actuated. The stops set up by the momentary actuation of the landing buttons may be accomplished by any lift in the group, and are made automatically by the first available car that approaches the landing in the corresponding direction.

1.39.6 Car Switch Operation

Method of operation by which the movement of lift car is directly under the operation of the attendant by means of a handle.

1.39.7 Signal Operation

Same as collective operation, except that the closing of the door is initiated by the attendant.

1.39.8 Double button (continuous pressure) Operation

Operation by means of buttons or switches in the car and at the landings any of which may be used to control the movement of the car as long as the button or switch is manually pressed in the actuating position.

1.40 Operating Device

A car switch, push button or other device employed to actuate the control.

1.41 Over head Beams

The members, usually of steel, which immediately support the lift equipment at the top of the lift well.

1.42 **अति चाल नियंत्रक** एक यांत्रिक यांत्रिक युक्ति है जो अवरोहण दिशा में चाल पूर्व निर्धारित सीमा से अधिक होने पर सुरक्षा गियर को प्रचालित करके लिफ्ट कार और / या प्रतिभार को विराम की स्थिति में ला सकती है।

यह एक ऐसी स्वचालित युक्ति है जो अवरोहण दिशा में चाल पूर्व निर्धारित सीमा से अधिक होने पर सुरक्षा गियर को प्रचालित करके लिफ्ट कार और / या प्रतिभार को विराम की स्थिति में ला सकती है।

- 1.43 **यात्री लिफ्ट**
यात्रियों के परिवहन के लिए डिजाइन की गयी लिफ्ट ।
- 1.44 **स्थिति और / या दिशा सूचक**
एक ऐसी युक्ति जो लिफ्ट अवतरण पर या लिफ्ट में या दोनों पर लिफ्ट कार जिसमें चल रही है उस कूप में लिफ्ट कार की स्थिति या दिशा या दोनों की सूचना प्रदान करती है।
- 1.45 **निर्धारित भार**
वह अधिकतम भार, जिसके लिए लिफ्ट कार को डिजाइन और अधिष्ठापित किया गया है ताकि वह इसे सुरक्षित तथा अपनी निर्धारित चाल से वहन कर सके ।
- 1.46 **निर्धारित चाल**
लिफ्ट कार में निर्धारित भार के साथ ऊपर और नीचे की दिशा में लिफ्ट कार द्वारा प्राप्त की जाने वाली अधिकतम चाल ।
- 1.47 **पश्चवर्तन (रिटायरिंग) कैम**
एक ऐसी युक्ति जो अवतरण दरवाजों को अवतरण पर लिफ्ट कार के रुक जाने तक अपाशित होने से रोकती है।
- 1.48 **बहु रज्जुबंधन**
रज्जुबंधन की एक ऐसी प्रणाली जहाँ मशीन से कार तक अनेक घटक प्राप्त करने के उद्देश्य से अनेक रज्जु प्रपात कार या प्रतिभार या दोनों की चरखियों के चारों ओर घुमाए जाते हैं। इसमें 2 से 1 तक, 3 से 1 तक आदि रज्जुबंधन व्यवस्था शामिल है ।
- 1.49 **सुरक्षा गियर**
लिफ्ट कार या प्रतिभार या दोनों से संलग्न एक ऐसी यांत्रिक युक्ति जिसे कार या प्रतिभार को रोकने या ठहराव के लिए डिजाइन किया गया है ताकि मुक्त पात या अवरोहण की दिशा में नियंत्रक को अति चाल से प्रचालित होने पर इसे गाइड किया जा सके।
- 1.50 **चरखी**
एक ऐसा रज्जु पहिया जिसके रिम पर निलंबित रज्जुओं को प्राप्त करने के लिए खाँचे कटे होते हैं परन्तु इससे रज्जु दृढ़ता पूर्वक जुड़े नहीं होते और इसके द्वारा पॉवर लिफ्ट मशीन से निलंबित रज्जुओं तक संप्रेषित की जाती है।
- 1.51 **श्लथ रज्जु स्विच**
रज्जु (रज्जुओं) को ढीला होने की स्थिति में नियंत्रण परिपथ को खोलने के लिए दी गयी स्विच।
- 1.52 **निलंबन रज्जु**
कार और प्रतिभार को लटकाने वाली रज्जु ।
- 1.53 **टर्मिनल बंदन स्विच**
एक ऐसी स्विच जो सक्रिय किए जाने पर निश्चिततः उच्च चाल को विच्छेदित कर देगी तथा उस परिपथ को चालू कर देगी ताकि टर्मिनल (अंतिम) अवतरणों पर पहुँचने से पूर्व उत्पापक समतलन चाल से चल सके।

1.42 **Over-Speed Governor**

An automatic device which brings the lift car and/or counterweight to rest by operating the safety gear in the event of the speed in a descending direction exceeding a predetermined limit.

1.43 **Passenger Lift**

A lift designed for the transport of passengers

1.44 **Position and/or Direction Indicator**

A device which indicates on the lift landing or in the lift car or both, the position of the car in the lift well or the direction or both in which the lift car is travelling.

1.45 **Rated Load**

The maximum load for which the lift car is designed and installed to carry safely at its rated speed.

1.46 **Rated Speed**

The means of the maximum speed attained by the lift car in the upward and downward direction with rated load in the lift car.

1.47 **Retiring Cam**

A device which prevents the landing doors from being unlocked by the lift car unless it stops at a landing.

1.48 **Roping Multiple**

A system of roping where, in order to obtain a multiplying factor from the machine to the car, multiple falls of rope are run around sheaves on the car or counterweight or both. It includes roping arrangement of 2 to 1, 3 to 1 etc.

1.49 **Safety Gear**

A mechanical device attached to the lift car or counterweight or both, designed to stop and to hold the car or counterweight to the guides in the event of free fall or if governor operated of over speed in the descending direction.

1.50 **Sheave**

A rope wheel, the rim of which is grooved to receive the suspension ropes but to which the ropes are not rigidly attached and by means of which power is transmitted from the lift machine to the suspension ropes.

1.51 **Slack Rope Switch**

Switch provided to open the control circuit in case of slackening of rope(s).

1.52 **Suspension Ropes**

The ropes by which the car and counterweight are suspended.

1.53 **Terminal Slow Down Switch**

A switch when actuated shall compulsorily cut off the high speed and switch on the circuitry to run the elevator in levelling speed before reaching on terminal landings.

- 1.54 **टर्मिनल रोक (स्टॉपिंग) स्विच सामान्य**
कार को सबसे उपरी या नीचले अवतरण से आगे यात्रा करने के मामले में पूरी अर्जित धारा का विच्छेद करने के लिए स्विच या एक ऐसी स्विच जो ऊर्जित करने वाली धारा का विच्छेद कर दे जिससे कार को सबसे ऊपरी और नीचले तल पर रोका जा सके।
- 1.55 **टर्मिनल रोक स्विच अंतिम**
एक ऐसी युक्ति जो कार को टर्मिनल अवतरण से आगे बढ़ जाने के पश्चात् विद्युत् लिफ्ट चालन मशीन मोटर और ब्रेक सामान्य टर्मिनल रोक युक्ति, प्रचालन युक्ति या किसी आपात टर्मिनल रोक युक्ति के स्वतंत्र कार्यकरण से पॉवर को हटा देती है।
- 1.56 **कुल हैडरूम**
शीर्ष लिफ्ट अवतरण तल से मशीन कक्ष स्लैब के तल तक ऊर्ध्वाधर दूरी।
- 1.57 **यात्रा**
सेवित लिफ्ट अवतरण के तल और शीर्ष के बीच की ऊर्ध्वाधर दूरी।
- 1.58 **गियर युक्त मशीन**
ऐसी मशीन जिसमें चरखी को वर्म या वर्म और स्पर न्यूनकारी गियरिंग के माध्यम से पावर संप्रेषित की जाती है।

- 1.54 **Terminal Stopping Switch Normal**
Switch for cutting all the energizing current in case of car travelling beyond the top or bottom landing or a switch which cuts off the energizing current so as to bring the car to a stop at the top and bottom level.
- 1.55 **Terminal Stopping Device final**
A device which automatically cause the power to be removed from an electric lift driving-machine motor and brake, independent of the functioning of the normal terminal stopping device, the operating device or any emergency terminal stopping device, after the car has passed a terminal landing.
- 1.56 **Total Headroom**
The vertical distance from the level of the top lift landing to the bottom of the machine room slab.
- 1.57 **Travel**
The vertical distance between the bottom and top lift landing served.
- 1.58 **Geared Machine**
A machine in which the power is transmitted to the sheave through worm or worm and spur reduction gearing.

अध्याय - III

स्थापत्य और संरचना उपस्कर

1.0 भवन आरेखों में लिफ्टों के विवरण

1.1 भवन के आरेखों में निम्नलिखित विवरण तथा लिफ्ट अधिष्ठापनों के संबंध में परिष्कृत आकार दिए जाने चाहिए:

- (क) लिफ्ट कूप की स्थितियां
- (ख) लिफ्ट कूप अहाता के विवरण
- (ग) अवतरण दरवाजों का आकार स्थिति, संख्या और प्रकार
- (घ) लिफ्ट सेवा वाले तलों की संख्या
- (ङ) तल स्तरों के ब्रीच की ऊँचाई
- (च) प्रवेश द्वारों की संख्या
- (छ) कुल हैडरूम
- (ज) मशीन कक्ष के लिए अधिगम की व्यवस्था
- (झ) मशीन कक्ष के संवातन और, यदि संभव हो तो, प्राकृतिक प्रकाश की व्यवस्था
- (ञ) मशीन कक्ष की ऊँचाई
- (ट) ट्रेप दरवाजा
- (ठ) लिफ्ट गर्त की गहराई
- (ड) लिफ्ट कूप के ऊपर या नीचे लिफ्ट मशीन की स्थिति
- (ढ) प्रत्येक तल पर लिफ्ट से सटे किसी ट्रिगर जॉयस्ट या स्थाणुकों का आकार और स्थिति
- (ण) छत स्तरों पर आधारी इस्पात कार्य का आकार और स्थिति
- (त) यदि पाद या जालीदार नीव लिफ्ट गर्त के आसन्न हो तो इनके आकार और स्थिति
- (थ) यात्री लिफ्टों के मामले में क्या लिफ्ट पिंजरे में धरेलू सामान यथा रेफ्रिजरेटर, इस्पात की अलमारी आदि वहन करना आवश्यक है।

2.0 स्थापत्य विचार

- 2.1 एक लिफ्ट बैंक में लिफ्टों की संख्या 4 से अधिक नहीं होनी चाहिए। किसी बैंक का एकल शैफ्ट अच्छी प्रकार प्लास्टर की गयी 4-1/2" मोटी आर. सी. सी. दीवार युक्त 9" की ईट की दीवार द्वारा या 2" घंटा आग निर्धारण (फायर रेटिंग) के लिए उपयुक्त मोटाई की अग्नि मंदक सामग्री के उपयुक्त विभाजक दीवार द्वारा पृथक किया जाएगा।
- 2.2 कार्यालय भवन के प्रत्येक ब्लॉक में यात्री लिफ्ट (लिफ्टों) के अलावा 1 (एक) माल लिफ्ट होनी चाहिए, जबकि आवासीय भवनों में यात्री लिफ्टों की सभी विशिष्टताओं वाली यात्री-सह-माल लिफ्टें होनी चाहिए परन्तु फर्श, प्रवेश द्वार तथा कार की विभाएं माल लिफ्टों के अनुसार होनी चाहिए।
- 2.3 भवन के मुख्य भाग में स्थित लिफ्ट लॉबी से निकास आधा घंटा अग्नि-रोधी स्वतः संवरक (शैल्फ क्लोजिंग) दरवाजे से होकर जाएगा।
- 2.4 सामान्यतः लिफ्ट का गमनागमन तहखाने तक नहीं होना चाहिए, परन्तु लिफ्ट का गमनागमन तहखाने तक होने की स्थिति में तहखाने को खंड 6 के अनुरूप दाबानुकूलित तथा परिशिष्ट-VI के खंड-7 के अनुसार दरवाजा स्वतः संवरण प्रकार का होना चाहिए।
- 2.5 लिफ्ट लॉबी का भीतरी आकार 1800 X 2000 मिमी० या अधिक होना चाहिए।

CHAPTER-III

ARCHITECTURAL & STRUCTURAL REQUIREMENTS

1.0 Particulars of Lifts in building drawings

1.1 The drawings of the building should give the following particulars and finished sizes in respect of the lift installations:

- (a) Positions of lift well
- (b) Particulars of lift well enclosure;
- (c) Size, position, number and type of landing doors;
- (d) Number of floors served by the lift;
- (e) Height between floor levels;
- (f) Number of entrances;
- (g) Total headroom;
- (h) Provision of access to machine room;
- (i) Provision of ventilation and , if possible, natural lighting of machine room;
- (j) Height of machine room;
- (k) Trap door
- (l) Depth of lift pit;
- (m) Position of lift machine, above or below lift well;
- (n) Size and position of any trimmer joists or stanchions adjacent to the lift well at each floor;
- (o) Size and position of supporting steel work at roof levels;
- (p) Size and position of any footings or grillage foundations, if these are adjacent to the lift pit, and
- (q) In the case of passenger lifts whether the lift cage is required to carry household luggage, such as refrigerator, steel almirah, etc.

2.0 Architectural Considerations :

- 2.1 The number of lifts in one lift bank shall not exceed 4. Individual shafts in a bank shall be separated by a 9" brick wall duly plastered / 4 -1/2" thick RCC wall or suitable partition of fire retarding material of appropriate thickness for 2 hrs fire rating.
- 2.2 In office building each block shall have 1 No. goods lift in addition to the passenger lift (s), where as residential buildings shall have all passenger cum goods lifts with all the features of passenger lifts except the flooring , entrance and car dimensions which shall be as per goods lifts.
- 2.3 Exit from the lift lobby, if located in the core of the building, shall be through a self-closing smoke stop door of half an hour fire resistance.
- 2.4 Lift shall not normally communicate with the basement: if , however, lifts are in communication, the lift lobby of the basements shall be pressurised as in clause 6, with self-closing door as in clause 7 of Appendix VI.
- 2.5 The lift lobby shall be of an inside measurement of 1800 x 2000 mm or more.

2.6 लिफ्ट लॉबी में, यथा अग्नि शमन के दौरान प्रयुक्त पानी को लिफ्ट शैफ्ट में प्रवेश करने से रोकने के लिए फर्श को ढालू बनाने की उपयुक्त व्यवस्था की जानी चाहिए।

3.0 संरचना विचारण

3.1 लिफ्ट कूप आहाता, लिफ्ट गर्त, मशीन कक्ष और मशीन सहायक साधन भवन निर्माण का अंग तथा लिफ्ट विनिर्माता के आरेखों के अनुरूप होने चाहिए।

3.2 लिफ्ट कूप

यह आई. एस. 14665 (भाग-1)-2000 के खंड-5 के अनुरूप होना चाहिए। लिफ्ट कूप सभी ओर से साहुल में होना चाहिए। अधिष्ठापन के लिए आवश्यक कोई प्रक्षेप को आई. एस 14665 (भाग-1): 2000 के खंड-5.2 के अनुसार उपयुक्त रूप से देखा जाना चाहिए।

लिफ्ट कूप के लिए किसी स्तर पर संरचनात्मक सीमाओं को आई. एस. 14665 (भाग-2 खंड 1 और (2)-2000 द्वारा निर्धारित विभाओं का अतिक्रमण नहीं करना चाहिए। साहुल करने में अनुमेय त्रुटि निम्नलिखित सीमाओं के भीतर होनी चाहिए:

(क) 30 मीटर तक वाले कूप के लिये 0 से +25 मिमी० तक

(ख) 60 मीटर तक वाले कूप के लिये 0 से +35 मिमी० तक

(ग) 90 मीटर तक वाले कूप के लिये 0 से +50 मिमी० तक

लिफ्ट कूप और गर्त में लिफ्ट अधिष्ठापन के भाग के रूप में निर्माण के अलावा किसी अतिरिक्त अधिष्ठापन की अनुमति नहीं दी जाएगी। लिफ्ट कार तथा इसके प्रतिभार दोनों एक ही लिफ्ट कूप में अवस्थित होना चाहिए। लिफ्ट कूप में अवतरण द्वार के अलावा कोई अन्य द्वार नहीं होना चाहिए। लिफ्ट कूप अहाते में किसी भी दशा में काँच का उपयोग नहीं किया जाना चाहिए। लिफ्ट शैफ्ट का आकार इसके संस्तुत आकार से बड़ा होने पर उचित संख्या में आर एस जॉयस्ट/वैनल, इसमें गहरे ब्रैकेट भी शामिल हैं, उपलब्ध कराए जाने चाहिए।

3.3 लिफ्ट गर्त

लिफ्ट गर्त को उचित जल रोधी उपचार द्वारा बिल्कुल शुष्क रखा जाना चाहिए। इस बात की सावधानी बरती जानी चाहिए कि लिफ्ट गर्त में अधिष्ठापन के दौरान इस प्रकार का जल रोधन क्षतिग्रस्त न हो। लिफ्ट गर्त की गहराई 1.6 मीटर से अधिक होने पर लिफ्ट गर्त तक पहुँचने के लिए अभिगम सीढ़ी उपलब्ध करायी जानी चाहिए और सीढ़ी की ऊँचाई निम्नतम फर्श तल से 0.75 मी० अधिक होना चाहिए।

3.4 मशीन कक्ष - फर्श को सामान्यतः 1000 किग्रा/मी०² भार वहन के लिए डिजाइन किया जाना चाहिए, परन्तु उपर्युक्त के लिए यू डी एल पुष्टि लिफ्ट विनिर्माता से प्राप्त की जा सकती है।

3.5 टैकिल वहन के लिए मशीन कक्ष अंतस्छद के ठीक नीचे उपयुक्त उत्पाक बीम उपलब्ध कराए जाने चाहिए ताकि किसी भारी लिफ्ट के किसी वजनी भार को उठाना संभव बनाया जा सके। (लिफ्ट विनिर्माताओं के सुझावों के अनुसार)।

3.6 बड़े लिफ्ट अधिष्ठापनों के मामलों में मशीन कक्ष के अंतस्छद को भी डिजाइन किया जाना चाहिए ताकि निरीक्षण और मरम्मत हेतु मशीनरी के पुर्जों को ऊपर उठाने के उपयोग में लाने के लिए पुली को ऊपर लिया जा सके।

3.7 लिफ्ट अधिष्ठापनों द्वारा भवन पर पड़ने वाले समतुल्य को लिफ्ट विनिर्माता के आरेख में दर्शाया जाना चाहिए ताकि वास्तुविद/इंजीनियर उचित व्यवस्था कर सके।

3.8 मशीन कक्ष तथा जल टंकी के बीच कोई उभयनिष्ठ दीवार नहीं होनी चाहिए। लिफ्ट शैफ्ट/मशीन कक्षों से होकर जाने वाली या आसन्न कोई चिमनी या अपवाह नाली नहीं होनी चाहिए।

3.9 वर्षा जल को खिड़कियों (बिना छज्जा वाली) या लिफ्ट लॉबी की खिड़कियों/जालियों के रास्ते मशीन कक्ष में नहीं फैलना चाहिए। मशीन कक्ष उचित रूप से संवातित होना चाहिए।

2.6 Suitable arrangement such as providing slope in the floor of the lift lobby shall be made to prevent water used during fire fighting etc at any landing from entering the lift shafts.

3.0 Structural Considerations

3.1 Lift well enclosures, lift pits, machine rooms and machine supports should form part of the building construction and comply with the lift manufacturer's drawings.

3.2 Lift well :

It should be as per clause 5 of IS 14665 (Part 1) –2000. Lift well shall be in plumb on all sides. It shall be made fire resistant. Any projection necessary for the installation shall be suitably treated as per clause 5.2 of IS 14665 (Part-I):2000. The structural limits for lift well at any level should not encroach on the dimensions prescribed by IS 14665 (Part 2 - Sec 1 & 2) -2000. The tolerance allowed in the plumbness shall fall within the following limits:-

- (a) for well up to 30 mts - 0 to + 25mm
- (b) for well up to 60 mts - 0 to +35mm
- (c) for well upto 90 mts - 0 to +50mm

No extra installation other than that forming a part of the lift installation shall be allowed in the lift well and pit. The lift car and its counterweight should both be located in the same lift well. There shall be no opening to the lift well except the landing opening. Glass shall in no case be used for lift well enclosure. When the lift shaft size is bigger than the recommended size suitable number of R.S. joists/ channel including deeper brackets shall be provided.

3.3 Lift Pit :

The lift pit shall be kept perfectly dry by suitable water proofing treatment. Precautions should be taken not to damage such water proofing during the installation work in the lift pit. Where the lift pit depth exceeds 1.6m suitable access ladder shall be provided to reach the lift pit and the ladder shall extend to a height of 0.75m above the lowest floor level.

3.4 Machine Room – Floors shall normally be designed to carry a load of 1000 kg/sqm UDL Confirmation to above may however be taken from lift manufacturer.

3.5 Suitable lifting beams immediately below the machine room ceiling may be provided for carrying tackle to facilitate lifting of any heavy part of a heavy lift (as per lift manufacturers recommendations).

3.6 In the case of large lift installations, the roof of the machine room also should be designed to take up the pulley which could be used for lifting up parts of the lift machinery for inspection and repair.

3.7 The equivalent dead loads imposed upon the building by the lift installations should be shown on the lift manufacturer's drawing so that the architect/ engineer may make provision accordingly.

3.8 There should be no common wall between machine room and water tank. There shall be no Chimney or drainage duct either passing through or adjoining lift shafts/ machine rooms.

3.9 There should be no possibility of rain water splashing into machine room through windows (without chhajja) or in the lift lobbies through windows / jallies. The machine room shall be properly cross ventilated.

- 4.0 मशीन कक्ष तथा लिफ्ट गर्त तक अभिगम
- 4.1 लिफ्ट के ऊपर मशीन कक्ष के लिए अभिगम अंतस्छद से या एक आंतरिक सीढ़ी द्वारा हो सकता है।
- 4.2 द्वितीयक तल और मशीन कक्ष के बीच का अभिगम सीढ़ी द्वारा स्थापित किया जा सकता है। मशीन कक्ष प्रवेश द्वार आसन्न फर्श या छत पृष्ठों से 1.5 मी. से कम ऊपर या नीचे होने पर एक उचित स्थायी रूप से संलग्न सीढ़ी का उपयोग किया जा सकता है। सीढ़ियां किसी दीवार, बीम या अवरोध से कम से कम 15 सेमी. दूर सुदृढ़ की जानी चाहिए तथा निश्चित रूप से अवतरण स्तर तक पहुँचनी चाहिए। अवतरण स्तर से ऊपर तथा न्यूनतम 1.15 मी. की ऊँचाई के लिए या तो सीढ़ी के आबंधक को बढ़ाया या उपयुक्त हत्या उपलब्ध कराया जाएगा।
- 4.3 मशीन कक्ष प्रवेश द्वार आसन्न फर्श या छत पृष्ठों से 1.5 मी. या इससे अधिक ऊपर या नीचे होने पर अभिगम नीचे दी गयी 4.3.1 से 4.3.6 तक की आवश्यकताओं के अनुसार सीढ़ी (स्टेयर) द्वारा उपलब्ध कराया जाएगा।
- 4.3.1 सीढ़ी का उन्नयन कोण क्षैतिज से 50° से अधिक तथा सीढ़ी की चौड़ाई 60 सेमी. से कम नहीं होनी चाहिए।
- 4.3.2 पदन्यास का पृष्ठ असर्पणयुक्त होना चाहिए जो कि खुली सीढ़ी निर्माण के लिए 15 सेमी. से कम तथा बंद सीढ़ी निर्माण के लिए 20 सेमी. से कम पार्श्व नहीं।
- 4.3.3 सीढ़ी का राइजर 25 सेमी. से अधिक नहीं होना चाहिए।
- 4.3.4 सभी सीढ़ी मार्गों के बाह्य स्ट्रिंगर पर सुविधा जनक ऊँचाई पर एक हस्त रेल उपलब्ध करायी जाएगी जो कि वलन सुंडन (नोजिंग) से ऊर्ध्वाधर 50 सेमी. तथा अवतरणों और प्लेटफार्मों से 1 मीटर ऊँचाई से कम नहीं होनी चाहिए। इस प्रकार की हस्त रेल तथा सीढ़ी के संगत पार्श्व के निकटतम स्थायी वस्तु के बीच का अंतराल कम से कम 5 सेमी. होना चाहिए।
- 4.3.5 प्रत्येक सीढ़ी मार्ग पर इसकी नोजिंग से मापित 5 मी. से कम हेडरूम अंतराल नहीं होना चाहिए।
- 4.3.6 लंबाई में 5 मीटर से अधिक ऊँचाई वाली सीढ़ियों पर मध्यवर्ती अवतरण उपलब्ध कराए जाने चाहिए।
टिप्पणी : 4.1 से 4.3 तक में निर्धारित किसी आवश्यकता को पूरा करना व्यवहारिक न होने पर ऐसी आवश्यकताओं को परिवर्तित करने में सक्षम प्राधिकारी को परिवर्तन के लिए आवेदन किया जाएगा।
- 4.4 तहखाने में मशीन कक्ष के लिए अभिगम गलियारे से उपलब्ध कराया जा सकता है।
- 4.5 लिफ्ट कूप के रास्ते मशीन कक्ष के लिए अभिगम निषिद्ध होगा।
- 4.6 लिफ्ट गर्त पृथक अभिगम द्वारा परीक्षण किए जाने के योग्य होना चाहिए। दो लिफ्टों की बैटरी के मामले में आसन्न लिफ्ट गर्त से इसकी जाँच करना सम्भव होता है।
- 4.7 कम से कम एक लिफ्ट के लिए भूतल प्रवेश द्वार पर ईंट का कार्य उत्थापन के लिए मशीनरी/उपस्कर को उठाए जाने के बाद ही किया जाना चाहिए।

4.0 Access to Machine Room and Lift Pits

- 4.1 Access to a machine room above a lift well may be either from the roof or by an internal staircase.
- 4.2 Access between a secondary floor and a machine room may be by ladder. Where a machine room entrance is less than 1.5m above or below the adjacent floor or roof surfaces, a substantial permanently attached ladder may be used. Ladders shall be fixed at least 15 cm clear of any wall, beam or obstruction and shall extend at least to the landing level. Above the landing level and for a height of at least 1.15m, either the ladder stringers shall be extended or suitable hand grips shall be provided.
- 4.3 Where the machine room entrance is 1.5 m or more above or below the adjacent floor or roof surface, access shall be provided by means of stairs in accordance with the requirements in 4.3.1. to 4.3.6 given below.
- 4.3.1 The angle of inclination of the stair shall not exceed 50° from the horizontal and the clear width of the stair shall be not less than 60 cm.
- 4.3.2 The tread shall have a non-slip surface which shall be not less than 15 cm wide for open stair construction and not less than 20 cm side for closed stair construction.
- 4.3.3 The riser of the stair shall not exceed 25 cm.
- 4.3.4 A hand rail shall be provided on the outer stringer of all stairways fixed at a convenient height, but not less than 50 cm high measured vertically from the nosings, and not less than one meter high on landings and platforms. Such hand rail shall have at least 5 cm clearance between nearest permanent object at the corresponding side of the stair.
- 4.3.5 Headroom clearance of not less than 2m measured from the nosings of the stairways, shall be provided on every stairway.
- 4.3.6 Heights of stairs over 5 m in length shall be provided with intermediate landings.
Note: Where compliance with any of the requirements specified in 4.1 to 4.3 is impracticable, applications for variation shall be made to the Authority, who may, vary such requirements.
- 4.4 Access to a machine room in a basement may be provided from a corridor.
- 4.5 Access to a machine room via the lift well shall be prohibited.
- 4.6 The lift pit should be capable of being examined by a separate access. In the case of a battery of two lifts, it is possible to examine the lift pit through the adjoining one.
- 4.7 Brick work at ground floor entrance for at least one lift shall be done only after the machinery/ equipment are lifted up for erection.

1.0 विषय क्षेत्र :

यह खंड लिफ्ट अधिष्ठापन, इसके घटकों, सुरक्षा युक्तियों, विभिन्न प्रकार के नियंत्रणों तथा प्रचालन विधियों की तकनीकी आवश्यकताओं से संबंधित है। किसी विशेष प्रकार का नियंत्रण तथा प्रचालन विधि का चयन प्रत्येक मामले की आवश्यकताओं यथा भवन की प्रकृति, उपयोग, दखल, यातायात पैटर्न आदि, के आधार पर निर्धारित किया जाएगा।

2.0 चालन (ड्राइव) मशीनरी

2.1 विद्युत पूर्ति

त्रिकला, 50 चक्र / सेकेंड, 415 वोल्ट की विद्युत पूर्ति उपलब्ध कराई जाएगी। लिफ्ट के सभी उपस्कर + 10 % से -20 % तक की निर्धारित पूर्ति वोल्टता पर प्रचालन के लिए उपयुक्त होने चाहिए।

2.2 गियर रहित मशीन

गियर रहित मशीन में मोटर, कर्षण चरखी और एकल शैफ्ट से पूर्णतः संरेखित ब्रेक ड्रम या ब्रेक डिस्क शामिल होंगे। गियर रहित मशीन वी० वी० एफ० चालन युक्त ए० सी० गियर रहित होगी।

2.3 गियर युक्त मशीन

लिफ्ट मशीन मोटर, ब्रेक, वर्म गियरिंग तथा चालन चरखी युक्त न्यूनकारी वर्मगियर प्रकार की तथा विनिर्दिष्ट नियंत्रण के प्रकार के लिए उपयुक्त होगी।

2.4 चरखियां

चरखियां तथा घिरनियां कठोर मिश्रधातु, ढलवाँ लोहा, एस जी लोहा या इस्पात की होंगी तथा दरारों, बालू छिद्रों तथा अन्य दोषों से मुक्त होंगी। इसमें मशीन किए खाँचे होने चाहिए। उचित कर्षण के लिए कर्षण घिरनी पर खाँचे काटे जाने चाहिए तथा इसकी विभा पर्याप्त होनी चाहिए ताकि खाँचे के घर्षण को समाहित किया जा सके। विक्षेपक चरखी के खाँचे इस प्रकार के हों कि वह रज्जु के लिए मासृण बेड उपलब्ध करा सके। विक्षेपक या द्वितीय चरखी ऐसेम्बलियां, जहाँ प्रयुक्त की जाती हैं। कर्षण चरखी की ठीक रेखा में आरोपित की जाएंगी। आई० एस० 14665 (भाग - 4 धारा 3) के खंड 8: 2000 में यथा विनिर्धारित इस प्रकार के विक्षेपक का खाँचा रज्जु व्यास से बड़ा होना चाहिए। सभी चरखियों का आकार आई एस 14665 (भाग - 4 धारा 3) के खंड 8.4 : 2000 के अनुसार होंगे। आवश्यकतानुसार रक्षक गार्ड भी उपलब्ध कराए जा सकते हैं।

2.5 शैफ्ट चाबी

चरखियों, गियरों, कपलिंग को टेक देने वाले शैफ्टों तथा बलयुग्म संप्रेषित करने वाले अन्य अवयवों में पर्याप्त सामर्थ्य और गुणवत्ता वाले कसी फिटिंग की चाबियां लगाई जाएंगी।

2.6 ब्रेक

लिफ्ट चालन मशीनरी में विद्युत चुम्बकीय ब्रेक या मोटर चालित ब्रेक प्रदान किए जाएंगे तथा ब्रेक प्रचालन युक्ती को बंद (ऑफ) स्थिति में रखते हुए स्प्रिंग को दबाकर लगाया जाएगा। ब्रेक-ब्रेक ड्रम या ब्रेक डिस्क पर उपर्युक्त वक्राकार होगा तथा इसमें अग्निरोधी घर्षण लाइनिंग (अस्तर) लगाया जाएगा। ब्रेक का प्रचालन निर्बाध, धीरे-2 तथा न्यूनतम शोर के साथ किया जाएगा।

CHAPTER-IV

TECHNICAL

1.0 **Scope**

This section deals with technical requirements of lift installation, its components, safety devices various type of controls and methods of operation. The selection of a particular type of control and method of operation will be guided by the requirements in individual case such as nature of building, usage, occupancy, traffic pattern etc., and has to be decided in individual cases.

2.0 **Drive Machinery :**

2.1 **Electric Supply**

Three phase, 50 c/s, 415 V electric supply shall be made available. The entire lift equipment should be suitable for operation at +10% to -20% of the rated supply voltage.

2.2 **Gearless machine**

The gearless machine shall consist of a motor , traction sheave and break-drum or brake disc completely aligned on a single shaft. Gearless machine shall be A.C. gearless with VVVF drive.

2.3 **Geared machine**

The lift machine shall be of worm gear reduction type with motor, brake, worm gearing and driving sheave and suitable for type of control specified.

2.4 **Sheaves:**

Sheaves and pulleys shall be of hard alloy, cast iron, SG iron or steel and free from cracks, sand holes and others defects. They shall have machined rope grooves. The traction sheave shall be grooved to produce proper traction and shall be of sufficient dimension to provide for wear in the groove. The deflector sheave shall be grooved so as to provide a smooth bed for the rope. The deflector or secondary sheave assemblies where used shall be mounted in proper alignment with the traction sheave. Such deflector sheaves shall have grooves larger than rope diameter as specified in clause 8 of IS 14665 (Part -4-Sec 3):2000. The size of all the sheaves shall be in accordance with clause 8.4 of IS 14665 (Part-4-Sec 3) : 2000. Wherever necessary suitable protective guards may be provided.

2.5 **Shaft Keys:**

Shafts which supports sheaves, gears, coupling and other members which transmit torque shall be provided with tight fittings keys of sufficient strength and quality.

2.6 **Brake :**

The lift drive machinery shall be provided with an electro-magnetic brake or motor operated brake normally applied by means of springs in compression when the operating device is in off position. The brake shall be suitably curved over the brake drum or brake disc and provided with fire proof friction lining. The operation of brake shall be smooth, gradual and with minimum noise. The brake shall be designed to be of sufficient size and strength to stop and hold the car at rest with rated load. The brake should be capable of operation automatically by the various safety devices,

ब्रेक को उपर्युक्त आकार और सामर्थ्य का डिजाइन किया जाएगा ताकि निर्धारित भार के साथ कार को बिल्कुल रोका जा सके। ब्रेक विभिन्न सुरक्षा युक्तियों, विद्युत विफलता या कार के सामान्य रोक द्वारा स्वतः प्रचालन योग्य होना चाहिए। ब्रेक को विद्युत द्वारा मोचित किया जाएगा। ब्रेक को हाथ से भी मोचित करना संभव होगा, छोटे स्टॉप में लिफ्ट कार को चलाने हेतु इस प्रकार के मोचन के लिए सतत बल लगाने की आवश्यकता होगी। इस उद्देश्य के लिए, जहाँ भी आवश्यक हो, उपयुक्त ब्रेक मोचन उपस्कर प्रत्येक लिफ्ट अधिष्ठापन के साथ प्रदान किए जाएंगे तथा इनके दुरुपयोग को रोकने के लिए इन्हें सुरक्षित अभिरक्षा में रखा जाएगा।

2.6.1 हस्तकुंडलन पहिया (हैंड वाइंडिंग व्हील) या हत्था

किसी कारण बस लिफ्ट के रूक जाने पर लिफ्ट को निकटतम अवतरण तक अयांत्रित रूप से चलना संभव होगा। अयांत्रिक (हस्त) प्रचालन कुंडलन पहिए या मोटर शैफ्ट के सिरे पर आरोपित हत्ये के माध्यम से होगा। कार की ऊपर या नीचे की दिशा में गति के संबंधी निशान मोटर पर या उपयुक्त स्थान पर लगाया जाना चाहिए। अनुरक्षक स्टॉफ को सलाह देते हुए बड़े सिग्नल लाल रंग की चेतावनी प्लेट "ब्रेक को मोचित तथा पहिए को प्रचालित करने से पूर्व मुख्य पूर्ति की स्विच को बंद करें" प्रमुखता से प्रदर्शित की जानी चाहिए।

2.7 बियरिंग

बियरिंग तेल टंकी, स्वतः स्नेहक तेल गेज, टोपी भरक विवर और बॉल रोलर अपवाह युक्त प्रति-घर्षक धातु स्तवी प्रकार की या तेल प्लवन स्नेहन या ग्रीज स्नेहन वाली सिंटर प्रकार की होती है।

ग्रीज स्नेहित बियरिंगों में ग्रीज गन संयोजन तथा अपवाह प्लग लगे होने चाहिए। बियरिंग तथा स्नेहक टंकिया धूल रोधी होनी चाहिए तथा रिसाव रोकने के लिए इसमें प्रभावकारी सील लगी होनी चाहिए। बियरिंग का बाहरी सिरा अपनेय तेल रोधी प्लेट बंद किया जाएगा। प्रणोद बियरिंग बॉल या रोलर प्रकार के तथा इनके दो सेट होंगे तथा इस प्रकार व्यवस्थित होंगे कि कुशल कार्यकरण के लिए पश्चगमन को न्यूनतम किया जा सके।

3.0 नियंत्रणों के प्रकार

3.1 एकल चाल प्रत्यावर्ती धारा नियंत्रण :

उस चालन मशीन प्रेरण मोटर के लिये नियंत्रण, जिसे एकल चाल पर चलने के लिए व्यवस्थित किया गया है।

3.2 परिवर्ती वोल्टता परिवर्ती आवृत्ति (वी वी वी एफ)

आने वाली मुख्य ए० सी० पॉवर प्रथमतः डी० सी० में परिशोधित की जाती है तथा इसके पश्चात् उत्पापक चालन के लिए नियंत्रित ए० सी० विद्युत धारा उपलब्ध करायी जाती है। मोटर चाल और कार की दिशा, स्थिति तथा भार के सूक्ष्मता पूर्वक मानीटरन से मोटर को आपूर्ति ए० सी० पॉवर की स्पंद दर को समायोजित करने में समर्थ हो सकते हैं ताकि उत्पापक की चाल को आदर्श प्रोफाइल के अनुसार बिल्कुल ठीक बनाए रखना सुनिश्चित किया जा सके। अतः वी० वी० वी० एफ० नियंत्रणों में ए० सी० मोटरों का स्पंद चौड़ाई माडुलन नियंत्रण की पुराने सर्वो नियंत्रित उत्पापकों की तुलना में निम्नलिखित विशेषताएं हैं :-

- (क) गति चक्र के प्रत्येक चरण पर पूर्ण नियंत्रण
- (ख) संगत पूर्णतः समायोजनी निर्बाध राइड
- (ग) सभी दशाओं में बेहतर समतलन परिशुद्धता
- (घ) उच्चतर पॉवर घटक
- (ङ) निम्नतर प्रवर्तन धाराएं
- (च) घटी विद्युत खपत के माध्यम से ऊर्जा बचत

4.0 अधिष्ठापन पहलू

4.1 मशीन कक्ष में अधिष्ठापन

चालन मशीनरी, नियंत्रक आदि को समाहित करने के लिए यथा संभव लिफ्ट मशीन कक्ष लिफ्ट शैफ्ट के ऊपर अवस्थित होना चाहिए। वहाँ उपस्कर का विन्यास इस प्रकार होना चाहिए कि अनुरक्षण कार्मिक इसके भीतर निर्बाध रूप से आ-जा सकें। मशीन कक्ष का उपयोग भंडारण के लिए नहीं किया जाना चाहिए।

current failure and by the normal stopping of the car. The brake shall be released electrically. It shall also be possible to release the brake manually, such releases requiring the permanent application of manual force so as to move the lift car in short stops. For this purpose suitable brake release equipment wherever necessary shall be supplied with each lift installation and the same shall be kept in safe custody to prevent misuse.

2.6.1 Hand winding wheel or handle:

At times of lift stoppage due to any reasons, it shall be possible to move the lift car to the nearest landing manually. The manual operation shall be by means of a winding wheel or handle mounted on the end of the motor shaft. The up or down direction of the movement of the car should be clearly marked on the motor or at suitable location. A warning plate written in bold signal red colour advising the maintenance staff to switch off the mains supply before releasing the brake and operating the wheel is to be prominently displayed.

2.7 Bearings:

Bearings shall be either of the anti-friction metal sleeve type with oil reservoirs, self lubrication, oil gauges, capped filler openings and drains of the ball roller or sintered type subject to oil flood lubrication or grease lubrication.

Grease lubricated bearings shall have grease gun connections and drain plugs. The bearings and lubricant reservoirs shall be dust tight and shall incorporate effective seals to prevent leakage. The outer end of the bearings shall be closed with a removable oil tight plate. Thrust bearings shall be of the ball or roller type and shall have two sets of balls or rollers arranged to minimise backlash for efficient working.

3.0 Type of controls:

3.1 Single speed alternating current control:

A control for a driving machine induction motor which is arranged to run at a single speed.

3.2 Variable Voltage Variable Frequency :

Incoming mains ac power is first rectified to dc and then inverted to provide controlled ac current to the elevator drive. Precision monitoring of motor speed and car direction, position and load enable the pulse width of the ac power supplied to the motor to be adjusted to ensure that elevator speed is maintained very accurately to an ideal profile.

Thus in VVVF controls pulse width modulation control of ac motors has following advantages compared with the older servo controlled elevators :-

- (a) Total control at all stages of the motion cycle.
- (b) A consistent fully adjustable smooth ride
- (c) Better levelling accuracy under all conditions
- (d) A higher power factor
- (e) Lower starting currents
- (f) Energy saving through reduced power consumption.

4.0 Installation aspects :

4.1 Installation in machine room – Lift machine room to accommodate the drive machinery, controller, etc., shall as far as possible be located on top of the lift shaft. The layout of equipment there should be such as to allow free movement of maintenance personnel inside. Machine room shall not be used for storage purpose.

4.1.1 मशीन कक्ष का संवातन - विद्युत उपस्करों को अति तापित होने से बचाने तथा नियंत्रक का उचित प्रचालन सुनिश्चित करने के लिए मशीन कक्ष में प्राकृतिक वायु और यांत्रिक संवातन उपलब्ध कराया जाएगा। धूल आदि के प्रवेश को उचित प्रकार से रोका जाएगा।

4.1.2 कंपनी, विलगन - कंपनी को विलगित करने की व्यवस्था की जाएगी ताकि कंपनी को भवन और संरचना में संप्रेषित होने से रोका जा सके।

4.2 लिफ्ट कूप का सामान्य प्रदीपन

लिफ्ट कूप में भूतल से प्रारंभ करके उपयुक्त प्रकाश बिंदु प्रदान किए जाएंगे तथा इनके बीच की दूरी 10 मी० से अधिक नहीं होनी चाहिए। सभी बिन्दू एम/सी कक्ष से ग्रुप नियंत्रित किये जाने चाहियें। तार विछाने का कार्य सी.पी.डब्ल्यू.डी के सामान्य विनिर्देशों के अनुसार पृष्ठ नलिका में किया जाएगा। अनुरक्षण कर्मियों द्वारा उपयोग किए जाने के लिए एक सॉकेट आउटलेट भूतल अवतरण से कुछ ऊपर शैफ्ट में उपलब्ध कराया जाएगा।

5.0 गाइड रेल

गाइड रेलें आई एस 14665 (भाग 4 धारा 2) 2000 के खंड 3 के अनुसार होंगी। यात्रियों और अस्पताल लिफ्ट की कारों के लिए केवल मशीनित गाइड रेलों की अनुमति दी जाएगी। 1.75 एम० पी० एस० चाल तक प्रतिभार अनुप्रयोगों के लिए प्ररूपित चादर धातु रेलों का उपयोग किया जाएगा। माल लिफ्टों के मामले में सभी चालों पर तथा 0.5 मी० / से० चाल वाली कारों के लिए बिना मशीनित गाइड रेलों को प्रतिभार के लिये अनुमति दी जाएगी।

गाइड रेलें पूरी यात्रा तक अविच्छिन्न तथा पूर्ण भरी कार होने पर सुरक्षा गियर के कार्य से बिना विरूपित हुए सहन करने योग्य होनी चाहिए।

सामान्यतः गाइड रेलें प्रत्येक तल पर लगे हाइस्टवे फ्रेम ब्रकिटों द्वारा आलंबित होंगी। रेल अनुमोदित भारी रेल क्लैपों द्वारा ब्रकिटों या अन्य आलम्बों से पूर्णतः बंधी होती हैं। सभी आवश्यक गाइड रेल पैकिंग या अतिरिक्त आलंब उपलब्ध कराए जाएंगे ताकि गाइड रेल विचलन और प्रतिबलों को निर्धारित सीमाओं से अधिक होने से रोका जा सके। लदान, उतराई तथा चालन के दौरान गाइड रेलों पर क्षैतिज बलों के कारण पड़ने वाले प्रतिबलों की गणना बिना संघट्ट के लदान वर्ग के आधार पर 1100 किग्रा० / सेमी०² तथा विचलन 5 मिमी० से अधिक नहीं होना चाहिए। गाइड रेल ब्रेकिट, उनके बंधक और आलम्ब उपर्युक्त क्षैतिज बलों का प्रतिरोध करने में सामर्थ्य होने चाहिए तथा आलम्ब बिंदु पर कुल विचलन 3 मिमी० से अधिक नहीं होना चाहिए।

गाइड रेलें गर्त फर्श से कंक्रीट स्लैब के भीतर की ओर तक या लिफ्ट कूप के ऊपर ग्राफिंग तक विस्तारित होंगी। वे साहुल में तथा अधिकतम 3 मिमी० के विचलन के साथ समान्तर खड़े किए जाएंगे। सभी आवश्यक वेशनी अनुकूलन धातु के तथा अपने स्थान पर सुरक्षित होने चाहिए। संयोजक प्लेटों की स्थिति आलम्बन क्लैपों और ब्रेकिटों को बाधित नहीं करनी चाहिए। बोल्टों को सिंग्रिंग लॉक वाशरों के साथ उपयोग में लाया जाएगा। गर्त फर्श पर गाइड रेल को लगाने का कार्य जल रोधन को पंचर किए बिना ही किया जाना चाहिए गाइड रेलों में विस्तार जोड़ों को इस प्रकार डिजाइन किया जाएगा ताकि लिफ्ट कार में झटकों से बचा जा सके। मशीनित गाइड रेलों के पृष्ठ परिष्कृत तथा संक्षारण रोधी यौगिक से लेपित होना चाहिए तथा इसे अधिष्ठापन प्रारंभ होने तक बनाए रखा जाना चाहिए। कार को प्रचालन के लिए स्थापित करने से पूर्व गाइड रेल से निवारक लेप हटाकर इसे अच्छी प्रकार साफ और चिकना बनाया जाना चाहिए।

6.0 लिफ्ट कार

6.1 कार फ्रेम

कार फ्रेम आई-एस 14665 (भाग 4 धारा 3 : 2001 के खंड 4) के अनुसार मजबूत इस्पात चादर से निर्मित होना चाहिए ताकि बिना किसी विरूपण के सुरक्षा गियर प्रचालन को सहन कर सके। कार को फ्रेम पर इस प्रकार आरोपित होना चाहिए कि यात्रियों तक पहुँचने वाले कंपनी और शोर को न्यूनतम रखा जा सके।

4.1.1 **Ventilation of machine room** – Machine room shall be provided with natural air and mechanical ventilation to avoid over heating of the electrical equipments and to ensure proper operation of the controller. Entry of dust etc. shall also be suitably prevented.

4.1.2 **Vibration, Isolation** – Vibration and isolation arrangement shall be provided to prevent transmission of vibration to the building and structure.

4.2 **General Illumination of Lift well**

Suitable light points shall be provided in the lift well at a spacing of not more than 10 meters in between, starting at the ground floor. All the points should be group controlled from the M/C room. The wiring shall be carried out in surface conduit as per CPWD General Specification. One socket outlet shall be provided in the shaft for use by maintenance personnel at a level slightly above the ground floor landing.

5.0 **Guide rails**

Guide rails shall be in accordance with clause 3 of IS 14665 (Part 4- Sec 2) 2000. Only machined guide rails shall be permitted for cars for passengers and hospital lifts. Formed sheet metal rails shall be used upto speeds of 1.75 mps for counter weight applications. In the case of goods lifts, unmachined guides rails shall be permitted for the counterweight for all speeds and for the cars only upto a speed of 0.5 m/sec.

The guide rails shall be continuous throughout the entire travel and shall withstand without any deformation the action of safety gear with a fully loaded car.

Generally the guide rails shall be supported by brackets secured to the hoistway frame at each floor. The rails shall be securely fastened to the brackets or other supports by approved heavy rail clamps. All necessary guide rails packing or additional supports shall be provided to prevent guide rail deflection and stresses exceeding the prescribed limits. The stresses on the guide rail due to the horizontal forces imposed on it during loading, unloading and running calculated without impact, shall not exceed 1100 kg/sq. cm based upon the class of loading and the deflection shall not exceed 5mm. The guide rail brackets, their fastenings and supports shall be capable of resisting the horizontal forces mentioned above, with the total deflection at the point of support not in excess of 3mm.

Guide rails shall extend from pit floor to the underside of concrete slabs or grating at top of the lift well. They shall be erected in plumb and parallel with a maximum deviation of 3mm. All shimming required shall be of metal securely held in place. Jointing plates shall be so located as not to interfere with supporting clamps and brackets. The bolts shall be used with spring lock washers. The guide rail anchorage at pit floor must be made without puncturing the water proofing. The expansion joints in the guide rails shall be so designed as to avoid jerks in the lift car. Machined guide rails shall have finished surfaces which shall be coated with corrosion preventive compound which shall be maintained till the commissioning of the installation. Before the car is placed in operation, the preventive coating shall be removed and the guide rails thoroughly cleaned and smoothed.

6.0 **Lift Car**

6.1 **Car Frame**

The car frame shall be in accordance with clause –4 of IS 14665 (Part 4–Sec 3) : 2001 made of sheet steel of rigid construction to withstand without permanent deformation the operation of safety gear. The car shall be so mounted on the frame that vibration and noise transmitted to the passengers inside is minimised.

6.2 कार प्लेट फार्म

6.2.1 कार प्लेटफार्म फ्रेम द्वारा निर्मित तथा इसका डिजाइन समान रूप से वितरित निर्धारित भार पर आधारित रहेगा। इसकी विभाएं, जब तक अन्यथा विनिर्धारित न हों, आई एस 14665 (भाग 1) 2000 के अनुरूप होंगी। फर्श मासुण तथा पृष्ठ प्रतिधिसटक होना चाहिए। माल लिफ्ट की फर्श पर्याप्त मजबूत होनी चाहिए ताकि बिना किसी विकृति या क्षति के निर्धारित भार को ले जा सके।

6.2.2 निर्धारित भार और स्वीकार्य अधिकतम यात्रियों की संख्या देते हुए प्रत्येक लिफ्ट कार में किसी साफ स्थिती में अतिभार अलार्म के साथ भार प्लेट लगाई जाएगी।

6.3 कार बॉडी (काय)

कार धात्विक संवरक द्वारा परिवृत्त होगी। दरवाजे सहित अहाता किसी बिंदु पर लंबवत पड़ने वाले 35 किग्रा० प्रणोद बिना किसी विकृति के सहन कर सकेगा तथा यह आई एस 14665 (भाग 4 धारा 3) 2001 के अनुसार होगा। विनिर्दिष्ट होने पर संवातन विवर आई एस 14665 (भाग 4/धारा 3) 2001 के अनुसार होगी।

6.3.1 बेड /माल लिफ्टों के लिए / पी वी सी / रबड़ बहिर्वेधन से निर्मित तथा जंग रोधी इस्पात बीडिंग में वेष्टित स्ट्रेचर गार्ड / ट्राली गार्ड पश्च / पार्श्व पैनलों के समुचित स्तरों पर लगाए जाएंगे।

6.3.2 लिफ्ट कार दरवाजे की निर्धारित अग्नि-रोधक क्षमता एक घंटे की होगी।

6.3.3 भू-तल स्तर पर भूसंपर्कन स्विच (स्विचें) सभी लिफ्टों पर उपलब्ध कराई जाएंगी ताकि अग्नि शमन सेवा लिफ्टों को भूसंपर्कित करने में समर्थ हो सके।

6.4 कार छत

कार की छत ठोस प्रकार की तथा कम से कम 140 किग्रा० भार लेने के योग्य और आई एस 14665 (भाग 4 धारा 3) 2001 के अनुसार होगी।

6.5 कार देहली

कार प्रवेश द्वार पर धातु की देहली लगाई जाएगी तथा पृष्ठ खॉचेदार होना चाहिए। क्षैतिज सरकवाँ कार दरवाजों या फाटकों वाली लिफ्टों के लिए देहली मशीनित तथा बहिर्वेधित गाइड खॉचों वाली होनी चाहिए।

6.6 पदाग्र (टो) गार्ड ऐग्रन

प्रवेशद्वार के दोनों ओर कम से कम 15 मि०मी० दूरी तक पदाग्र गार्ड ऐग्रन जिसका गेज 1.6 मि०मी० चादर इस्पात से कम न हो उपलब्ध कराया जा सकता है। गार्ड का अग्र भाग सीधा ऊर्ध्वाधर परिष्कृत कार फर्श तल के नीचे तक विस्तारित होगा तथा समतलन जोन से + 7.5 मि०मी० से कम गहरा नहीं होगा। गार्ड का निचला सिरा 1.5 एम. पी. एस. तक चाल वाली लिफ्टों के लिए 700 मि०मी० तथा 1.5 एम. पी. एस. से अधिक चाल वाली लिफ्टों के लिए 1000 मि०मी० तक ऊर्ध्वाधर फलक के नीचे तक विस्तारित तथा ऊर्ध्वाधर से 15° कोण पर वेवलित किया गया होगा। इसे कार प्लेटफार्म से जोड़ा तथा प्रबलित किया और बांधा जाएगा।

6.7 अवकाश

कार के शीर्ष और लिफ्ट शैफ्ट छत, कार तथा गर्त फर्श, बफर आदि के बीच के अवकाश, तथा कार और लिफ्ट कूप, कार और अवतरण सिल, एक ही शैफ्ट में दो लिफ्ट कारों के बीच का अवकाश आई एस 14665 (भाग 1, 2, और 4) और परिशिष्ट -1 में उल्लेखित संगत लिफ्ट नियमों के अनुसार प्रदान किया जायेगा।

6.2 **Car platform**

6.2.1 The car platform shall be of framed construction and designed on the basis of rated load evenly distributed. The dimensions shall conform to IS: 14665 (part 1), 2000 unless otherwise specified. The flooring shall be smooth and of anti-skid surface. The flooring for goods lift shall be strong enough to take the rated load without any deformation or damage.

6.2.2 A load plate along with overload alarm, giving the rated load and permissible maximum number of passengers should be fitted in each lift car in a conspicuous position.

6.3 **Car body**

The car shall be enclosed on all sides by a metallic enclosure. The enclosure including the door shall withstand without deformation a thrust of 35kg applied normally at any point and as per IS 14665 (part 4/ Sec 3)-2001. Ventilation openings if specified shall be as per IS 14665 (Part 4/ Sec 3)-2001.

6.3.1 Stretcher guards/ trolley guards made of PVC/ Rubber extrusion housed in a stainless steel beading shall be fitted at suitable level (s) to rear / side panels for bed lifts/ goods lifts.

6.3.2 Lift car door shall have a fire resistance rating of one hour.

6.3.3 Grounding switch (es), at ground floor level, shall be provided on all the lifts to enable the fire service to ground the lifts.

6.4 **Car roof**

The roof of the car shall be solid type capable of supporting a weight of at least 140 kg and as per IS 14665 (Part -4 -Sec 3): 2001

6.5 **Car Thresholds**

Car entrance shall be provided with metal thresholds having a grooved surface. Thresholds for lifts having horizontally sliding car doors or gates shall have machined or extruded guide grooves.

6.6 **Toe Guard Aprons**

The toe guard apron of gauge not less than 1.6mm sheet steel may be provided extending at least 15mm beyond entrance jambs at each side. The guards shall have a straight vertical face extending below the level of the finished car floor and not less than the depth of the levelling zone plus 7.5mm. The bottom of guard shall extend 700mm for lifts upto speed of 1.5 mps & 1000 mm for lifts above speed of 1.5 mps below vertical face and bevelled at 15° angle from the vertical. It shall be seamed to car platform construction and be reinforced and braced.

6.7 **Clearance**

The clearance between the top of the car and the soffit of the lift shaft roof, bottom of the car and the pit floor, the buffers etc., and the clearance between the car and the lift well, between the car and the landing sill, between two lift cars in the same shaft etc, shall be provided as per IS 14665 (Part 1,2 & 4) and relevant lift rules mentioned in Appendix -I.

6.8 कार ऐग्रन, अवतरण देहलियां और सिल

ऐग्रन को कार प्लेटफार्म पर इस प्रकार लगाया जाना चाहिए कि अवतरण के समय दरवाजा खोलने पर कोई खतरनाक अंतराल मौजूद न हो। देहली और सिल प्लेटों अवतरणों पर भी प्रदान की जाएंगी। अवतरण सिल तथा कार प्लेटफार्म सिल के बीच की दूरी 30 मिमी० से अधिक नहीं होनी चाहिए।

6.9 अतः संचार प्रणाली

6.9.1 यद्यपि आई एस 14665 (भाग 2 / धारा 1) : 2000 का पैरा कार के भीतर आपात सिग्नल या टेलीफोन की व्यवस्था के लिए सुझाव देता है परन्तु सामान्य अनुभव यह है कि समय बीतने पर कुछ कारणों से ये युक्तियां निष्क्रिय हो जाती हैं। अतः एक युक्ति को सदैव सक्रिय रखने के लिए लिफ्ट कारों में दोनों की वैकल्पिक व्यवस्था अर्थात् न्यूनतम दो कनेक्शन युक्त टेलीफोन एक प्रचालक कक्ष पर तथा दूसरा गार्ड कक्ष पर, तथा विद्युत पूर्ति के लिए पुनः चार्ज करने योग्य बैटरियों वाली आपात सिग्नल व्यवस्था उपलब्ध कराई जाएगी।

6.9.2 आपात सिग्नलों के लिए प्रयुक्त युक्ति में यह विशेषता होनी चाहिए कि वह कार यात्रियों को तुरन्त परिपुष्टि करे कि युक्ति ने उचित ढंग से कार्य किया है तथा आशदित ऐजेंसी को सिग्नल भेज दिया गया है। इसे नियंत्रण कक्ष से बटन दबाकर प्राप्त किया जा सकता है और यह कार के यात्रियों को श्रव्य सिग्नल भेजेगा।

6.9.3 लिफ्टों के कार्य-करण को दर्शाने के लिए नियंत्रण कक्ष में ग्रुप सूचक पैनल की व्यवस्था की जाएगी।

6.9.4 लिफ्ट कार के लिये आपात विद्युत पूर्ति

इसमें लिफ्ट कार में प्रकाश फिक्सरों को पूर्ति के लिए ट्रिक्ल / बूस्ट चार्ज व्यवस्था युक्त उपयुक्त द्वितीयक बैटरी और आवश्यक संपर्क वाला इनवर्टर पॉवर पैक शामिल है। वही बैटरी अलार्म घंटी तथा संचार उपस्कर की भी पूर्ति करेगी।

6.10 निर्धारण और अनुदेश

लिफ्ट का पूर्तिकार लिफ्ट कार के भीतर निर्धारित भार तथा यात्रियों के लिए विस्तृत अनुदेश लिखी एक जंग रोधी इस्पात प्लेट भी लगाएगा। इसे उपयुक्त स्थान पर लगाया जाएगा।

6.11 लिफ्ट कार का भीतरी परिष्करण

पार्श्व पृष्ठ और सामने के पैनल खरोच मुक्त जंगरोधी इस्पात चादर के बने होंगे। यात्री लिफ्टों के लिए फर्श 3 मिमी० मोटी पी. वी.सी. टाइल की तथा माल लिफ्टों और माल-सह-यात्री लिफ्टों के लिए फर्श चारखाने वाली एल्युमिनियम चादर की होगी। लिफ्ट कार की आभासी अंतस्छद उपयुक्त रंग से लेपित मृदु इस्पात पाउडर से तथा सी.एफ.एल. लैप और पंखा विसारक अलग रंग में रंगी जाएगी।

6.11.1 कार के भीतर का प्रचालन पैनल

कार प्रचालन पैनल धातु का सपाट रोपित तथा कार की भीतरी सज्जा के अनुरूप विधिवत परिष्कृत होगा तथा इसमें प्रचालन की आवश्यकतानुसार विनिर्धारित सभी युक्तियां शामिल होंगी। इसके अलावा फर्श और दिशा को दर्शाने के लिए ऊपर या दरवाजे के रास्ते पर एक अतिरिक्त पृथक प्रदीपन पैनल प्रदान किया जा सकता है। सभी स्विचें म्लानता रोधी तथा युक्तियां उपयुक्त गुणवत्ता की होनी चाहिए।

प्रत्येक युक्ति और उसकी प्रचालन स्थिति स्पष्ट म्लानरोधी तथा चिन्हित होनी चाहिए।

7.0 कार और अवतरण द्वार

कार और अवतरण दरवाजे पॉवर प्रचालन के लिए सपाट प्रकार के इस्पात चादर के ही होंगे। सपाट प्रकार का आगे एकल सरकवां मध्य में खुलने वाला या दो चाल निर्माण का होगा। पॉवर प्रचालित कार तथा अवतरण दरवाजे इस प्रकार डिजाइन किए जाएंगे

6.8 **Car Apron, Landing Thresholds and Sills**

An apron shall be fitted to the car platform such that no dangerous gap exist at any time when the landing door is opening. Thresholds and sill plates shall be provided at the landings also. The distance between landing sill and the sill on car platform shall not be more than 30mm.

6.9 **Inter-communication system**

6.9.1 Though para 8.4.3 of IS 14665 (part 2/sec 1) : 2000 recommends for provision of either an emergency signal or a telephone inside the car but as a general experience, it is seen that over a period of time these devices become inoperative due to one reasons or the other. Therefore, in order to have at least one device of communication functioning at all the times, as an alternative arrangement, provision of both i.e. telephone with minimum two connections- one at the operator's room and other at guard room and the emergency signal with re-chargeable batteries as source of supply shall be made in the lift cars.

6.9.2 The device used for emergency signals should incorporate a feature that gives immediate feedback to the car passengers that the device has worked properly and the signal has been passed on to the intended agency. This shall be achieved by pressing of button from control room which shall give audio signal to the passengers in the car.

6.9.3 Provision of group indicator panel in the control room shall be made to indicate working of lifts.

6.9.4 **Emergency Power Supply for lift car**

This shall include suitable secondary battery with trickle/ boost charge arrangement and inverter power pack with necessary contactors for supplying the light fixtures in the lift car. The same battery shall also feed the alarm bell and communication equipment.

6.10 **Ratings and Instructions**

Inside the lift car, the lift supplier shall also provide a stainless steel metallic plate indicating the rated load and detailed instructions for the passengers. This shall be mounted at a suitable place.

6.11 **Lift Car Interior Finish**

The side, rear and fascia panel shall be of scratch free stainless steel sheet. The flooring shall be with 3mm thick PVC tiles for passenger lifts and chequered aluminium sheet for goods lifts and goods-cum-passenger lifts. The False ceiling in the lift car shall be crafted from mild steel powder coated to suitable colour with CFL lamps and fan diffuser (s) in different colour.

6.11.1 **Operating Panel Inside the car**

The car operating panel shall be of metal, flush mounted and duly finished to match the car interior décor and shall contain all the devices as may be specified depending upon the type of operation required. In addition separate illuminated panel for indicating the floor and direction may be provided on the top or the door way. All switches shall be fade proof and the devices shall be of suitable quality.

Each device and its operating position shall be legible fade proof and marked.

7.0 **Car and landing entrances**

The car and landing doors shall be of flush type sheet steel only for power operation. The flush type may further be of single sliding, centre opening or two speed construction. Power operated

कि वे बंद होते समय किसी व्यक्ति को घायल न करें इसके हेतु एक सुरक्षा दाब स्विच की व्यवस्था की जाएगी जो निम्नतम दाब पर दरवाजों को पुनः खोल देगी। पॉवर प्रचालित दरवाजों के मामले में बिजली फेल हो जाने पर कार के भीतर से उन्हें खोलना संभव होगा। यात्री लिफ्टों के लिए सभी द्वारों ऊँचाई में 2000 मिमी० का अवकाश होगा। माल लिफ्ट के लिए ऊर्ध्वाधर द्वि-विभाजक या सिमटवां दरवाजे, यथा विनिर्दिष्ट, उपयोग में लाए जाएंगे। दरवाजे के खुलने और बंद होने का कार्य बिना किसी अनापेक्षित शोर, कंपन और झटके के निर्बाध रूप से तथा तीव्रतापूर्वक किया जाएगा और गति दोनों सीमाओं पर कुशन युक्त तथा नियंत्रित होगी।

7.1 कार दरवाजे

7.1.1 दरवाजे शीर्ष एम.एस. से संविरचित ट्रेक से लटकाए जाएंगे तथा दरवाजे को ट्रेक से बाहर उछलने से रोकने के उपाय किए जाएंगे। दरवाजों में निर्धारित प्रकार के द्वार प्रचालन के लिए उपयुक्त दो बिंदुक निलंबन चरखी प्रकार के हैंगर लगाए जाएंगे। हैंगर आधातवर्ध लौह या इस्पात ब्रैकेट पर आरोपित बियरिंगों पर सुरक्षापूर्वक बंधित किए जाएंगे। कार दरवाजों की ऊर्ध्वाधर और क्षैतिज समायोजन के लिए व्यवस्था की जाएगी। एम.एस. संविरचित ट्रेक पर चरखियां गति करेंगी। इनका आकार इस प्रकार का होता है कि चरखी के ऊर्ध्वाधर समायोजन पर चरखी ब्रैकेट या वेशन (हाउसिंग) के ऊर्ध्वाधर समायोजन पर भी यह मुक्त रूप से गति कर सके।

कार्यालय, आवासीय तथा माल लिफ्ट अनुप्रयोगों के लिए कार दरवाजे मध्य में खुलने वाला क्षैतिज, सरकवां जंगरोधी खरोचरोधी इस्पात (मून रॉक फिनिश) के तथा अस्पतालों के लिए टेलिस्कोपी क्षैतिज सरकवां जंगरोधी खरोचरोधी पृष्ठ (मून रॉक फिनिश) वाले होने चाहिए।

7.1.2 दुर्घटनाओं के अधिकांश कारण बिजली फेल होने के कारण नीचले तल से दूर कार के रुक जाने पर अवतरण द्वार पाश को खोलने के लिए किए जाने वाले प्रयास हो सकते हैं। चूंकि आई एस 14665 (भाग 2 / धारा 1) 2000 के पैरा 10.9.1 में यथा उल्लेखित संवातन में सुधार तथा घुटन से बचने के लिए कार दरवाजे को खोला जा सकता है, इसलिए फंसे हुए यात्रियों की प्रवृत्ति होती है कि वे पहुँच वाले अवतरण दरवाजे को खोलने के प्रयास करें। दरवाजे को विद्युत् यांत्रिक लैच से, जो कि खुले कार दरवाजे से दिखाई देता है, खोला जा सकता है। घबराहट में इस प्रकार के प्रयास के परिणाम स्वरूप यह लिफ्ट गर्त में गिर सकती है। फंसे यात्री अवतरण दरवाजे को खोलने का प्रयत्न न करें यह सुनिश्चित करने के लिए विद्युत्-यांत्रिक लैच का डिजाइन इस प्रकार का होना चाहिए कि वह कार के यात्रियों की पहुँच में न आए या उन्हें दिखाई न दे।

7.1.3 कार में चढ़ते या उतरते समय दुर्घटना बस दरवाजों को बंद होने से बचाने के लिए दरवाजे की पूरी ऊँचाई को कवर करने वाला टेंपर रोधी अवरोक्त परदा लिफ्ट दरवाजों में प्रदान किए जाने चाहिए।

7.2 रौथिका मुक्त आवश्यकताओं के अनुसार प्रावधान :

7.2.1 उपविधियों के अनुसार जहाँ कहीं भी लिफ्ट आवश्यक है कम से कम एक में पहिए दार कुर्सी के लिए व्यवस्था की जाएगी। भारतीय मानक ब्यूरो द्वारा 13 यात्री क्षमता वाली लिफ्ट के लिए निम्नलिखित लिफ्ट पिंजरा (केज) विभाएं सुझाई गयी हैं।

स्पष्ट आंतरिक गहराई	:	1100 मिमी०
स्पष्ट आंतरिक चौड़ाई	:	2000 मिमी०
प्रवेश द्वार चौड़ाई	:	900 मिमी०

7.2.2 एक हस्त रेल, जिसकी लंबाई कम से कम 600 मिमी० हो तथा फर्श तल से 900 मिमी० कम ऊँची न हो, नियंत्रण पैनल के आसन्न लगायी जाएगी।

7.2.3 स्वतः बंद होने वाले दरवाजे का न्यूनतम समय 5 सेकेंड तथा बंद होने की चाल 0.25 मी०/से० से अधिक नहीं होनी चाहिए।

car and landing doors shall be so designed as not to injure any person during their closure by means of provision of a safety pressure switch which shall cause the doors to reopen on the slightest pressure. In case of power operated doors, it shall be possible on power failure, to open them from the car side. All the openings for passenger lifts shall be 2000 mm clear in height. For goods lift vertical by-parting doors or collapsible gates as specified shall be used. The door opening and closing shall be accomplished smoothly and quickly without undue noise, vibration and shock and their movements shall be cushioned and checked at both limits.

7.1 Car doors

7.1.1 The car door shall be hung from the top M.S. fabricated track and means shall be provided to prevent the door from jumping off the track. The doors shall be provided with two point suspension sheave type hangers suitable for the type of door operation specified. The hangers shall be securely fastened on bearings mounted on a malleable iron or steel bracket. Arrangement shall be provided for vertical and lateral adjustment of car doors. The sheaves shall move on a M.S. fabricated track so shaped as to permit free movement of sheaves with regard to vertical adjustment of sheave bracket or housing.

The car door shall be centre opening horizontal sliding stainless steel scratch proof (moon rock finish) for office, residential & goods lift applications whereas telescopic horizontal sliding stainless scratch proof surface (moon rock finish) for hospitals.

7.1.2 A potential cause of accidents could be the attempts made to open the landing door lock of lower floor in case the car stops away from floor level due to power failure. Since the car door can be opened in case of power failure so as to improve the ventilation and avoid claustrophobic situations etc. as outlined in IS 14665 (part 2/sec 1) : 2000 para 10.9.1, there is a tendency among trapped passengers to make attempts to open any accessible landing door which can be opened by a electromechanical latch in the landing doors as the lock is accessible through open car doors. This attempt in panic may result in accidental fall into the lift pit. In order to ensure that the trapped passenger do not attempt opening the landing door, the electromechanical latch should be so designed that it is inaccessible or invisible to the passengers in the car.

7.1.3 In order to avoid accidental closure of doors while boarding or alighting the car, a tamper proof infrared curtain covering almost the entire height of the door should be provided in the lift doors.

7.2 Provisions as per Barrier Free requirements

7.2.1 Wherever lift is required as per by-laws, provision of at least one lift shall be made for the wheel chair user with the following cage dimensions of lift recommended for passenger lift of 13 persons capacity by Bureau of Indian Standards.

Clear internal depth	:	1100 mm
Clear internal width	:	2000 mm
Entrance door width	:	900 mm

7.2.2 A hand rail not less than 600mm long at 900mm above floor level shall be fixed adjacent to the control panel.

7.2.3 The time of an automatically closing door should be minimum 5 seconds and the closing speed should not exceed 0.25 M/Sec.

7.2.4 पिंजरे के भीतरी भाग में ऐसी युक्ति उपलब्ध कराई जाएगी। जो श्रव्य रूप से यह दर्शाएगी कि पिंजरा पहुंच गया है तथा यह भी दर्शाएगी कि प्रवेश/निकास के लिए पिंजरे का दरवाजा खुला है या बंद।

7.3 अवतरण (लैंडिंग) दरवाजे

प्रत्येक अवतरण दरवाजा पाश, हैडर, फ्रेम, रिम, कवर प्लेट युक्त हैंगर आलंब, फलक आदि से पूर्ण होगा। पूरा किया गया कार्य मजबूत, दृढ़ तथा साफ-सुथरा होना चाहिए। समतल पृष्ठ चिकना तथा व्यांकुचन या उभार रहित होना चाहिए। ढला पृष्ठ साफ, सीधा और समतल होना चाहिए। बंधक समग्री के ऊपर की ओर से ढके होने चाहिए। इस्पात सिल में शैफ्ट की ओर लगभग 25 मिमी० गहराई की उपयुक्त नोजिंग होगी। अवतरण फाटकों के द्वार या दरवाजे लिफ्ट कार के दरवाजे से अधिक चौड़े नहीं होने चाहिए। द्वि-विभाजक प्रकार के इस्पात दरवाजों के मामले में दरवाजों की दो पत्ती पाशन का पाश धनात्मक (पॉजिटिव) होना चाहिए।

7.4 कार अवतरण

7.4.1 सभी कार अवतरण 150 लक्स प्रदीपन स्तर से अच्छी प्रकार प्रकाशित तथा अवरोध मुक्त होने चाहिए। अवतरण प्रकाश तथा संकेत प्रकाश के लिए नियंत्रण टैंपर (छेड़-छड़) रोधी होना चाहिए। विद्युत पूर्ति की अतिरिक्त व्यवस्था उपलब्ध होने पर इन बत्तियों को अतिरिक्त परिपथों से भी जोड़ दिया जाना चाहिए।

7.4.2 अभिनिर्धारण के उद्देश्य से अवतरण दरवाजे बाहर कार के भीतर तथा मशीन कक्ष में लिफ्ट संख्या प्रदर्शित की जानी चाहिए। उस संख्या का प्रयोग नेमी/निवारक अनुरक्षण के उद्देश्य के लिए मशीन कक्ष से प्रचालन तथा किसी घटना से संबंधित रिपोर्ट आदि के लिए संदर्भ के रूप में किया जा सकता है।

7.4.3 अनुदेश

यात्रियों के मार्गदर्शन के लिए यथाविनिर्दिष्ट विस्तृत अनुदेश संविदाकार द्वारा कार के भीतर तथा विभाग द्वारा सभी अवतरणों पर कार के बाहर लगाये जाएंगे। विभाग द्वारा लिफ्ट लॉबी में सभी अवतरणों पर बाहर की तरफ उस लिफ्ट के लिये जो कि परिशिष्ट-VI के अनुसार अवरोधक मुक्त जरूरतों को पूरा करने के लिये है, ब्रेल संकेतक लगाये जायेंगे।

7.4.4 सामान्यतः यह देखा गया है कि संगत आई० एस० प्रावधानों के अनुसार करें और न करें के अनुदेश लिफ्ट कारों में लगाए तो जाते हैं परन्तु वे या तो अस्पष्ट स्थल पर लगे हैं या उनका आकार बहुत छोटा है या वे केवल एक ही भाषा में हैं। इन अनुदेशों के आशादित उद्देश्यों को प्राप्त करने तथा संगत मात्र आई एस खण्ड का अनुपालन न करने हेतु इन अनुदेशों को स्पष्ट स्थान पर लगाया जाना चाहिए और साफ अक्षरों में तथा हिन्दी अंग्रेजी तथा क्षेत्रीय भाषा में (जहाँ क्षेत्रीय राज भाषा अधिसूचित है) लिखे जाने चाहिए।

8.0 समतलन

सभी लिफ्टों में उपयुक्त तल समतलन युक्तियां लगी होनी चाहिए। स्वतः पावर प्रचालित दरवाजों और ए.सी., वी.वी.वी.एफ. नियंत्रण वाली लिफ्टों के मामले में स्वतः समतलन के लिये ± 5 मिमी० परिशुद्धता की पृथकतल युक्ति लगायी जाएगी।

9.0 प्रति - भार

लिफ्ट कारों का प्रतिभार आई. एस. 14665 (भाग 4 - धारा - 3) : 2001 के खण्ड 6 के अनुसार होगा तथा इसे खाली कार का भार धन निर्धारित भार का लगभग 50% भार को संतुलित करने के लिए डिजाइन किया जाएगा। इसमें ऐसे ढले परिच्छेद होंगे जो दो तान छड़ों (टाइ रॉड) द्वारा दृढ़तापूर्वक संरक्षित होंगे ताकि वे सापेक्ष गति न कर सकें। तान छड़ों के दोनों सिरों पर नट विपाटित (स्लिट) पिनें लगी होंगी तथा दोनों प्रत्येक परिच्छेद से होकर गुजरेंगे तथा दृढ़ इस्पात फ्रेम वर्क में वैशित होंगी। दरार वाले तथा टूटे हुए उप-भार स्वीकार नहीं किये जाएंगे।

The interior of the cage shall be provided with a device that audibly indicate the floor the cage has reached and indicate that the door of the cage for entrance/exit is either open or closed.

Landing doors

Each landing door shall be complete with locks, headers, sills, frames, rims, hanger supports with cover plates, fascia plates etc. The finished work shall be strong, rigid and neat in appearance. Plain surfaces shall be smooth and free from warp or buckle. Moulded surfaces shall be clean out, straight and true. Fastenings shall be concealed from the face side of the material. Steel Sills shall be provided with a suitable nosing of approximately 25mm depth on the shaft side.

The opening for the landing gates or doors shall not be wider than that of the lift car. In the case of bi-parting type steel doors, the locking of the two leafs locking of the doors should be positive.

Car landings

All the lift car landings shall be well lit to an illumination level of 150 lux and shall be free from obstructions. The control for landing lights and the sign lights shall be tamper proof. Wherever stand by power supply is available, these lights shall be connected to standby circuits also.

For the purpose of identification, the lift number should be displayed outside the landing door, inside the car and in the machine room. This numbering may be used as reference for the purpose of routine/ preventive maintenance, for operating from machine rooms and reporting of any incidents etc.

Instructions

Detailed instructions as specified for guidance of passengers shall be prominently displayed inside the car by contractor and outside the car at all landings by the department. The Braille signage will be posted by the department outside lift lobby at all landings for the lift meant for barrier free requirements as per Appendix VII.

It is seen generally, that though the instruction on DO's and Don'ts, as per provision of the relevant IS, are displayed in lift cars but the same are either displayed in inconspicuous location, or are very small in size or are in one language only. To make these instructions serve the intended purpose, and not a mere compliance of relevant IS clause; that these instructions should be displayed at a conspicuous location with larger and understandable script and should be written in Hindi, English and regional language (where official regional language is notified).

Levelling

All lift (s) shall be incorporated with suitable floor levelling devices. In case of lifts with automatic power operated doors and with A.C. VVVF controller a separate level device for automatic levelling with levelling accuracy of ± 5 mm shall be incorporated.

Counter Weight

The counter weight for lift cars shall be in accordance with clause 6 of IS 14665 (Part 4-Sec-3) : 2001 and shall be designed to balance the weight of empty lift car plus approximately 50 per cent of the rated load. It shall consist of cast sections firmly secured in relative movement by at least two numbers steel tie rods having lock nuts/split pins at each end and passing through each section and Housed in a rigid steel frame work. Cracked and broken sub weights shall not be accepted.

9.1 प्रति भार गार्ड

अनुरक्षण कर्मियों को चोट की संभावना को समाप्त करने के लिए गर्त फर्श से ऊपर उपयुक्त ऊँचाई पर लिफ्ट गर्त में तार धातु/जाली के गार्ड उपलब्ध कराये जाएंगे।

10.0 गाइड नाल (शूज़)

लिफ्ट कार और प्रतिभार पर दो गाइड नाल ऊपर तथा दो गाइड नाल नीचे उपलब्ध कराये जायेंगे।

10.1 नाल के प्रकार

10.1.1 यात्री लिफ्टों तथा बेड-सह-यात्री लिफ्टों के लिए

(क) 1.5 एम पी एस तक की चाल के लिए सरकवां गाइड नाल उपयोग में लाये जाएंगे। कार के लिए सरकवां गाइड नाल सदैव नम्य होंगे तथा प्रतिभार ठोस गाइड के लिए 1.0 एम पी एस तक नाल का उपयोग किया जा सकता है।

(ख) 1.5 एम पी एस से अधिक चाल वाली कार और प्रतिभार के लिये रोलर गाइड नाल का उपयोग किया जाएगा।

10.1.2 माल लिफ्टों के लिए ठोस नाल उपयोग में लाये जा सकते हैं।

10.2 नम्य प्रकार के / ठोस प्रकार के सरकवां गाइड नाल

1 एम पी एस तक चाल वाली लिफ्ट कारों के लिए नवीकरणीय लाइनरों वाले ठोस या कमानी भारित भ्रामी गाइड नाल प्रदान किये जाएंगे। 1 एम. पी. एस. से अधिक चाल वाली कारों के लिए नवीकरणीय लाइनरों युक्त कमानी भारित गाइड नाल या रोलर प्रकार के गाइड नाल लगाए जाएंगे।

10.3 रोलर प्रकार के गाइड नाल

प्रत्येक रोलर प्रकार का नाल अनुमोदित प्रकार का रोलर ढलाई तथा पर्याप्त धातु आधार पर संयोजित होगा और ऐसे आरोपित होगा की वह भार व प्रचालन की सभी दशाओं में संगत गाइड रेल पृष्ठों के साथ सतत सभी रोलरों के संपर्क में रहे। रोलरों को तीन परिष्कृत गाइड रेल पृष्ठों पर चलना चाहिए तथा ध्वनि रहित प्रचालित होने चाहिए।

10.3.1 गाइड नालों का आरोपण

गाइड नालों के आरोपण समायोजनी होंगे तथा कार स्लिंग के प्रत्येक ओर ऊपर और नीचे से तथा प्रतिभार फ्रेम निर्माण से सीधी रेखा में होंगे। प्रतिभार से नीचे संलग्न तेल बफर का उपयोग किये जाने पर बफर फ्रेम के प्रत्येक ओर अतिरिक्त गाइड नाल लगाये जायेंगे। गाइड नाल तथा कार सुरक्षा युक्ति के डिजाइन इस प्रकार समन्वित होने चाहिए कि इस अध्याय के खंड 5.7 में विनिर्दिष्ट अवकाश के साथ उपस्कर का प्रावधान और अधिष्ठापन सुनिश्चित किया जा सके।

11.0 लिफ्ट रज्जु - आई एस 14665 (भाग 4 / धारा 8) -2001

लिफ्ट के लिए 12.5 मीटरी टन/सेमी² से अधिक तनन सामर्थ्य तथा अच्छी नम्यता वाली इस्पात तार रज्जुओं से निर्मित गोल लड़ इस्पात रज्जु उपयोग में लाई जाएगी। लड़ों के बीच का स्नेहन संसेचित सुतली प्रदान करके प्राप्त किया जा सकता है। लिफ्ट रज्जु आई एस 14665 (भाग - 4 धारा - 8) : 2001 के अनुरूप होगी तथा निम्नलिखित सुरक्षा कारकों का पालन किया जाएगा। कारों और यात्री प्रतिभार तथा माल लिफ्ट के लिए रज्जु का न्यूनतम व्यास 8 मिमी० होगा।

यात्री तथा माल लिफ्टों की रज्जु चाल (मी./से.)	सुरक्षा घटक
0.5 या इससे कम	8
0.5 से अधिक 1.0 तक	8.6
1.0 से अधिक 2.0 तक	10
2.0 से अधिक 3.5 तक	11
3.5 से अधिक	12

9.1 Counter Weight Guards

Guards of wire metal/ mesh shall be provided in the lift pit to a suitable height above the pit floor to eliminate the possibility of injuries to the maintenance personnel.

10.0 Guide shoes

Two numbers of guide shoes at the top and two numbers at the bottom shall be provided on the lift car and counter-weight.

10.1 Type of shoes

10.1.1 For passenger lifts and bed-cum-passenger lifts

- (a) For speed upto 1.5 mps sliding guide shoes shall be used. Sliding guide shoes for car shall be always flexible and for counterweight solid guide shoes can be used upto 1.0 mps.
- (b) For speeds more than 1.5 mps roller guide shoes shall be used for car and counter weight.

10.1.2 For goods lifts solid shoes can be used.

10.2 Flexible type/solid type sliding guide shoes

The car shall be provided with solid or spring loaded swivaling guide shoes with renewable liners, where the lift car speeds are upto and including 1 MPS. The cars with speeds beyond 1 MPS shall be provided with spring loaded guide shoes with renewable liners or the guide shoes shall be of roller type.

10.3 Roller type guide shoes

Each roller type shoe shall be of an approved type consisting of rollers assembled on a substantial metal base and mounted as to provide continuous contact of all rollers with the corresponding guide rail surfaces under all conditions of load and operation. The rollers shall run on the three finished guide rail surfaces and shall operate quietly.

10.3.1 Mounting of guide shoes

Guide shoes shall be provided with adjustable mountings & shall be rigidly secured in accurate alignment at the top and bottom on each side of the car sling and counter weight frame construction. When oil buffers attached to the bottom of counter weight are used, additional guide shoe shall be provided on each side of the buffer frame. The design of guide shoes and car safety device shall be coordinated so as to ensure the provision and installation of equipment with clearance specified in clause 5.7 of this Chapter.

11.0 Lift Ropes – IS 14665 (part 4/Sec 8)-2001

Round strand steel wires ropes made from steel wire ropes having a tensile strength not less than 12.5 tonnes/ cm² and of good flexibility shall be used for lift. Lubrications between the strands shall be achieved by providing impregnated hemp core. The lift ropes shall conform to IS 14665-(Part -4-Sec.-8): 2001 and the following factor of safety shall be adhered to. The minimum diameter of rope for cars and counter weight of passenger and goods lift shall be 8 mm.

<i>Rope speed of passenger & goods lifts (m/s)</i>	<i>Factor of safeties</i>
0.5 or less	8
exceeding 0.5 to 1.0	8.6
exceeding 1.0 to 2.0	10
exceeding 2.0 to 3.5	11
exceeding 3.5	12

- 11.1 **रज्जु बंधक**
लिफ्ट रज्जुओं के सिरे एकल टेपर बैबिट सॉकेट वाली समायाजनी रज्जु शैकल या किसी अन्य उपयुक्त व्यवस्था से कार या प्रतिभार खॉचा प्लेटों से दृढ़ता पूर्वक जुड़े होने चाहिए। प्रत्येक रज्जु शैकल में उपयुक्त शैकल कमानी सीट वाशर, शैकल नट और पाश (लॉक) तथा शैकल नट विपाटित (स्लिट) पिन लगे होंगे।
- 11.2 **लिफ्ट रज्जु गार्ड**
उन स्थानों पर जहाँ लिफ्ट रज्जु कार की चरखी या चरखियों पर और / या गियर युक्त / गियर रहित मशीन के प्रतिभार के चारों ओर घूमती है, उपयुक्त गार्ड प्रदान किए जाएंगे ताकि अनुरक्षण कर्मियों को चोट से बचाया जा सके।
- 11.3 **रज्जुओं की संख्या और आकार**
संविदाकार उपयोग के लिए प्रस्तावित लिफ्ट रज्जुओं और नियंत्रक रज्जुओं की संख्या और आकार, उनका मूल, प्रकार, अंतिम सामर्थ्य तथा सुरक्षा घटकों को निश्चित रूप से दर्शाएगा। संविदाकार सक्षम प्राधिकारी द्वारा जारी किए गए रज्जु विनिर्माताओं से रज्जु प्रमाण पत्र प्रस्तुत करेगा।
- 12.0 **सुरक्षा उपस्कर**
प्रत्येक लिफ्ट अधिष्ठापन के लिए अनिवार्य रूप से निम्नलिखित सुरक्षा विशेषताएं प्रदान की जाएंगी।
- 12.1 आई एस 14665 (भाग 4, धारा 4) : 2001 के अनुसार सुरक्षा गियर प्रदान किए जाएंगे, प्रत्येक प्रकार की कार सुरक्षा चाल नियंत्रक से सक्रिय की जाएगी।
- 12.2 **अधिनियंत्रक (गवर्नर)** - कार सुरक्षा सिरोपरि अवस्थित तथा नियंत्रक रज्जु द्वारा चालित चाल अधिनियंत्रक द्वारा प्रचालित होती है। अधिनियंत्रक रज्जु उपयुक्त ढंग से कार से संयोजित तथा अपनी स्वयं की पुली पर अधिरोपित होती है। रज्जु को भार के माध्यम से या गर्त में अवस्थित कमानी भारित तनन चरखी द्वारा तनन की अवस्था में बनाए रखा जाता है। 5.5 मीटर से अधिक यात्रा करने वाली लिफ्टों के लिए नियंत्रक प्रदान किया जाएगा।
अधिनियंत्रक रज्जु का व्यास 6 मिमी० से कम नहीं होना चाहिए तथा यह इस्पात या फास्फरब्रांज की बनी होनी चाहिए। ये आई० एस० 14665 (भाग 4/धारा 4) : 2001 के अनुरूप होनी चाहिये। सुरक्षा गियर को निम्नलिखित चालों पर सक्रिय करने के लिए कार सुरक्षा गियर नियंत्रक को समायोजित किया जाएगा :
(क) अधिकतम 1 मी०/से० तक की निर्धारित चालों के लिए नियंत्रक ट्रिपिंग चाल निर्धारित चाल का 140 प्रतिशत या 0.88 मी०/से० जो भी अधिक हो, होनी चाहिए। अधिकतम 1 मी०/से० से अधिक निर्धारित चाल के लिए अधिनियंत्रक ट्रिपिंग चाल निर्धारित चाल का 115 प्रतिशत धन (+) 0.25 मी०/ से० होनी चाहिए।
(ख) अधिकतम अधिनियंत्रक ट्रिपिंग चाल निर्धारित चाल का 115 प्रतिशत होगी।
- 12.2.1 अधिनियंत्रक के पहिए का डिजाइन "V" खॉचा युक्त होगा तथा नीचे की ओर पूर्व निश्चित अतिचाल पर रज्जु को बिना क्षति पहुँचाए कार सुरक्षा को सक्रिय करने के लिए केवल पहिए को रोका जाता है।
- 12.3 अधिनियंत्रक, रज्जु और चरखी ऐसी होगी कि दुर्घटना के कारण उपस्कर को क्षतिग्रस्त होने की संभावना न्यूनतम हो।
- 12.3.1 अधिनियंत्रक चरखी तथा तनन चरखी खंड 2.4 के अनुसार होगी। चरखी का बियरिंग इस अध्याय के खंड 2.7 के अनुसार होगा।
- 12.3.2 कार सुरक्षा तथा नियंत्रक संबंधी क्षेत्र परीक्षण तथा सरकवां प्रकार की कार सुरक्षाओं के पात परीक्षणों के लिए आवश्यकताएं, इस विनिर्देश के खंड IV में विनिर्धारित किए गए अनुसार होंगी।

11.1 Rope fastenings

The ends of lift ropes shall be properly secured to the car and counter weight hitch plates as the case may be with adjustable rope shackles having individual tapers babbit sockets, or any other suitable arrangement. Each lift rope shackle shall be fitted with a suitable shackle spring, seat washer, shackle nut & lock & shackle nut split pin.

11.2 Guards for lift ropes

Where lift ropes run round a sheave or sheaves on the car and /or counterweight of geared/ gearless machine suitable guards shall be provided to prevent injury to maintenance personnel.

11.3 Number & size of ropes

The contractor must indicate the number and size of lift ropes and governor ropes proposed to be used, their origin, type, ultimate strength and factor of safety. The contractor should furnish certificate of ropes from the rope manufacturers issued by competent authority.

12.0 Safety Equipments:

Every lift installation shall necessarily be provided with the following safety features:

12.1 The safety gear shall be provided in accordance with IS 14665(Part-4-Sec.4):2001, each type of car safety shall be actuated by a speed governor.

12.2 Governor – the car safety shall be operated by speed governor located overhead and driven by governor rope suitably connected to the car and mounted on its own pulleys. The rope shall be maintained in tension by means of weighted or spring loaded tension sheaves located in the pit. Governor shall be provided for lifts with a travel of more than 5.5 meters. The governor rope shall be not less than 6mm in dia and shall be made of steel or phosphorbronze. These shall be in accordance with IS 14665 (part 4/sec-4): 2001. Governor for car safety gears shall be adjusted to actuate the safety gear at the following speeds:-

(a) For rated speeds upto 1m/s maximum governor tripping speed shall be either 140 percent of rated speed or 0.88 m/s, which ever is higher. For rated speed above 1m/s maximum governor tripping speed shall be 115 per cent of the rated speed plus 0.25 m/s.

(b) Minimum governor tripping speed shall be 115 per cent of the rated speed.

12.2.1 The governor shall be of "V" groove wheel design and only wheel is stopped to actuate the car safety upon a pre-determined over speed downward without damaging the rope.

12.3. The governor, rope and sheave shall be so located so as to minimise danger of accidental injury to the equipment.

12.3.1. The governor sheave and tension sheave shall be according to clause 2.4 and the sheave bearing shall be according to clause 2.7 of this Chapter.

12.3.2 The requirements for field tests on car safety and governor and for drop tests to sliding type car safeties shall be as specified in section IV of this specifications.

12.4 टर्मिनल सीमा स्विच

ये कार को अंतिम तलों पर ऊपरी और निचली स्वीकार्य अति - यात्रा के भीतर स्वतः रोक देगी। वे प्रचालन युक्तियों, अन्तिम सीमा स्विचों और बफर से स्वतंत्र रहकर कार्य करेंगी। वे आई एस : 14665 (भाग 3 - धारा 1) : 2000 के खंड - 8 के अनुसार होंगी।

12.4.2 शैफ्ट या कार में अवस्थित और कैम द्वारा प्रचालित टर्मिनल रोक युक्तियों में रबड़ या अन्य अनुमोदित संघटनों वाले रोलर लगे होने चाहिए। ताकि कैम द्वारा सक्रिय किए जाने पर नीरव प्रचालन हो सके। जब लिफ्ट कार क्रास हैड इसके ऊपर के निकटतम अवरोध से 60 से० मी० दूर हो तो कार का कोई प्रक्षेप सिरोपरि संरचना के किसी भाग को प्रभावित नहीं करेगा।

12.4.3 1.25 मी०/से० से अधिक चाल वाली लिफ्टों में कार पर या गाइड रेलों पर या मशीन कक्ष में अवस्थित सामान्य टर्मिनल रोक युक्तियां होंगी।

12.5 अन्तिम टर्मिनल स्विचें

इन्हें कानूनी प्रावधानों तथा स्थायी प्रक्रियाओं के अनुसार उपलब्ध कराया जाएगा। उपलब्ध होने पर ये सामान्य टर्मिनल स्विचों से स्वतंत्र रहकर ऊपरी तथा निचले अवकाशों के भीतर, परन्तु बफर को प्रचालित रहते हुए, स्वतः कार को रोकने की व्यवस्था करेंगी। ये आई एस : 14665 (भाग 3/धारा 1) : 2000 के खंड 8 के अनुसार होंगे।

12.6 बफर - (आई एस : 14665 (भाग 4/धारा 1) : 2001)

0.25 एम. पी. एस. तक चाल के लिए बफर तेल प्रतिरोधक (रबड़) पैड प्रकार के तथा 1.5 एम. पी. एस. तक चाल के लिए कमानी/तेल प्रकार के और 1.5 एम.पी.एस. से अधिक चाल के लिए केवल तेल प्रकार के होने चाहिए।

बफर उपलब्ध स्थान में अधिष्ठापित करने योग्य होने चाहिए। गर्त फर्श पर बफर स्थिरक का अधिष्ठापन जल रोधक में छिद्र किए बिना किया जाना चाहिए।

कार और प्रतिभार के तेल बफर कमानी प्रत्यावर्ती प्रकार के या गुरुत्व प्रकार के होने चाहिए।

कार को टर्मिनल अवतरण तल में होने पर कमानी प्रत्यावर्ती तेल बफर का आंशिक संपीडन स्वीकार्य नहीं होगा।

सभी बफरों का विनिर्माता के कार्यस्थल पर परीक्षण किया जाएगा तथा परीक्षण रिपोर्ट की एक प्रति जमा की जाएगी।

उस समय जब कार के बफर पूर्णतः संपीडित दशा में हो तब कार फ्रेम के निकटतम बिन्दु और बफर या उसके टेक के इतर गर्त में किसी अवरोध के बीच का अवकाश कम से कम 60 सेमी० होगा।

संविदाकार बफर विनिर्माताओं के नाम बफर स्ट्रोक तथा प्रमाणित अधिकतम भार को अवश्य दर्शाएगा।

12.7 दरवाजा पाश (लॉक)

सभी अवतरण दरवाजों के लिए विद्युत - यांत्रिक दरवाजा पाश अर्थात् लॉक उपलब्ध कराए जाने चाहिए और वे इस प्रकार के होने चाहिए कि दरवाजे को किसी विशेष अवतरण पर रूक जाने पर ही खोला जा सके। कार को तब तक चलना संभव नहीं होगा जब तक सभी अवतरण दरवाजे और कार दरवाजा बन्द और पाशित न हो जाए। परन्तु स्वतः समतलन युक्त वाले लिफ्ट कार के लिए इसकी आवश्यकता नहीं होगी और ऐसे मामलों में इस बात की अनुमति होगी कि समतलन के उद्देश्य से समतलन जोन में दोनों दरवाजों को खुला रखकर कार को चलाया जा सके।

12.4 **Terminal limit switches**

12.4.1 **Terminal switches**

These shall stop the car automatically at terminal floors within the top and bottom permissible over travel. They shall act independently of the operating devices, the ultimate limits switches and the buffers. They shall be in accordance with clause 8 of IS: 14665 (part 3-Sec 1) : 2000.

12.4.2 Terminal stopping devices located in shaft or in the car and operated by cams shall be fitted with rollers having a rubber or other approved composition to provide silent operation when actuated by the cam. When the lift car cross head is 60cm from the nearest obstruction above it, no projection on the car shall strike any part of the overhead structure.

12.4.3 Lifts with speeds over 1.25 meters/ second shall have the normal terminal stopping device located on the car or on the guide rails or in the machine room.

12.5 **Ultimate Terminal Switches**

These shall be provided in accordance with the statutory requirements and standing practices. When provided these shall arrange to stop the car automatically within top and bottom clearances independently of the normal terminal switches but with the buffers operative. These shall be in accordance with clause 8 of IS: 14665 (Part 3/Sec 1)-2000.

12.6 **Buffers – (IS 14665(Part 4/Sec 1)-2001)**

Buffers shall be oil resistant rubber pad type for speeds upto 0.25 mps and spring / oil type for speeds upto 1.5 mps and only oil type for speeds higher than 1.5 mps.

Buffers shall be suitable for installation in the space available. Buffer anchorage at pit floors shall be installed avoiding puncturing of water proofing.

Oil buffers of the car and counter weight shall be of the spring return type or of gravity type.

The partial compression of spring return oil buffers when the car is in level with terminal landing will not be acceptable.

All buffers shall be tested at manufacturers works and a copy of the test report shall be submitted.

When the lift car rests on fully compressed buffers there shall be at least 60 cms clearance between the lowest point in its car frame and any obstruction in the pit exclusive of buffers and their supports. Similarly when the lift car cross head is 60 cm from the nearest obstruction above it, no projection on the car shall strike any part of the overhead structure.

The contractor must indicate the name of buffer manufacturers, buffer stroke & certified maximum loads.

12.7 **Door Locks**

Electro –mechanical door lock shall be provided for all the landing doors and they shall be such that the doors cannot open unless the car is at rest at the particular landing. It shall not be possible to move the car unless all the landing doors and the car door are closed and locked. This requirement however does not apply when the lift car is provided with automatic levelling devices and in such cases, it shall be permitted to move the car with both the doors open in the levelling zone for the purpose of levelling.

सभी पाश और संपर्क आई० एस० 14665 (भाग 1/धारा 6) : 2001 के अनुरूप तथा धनात्मक होगा और इसे मान्यता प्राप्त परीक्षण प्रयोगशाला से निर्धारित सहन और विश्वसनीयता परीक्षण पास करने होंगे। उनके स्थान ऐसे हों कि वहां अनाधिकृत व्यक्ति न पहुँच सके। विद्युत यांत्रिक चटखनी इस प्रकार डिजाइन हो कि यह कार के यात्रियों की पहुँच से दूर या अदृश्य हो।

12.8 अन्य सुरक्षाएं

उपर्युक्त इन सुरक्षा युक्तियों के अलावा इसमें मोटर प्रचालित विद्युत - यांत्रिक ब्रेक (खंड 1.6) प्रतिभार गार्ड (खंड 8.1) अलार्म घंटी - आपात दरवाजा पाश मोचन प्रचलन चाबी तथा संबंधित सुरक्षा और अन्य सुरक्षा आवश्यकताएं भी शामिल की जाएंगी।

13.0 लिफ्ट प्रचालन

13.1 स्वचालित - सह - परिचर प्रचालन

13.1.1 एकल स्वचालित दाब बटन परिचर सहित/रहित

इस प्रचालन के लिए कार प्रचालन पैनल पर प्रचालन युक्तियों में संगत विभिन्न अवतरणों के कार बटन तथा प्रत्येक अवतरण पर एकल अवतरण बटन शामिल हैं। ये सभी तल चयन, यात्रा की दिशा, त्वरण, मंदन आदि को नियंत्रित करने वाले नियंत्रक से विद्युत रूप से संयोजित होते हैं।

यह प्रणाली इस प्रकार व्यवस्थित होनी चाहिए कि जब कार उपयोग में न लायी जा रही हो, तथा सभी दरवाजे बन्द हों तो अवतरण कॉल बटन दबाने पर कार को स्वतः चालू हो जाना चाहिए। कार चालन के दौरान तथा उस समय भी जब कार तल अवतरण अर्थात् लैंडिंग पर रुक रही हो तब पूर्व निर्धारित समय के लिए अन्य अवतरण आह्वान (कॉल) बटन निष्प्रभावी रहेंगे। कार बटन के दबाने पर स्वतः प्रारंभ हो जाएगी तथा वांछित अवतरण के लिए चल देगी। इन सभी मामलों में कार का प्रवर्तन अवतरण द्वार स्थापन तथा कार अंतः-पाश परिपथों अर्थात् इंटर लॉक सर्किट का आनुषंगिक है। उपलब्धता या उपयोग में है, यह दर्शाने के लिए अवतरण कॉल बटन पैनल पर बत्ती लगाई जानी चाहिए। बत्ती बंद (ऑफ) होने पर यात्री कार का आह्वान कर सकते हैं। हस्त चालित दरवाजे के मामले में यदि लिफ्ट किसी अवतरण पर दरवाजा खुले रूकी है तो अवतरण कॉल बटन दबाने पर कार के ऊपर लगी घंटी बजेगी ताकि यदि कोई व्यक्ति दरवाजे के निकट खड़ा है तो लिफ्ट का दरवाजा बंद करने के लिए उसकी सहायता ली जा सके।

पॉवर प्रचालित दरवाजों के मामले में उस समय जब कार अवतरण पर पार्क स्थिति में हो, अवतरण और कार दरवाजे स्वचालित रूप में खुलने के लिए व्यवस्थित होंगे। कॉल पूरा होने के पश्चात् लिफ्ट किसी अवतरण पर पार्क हो जाती है। दरवाजे इच्छानुसार खुले या बंद रह सकते हैं। कार को खुलने वाली युक्ति या दरवाजे खोलने के बटन द्वारा रोके या बाधित किये जाने के अलावा ऐसी व्यवस्था होगी कि द्वार पूर्व - निर्धारित समय के बाद स्वतः बंद हो जाएं।

“परिचर” और “स्वचालित” स्थिति दर्शाने वाली चाबी प्रचालित ट्रांसर स्विच द्वारा लिफ्ट को परिचर द्वारा या उसके बिना दोनों प्रकार से प्रचालित किया जा सकेगा। परिचर प्रचालनों के दौरान नियंत्रण प्रणाली से अवतरण काल को वियोजित कर दिया जाएगा तथा लिफ्ट कार में एननसिएटर से संयोजित कर दिया जाएगा। इसके बाद परिचर रजिस्टर की गई कॉलों के उत्तर में कार प्रचालित करेगा। यह प्रचालन कम ऊँचाई वाले एकल लिफ्ट अधिष्ठापन तथा एकल चाल नियंत्रण वाली लिफ्ट के लिए संस्तुत है।

13.1.2 परिचर सहित/रहित सिम्पलैक्स चयनात्मक सामूहिक प्रचालन

संयोजित प्रत्येक अवतरण के लिए एक बटन तथा अवतरणों पर ऊपर और नीचे के लिये बटनों द्वारा स्वचालित प्रचालन, इसमें शक्ति सक्रियण से जैसा कि इसे गैर-चयनात्मक स्वतः प्रचालन के रूप में परिभाषित किया गया है। रजिस्टर होता है परंतु

All the locks and contacts shall conform to IS: 14665 (Part 1/ Sec 6)-2001 shall be positive and pass the prescribed endurance and reliability test from a recognised testing laboratory. They shall be so located as to be inaccessible to un-authorised personnel. The electromechanical latch should be so designed that it is inaccessible or invisible to the passengers in the car.

12.8 **Other safeties**

Besides these safety devices mentioned above, motor operated electro-mechanical brake (Clause 1.6) counter-weight guards (Clause 8.1) alarm bell, emergency door lock release operating key and associated safety and other safety requirements shall also be included.

13.0 **Lift operations**

13.1 **Automatic- cum-attendant operation**

13.1.1 **Single Automatic Push Button with/ without attendant** – The operating devices for this operation shall incorporate in the car control panel, car buttons corresponding to the various landings served and single landing button at each landing, all electrically connected to controller governing floor selection, direction of travel, acceleration, retardation etc.

This system shall be so arranged that when the car is not in use, on pressing a landing call button the car shall start automatically provided all the doors are closed. During the movement of the car and also when car stops at floor landing, other landing call buttons are in-operative for a predetermined time. The pressing of a car button shall automatically start the car and send it to the desired landing. In all the cases, the starting of the car is contingent on the establishment of landing door and car inter-lock circuits. To indicate the availability, or 'in use' light shall be placed in the landing call button panel. When light shall be 'OFF' the passenger shall be able to call the car. In case of manual operated door if the lift is standing at any landing with doors open (when not in use), the pressing of the landing call button shall ring a bell, fitted at the top of car to attract the attention of the people soliciting their help for closing the lift door if any one of the them happens to be near the lift.

In case of power operated doors, the landing and car doors shall be arranged to open automatically when the car is parked at landing after all the calls are served and the lift is parked at any landing. The doors can remain open or alternatively if desired, the car shall be arranged to close after a pre-determined time unless closing is prevented or interpreted by the car doors re-opening device or the door open button.

The lift shall be suitable for dual operation with or without attendant by the provision of key operated transfer switch indicating 'attendant' and 'automatic' positions. During 'attendant' operations the landing call shall be disconnected from the control system and shall be connected to an annunciator in the lift car. The attendant shall then operate the car to answer the registered calls. This operation is recommended for single speed control lift for low rising building having a single lift installation.

13.1.2 **Simplex Selective-Collective operation with /without attendant**

Automatic operation by means of one button in the car for each landing level served and by up-and-down buttons at the landings, wherein all stops registered by the momentary actuation of the car made as defined under non-selective Automatic Operation but where in the stops registered by the momentary actuation of the landing buttons are made in the order in which the landings are

अवतरण बटनों का क्षणिक सक्रियण यात्रा की दिशा में पहुँचने के क्रम में रजिस्टर होते हैं। (इसमें बटन सक्रियण का क्रम निरपेक्ष होता है)। ऐसे प्रचालन से सभी ऊपर (अप) अवतरण काल कार को ऊपर जाते समय तथा नीचे (डाऊन) अवतरण काल कार के नीचे जाते समय उत्तरित होते हैं, परन्तु उच्चतम और निम्नतम काल कार की यात्रा की दिशा में पहुँचते ही उत्तरित होते हैं।

13.1.3 परिचर सहित/रहित डुप्लैक्स सामूहिक चयनात्मक प्रचालन

इस प्रचालन के लिए नियंत्रण प्रणाली सिम्प्लैक्स चयनात्मक प्रचालन के अंतर्गत उद्धृत किए गए अनुसार होगी परन्तु इस प्रणाली में दो लिफ्ट कार आसन्न दीवारें होंगी। कुशल सेवा के लिए दोनों कारों को इस प्रकार समन्वित किया जाएगा कि मात्र एक सेट अवतरण कॉल बटन फिक्सरों की व्यवस्था से एक ही कॉल के लिए दोनों की अनुक्रिया से रोका जा सके। प्रत्येक काल स्वतः उस कार को सौंपा जाएगा जो तुरंत उत्तर के लिए उपयुक्ततम स्थिति में हो। प्रणाली को इस प्रकार व्यवस्थित किया जाएगा कि सामान्यतः एक कार बंद या खुले दरवाजे के साथ नीचले मुख्य अवतरण पर तथा दूसरी बंद या खुले दरवाजे के उस अवतरण पर जहाँ अंतिम काल अवतरित हुआ और निकटतम काल तक पहुँचने के लिए होगी।

प्रत्येक कार अपनी कॉल बटनों द्वारा रजिस्टर किए गए कॉलों का उत्तर देगी। किसी कारणवश एक कार सेवा से बाहर होने पर दूसरी कार (सिम्प्लैक्स) चयनात्मक सामूहिक के रूप में कार्य करेगी। इसके अलावा कार के भीतर से स्वतंत्र सेवा के लिए नियंत्रण प्रणाली की व्यवस्था भी की जाएगी।

कार के भीतर एक बाई-पास बटन (नॉन स्टॉप बटन) भी उपलब्ध कराई जाएगी ताकि कार भरी होने या अन्यथा आवश्यक होने पर परिचर किसी अवतरण को बाई-पास कर सके। दो लिफ्टों को परिचर के सहित या रहित प्रचालन के लिए व्यवस्थित किया जाएगा और ये एकल कार चयनात्मक - सामूहिक प्रचालन का उपयोग करने के लिए उद्धृत ढंग से कार्य करेगी।

उस समय जब अंतरण स्विच परिचर (अटेंडेंट) स्थिति में हो तो इस बात के अलावा कार स्वतः प्रचालनों के लिए उद्धृत के समरूप होगी कि:

- (क) दरवाजों को बंद करने और कार के चालू करने के कार्य केवल कार बटनों के द्वारा ही शुरू किए जाएंगे;
- (ख) बजर तथा कार में दिशात्मक बत्तियां चालन योग्य होंगी; और
- (ग) अवतरण अर्थात् लैंडिंग बाई-पास प्रभावी होगा।

ऊपर या नीचे अवतरण कॉल को दबाने पर कार पैनल पर उचित दिशा सूचक प्रदीप्त हो जाएगा जो कि कॉल का उत्तर (अनुक्रिया) है तथा दरवाजे खुले होने पर परिचर को ध्वनि बजर संकेत भी प्राप्त होगा। दोनों कारों को निम्न अवतरण पर पार्क होने पर उपर्युक्त सिग्नल उस कार को दिया जाएगा जो तल पर अधिक समय से है।

13.2 स्वचालित ग्रुप पर्यवेक्षी नियंत्रण

13.2.1 सामान्य प्रचालन सिद्धांत

कार के भीतर तथा अवतरणों पर रजिस्टर किए गए काल बटन दबाने के अनुक्रम को ध्यान में न रखते हुए तलों के क्रम में उत्तरित होंगे। किसी एक अवतरण कॉल के उत्तर में केवल एक ही कार रुकेगी और वह कार संगत दिशा में चल रही निकटतम कार होगी। कार को इस अवतरण पर रुकने से कॉल स्वतः निरस्त हो जाएगी ताकि दूसरी कार उसी काल के लिए न रुके।

reached in each direction of travel (irrespective of the sequence in which the buttons have been actuated). With this type of operation, all 'up' landing calls are answered when the car is travelling in the up direction and all 'down' landing calls are answered when the car is travelling in the down direction, except in the case of the uppermost or lowermost calls which are answered as soon as they are reached in-respective of the direction of travel of the car.

13.1.3 *Duplex Collective Selective Operation with/without attendant*

The control system for this operation shall be similar to the one described under simplex selective-collective operation except that in this system there shall be two lift cars in adjacent wells. It shall be arranged to co-ordinate both cars for efficient service and prevent them from answering the same calls by the provisions of only one set of landing call button fixtures. It shall automatically assign each call to the car that will be in the best position to answer promptly. The system shall be so arranged that when the cars are idle, normally one car will be parked at the lower main landing with its doors closed or open and the other car shall be free car parked with the doors closed or open to the landing where it answered its last call, and shall be the one to attend to the nearest call.

Each car shall always respond to calls registered by its own car call buttons. When either car is parked out of service for any reasons the other car shall function as single car (simplex) selective collective. Besides the control system shall also be arranged for independent service from inside the car.

A by-pass button (non-stop button) shall also be provided inside the car to enable the attendant to by-pass any landing if the car is full or if otherwise so required.

The two lifts shall be arranged with or without attendant operation and shall function as described using single car selective-collective operation. When the transfer switch is in the attendant position the operation of the cars shall be identical with that described for automatic operations except that :

- (a) Closing of doors and starting of cars shall be initiated by the car buttons only;
- (b) Buzzers and directional lights in the car are operative , and
- (c) Landing by-pass shall be effective.

The pressing of an up or down landing call shall illuminate appropriate direction indicator in the car panel, which is to answer that call and if the doors are open shall also sound buzzers as a signal to the attendant. If both cars are parked at the lower landing the above signals shall be given to the car which has been at the floor for longest time.

13.2 *Automatic group supervisory control*

13.2.1 *General operating principle*

The calls registered inside the car as well as the landings are answered in the sequence in which the floors are reached irrespective of the sequence in which the buttons have been pressed. Only one car will stop in response to any one landing call and will be the nearest car travelling in the corresponding direction of the call. While this car is stopping at this landing, the call will be automatically cancelled to prevent other cars stopping against the same call.

13.2.2 यातायात (प्रोग्राम) का स्वतः चयन

ग्रुप पर्यवेक्षी नियंत्रण भवन की यातायात दशाओं की निरंतर जाँच करता है और किसी समय विशेष के माँग के अति अनुरूप प्रोग्राम को स्वतः प्रचालित कर देता है। यह पूर्णतः स्वचालित है और इसके लिए किसी पर्यवेक्षण या परिचर की आवश्यकता नहीं है। भवन की यातायात माँग के अनुरूप इस नियंत्रण में शामिल करने के लिए उपयुक्त यातायात (ट्राफिक) कार्यक्रमों का चयन किया जा सकता है। उपलब्ध यातायात प्रोग्राम निम्नलिखित हैं :-

- (क) अप पीक (उच्च चरम) प्रोग्राम
- (ख) डौउन पीक (निम्न चरम) प्रोग्राम
- (ग) अप-डौउन अंतःतल प्रोग्राम और
- (घ) रात्रि प्रोग्राम

- (क) **अप पीक (उच्च चरम) प्रोग्राम :-** ग्रुप पर्यवेक्षी नियंत्रण सुबह के समय कार्य प्रारम्भ करते समय अप पीक (उच्च चरम) कार्यक्रम को स्वतः चालू करने से मुख्य अवतरण पर यात्रियों की बढ़ती गति पर अनुक्रिया करता है। पूर्ववर्ती कार के प्रेषण के पश्चात् पूर्व-निर्धारित अंतराल पर कारें स्वचालित रूप से मुख्य अवतरण से प्रेषित की जाती हैं। मुख्य अवतरण पर, प्रेषित की गयी कार से दूसरी कार को, तत्काल 'पहले जाएगी' (लीक्स फ़र्ट) का सिगनल भेजा जाएगा। कार तलों के स्वभाविक अनुक्रम में रजिस्टर की गयी कॉलों का उत्तर देती है और अंतिम यात्री को छोड़ने के बाद मुख्य अवतरण पर वापस आ जाती है। मुख्य अवतरण पर नए यात्रियों को लेने के लिए पूर्व निर्धारित समय पर रखी जाती है। परन्तु पूर्णतः भर जाने के तुरंत बाद, प्रेषण अंतराल की समाप्ति की प्रतीक्षा किए बिना, ऊपर की यात्रा प्रारम्भ कर देती है।
- (ख) **डौउन पीक (निम्न चरम) प्रोग्राम :-** ऊपरी तलों से मुख्य अवतरण की ओर तेज यातायात प्रवाह डौउन पीक प्रोग्राम को स्वतः चालू कर देगा। कारें ऊपरी तल पर पूर्णतः भर जाने पर सीधे मुख्य अवतरण पर आती हैं और यात्रियों को छोड़ने के पश्चात् निम्न अवतरण काल का पुनः उत्तर देने के लिए तुरन्त प्रारंभ हो जाती हैं। बाई-पास कर दिया गया कॉल अन्य निम्न कॉल (डौउन कॉल) पर प्राथमिकता पाता है ताकि सभी तलों के लिए समान सेवा सुनिश्चित की जा सके।
- (ग) **अप-डौउन (ऊपर नीचे) अंतःतल प्रोग्राम :-** मुख्य तल तथा ऊपरी तल तथा एक तल से दूसरे तल के बीच निरंतर यातायात के कारण अंतः तल प्रोग्राम स्वतः चालू हो जाता है। विशेष कारों को यातायात विश्लेषक द्वारा विशेष कॉल का उत्तर देने का कार्य दिया जाता है ताकि कॉलों को अति कुशल ढंग से संभाला जा सके। कॉलों को इस प्रकार वितरित किया जाता है कि प्रत्येक काल निम्नतम प्रतीक्षा अंतरालों के साथ बराबर सेवा प्राप्त करे। कॉलों की संख्या बहुत कम होते ही, जैसे कि रात को, कार अपने लिए निर्धारित जोन में पार्क हो जाती है ताकि निम्नतम लिफ्ट यात्रा के साथ वैयक्तिक सेवा प्रदान करे। कुछ समय के लिए कोई कॉल रजिस्टर न होने पर मोटर जनरेटर सैट स्वतः बंद हो जाते हैं।
- (घ) **रात्रि प्रोग्राम :-** यातायात यदा-कदा कॉल तक सीमित हो जाने पर पर्यवेक्षी नियंत्रण स्वतः रात्रि प्रोग्राम पर चला जाता है। सभी कारें बंद दरवाजों के साथ मुख्य अवतरण पर पार्क रहती हैं परन्तु प्रचालन के लिए सदैव तैयार रहती हैं। एक लिफ्ट का सिगनल "पहले जाएगी" प्रकाशित रहता है। मुख्य अवतरण के कॉल बटन को दबाने पर इस लिफ्ट के दरवाजे खुल जाते हैं और यात्री इसमें यात्रा कर सकते हैं, वही लिफ्ट उपर से अवतरण कॉल का भी उत्तर देगी। इस कार को मुख्य अवतरण से चलते डी सिगनल "पहले जाएगी" दूसरी लिफ्ट पर चला जाएगा और मुख्य लॉबी में आने वाले यात्री इस दूसरी लिफ्ट को लेंगे। यदि पहली लिफ्ट मांग को पूरा करने में असमर्थ हो तो दूसरी लिफ्ट भी अवतरण कॉल का उत्तर देगी। अपनी कॉलों का उत्तर देने के पश्चात मुख्य अवतरण पर अंत में पहुंचने वाली लिफ्ट पर "पहले जाएगी" का सिगनल बना रहेगा। इस प्रकार व्यवहारिक रूप से सेवा केवल एक लिफ्ट तक सीमित रहेगी और शेष लिफ्टों के जनरेटर सेटों की स्विचें बंद रहेगी। कुछ समय तक यदि कोई कॉल रजिस्टर नहीं होती तो इस (तैयार) लिफ्ट के मोटर जनरेटर की स्विच स्वतः बंद हो जाएगी। मोटर जनरेटर कॉल प्राप्त होते ही पुनः चालू हो जाएगा, चालू होने वाली लिफ्टों की संख्या स्वतः विनियमित होती है ताकि उतनी ही लिफ्टें प्रचालित हों जो उस समय की यातायात आवश्यकता को पूरा करने के लिए पर्याप्त हो।

13.2.2 Automatic selection of traffic programme

The group supervisory control continuously examines traffic conditions in the building and automatically puts into operation the programme which can best cope with the demand at any particular time. This is fully automatic and requires no supervision or attendant. To suit the traffic demand in the building, suitable traffic programmes can be selected for inclusion in this control. The following are the traffic programmes available:

- (a) Up Peak Programme,
- (b) Down Peak Programme,
- (c) Up down Interfloor Programme, and
- (d) Night Programme,

- (a) *Up Peak Programme* :- The group supervisory control responds to the increasing influx of passengers at the main landing in the morning hours, at the start of work, by automatically switching on the up peak programme. The cars are despatched from the main landing automatically at a pre-determined interval after the previous despatched car. The 'Leaves First' signal is transferred instantaneously from the car despatched to another car at the main landing. The car answers the registered calls in the natural sequence of the floors and returns directly to the main landing after last passenger has been discharged. At the main landing they are kept for a predetermined time for taking new passengers. However, a car starts its up travel the moment it becomes fully loaded, without waiting for the despatch interval to lapse.
- (b) *Down Peak Programme*- An intense traffic flow from the upper floors towards main landing will automatically switch on the down peak programme. The cars, when fully loaded at upper floors, travel directly to the main landing and after discharging the passenger, immediately start up to answer further down landing calls. The down landing call which has been by-passed gets a priority over other down calls, which ensures equal service to all floors.
- (c) *Up-down Interfloor Programme*:- A steady traffic between main floor and upper floor, and between floor to floor causes automatic switching on of the Interfloor Programme. Specific cars are assigned to answer specific calls by traffic analyser so that the calls are handled most efficiently. The cars are so well distributed that every call gets equal service with short waiting intervals.

As soon as the number of calls drop to occasional calls only such as at night, the cars get automatically parked in their assigned zones to give personalised service with minimum lift travel. If no calls are registered for some time the motor generator sets are automatically switched off.

- (d) *Night Programme* :- When the traffic ceases to occasional calls only, the supervisory control automatically switches over to Night Programme. All cars remain parked at the main landing with doors closed, but are at all times ready for operation. One of the lifts has its 'Leave first' signal lighted. On pressing of call button at the main landing, the doors of this particular lift open and the passenger can travel with the lift. The same lift also responds to landing calls from above. The moment this car leaves the main landing the 'Leave First' signal is transferred to a second lift. Further passengers entering main lobby will take this second lift. This second lift also responds to landing calls from above if one lift can no longer cope with the demand. After these lifts have answered their calls, the one reaching the main landing last will retain the 'Leave First' signal. Thereby, the service is practically confined to one lift alone and motor generator sets of the remaining lifts remain switched off. If no calls are registered for sometime, the motor generator of the stand by lift also automatically be switched off. The motor generator will start up again, the moment the call is received. The number of lifts going into action is automatically regulated to just so many as are necessary to cope with the occasional traffic surge.

एक किनारे पर तीन से अधिक लिफ्टें अधिष्ठापित होने के मामले में कठिन समय में प्रत्येक दिशा में भारी यातायात से निपटने के लिए दो अतिरिक्त प्रोग्रामों से लिफ्टों का बेहतर उपयोग किया जा सकता है। ये हैं (I) भारीतर "अप" प्रोग्राम (II) भारीतर "डॉउन" प्रोग्राम।

- (i) भारीतर "अप" प्रोग्राम :- यह कारों को ऊपर की दिशा में अधिक रोकने के लिए आवश्यक होगा, जिससे ऊपर की यात्रा के लिए अधिक समय लगेगा। इस उद्देश्य से स्वचालित यातायात विश्लेषक दोनों सिरों (टर्मिनल से स्वतः समन्वित समयान्तराल पर कारों को भेजेगा ताकि कारों के बीच की दूरी समान बनी रहे और यात्रियों की प्रतीक्षा में कम समय लगे (यह प्रोग्राम दोनों दिशाओं के यातायात संभालने के लिए है परन्तु ऊपर की दिशा में, उदाहरणतः सुबह चरम या दोपहर के भोजन के पश्चात अधिक उपयोग के लिए)।
- (ii) भारीतर "डॉउन" प्रोग्राम :- यह कारों को नीचे की दिशा में अधिक रोकने के लिए आवश्यक होगा और प्रेषण समय यातायात विश्लेषक द्वारा तदनुसार समायोजित किया जाएगा।
किसी कार ग्रुप में कोई दोष उत्पन्न हो जाने पर वह कार ग्रुप नियंत्रण से स्वतः वियोजित हो जायेगी इसे ठीक किये जाने तक वियोजित रहेगी।
स्वाचालित प्रेषण प्रणाली फेल होने पर सेवा में किसी व्यवधान से बचने के लिए लिफ्टें सहायक उपायों से कार्य करेंगी।
ऐसी विफलता की जानकारी देने के लिए श्रव्य दृश्य संकेत दिए जाएंगे।
निम्नलिखित के अलावा, लिफ्टों को एकल (सिम्पलैक्स) चयनात्मक सामूहिक प्रचालन के अंतर्गत यथा उद्भूत परिचर प्रचालन के लिए डिजाइन किया जाएगा :
(क) कार की संकेत बत्तियाँ प्रचालनीय होनी चाहिए ताकि परिचर को यह सूचित किया जा सके कि टर्मिनल पर कार का अवतरण कब प्रारम्भ किया जाए और टर्मिनल को कब छोड़ा जाए।
(ख) अवतरण कॉल (आह्वान) बाई पास स्विच और कार प्रत्यावर्तन स्विच और स्विचें प्रभावी तथा भार भारण युक्तियाँ निष्प्रभावी होनी चाहिए।
(ग) ऊपर कॉल सिगनल उस समय प्रदीप्त होगा जब अवतरण से ऊपर की काल परिचर को कार ऊपर के जाने के लिए रजिस्टर हो। सबसे ऊपर की काल उत्तरित होने पर बत्ती बुझ जाएगी तथा परिचर को यह संकेत प्राप्त होगा कि कार चालू किए जाने पर नीचे की ओर जाएगी।

14.0 नियंत्रण उपस्कर

कार का संचालन मशीन कक्ष में अवस्थित नियंत्रक के माध्यम से विद्युत द्वारा नियंत्रित होता है।

14.1 नियंत्रण परिपथ

नियंत्रण परिपथ सुरक्षा प्रचालन के लिए विनिर्धारित लिफ्ट प्रकार के डिजाइन किया जाएगा। कार और अवतरण दरवाजों को पूर्णतः बंद तथा अवतरण दरवाजों को पाशित हो जाने के बाद ही कार को चालू करना संभव होगा। परिपथ में दोष और अतिभार के लिए स्वतंत्र फ्यूज संरक्षण होगा और यह इस प्रकार व्यवस्थित होगा कि भूसंपर्कन दोष या खुला परिपथ असुरक्षित स्थिति न उत्पन्न कर सके। परिपथ को इस प्रकार व्यवस्थित किया जाएगा कि किसी विनिर्धारित अवतरण पर कार को रोकने के लिए या आपात स्विचों या सुरक्षा गियरों के प्रचालन द्वारा संकुचक के सक्रियण के लिए प्रणाली इस पर निर्भर नहीं होगी कि विद्युत पूर्ति या ब्रेक लगाने के लिये किसी विद्युत परिपक्ष को पूरा किया जाए या उसे बनाए रखा जाए। गतिक ब्रेक लगाने और चाल नियंत्रण युक्तियों के लिए यह आवश्यक नहीं है।

14.2 टर्मिनल बोर्ड

बाह्य नियंत्रण परिपथों के लिए सभी तार टर्मिनल बोर्ड तक लाए जाएंगे तथा प्रत्येक तार पर निशान लगाया जाएगा। अनिवार्य रूप से धात्विक/प्लास्टिक पहचान टैग लगाए जाएंगे। टर्मिनल बोर्डों के सभी संयोजन तारों पर उपयुक्त क्लैप या पेंच लगाया जाएगा।

In case where more than 3 lifts installed in a bank, a better utilisation of these lifts can be obtained by two additional programmes to deal with heavier traffic in each direction in difficult time. These are (i) Heavier 'Up' programme (ii) Heavier (DOWN' programme).

- (i) Heavier 'UP' Programme :- This shall require the cars to make more stops in the up direction, necessitating more time for the up travel. For this purpose the automatic traffic analyser shall dispatch cars from both terminal at automatically adjusted time intervals so that the cars are equally spaced, thus reducing passenger waiting interval (this programme caters for the traffic which is likely to be in both directions but predominantly in the up direction e.g. immediately after the morning peak or after lunch).
- (ii) Heavier 'DOWN' Programme :- This shall require the cars to make more stops in the down direction and the despatch times shall be adjusted accordingly by the traffic analyser. If any of the cars in the group develops any defect it shall be automatically disconnected from the group control until it is rectified.

In the event of failure of automatic despatch system the lifts shall function by auxiliary means to avoid any disruption of service.

Audio visual indication shall be provided to bring such failures to notice.

The lifts shall be designed for attendant operation as described under single (simplex) selective collective operation car except as follow:-

- (a) the indicating lights in car shall be operative to inform the attendant when to start loading a car at a terminal and when to leave the terminal.
- (b) Landing call by pass switch and car reversal switch and switches shall be effective and load weighing devices shall be inoperative.
- (c) Call above signal shall be illuminated when ever a call is registered at a landing above the car location indicating to attendant that car is to proceed upwards. When the highest call has been answered the light shall be extinguished indicating to the attendant that when the car is started it will proceed downward.

14.0 Controlling Equipment

The movement of the car shall be electrically controlled by means of a controller located in the machine room.

14.1 Control circuits

The control circuit shall be designed to the type of lift specified for safety operation. It shall not be possible to start the car unless all the car and landing doors are fully closed and landing doors locked. The circuit shall have an independent fuse protection for fault and over loads and be arranged so that earth fault or an open circuit shall not create unsafe condition. The circuit shall be so arranged that for the stoppage of the car at specified landing or for actuation of a contactor by emergency switches or operation of safety gears the system shall not depend upon the completion or maintenance of an electrical circuit to cut off power supply and apply the brakes. This requirement is not applicable to dynamic braking and speed control devices.

14.2 Terminal Boards

All wiring for external control circuits shall be brought to a terminal board with means of identification of each wire. Metallic/ plastic identification tags shall invariably be provided. All connections of wires to terminal boards shall be adequately clamped or screwed.

14.3 सहायक स्विच

14.3.1 आपात विराम स्विच

लिफ्ट के शिखर पर अनुरक्षण कार्मिकों के प्रयोग के लिए एक आपात विराम स्विच प्रदान की जाएगी। विराम (स्टॉप) स्विच मशीन कक्ष में उपलब्ध करायी जायेगी। इन स्विचों / बटनों के प्रचालन से उस विशेष लिफ्ट के लिए रजिस्टर सभी कालें तथा अवतरण कालें रद्द हो जाएंगी।

14.3.2 कार के ऊपर अनुरक्षण स्विच

निरीक्षण और अनुरक्षण के लिए कार के ऊपर अनुरक्षण स्विच प्रदान की जाएगी। नियंत्रण परिपथी इस प्रकार व्यवस्थित की जाएगी कि इस स्विच को प्रचालित करने पर :

(क) कार की चाल निर्धारित चाल से कम (0.85 मी/से० से अधिक नहीं होगी)।

(ख) कार का संचालन बटन पर निरंतर दाब लगाने पर ही संभव होगा। इसे ऐसे स्थान पर लगाया जाएगा जिससे इसे गलती से न प्रचालित किया जा सके।

14.3.3 फायरमैन स्विच

सभी लिफ्टों के लिए भूतल या मुख्य तल पर ऐसी काँच युक्त फायरमैन स्विच प्रदान की जाएगी जिसे तोड़कर स्विच तक पहुँचा जा सके। इस स्विच के प्रचालन से सभी लिफ्टों के सभी कॉल विलग या रद्द हो जाएंगी और यदि लिफ्ट ऊपर जा रही है तो निकटतम अवतरण पर रुक जाएगी। इस अवतरण पर दरवाजा नहीं खुलेगा और लिफ्ट नीचे की ओर चल देगी यदि वे नीचे की ओर चल रही है तो मार्ग में बिना रुके वह सीधे भूतल पर जाएगी।

14.3.4 निरीक्षण सुविधा

निरीक्षण का एक चेंज ओवर स्विच तथा टेस्ट बटन सेट नियंत्रक के लिए प्रदान किए जाएंगे। निरीक्षक की परिवर्तन स्विच के प्रचालन से कार और अवतरण दोनों के बटन अक्रिय हो जाएंगे और परीक्षण उद्देश्यों से नियंत्रक में संगत परीक्षण बटन को दबाकर लिफ्ट को मशीन कक्ष से किसी भी दिशा में चला सकेंगे। परन्तु यह कार के भीतर या कार स्टाप पर आपात शीर्ष स्विचों को प्रभावित नहीं करेगा।

14.3.5 सुरक्षा लाइन सूचक

विनिर्दिष्ट होने पर सरलतापूर्वक दोष की जानकारी प्राप्त करने के लिए लिफ्ट की सुरक्षा लाइन में दोषों की दशा को मानीटर करने के लिए स्थिति सूचक बत्तियाँ प्रदान की जा सकती हैं। सुरक्षा परिपथ सामान्य होने पर ये सूचक प्रकाशित रहेंगे।

नियंत्रक पर प्रत्येक सुरक्षा के लिए एक सूचक प्रदान किया जाएगा। लिफ्ट को प्रचालन क्रम में आगे बढ़ने पर, सूचक के प्रकाशित होने में विफल होने पर सरल दोष अन्वेषण के लिए सुरक्षा लाइन खुले परिपथ पर दृश्य संकेत प्राप्त होगा तथा इसकी अवस्थिति का भी पता चलेगा।

14.4 नियंत्रण तार लगाना (कंट्रोल वायरिंग)

14.4.1 मशीन कक्ष में तार लगाना

विभिन्न अवतरणों के लिए नियंत्रक तथा मुख्य बोर्ड नियंत्रक के बीच की पॉवर तार लगाने का कार्य बड़े गेज के कंड्यूट या नली में किया जाएगा और यह आई.ई. नियम, 1956 तथा विद्युत कार्यों के सी.पी.डब्ल्यू.डी. विनिर्देशों के अनुरूप होगा। तार लगाने समय निम्नलिखित सामान्य सिद्धांतों का पालन किया जाएगा।

(क) (i) डी. सी वाहक नियंत्रण केबिल और ए.सी. वाहक पॉवर केबिल एक ही कंड्यूट या धातु नली में नहीं होने चाहिए और उन्हें आई. ई. नियमों के अनुसार बिछाया जाएगा।

(ii) खोलने योग्य निरीक्षण कवर वाली धातु नली को तरजीह दी जाएगी।

(iii) नियंत्रण केबिल और हर्नेस भी जहाँ तक व्यवहारिक हो अलग-अलग कार्यों के लिए अलग-अलग होंगे और उचित माप वाली धातु नली या एक पृथक कंड्यूट में यथा सिग्नलिंग, पाशन, लैंप संकेतन और सुरक्षाओं के लिए अलग-अलग बिछाए जाएंगे। लिफ्ट अधिष्ठापन कार्यों में विभिन्न दोलताओं के लिये नियंत्रण केबिल आई.ई. नियमों के अनुसार बिछाए जायेंगे।

14.3 **Auxiliary Switches**

14.3.1 **Emergency stop switches:**

On top of the lift car an emergency stop switch shall be provided for use by maintenance personnel. Stop switch shall be provided in the machine room. Operation of these switches/ buttons shall cancel all the registered calls and landing calls for that particular lift.

14.3.2 **Maintenance switch on top of the car**

For purpose of inspection and maintenance, maintenance switch shall be provided on top of the car. The control circuitry shall be so arranged that in the event of the operation of this switch:

- (a) The car speed shall be less than the rated speed not exceeding 0.85 metres /sec.
- (b) The car movement shall be possible only on the application of the continuous pressure on a button. It shall be so mounted to prevent any inadvertent operation.

14.3.3 **Fireman Switch :**

Fireman switch with glass to break for access shall be provided at ground or main floor for all the lifts. The operation of this switch shall isolate/ or cancel all calls to all the lifts and the lifts will stop at the next nearest landing if travelling upward. The doors will not open at this landing and the lifts will start travelling to ground floor. If these were already travelling down, they will go straight to ground floor direct without stopping enroute.

14.3.4 **Inspection facility :**

An Inspector's change over switch and set of test buttons shall be provided in the controller. Operation of the Inspector's change over switch shall make both the car and landing buttons inoperative and permit the lift to be worked in either direction from machine room for test purposes by pressing corresponding test buttons in the controller. It shall not however interfere with the emergency stop switches inside the car or on the top of the car.

14.3.5 **Safety line indicators :**

If specified visual tell tale lights may be provided to monitor the conditions of faults in the safety line of the lift for easier fault finding. These indicators will remain lit when safety circuits are normal.

One indicator shall be provided for each safety on the controller. If any indicators fail to light up as the lift proceeds in its sequence of operation, there shall be visual indication of the safety line open circuit and also its location for easier fault finding.

14.4 **Control Wiring**

14.4.1 **Wiring in machine room :**

Power wiring between the controller and main board controller to various landings shall be done in heavy gauge conduit or metal duct & shall conform to I.E. Rules 1956 and CPWD. Specifications for electrical works. Following general principles shall be followed in wiring :

- (a) (i) control cables carrying DC and power cable carrying AC shall not be run in the same conduit or metal duct and they shall be laid as per I.E. rules.
- (ii) Metal duct with removable inspection cover shall be preferred.
- (iii) In case of control cables also the harness shall be separate as far as feasible for separate functions and laid separately in suitably dimensioned metal duct or in a separate conduit such as the signaling, locking, lamp indication and safeties. Control cables for different voltages in the lift installation works should be laid as per IE. Rules.

(ख) असंयोजित अतिरिक्त तारों का कम से कम 5 प्रतिशत न्यूनतम 5, सभी लाइनों के बाहर उपलब्ध होंगे ताकि मध्य जंक्शन बॉक्स से मशीन कक्ष तक तार हॉर्नेस प्रदान की जा सके।

(ग) नियंत्रक गुरुकार्य लोड ब्रेक से संबंध एक मास्टर विलगन स्विच फ्यूज लगा होगा, जो कि द्रुत संयोजन द्रुत वियोजन टी.पी.एण्ड एन प्रकार का तथा अधिमानतः नियंत्रक कैबिनेट दरवाजे से अंतर्पाशित होगा।

सभी रिले लिफ्ट सेवा के लिए उपयुक्त होनी चाहिए तथा विश्वसनीय प्रचालन के लिए इसमें समुचित संपर्क वाइप लगे होने चाहिए रिले को 80 प्रतिशत से 110 प्रतिशत की वोल्टता पर संतोषजनक ढंग से प्रचालित होनी चाहिए।

मुख्य मोटर संपर्किंग ए.सी.ड्यूटी के लिए उपयुक्त होगा। निविदाकार के लिए यह आवश्यक होगा कि संपर्किंग और रिले के निर्माता (मेक) टाइप उपयोग, मानक, वोल्टता तथा धारा निर्धारण, ड्यूटी वर्ग, किए गए टाइप और नेमी परीक्षण आदि का पूर्ण विवरण प्रस्तुत करे। सफल निविदाकार द्वारा टाइप परीक्षण प्रमाणपत्र और अन्य परीक्षण प्रमाणपत्र भी प्रस्तुत किए जाएंगे।

सभी केबिल उचित आकार के ताँबा चालकों वाले तथा ज्वाल मंदक या पी.वी.सी. रोधित होंगे। अधिधारा प्रवाह पथ में केबिल प्रभरण मोटर का चयन इस प्रकार किया जाएगा कि इसका आकार रक्षक फ्यूजों से मेल खाए और उसके परिणाम स्वरूप मुख्य बोर्ड से मोटर टर्मिनल तक वोल्टता पात 2 प्रतिशत से अधिक न हो। नियंत्रक केबिल, यदि लड़युक्त हों तो, 0.5 वर्ग मिमी० या समकक्ष से कम न हों परन्तु जहाँ अधिक गेज वाले कंड्यूट का अधिष्ठापन कठिन हो कम लंबाई के नम्य कंड्यूट की अनुमति दी जाएगी परन्तु प्रभावी वैद्युत अविच्छिन्नता तथा भू संपर्कन सुनिश्चित किया जाना चाहिए। तार लगाने की मानक नियंत्रण पद्धति के अनुसार सभी केबिलों के किनारों पर फैरूल स्लिप होगी। सभी टर्मिनल ब्लाकों पर उचित निशान लगाए जाएंगे।

14.4.2 अनुगामी केबिल

यदि इस अनुगामी केबिल के सभी चालक इससे होकर गुजरने वाली अधिकतम वोल्टता के लिए रोधित हों तो प्रकाश व्यवस्था नियंत्रण और सिग्नल परिपथ के लिए एक अनुगामी तार लगाने की अनुमति है। केबिल की लम्बाई पर्याप्त होनी चाहिए ताकि कार के चलने के कारण किसी प्रकार के तनाव को रोका जा सके पहचान के लिए सभी केबिलों पर धातु/प्लास्टिक के उचित टैग लगाए जाएंगे।

अनुगामी केबिल कार के ऊपरी जंक्शन बाक्स से यात्रा के मध्य बिंदु के निकट स्थित जंक्शन बाक्स तक जाएगा और इन जंक्शन बाक्सों से चालक विभिन्न स्थानों के लिए जाएगा।

30 मीटर से अधिक लंबाई वाले अनुगामी केबिल इस प्रकार लगाए जाएंगे कि एकल केबिल चालकों पर तनाव न्यूनतम हो जाए और केबिल कार प्रति भार शैफ्ट दीवारों या अन्य उपस्कर से जुड़ने के लिए मुक्त हों।

30 मीटर से अधिक लम्बाई वाले केबिलों पर इस्पात टेक भरक लगे होंगे और वे टेक पर रगड़े बिना सीधे निलंबित हो सकेंगे। 30 मीटर से कम लम्बाई वाले केबिलों पर कोई धातु भरक नहीं होगा और वे पोर्सलेन फिरकी या इसी प्रकार के टेक के चारों ओर केबिल लूप लगाकर निलंबित किए जाएंगे।

कुल क्षमता का 5 प्रतिशत तार जो कि न्यूनतम 5 से कम न हो, विभिन्न कार्यों के बीच समुचित प्रकार से वितरित प्रत्येक जगह अनुगामी केबिल में अप्रयुक्त उपलब्ध होंगे।

14.4.3 भूसंपर्कन (अर्थिंग)

धातु फ्रेम और लिफ्ट नियंत्रक फ्रेम आदि के सभी धातु कार्य दोहरी भूसंपर्कन तारों को भू-छड़ में जोड़कर भूसंपर्कित किए जाते हैं। व्यावहारिक होने पर पाशन की अनुमति दी जा सकती है। घटकों के सभी अन्य एकल धात्विक फ्रेमवर्क लूप भूसंपर्कित किए जाएंगे।

(b) At least 5 percent with a minimum of 5 unconnected spare wires shall be available out of all the lines to be provided in the wiring harness from the midway junction box to the machine room.

(c) There shall be a master isolating switch Fuse associated with the controller heavy duty load break, quick make quick break type TP&N preferably interlocked with controller cabinet door. Isolator handle shall have provision for external locking in off position.

All relays shall be suitable for lift service and shall incorporate adequate contact wipe for reliable operation. Relays shall operate satisfactorily between 80 percent to 110 percent of their voltage.

Main motor contactors shall be suitable for A.C. duty. Tenderer shall be required to furnish full details of make, type, applicable standard, voltage and current rating, duty class, type and routine tests done etc., on contactors and relays. Copies of type test certificates and other test certificates shall also be furnished by the successful tenderer.

All cables shall be with copper conductors and flame retardant or PVC insulated of appropriate size. The cables feeding motor and in heavy current flow paths shall be so selected that the size matches the protecting fuses and will not result in more than 2 percent voltage drop from the main board to the terminals of motor. Control cables shall not be less than 0.5 sq.mm. or equivalent if stranded; where installation of heavy gauge conduits present difficulties, short lengths of flexible conduits will be permitted but effective electrical continuity and earth bonding shall be ensured. Ferrules shall be slipped at the ends of all cables as per standard control wiring practice. All terminal blocks shall be suitably marked.

14.4.2 *Trailing Cables:*

A single trailing cable for lighting control and signal circuit is permitted, if all the conductors of this trailing cable are insulated for maximum voltage running through any one conductor of this cable. The lengths of the cables shall be adequate to prevent any strain due to movement of the car. All cables shall be properly tagged by metallic/plastic tags for identification.

Trailing cables shall run from a junction box on the top of the car to a junction box located in the shaft near mid point of travel and from these junction boxes conductors shall be run to the various locations.

Trailing cables exceeding 30 meters in length shall run so that the strain on individual cable conductors will be reduced to a minimum and the cables are free from contact with the car counter-weight, shaft walls or other equipment.

Trailing cables exceeding 30 meters in length shall have steel supporting fillers and shall be suspended directly by them without rubbing over other supports.

Cables less than 30 meters in length shall have no metallic fillers and shall be suspended by looping cables around supports of porcelain spools type or equivalent.

5 per cent of the total capacity subject to a minimum of 5 wires shall be available unutilised in the trailing cable every where suitably distributed between various functions.

14.4.3 *Earthing :*

Metal frames and all metal work of the lift controller frame etc., shall be earthed with double earth leads taken to the earth bar. Looping shall be permitted if such routing is feasible. All other individual metallic frame work of components etc., shall be loop earthed.

- 14.5 **विविध**
घटकों की साधारण व्यवस्था के अंतर्गत जहाँ तक संभव हो प्रकार्य कार विलगन के सिद्धांत को अपनाया जाएगा। सभी टर्मिनल ब्लाक 650 वी ग्रेड के होने चाहिए।
- 14.6 **नियंत्रक केसिंग**
नियंत्रण यूनिट, जिसमें मुख्य परिपथ वियोजक समायोजनी अतिभार और फेज परावर्तक और फेज विफलता संरक्षक सभी परिपथ एलीमेंट ट्रांसफार्मर, डी. सी. नियंत्रण पूर्ति के लिए रेक्तिफायर, इनवर्टर पॉवर पैक, टर्मिनल ब्लॉक आदि शामिल हैं, कीट रोधी, चादर इस्पात फर्श या आगे या आगे और पीछे, दोनों ओर कब्जा लगे दरवाजों वाले दीवार में लगे कैबिनेट में परिवृत्त होनी चाहिए। नियंत्रक केस के दोनों ओर उचित चेतावनी बोर्ड और खतरा सूचक प्लेटें लगायी जाएंगी। नियंत्रक कैबिनेट के लिए प्रयुक्त चादर इस्पात का गेज 18 से कम नहीं होना चाहिए आवश्यकतानुसार उचित बंधन युक्त होना चाहिए। चार्जर यूनिट के लिए बैटरी मशीन कक्ष में समुचित ढंग से रखी जानी चाहिए। सभी चादर इस्पात कार्य जस्ता प्राइमर के दो लेप के पश्चात ऊपर और नीचे दोनों तरफ से उपयुक्त रंग के संश्लिष्ट इनेमल पेंट से पेंट किए जाने चाहिए।
- 15.0 **लिफ्ट रज्जु प्रतिकरण**
लिफ्ट यात्रा के लिफ्ट रज्जु प्रतिकरण सभी मामलों में 40 मी० से अधिक की लिफ्ट यात्रा के लिए प्रदान किया जाएगा।
- 16.0 **स्वचालित बचाव युक्तियां (ए. आर. डी)**
लिफ्ट कार को निकटतम अवतरण दरवाजों तक लाने के लिए उददिष्ट स्वचालित बचाव युक्तियां (ए.आर.डी) चयनात्मक रूप में प्रयुक्त होती हैं और सामान्यतः अधिक यातायात वाले वाणिज्यिक भवनों के लिए ही सीमित होती हैं। परन्तु बार-बार बिजली फेल होना एक आम बात है इसलिए सार्वजनिक भवनों की सभी लिफ्टों में ए.आर.डी. की व्यवस्था की जानी चाहिए। ए.आर. डी. की निम्नलिखित विशिष्टियां होनी चाहिए :-
- 16.1 उत्थापक के सामान्य प्रचालन के दौरान बिजली फेल हो जाने पर ए.आर.डी. उत्थापक को निकटतम अवतरण तक ले जाना चाहिए।
- 16.2 ए.आर.डी. को मुख्य नियंत्रक में सामान्य विद्युत पूर्ती मॉनीटर करना चाहिए तथा बिजली फेल होने के 10 सैकेंड के भीतर उसे बचाव प्रक्रिया सक्रिय कर देनी चाहिए। इसे उत्थापक को, सामान्य से कम चाल पर, निकटतम तल तक लाना चाहिये। निकटतम तल की ओर जाते समय उत्थापक जोन की पहचान करेगा और रूक जाएगा। उत्थापक के रूक जाने के पश्चात दरवाजे स्वतः खुल जाएंगे और खुले दरवाजे के साथ पार्क हो जाएगा। ए.आर. डी. का प्रचालन पूरा होने के पश्चात सामान्य विद्युत पूर्ती बहाल होते ही उत्थापक स्वतः सामान्य प्रचालन की स्थिति में आ जाएगा।
- 16.3 ए.आर.डी प्रचालन के दौरान सामान्य पूर्ति बहाल हो जाने पर निकटतम अवतरण पर पहुँचने तक तथा दरवाजों के पूर्णतः खुलने तक ए.आर.डी द्वारा प्रचालन जारी रहेगा। उत्थापक को अवतरण पर होने पर यदि सामान्य विद्युत पूर्ति वापस आ जाती है तो यह स्वतः सामान्य विद्युत प्रचालन की स्थिति में आ जाएगा।
- 16.4 ए. आर. डी. प्रचालन के दौरान लिफ्ट की सभी सुरक्षा युक्तियां सक्रिय बनी रहेंगी।
- 16.5 बैटरी की क्षमता इतनी पर्याप्त होनी चाहिए कि एक दिन में कम से कम सात बार ए.आर.डी. प्रचालित हो सके, बशर्ते उपयोग के बीच न्यूनतम अन्तराल 30 मिनट का हो।

14.5 *Miscellaneous*

Principle of segregation function wise shall be accepted as far as possible in the general arrangement of components. All terminal blocks shall be of 650 V grade.

14.6 *Controller casing :*

The controller unit comprising of the main circuit breaker adjustable overload and phase reversal and phase failure protection all the circuit elements transformer, rectifier for D.C. control supply, inverter power pack, terminal blocks etc., shall be enclosed in an insect proof, sheet steel floor or wall mounted cabinet with hinged doors at front or at both front and rear. Proper warning boards and danger plates shall be provided on both sides of the controller casing. Sheet steel used for controller cabinet shall not be less than 18 gauge and shall be properly braced where necessary. Suitable gland plate shall be provided for cable entry. The battery for the charger unit shall be suitably placed in the machine room.

All sheet steel work shall be painted with two coats of synthetic enamel paint of suitable shade both inside and outside over two coats of zinc primer.

15.0 **Lift Rope Compensation**

The lift rope compensation for lift travel shall be provided for lift travels beyond 40m in all cases.

16.0 **Automatic Rescue Devices (ARD)**

The Automatic Rescue Devices (ARD) meant for the purpose of bringing the lift car to the nearest landing doors, are being used selectively and is generally restricted to commercial buildings having heavy traffic. However, frequent power failures being the common phenomenon, the provision of ARD shall be made in all the lifts in public buildings. The ARD shall have the following specifications:

16.1 ARD should move the elevator to the nearest landing in case of power failure during normal operation of elevator.

16.2 ARD should monitor the normal power supply in the main controller and shall activate rescue operation within 10 seconds of normal power supply failure. It should bring the elevator to the nearest floor at a slower speed than the normal run. While proceeding to the nearest floor the elevator will detect the zone and stop. After the elevator has stopped, it automatically opens the doors and parks with door open. After the operation is completed by the ARD the elevator is automatically switched over to normal operation as soon as normal power supply resumes.

16.3 In case the normal supply resumes during ARD in operation the elevator will continue to run in ARD mode until it reaches the nearest landing and the doors are fully opened. If normal power supply resumes when the elevator is at the landing, it will automatically be switched to normal power operation.

16.4 All the lift safeties shall remain active during the ARD mode of operation.

16.5 The battery capacity should be adequate so as to operate the ARD at least seven times a day provided the duration between usage is at least 30 minutes.

खण्ड- II
द्रव चालित लिफ्टें

संख्या से संबंधित कृपया तुरंत कार्यवाही करें।

SECTION -II

HYDRAULIC LIFTS

द्रव चालित लिफ्टें

एक ऐसी लिफ्ट जिसमें विद्युत चालित पंप से पॉवर प्राप्त करके कार पर एक या अधिक जैकों को प्रत्यक्ष या अप्रत्यक्ष रूप से चलाने के लिए चालन द्रव संप्रेषित किया जाता है। ये सामान्यतः उन भवनों में जहाँ तलों की संख्या 4-5 से अधिक नहीं है तथा मशीन कक्ष लिफ्ट शाफ्ट के ऊपर नहीं है, उपलब्ध कराई जायेगी।

1.0 द्रव चालित लिफ्टों के प्रकार

1.1 प्रत्यक्ष कार्यकारी प्रकार की द्रव चालित लिफ्टें (चित्र 1)

द्रव चालित रैम लिफ्ट कार या कार फ्रेम से सीधे संयोजित होता है।

1.2 अप्रत्यक्ष कार्यकारी द्रव चालित लिफ्टें (चित्र 2)

द्रवचालित सिलिंडर कार या कार फ्रेम के निकट निलंबन उपायों (रज्जुओं) द्वारा आरोपित होता है।

2.0 शब्दावली

2.1 जैक

सिलिंडर और रैम प्लंजर या पिस्टन का सम्मिलित रूप है जो द्रव चालित सक्रियण इकाई बनाता है।

2.2 एकल - कार्यकारी जैक

एक ऐसा जैक जिसमें एक दिशा में प्रतिस्थापन द्रव सक्रियता द्वारा तथा दूसरी दिशा में गुरुत्व द्वारा होता है।

2.3 कार - फ्रेम या कार-स्लिंग

कार को वहन करने वाला निलंबन द्वारा संयोजित धातु फ्रेमवर्क (ढांचा) कार फ्रेम कार अहाते का अभिभाज्य भाग हो सकता है।

2.4 पूर्ण भार दाब

कार का निर्धारित भार पर तथा उच्चतम अवतरण स्तर पर परीक्षण करते समय जैक से सीधे जुड़ी पाइपों पर पड़ने वाला स्थैतिक दाब

2.5 अवरुद्धक वाल्व

एक ऐसा हस्तप्रचालित द्विदिशी वाल्व जो किसी दिशा में प्रवाह की अनुमति दे सकता है या इसे रोक सकता है।

2.6 दाब मोचन वाल्व

एक ऐसा वाल्व जो द्रव को बाहर निकालकर दाब को पूर्व निर्धारित मान तक सीमित रखता है।

2.7 अथोदिक वाल्व

कार अवरोहण को नियंत्रित करने के लिए द्रवीय परिपथ का विद्युतीय नियंत्रित वाल्व।

HYDRAULIC LIFTS

सभी सामग्री का प्रयोग

के समान ही प्रकार की विभिन्न के स्थानों पर उपलब्ध होगा। सभी दर्जित

1

A lift in which power is derived from an electrically driven pump transmitting hydraulic fluid to one or more jacks acting directly or indirectly on the car. These shall generally be provided in the buildings where number of floors do not exceed 4 to 5 and machine room is not available on the top of the lift shaft.

1.0 Type of Hydraulic Lifts

1.1 *Direct Acting Type Hydraulic Lifts (Fig.1)*

The hydraulic ram is directly attached to the lift car or the carframe.

1.2 *Indirect Acting Hydraulic Lift (Fig.2)*

The hydraulic cylinder is mounted in the lift shaft adjacent to the car or the car-frame by suspension means (ropes).

2.0 Terminology

2.1 *Jack*

A combination of a cylinder and a ram (or plunger or piston) forming a hydraulic actuating unit.

2.2 *Single-Acting Jack*

Jack in which displacement in one direction is by fluid action and in the other by gravity.

2.3 *Car-Frame or Car Sling*

The metal framework carrying the car connected to the means of suspension. The car-frame may be integral with the car enclosure.

2.4 *Full Load Pressure*

Static pressure exerted on the piping directly connected to the jack, the car with rated load being at test at the highest landing level.

2.5 *Shut-Off Valve*

A manually operated two-way valve which can permit or prevent flow in either direction.

2.6 *Pressure Relief Valve*

A valve which limits the pressure to a pre-determined value by exhausting fluid.

2.7 *Down Direction Valve*

Electrically controlled valve in hydraulic circuit for controlling the descent of the car.

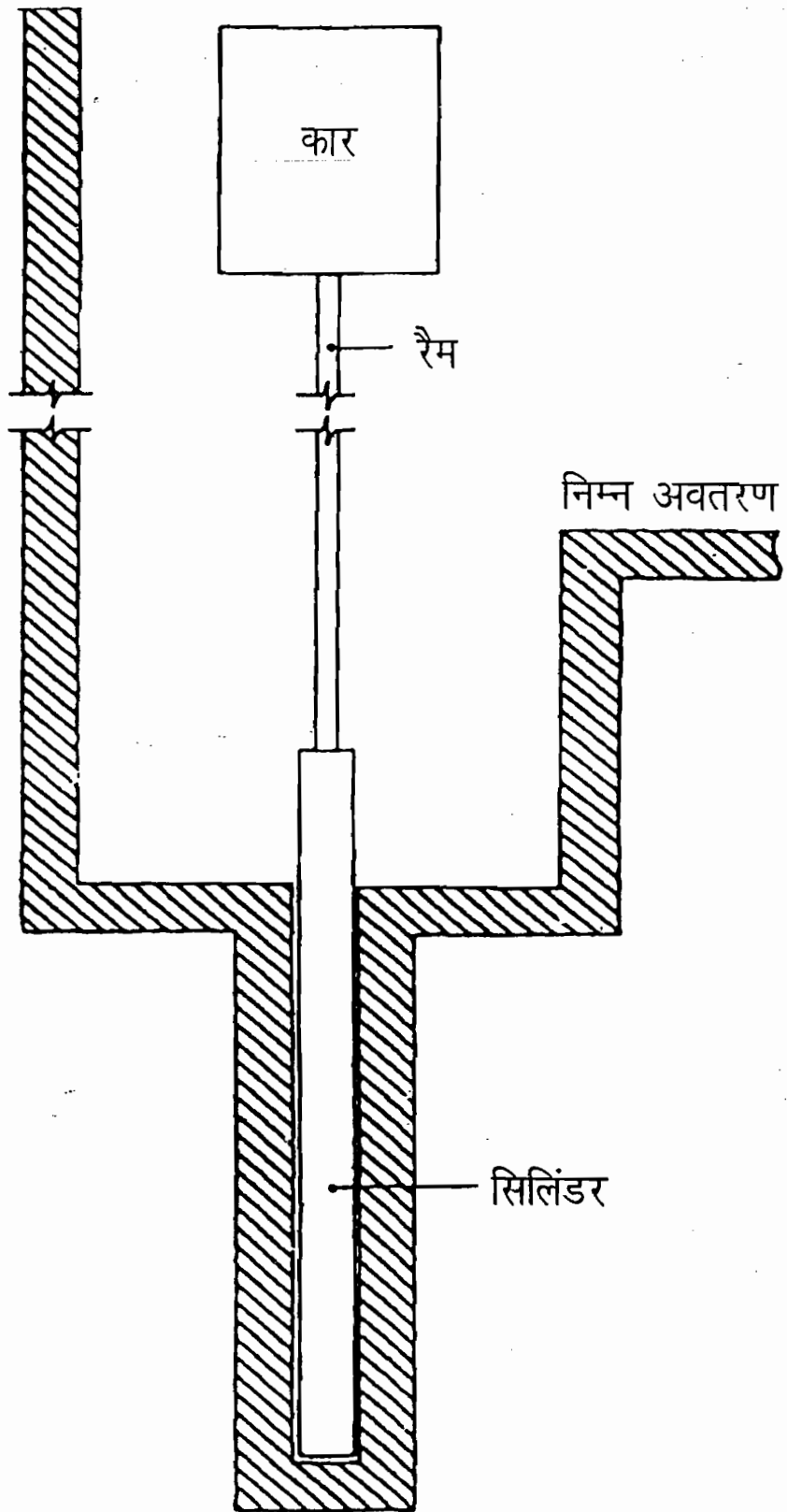

चित्र-1
प्रत्यक्ष कार्यकारी प्रकार की द्रव चालित लिफ्ट

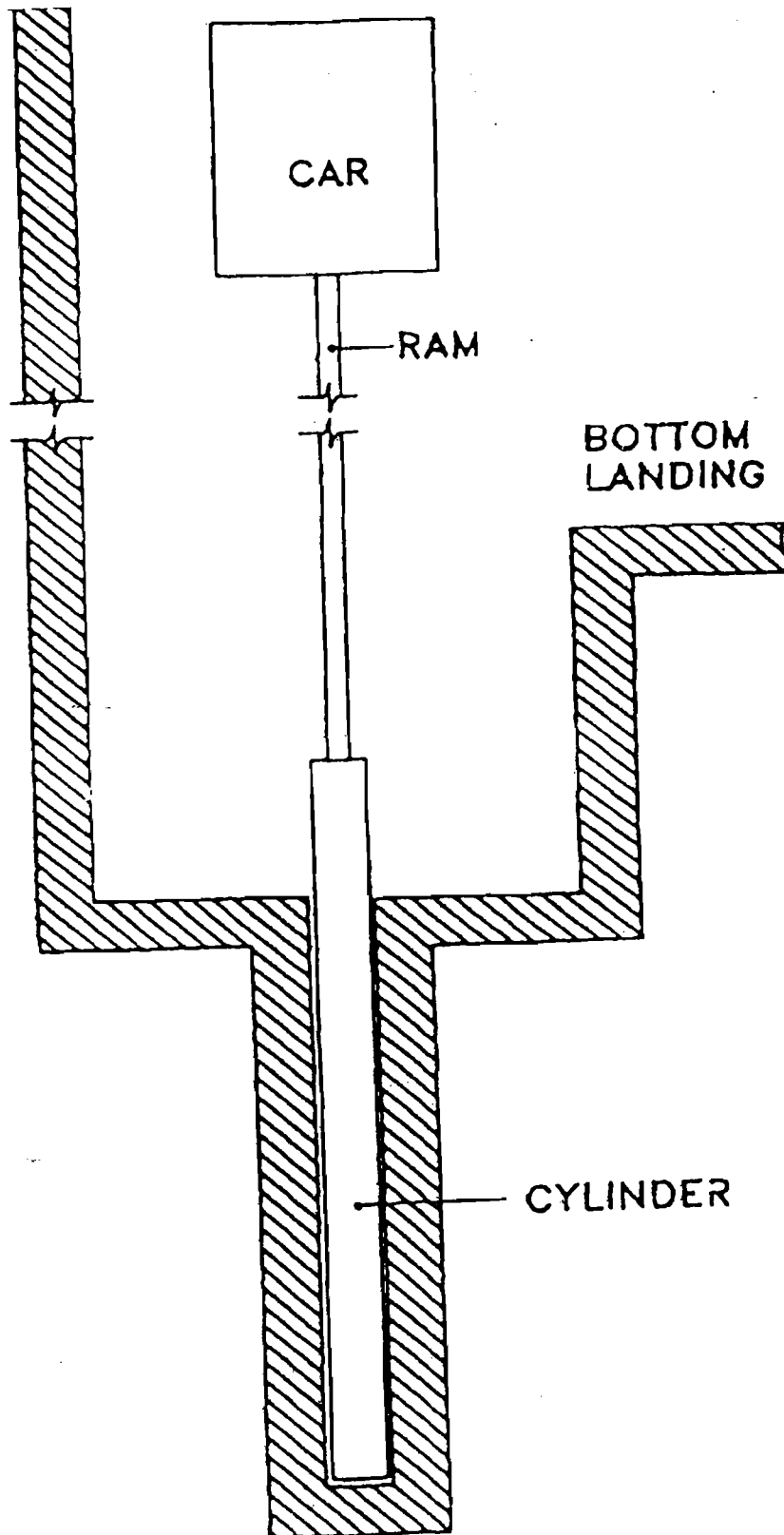
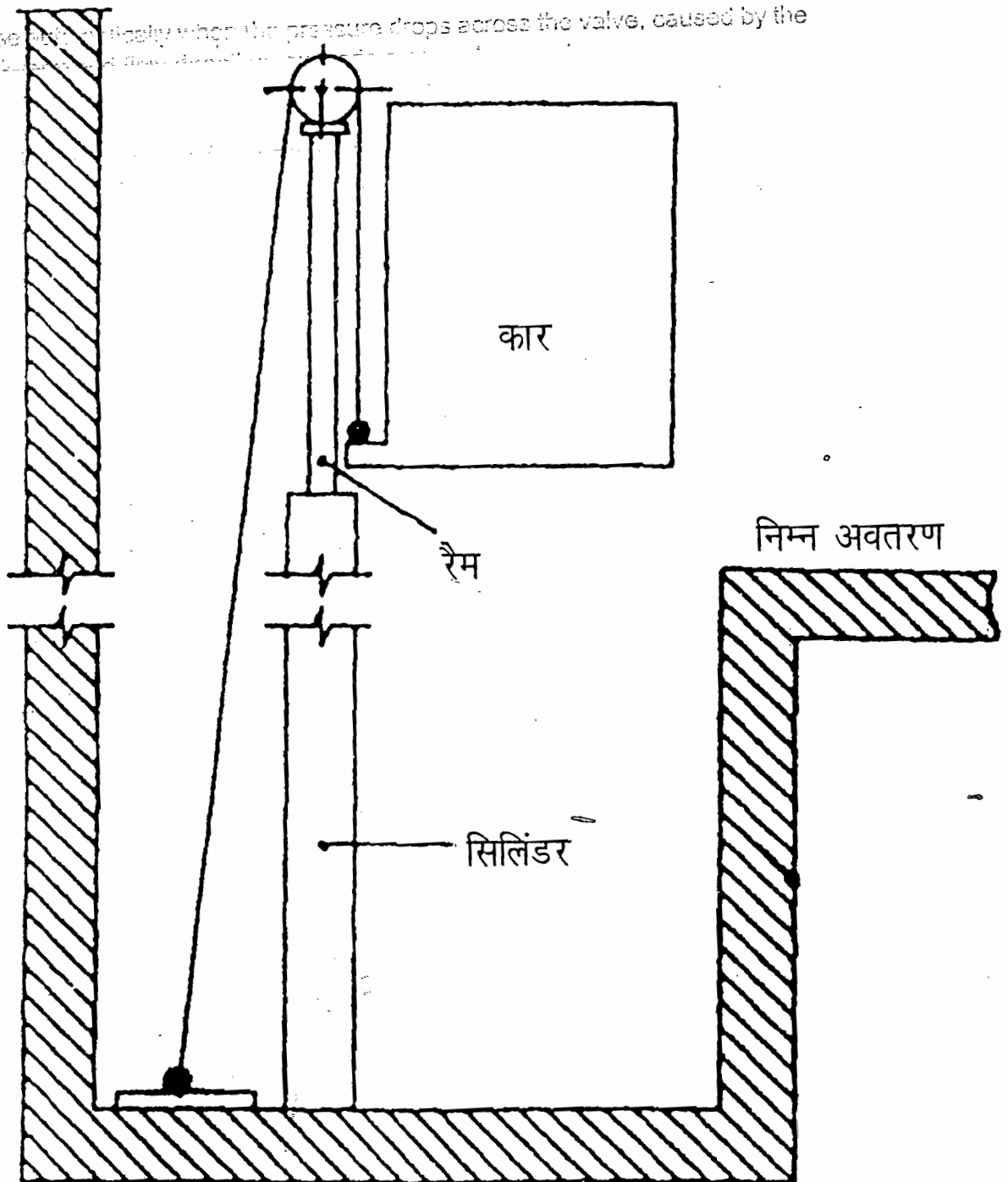

Fig-1
DIRECT ACTING TYPE HYDRAULIC LIFT

valve designed in close proximity to the valve, caused by the pressure drops across the valve, caused by the



चित्र-2
अप्रत्यक्ष कार्यकारी प्रकार की द्रव चालित लिफ्ट

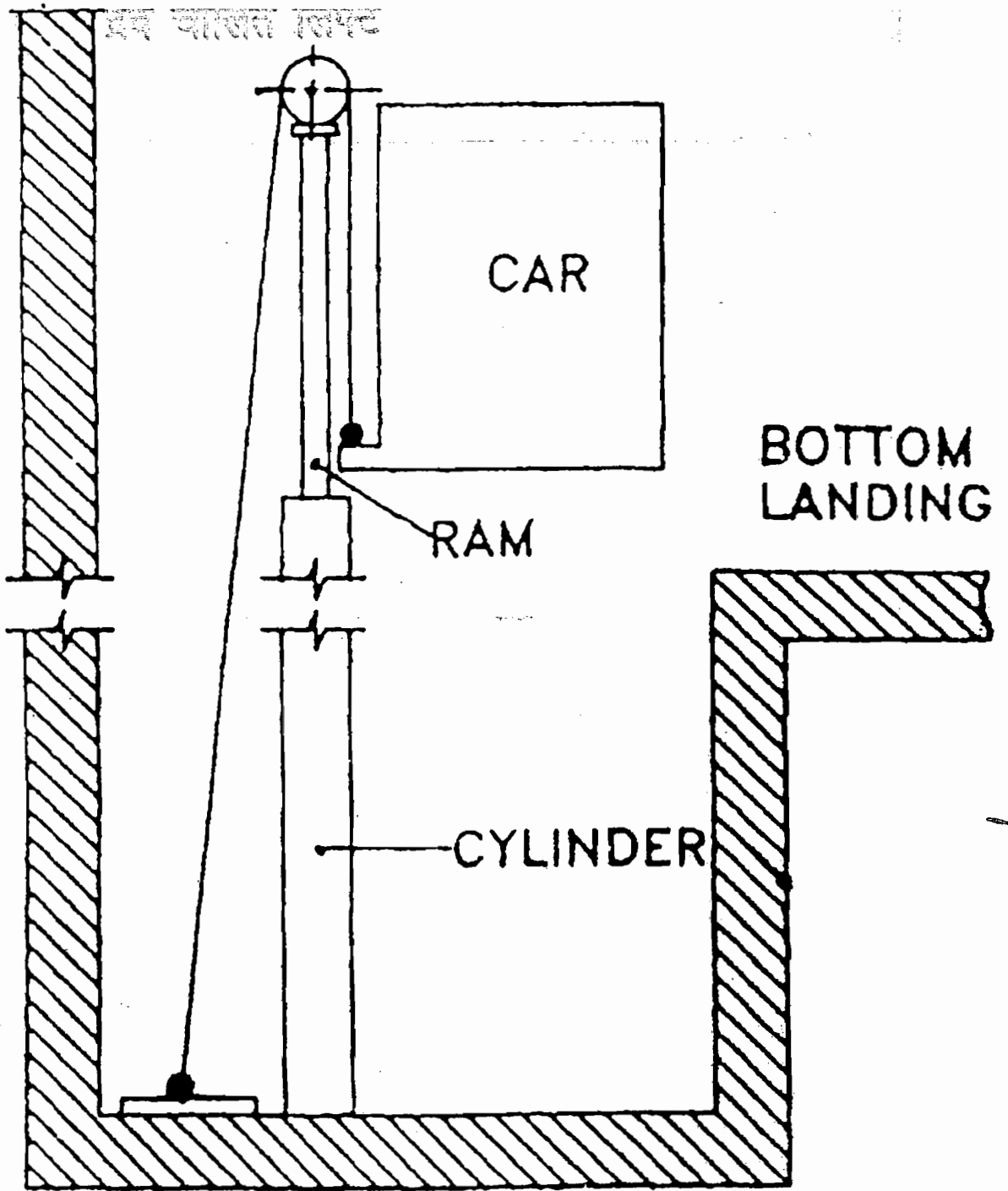

Fig-2.
INDIRECT ACTING TYPE HYDRAULIC LIFT

2.8 विदरण वाल्व

एक ऐसा डिजाइन किया हुआ वाल्व जो पूर्व निर्धारित प्रवाह की दिशा में प्रवाह में पूर्व निर्धारित सीमा से अधिक वृद्धि के कारण वाल्व पर दाब कम होने पर स्वतः बंद हो जाता है। (Valve or down direction valve) shall be

2.9 विद्युतीय विसर्पण रोधी प्रणाली

विसर्पण के खतरे से बचने के लिए एक सम्मिलित सावधानी प्रणाली ।

3.0 द्रव चालित लिफ्टों के निर्माण उपस्कर

3.1 प्रत्येक द्रव चालित लिफ्ट और उसके भाग पर्याप्त रेटिंग, निर्माण, और पर्याप्त यांत्रिक सामर्थ्य वाले मजबूत पदार्थ के बने होंगे और खतरे से बचने के लिए इसे अच्छी प्रकार अधिष्ठापित, संरक्षित, कार्यकृत और अनुरक्षित किया जाएगा ।

3.2 द्रव चालित लिफ्टों में प्रयुक्त सभी सामग्रियाँ नवीनतम भारत मानकों के अनुरूप जहाँ भी लागू हो, होनी चाहिएं ।

4.0 मशीन, जैक और अन्य द्रवीय उपस्कर

4.1 सामान्य प्रावधान

प्रत्येक लिफ्ट की कम से कम एक अपनी मशीन होगी। चालन की निम्नलिखित दो विधियाँ स्वीकार्य हैं :

- (क) प्रत्यक्ष कार्यकारी, और
- (ख) अप्रत्यक्ष कार्यकारी

4.2 जैक

4.2.1 जैक के सुरक्षा गुणांक की गणना

- (क) दाब की गणना - जैक को इस प्रकार डिजाइन किया जाएगा कि 2.3 गुने पूर्ण भार दाब के बराबर दाब से उत्पन्न बलों के अधीन उल्लिखित रोध प्रतिबल का कम से कम 1.7 सुरक्षा गुणांत सुनिश्चित किया जा सके।
- (ख) व्याकुंचन(बकलिंग) की गणना - जैक को इस प्रकार डिजाइन किया जाएगा कि संपीडक भार के अधीन, इसकी पूर्णतः विस्तारित दशा में तथा पूर्ण भार दाब के 1.4 गुना भार दाब से उत्पन्न बलों के अधीन व्याकुंचन के विरुद्ध कम से कम दो सुरक्षा गुणांक सुनिश्चित किया जा सके ।
- (ग) तनन प्रतिबल की गणना - जैक को इस प्रकार डिजाइन किया जाएगा कि 1.4 गुणा भार दाब से उत्पन्न बलों के अधीन उल्लिखित रोध प्रतिबल का कम से कम दो सुरक्षा गुणांक सुनिश्चित किया जा सके।

4.2.2 कार/रैम (सिलिंडर) संयोजन

- (क) प्रत्यक्ष कार्यकारी लिफ्ट - कार और रैम सिलिंडर के बीच का जोड़ नम्य होना चाहिए और इस प्रकार बनाया जाना चाहिए कि वह रैम (सिलिंडर) के भार और अतिरिक्त गतिज बलों को आलम्ब दे सके। संयोजन के तरीकों को सुरक्षित किया जाना चाहिए।
- (ख) अप्रत्यक्ष कार्यकारी लिफ्ट - रैम का हैड (शीर्ष) निर्देशित होगा। रैम हैड निर्देशन प्रणाली का कोई भी हिस्सा कार अन्तस्छद के उर्ध्वाधर प्रक्षेप में शामिल नहीं होगा।

4.3 नल तंत्र (पाइपिंग)

4.3.1 सामान्य

नलतंत्र और फिटिंग्स, यथा- लिफ्ट द्रव चालन प्रणाली के सभी घटक, जो दाब से प्रभावित हों (संयोजन वाल्व आदि)

- (क) प्रयुक्त द्रव के लिए उपयुक्त होने चाहिएं।
- (ख) इस प्रकार डिजाइन और अधिष्ठापित किए जाने चाहिएं ताकि उनके लगाने, तनाव या कंपन से कोई असामान्य प्रतिबल उत्पन्न न हो।
- (ग) क्षति होने से रक्षित हों, विशेष कर यांत्रिक क्षेत्र में।

2.8 **Rupture Valve**

A valve designed to close automatically when the pressure drops across the valve, caused by the increased flow in a predetermined flow direction, exceeds a pre-set amount.

2.9 **Electrical Anti-creep System**

A combination of precautions against the danger of creeping.

3.0 **Construction Requirements of Hydraulic Lifts**

3.1 Every hydraulic lift and part thereof shall be of sound material of sufficient rating and construction and sufficient mechanical strength for the purpose for which it is intended and shall be installed, protected, worked and maintained in such a manner so as to prevent danger.

3.2 All materials used in hydraulic lifts shall conform to the latest Indian Standards, wherever applicable.

4.0 **Machine, Jack and Other Hydraulic Equipment**

4.1 **General Provisions**

Each lift shall have at least one machine of its own. The following two methods of drive are permissible:

- (a) Direct acting, and
- (b) Indirect acting

4.2 **Jack**

4.2.1 **Calculation of Factor of Safety of Jack**

- (a) Pressure calculations – The jack shall be designed such that, under the forces resulting from a pressure equal to 2.3 times the full load pressure; a safety factor of at least 1.7 referred to the proof stress is assured.
- (b) Buckling calculations - Jacks under compressive loads shall be designed such that, in their fully extended position, and under the forces resulting from a pressure equal to 1.4 times the full load pressure, a safety factor of at least two against buckling is assured.
- (c) Tensile stress calculations – Jacks under tensile loads shall be designed such that, under the forces resulting from a pressure equal to 1.4 times full load pressure, a safety factor of at least 2 referred to the proof stress is assured.

4.2.2 **Connection Car/Ram (Cylinder)**

- (a) Direct-acting lift- The connection between the car and the ram (cylinder) shall be flexible and shall be constructed as to support the weight of the ram (cylinder) and the additional dynamic forces. The connection means shall be secured.
- (b) Indirect-acting lifts- The head of the ram (cylinder) shall be guided. No parts of the ram head guiding system shall be incorporated within the vertical projection of the car roof.

4.3 **Piping**

4.3.1 **General**

Piping and fittings which are subject to pressure (connections, valves, etc.) as in general all components of a lift hydraulic system shall :

- (a) Be appropriate to the hydraulic fluid used.
- (b) Be designed and installed in such a way to avoid any abnormal stress due to fixing, tension or vibration.
- (c) Be protected against damage, in particular of mechanical origin.

4.3.2 दृढ़ पाइपें

दृढ़ पाइपें तथा सिलिंडर और अनिवर्ती वाल्व या नीचे की दिशा वाले वाल्व (वाल्वों) के बीच की फिटिंग्स इस प्रकार डिजाइन की जानी चाहिए कि 2:3 गुणा पूर्ण भार दाब के बराबर दाब के परिणाम स्वरूप उत्पन्न होने वाले बलों के अधीन उल्लिखित रोध प्रतिबल से कम से कम 1.7 सुरक्षा गुणांक सुनिश्चित किया जा सके।

4.3.3 नम्य होज

सिलिंडर और अनिवर्ती वाल्व या नीचे की दिशा वाले वाल्व के बीच की नम्य होज -

- (क) का चयन पूर्ण भार दाब या प्रस्फोटन दाब पर कम से कम 8 सुरक्षा गुणांक के लिए किया जाना चाहिए; और
- (ख) बिना किसी क्षति के पूर्ण भार दाब का पांच गुना दाब सहन कर सके। यह परीक्षण होज के विनिर्माता द्वारा किया जाएगा। नम्य होज पर निम्न प्रकार से स्पष्ट निशान लगाए जाने चाहिए :
 - (क) विनिर्माता का नाम या ट्रेड मार्क
 - (ख) परीक्षण दाब और
 - (ग) परीक्षण की तारीख

4.4 द्रवीय नियंत्रण एवं सुरक्षा युक्तियां

4.4.1 अवरुद्धक वाल्व

एक अवरुद्धक वाल्व उपलब्ध कराया जाएगा और यह मशीन कक्ष में अवस्थित होगा। यह उस परिपथ में स्थापित किया जाएगा जो अनिवर्ती वाल्व और अधोदिक वाल्व से सिलिंडर को जोड़ता है।

4.4.2 अनिवर्ती वाल्व

एक ऐसा अनिवर्ती वाल्व उपलब्ध कराया जाएगा जो पूर्ण दाब निम्नतम प्रचालन दाब से नीचे गिर जाने पर किसी बिंदु पर लिफ्ट कार को निर्धारित भार के साथ रोकने में समर्थ हो। अनिवर्ती वाल्व को पंप और अवरुद्धक वाल्व के बीच वाले परिपथ में स्थापित किया जाएगा।

4.4.3 दाब मोचन वाल्व

एक दाब मोचन वाल्व उपलब्ध कराया जाएगा और इसे पूर्ण भार दाब के 1.4 गुना दाब सीमा तक के लिए समायोजित किया जाएगा। इसे पंप और अनिवर्ती वाल्व के बीच परिपथ में संयोजित किया जाएगा।

4.4.4 अधोदिक वाल्व - अधोदिक वाल्वों को बिजली से खुला रखा जाएगा। इनका बंद किया जाना जैक के द्रवीय दाब द्वारा और कम से कम प्रतिवाल्ब एक निर्देशित संपीडन स्प्रिंग द्वारा प्रभावित होगा।

4.4.5 फिल्टर

टंकी और पंप के बीच के परिपथ में और अवरुद्धक वाल्व और अधोदिक वाल्व के बीच वाले परिपथ में फिल्टर या इसी प्रकार की युक्तियां अधिष्ठापित की जाएंगी। अवरुद्धक वाल्व और अधोदिक वाल्व के बीच का फिल्टर या समरूप युक्ति निरीक्षण और अनुरक्षण के लिए अभिगम्य होनी चाहिए।

4.5 दाब की जाँच करना

एक दाब गेज उपलब्ध कराया जाएगा। इसे अनिवर्ती वाल्व या अधोदिक वाल्व और अवरुद्धक वाल्व के बीच में संयोजित किया जाएगा। यह संयोजन M 20 x 1.5 या G 1/2 इंच की आंतरिक चूड़ी द्वारा किया जाएगा।

4.3.2 *Rigid Pipes*

Rigid pipes and fittings between cylinder and non-return valve or down direction valve(s) shall be designed such that, under the forces resulting from pressure equal to 2.3 times the full load pressure, a safety factor of at least 1.7 referred to the proof stress is assured.

4.3.3 *Flexible Hoses*

The flexible hose between cylinder and non-return valve or down direction valve shall:

- (a) Be selected with a safety factor of at least 8 relating full load pressure and bursting pressure; and
- (b) Withstand without damage a pressure of five times full load pressure, this test to be carried out by the manufacturer of the hose assembly.

The flexible hose shall be marked in an indelible manner with:

- (a) the name of the manufacturer or the trade mark,
- (b) the test pressure, and
- (c) the date of the test.

4.4 *Hydraulic Control and Safety Devices*

4.4.1 *Shut-Off Valve*

A shut-off valve shall be provided, and shall be located in the machine room. It shall be installed in the circuit which connects the cylinder to the non-return valve and the down direction valve.

4.4.2 *Non-return Valve*

A non-return valve shall be provided and shall be capable of holding the lift car with the rated load at any point when the supply pressure drops below the minimum operating pressure. Non-return valve shall be installed in the circuit between the pump and the shut-off valve.

4.4.3 *Pressure Relief Valve*

A pressure relief valve shall be provided and shall be adjusted to limit the pressure to 1.4 times the full load pressure. It shall be connected to the circuit between the pump and the non-return valve. The hydraulic fluid shall be returned to the tank.

4.4.4 *Down Direction Valve*

Down direction valves shall be held open electrically. Their closing shall be affected by the hydraulic pressure from the jack and by at least one guided compression spring per valve.

4.4.5 *Filters*

In the circuit between the tank and the pump and in the circuit between the shut-off valve and the down direction valve filters or similar devices shall be installed. The filter or similar device between the shut-off valve and the down direction valve shall be accessible for inspection and maintenance.

4.5 *Checking the Pressure*

A pressure gauge shall be provided. It shall be connected between the non-return valve or the down direction valve and the shut-off valve. The connection shall be provided with an internal thread of either M20x1.5 or G ½ inch.

4.6

टंकी में द्रव का स्तर :

टंकी में द्रवचालन द्रव के स्तर की जाँच करना सरल होगा।

4.7

चाल :

निर्धारित चाल 1.0 एम पी एस से अधिक नहीं होनी चाहिए। खाली कार की ऊपर की ओर चाल निर्धारित उर्ध्वमुखी चाल से 8 प्रतिशत से अधिक नहीं होनी चाहिए और निर्धारित भार के साथ कार की नीचे की ओर चाल निर्धारित अधोमुखी चाल से 8 प्रतिशत से अधिक नहीं होनी चाहिए, प्रत्येक मामले में यह द्रवचालन द्रव के सामान्य प्रचालन ताप से संबंधित है। ऊपर की दिशा में यात्रा के लिए यह माना जाता है कि पूर्ति इसकी निर्धारित आवृत्ति पर है और मोटर वोल्टता उपस्कर की निर्धारित वोल्टता के बराबर है।

4.8

आपात हस्त प्रचालन

4.8.1

कार को नीचे की ओर चलाना

लिफ्ट को मशीन कक्ष में अवस्थित हस्त प्रचालित वाल्व को प्रचालित करके कार को नीचले तल तक बिजली फेल हो जाने पर भी, लाया जा सकेगा ताकि यात्री कार से बाहर निकल सकें। कार की चाल 0.3 मी./से. से अधिक नहीं होनी चाहिए।

4.8.2

कार को ऊपर की ओर चलाना

सुरक्षा गियर लगी सभी कारों में, कार को ऊपर की दिशा में ले जाने के लिए स्थायी तौर पर एक हैंड पंप अधिष्ठापित किया जाएगा। इसे अनिवर्ती वाल्व या अधोदिक वाल्व और अवरोद्धक वाल्व के बीच में संयोजित किया जाएगा।

4.9

मोटर चालन काल सीमक (रन टाइम लिमिटर)

एक मोटर चालन काल सीमक उपलब्ध कराया जाएगा। यह युक्ति मोटर को बंद कर देगी और निर्धारित भार के साथ ऊपर की ओर पूरी यात्रा के लिए अपेक्षित से अधिक समय, धन अधिकतम 60 सेकेन्ड, तक जब तक यह अर्जित बना रहता है इसे बंद रखेगी। सामान्य सेवा के लिए वापसी हाथ से पुनः सेट करने बाद ही सम्भव होगी। पूर्ति वियोजन के पश्चात् बिजली बहाल करने पर रूकी हुई स्थिति में मशीन का अनुरक्षण अनिवार्य नहीं है।

4.10

द्रवचालित (हाइड्रोलिक) तरल का अतितापन से संरक्षण

एक ताप संसूचक युक्ति उपलब्ध करायी जाएगी यह युक्ति मशीन को बंद कर देगी और इसे उस समय तक बंद रखेगी जब तक द्रवचालित तरल का ताप विनिर्माता द्वारा निर्धारित प्री-सेट मान से कम न हो जाए।

5.0

विभीय उपेक्ष्य त्रुटियां

5.1

द्रवचालित लिफ्ट के लिए शिरोपरि विभाएं और गर्त गहराई क्रमशः 3450 मिमी० और 1100 मिमी० से कम नहीं होनी चाहिए।

6.0

मशीन कक्ष

मशीन और इससे संबंधित उपस्कर उचित अहाता वाले विशेष कक्ष में रखे जाएंगे। मशीन कक्ष निष्कासन पंखे से उचित प्रकार से संवातित होंगे तथा उत्पन्न ऊष्मा के प्रभावी क्षय के लिए आर-पार (क्रास) होंगे। उपयुक्त क्षमता वाली टी.पी. एण्ड एन स्विच में त्रिकला, 50 सी / एस, 415 वोल्ट की पूर्ति की जाएगी। आवश्यक होने पर आगे वितरण संपर्कित्र द्वारा किया जाएगा।

6.1

मशीन कक्ष गर्त या किसी अवतरण से सटा हुआ हो सकता है परन्तु किसी भी दशा में पंप इकाई और सिलिंडर अंतर्गम के बीच की दूरी 20 मी० से अधिक नहीं होगी।

4.6 **Fluid Level in the Tank**

It shall be easy to check the level of the hydraulic fluid in the tank.

4.7 **Speed**

The rated speed shall not be greater than 1.0 mps. The speed of the empty car upwards shall not exceed the rated upward speed by more than 8 percent and the speed of the car with rated load downwards shall not exceed the rated downward speed by more than 8 percent, in each case this relates to the normal operating temperature of the hydraulic fluid. For a journey in the upward direction it is supposed that the supply is at its rated frequency and the motor voltage is equal to the rated voltage of the equipment.

4.8 **Manual Emergency Operation**

4.8.1 **Moving the Car Downwards**

The lift shall be operated with a manually operated valve located in the machine room to allow the car, even in the case of power failure, to be lowered to a level where the passengers can leave the car. The speed of the car shall not exceed 0.3 m/s.

4.8.2 **Moving the Car Upwards**

A hand pump which causes the car to move in the upward direction shall be permanently installed for every lift whose car is fitted with a safety gear. It shall be connected to the circuit between the non-return valve or down direction valve and the shut-off valve.

4.9 **Motor Run Time Limiter**

A motor run time limiter shall be provided. This device shall stop the motor and keep it stopped when it remains energized longer than the time required for the full travel upwards with rated load, plus a maximum of 60 sec. The return to normal service shall only be possible by manual resetting. On restoration of the power after a supply disconnection, maintenance of the machine in the stopped position is not necessary.

4.10 **Protection Against Overheating of the Hydraulic Fluid**

A temperature detecting device shall be provided. This device shall stop the machine and keep it stopped as long as the temperature of the hydraulic fluid exceeds a pre-set value prescribed by the manufacturer.

5.0 **Dimensional Tolerances**

5.1 The overhead dimensions and pit depth for hydraulic lifts shall be not less than 3450 mm and 1100 mm respectively.

6.0 **Machine Rooms**

The machine and its associated equipment shall be kept in a special room with proper enclosure. Machine rooms shall be properly ventilated with exhaust fan and shall have cross ventilation to effectively dissipate the heat generated. Three phase, 50 c/s, 415 V supply shall be provided in a suitable capacity TP&N switch. Further distribution if required shall be done by the contractor.

6.1 The machine room may be located adjacent to the pit or any landing but in no case shall be distance between the pump unit and cylinder inlets exceed 20m.

- 6.2 मशीन कक्ष की विभाएं इतनी पर्याप्त होनी चाहिए कि सेवाई कार्मिक सभी घटकों तक, विशेषकर बिजली के उपस्कर तक, सरलता पूर्वक और सुरक्षित ढंग से पहुंच सकें। विशेषतः निम्नलिखित प्रदान किए जाएंगे।
- (क) पैनेलों और कैबिनेटों के सामने साफ क्षैतिज क्षेत्र। इस क्षेत्र को निम्नानुसार परिभाषित किया गया है:
गइराई : अहातों के बाह्य पृष्ठ (अर्थात् सर्फेस) से मापी गयी गइराई कम से कम 0.7 मी.। बाहर निकल रहे नियंत्रणों (हथ्ये आदि) के सामने दूरी की 0.6 मी० तक कम किया जा सकता है,
चौड़ाई : निम्नलिखित का बढतर मान: 0.5 मी० या कैबिनेट या पैनेल की पूरी चौड़ाई।
- (ख) सचल पुर्जों की सेवाई और निरिक्षण और आवश्यक होने पर हस्त आपात प्रचालन के लिए आवश्यक बिंदुओं पर कम से कम 0.5 मी० X 0.6 मी० का स्पष्ट क्षैतिज क्षेत्र।
- (ग) इन स्पष्ट जगहों के लिए अभिगम मार्ग जिसकी चौड़ाई 0.5 मी० से कम न हो। उन क्षेत्रों में जहाँ कोई सचल भाग न हो इस मान को घटाकर 0.4 मी० किया जा सकता है।
- 6.3 मशीन कक्ष फर्श तेल प्रतिरोधक, आग मंदक और प्रतिधिसटन पदार्थ का बना होना चाहिए।
- 7.0 **गाइड रेल, गाइड शू और बफर**
गाइड रेल, गाइड शू और बफर सामान्यतः आई एस 14665 (भाग 4 धारा 1 और 2) के अनुरूप होंगे तथा इन पर खंड I अध्याय IV के पैरा 5.0, 10.0 और 12.6 में विनिर्दिष्ट उपबंध लागू होंगे।
- 8.0 **लिफ्ट कार और कार ढाँचे (कार फ्रेम) (कार-स्लिंग)**
लिफ्ट-कारों और कार ढाँचों के लिए, जहाँ भी प्रदान किए गए हैं, खंड I अध्याय IV के पैरा 6 में विनिर्दिष्ट आवश्यकताएं लागू होंगी। क्षमता और लदान के संबंध में परिशिष्ट - V में विनिर्दिष्ट आवश्यकता लागू होगी। कार ढाँचा सामान्यतः खंड -I अध्याय - IV के पैरा 6.I के अनुरूप होगा।
- 9.0 **कार दरवाजे, अवतरण दरवाजे और पाशन साधन**
इन पर खंड I अध्याय - IV के पैरा 7.1, 7.3 और 12.7 में उल्लिखित आवश्यकता लागू होगी।
- 10.0 **कार का मुक्त प्रपात, अत्यधिक चाल से अवरोहण और विसर्पण के विरुद्ध सावधानियां**
- 10.1 कार के मुक्त प्रपात या अत्यधिक चाल से अवरोहण को रोकने के लिए नीचे 10.2 में यथा परिभाषित सुरक्षा गियर प्रदान किए जाएंगे।
- 10.2 अवतरण स्तर से 0.12 मी० से अधिक विसर्पण और इसके समान ही, अपाशन जोन के नीचले सिरे से नीचे विसर्पण को रोकने के लिए लिफ्ट में निम्नलिखित में से कोई एक प्रदान किया जाएगा :
(क) वैद्युत विसर्पण रोधी (11.2.6 देखें) या
(ख) कार को नीचे की ओर गति करने पर सुरक्षा गियर की अतिरिक्त ट्रिपिंग।
- 10.3 गर्त अर्थात् पिट में काम कर रहे व्यक्तियों की कार के विसर्पण के विरुद्ध सुरक्षा सुनिश्चित करने के लिए हॉयस्टवे में एक रक्षी युक्ति (साधन) प्रदान की जाएगी।
- 11.0 **सुरक्षा गियर**
- 11.1 **प्रत्यक्ष कार्यकारी द्रवचालित लिफ्ट**
यात्री वहन करने योग्य सभी प्रत्यक्ष कार्यकारी लिफ्टों में विदरण वाल्व लगाए जाएंगे।
- 11.2 **अप्रत्यक्ष कार्यकारी द्रवचालित लिफ्टें**
- 11.2.1 सभी अप्रत्यक्ष कार्यकारी लिफ्टों में इस विनिर्देशों के खंड I अध्याय IV के पैरा 12.0 में विनिर्दिष्ट आवश्यकताओं का पालन करते हुए सुरक्षा गियर लगाए जाएंगे।

- 6.2 The dimensions of machine rooms shall be sufficient to permit easy and safe access for servicing personnel to all the components, especially the electrical equipment. In particular these shall be provided:
- (a) a clear horizontal area in front of the panels and the cabinets. This area is defined as follows:
depth : measured from the external surface of the enclosures; at least 0.7m. this distance may be reduced to 0.6m in front of protruding controls, (handles, etc.)
width : the greater of the following values: 0.5m or the full width of the cabinet or panel.
 - (b) A clear horizontal area of at least 0.5m x 0.6m for servicing and inspection of moving parts at points where this is necessary and , if need be, manual emergency operation.
 - (c) Access ways to these clear spaces which shall have a width of at least 0.5m. This value may be reduced to 0.4m in areas where there are no moving parts.
- 6.3 The machine room floor should be made of oil resistance, fire retardent and nonskid material.
- 7.0 **Guide Rails, Guide Shoes and Buffers**
Guide rails, guide shoes and buffers shall generally conform to IS 14665 (part 4 Sec 1 & 2): 2001 and provision as specified under para 5.0, 10.0 & 12.6 of section I chapter IV shall apply.
- 8.0 **Lift Car and Car-Frames (Car Slings)**
For lift cars and car-frames wherever provided, the requirements specified in para 6 of Section-I Chapter IV shall apply. As regards capacity and loading, the requirement specified in Appendix V shall apply. The car frame shall generally conform to para 6.1 of Section-I Chapter IV.
- 9.0 **Car Doors, Landing Doors and Locking Devices**
The requirement specified in para 7.1,7.3 & 12.7 of section-I Chapter IV shall apply.
- 10.0 **Precautions against Free Fall of Car, Descent with Excessive Speed and Creeping**
- 10.1 To prevent the car from free fall or descent with excessive speed, safety gears as defined in 10.2 below shall be provided.
- 10.2 To prevent the car from creeping from a landing level by more than 0.12m, and likewise, creeping below the lower end of the unlocking zone, the lift shall be provided with either;
- (a) electrical anti-creep(see 11.2.6); or
 - (b) additional tripping of safety gear by down-ward movement of car.
- 10.3 A protective device shall be provided in the hoistway to ensure safety of person working in the pit against creeping of the car.
- 11.0 **Safety Gears**
- 11.1 **Direct Acting Hydraulic Lifts**
All direct acting lifts capable of carrying passengers shall be provided with a rupture valve.
- 11.2 **Indirect Acting Hydraulic Lifts**
- 11.2.1 All indirect acting lifts shall be provided with safety gears complying with the requirements specified in para 12.0 of chapter IV in Section-I of this specifications.

- 11.2.2 सुरक्षा गियर 1.0 एम पी एस से अनधिक निर्धारित चाल वाली लिफ्टों के विदरण वाल्व के साथ मिलकर सुरक्षा रज्जु द्वारा प्रचालित होगा।
- 11.2.3 विदरण वाल्व कार की अधोगति को रोकने में सक्षम होगा और अधोगामी निर्धारित चाल धन 0.3 मी०/से० के बराबर चाल तक पहुँचने तक इसे स्थिर बनाए रखेगा।
- 11.2.4 विदरण वाल्व समायोजन और निरीक्षण के लिए अभिगम्य होगा।
- 11.2.5 विदरण वाल्व या तो
 (क) सिलिंडर का अभिन्न भाग, या
 (ख) प्रत्यक्षतः और दृढ़तापूर्वक फ्लैज आरोपित, या
 (ग) सिलिंडर के निकट स्थापित और छोटी दृढ़ पाइपों के माध्यम से इससे संयोजित वेल्डित, फ्लैज या चूड़ीदार संयोजन, या
 (घ) चूड़ीकाटकर सिलिंडर से सीधे संयोजित। विदरण वाल्व की अंतिम चूड़ियां उभरी हुई (स्कंध युक्त) होनी चाहिए।
- 11.2.6 **वैद्युत विसर्पण रोधी प्रणाली**
 वैद्युत विसर्पण रोधी प्रणाली में निम्नलिखित दशाओं को संतुष्ट करने की व्यवस्था होनी चाहिए:
 कार को अवतरण स्तर से नीचे अधिकतम 0.12 मी० से अपाशन जोन के निचले सिरे तक के जोन में विस्तारित होने पर, मोटर, दरवाजे की स्थिति के निरपेक्ष, ऊर्जित हो जाएगा।
 पिछली यात्रा के पश्चात् न्यूनतम 15 मिनट से अनधिक अवधि के लिए कार का उपयोग न होने पर कार स्वतः निम्नतम अवतरण पर भेज दी जाएगी।
- 12.0 **निलंबन**
 निलंबन रज्जु जहाँ भी लगाई गयी हों, आई एस० 14665 (भाग 4 धारा 8) : 2001 में विनिर्दिष्ट आवश्यकताओं का पालन करेंगी।
- 13.0 **नियंत्रक और प्रचालन युक्तियां**
 इस पर आई० एस० 14665 (भाग 4 धारा 9) : 2001 में विनिर्दिष्ट आवश्यकता लागू होगी।
- 14.0 **टर्मिनल अवरोधन और अंतिम सीमा स्विच**
- 14.1 प्रत्येक द्रवचालित लिफ्ट में उच्च और निम्न सामान्य टर्मिनल सीमाओं को इस प्रकार व्यवस्थित किया जाना चाहिए ताकि कार को सामान्य प्रचालन की किसी भी चाल से शीर्ष कार अवकाश और तल रन-बाई (अति यात्रा) की सीमाओं के भीतर स्वतः रोका जा सके। ऐसी सीमा स्विचें प्रचालन युक्तियों चरम अंतिम सीमा स्विचों और बफर से स्वतंत्र रहकर कार्य करेंगी।
- 14.2 द्रवचालित लिफ्टों में सदैव चरम या अंतिम सीमा स्विच को इस प्रकार व्यवस्थित किया जाएगा कि कार को शीर्ष अवकाश के भीतर, सामान्य प्रचालन सेवा से स्वतंत्र रहकर, स्वतः रोका जा सके।

11.2.2 The safety gear shall be operated by a safety rope in conjunction with a rupture valve on lifts with a rated speed not exceeding 1.0 mps.

सुरक्षात्मक प्रयत्न के लिए उचित बल प्रदान किया जाये।

11.2.3 The rupture valve shall be capable of stopping the car in downward movement, and maintaining it stationary at the latest when the speed reaches a value equal to rated speed downwards plus 0.3 m/s.

11.2.4 The rupture valve shall be accessible for adjustment and inspection.

11.2.5 The rupture valve shall be either:

- (a) integral with the cylinder, or
- (b) directly and rigidly flange mounted, or
- (c) placed close to the cylinder and connected to it by means of short rigid pipes, having welded, flanged or threaded connections, or
- (d) connected directly to the cylinder by threading. The rupture valve shall be provided with a thread ending with a shoulder. The shoulder shall butt up against the cylinder.

11.2.6 *Electrical Anti-creep System*

An electrical anti-creep system shall be provided which satisfies the following conditions:

The motor shall be energized in the up direction independent of the position of the doors, when the car is in a zone which extends from maximum 0.12m below the landing level to the lower end of the unlocking zone.

When the lift has been unused for a period not exceeding 15 min after the last journey, the car shall be dispatched automatically to the lowest landing.

12.0 **Suspension**

Wherever provided, the suspension ropes shall comply with the requirements specified in IS 14665 (Part 4- Sec. 8): 2001

13.0 **Controllers and Operating Devices**

The requirement specified in IS 14665 (part 4-Sec 9): 2001 shall apply.

14.0 **Terminal Stopping and Final Limit switches**

14.1 Every hydraulic lift shall be provided with upper and lower normal terminal limit switches arranged to stop the car automatically within the limits of top car clearance and bottom run by (overtravel) from any speed attained in normal operation. Such limit switches shall act independently of the operation devices, the ultimate or final limit switches and the buffers.

14.2 Hydraulic lifts shall in all cases be provided with an ultimate or final switch arranged to stop the car automatically within the top clearance independent of the normal operating service.

This section covers the essential requirements, design considerations, testing and precautions

खण्ड - III

सेवा लिफ्ट (मूक प्रतीक्षक)

श्री गणेशाय नमः । श्री १९४७-४८ (विशेष) विधानसभा अध्यादेश ।
श्री १९४७-४८ (विशेष) विधानसभा अध्यादेश ।

१९४७-४८

SECTION -III

SERVICE LIFTS (DUMB WAITERS)

विषय क्षेत्र

- 1.1 इस अनुभाग में विद्युत शक्ति से प्रचालित सेवा लिफ्टों (मूक प्रतीक्षकों) के अधिष्ठापन के दौरान अपनायी जाने वाली आवश्यक अर्हताएं, डिजाइन विचारणों, परीक्षणों और सावधानियों को शामिल किया गया है ताकि इसका सुरक्षित और संतोषजनक निष्पादन सुनिश्चित किया जा सके।
यह अधिष्ठापन के पश्चात् उचित अनुरक्षण के लिए मार्ग निर्देश भी देता है।
- 1.2 यह अनुभाग केवल सेवा लिफ्टों (मूक प्रतीक्षकों) के लिए ही लागू होगा और प्लेटफार्म, मोटर वाहक लिफ्टों आमोद-प्रमोद युक्तियों, स्किप हॉयस्ट, वाहकों या इसी प्रकार के उपकरणों को उठाने, स्तंभन या अलंकरण के लिए लागू नहीं होगा।
- 2.0 **शब्दावली**
- 2.1 इस अनुभाग के लिए इस विनिर्देश के खंड I के अध्याय II में दी गयी परिभाषाएं और निम्नलिखित परिभाषाएं लागू होंगी।
- 2.1.1 **सेवा लिफ्ट (मूक-प्रतीक्षक)**
कार युक्त एक ऐसी लिफ्ट है जो गाइडों में वस्तुतः ऊर्ध्वाधर दिशा में गति करती है, इसका फर्श क्षेत्रफल निश्चित तथा भीतरी ऊँचाई पूर्ण होगी, इसमें स्थिर या सचल शैल्फ लगे या नहीं भी लगे हो सकते हैं इसकी क्षमता क्रमशः 1 वर्ग मी०, 1.25 मी० और 250 किग्रा० से अधिक नहीं होगी और इसका उपयोग -मात्र सामग्री वहन के लिए किया जाता है और व्यक्ति वहन के लिए नहीं।
- 3.0 **सामग्रियां**
- 3.1 लिफ्ट अधिष्ठापन में प्रयुक्त सभी सामग्रियां फिटिंग्स, उपकरण आदि संगत आई एस मानकों जहां भी ये मौजूद हों, के अनुरूप होंगे। ऐसी सामग्रियां जिनके लिए भारतीय मानक उपलब्ध नहीं है, सक्षम प्राधिकारी द्वारा अनुमोदित की जाएंगी।
- 4.0 **सुरक्षा गुणक**
लिफ्ट के किसी भी भाग के लिए सुरक्षा गुणक 5 से कम नहीं होगा। विनिर्दिष्ट होने पर विभिन्न भागों के लिए उच्चतर सुरक्षा गुणक लागू होगा।
- 5.0 **गाइड**
इस विनिर्देश के खंड I की आवश्यकताएं लागू होंगी, अलावा यह कि एंगल सैक्शन गाइड रेलों का भी प्रयोग किया जा सकता है और सुरक्षा गियर प्रयुक्त किये जाने पर ही आई एस 14665 (भाग 4 / धारा 4) की आवश्यकताएं लागू होंगी।
- 6.0 **बफर**
स्प्रिंग, रबड़ या काष्ठ बफर प्रयुक्त किए जाएंगे। काष्ठ पकाया हुआ और आई एस 401 के अनुसार उपचारित होगा।
- 7.0 **लिफ्ट कार**
- 7.1 सेवा कार काष्ठ या धातु की बनायी और निलंबन बिंदु पर प्रबलित होनी चाहिए। प्रयुक्त सामग्री की सामर्थ्य और दृढ़ता इतनी होगी कि वह अनुबंधित भार को सहन कर सके। नवीकरणीय गाइड शूज के दो जोड़े उपलब्ध कराए जाएंगे।
- 7.2 हटाने योग्य शैल्फ को इस प्रकार बनाए रखा जाएगा कि वह कार की गति से विस्थापित न हो।

1.0 **Scope**

1.1 This section covers the essential requirements, design considerations, testing and precautions to be exercised during installation of service lifts (dumb waiters) operated by electric power so as to ensure safe and satisfactory performance.

It also provides guidance for proper maintenance after installation.

1.2 This section applies to service lifts (dumb waiters) only and does not apply to platform, motor vehicle lifts, amusement devices, skip hoists, conveyors or similar apparatus used for raising, piling or tiring.

2.0 **Terminology**

2.1 For the purpose of this section, the definitions given in chapter II in section I of this specifications and the following definitions shall apply.

2.1.1 *Service Lift (Dumb-Waiter)*

A lift with a car which moves in guides in a substantially vertical direction; has net floor area, total inside height, whether or not provided with fixed or removable shelves, and capacity not exceeding 1 sq m, 1.25m and 250 kg respectively; and is exclusively used for carrying material and not any person.

3.0 **Materials**

3.1 All material, fittings, appliances, etc. used in lift installation shall conform to the relevant Indian Standards wherever these exist. The materials for which Indian Standards do not exist shall be approved by a competent authority.

4.0 **Factor of Safety**

The factor of safety for any part of the lift shall not be less than five. Higher factor of safety for various parts shall be applicable wherever specified.

5.0 **Guides**

The requirements of Section I of this specifications shall apply except that angle section guide rails may also be used and the requirements of IS 14665 (Part 4/ Sec 4) shall apply only when safety gear is used.

6.0 **Buffers**

Spring, rubber or timber buffers shall be used. Timber shall be seasoned and treated in accordance with IS401.

7.0 **Lift Car**

7.1 The service lift car shall be made of wood or metal, reinforced at the point of suspension. The material used shall be of such strength and stiffness that it withstands the contract load. Two pairs of renewable guide shoes shall be provided.

7.2 Any removable shelves shall be so retained that they are not displaced by the movement of the car.

7.3 विपरीत दिशा में खुलने वाली कार को इस प्रकार बनाया जाएगा कि माल को बाहर निकलने से बचाने के लिए कुछ संरक्षण प्रदान किया जाए। फाटकों का उपयोग होने पर इसमें पिकेट लगे होने चाहिए और इसके केन्द्रों के बीच दूरी 125 मिमी० से अधिक नहीं होनी चाहिए।

7.4 सुरक्षा गियर वाले स्थानों पर इनके प्रचालन को सहन करने के लिए पर्याप्त दृढ़ता वाले कार का इस्पात ढांचा प्रदान किया जाना चाहिए।

8.0 लिफ्ट कूप

8.1 लिफ्ट कूप में सेवा लिफ्ट कूप के अंग के रूप में कार्य करने वाले तथा इसके अनुरक्षण के लिए आवश्यक भाग के अलावा कोई अन्य उपस्कर स्थापित नहीं किया जाना चाहिए।

8.2 सेवा लिफ्ट कूप का आंतरिक पृष्ठ, जहाँ तक व्यवहारिक हो, सपाट रखा जाएगा।

8.3 कार के गाइडों तथा लिफ्ट कूप अहाते की पार्श्व दीवारों के बीच पर्याप्त अवकाश प्रदान किया जाना चाहिए ताकि सुरक्षा गियर के पुर्जों की मरम्मत और अनुरक्षण के लिए उन तक सरलता पूर्वक सुरक्षित पहुँचा जा सके।

8.4 लिफ्ट कूपों को, इसके पूरे उपकरणों और उपसाधनों के साथ साथ अधिकतम संभावित सीमा तक आग रोधी बनाया जाना चाहिए।

8.5 ठोस अवतरण दरवाजों से पूर्णतः बंद लिफ्ट के मामले में प्रत्येक अवतरण के बाहर "सेवा लिफ्ट" की एक नोटिस लगायी जानी चाहिए।

8.6 प्रत्येक प्रतिभार को उसी लिफ्ट कूप में इसी कार कर के ठीक विपरीत दिशा में यात्रा करनी चाहिए।

8.7 किसी लिफ्ट कूप के नीचे से कोई कक्ष जगह या पारगमन मार्ग देना वांछनीय नहीं है। इसे अपिहार्य होने पर गर्त फर्श इतना दृढ़ होना चाहिए कि वह लदी हुई कार या प्रतिभार के मुक्त पात संघट्ट को सहन कर सके।

8.8 लिफ्ट गर्त, निम्न अवकाश और उच्च अवकाश

8.8.1 प्रत्येक सेवा लिफ्ट के अधस्तल पर निम्नतम अवतरण के अवतरण स्तर से लिफ्ट गर्त प्रदान की जानी चाहिए।

8.8.2 गर्तों को सुदृढ़ निर्मित और अनुरक्षित तथा साफ सुथरी दशा में बनाए रखा जाना चाहिए तथा, यथावश्यक, स्थायी अपवाह के लिए व्यवस्था की जानी चाहिए।

8.8.3 गर्त की गहराई 1.5 मीटर से अधिक होने पर उचित अभिगम के लिए एक कैट लैडर या अन्य उपयुक्त युक्ति उपलब्ध करायी जानी चाहिए तथा अनुरक्षण और मरम्मत कार्य की सुविधा के लिए एक लाइट प्वाइंट और स्विच लगाया जाना चाहिए।

8.8.4 उच्च कार अवकाश इतना पर्याप्त होना चाहिए कि कार के शीर्ष पर लगे बाहर निकले हुये किसी भाग को अधस्छद या अपवर्ती चरखी के सीधे संपर्क में आने से बचा जा सके।

अवकाश की गणना निम्नलिखित को ध्यान में रखकर की जाएगी और यह निम्नलिखित चार मदों के योग से कम नहीं होना चाहिए:

(क) निम्न प्रतिभार रनबाई,

7.3 Car constructed with openings on opposite sides shall be provided with some form of protection to prevent the goods from projecting outside the car. Where gates are used, they shall have pickets spaced with centres not more than 125 mm apart.

7.4 Where safety gear is provided, steel car frame of sufficient rigidity to withstand the operation of the safety gear shall be provided.

8.0 Lift Wells

8.1 No equipment except that forming a part of the service lift or necessary for its maintenance shall be installed in the lift well.

8.2 The internal surface of service lift well, so far as practical, shall be kept flush.

8.3 Sufficient space shall be provided between the guides for the car and the side walls of the lift well enclosure to allow safe and easy access to the parts of the safety gears for their maintenance and repairs.

8.4 Lift wells, together with the whole of the contained equipment and apparatus, shall be rendered fire-resisting to the greatest possible extent.

8.5 In case of a completely enclosed lift well, with solid landing doors, a notice with the word 'Service Lift' shall be placed outside each landing door.

8.6 Every counterweight shall travel in juxtaposition to its car in the same lift well.

8.7 It is undesirable that any room passage or thoroughfare be permitted under any lift well. If unavoidable then the pit floor should be strong enough to withstand the impact of free falling loaded car or counterweight.

8.8 Lift Pits, Bottom Clearance and Top Clearance.

8.8.1 A lift pit shall be provided at the bottom of every service lift from the loading level of the lowest landing.

8.8.2 Pits shall be soundly constructed and maintained in a dry and clean condition, Where necessary, provision shall be made for permanent drainage.

8.8.3 Where pit depth exceeds 1.5m, suitable access shall be provided by a cat ladder or any other suitable device and a light point and switch shall also be provided for facility of maintenance and repair work.

8.8.4 The top car clearance shall be sufficient to avoid any protruding part fixed on the top of the car coming in direct contact with the ceiling or diverting sheave.
The clearance shall be calculated taking into account the following and shall not be less than the sum of the following four items :
(a) The bottom counterweight runby,

(ख) प्रयुक्त प्रतिभार बफर का स्ट्रोक

(ग) लिफ्ट कूप में अधस्खद के नीचे लटक रहे अपवर्ती चरखी के हिस्से की विभाए, और

(ध) गुरुत्व विरामी दूरी की पूर्ति और प्रतिभार कार या निलंबन बिंदुओं पर रज्जु संयोजनों की भावी मरम्मतों के लिए 15 सेमी०।

8.8.5 निम्न कार अवकाश को इस प्रकार बनाए रखा जाना चाहिए कि कार को पूर्णतः बफर की संपीडित विरामावस्था में होने पर अंतस्खद या इसके नीचे लटक रहा कोई भाग किसी अन्य भाग के संपर्क में न आए बशर्ते बफर स्प्रिंग प्रकार के तथा ठोक कंक्रीट या इस्पात आधार पर आरोपित हो।

काष्ठ बफर के मामले में निम्न कार अवकाश को इस प्रकार बनाए रखा जाना चाहिए कि कार की गर्त के निकटतम फर्श के सेवा स्तर से नीचे की ओर कुल यात्रा, कार बफर पूर्णतः दबी होने पर उच्च (शीर्ष) प्रतिभार अवकाश से अधिक नहीं होनी चाहिए।

8.8.6 ऊपरी प्रतिभार अवकाश प्रतिभार के लिए ऊपरी अवकाश की गणना निम्नलिखित को ध्यान में रखकर की जाएगी और यह निम्नलिखित तीन मदों के योग से कम नहीं होनी चाहिए :

(क) कार रनबाई

(ख) बफर स्प्रिंग का संपीडन या बफर के रूप में प्रयुक्त काष्ठ ब्लाक की ऊँचाई

(ग) प्रतिभार की गुरुत्व विराम दूरी की पूर्ति और कार सिरों या निलंबन बिंदुओं पर प्रतिभार संयोजक रज्जु के किसी भावी मरम्मत के लिए 15 सेमी०।

8.9 कारों या प्रतिभारों के लिए रनबाई

8.9.1 कारों और प्रतिभारों के लिए निम्न रनबाई 15 सेमी० से कम नहीं होना चाहिए।

8.9.2 अधिकतम तल रनबाई

किसी भी दशा में अधिकतम तल रनबाई 30 सेमी० से अधिक नहीं होना चाहिए।

8.10 लिफ्ट कूप अहाते

8.10.1 लिफ्ट कूप अहाता प्रदान किया जाएगा और यह एक फर्श से दूसरे फर्श तक या एक सीढ़ी से दूसरी सीढ़ी तक सभी पार्श्व पर विस्तारित होना चाहिए।

8.10.2 किसी कार प्रवेश के सामने के लिफ्ट कूप अहाते का भीतरी किनारा यथा संभव चिकना, अविच्छिन्न सपाट प्रक्षेप और अवकाश रहित होना चाहिए।

8.10.3 चूँकि किसी भवन में खुला लिफ्ट कूप आग लगने के जोखिम को बढ़ा देता है इसलिए लिफ्ट कूप अहाते का निर्माण अग्नि रोधक पदार्थों से किया जाना चाहिए।

8.10.4 तार ग्रिल या ऐसी ही निर्माण का उपयोग किए जाने पर जाली या द्वार इस प्रकार का होना चाहिए कि छड़ों के बीच द्वार 30 मिमी० व्यास वाली गेंद को अस्वीकार कर दे तथा लिफ्ट कूप अहाता इतना दृढ़ होना चाहिए कि वह सटे फर्श की सीढ़ी के प्रयोगकर्ताओं, सामग्रीयों या निकट में चल रही ट्रकों के आकस्मिक संघट्ट को रोक सके।

- (b) The stroke of the counterweight buffer used,
- (c) The dimensions of the portion of the diverting sheave hanging underneath the ceiling in the lift well, and
- (d) 15 cm for compensating for gravity stopping distance and future repairs to the rope connections at counter weight and at the car or at the suspension points.

8.8.5 The bottom car clearance shall be maintained in such a way that the counter weight shall not come in contact with the ceiling or any part hanging underneath the ceiling, when the car completely rests on fully compressed buffers, provided the buffers are spring type mounted on solid concrete or steel bed.

In case of wooden buffers the bottom car clearance shall be maintained in such a way that the total downward travel of the car from the service level of the immediate floor near the pit, shall not be more than the top counterweight clearance, when the wooden buffers are completely crushed.

8.8.6 The top clearance for the counterweight can be calculated taking into account the following and shall not be less than the sum of the following three items:

- (a) Car runby,
- (b) Compression of the buffer spring or height of the wooden block used as buffer, and
- (c) 15 cm to compensate for gravity stopping distance for counterweight and any future repairs to rope connections at the counterweight at the car ends or at the suspension points.

8.9 Runby for Cars and Counterweights

8.9.1 The bottom runby for cars and counterweights shall not be less than 15 cm.

8.9.2 *Maximum bottom runby*

In no case shall the maximum bottom runby exceed 30 cm.

8.10 Lift Well Enclosures

8.10.1 Lift well enclosures shall be provided and shall extend on all sides from floor to floor or stair to stair.

8.10.2 The inner sides of the lift well enclosures facing any car entrance shall as far as practicable, form a smooth, continuous flush surface devoid of projections or recesses.

8.10.3 Where an open lift well would increase the fire risk in a building, the lift well enclosures shall be of fire resisting construction.

8.10.4 Where wire grill or similar construction is used, the mesh or opening shall be such that the opening between the bars shall reject the ball of 30 mm in diameter and the lift well enclosures shall be of sufficient strength to resist accidental impact by users of the staircase of adjoining floors or by materials or trucks being moved in the vicinity.

- 8.10.5 खुले प्रकार के लिफ्ट कूप अहाते के भीतर और लिफ्ट उपस्कर उपकरण के किसी सचल या चलने योग्य भाग के बीच का अवकाश यदि 5 सेमी० से कम हो तो अहाते की खुली जगह को पुनः ऐसी वर्गाकार जाली से संरक्षित किया जाना चाहिए जिसके छिद्र 1 सेमी से बड़े तथा तार 1 मिमी. से छोटे न हों (कारखाना अधिनियम के अंतर्गत आने वाले कारखाना परिसरों के लिफ्ट कूपों के लिए इनका पालन करना आवश्यक नहीं है। ऐसे मामलों में 8.16.4 का उपबंध पर्याप्त है) ।
- 8.10.6 सेवा लिफ्ट कूप अहाते में किसी ऐसे द्वार की अनुमति नहीं होगी जिससे प्रतिभार के नीचे से होकर सेवा लिफ्ट कार के लिए मार्ग मिल सके।
- 8.10.7 सूचक
सेवा लिफ्टों को पूर्णतः संवृत्त कूपों में अधिष्ठापित होने पर प्रत्येक अवतरण पर प्रचालन दाब बटनों के साथ-साथ कार आगमन या स्थिति सूचक या दिशा तीर या "प्रयोग में है" (IN USE) सूचक अधिष्ठापित किए जाते हैं।
- 8.10.8 अवतरण दरवाजे
प्रत्येक सेवा लिफ्ट कूप में, प्रत्येक ओर जहाँ से कार तक पहुँचा जा सके, एक दरवाजा लगाया जाना चाहिए। इस प्रकार के दरवाजों में एक कुशल विद्युत यंत्रिक पाश लगायी जानी चाहिए ताकि यह सुनिश्चित किया जा सके कि सेवा लिफ्ट कार को अवतरण पर होने के अलावा खोला न जा सके और दरवाजों को बंद और पाशित होने से पूर्व इसे अवतरण से न चलाया जा सके। दरवाजे को यांत्रिक रूप से पाशित होने पर आपात स्थिति में या निरीक्षण के दौरान विशेष चाबी से खोलने की व्यवस्था की जानी चाहिए।
- 8.10.9 पॉवर विलगन के लिए स्वचालित युक्तियों
प्रत्येक सेवा लिफ्ट में एक कुशल स्वचालित युक्ति प्रदान की जाएगी और बनायी रखी जाएगी जिससे कार या प्रतिभार को बफर पर उतरने से पहले सभी पॉवर मोटर से विलग हो जाएं।
- 8.11 सेवा लिफ्ट कार
- 8.11.1 आवश्यक होने पर सेवा लिफ्ट कारों के लिए दरवाजे प्रदान किए जाएंगे।
- 8.12 अवतरण दरवाजों और शटर के लिए पाशन युक्तियां
- 8.12.1 अवतरण दरवाजा या शटर अंतर्पाश प्रणाली यात्री लिफ्टों (खंड-I) में प्रदान की गयी प्रणाली के अनुरूप होगी।
- 8.12.2 पाशन प्रणाली का डिजाइन इस प्रकार का होना चाहिए कि कार्यशील भागों के बीच अधिक होने के कारण पाश (लॉक) हथ्यों की गति से लिफ्ट के प्रचालन में बाधा उत्पन्न न हो।
- 8.13 निलंबन रज्जु
खंड - I में दिए अनुसार विद्युत संकर्षण लिफ्टों के प्रावधान लागू होंगे
- 8.14 चरखियां और पुली
खंड - I में दिए अनुसार विद्युत संकर्षण लिफ्टों के प्रावधान लागू होंगे।
- 8.15 प्रतिभार
खंड - I में दिए अनुसार विद्युत संकर्षण लिफ्टों के प्रावधान लागू होंगे

- 8.10.5 Where the clearance between the inside of an open type lift well enclosure and any moving or movable part of the lift equipment or apparatus is less than 5 cm, the opening in the enclosure shall be further protected by netting of square mesh of aperture not greater than 1 cm and of wire not smaller than 1mm (the provision in this clause need not be adhered to for lift wells in factory premises, coming under the purview of Factories Act. In such cases provision of 8.10.4 is sufficient).
- 8.10.6 There shall be no opening in the service lift well enclosure permitting access to the service lift car by passing under the counterweight.
- 8.10.7 **Indicators**
Where service lifts are installed in totally enclosed wells, car arrival or position indicator and direction arrow or IN USE indicators should be installed on each landing along with operation push buttons.
- 8.10.8 **Landing Doors**
Every service lift well shall, on each side from which there is access to a car, be fitted with a door. Such a door shall be fitted with efficient electromechanical locking so as to ensure that it cannot be opened except when the service lift car is at landing and that the service lift car cannot be moved away from the landing until the door is closed and locked. If the door is mechanically locked, means should be provided for opening the same by means of special key during emergency or inspection.
- 8.10.9 **Automatic Devices for Cutting Off Power**
An efficient automatic device shall be provided and maintained in each service lift whereby all power shall be cut off from the motor before the car or counterweight lands on the buffers.
- 8.11 **Service Lift Cars**
- 8.11.1 Where necessary doors shall be provided to service lift cars.
- 8.12 **Locking Devices for Landing Doors and Shutters**
- 8.12.1 The system of landing door or shutter interlocks shall be of the kinds as provided in for passenger lifts in Section I.
- 8.12.2 The design of the locking system shall be such that reasonable wear between working parts does not permit interference with the operation of the lift by movement of the lock handles.
- 8.13 **Suspension Ropes**
The provisions as indicated in Electric Traction lifts under Section I shall apply.
- 8.14 **Sheaves and Pulleys**
Provision as indicated in Electric Traction lifts under Section I shall apply.
- 8.15 **Counterweight**
Provisions as indicated in Electric Traction lifts under Section I shall apply.

8.16 मोटर कक्ष और शिरोपरि संरचनाएं

- 8.16.1 सेवा लिफ्ट मशीन नियंत्रक तथा इसके अन्य सभी उपकरण और उपस्कर, लिफ्ट कूप या अन्य स्थितियों में कार्य करने वाले उपकरणों और उपस्करों को छोड़कर, पर्याप्त रूप से प्रकाशित, सर्वातित अग्नि तथा वर्षा सह मोटर कक्ष में स्थापित किए जाने चाहिए।
- 8.16.2 द्वितीयक चरखियाँ, पुलियाँ, तल चयनकर्ता उपस्करों को मोटर कक्ष के अलावा ऐसे स्थान पर लगायी जानी चाहिए जो पर्याप्त प्रकाशित, अग्नि सह और जल सह हो।
- 8.16.3 मशीन कक्ष फर्श को इस प्रकार डिजाइन और निर्मित किया जाएगा कि उत्पादन के दौरान और अनुरक्षण के उद्देश्य से सबसे भारी हिस्से को या उपस्कर इकाई को किसी बिंदु पर सुरक्षापूर्वक ले जाया जा सके।
- 8.16.4 मशीन कक्ष को, मशीनरी या उपस्कर के प्रचालन और अनुरक्षण से संबंधित व्यक्तियों के अलावा, बंद रखा जाएगा।
- 8.16.5 मशीन कक्ष में मशीनरी की जाँच के लिए लचीली डोरी युक्त विद्युत् रोधी सुवाह्य हैंड लैप लगाया जाएगा।
- 8.16.6 यदि कोई मशीन कक्ष फर्श या प्लेटफार्म अहाता दीवारों तक विस्तारित न हो तो खुली ओर हस्त (हैंड) रेल या अन्य उपयुक्त गार्ड लगाए जाएंगे।
- 8.16.7 मशीन कक्ष के दरवाजे बाहर की ओर खुलने चाहिए।
- 8.16.8 मशीन कक्ष को लिफ्ट मशीन या इससे संबंधित उपकरणों और उपस्करों के वेशन के अलावा स्टोर कक्ष या किसी अन्य उद्देश्य के लिए उपयोग में नहीं लाया जाना चाहिए।
- 8.16.9 सभी मशीनें, पुलियाँ और इसी प्रकार की इकाइयाँ इस प्रकार आलंबित और स्थापित होनी चाहिए कि इनमें से कोई मशीन या इसका कोई पुर्जा ढीला या विस्थापित न हो तथा इसके सुरक्षित कार्यकरण को प्रभावित न करे।
- 8.16.10 सेवा लिफ्ट मशीन कक्ष के लिए सीधा अभिगम उपलब्ध होना चाहिए।
- 8.16.11 मशीन कक्ष की ऊँचाई इतनी पर्याप्त होनी चाहिए कि मरम्मत और बदलने के लिए उपस्कर के किसी भाग तक पहुँचा जा सके और इसे निकाला जा सके, और यह फर्श से 1.2 मीटर से कम ऊँचा नहीं होना चाहिए।
- 8.16.12 शिरोपरि बीम पर कुल भार बीम पर टिके कुल भार धन बीम से अधिकतम निलंबित कुल भार का दोगुना माना जाना चाहिए।
- 8.16.13 सामग्री और भार की अंतिम सामर्थ्य पर आधारित 8.16.12 के अनुसार सभी शिरोपरि बीम और आलंबों के लिए सुरक्षा गुणांक निम्नलिखित से कम नहीं होना चाहिए:
- | | |
|------------------------|---|
| इस्पात के लिए | 5 |
| प्रबलित कंक्रीट के लिए | 7 |
- उपर्युक्त के अनुसार गणना किए गए अधिकतम स्थैतिक भार के अंतर्गत शिरोपरि बीम का विचलन विस्तृति (स्पैन) के 1/1500 से अधिक नहीं होना चाहिए।

8.16 **Motor Room and Overhead Structures**

- 8.16.1 The service lift machine controller and all other apparatus and equipment of the same, excepting such apparatus and equipments as function in the lift well or other positions shall be placed in the motor room which shall be adequately lighted, ventilated and rendered fireproof and weather proof.
- 8.16.2 The secondary sheaves, pulleys, floor selecting equipments may be placed in a place other than the motor room and such position shall be adequately lighted and rendered fireproof and weatherproof.
- 8.16.3 The machine room floor shall be designed and constructed to carry safely at any point the heaviest portion or unit of equipment both during erection and for maintenance purpose.
- 8.16.4 The machine room shall be kept closed except to those concerned with the operation and maintenance of machinery or equipment.
- 8.16.5 The machine room shall be equipped with an insulated portable hand lamp provided with flexible cord for examining the machinery.
- 8.16.6 If any machine room floor or platform does not extend to the enclosing walls, the open sides shall be provided with hand rails or otherwise suitably guarded.
- 8.16.7 The machine room shall be provided with access doors opening outwards.
- 8.16.8 The machine room shall not be used as a store room or for any purpose other than housing the lift machinery and its associated apparatus and equipment.
- 8.16.9 All machines, pulleys and similar units shall be so supported and held as to prevent any of these machines or parts thereof becoming loose or displaced affecting their safe working. Supporting beam shall be of steel or reinforced concrete.
- 8.16.10 There shall be direct access to the service lift machine room.
- 8.16.11 The height of the machine room shall be sufficient to allow any portion of equipment to be accessible and removable for repair and replacement, and shall be not less than 1.2 m clear from the floor.
- 8.16.12 The total load on the overhead beams shall be assumed as equal to all equipment resting on the beams plus twice the maximum load suspended from the beams
- 8.16.13 The factor of safety for all overhead beams and supports based on ultimate strength of the material and load in accordance with 8.16.12 shall be not less than the following :
- | | |
|-------------------------|---|
| For steel | 5 |
| For reinforced concrete | 7 |
- The deflection of the overhead beams under the maximum static load calculated in accordance with above shall not exceed 1/1500 of the span.

8.17 शिरोपरि पुलियों का वेशन

पेंट हाउस या शिरोपरि पुलियों के वेशन का अन्य अवकाश की स्पष्ट ऊँचाई कम से कम 1.0 मी० होनी चाहिए तथा इसे सुरक्षित और सुविधाजनक अभिगम प्रदान करना चाहिए तथा, जहाँ व्यावहारिक हो, इसका प्लेटफार्म या फर्श स्थाई, तथा स्थाई रूप से कृत्रिम प्रकाश व्यवस्था की जानी चाहिए।

8.18 बफर

8.18.1 बफर को कार के गुरुत्व केन्द्र के सापेक्ष सममित रूप से ± 5 सेमी० उपेक्ष त्रुटि के भीतर इस प्रकार स्थापित और व्यवस्थित किया जाना चाहिए कि प्रचालन की सामान्य परिस्थितियों में सेवा लिफ्ट कार उनसे न टकराए।

8.18.2 बफर को सेवा लिफ्ट कारों कि लिए यथा निर्धारित प्रतिभार कि नीचे लगाया तथा भार के नीचे सममित रूप से व्यवस्थित किया जाएगा।

8.19 सुरक्षा गियर परीक्षण

आई एस 14665 (भाग 2 / धारा 1) के उपबंध लागू होंगे।

8.20 श्लथ (स्लैक) रज्जु स्विच

आई एस 14665 (भाग 2 / धारा 1) के उपबंध लागू होंगे।

9.0 सरंचनात्मक शक्ति और लदान

9.1 निर्धारित भार तथा कार के भीतरी क्षेत्रफल की शुद्ध माप

चालन मशीन, कार और प्रतिभार, निलंबन साधनों शिरोपरि बीम और आलम्बों, बफर और बफर आलम्बों गाइडों और ब्रेकिटों तथा प्रचालन के दौरान भार से प्रभावित होने वाले अन्य सभी अवयवों को निम्नलिखित गणना के अनुसार निर्धारित भार के आधार पर डिजाइन किया जाएगा :

$$L = 250 A^2$$

जहाँ

L = निर्धारित भार किग्रा में तथा

A = शुद्ध भीतरी क्षेत्रफल वर्गमीटर में है

निर्धारित भार 250 किग्रा० और प्लेटफार्म के भीतर शुद्ध क्षेत्रफल 1 मी०² से अधिक नहीं होना चाहिये।

10.0 लोड प्लेट

निर्धारित लोड को 6 मिमी० से बड़े अक्षरों और अंकों में दर्शाती हुई एक धातु प्लेट कार में स्पष्ट स्थान पर लगायी जानी चाहिए।

11.0 प्रतिभार

11.1 प्रतिभार धातु का होना चाहिए।

11.2 कई खंड और फ्रेम रहित प्रतिभार में पूरे प्रतिभार तक विस्तारित निलंबन छड़ों की संख्या दो से कम नहीं होनी चाहिए। निलंबन छड़ों के नट स्लिट पिनों द्वारा कंक्रीट धातु फ्रेम में या समान थनात्मक उपायों द्वारा बनाए रखे जाएंगे।

12.0 सुरक्षा गियर

12.1 ऐसे अधिकृत स्थान या बरामदे में कार्य कर रही सेवा लिफ्ट की कार और इसके प्रतिभार के लिए सुरक्षा गियर प्रदान किए जाने चाहिए। जहाँ गर्त का तल मुक्त रूप से गिरने वाली भरी कार या प्रतिभार के संघट्ट को आलम्ब देने में समर्थ न हो।

8.17 Housing of Overhead Pulleys

The penthouse or other space in which overhead pulleys are housed shall have a clear height of at least 1.0 m and shall allow safe and convenient access and where practicable, have a substantial platform or floor and be provided with permanent and adequate artificial illumination.

8.18 Buffers

8.18.1 Buffers shall be placed symmetrically with respect to the centre of gravity of the car within a tolerance of ± 5 cm and shall be so arranged, that the service lift car, in ordinary circumstances of operations cannot strike them.

8.18.2 The buffers shall be fitted under counterweight, similar to those specified for service lift cars and arranged symmetrically below the weight.

8.19 Safety Gear Test

Provisions of IS 14665 (part 2/Sec 1) shall apply.

8.20 Slack rope Switch

Provisions of IS 14665 (Part 2/Sec 1) shall apply.

9.0 Structural Strength and loading

9.1 Rated load and Net Inside Car Area Measurements

Driving machine, car and counterweight, suspension means, overhead beams and supports, buffers and buffer supports, guides and brackets and all other members subjected to load during operations shall be designed on the basis of rated load calculated as follows:

$$L = 250 A^2$$

Where

- L = rated load in kg. And
- A = net inside area in m².

The rated load shall be not more than 250 kg and the net inside platform area shall be not more than 1 m².

10.0 Load Plate

A metal plate giving the rated load in not less than 6 mm high letters and figures shall be fastened in a conspicuous place in the car.

11.0 Counterweight

11.1 The counterweight shall be of metal.

11.2 The counterweight consisting of sections and without frame shall have not less than two suspension rods extending throughout the counterweight. The nuts on the suspension rods shall be retained by split pins, concrete in metallic frame or equivalent positive means.

12.0 Safety Gear

12.1 A safety gear shall be provided for the car and counterweight of the service lift working over an occupied space or corridor, where the bottom of the pit cannot support the impact load of the freely falling loaded car or counterweight.

12.2 सुरक्षा गियर, लिफ्ट कूप, शीर्ष की स्वतंत्र पुली पर चलायमान स्वतंत्र इस्पात तार रज्जु द्वारा तात्कालिक रूप से प्रचालनीय प्रकार का हो सकता है, नियंत्रक प्रचालन तथा नियंत्रण परिपथ को वियोजित करने वाली स्विच की आवश्यकता नहीं है।

The driving machine shall be of either of the following types:

13.0 निलंबन (सस्पेंशन) के उपाय और बंधक

13.1 कार और प्रतिभार को आई एस 2365 के अनुरूप एक या अधिक निलंबन रज्जुओं या ध्वनिरहित प्रकार के रोलर ब्लाक या बहुलिंग चैन द्वारा निलंबित किया जाना चाहिए।

13.2 कुंडली ड्रम से लगी सभी रज्जु और चैन, कार या प्रतिभार को इसके अधियात्रा की अंतिम सीमा तक पहुँचने के बाद, एक फेरे से कम शेष नहीं होना चाहिए।

13.3 संरचनात्मक क्षमता भार युक्त कार या प्रतिभार के स्थैतिक भार पर आधारित निलंबन साधनों के सुरक्षा गुणांक निम्नलिखित से कम नहीं होंगे :

रज्जुओं के लिए $4.5 + 1.4 V$ और

चेनों के लिए $5.6 + 1.75 V$

जहां V रज्जु या चैन की चाल (मीटर/सेकेंड में) है।

13.3.1 इस अनुभाग के लिए सुरक्षा गुणांक

$$\frac{F \times n \times K}{w}$$

जहां

F = रज्जु या चैन की अभिहित भंजन सामर्थ्य

n = भार के अधीन पृथक निलंबन रज्जुओं या चेनों की संख्या

k = रज्जुबंधन गुणांक, अर्थात् 1:1 रज्जुबंधन के लिए 1, 2:1 रज्जुबंधन के लिए 2, 3:1 रज्जु बंधन के लिए 3; और

w = कार को स्थिर तथा सेवा लिफ्ट के संरचना क्षमता भार से लदे होने पर कार रज्जु या चैन पर भार

13.4 किसी कार या प्रतिभार रज्जु की संबंधन द्वारा मरम्मत या लम्बाई में वृद्धि नहीं की जाएगी।

13.5 कार और प्रतिभार के कुंडली ड्रम सिरों को ड्रम के भीतर की ओर क्लैप लगाकर संरक्षित किया जाएगा।

13.6 कार और प्रतिभार से लगी निलंबन रज्जुओं को संबंधन युक्त रिटर्न लूप, क्लिप रिटर्न लूप या एकल टेपर बैब्रिट लगे सॉकेटों द्वारा जोड़ा (बद्ध) किया जाना चाहिए। लूपों को उनकी नियतन स्थल पर वहन नहीं करना चाहिए परन्तु वे उचित थिंबल केन्द्रों या संम संरक्षक से संरक्षित होने चाहिए।

13.7 सभी मामलों में बंधक निलंबन रज्जुओं के लिये निर्धारित सुरक्षा गुणांक का 80 प्रतिशत अंतिम निलंबन रज्जु सामर्थ्य से अधिक भार सहन करने योग्य होने चाहिए।

13.8 एकल निलंबन रज्जुओं या चेनों पर भार को बराबर करने के साधन प्रदान किए जाने चाहिए।

13.9 प्रतिकारी रज्जुओं सुरक्षा या इसी प्रकार की रज्जुओं की गिरने वाली वस्तुओं के कारण होने वाली क्षति से संरक्षा की जानी चाहिए।

12.2 The safety gear may be of the instantaneous type operated by an independent steel wire rope running over an independent pulley at the top of the lift well, governor operation and switch to cut the control circuit is not required.

13.0 **Means of Suspension and Fastenings**

13.1 The car and counterweight shall be suspended by one or more steel wire suspension ropes conforming to IS 2365 or silent type roller, block or multiple link chains

13.2 All the ropes and the chains anchored to a winding drum shall have not less than one turn on the drum when the car or counterweight has reached the extreme limit of its overtravel.

13.3 The factor of safety of the suspension means, based on the static load of the car with structural capacity load or of the counterweight, shall be not less than:

4.5+ 1.4 V for ropes, and

5.6 +1.75 V for chains.

Where

V is the speed of the rope or chain in m/s.

13.3.1 For the purpose of this section, the factor of safety is given by:

$$\frac{F \times n \times k}{W}$$

Where

F = nominal breaking strength of the rope or chain;

n = number of separate suspension ropes or chains under load;

k = roping factor, that is, 1 for 1:1 roping, 2 for 2:1 roping and 3 for 3:1 roping; and

W = load on the car rope or chain when the car is stationary and loaded to the structural capacity load of the service lift.

13.4 No car or counterweight rope shall be repaired or lengthened by splicing.

13.5 The winding drum ends of the car and counterweight ropes shall be secured by clamps on the inside of the drum.

13.6 The car and counterweight ends of the suspension ropes shall be fastened by spliced return loops, clipped return loops or individual tapered babbitted sockets. Loops shall not bear directly on their fixing, but shall be lined with proper thimble eyes or equal protection.

13.7 In all the cases the fastenings shall be capable of sustaining a load not less than the ultimate strength of the suspension ropes based on a factor of safety of 80 percent of the specified factor of safety for suspension ropes.

13.8 Means shall be provided to equalize the load on the individual suspension ropes or chains.

13.9 Tensioning devices for compensation ropes, safety ropes and the like shall be protected against damage due to falling objects.

14.0 चालन मशीन

14.1 चालन मशीन निम्नलिखित में से किसी एक प्रकार की हो सकती है :-

- (क) ड्रम प्रकार की, और
- (ख) संकर्षण प्रकार की

14.2 चालन मशीन और चरखियों को स्थैतिक भार के आधार पर (संरचना क्षमता भार धन कार, रज्जुओं, प्रतिभार आदि का भार) डिजाइन किया जाएगा, या ये निम्न से कम नहीं होंगे :-

- (क) इस्पात के लिए 6, और
- (ख) डलवाँ लोहा और अन्य सामग्रियों के लिए 9

14.3 चालन मशीन में विद्युतीय रूप से मुक्त किए या जाने वाला ऐसा ब्रेक होना चाहिए जो मोटर से पॉवर वियोजित करने पर स्प्रिंग संपीडन द्वारा या गुरुत्व द्वारा स्वतः लग जाए।

15.0 नियंत्रक और प्रचालन युक्तियाँ

15.1 हस्त प्रचालित मुख्य तार वियोजन स्विच को विद्युत चालन मशीन के मुख्य परिपथ केबिलों में अधिष्ठापित किया जाएगा। यह स्विच मशीन से सुगम स्पष्टतः दिखाई देने योग्य होनी चाहिए।

15.2 मुख्य परिपथ को खोलने या चालन मशीन को रोकने के लिए नियंत्रक स्विच में धातु से धातु संपर्कों का प्रयोग किए जाने पर डिजाइन में कम से कम दो स्वतंत्र परिपथ वियोजक लगाए जाएंगे। भूसंपर्कित होने में चूक या किसी दरवाजे को खुला रहने पर यह लिफ्ट कार्य नहीं करेगी।

15.3 तनन स्थिति में स्प्रिंग या स्प्रिंगों का प्रचालन या अन्य विद्युत परिपथ की पूर्णता से इस बात के लिए निर्भर नहीं होना चाहिए कि परिपथ वियोजित और अंतिम अवतरण पर लिफ्ट रुक जाएगी।

15.4 विद्युत परिपथ की रूकावट कार की गति को रोक देगी।

15.5 चालन मशीन बहुकला ए.सी. मोटर द्वारा प्रचालित होने पर इसकी कला उत्क्रमण या विफलता से रक्षा की जानी चाहिए।

15.6 किसी ऐसी नियंत्रण प्रणाली का प्रयोग नहीं किया जाएगा जो विद्युत पूर्ति की विच्छिन्नता के लिए विद्युत परिपथ की पूर्णता या अनुरक्षण पर और लिफ्ट कार को अंतिम तलों पर पहुँचने पर विद्युत यांत्रिक ब्रेकों के अनुप्रयोग पर निर्भर हो।

15.7 नियंत्रण परिपथ मुख्य परिपथ से स्वतंत्र, दोषों या अतिभारों के विरुद्ध फ्यूज द्वारा या अन्यथा रक्षित होंगे।

15.8 किसी नियंत्रक प्रचालन परिपथ की वोल्टता आई एस 12360 में यथा परिभाषित निम्न वोल्टता से अधिक नहीं होनी चाहिए। मुख्य परिपथ से अलग नियंत्रण परिपथ की उचित संरक्षा प्रदान की जाएगी और इस प्रकार व्यवस्थित की जाएगी कि भू-संपर्कन दोष या खुले परिपथ से प्रचालन की स्थिति असुरक्षित न हो जाये।

15.9 हस्त रज्जु (हाथ रस्सी), लीवर या इसी प्रकार की युक्तियों की अनुमति नहीं दी जाएगी।

16.0 टर्मिनल अवरोधन तथा अंतिम सीमा स्विच

16.1 एक ऐसी युक्ति प्रदान की जानी चाहिए जो सामान्य प्रचालन युक्ति से स्वतंत्र हो तथा उच्च और निम्न टर्मिनलों पर मोटर और ब्रेक से पॉवर को स्वतः वियोजित कर सके। यह युक्ति मशीन कक्ष, कार या लिफ्ट कूप में अवस्थित हो सकती है।

14.0 Driving Machine

- 14.1 The driving machine shall be of either of the following types:
- (a) Drum type; and
 - (b) Traction type.
- 14.2 The driving machine and sheaves shall be designed with a factor of safety, based on the static load (the structural capacity load plus the weight of the car, ropes, counterweight, etc) or not less than
- (a) 6 for steel, and
 - (b) 9 for cast iron and other materials.
- 14.3 The driving machine shall have electrically released brake applied automatically by springs in compression or by gravity when the power is removed from the motor.

15.0 Controllers and Operating Devices

- 15.1 A manually operated mains-disconnecting switch shall be installed in the main circuit cables of electric driving machine. This switch shall be visible readily accessible from the machine.
- 15.2 When metal-to-metal contacts are used in the controller switch for opening the main circuit or for stopping the driving machine, at least two independent current breaks shall be incorporated in the design. In the event of an earth fault or with any door open, the lift shall not work.
- 15.3 Operation of a spring or springs in tension or the completion of another electric circuit shall not be depended upon to break the circuit to stop the lift at terminal landings.
- 15.4 An interruption of the electrical circuit shall stop or prevent the movement of the car.
- 15.5 When the driving machine is operated by a polyphase ac motor, it shall be protected against phase reversal or failure.
- 15.6 No control system shall be used which depends on the completion or maintenance of an electrical circuit for the interruption of the power supply and the application of the electro-mechanical brakes when the lift car reaches the terminal floors.
- 15.7 The control circuits shall be fused or otherwise protection against faults or overloads, independently of the main circuit.
- 15.8 The voltage of any controller- operating circuit shall not exceed the low voltage as defined in IS 12360. The control circuits shall be suitably protected independently of the main circuit and they shall be so arranged that an earth fault or open circuit shall not create an unsafe condition.
- 15.9 Controller operate by hand ropes, levers or similar devices shall not be permitted.

16.0 Terminal Stopping and Final Limit Switches

- 16.1 A device shall be provided to remove power automatically from the motor and brake at the top and bottom terminals independently of the operation of the normal operating device. This device may be located in the machine room; in the car or in the lift well.

- 16.2 लिफ्ट में ड्रम प्रकार की चालन मशीन लगी होने पर इसके लिए मशॉन द्वारा प्रचालित अवरोधन सीमा स्विच भी लगी होनी चाहिए।
- 17.0 बिजली के तार लगाना और उपकरण
- 17.1 विद्युत संकर्षण लिफ्ट खंड - I में दिए गए उपबंध लागू होंगे।
- 18.0 मशीन कक्ष का स्थिति निर्धारण
- 18.1 विद्युत संकर्षण लिफ्ट खंड - I में दिए गए उपबंध लागू होंगे।
- 19.0 मशीन कक्ष
- 19.1 तलों को इस प्रकार डिजाइन किया जाएगा कि वे पूरे क्षेत्रफल पर 350 किग्रा/मी² से अधिक भार के साथ साथ मशीन कक्ष में प्रयुक्त उपस्कर द्वारा लगने वाले भार या सामान्य प्रचालन और मरम्मत की अवधि दोनों में ऐसे उपस्कर की प्रतिक्रिया द्वारा लगने वाले भार को सहन कर सके।
- 19.2 सेवा लिफ्ट कूप की पार्श्व दीवार कम से कम 7.5 सेमी० मोटी प्रवर्तित सीमेंट कंक्रीट की बनी होनी चाहिए जिसमें गाइडों को लगाने के लिए समुचित आधार प्राप्त हो सके।
- 19.3 मशीन कक्ष और लिफ्ट गर्त के लिए अधिगम प्रत्येक मशीन कक्ष के लिए सुरक्षित और सुविधाजनक अभिगम उपलब्ध कराया जाना चाहिए। लिफ्ट कूप से ऊपर वाले मशीन कक्ष के लिए अभिगम अन्तस्छद से या एक भीतरी सीढ़ी या उचित स्थिरण व्यवस्था वाली हटाने योग्य सीढ़ी से प्रदान किया जा सकता है।
- 20.0 अग्नि रक्षण
- 20.1 विद्युत संकर्षण लिफ्ट खंड - I में दिए गए प्रावधान लागू होंगे।
- 21.0 परीक्षण
- 21.1 इस विशिष्ट के खंड - IV में दर्शाए अनुसार परीक्षण किए जाएंगे।

16.2 When the lift is provided with drum type driving machine, it shall also have stopping limit switch operated by the machine.

17.0 **Electrical Wiring and Apparatus**

17.1 Provisions as indicated in Electric Traction lifts section I shall apply.

18.0 **Positioning of Machine Room**

18.1 Provisions as indicated in Electric Traction lifts section I shall apply.

19.0 **Machine Room**

19.1 Floors shall be designed to carry a load of not less than 350 kg/ sqm over the whole area and also any load which may be imposed thereon by the equipment used in the machine room or by any reaction from such equipment both during periods of normal operation and repair.

19.2 The side wall of the service lift well may be made of reinforced cement concrete at least 7.5 cm thick so as to provide satisfactory anchoring arrangement for the guides.

19.3 **Access to Machine Room and Lift Pits**

Safe and convenient access to every machine room shall be provided. Access to the machine room above a lift well may be either from the roof or by an internal staircase or by a removable ladder with a proper arrangement for fixing.

20.0 **Fire Protection**

20.1 Provisions as indicated in Electric Traction lifts section I shall apply.

21.0 **Testing**

21.1 Test shall be carried out as indicated in Section IV of this specifications.

खण्ड - IV

लिफ्ट अधिष्ठापनों का परीक्षण

सर्वोच्च न्यायालय के द्वारा एक अधिनियम का संशोधन :-

1974-75 अधिनियम सं. 10

1974-75 अधिनियम सं. 10

SECTION -IV

TESTING OF LIFT INSTALLATIONS

लिफ्ट अधिष्ठापनों का परीक्षण

The operation of the controllers and interlocks shall be examined and it shall be ascertained

1.0 स्थल पर परीक्षण

(क) समतलन परीक्षण

तल समतलन की पारेशुद्धता का परीक्षण लिफ्ट को खाली रखकर और पूर्णतः भरा रखकर किया जाएगा।

लिफ्ट को ऊपर और नीचे की ओर प्रत्येक के तल अवतरण से ऊपर / नीचे चलाया जाएगा तथा इसके कार की वास्तविक दूरी मापी जाएगी। प्रत्येक दशा में, जब कार खाली और पूर्णतः भरी हो, तलों पर समतलन के लिए इन मापों का अंतर अधिक नहीं होना चाहिए। समतलन की उपेक्ष्य त्रुटि अध्याय IV, खंड- I के पैरा 8 में यथा विनिर्दिष्ट होगी।

(ख) सुरक्षा गियर परीक्षण

गवर्नर (नियंत्रक) द्वारा नियंत्रित तात्क्षणिक सुरक्षा गियर का परीक्षण गवर्नर को हाथ से प्रचालित करके, अनुबंधित भार और अनुबंधित चाल पर किया जाना चाहिए। फन्नी (वैज) क्लैप या नम्य फ्लैप रक्षकों के साथ दो परीक्षण, एक कार में अनुबंध भार के साथ तथा दूसरा कार में 68 किग्रा भार (एक व्यक्ति के भार के समतुल्य) के साथ किए जाएंगे। प्राप्त अवरोधन दूरी की तुलना निर्धारित अंकों से की जाएगी तथा इसके पश्चात गाइडों, कार प्लेटफार्म और सुरक्षा गियरों की स्थाई विकृति के लिए सावधानी पूर्वक परीक्षा जाँच की जाएगी।

प्रतिभार सुरक्षा गियर को प्रतिभार नियंत्रक द्वारा और उल्लिखित अवरोधन दूरी पर ट्रिप होना चाहिए। परन्तु इस मामले में नियंत्रक ट्रिपिंग चाल कार सुरक्षा नियंत्रक की चाल से अधिक परन्तु 10% से अधिक नहीं होनी चाहिए।

सुरक्षा गियर परीक्षणों के दौरान कार की चाल का निर्धारण (नियंत्रक या मुख्य चरखी से) आई. एस. में यथा उल्लिखित तात्क्षणिक या ट्रिपिंग चाल पर किया जाना चाहिये। नियंत्रक के जबड़ों और रज्जु की जाँच किसी अनापेक्षित संघर्षण के लिए की जानी चाहिए।

(ग) अनुबंधित चाल (कान्ट्रैक्ट स्पीड)

इसे कार में अनुबंधित भार के साथ, आधे भार, बिना भार के साथ मापा जाना चाहिए और इसकी तथा अनुबंधित चाल का अंतर 10% से अधिक नहीं होना चाहिए। इसकी सरल विधि यह है कि चरखी या ड्रम पर खड़िया मिट्टी से निशान लगाकर ज्ञात समय में चरखी या ड्रम द्वारा किए गए चक्रों की संख्या की गिनती की जाए, परन्तु यह सावधानी बरतें कि त्वरण या मंदन की अवधियां इसमें शामिल न हों। यदि रज्जु बंधन 2:1 के अनुपात में हो तो चरखी की चाल कार के चाल की दोगुनी है। इसके अलावा चरखी के ठीक नीचे शैफ्ट में सीधे टैकोमीटर लगाकर चाल को मापा जा सकता है।

(घ) लिफ्ट संतुलन

उपर्युक्त परीक्षण के पश्चात कुछ भार को तब ही हटाया जाएगा जब तक शेष भार निविदाकार द्वारा निर्धारित अंकों तक न पहुँच जाए। इस शर्त के साथ कार द्वारा आधी दूरी तय कर लेने पर कुंडली पहिए की सहायता से किसी भी दिशा में कार को चलाने के लिए अपेक्षित प्रयास यथा संभव समान होना चाहिए तथा इसकी जाँच की जानी चाहिए।

(ड) कार और अवतरण दरवाजों के अंतः पाश (इंटर लॉक)

कोई दरवाजा खुला रखकर कोई कार चलने योग्य नहीं होनी चाहिए। कार दरवाजा रिले संपर्क और पश्चवर्ती मोचित्र कैम रीटायरिंग रिलीज कैम, का सुनिश्चित रूप से परीक्षण किया जाना चाहिए। दरवाजा प्रचालन, सुरक्षा कोरों और लाइट उपस्कर, यदि कोई हो के कार्यकरण की भी जाँच की जानी चाहिए।

TESTING OF LIFT INSTALLATION

Tests at site :

(a) **Levelling Test :**

Accuracy of the floor levelling shall be tested with the lift empty, fully loaded.

The lift shall be run to each floor while travelling both in upward and downward directions and the actual distance of car floor above/ below landing floor shall be measured. In each case there shall not be any appreciable difference in these measurements for levelling at the floors when the car is empty and when it is fully loaded. The tolerances for levelling shall be as specified in para 8 of chapter IV, section I.

(b) **Safety Gear Tests :**

Instantaneous safety gear controlled by a governor, should be tested with contract load and a contract speed, the governor being operated by hand. Two tests should be made, however, with wedge clamp or flexible clamp safeties, one with contract load in the car and the other with 68 kg (equivalent to one person) in the car. The stopping distance obtained should be compared with the specified figures and the guides, car platform, and safety gear should be carefully examined afterwards for signs of permanent distortion.

Counterweight safety gear should be tripped by the counter weight governor and the stopping distance noted. In this case, however the governor tripping speed should exceed that of the car safety governor but by not more than 10 percent.

During the safety gear tests, car speed (from the governor or the main sheave) should be determined at the instant or tripping speed with that stated in I.S. The governor jaws and rope should be examined for any undue wear.

(c) **Contract speed :**

This should be measured with contract load in the car, with half load with no load, and should not vary from the contract speed by more than 10 percent. The convenient method is by counting the number of revolutions, made by the sheave or drum in a known time, Chalk mark on the sheave or drum and a stop switch will facilitate timing but care must be exercised to ensure that no acceleration or retardation periods are included. If the roping is 2 to 1 the sheave speed is twice the car speed. Alternatively, the speed can be measured by a tachometer applied directly to shaft immediately below the sheave.

(d) **Lift balance :**

After the above test, some of the weight shall be removed until the remaining weights represent the figures specified by the tenderer. With this condition car at half way travel the effort required to move the lift car in either direction with the help of winding wheel shall be as nearly as can be judged by the same.

(e) **Car and landing doors interlocks:**

The lift shall not move with any door open. The car door relay contact and the retiring release cam must be tested. The workings of the door operation and the safety edges and light equipment if any provided shall also be examined.

(च) **नियंत्रक**

संपर्कों और अंतः पाशनों के प्रचालनों की भी जाँच की जानी चाहिए और यह सुनिश्चित किया जाना चाहिए कि विशिष्टियों में उल्लिखित सभी आवश्यकताएँ पूरी-हो-रही हैं या नहीं।

(छ) **सामान्य टर्मिनल अवरोधन स्विचें**

इनका परीक्षण प्रत्येक टर्मिनल अवतरण के लिए कार को, पहले भार सहित और इसके बाद अनुबंधित भार के साथ चलाकर उच्च और निम्न अधि यात्राओं की माप लेकर सुनिश्चित किया जा सकता है।

(ज) **अन्तिम टर्मिनल अवरोधन स्विच**

सामान्य टर्मिनल अवरोधन स्विचों को इस परीक्षण के लिए वियोजित किया जाएगा और यह सुनिश्चित किया जाएगा कि ये स्विचें बफर से संबंध होने से पहले ही प्रचालित हों।

(झ) **विद्युत रोधन प्रतिरोध**

इसे पॉवर और नियंत्रण लाइनों तथा भूसंपर्क के बीच (इलैक्ट्रॉनिक पी सी बी और इसके संयोजनों को हटाने के बाद) मापा जाता है और यह 500 वोल्ट की डी.सी. वोल्टता पर 5 मेगा ओम से कम नहीं होना चाहिए।

यह परीक्षण संयोजकों को एक साथ संयोजित करके इस प्रकार किया जाता है कि प्रत्येक परिपथ के सभी भागों का एक साथ परीक्षण सुनिश्चित किया जा सके।

(ञ) **भूसंपर्कन**

सभी कंड्यूट, स्विचें, केशिंग और इसी प्रकार के धातु कर्म सतत, भू-संपर्कित होने चाहिए।

(ट) **रज्जु**

रज्जुओं के आकार, संख्या निर्माण और बंधक की सावधानीपूर्वक जाँच और उन्हें रिकार्ड किया जाना चाहिए।

(ठ) **बफर**

कार या बफर की किसी स्थायी विकृति की जाँच के लिए कार को अपने बफर पर अनुबंधित चाल पर और अनुबंधित भार के साथ चलाया जाना चाहिए। इसी प्रकार प्रतिभार बफर का भी परीक्षण किया जाना चाहिए।

2.0 **विनिर्माणकर्ता के कार्यों पर परीक्षण :**

(क) **उच्च वोल्टता परीक्षण**

परावैद्युत (डाई इलैक्ट्रिक) या वैद्युत उपकरणों (मोटर, जनरेटर और ऐसे मापयंत्र जिनका उपयुक्त भारतीय मानक के अनुसार, जहाँ भी मौजूद हों, परीक्षण किए गए उपकरणों को छोड़कर) कार्यशील वोल्टता की दश गुणा परीक्षण वोल्टता, अधिकतम 2000 वोल्ट, सहन करने योग्य होने चाहिए।

(i) सभी परिपथ पूर्ण होने पर विद्युन्मय भागों और फ्रेम केश (ढांचा खोल) के बीच

(ii) सभी परिपथ खुले होने पर मुख्य टर्मिनलों या समतुल्य भागों के बीच, और

(iii) स्वतंत्र परिपथ के किन्हीं विद्युन्मय भागों के बीच

टिप्पणी : नियंत्रक में तार बिछाने का काम पूरा हो जाने के पश्चात् नियंत्रकों या इसके समरूप उपकरणों पर उपयुक्त (ii),

(iii) परीक्षण लागू करना अव्यवहारिक हो जाने के कारण इन परीक्षणों को विनिर्माण के सुविधाजनक चरण पर किया जाना चाहिए।

(ख) (i) **उच्च वोल्टता लागू करने की विधि :**

परीक्षण किसी सुविधाजनक प्रत्यावर्ती वोल्टता के साथ अधिमानतः 49 और 60 चक्र प्रति सेकेंड के बीच किया जाना चाहिए। परीक्षण वोल्टता लगभग sine (ज्या) तरंग स्वरूप की होगी और उच्चतम मान के साथ वोल्टता

(f) **Controllers :**

The operation of the contactors and interlocks shall be examined and it shall be ascertained whether all the requirements laid down in the specifications have been met.

(g) **Normal terminal stopping switches:**

These shall be tested by letting the car run to each terminal landing in turn, first with no load and then with contract load and by taking measurements, top and bottom over travels can be ascertained.

(h) **Final terminal stopping switches :**

The normal terminal stopping switches shall be disconnected for this test. It shall be ensured that these switches operate before the buffers are engaged.

(i) **Insulation Resistance :**

This shall be measured (after removing the electronic PCB's and their connection) between power and control lines and earth and shall not be less than 5 mega-ohms when measured with D.C. voltage of 500 volts. The test shall be carried out with contactors so connected together as to ensure that all parts of every circuit are simultaneously tested.

(j) **Earthing :**

All conduits, switches, casing and similar metal work shall have earthing continuity.

(k) **Ropes :**

The size, number construction and fastenings of the ropes should be carefully examined and recorded.

(l) **Buffers :**

The car should be run on to its buffers at contract speed and with contract load in the car to test whether there is any permanent distortion of the car or buffers. The counter weight buffers should be tested similarly.

2.0 Tests at Manufacturer's works :

(a) **High voltage test:**

The dielectric or electrical apparatus (excluding motors, generators and instruments which are tested in accordance with the appropriate Indian Standards wherever they exist) shall be capable of withstanding a test voltage of ten times the working voltage with a maximum of 2000 volts when applied.

(i) between the live parts and case of frame with all circuits completed.

(ii) between main terminals or equivalent parts with all circuits open, and

(iii) between any live parts of independent circuits.

Note: Owing to the impracticability of applying tests (ii), (iii) mentioned above on controllers and similar apparatus after controller wiring has been completed, these tests may be made at convenient stages of manufacture.

(b) (i) **Method of applying high voltage:**

The test shall be made with alternating voltage of any convenient frequency, preferably between 49 and 60 cycles per second. The test voltage shall be of approximately sine-

लगाने के दौरान, स्पार्क अंतराल ऑसिलोग्राफ द्वारा या किसी अन्य अनुमोदित विधि द्वारा यथा निर्धारित, आर एम एस मान के 1.45 गुना से अधिक नहीं होना चाहिए। लगायी गई वोल्टता के आर एम एस मान की माप वोल्टमीटर के माध्यम से उचित प्रकार से अंशांकित विभव (पोर्टेशियल) ट्रांसफार्मर का उपयोग करके या वोल्टमीटर के माध्यम से विशेष अंशांकित वोल्टमीटर वाइडिंग (लपेटन) के साथ संयोजित करके या अन्य उपयुक्त वोल्टमीटर द्वारा परीक्षण ट्रांसफार्मर के बाहर की ओर संयोजित करके की जाएगी।

(ii) उच्च वोल्टता परीक्षण की अवधि

परीक्षण वोल्टता के एक-तिहाई वोल्टता पर परीक्षण प्रारम्भ किया जाएगा तथा मापयंत्र द्वारा निरंतर पूर्ण परीक्षण वोल्टता दर्शाते ही इसे बढ़ा दिया जाएगा। पूर्ण परीक्षण वोल्टता एक मिनट के लिए बनायी रखी जाएगी। इस अवधि के अंत में इसे बंद करने से पूर्व परीक्षण वोल्टता को तीव्रतापूर्वक घटाकर एक तिहाई कर दिया जाएगा।

उपर्युक्त परीक्षणों के पश्चात यह सुनिश्चित करने के लिए तेल बफर की परीक्षा तेल रिसाव या विकृति की जाँच के लिए की जाती है ताकि यह सुनिश्चित किया जा सके कि बफर अपनी सामान्य स्थिति में वापस आ गए हैं।

(ग) बफर परीक्षण

परीक्षण रिपोर्ट की एक प्रति कार्य पर परीक्षण के पश्चात सूचनार्थ भेजी जाएगी।

3.0 निष्पादन परीक्षण

यह परीक्षण यात्री लिफ्टों के लिए उद्दिष्ट है और लिफ्ट अधिष्ठापन की निगरानी के अंतर्गत यात्री संभलाई क्षमता और यथा प्राप्त प्रतीक्षा अंतराल के साथ-साथ डिजाइन, डाटा की जाँच निम्नानुसार की जाती है :

(i) प्रतीक्षा अंतराल : (T) - इसे अनेक चक्र में लगे समय को उस बैंक की लिफ्टों की संख्या से भाग देकर औसत निकाल कर, इसकी गणना की जा सकती है।

(ii) संभलाई क्षमता

$$H = \frac{300 \times Q \times 100}{T \times P}$$

जहाँ

H = 5 मिनट में संभाली गई अधिकतम जनसंख्या के प्रतिशत के रूप में संभलाई क्षमता

P = सुबह के व्यस्ततम समय में संभाली गयी कुल जनसंख्या (यह लिफ्ट के विशेष बैंक क्षेत्र से संबंधित है)

Q = कार में वहन किए गए यात्रियों की औसत संख्या

T = प्रतीक्षा अंतराल

(iii) सेवा तापक्रम परीक्षण

अनुमानित ड्यूटी सेवा में यथा व्यावहारिक चालू या बंद करने की संख्या को पुनर्जीवित करने के लिए निरंतर एक घंटे तक चलाया जाएगा। (मानक ड्यूटी चक्र प्रति घंटे 90 से 180 तक चालू करने का है)। व्यावहारिक रूप में पूर्ण भार और बिना भार के प्रत्यावर्ती रूप से चालू करते हुए इस परीक्षण को करना अधिक कठिन है अतः यह आवश्यक है कि इन चक्रों को सिमुलेट (अनुक्रमानुसार) किया जाए। अनुबंधित भार के साथ निम्न अवतरण से कार को ऊपर की ओर चलाने तथा प्रत्येक तल पर रोकने के लिए सभी मोटरों का, पिंजर मोटरों को छोड़कर, उचित परीक्षण किया जाएगा। शीर्ष तल से निम्नतम तल की बिना रुके यात्रा की जाएगी और इसके पश्चात ऊपर की ओर रुकते हुए यात्रा की जाएगी और इस प्रक्रिया को दोहराया जाएगा। तलों पर रुकने और चालू होने का अंतराल समान होना चाहिए और यह इस प्रकार होना चाहिए कि एक घंटे में 150 बार चालू किया जा सके। इस चालन के अंत में आर्मेचर और मोटर तथा जनरेटर क्षेत्रों के तापक्रमों को मापा जाएगा। तापक्रम में वृद्धि ए या बी प्रकार के विद्युत रोधनों के लिए क्रमशः 55° से. या 75° से. से अधिक नहीं होनी चाहिए।

wave form and during the application of voltage with peak value, as would be determined by spark gap by oscillograph or by any other approved method shall not be more than 1.45 times the rms value. The rms values of the applied voltage shall be measured by means of a volt meter used with a suitably calibrated potential transformer or by means of voltmeter used in connection with a special calibrated voltmeter winding or testing transformer by any other suitable voltmeter connected to the output side of the testing transformer.

(ii) **Duration of high voltage test:**

The test shall be commenced at a voltage of about one third of the test voltage which shall be increased to the full test voltage as rapidly as is consistent with the value being indicated by the measuring instrument. The full test voltage shall be maintained for one minute. At the end of this period, the test voltage shall be rapidly diminished to one third of its full value before switching off.

The oil buffers are examined after the above tests have been made to determine if there has been any oil leakage or distortion and to ensure that the buffers return to their normal positions.

(c) **Buffer test :**

A copy of the test report shall be intimated after testing at works.

3.0 **Performance Test :**

This test is meant for passenger lifts and is conducted to watch the performance of lift installation in terms of passenger handling capacity and waiting interval as obtained at site vis-à-vis design, data and conducted as below:

(i) Waiting interval : (T)- This can be worked out by taking the average of several round trip times as observed physically and then dividing it by the number of lifts in that bank.

(ii) Handling capacity $H = \frac{300 \times \bar{Q} \times 100}{T \times P}$

Where

H= Handling capacity as the percentage of the peak population handled during 5 minutes.

P= Total population to be handled during peak morning period. (It is related to the area for which particular bank of lifts serves).

Q= Average number of passenger carried in a car.

T= Waiting interval.

(iii) **Service temperature Test :**

A continuous run of one hour should be made with number of starts and stops to reproduce as nearly as practical the anticipated duty in service. (The standard duty cycle is for 90 to 180 start per hour). It is very difficult in practice to carry out this test with alternate starts at full load and no load and it is necessary therefore to simulate these cycles. A suitable test for all motors except squirrel cage motors is to run the car up from the bottom landing with contract load and stop at each floor. From the top floor a non stop run is made to the lowest floor and the upward journey with stop is then repeated. The time intervals between stops and starts at the floors should be uniform and such as to give about 150 starts in one hour. At the end of this run the temperatures of the armatures and fields of the motor and generator are recorded. The temperature rise should, not exceed 55 deg C or 75 deg C for classes A or B insulation respectively.

खण्ड - V

एस्कलेटर (चल सोपान)

किसी कार्य के अन्तर्गत प्रयोज्य कर्मियों के नामों का नामावली, जो कि सुनिश्चित किया जाता है कि
विद्यमान में कार्य के अन्तर्गत कर्मियों के नामों का नामावली जारी की जायेगी।

SECTION -V
ESCALATORS

1.0 शब्दावली

- 1.1 **एस्कलेटर (चल सोपान) :** यात्रियों को ऊपर बढ़ाने या नीचे उतारने के लिए प्रयुक्त पावर चालित आनित सीढ़ी मार्ग (स्टेयरवे)
- 1.1.1 **एस्कलेटर अधिष्ठापन :** इसमें एस्कलेटर, इसके ट्रैक, कैंचियां या गर्डर, बलयालंबन, सोपान न्यास (स्टेप एण्ड ट्रेडस) और अवतरण तथा एस्कलेटर के प्रचालन से सीधे संबंधित सभी चैन, तार और सयंत्र शामिल हैं।
- 1.1.2 **एस्कलेटर मशीन -** एस्कलेटर को चलाने के लिए इससे संबंधित यंत्रावली और अन्य उपस्कर।
- 1.2 **वलयालम्ब -** ऊपर कृत तथा नीचे उभरा हुआ एक छोटा स्तम्भ।
- 1.2.1 **वलयालम्ब जंगला -** सचल हस्तरेलों (हैंडरेल) को टेक देने के लिए उददिष्ट वलयालम्बों की एक पंक्ति।
- 1.3 **दाँतेदार प्लेट (क्रॉम्बप्लेट) -** दाँतेदार प्लेट एस्कलेटर अवतरण का एक भाग है और यह यात्रा की समाप्ति पर सोपान क्लीट (स्टेप क्लीट) के साथ जुड़ जाती है।
- 1.4 **आपातकालीन स्टॉप पुश या स्विच -** एस्कलेटर मशीन के परिपथ को वियोजित करने और पॉवर पूर्ति बंद करने के लिए डिजाइन की गयी दाब पुश बटन या स्विच ताकि एस्कलेटर रुक जाए।
- 1.5 **अवतरण -** भवन या संरचना का वह हिस्सा जिसका उपयोग एस्कलेटर पर यात्रियों को चढ़ाने या उस पर से उतारने के लिए किया जाता है।
- 1.6 **यात्रा (उठान) -** किसी एस्कलेटर के निम्न टर्मिनल अवतरण और उच्च टर्मिनल अवतरण के बीच की ऊर्ध्वाधर दूरी।
- 1.7 **अतिचाल नियंत्रक (ओवर स्पीड गवर्नर) -** एक ऐसी स्वचालित युक्ति जिसके कारण एस्कलेटर की चाल सामान्य प्रचालन चाल के पूर्व निर्धारित मान से अधिक हो जाने पर पॉवर पूर्ति बाधित हो जाती है।
- 1.8 **निर्धारित भार -** वह भार जिसके लिए निर्धारित चाल पर उत्पापन के लिए एस्कलेटर को डिजाइन और अधिष्ठापित किया गया है।
- 1.9 **निर्धारित चाल -** वह चाल जिस पर प्रचालित होने के लिए एस्कलेटर को डिजाइन किया गया है। यह, सोपान या कैरिज पर निर्धारित भार के साथ उन्नयन कोण के साथ मापित, सोपान यात्रा की दर है।
- 2.0 **एस्कलेटरों का निर्माण, अधिष्ठापन, रक्षण, प्रचालन और अनुरक्षण**
- 2.1 **प्रत्येक एस्कलेटर और इसका प्रत्येक भाग मजबूत सामग्री और अच्छे निर्माण तथा पर्याप्त यांत्रिक सामर्थ्य का होना चाहिए ताकि वह आशयित उद्देश्य को पूरा कर सके और यथा व्यवहारिक इससे इस प्रकार अधिष्ठापित, रक्षित, कृत और अनुरक्षित किया जाना चाहिए कि किसी प्रकार के खतरे से बचा जा सके।**
- 2.2 **सभी सामग्रियां नवीनतम भारत मानक की विशिष्टियों, जहां भी उपलब्ध हों, के अनुरूप होनी चाहिए।**
- 3.0 **निर्माण की आवश्यकताएं**
- 3.1 **उन्नयन कोण -** यह क्षैतिज से 30° से अधिक नहीं होना चाहिए तथा 6 मीटर से कम ऊर्ध्वाधर उत्थान वाले एस्कलेटर के मामले में 35° तक की अनुमति प्रदान की जा सकती है।

1.0 Terminology

- 1.1 **Escalator** – A power driven, inclined, continuous stairway used for raising or lowering passengers.
- 1.1.1 **Escalator Installation** – It includes the escalator, the track, the trusses or girders, the balustrading, the step-treads and landings and all chains, wires and plant directly connected with the operation of the escalator.
- 1.1.2 **Escalator Machine** – the mechanism and other equipment in connection therewith used for moving the escalator.
- 1.2 **Baluster** – A short pillar slender above and bulging below.
- 1.2.1 **Balustrade** – A row of balusters meant for supporting moving handrails.
- 1.3 **Combplate** – A pronged plate that forms part of an escalator landing and engages with the cleats of the steps at the limits of travel.
- 1.4 **Emergency Stop Push or Switch** – A push-button or switch designed to open a circuit and cut off power supply to the escalator machine so as to cause the escalator to stop.
- 1.5 **Landing** -The portion of the building or structure which is used to receive or discharge passengers into or from an escalator.
- 1.6 **Travel (Rise)** – The vertical distance between the bottom terminal landing and the top terminal landing of an escalator.
- 1.7 **Overspeed Governor**– An automatic device which causes the power supply to the escalator to be interrupted in the event of the speed exceeding the predetermined value of the normal running speed.
- 1.8 **Rated Load** – The load at which the escalator is designed and installed to lift at the rated speed.
- 1.9 **Rated Speed** – The speed at which the escalator is designed to operate. It is the rate of travel of the steps, measured along the angle of inclination, with rated load on the steps or carriage.
- 2.0 **Construction, Installation, Protection, Operation and Maintenance of Escalators**
- 2.1 Every escalator and every part thereof shall be of sound material and good construction and of sufficient mechanical strength for the purpose for which it is intended and so far as is practicable, shall be installed, protected, worked and maintained in such a manner so as to prevent danger.
- 2.2 All materials shall be in accordance with the latest Indian Standard specifications wherever available.
- 3.0 **Construction Requirements**
- 3.1 **Angle of Inclination** – It shall not be in excess of 30 degrees from the horizontal excepting that with an escalator having a vertical rise not exceeding 6 metres an angle up to 35 degrees may be permitted.

- 3.2 चौड़ाई - वलयालंब जंगलों के बीच की चौड़ाई की माप नासिका सोपान लाईन के ठीक ऊपर 68.5 से०मी० के उन्नत बिंदु पर ली जायेगी और यह सोपान की चौड़ाई से कम नहीं होनी चाहिए। यह सोपान से 33 से०मी० से अधिक, एस्कलेटर के दोनों ओर 16.5 से०मी० अधिकतम, नहीं होना चाहिए।
- 3.3 वलयालंबन - एस्कलेटरों के दोनों ओर ठोस वलयालंबन प्रदान किया जाना चाहिए। सोपान के पार्श्व पर वलयालंबन चिकना तथा पर्याप्त स्पष्ट होना चाहिए परन्तु सोपान चाल (रन) के समान्तर रक्षक ढलाई उचित साहुल के भीतर तथा इसकी ऊंचाई, जो कि जोड़ों को कवर करेगी, 6.5 मिमी० से अधिक नहीं होनी चाहिए।
- 3.3.1 वलयालंबन जंगलों में कांच का उपयोग - आई० एस० 2553 - 1964 की पुष्टि के बिना कांच के पैनलों का उपयोग नहीं किया जायेगा।
- 3.3.2 वलयालंबन जंगलों के बीच की चौड़ाई में परिवर्तन - एस्कलेटर के दोनों ओर के वलयालंबन जंगलों की बीच की चौड़ाई में कोई अचानक परिवर्तन नहीं किया जाना चाहिए। परन्तु चौड़ाई में परिवर्तन अपरिहार्य होने पर यह परिवर्तन अधिकतम चौड़ाई के 8 प्रतिशत से अधिक नहीं होना चाहिए। अधिकतम अनुमेय वलयालंबन कोण परिवर्तन के कारण चौड़ाई में कमी के परिणामस्वरूप वलयालंबन जंगलों की दिशा में परिवर्तन एस्कलेटर की यात्रा की रेखा से 15° से अधिक नहीं होना चाहिए।
- 3.3.3 वलयालंबन जंगलों और सोपानों के बीच का अवकाश - सोपान के दोनों ओर सोपान और आसन्न स्कर्ट गार्ड के बीच का अवकाश 5 मि०मी० से अधिक नहीं होना चाहिए और दोनों ओर के अवकाशों का योग 6 मि०मी० से अधिक नहीं होना चाहिए।
- 3.3.4 अंतस्छद्द प्रतिच्छेद गार्ड - उन स्थानों के अलावा जहां बाह्य वलयालंबन (डेक-बोर्ड) और अंतस्छद्द या निचली सतह का प्रतिच्छेद हस्त रेल की मध्य रेखा से 60 से०मी० से अधिक हो बाह्य वलयालंबन (डेक-बोर्ड) और अंतस्छद्द या निचली स्तह के प्रतिच्छेदन कोण में ठोस गार्ड लगाया जाना चाहिए।
- गार्ड का उर्ध्वाधर पृष्ठ कोण के शीर्ष से क्षैतिज रूप से कम से कम 36 से०मी० प्रक्षेपित होना चाहिए। कर्तन खतरे को समाप्त करने के लिए गार्ड के बाहरी सिरे को गोल किया जाना चाहिए। गार्ड भंजन रोधी कांच के हो सकते हैं।
- 3.4 हस्तरेल (हैंडरेल)
- 3.4.1 प्रत्येक वलयालंबन जंगले के साथ हस्तरेलें प्रदान की जानी चाहिए जो उसी दिशा में तथा सोपानों की समान गति से गतिशील हों।
- 3.4.2 दांतेदार प्लेटों से आगे विस्तार - प्रत्येक हस्तरेल सामान्य हस्तरेल की ऊंचाई तक विस्तारित तथा उच्च और निम्न अवतरणों पर दांतेदार प्लेट के दांतों के बिंदुक रेखा से आगे 30 सेमी० से कम नहीं होना चाहिए।
- 3.4.3 गार्ड - उस बिंदु पर हाथ या अंगुलि गार्ड प्रदान किया जाना चाहिए जहां हस्तरेल (वलयालंबन जंगले) में प्रवेश करती हो।
- 3.4.4 हस्तरेलों के बीच की दूरी - दो हस्तरेलों की मध्य रेखाओं के बीच की क्षैतिज दूरी, जो कि उन्नत दशा में मापी जाती है, वलयालंबन जंगलों के बीच की चौड़ाई से 15 सेमी० से अधिक नहीं होना चाहिए और यह एस्कलेटर के दोनों ओर अधिकतम 7.5 सेमी० तक हो सकती है।

Width – The width between balustrades shall be measured on the incline at a point 68.5 cm vertically above the nose line of the steps, and shall not be less than the width of the step. It shall not exceed the width of the step by more than 33 cm with a maximum of 16.5 cm on either side of the escalator.

Balustrading – Escalators shall be provided on each side with solid balustrading. On the step side the balustrading shall be smooth and substantially flush except for protective mouldings parallel to the run of the steps and properly bevelled vertical mouldings projecting not more than 6.5mm, that cover joints of panels.

Use of Glass in Balustrades – Glass panels shall not be used unless they conform to IS: 2553-1964.

Change in Width Between Balustrades – There shall be no abrupt changes in the width between the balustrading on the two sides of the escalator. Where a change in width is unavoidable, such change shall not exceed 8 percent of the greatest width. In changing the direction of the balustrading resulting from a reduction in width the maximum allowable angle of change in the balustrading shall not exceed 15 degrees from the line of the escalator travel.

Clearance Between Balustrades and Steps – The clearance on either side of the steps between the steps and the adjacent skirt guard shall be not more than 5mm and the sum of the clearances on both sides shall be not more than 6mm.

Guards at Ceiling Intersection – A solid guard shall be provided in the intersecting angle of the outside balustrade (deck board) and the ceiling or soffitt except where the intersection of the outside balustrade (deck board) and the ceiling or soffitt is more than 60 cm from the centre line of the handrail.

The vertical face of the guard shall project at least 36 cm horizontally from the apex of the angle.

The exposed edge of the guard shall be rounded to eliminate shear hazard. Guards may be shatterproof glass.

3.4 Handrails

Each balustrade shall be provided with a handrails moving in the same direction and at substantially the same speed as the steps.

Extension Beyond combplates – Each moving handrails shall extend at normal handrail height not less than 30 cm beyond the line of points of the combplate teeth at the upper and lower landings.

Guards – Hand or finger guards shall be provided at the point where the handrail enters the balustrade.

Distance Between Handrails – The horizontal distance between the centre lines of the two handrails, measured on the incline, shall not exceed the width between the balustrades (see 3.2) by more than 15 cm, with a maximum of 7.5 cm on either side of the escalator.

3.5 सोपान पद न्यास

3.5.1 सामाग्रियां और इनका प्रकार - सोपान फ्रेम अदहनशील सामग्री का बनाया जाएगा। सोपान न्यास क्षैतिज तथा अदाह्य सामग्री द्वारा निर्मित होगा तथा सुरक्षित फुट होल्ड (पाद स्थिरक) प्रदान करेगा।

3.5.2 सोपानों की विभाएं - यात्रा की दिशा में किसी सोपान पद न्यास की गहराई 40 सेमी० से कम नहीं होनी चाहिए तथा पद न्यासों के बीच का उभार 22 सेमी० से अधिक नहीं होना चाहिए। सोपान पद न्यास की चौड़ाई 40 सेमी० से कम तथा 102 सेमी० से अधिक नहीं होनी चाहिए।

3.5.3 सोपानों के बीच का अवकाश - सोपान पद न्यासों के बीच का अधिकतम अवकाश क्षैतिज चलन पर 4 मिमी० होना चाहिए।

3.5.4 सोपान पद न्यास में खांचे बनाना - प्रत्येक सोपान के न्यास पृष्ठ पर सोपानों की यात्रा की समान्तर दिशा में खांचे बनाए जाएंगे। प्रत्येक खांचा 6.5 मिमी० से अधिक चौड़ा तथा 9.5 मिमी० से कम गहरा नहीं होना चाहिए; तथा एक खांचे के केन्द्र से दूसरे खांचे के केन्द्र तक की दूरी 9.5 मिमी० से अधिक नहीं होनी चाहिए।

3.6 अवतरण

3.6.1 अवतरणों की सामग्री और डिजाइन इस प्रकार की होनी चाहिए कि फुटहोल्ड को सुरक्षित किया जा सके।

3.6.2 यदि अवतरण कंक्रीट का हो तो इसके कोर पर धातु, काष्ठ या सरकवां रोधी सामग्री लगायी जानी चाहिए।

3.7 दांतेदार प्लेट

3.7.1 प्रत्येक एस्कलेटर के प्रवेश और निकास पर दांतेदार प्लेटें लगायी जानी चाहिए।

3.7.2 दांतेदार प्लेट की डिजाइन - दांतेदार प्लेट के दांत पद-न्यास पृष्ठ से इस प्रकार अंतर्योजित तथा खांचों में सेट होने चाहिए कि दांतों के नोक सदैव पद न्यासों के ऊपरी पृष्ठ से नीचे हों।
दांतेदार प्लेटें ऊर्ध्वाधरतः समायोजन योग्य होनी चाहिए।

3.8 कैचियां या गर्डर

3.8.1 कैचियों या गर्डर को इस प्रकार डिजाइन किया जाएगा कि वे सोपानों तथा प्रचालित सचल गियर को सुरक्षित रूप से सहन कर सकें। ट्रेक प्रणाली के विफल हो जाने पर ये सचल गियरों को उनके गाइडों में रोके रखें।

3.8.2 उन स्थानों पर जहां कषण मुक्ति तनन भारों के माध्यम से प्रचालित हो, वहां इन भारों को यदि उन्हें मुक्त किया जाता है, कैची में रोकने की व्यवस्था की जाती है।

3.9 सोपान पहिया ट्रेक

3.9.1 सोपान पहिया ट्रेक को इस प्रकार डिजाइन किया जाता है कि यदि सोपान चैन टूट जाए तो सोपान और सचल गियर के विस्थापन को रोका जा सके।

3.10 निर्धारित भार

3.10.1 किसी एस्कलेटर पर किलोग्राम में निर्धारित भार की गणना निम्नलिखित सूत्र से की जा सकती है :

$$\text{निर्धारित भार } 2.7 = W. A.$$

जहां W = वलयालंब जंगलों के बीच की चौड़ाई (सेमी० में), तथा

A = दांतेदार प्लेट के ऊपरी और निचले दांतों के बीच की क्षैतिज दूरी (मीटर में) है।

3.11 एस्कलेटर की निर्धारित चाल 38 मीटर प्रति मिनट से अधिक नहीं होनी चाहिए।

3.5 Steps Treads

- 3.5.1 *Materials and Type* – Step frames shall be made of incombustible material. Step treads shall be horizontal and made of incombustible material and shall afford a secure foothold.
- 3.5.2 *Dimensions of Steps* – The depth of any step tread in the direction of travel shall be not less than 40 cm and the rise between treads shall be not more than 22 cm. The width of a step tread shall be not less than 40 cm nor more than 102 cm.
- 3.5.3 *Clearance Between Steps* – The maximum clearance between step treads on the horizontal run shall be 4 mm.
- 3.5.4 *Slotting of step Treads*- The tread surface of each step shall be slotted in a direction parallel to the travel of the steps. Each slot shall be not more than 6.5 mm wide and not less than 9.5mm deep; and the distance from centre to centre of adjoining slots shall be not more than 9.5 mm.

3.6 Landings

- 3.6.1 Landings shall be of material and design affording secure foothold.
- 3.6.2 If the landing is of concrete, it shall have edge insertions of metal, wood or other antislip material.

3.7 Combplates

- 3.7.1 There shall be a combplate at the entrance and at the exit of every escalator.
- 3.7.2 *Design of combplates*- The combplate teeth shall be meshed with and set into the slots in the tread surface so that the points of the teeth are always below the upper surface of the treads. Combplates shall be adjustable vertically.

3.8 Trusses or Girders

- 3.8.1 The truss or girder shall be designed to safely sustain the steps and running gear in operation. In the event of failure of the track system it shall retain the running gear in its guides.
- 3.8.2 Where tightening devices are operated by means of tension weights, provision shall be made to retain these weights in the truss if they should be released.

3.9 Step Wheel Tracks

- 3.9.1 Step wheel tracks shall be so designed as to prevent displacement of the steps and running gear if a step chain breaks.

3.10 Rated Load

- 3.10.1 The rated load in kilograms on an escalator shall be computed by the following formula :

$$\text{Rated Load} = 2.7 WA$$

Where W = the width in cm between the balustrades , and

A = the horizontal distance between the upper and lower combplate teeth in metres.

- 3.11 The rated speed of the escalator shall not be more than 38 metres per minute.

- 3.12 डिजाइन सुरक्षा गुणांक
- 3.12.1 स्थैतिक भार पर आधारित सुरक्षा गुणांक कम से कम निम्नलिखित होने चाहियें :
- (क) ट्रेक सहित कैचियों और सभी सरचनात्मक सदस्यों के लिए - पाँच (5)
- (ख) चालन मशीन के पुर्जों के लिए
- (1) इस्पात या काँसे द्वारा निर्मित - आठ (8)
- (2) ढलवाँ लोहा या अन्य सामग्रियों से निर्मित - दस (10)
- (ग) पॉवर - संप्रेषण घटकों के लिए - दस (10)
- ढलवाँ - इस्पात कड़ियों वाली स्टेप चेन, यदि अच्छी प्रकार अनीलित हो तो, के लिए कम से कम बीस (20) सुरक्षा गुणांक की अनुमति दी जाएगी।
- 4.0 चालन मशीन, मोटर और ब्रेक
- 4.1 चालन मशीन और मुख्य चालन शैफ्ट के बीच का संयोजन - चालन मशीन को मुख्य चालन शैफ्ट से दौंतेदार गियरिंग, कपलिंग या चेन द्वारा संयोजित किया जाएगा।
- 4.2 चालन मोटर - एक विद्युत मोटर को एक से अधिक एस्कलेटर नहीं चलाना चाहिए।
- 4.3 ब्रेक - प्रत्येक एस्कलेटर में विद्युत रूप से मोचक तथा यांत्रिक रूप से लगाए जाने वाले ऐसे ब्रेक प्रदान किए जाने चाहिए कि इसे निर्धारित भार तक किसी भार के साथ ऊपर या नीचे की ओर गतिशील एस्कलेटर को रोकने में समर्थ हो। यह ब्रेक या तो चालन मशीन पर या मुख्य चालन शैफ्ट पर अधिष्ठापित किया जा सकता है। उस स्थान पर जहाँ चालन मशीन को मुख्य चालन शैफ्ट से जोड़ने के लिए चेन का प्रयोग किया जाए वहाँ इस शैफ्ट पर ब्रेक लगाया जाना चाहिए। यदि चालन मशीन पर विद्युत रूप से मोचक ब्रेक प्रदान किया गया हो तो इस ब्रेक का विद्युत रूप से मोचक प्रकार का होना आवश्यक नहीं है।
- 5.0 प्रचालन और सुरक्षा युक्तियां
- निम्नलिखित आवश्यकताओं की पूर्ति करने वाली प्रचालन और सुरक्षा युक्तियां प्रदान की जाएंगी।
- 5.1 प्रवर्तन स्विच - प्रवर्तन स्विचें कुंजी प्रचालित प्रकार की तथा एस्कलेटर सोपान दर्श के भीतर अवस्थित होना चाहिए।
- 5.1.1 प्रवर्तन स्विचें जनता की पहुंच के भीतर होने पर वे या तो कुंजी प्रचालित प्रकार की या ताला-चाबी युक्त बॉक्स में बंद होनी चाहिए।
- 5.2 आपातकालीन स्टॉप बटन - आपातकालीन स्टॉप बटन या हस्तचालित अन्य प्रकार की स्विचें लाल बटन या हथिये वाली हो सकती हैं और इस पर स्पष्ट स्टॉप पुश या स्टॉप स्विच निशान लगा होना चाहिए और यह प्रत्येक एस्कलेटर के उच्च और निम्न अवतरणों पर या इसके निकट अवस्थित होना चाहिए, और संरक्षित होना चाहिए ताकि इसे दुर्घटना बसने पर प्रचालित किया जा सके। अपाशित ऐसी कवर युक्त एस्कलेटर स्टॉप बटन, जिसे सरलता पूर्वक उठाया या बगल में दबाया जा सकता है, को अभिगम्य समझा जाएगा। इन बटनों या स्विचों के प्रचालन से चालन मशीन की पॉवर बाधित हो जाएगी। इन बटनों या स्विचों द्वारा चालन मशीन को चालू करना संभव नहीं होगा।
- 5.3 चाल नियंत्रक (स्पीड गर्वनर) - एक ऐसा चाल नियंत्रक प्रदान किया जाएगा जिसके प्रचालन से चालन मशीन की पॉवर बाधित हो जाएगी और इससे सोपान की चाल पूर्व निर्धारित मान तक बढ़ जाएगी। यह चाल निर्धारित चाल से 40 प्रतिशत से अधिक नहीं होनी चाहिए।
- अपवाद: निम्न स्लिप प्रत्याघर्ती धारा पिंजर मोटर का उपयोग किए जाने पर तथा मोटर को सीधे चालन मशीन से संयोजित होने पर अति चाल नियंत्रक आवश्यक नहीं होता है।

2. **Design Factors of Safety**

2.1 The factors of safety, based on the static loads, shall be at least the following :

- (a) For trusses and all structural members including tracks -five (5);
- (b) For driving machine parts :
 - (1) where made of steel or bronze- eight (8);
 - (2) where made of cast iron or other materials – ten (10);
- (c) For power-transmission members –ten (10).

Step chains composed of cast-steel links which , if thoroughly annealed, shall be permitted with a factor of safety of at least twenty (20).

4.0 **Driving Machine, Motor and Brake**

4.1 **Connection Between Driving Machine and Main Drive Shaft** – The driving machine shall be connected to the main drive shaft by toothed gearing, a coupling, or a chain.

4.2 **Driving Motor** – An electric motor shall not drive more than one escalator.

4.3 **Brake** – Each escalator shall be provided with an electrically released, mechanically applied brake capable of stopping the up or down travelling escalator with any load up to rated load. This brake shall be located either on the driving machine or on the main drive shaft.

Where a chain is used to connect the driving machine to the main drive shaft, a brake shall be provided on this shaft. It is not required that this brake be of the electrically released type if an electrically released brake is provided on the driving machine.

5.0 **Operating and Safety Devices**

Operating and safety devices shall be provided conforming to the following requirements.

5.1 **Starting Switch** – Starting switches shall be of the key-operated type and shall be located within sight of the escalator steps.

5.1.1 Where starting pushes or switches are within reach of the public they shall be either of the key-operated type or be enclosed in a box provided with a lock and key.

5.2 **Emergency Stop Buttons** – Emergency stop buttons or other type of manually operated switches having red buttons or handles and conspicuously marked STOP PUSH or STOP SWITCH shall be accessibly located at or near the top, and bottom landings of each escalator, and shall be protected against accidental operation. An escalator stop button with an unlocked cover over which it can readily be lifted or pushed aside shall be considered accessible. The operation of either of these buttons or switches shall interrupt the power to the driving machine. It shall not be possible to start the driving machine by these buttons or switches.

5.3 **Speed Governor** – A speed governor shall be provided, the operation of which shall cause the interruption of power to the driving machine should the speed of the steps exceed a predetermined value which shall be not more than 40 percent above the rated speed.

Exception : The over speed governor is not required where a low slip alternating current squirrel cage induction motor is used and the motor is directly connected to the driving machine.

- 5.4 **भंजित सोपान - चैन (स्टेप चैन) युक्ति** - एक ऐसी भंजित सोपान चैन युक्ति प्रदान की जानी चाहिए जो सोपान-चैन टूटने पर और; वहां जहां स्वचालित चैन तनन युक्ति प्रदान नहीं की गयी है। किसी भी सोपान चैन में अत्यधिक सोल उत्पन्न होने पर चालन मशीन के लिए पॉवर को बाधित कर दे।
- 5.5 **भंजित चालन - चैन - युक्ति** - वहां जहां चालन मशीन चैन के माध्यम से मुख्य चालन शैफ्ट से संयोजित हो, एक ऐसी युक्ति प्रदान की जाएगी जिसके कारण, चालन - चैन विभाजित होने पर, मुख्य चालन शैफ्ट पर ब्रेक लगाया जा सके।
- 5.6 **मशीनरी अवकाशों में स्टॉप स्विच** - ऐसे प्रत्येक मशीनरी अवकाश में, जहां अभिगम के साधन उपलब्ध हैं, स्टॉप स्विच उपलब्ध की जानी चाहिए। इस स्विच के खुलने के कारण एस्कलेटर चालन मशीन मोटर और ब्रेक से विद्युत पॉवर हट जाएगी। स्टॉप स्विच -
 (क) हाथ से खुलने योग्य और बंद प्रकार की;
 (ख) स्पष्टतः और स्थाई रूप से 'स्टॉप' (Stop) चिन्हित; और
 (ग) यांत्रिक रूप से सुनिश्चित खुली तथा उनके मुख मात्र स्प्रिंग पर निर्भर नहीं होने चाहिए।
- 5.7 **विद्युत मोचित ब्रेक का प्रयोग** - कोई भी युक्ति 5.2 और 5.5 फलन द्वारा आवश्यक होने पर विद्युत मोचित ब्रेक एस्कलेटर को स्वतः रोक देगा।
- 6.0 **मशीन कक्ष**
- 6.1 **एस्कलेटर मशीन या मशीनों, और उससे संबंधित उपकरणों और उपस्करों के वेशन के लिए उचित आकार और निर्माण का मशीन कक्ष प्रदान किया जाना चाहिए।**
- 6.2 **अभिगम**
- 6.2.1 **मशीन कक्ष को इस प्रकार व्यवस्थित किया जाना चाहिए कि इस तक पहुंचने और इसके उपस्करों या इसके किसी पुर्जे को निकालने के लिए पर्याप्त मार्ग प्राप्त हो सके। मशीन कक्ष की ऊंचाई इतनी पर्याप्त होनी चाहिए कि उपस्कर के किसी भाग तक पहुंचने के लिए और मरम्मत तथा बदलने के हेतु इसे निकालने के लिए पर्याप्त अवकाश प्राप्त हो सके।**
- 6.2.2 **मशीन कक्ष प्रवेश के लिए सुरक्षित और सुविधाजनक अभिगम प्रदान किया जाना चाहिए तथा इसके अभिगम दरवाजे बाहर की ओर खुलने चाहिए।**
- 6.3 **मशीन कक्ष को एस्कलेटर मशीन, इसके संबंधित उपकरणों और उपस्करों के वेशन के अलावा भंडार कक्ष या किसी अन्य उद्देश्य के लिए उपयोग में नहीं लाना चाहिए। मशीन कक्ष में कोई दहनशील या विस्फोटक सामग्री नहीं रखी जानी चाहिए।**
- 7.0 **प्रकाश व्यवस्था, अभिगम और विद्युत मार्ग**
- 7.1 **मशीन कक्ष की प्रकाश व्यवस्था - मशीन कक्ष में अनुमोदित प्रकार की स्थाई और उचित कृत्रिम प्रकाश व्यवस्था प्रदान की जानी चाहिए तथा विद्युत प्रकाश व्यवस्था उपलब्धता वाले स्थानों पर प्रत्येक दो या कम मशीनों के लिए कम से कम एक निश्चित लाइट प्वाइंट तथा एक प्लग सॉकेट प्रदान किया जाना चाहिए। बत्ती के लिए स्विच मशीन कक्ष प्रवेश के निकट लगाई जानी चाहिए। प्रकाश व्यवस्था स्विच ऐसे स्थान पर होनी चाहिए कि मशीनरी के किसी भाग पर गये या पहुंचे बिना इसे प्रचालित किया जा सके।**
- 7.2 **सोपान पदन्यास की प्रकाश व्यवस्था - सोपान पद न्यास पूरे चालन तक प्रदीप्त होना चाहिए। पदन्यास पृष्ठों पर प्रकाश की तीव्रता 20 लक्स से कम नहीं होनी चाहिए।**
टिप्पणी: यह वांछनीय है कि प्रकाश की तीव्रता सप्पान तथा निकटवर्ती क्षेत्र से वस्तुतः विपरीत न हो।

5.4 **Broken Step-Chain Device** – A broken step-chain device shall be provided which shall cause the interruption of power to the driving machine if a step-chain breaks, and, where no automatic chain tension device is provided, if excessive sag occurs in either step-chain.

5.5 **Broken Drive-Chain Device** – Where the driving machine is connected to the main drive shaft by a chain, a device shall be provided to cause the application of the brake on the main drive shaft if the drive-chain parts.

5.6 **Stop Switch in Machinery Spaces** – A stop switch shall be provided in each machinery space where means of access to the space is provided. This switch, when opened, shall cause electric power to be removed from the escalator driving machine motor and brake. The stop switches shall be:

- (a) of the manually opened and closed type;
- (b) conspicuously and permanently marked, 'STOP'; and
- (c) positively opened mechanically and their opening shall not be solely dependent on springs.

5.7 **Application of an Electrically Released Brake** – An electrically released brake shall automatically stop the escalator when any of the safety devices required by 5.2 to 5.5. function.

6.0 Machine Room

6.1 A machine room of suitable size and construction shall be provided for the housing of the escalator machine or machines, and associated apparatus and equipment.

6.2 Access

6.2.1 The machine room shall be arranged to allow reasonable access to and the removal of the equipments therein or of any part thereof. The height of the machine room shall be sufficient to allow any part of the equipment to be accessible and removable for repairs and replacement.

6.2.2 Safe and convenient access to machine room entrances shall be provided with access doors opening outwards.

6.3 The machine room shall not be used as store room or for any other purpose other than housing the escalator machine an associated apparatus and equipment. No inflammable or explosive material shall be kept in machine room.

7.0 Lighting , Access and Electrical work

7.1 **Lighting of Machine Room** – The machine room shall be provided with permanent and adequate artificial lighting of an approved type and whenever available electric lighting shall be provided by at least one fixed light point and one plug socket for every two or less machines. The light switch shall be fixed near the machine room entrance. The lighting switch shall be so located that it can be operated without passing over or reaching over any part of the machinery.

7.2 **Lighting of Step Treads** – Step treads shall be illuminated throughout their run. The light intensity on the tread surfaces shall be not less than 20 lux.

Note : It is desirable that the illumination be of uniform intensity and that it should not contrast materially with that of the surrounding area.

7.3 बिजली के तार लगाना और उपकरण

7.3.1 एस्कलेटर अधिष्ठापन से संबंधित सभी बिजली के तार और उपकरण भारतीय विद्युत नियम और संगत भारतीय मानक के अनुरूप होने चाहिए और उस भवन के लिए, जिसमें एस्कलेटर अधिष्ठापित किया गया है, अग्नि बीमा से संबंधित अन्य विनियमों, यदि कोई हो, अनुपालन किया जाना चाहिए।

7.3.2 एस्कलेटर अधिष्ठापन से संबंधित सभी केबिल और अन्य तार कार्यकरण की आशदित वोल्टता के लिए संगत भारतीय मानक के अनुरूप होना चाहिए तथा धात्विक कवर का प्रयोग किए जाने पर इसे उचित ढंग से भूसंपर्कित किया जाना चाहिए।

7.3.3 किसी एस्कलेटर में किसी छड़ चालक का उपयोग नहीं किया जाना चाहिए कारण कि इससे व्यक्तियों को खतरा उत्पन्न हो सकता है।

7.3.4 विद्युत चालकों को दृढ़ कंड्यूइंट विद्युत ट्यूब या वायरवे में खोलबंद किया जाना चाहिए तथा इसे आलंबन संरचना के साथ मजबूतीबद्ध होना चाहिए।

7.3.5 एस्कलेटर की सभी विद्युत पूर्ति लाइनें और उपकरण उपयुक्त निर्माण की तथा ऐसे अधिष्ठापित, रक्षित, कार्यकृत और अनुरक्षित होने चाहिए कि उनसे व्यक्तियों को कोई खतरा न रहे।

7.3.5.1 सभी धातु खोल या विद्युत पूर्ति लाइन या उपकरणों वाली या उसके रक्षक धातु आवरण कुशलता पूर्वक भूसंपर्कित किए जाने चाहिए।

7.3.6 *वियोजन स्विच* - एक आवृत्त, फ्यूज वियोजन स्विच या परिपथ वियोजक अधिष्ठापित किया जाएगा और इसे चालन मशीन मोटर की पॉवर पूर्ति लाइन में संयोजित किया जाएगा। वियोजन स्विचों या परिपथ वियोजक हाथ से बंद करने योग्य बहु-ध्रुवी प्रकार का होगा। यह स्विच एस्कलेटर मशीन के निकट लगायी जाएगी तथा विद्युत पूर्ति के नियंत्रण स्थल से दर्शनीय होगी।

7.3.7 *विद्युत पुर्जों का परिवृत्त* - सभी विद्युत सुरक्षा स्विचों और नियंत्रकों को परिवृत्त किया जाना चाहिए ताकि अचानक संपर्क से बचा जा सके।

7.3.8 *सावधानी नोटिस* - उस प्रत्येक मोटर या उपकरण के निकट, जिसमें 250 वोल्ट से अधिक दाब पर ऊर्जा का प्रयोग किया जाता हो, उपयुक्त "चेतावनी/सावधानी" नोटिस लगाया जाना चाहिए।

7.3.9 *विद्युत रोधन* - प्रवर्तन और रोक युक्तियों के बिजली के भागों, अन्य प्रचालन और समान युक्तियों, नियंत्रकों तथा समान अन्य भागों को कुशलतापूर्वक विद्युत रोधित किया जाना चाहिये। यह विद्युत रोधन इन विद्युत पुर्जों के ऊर्जन की परीक्षण वोल्टता या प्रत्यावर्ती धारा से 10 गुनी वोल्टता, अधिकतम 2000 वोल्ट, उस समय जब परीक्षण वोल्टता खुली दशा में संपर्कों या समान भागों के बीच लगाई गयी हो, तथा ऐसे संपर्कों और भूसंपर्कित भागों के बीच, निरंतर एक मिनट तक सहन करने योग्य होनी चाहिए।

7.4 *अभ्यांतर के लिए अभिगम* - निरीक्षण और अनुरक्षण के हेतु एस्कलेटर के अभ्यांतर में जाने के लिए उपयुक्त अभिगम प्रदान किया जाना चाहिए।

8.0 अतिरिक्त सावधानियां और आवश्यकताएं

8.1 एस्कलेटर मशीन कक्ष में उपयुक्त अग्नि शामक प्रदान किया जाना चाहिए।

8.2 विस्फोटक और अन्य ज्वलनशील सामग्रियां एस्कलेटर में नहीं ले जायी जानी चाहिए इसके कारण व्यक्तियों की सुरक्षा को खतरा उत्पन्न हो सकता है।

7.3 Electrical Wiring and Apparatus

- 7.3.1 All electrical wiring and apparatus in connection with the escalator installation, shall conform to the Indian Electricity Rules and to the relevant Indian Standard and also to other regulations, if any, relating to fire insurance of the building in which the escalator is installed.
- 7.3.2 All cables and other wiring in connection with the escalator installation shall conform to the relevant Indian Standard for the voltage at which these are intended to be worked and if metallic covering is used it shall be efficiently earthed.
- 7.3.3 No bare conductor shall be used in any escalator as may cause danger to persons.
- 7.3.4 Electrical conductors shall be encased in rigid conduits, electrical tubings or wireways which shall be securely fastened to the supporting structure.
- 7.3.5 All electric supply lines and apparatus in the escalator shall be of suitable construction and shall be so installed, protected, worked and maintained that there is no danger to persons from them.
- 7.3.5.1 All metal casings or metallic coverings containing or protecting any electric supply line or apparatus shall be efficiently connected with earth.
- 7.3.6 *Disconnect Switch* – An enclosed, fused disconnect switch or a circuit breaker shall be installed and shall be connected into the power supply line to the driving machine motor. Disconnect switches or circuit breakers shall be of the manually closed multi-pole type. The switch shall be so placed that it is close to and visible from the escalator machine to which the supply is controlled.
- 7.3.7 *Enclosure of Electrical Parts*- All electric safety switches and controllers shall be enclosed to protect against accidental contact.
- 7.3.8 *Caution Notice* – Suitable 'CAUTION' notice shall be affixed near every motor or other apparatus in which energy is used at a pressure exceeding 250 volts.
- 7.3.9 *Insulation* – The electrical parts of starting and stopping devices, other operating and similar devices, controllers and similar other parts shall be efficiently insulated and the insulation shall be capable of withstanding for a period of one minute, the continuous application of a test voltage of alternating current equal to ten times the voltage at which these electrical parts are energised, subject to a maximum voltage of 2000 volts when the test voltage is applied between contacts or similar parts in the open position, and between such contacts and earthed parts.
- 7.4 *Access to Interior* – Reasonable access to the interior of the escalator shall be provided for inspection and maintenance.

8.0 Additional Precautions and Requirements

- 8.1 The escalator machine room shall be provided with a suitable fire-extinguisher.
- 8.2 Explosive or other inflammable materials shall not be carried in the escalator as may endanger the safety of persons.

- 8.3 एस्कलेटर की जाँच या मरम्मत के दौरान यह सुनिश्चित करने के लिए उपयुक्त कदम उठाए जाने चाहियें कि एस्कलेटर को भूलवश किसी व्यक्ति द्वारा इस प्रकार से प्रचालित न किया जाए जिससे एस्कलेटर पर कार्य कर रहे व्यक्तियों की सुरक्षा को खतरा उत्पन्न हो।
- 8.4 **एस्कलेटर गर्त पैन** - एस्कलेटर गर्त पैन से तेल और कचरे को आवधिक रूप से साफ किया जाना चाहिए। सफाई की बारंबारता सेवा पर निर्भर होगी, परन्तु यह ऐसी होनी चाहिए जिससे दुर्घटनावश या स्वतः प्रज्वालन के परिणास्वरूप होने वाले खतरों को न्यूनतम किया जा सके।
- 8.5 **स्नेहन** - मशीनरी और उपस्कर के ऐसे भाग, जिनके लिए स्नेहन किया जाना आवश्यक हो, विनिर्माता द्वारा यथा संस्तुत ग्रेड के स्नेहक से नियमित आवधिक अंतराल पर स्नेहित किया जाना चाहिए। अत्याधिक मात्रा में स्नेहक का उपयोग किए जाने से बचना चाहिए।
- 9.0 **आग से कैचियों और मशीन अवकाशों का रक्षण**
- 9.1 **अपेक्षित रक्षण** - एस्कलेटर कैचियों और मशीनरी अवकाशों के पार्श्व तथा अधःपार्श्व अग्नि-प्रतिरोधी सामग्रियों में आवृत्त होना चाहिए। चालन और चालित मशीन तथा नियंत्रण अवकाशों के समुचित संवातन के लिए साधन प्रदान किया जाना चाहिए।
- 10.0 **फर्श द्वारों का रक्षण**
- 10.1 **अपेक्षित रक्षण** - एस्कलेटर के लिए फर्श द्वार ऐसे रक्षित होने चाहिए कि आग लगने पर ज्वाल, धुआँ और गैसों इसमें प्रवेश न कर सकें।
- 10.2 **अपेक्षित आर्द्रता माध्यम के रूप में प्रत्यादित एस्कलेटर** - अपेक्षित आर्द्रता माध्यम के रूप में प्रत्यापित एस्कलेटर अधः स्टेयरवे (भीतरी सीढ़ी मार्गों) से संबंधित स्थानीय कानूनों और अध्यादेशों की आवश्यकताओं के अनुसार पूर्णतः आवृत्त किए जाएंगे।
- 10.3 **अपेक्षित आर्द्रता माध्यम के रूप में अप्रत्यादित एस्कलेटर** - अपेक्षित आर्द्रता माध्यम के रूप में अप्रत्यापित एस्कलेटर के फर्श द्वार सामान्यतः निम्नलिखित मान्य विधियों में से किसी एक विधि द्वारा या सक्षम एजेंसी द्वारा यथा स्थापित अन्य समुचित विधियों द्वारा रक्षित होंगे :-
- (क) 10.2 में यथा निर्धारित पूर्ण अहाता;
- (ख) प्रोक्षक (छिड़काव) विधि (केवल उन स्थानों पर जहाँ भवन क्षेत्र पर्यवेक्षित स्वचालित प्रोक्षक प्रणाली द्वारा पूर्णतः रक्षित हों) के अंतर्गत इस प्रकार लगे एकल प्रचालित प्रोक्षक आते हैं जिससे द्वार के खुले पार्श्व की रक्षा की जा सके। द्वार से सटे प्रोक्षक शीर्षों के चारों ओर की ऊष्मा ढेर के लिए एक ऊष्मा एप्रॉन प्रदान किया जाना चाहिये एप्रॉन का निचला कोर प्रोक्षक शीर्ष के तल से 15 सेमी० से कम नीचे नहीं होना चाहिए।
- (ग) छतरियाँ (कुक्षक)
- (घ) स्वतः रोलिंग शटर (आई एस : 3614 (भाग-1) - 1966 देखें); या
- (ङ.) फुहार नोजल (केवल उन स्थानों पर जहाँ भवन क्षेत्र पर्यवेक्षित स्वचालित प्रोक्षक प्रणाली द्वारा पूर्णतः रक्षित हों।
- 11.0 **परीक्षण**
- 11.1 **एस्कलेटरों का स्थल परीक्षण**
- 11.1.1 प्रत्येक आकार और प्रकार के एस्कलेटर का उस निर्धारित भार के लिए परीक्षण किया जाएगा जिसे वहन करने के लिए उसे डिजाइन किया गया है। ऐसे परीक्षण विनिर्माता के विकल्प पर उसके संयंत्र में या क्षेत्र में भवन में इस आकार-प्रकार के प्रथम एस्कलेटर अधिष्ठापित किए जाएंगे।

Where an escalator is under examination or repairs suitable steps shall be taken to ensure that the escalator is not operated inadvertently by any person in such a manner which may endanger the safety of persons working in the escalator.

Escalator Pit Pans- Escalator pit pans should be periodically cleaned of oil and refuse. The frequency of cleaning will depend on the service, but should be such as to reduce to a minimum the hazard resulting from accidental or spontaneous ignition.

Lubrication – All parts of the machinery and equipment requiring lubrication should be lubricated at regular periodic intervals with lubricants of a grade as recommended by the manufacturer. The use of excessive amounts of lubricant should be avoided.

9.0 Protection of Trusses and Machine Spaces Against Fire

Protection Required – The sides and undersides of escalator trusses and machinery spaces shall be enclosed in fire-resistive materials. Means may be provided for adequate ventilation of the driving and driven machine and control spaces.

10.0 Protection of Floor Openings

Protection Required – Floor openings for escalator shall be protected against the passage of flame, smoke or gases in the event of fire.

Escalator Accredited as a Required Means of Egress- Escalators accredited as a required means of egress shall be fully enclosed in accordance with the requirements of local laws and ordinances pertaining to interior stairways.

Escalators Not Accredited as a Required Means of Egress – Escalators not accredited as a required means of egress shall have the floor openings protected by any one of the following generally recognized methods or by other methods which may be established as adequate by competent agencies :

(a) Fully enclosures as specified in 10.2;

(b) Sprinkler method (only where the building area is fully protected by a supervised automatic sprinkler system) consisting of individually operating sprinklers so spaced as to protect the exposed sides of the opening. A heat apron shall be provided to bank heat around the sprinkler heads adjacent to the opening. The lower edge of the apron shall be not less than 15 cm below the bottom of the sprinkler heads.

(c) Kiosks;

(d) Automatic rolling shutters (see IS: 3614 (Part I)-1966); or

(e) Spray nozzles (only where building area is fully protected by a supervised automatic sprinkler system).

11.0 Testing

11.1 Site Tests of Escalators

11.1.1 Each type and size of escalator shall be tested for the rated load that it is designed to carry. Such tests may be made, at the option of the manufacturer, in his plant or in the field on the first escalator of that type and size installed in a building.

ऐसे आकार-प्रकार के एस्कलेटर का यदि पूर्व में परीक्षण और एक अधिकार क्षेत्र में अनुमोदित किया जा चुका है तो प्रवर्तन प्राधिकारी के विकल्प पर वास्तविक परीक्षण के स्थान पर ऐसे प्रमाणपत्रों की प्रतियों को स्वीकार किया जा सकता है।

- 11.1.2. अधिष्ठापित किए जाने वाले एस्कलेटर का प्रकार और चौड़ाई परीक्षित किए गए, के प्रकार और चौड़ाई से 1.5 मीटर अधिक हो तो उच्चतर उठान के लिए एक नया प्रारूप (टाइप) परीक्षण किया जाएगा।
- 11.1.3 एस्कलेटर की अपेक्षित प्रचालन और सुरक्षा युक्तियों का निम्नानुसार एस्कलेटर पर भार-सहित परीक्षण किया जाएगा;
- (क) चाल नियंत्रक परीक्षण - चाल नियंत्रक जहाँ 5.3 द्वारा आवश्यक समझा जाए, नियंत्रक को हाथ से प्रचालित करके परीक्षण किया जाएगा।
- (ख) भंजित सोपान-चेन युक्ति- भंजित सोपान-चेन युक्ति का प्रचालन 5.4 द्वारा आवश्यक, समझे जाने पर सक्रियण युक्ति को हाथ से प्रचालित करके इसका परीक्षण किया जाएगा।
- (ग) भंजित चालन - चेन युक्ति - भंजित चालन - चेन युक्ति का प्रचालन 5.5 द्वारा आवश्यक समझे जाने पर, चालन चेन के उपयोग वाले स्थान पर, सक्रियण युक्ति को हाथ से प्रचालित करके इसका परीक्षण किया जाएगा।
- (घ) स्टॉप (रोक) बटन - आपातकालीन स्टॉप बटन का, 5.2 द्वारा आवश्यक समझे जाने पर, उन्हें प्रचालित करके उस समय परीक्षण किया जाएगा जब एस्कलेटर यात्रा की दोनों दिशा में प्रचालित हो रहा हो।

Where a type and size of escalator has previously been tested and approved in one jurisdiction, certified copies of such test may be accepted in lieu of an actual test at the option of the enforcing authority.

- 1.2 If the rise for a given type and width to be installed is more than 1.5 metres higher than the rise for which that type and width has been tested, a new type test shall be made for the higher rise.
- 1.3 Escalator operating and safety devices required shall be tested with no-load on the escalator in accordance with the following:
 - (a) *Speed Governor Test* – Where a speed governor is required by 5.3, the governor shall be tested by operating it by hand.
 - (b) *Broken Step-Chain Device* – Operation of the broken step-chain device, required by 5.4, shall be tested by operating the actuating device by hand.
 - (c) *Broken Drive -Chain Device* – Operation of the broken drive-chain device required by 5.5, where a drive chain is used, shall be tested by operating the actuating device by hand.
 - (d) *Stop Buttons* – The emergency stop buttons, required by 5.2, shall be tested by operating them when the escalator is operated in each direction of travel.

परिशिष्ट - I

विद्युत संकर्षण लिफ्टों के कारों और प्रतिभारों के लिए तल रनबाई

(भारतीय मानक 14665 (भाग-2/धारा 1) 2000 के अनुसार)

कारों और प्रतिभारों के लिए तल रनबाई निम्नलिखित से कम नहीं होना चाहिए :

(क) तेल बफर प्रयोग (वाले स्थानों पर) 15 सेमी.

(ख) स्प्रिंग बफर प्रयोग वाले स्थानों पर

(1) निम्नलिखित नियंत्रणों के लिए 15 सेमी.

(i) परिवर्ती वोल्टता मोटर नियंत्रण (जनरेटर क्षेत्र नियंत्रण)

(ii) इलेक्ट्रॉनिक युक्तियां

(iii) प्रत्यावर्ती धारा परिवर्ती वोल्टता (ए सी वी वी)

(iv) प्रत्यावर्ती धारा परिवर्ती वोल्टता परिवर्ती आवृत्ति (ए सी वी वी वी एफ) नियंत्रण

(v) ठोस अवस्था दिष्ट (डी०सी०) परिवर्ती वोल्टता नियंत्रण

(2) एकल चाल और दोहरी चाल प्रत्यावर्ती धारा नियंत्रण और रियोस्टैटी नियंत्रण के लिए निम्नलिखित से कम नहीं -
निर्धारित चाल (मी./से.) रनबाई (सेमी.)

0.125 तक

7.5

0.125 से 0.25 तक

15

0.25 से 0.50 तक

22.5

0.50 से 1 तक

30

अधिकतम तल रनबाई :- अधिकतम तल रनबाई किसी भी स्थिति में निम्नलिखित से अधिक नहीं होना चाहिए :-

(क) कारों के लिए 60 सेमी० और

(ख) प्रतिभारों के लिए 90 सेमी०

शीर्ष कार अवकाश

कार क्रस-हेड और 500 मिमी. के भीतर निकटतम शिरोपरि अवरोध, जिसे कार प्लेटफार्म को शीर्ष अवतरण के साथ समतल होने पर क्रस-हेड के निकटतम भाग के क्षैतिज मापा जाता है, निम्नलिखित के योग से कम नहीं होना चाहिए।

(क) तल प्रतिभार रनबाई;

(ख) प्रयुक्त प्रतिभार बफर का स्ट्रोक;

(ग) निम्न पर आधारित गुरुत्व विरामी दूरी का आधा :

(1) उन स्थानों पर जहाँ तेल बफर का प्रयोग किया जाता है तथा प्रतिभार बफर संलग्न होने पर कार के उछाल को रोकने की कोई व्यवस्था न होने पर निर्धारित चाल का 115 प्रतिशत

(2) उन स्थानों पर जहाँ स्प्रिंग बफर का प्रयोग किया जाता है नियंत्रक ट्रिपिंग चाल।

टिप्पणी : गुरुत्व विरामी दूरी की गणना प्रारंभिक वेग से गुरुत्व मंदन के आधार पर निम्नलिखित सूत्र से की जा सकती है :

$$S=5.1 V^2$$

जहाँ S= मुक्त पात सेमी. में (गुरुत्व विरामी दूरी) और

V = प्रारंभिक वेग मी०/से० में

APPENDIX-I

BOTTOM RUNBY FOR CARS & COUNTER WEIGHTS FOR ELECTRIC TRACTION LIFTS (As per Indian standard 14665 (Part-2/Sec1)2000

The bottom Runby for cars and counterweights shall be not less than the following:

- (a) 15 cm where oil buffers are used.
- (b) Where spring buffers are used :-
 - (1) 15 cm for following controls
 - (i) Variable voltage Motor control (Generator field control)
 - (ii) Electronic Devices
 - (ii) Alternating current variable voltage (ACVV)
 - (iii) Alternating current variable voltage variable frequency (ACVVVF) control.
 - (iv) Solid state d.c. variable voltage control
 - (2) Not less than the following for single speed & two speed Alternating Current control and Rheo-static Control

Rated Speed (m/s)	Runby (cm)
upto 0.125	7.5
0.125 to 0.25	15
0.25 to 0.50	22.5
0.5 to 1	30

Maximum bottom runby :- In no case shall the maximum bottom runby exceed the following:-

- (a) 60 cm for cars and
- (b) 90 cm for counter-weights

Top Car Clearance:

The vertical clearance between the car cross-head and the nearest overhead obstruction within 500mm measured horizontally to the nearest part of cross-head when the car platform is level with the top landing, shall be not less than the sum of the following:

- (a) The bottom counter-weight runby;
- (b) The stroke of the counter-weight buffer used;
- (c) One half of the gravity stopping distance based on:
 - (1) 115 percent of the rated speed where oil buffers are used and no provision is made to prevent the jump of the car at counter-weight buffer engagement, and
 - (2) Governor tripping speed where spring buffers are used.

Note: The gravity stopping distance based on the gravity retardation from any initial velocity may be calculated according to the following formula:

$$S = 5.1 V^2$$

Where S= free fall in cm (gravity stopping distance), and

V= initial velocity in m/s.

(घ) 600 मिमी०

कूप के अधःस्तर के नीचे यदि उभार है और कास-हैड लाइन से क्षैतिज परन्तु कार की छत के ऊपर मापित, यह उभार 500 मिमी० से अधिक है, तो न्यूनतम ऊर्ध्वाधर अवकाश जो कि उपर्युक्त गणना से कम नहीं है, कार की छत और उभार के बीच भी उपलब्ध होगा।

परन्तु कार के ऊपर आरोपित किसी उपस्कर ओर निकटतम शिरोपरि उभार के बीच का ऊर्ध्वाधर अवकाश ऊपर यथा परिकल्पित (क), (ख) और (ग) मदों के योग + 150 मिमी० से कम नहीं होगा।

शीर्ष प्रतिभार अवकाश

शीर्ष प्रतिभार अवकाश निम्नलिखित चार मदों के योग से कम नहीं होगा

(क) तल कार रनबाई

(ख) प्रयुक्त कार बफर का स्ट्रोक

(ग) 15 सेमी० और

(घ) निम्नलिखित पर आधारित गुरुत्व विरामी दूरी का आधा:

(1) उन स्थानों पर जहाँ तेल बफर का प्रयोग किया जाता है तथा कार बफर संलग्न होने पर प्रतिभार के उछाल को रोकने की कोई व्यवस्था न होने पर निर्धारित चाल का 115 प्रतिशत

(2) उन स्थानों पर जहाँ स्प्रिंग बफर का प्रयोग किया जाता है नियंत्रक ट्रिपिंग चाल।

(d) 600 mm

Where there is a projection below the ceiling of the well and the projection is more than 500mm, measured horizontally from the line of the cross-head, but over the roof of the car, a minimum vertical clearance not less than that calculated above shall also be available between the roof of the car and the projection.

Provided that the vertical clearance between any equipment mounted on top of the car and the nearest overhead obstruction shall be not less than the sum of the three items (a), (b) and (c) as calculated above plus 150mm.

Top Counter-weight Clearances

The top counter-weight clearance shall be not less than the sum of the following four items:

- (a) the bottom car runby,
- (b) the stroke of the car buffer used,
- (c) 15 cm, and
- (d) one-half the gravity stopping distance based on:
 - (1) one hundred and fifteen percent of the rated speed where oil buffers are used and no provision is made to prevent jump of the counterweight at car buffer engagement, and
 - (2) governor tripping speed where spring buffers are used.

परिशिष्ट - II

तकनीकी विवरण

- क्रम सं० ब्यौरों का विवरण
- क. सामान्य
1. विनिर्माता का नाम
 2. विनिर्माण देश
 3. क्षमताएं (व्यक्ति/ भार)
 4. सेवा
 5. यात्रा चाल
 6. यात्रा की ऊँचाई
 7. सेवित तलों की संख्या
 8. द्वारों की संख्या
 9. प्रतिभार की स्थिति
 10. समतलन विधि का प्रकार
- ख. मशीन
1. मशीन की स्थिति
 2. मोटर
 3. प्रचालन के लिए उपयुक्त विद्युत पूर्ति के विवरण
- ग. ब्रेक
1. प्रकार
- घ. कार ओर दरवाजे
1. कार की वाह्य विभाएं
 2. आंतरिक स्पष्ट विभाएं
 3. कार का निर्माण
 4. कार अहाते का डिजाइन /प्रकार
 5. फर्शबंदी के विवरण
 6. कार के भीतर संलग्न और फिटिंग्स
 7. **कार दरवाजे**
 - (क) आकार
 - (ख) प्रचालन
 - (ग) निर्माण, डिजाइन और परिष्करण
 8. **अवतरण दरवाजे**
 - (क) आकार
 - (ख) प्रचालन
 - (ग) निर्माण, डिजाइन और परिष्करण
- ङ. सुरक्षा युक्तियां
1. कार सुरक्षा प्रकार
 2. प्रतिभार सुरक्षा प्रकार
 3. कार प्रकार में दरवाजा अंतः पाश
 4. अवतरण प्रकार में दरवाजा पाश
- च. प्रस्ताव में शामिल अन्य सुरक्षाएं

APPENDIX -II

TECHNICAL PARTICULARS

Sl. No. Particulars of Details

A General :

1. Name of Manufacturer.
2. Country of Manufacture.
3. Capacities (Persons/ Weight).
4. Service
5. Speed of Travel
6. Height of Travel.
7. No. of Floors served.
8. No. of openings.
9. Position of counterweight.
10. Type of Levelling method.

B. Machine:

1. Position of Machine
2. Motor.
3. Electric supply particulars for which it is suitable for operation

C. Brake

1. Type

D. Car and Doors:

1. Outside dimensions of car.
2. Inside clear dimensions.
3. Construction of car
4. Design/ type of enclosure of car.
5. Details of flooring
6. Attachment and fitting inside the car

7. Car Doors:

- (a) Size
- (b) Operation
- (c) Construction , Design & finish

8. Landing Doors :

- (a) Size
- (b) Operation
- (c) Construction , design & finish

E. Safety Devices:

1. Car safety-type
2. Counter weight safety-type
3. Door inter locks in car-type
4. Door locks in landing-type.

F. Other Safeties included in the offer:

परिशिष्ट - III

विभागीय अधिकारियों और फर्म प्रतिनिधियों द्वारा संयुक्त निरीक्षण के लिए जाँच सूची संदर्भ खंड IV लिफ्ट अधिष्ठापनों का परीक्षण

1. निरीक्षण का स्थान
2. निरीक्षण की तारीख
3. फर्म
4. करार उद्धरण के अनुसार विवरण तथा संविदा के अनुसार निष्पादित किए जाने वाले कार्य की पूर्णता को देखकर सत्यापित करें।
5. ड्राइंग के अनुसार विन्यास (ले-आउट) और रिकार्ड विसंगतियों, यदि कोई हो, को सत्यापित करें।
6. क्या प्रत्येक अवतरण पर और लिफ्ट कार में लगाई जाने वाली 'लिफ्ट' लिखी प्लेट और अनुदेश प्रदर्शित किए गए हैं।

उपस्कर युक्त लिफ्ट

- (क) गर्त की गहराई और आवश्यक होने पर क्या सीढ़ी उपलब्ध कराई गयी है।
 - (ख) गर्त में प्रकाश व्यवस्था
 - (ग) लिफ्ट शैफ्ट में प्रकाश व्यवस्था
 - (घ) प्रतिभारों के लिए क्या समुचित टाई-रॉड उपलब्ध कराए गए हैं।
 - (ङ) क्या सभी तार कंड्यूइट पाइपों से होकर लगाए गए हैं / उचित रूप से दृढ़ और भूसंपर्कित किए गए हैं।
 - (च) गर्त में प्रतिभार के लिए गार्ड
 - (छ) रज्जु बंधकों और अंतकों में चेक नट और स्प्लिट पिनों की व्यवस्था
 - (ज) क्या सभी रज्जुओं के लिए रज्जु तनाव समान है।
 - (झ) क्या बफर सम्मिलित रूप से स्थापित किए गए हैं।
 - (ञ) क्या मोटर नियंत्रण के लिए परिपथों का संकेत और सिगनल देते हुए पृथक केबिल प्रदान किए गए हैं।
 - (ट) शीर्ष कार अवकाश
 - (ठ) निम्न कार अवकाश
 - (ड) शीर्ष प्रतिभार अवकाश
 - (ढ) तल कार रनबाई
 - (ण) निम्न प्रतिभार रनबाई
 - (त) कोई अन्य
7. निम्नलिखित के लिए मशीन कक्ष जाँच व्यवस्था:
- (i) नम्य कार्ड युक्त हैडलैंप की व्यवस्था
 - (ii) एक प्लग और सॉकेट
 - (iii) समुचित संवातन
 - (v) दरवाजे पर खतरे की प्लेट
 - (v) ट्रेप दरवाजा
 - (vi) मुख्य (मेन) स्विच
 - (vii) दीवार पर परिपथ रेखा चित्र
 - (viii) कोई अन्य

APPENDIX-III

CHECK LIST FOR JOINT INSPECTION OF LIFTS BY DEPARTMENTAL OFFICERS & FIRM'S REPRESENTATIVES

REF. SECTION IV-TESTING OF LIFT INSTALLATIONS

1. Place of Inspection
2. Date of Inspection
3. Name of the Firm
4. Verify visually particulars as per agreement description and completeness of work to be executed as per contract.
5. Verify lay-out as per drawing and record discrepancies if any
6. Whether a plate with word LIFT and instruction to be displayed /provided on each landing and in lift car.

LIFT WITH EQUIPMENT

- (a) Depth of pit and whether ladder provided if required.
 - (b) Arrangement for lighting in the pit.
 - (c) Arrangement for lighting in the lift shaft.
 - (d) Whether adequate tie rods provided for counter weights.
 - (e) Whether all wiring has been in conduit pipes / troughs properly fixed and earthed.
 - (f) Guard for counter weights in the pit.
 - (g) Provision of check nuts and split pins in rope fastenings and terminations.
 - (h) Whether rope tension equal for all ropes.
 - (i) Whether buffers symmetrically positioned.
 - (j) Top car clearance.
 - (k) Bottom car clearance.
 - (l) Top counter weight clearance
 - (m) Bottom car run by.
 - (n) Bottom counter weight run by.
 - (o) Any other
7. Machine room check provision for:
 - (i) Arrangement for hand lamp with flexible cord.
 - (ii) A plug and socket.
 - (iii) Adequate ventilation
 - (iv) A danger plate on door
 - (v) Trap door
 - (vi) Main switch
 - (vii) Circuit diagram on wall
 - (viii) Any other

8. भू संपर्कन

क्या मशीन काय नियंत्रक, कार फ्रेम, सीमा स्विचों और कंड्यूइट को उचित ढंग से भूसंपर्कित किया गया और भूसंपर्कन के अविच्छिन्नता की जाँच की गयी है।

9. मशीन और नियंत्रक

- (i) तेल रिसाव, यदि कोई हो
- (ii) तेल, बियरिंग और मोटर के तापक्रम में असामान्य वृद्धि
- (iii) असामान्य शोर या कंपन
- (iv) क्या मोटर या फ्लाई व्हील पर ऊपर (UP) और नीचे (DOWN) की दिशा दर्शाते हुए तीर के निशान लगाए गए हैं ?
- (v) क्या मशीन और इसके तल प्लेटों के नीचे रबड़ पैड लगाए गए हैं ?
- (vi) क्या नियंत्रण परिपथों के अपने-अपने फ्यूज हैं ?
- (vii) क्या रज्जु ब्रेकेज के विरुद्ध रक्षण या रज्जु वरक के लिए टैप प्रदान किए गए हैं ?
- (viii) क्या केबिल फेसल पर निशान लगे हैं ?
- (ix) कार और अवतरण देहली के बीच का अंतराल
- (x) कोई अन्य

10. प्रचालन

- (i) सभी तल बटनों का कार के भीतर से ऊपर और नीचे की दिशा में परिचर और स्वचालित दोनों प्रकार के नियंत्रणों से प्रचालन।
- (ii) कार का अवतरण बटनों के दिए गए कॉलों द्वारा ऊपर और नीचे की दिशा में दोनों परिचर और स्वचालित नियंत्रण पर प्रचालन।
- (iii) दरवाजा बंद करने और खोलने वाले बटनों का प्रचालन।
- (iv) आपातकालीन अलार्म।
- (v) आपातकालीन रोक (स्टॉप)।
- (vi) बत्ती और पंखा।
- (vii) आपातकालीन खोलने की चाबी।
- (viii) आपातकालीन बत्ती।
- (ix) संविदा में निर्धारित नियंत्रण प्रकार पर प्रचालन।
- (x) कार शीर्ष सुरक्षा स्विचों का लिफ्ट को अकार्यशील बनाने के लिए कार के भीतर से प्रचालन और प्रचालन की चाल।
- (xi) दरवाजा पाशन, प्रत्येक तल से यथा जाँची गयी।
- (xii) कोई असामान्य शोर, कंपन, झटका, अंतराल या विराम।
- (xiii) कार में पार्श्व की ओर लहक, यदि कोई हो।
- (xiv) प्रत्येक कार में और प्रत्येक अवतरण पर स्थिति और दिशा सूचकों का कार्यकरण
- (xv) दरवाजों के सचल कोर पर संवेदी अविवृत्तन (खोलने) की व्यवस्थाओं का कार्यकरण
- (xvi) कार और अवतरण दरवाजों की निर्बाध सर्पण गति।
- (xvii) क्या कार तलों के बीच में रोक जा सकती है और क्या दरवाजों को कार के भीतर से हाथ से खोला जा सकता है ?

8. Earthing
Whether machine body controller, car frame, limit switches, and conduits properly earthed & check earthing continuity.
9. Machine and controller
- (i) Oil leakage if any
 - (ii) Abnormal temp rise of oil, bearing and motor
 - (iii) Abnormal noise or vibrations
 - (iv) Whether UP and DOWN (direction arrows on motor or fly wheel marked)
 - (v) Whether rubber pads provided under machine and its bed plates
 - (vi) Whether control circuits have independent fuses
 - (vii) Whether protection against breakage of rope or taps for rope selector provided
 - (viii) Whether cable ferrules marked
 - (ix) Gap between the car and landing sill
 - (x) Any other
10. Operation
- (i) Operation of all floor buttons from within the car in up and down direction on both attendant and auto control.
 - (ii) Operation of car by calls given from landing buttons in up and down direction on both attendant and auto control.
 - (iii) Operation of door close and door open buttons
 - (iv) Emergency alarm
 - (v) Emergency stop
 - (vi) Light and fan
 - (vii) Emergency key opening
 - (viii) Emergency light
 - (ix) Operation on type of control stipulated in contract
 - (x) Operation of car top safety switches to make the lift inoperative from within the car and speed of operation.
 - (xi) Door locking as checked from each floor
 - (xii) Any abnormal noise vibration jerk interval and stopping
 - (xiii) Sideway play if any in the car.
 - (xiv) Working of position and direction indicators in car and at each landing.
 - (xv) Functioning of sensitive reopening arrangements on moving edge of doors.
 - (xvi) Smooth sliding movement of car and landing doors.
 - (xvii) Whether car is stopped in between the floor and whether the doors can be opened manually from inside.

- (xviii) लिफ्ट प्रचालन के दौरान अवतरण या कार दरवाजों को खोलना ताकि लिफ्ट स्टाप की गति को देखा जा सके।
- (xix) फायर मैन स्विच का प्रचालन।
- (xx) ब्रेक मोचक युक्ति और हस्त कुंडली व्यवस्था के लिये जांच।

11. सुरक्षा युक्तियां

- (i) समकलाकरण और कला विपर्यय के लिए रक्षण का कार्यकरण।
- (ii) कार और प्रतिभार को बफर पर लादने से पूर्व स्वचालित पॉवर कट-ऑफ युक्ति के लिए रक्षण प्रकमण।
- (iii) अधिभार रिले का कार्यकरण।
- (iv) सुरक्षा गियर का प्रचालन तथा गाइड रेल की अनापेक्षित विकृति को देखना तथा विरामी दूरी।
- (v) सुरक्षा स्विचों की जांच के लिए प्रचालन।
- (vi) उच्चतर सीमा स्विच का प्रचालन और स्थितियां।
- (vii) निम्नतर सीमा स्विच का प्रचालन और स्थिति।
- (viii) आपात कालीन दरवाजे के खुलने के विरुद्ध विद्युत रक्षण का प्रचालन।
- (ix) कोई अन्य

12. चरखी और रज्जु पर 60 मिमी० / 12 मिमी०, 60 मिमी० / 20 मिमी० पर संदर्भ चिन्ह लगाते हुए पूरे तीन चक्रों (ट्रिप) के पश्चात रज्जु स्वर्पण (स्लिप) की जांच करना

13. यह देखना कि ऊपर की दिशा में बिना भार के तथा नीचे की दिशा में पूर्ण भार पर तथा एकल समकलाकरण पर लिफ्ट चालू नहीं हो रही है।

14. पूरे भार के साथ नीचे की दिशा में पूरी चाल पर विद्युत पूर्ति बंद करके ब्रेक का अनुप्रयोग तथा अति तापन के लिए जांच करें।

15. भार परीक्षण : लिफ्ट संख्या

	भार रहित		पूर्ण भार सहित
	ऊपर	नीचे	ऊपर नीचे

प्रवर्तन धारा : ए सी (एम्पियर)

चालू धारा : ए सी (एम्पियर)

यात्रा (मीटर)

चाल : मीटर / सेकेन्ड

16. कोई अन्य परीक्षण

- (i) लिफ्ट कूप का आकार
- (ii) कार प्लेटफार्म की आंतरिक गहराई
- (iii) कार के दरवाजे का आकार
- (iv) रज्जु ब्रेकेज के विरुद्ध रक्षण किया गया है तथा परीक्षण परिणाम प्राप्त किए गए हैं।
- (v) विद्युत रोधन प्रतिरोध परीक्षण और उच्च वोल्टता परीक्षण भी किया जा चुका है। प्राप्त विद्युत रोधन प्रतिरोध -एम ओम (0.5M ओम मिनट आवश्यक) और उच्च वोल्टता परीक्षण सहन किया जा सका/ नहीं किया जा सका।

- (xviii) Opening of landing or car door when lift is in operation to see that the movement of lift stops.
- (xix) Operation of fireman switch.
- (xx) Check for brake-release device and hand winding provisions.

11. Safety Devices

- (i) functioning of protection for single phasing and phase reversal.
- (ii) Function of protection for automatic power cut off device before the car and counterweight load on buffers.
- (iii) Function of over load relays.
- (iv) Operation of safety gear and also see for undue deformation of guiderails and stopping distance.
- (v) Check operation of safety switches.
- (vi) Operation of upper limit switch & positions
- (vii) Operation of lower limit switch and position
- (viii) Operation of electrical protection against opening of emergency door.
- (ix) Any other.

12. Checking of rope slip after 3 complete trips by putting a reference mark on the sheave and rope 60mm/12mm, 60mm/20mm.

13. Test to see that the lift does not start in upward direction on no load and down direction on full load and on single phasing

14. Check application of brake on full load in down direction at full speed by switching off the power supply and for over heating.

15. Load Test : Lift No. ———

No Load

Full Load

UP

Down

UP

Down

Starting current : AC (Amp)

Running current : AC (Amp)

Travel (Meters)

Speed : Meter/Sec

16. Any other test

- (i) Size of the lift well
- (ii) Internal depth of car platform
- (iii) Size of the car door
- (iv) Rope protection against breakage have been carried out and test results are found
- (v) Insulation resistance test & high voltage test have also been tested. I.R. is found _____ M ohm (Requirement 0.5 M ohm minimum) and HV test with stood/ not with stood

परिशिष्ट - IV

On every de-energized lift, there shall be provided a four position indicator or

बंबई लिफ्ट नियम, 1958 (1989 तक यथा संशोधित)

1. लिफ्ट कूप

- (क) लिफ्टों के स्वीकार करने आशायित सभी लिफ्ट कूप मात्र इसी उद्देश्य से आरक्षित रखे जाने चाहिए और इसका उपयोग किसी अन्य उद्देश्य से नहीं किया जाना चाहिए।
- (ख) लिफ्ट कूप तथा इसमें स्थापित किए जाने वाले सभी उपस्कर और उपकरण अधिक संभावित सीमा तक अग्नि रोधी बनाए जाने चाहिए।
- (ग) लिफ्ट कूप का भीतरी पृष्ठ, इसकी अहाता बाड़ और लिफ्ट कार प्रवेश द्वार जहां तक व्यावहारिक हो बहिर्वेशनों या अवकाश को छोड़कर मासृण और सपाट रखे जाने चाहिए। किसी प्रक्षेप या कोटरित शीर्ष को सपाट न किए जाने पर धातु प्लेट लगाकर सीमेंट करके या अन्य अग्नि रोधी सामग्रियों द्वारा भीतर की ओर, जिसका कोण 60° से कम न हो समतल किया जाएगा।
- (घ) लिफ्ट-कार दरवाजे को खुला रखकर लिफ्ट-कार समतलन युक्ति प्रचालनीय रहने पर ऐसे आंतरिक पृष्ठ प्रत्येक अवतरण तल के नीचे मासृण और सपाट होने चाहिए।
- (ङ) कार के गाइडों और पार्श्व भित्तियों या लिफ्ट कूप अहाते के बीच पर्याप्त अवकाश उपलब्ध कराए जाने चाहिए ताकि सुरक्षा गियरों के पुर्जों के अनुरक्षण और मरम्मत के लिए उन तक आसानी से पहुँचा जा सके।
- (च) ऐसे लिफ्ट कूप के मामले में जो कि एक से अधिक लिफ्टों के लिए सर्वनिष्ठ और लिफ्ट कार या एक लिफ्ट का प्रतिभार दूसरी कार के कार लिफ्ट या प्रतिभार के ठीक विपरीत कार्य कर रहे हों ऐसी लिफ्ट कारों या प्रतिभारों को सावधानीपूर्वक और पर्याप्ततः रक्षित किया जाना चाहिए ताकि लिफ्ट कार या लिफ्ट कूप में कार्य कर रहे व्यक्तियों को ऐसी कारों या प्रतिभार की यात्रा के कारण होने वाली दुर्घटना से बचाया जा सके।
- (छ) पूर्ण अहाते वाली (संवृत) लिफ्ट कूप के मामले में प्रत्येक अवतरण दरवाजे के बाहर "लिफ्ट" लिखी सूचना लगायी जानी चाहिए।

2. लिफ्ट कूप अहाता

- (क) लिफ्ट कूप और प्रतिभार के लिए कूप, यदि लिफ्ट कूप से अलग अवस्थित हो तो, उपयुक्त अहाता कार्य के माध्यम से समुक्षित रक्षित होना चाहिए और यह फर्श से अंतस्छद तक विस्तारित होना चाहिए।
- (ख) मुख्य लिफ्ट-कूप से स्वतंत्र अवस्थित सभी प्रतिभार कूपों में प्रतिभारों, तार रज्जुओं और इनके स्थिरक स्थानों, गाइडों और गाइड सहायकों के निरीक्षण, अनुरक्षण और मरम्मत कार्यों के लिए उपयुक्त अभिगम उपलब्ध कराए जाने चाहिए।
- (ग) ऐसे प्रति-भार कूपों के लिए अभिगम प्रदान करने वाले ऐसे दरवाजों में विद्युत् यांत्रिक पाशन युक्तियां लगायी जानी चाहिए।
- (घ) तार ग्रिल या इसी प्रकार के निर्माण का प्रयोग किए जाने पर जाली या विवर 32 मिमी० से अधिक नहीं होना चाहिए और लिफ्ट मार्ग अहाता पर्याप्त दृढ़ता का होना चाहिए ताकि सीढ़ी या सटे फर्श के उपभोक्ताओं के आकस्मिक प्रभावों को सहन कर सके।
- (ङ) लिफ्ट कूप अहाता खुले प्रकार का होने पर यदि लिफ्ट कूप और लिफ्ट कूप उपस्कर उपकरण के सचल या चलन योग्य भाग के बीच का अवकाश 5 सेमी० से कम हो तो अहाते की खुली जगह वर्गाकार जाली से पुनः रक्षित की जाएगी। जाली 12 मिमी० से बड़ी तथा तार का व्यास 1 मिमी० से कम नहीं होना चाहिए।
- (च) लिफ्ट कूप या इसके किसी भाग में इसके स्वयं के प्रतिभार के अलावा किसी अन्य प्रतिभार को यात्रा करने की अनुमति नहीं दी जाएगी।

APPENDIX -IV

BOMBAY LIFT RULES 1958 as AMMENDED UPTO 1989

Lift wells

- (a) All lift-wells intended for the reception of lifts shall be exclusively reserved for that purpose and shall not be used for any other purpose.
- (b) Lift-wells and all equipments and apparatuses fixed therein shall be rendered fire-proof to the greatest possible extent.
- (c) The inner surface of the lift well and its enclosure facing any lift-car entrance shall, so far as practicable, be kept smooth and flush devoid of projections or recesses. Where any projections or tops of the recessed cannot be rendered flush, they shall be levelled on the underside to an angle of not less than 60 degrees from the horizontal, by means of metal plates, cement rendering or other fire-resisting materials.
- (d) Where a lift-car levelling device is operative with lift-car gate open such interior surfaces shall always form a smooth and flush surface below each landing level.
- (e) Sufficient space shall be provided between the guides for the car and the side-walls or the lift-well enclosure to allow safe and easy access to the parts of the safety gear for their maintenance and repairs.
- (f) In the case of a lift-well which is common to more than one lift and where the lift-car or the counter-weight of one lift is working in juxtaposition to the lift-car or the counter-weight of another lift, such lift-cars or counter-weights shall be guarded carefully and adequately in order to protect persons working in the lift-well or on the lift-cars from accidental contact with such cars or counter-weight in any part of their travel.
- (g) In case of a completely enclosed lift-well a notice with the word 'Lift' shall be placed on the outside of each landing door.

Lift-well enclosure

- (a) Lift-well and wells for the counter-weight if located independently of the lift-well shall be adequately protected by means of suitable enclosure work which shall be extended on all sides from floor to ceiling.
- (b) In all counter-weight wells located independently of the main lift-well, suitable access shall be provided for the inspection, maintenance and repairs to counter-weights, wire ropes and their anchorages, guides and guide supports.
- (c) All such doors giving access to such counter-weight wells shall be provided with electro-mechanical locking devices.
- (d) Where wire grill or similar construction is used, the mesh or opening shall be not greater than (32 mm) and the lift-way enclosure shall be of sufficient strength to resist accidental impacts from users of the staircase or adjoining floors.
- (e) Where the clearance between the lift-well enclosures, if of an open type and any moving or moveable part of the lift equipment of apparatus is less than (5 cm) the opening in the enclosure shall be further protected by nettings of square mesh not greater than (12mm) and of wire not smaller than (1mm dia).
- (f) No counter-weight shall be allowed to travel in any lift-well or part of any lift-well other than that to which it belongs.

- (छ) प्रत्येक यात्री लिफ्ट पर प्रत्येक तल पर एक तल स्थिति संकेतक या "उपयोग में लायी जा रही है" (IN USE) संकेतक या दिशा कौल रजिस्टरन बतियां प्रदान की जाएंगी।
- (ज) लिफ्ट कूप अहाते के लिए काँच का उपयोग नहीं किया जाएगा।
- (झ) कार प्रवेश के पार्श्व पर लिफ्ट कूप अहाते तथा कार की देहली कोर के बीच की दूरी अवतरण जोन में अवतरण फाटक से 30 मिमी० से अधिक नहीं होनी चाहिए। यदि ऐसी दूरी लिफ्ट कूप अहाते में 30 मिमी से अधिक हो तो इसे उपयुक्त और चिकने प्लास्टर कार्य या फलक प्लेट से सज्जित किया जाना चाहिए ताकि इसके पृष्ठ को प्रक्षेप और अवकाश रहित बनाया जा सके। पार्श्व फलक पर अहाता दीवार के मामले में लिफ्ट कार प्रवेश लिफ्ट कार प्लेटफार्म के देहली कोर से 13 सेमी० से अधिक ऊँचा हो तो इस प्रकार की लिफ्ट के दरवाजों को लिफ्ट कार से इस कार प्रवेश द्वारा सेवित अवतरण के अलावा, खोलने से रोकती है।
- (ञ) किसी अवतरण देहली कोर ओर कार प्लेटफार्म देहली के बीच की दूरी 25 मिमी० से अधिक नहीं होनी चाहिए।
- (ट) ऐसे लिफ्ट के किसी अवतरण, लिफ्ट मार्ग अहाते के दरवाजे में, जो संगलनीय लिंक के माध्यम से या अन्यथा ऊष्मा की क्रिया के कारण प्रचालित हों और जो भवन के किसी निकास की ओर अभिमय प्रदान करें। स्वचालित अग्नि दरवाजे या शटर की अनुमति नहीं दी जाएगी।
- (ठ) 24 मीटर से अधिक ऊँचाई वाले भवनों की लिफ्ट कूप अहाता दीवारों की आग प्रतिरोधकता 2 घंटे से कम की नहीं होनी चाहिए। लिफ्ट कूप में मशीन कक्ष के ठीक नीचे स्थायी द्वार होना चाहिये इस द्वार का स्पष्ट क्षेत्रफल 0.2 वर्ग मी० से कम नहीं होना चाहिए।
- (ड) 24 मीटर से अधिक ऊँचाई वाले भवनों के अग्नि लिफ्ट (एक ऐसी लिफ्ट जिससे अग्निशमन कार्मिक न्यूनतम विलंब से उच्च तलों पर पहुँच सकें इसका उपयोग आपातकाल में मात्र फायरमेन द्वारा किया जाएगा और प्रत्येक तल पर प्रत्येक अवतरण के लिए सीधे अभिगम्य होगी।) को ईट जोड़कर या ऐसी आर. सी.सी. दीवार द्वारा, जिसकी आग प्रतिरोधकता 2 घंटे से कम की न हो, पृथक किया जाएगा।

3. लिफ्ट-गर्त

- (क) लिफ्ट गर्तों को शुष्क और साफ दशा में दृढ़ता पूर्वक निर्मित और अनुरक्षित किया जाएगा। आवश्यकतानुसार स्थाई अपवाह की व्यवस्था की जाएगी।
- (ख) किसी लिफ्ट कूप के नीचे से कोई स्थान, यात्री या आम रास्ता प्रदान नहीं किया जाएगा, परन्तु अत्यन्त आवश्यक होने पर निम्नलिखित आवश्यकताओं को पूरा होने पर लिफ्ट कूप के नीचे से कोई स्थान यात्री या आम रास्ता दिया जा सकता है:-
- (i) लिफ्ट और प्रति भार के लिए स्प्रिंग और तेल बफर प्रदान किए गए हैं।
- (ii) लिफ्ट गर्त को पर्याप्त मजबूत बनाया गया है ताकि वह निर्धारित भार वाली लिफ्ट कार के संघट्ट को या निर्धारित चाल या नियंत्रक ट्रेपिंग चाल से अवरोहित होते प्रतिभार के संघट्ट को सफलतापूर्वक सहन कर सके; और
- (iii) कार और प्रतिभार में नियंत्रक प्रचालित सुरक्षा गियर प्रदान किये गये हैं।

4. शीर्ष कार अवकाश

- (क) शीर्ष कार अवकाश निम्नलिखित चार मदों के योग से कम नहीं होगा, नामतः
- (i) निम्न प्रतिभार रनबाई;
- (ii) प्रयुक्त प्रतिभार बफर का स्ट्रोक;
- (iii) 60 सेमी० या किसी चरखी या क्रॉस हैड शीर्ष से ऊपर क्रॉस हैड प्रोजेक्ट में या उस पर आरोपित किसी अन्य उपस्कर की दूरी जो भी अधिक हो, ओर
- (iv) निम्नलिखित पर आधारित गुरुत्व अवरोधन दूरी का आधा :-
- (क) उन स्थानों पर, जहाँ तेल बफर उपयोग किया जाता है और प्रतिभार बफर जुड़ने पर कार के उछाल को रोकने की कोई व्यवस्था नहीं की गयी है, एक सौ पंद्रह प्रतिशत; और

- (g) On every passenger lift, there shall be provided at each floor, a floor position indicator or 'IN USE' indicator or direction call registering light.
- (h) Glass shall not be used for lift-well enclosure.
- (i) The distance between the lift-well enclosure on the sides facing any lift-car entrance and the sill edge of the car shall be not more than 30mm in the landing zone below the landing gate. If such distance is more than 30mm in the lift-well enclosure, the same shall be finished with suitable and smooth plaster work or facia plates so as to make the surface thereof devoid of all projection and recesses. In case the enclosure wall on the sides facing the lift car entrance is more than 13 cms from the sill edge of the lift-car platform, the lift-car door of such lift shall be provided with means to prevent it from being opened except when the lift-car is at the landing served by such car entrance.
- (j) The distance between the edge of any landing sill and the sill of the car platform shall not be more than 25mm.
- (k) No automatic fire door or shutter which operates by means of a fusible link or otherwise due to the action of heat, shall be allowed in any landing, opening of the lift way enclosure of any lift, if such opening gives access to any exit from the building.
- (l) The walls enclosing lift-wells in the buildings having height more than 24 metres shall have fire resistance of not less than two hours. The lift-well shall have permanent vents immediately under the machine room not less than 0.2 sqm in clear area.
- (m) The lift-well for fire lift (a lift to enable firebrigade personnel to get to the upper floors with the minimum delay and to be used exclusively by firemen in an emergency and directly accessible to every landing on every floor), in the buildings having more than 24 metres height, shall be segregated from the other lift-well by means of brick masonry or R.C.C. wall of a fire resistance of not less than two hours.

3. Lift-pits

- (a) Lift-pits shall be soundly constructed and maintained in a dry and clean condition. Where necessary, provision shall be made for permanent drainage.
- (b) No room, passage or thoroughfare shall be provided under any lift-well; Provided that, where it is absolutely necessary to provide any room, passage or thoroughfare under a lift-well, all the following requirements shall be fulfilled, namely:-
- (i) spring or oil buffers shall be provided for lift and counter-weight;
 - (ii) the lift-pit shall be made sufficiently strong to withstand successfully the impact of the lift-car with the rated load or the impact of the counter-weight when descending at the rated speed or at the governor tripping speed ; and
 - (iii) the car and the counter-weight shall be provided with a governor-operate safety gear.

4. Top car clearance –

- (a) The top car clearance shall not be less than the sum of the following four items , namely:-
- (i) the bottom counter-weight runby;
 - (ii) the stroke of the counter-weight buffer used;
 - (iii) 60 cm or the distance which any sheave or any other equipment mounted in, or on, cross head projects above the top of the cross-head, whichever is greater; and
 - (iv) one half of the gravity stopping distance based on :
 - (A) One hundred and fifteen percent, of the rated speed, where oil buffers are used and no provision is made to prevent the jump of the car at counter-weight buffer engagement ; and

(ख) उन स्थानों पर जहां स्प्रिंग बफर का उपयोग किया जाता है, नियंत्रक ट्रिपिंग चाल।

टिप्पणी:- गुरुत्व अवरोधन चाल गुरुत्व मंदन पर आधारित होती है; प्रारंभिक वेग की गणना निम्नलिखित सूत्र से की जा सकती है- $S=5.1 v^2$

जहां 'S' मुक्त पात (सेमी० में) तथा 'V' प्रारंभिक वेग (मीटर प्रति सेकेंड) है।

(ख) अधस्तल कार अवकार

बफर की पूर्णतः संपीडित अवस्था में कार के विरामावस्था में होने पर लिफ्ट गर्त के फर्श और बफर स्ट्राइकर प्लेट या निम्नतम संरचना, या कार प्लेटफार्म के नीचे अधिष्ठापित उपस्कर या युक्ति के बीच का ऊर्ध्वाधर अवकाश 60 सेमी० से कम नहीं होना चाहिए परन्तु तीन सौ मिलीमीटर के भीतर अवस्थिति गाइड शूज, रोलर, सुरक्षा जबड़ा ब्लॉक और प्लेटफार्म एप्रॉन या गार्ड को कार प्लेटफार्म के पार्श्व से क्षैतिज मापा जाएगा।

पूर्णतः संपीडित बफर के साथ कार के विरामावस्था में होने पर कार या इससे संलग्न किसी उपस्कर का कोई भाग लिफ्ट गर्त के किसी भाग या इसमें अवस्थित किसी भाग से नहीं टकराएगा।

(ग) शीर्ष प्रतिभार अवकाश

शीर्ष प्रतिभार अवकाश निम्नलिखित चार मदों के योग से कम नहीं होगा:-

(i) निम्न कार रनबाई

(ii) प्रयुक्त कार बफर का स्ट्रोक

(iii) 15 सेमी० और

(iv) निम्नलिखित पर आधारित गुरुत्व अवरोधन दूरी का आधा

(क) उन स्थानों पर, जहाँ तेल बफर का उपयोग किया जाता है और प्रतिभार या कार बफर के जुड़ने पर इसके उछाल को रोकने की कोई व्यवस्था नहीं की गयी है, एक सौ पंद्रह प्रतिशत; और

(ख) उन स्थानों पर, जहां स्प्रिंग बफर का उपयोग किया जाता है, नियंत्रक ट्रिपिंग चाल।

(घ) लिफ्ट कार पर प्रक्षेप

उस समय जब लिफ्ट कार क्रॉस हैड इसके ऊपर निकटतम अवरोध से 60 सेमी० की दूरी पर हो लिफ्ट कार का कोई भी प्रक्षेप शिरोपरि संरचनाओं के किसी भाग से नहीं टकराना चाहिए।

5. अवतरण फाटक एवं दरवाजे

(क) सभी अवतरण द्वार फाटक या दरवाजों द्वारा रक्षित होने चाहिए और ये अवतरण द्वार पूरी ऊँचाई और पूरी चौड़ाई तक विस्तारित होने चाहिए। ये द्वार फाटकों या दरवाजों को बंद होने पर, किसी भी स्थिति में चौड़ाई में अवकाश 60 सेमी० से कम नहीं होना चाहिए।

(ख) सभी अवतरणों फाटकों की स्पष्ट ऊँचाई न्यूनतम 2 मी० तथा फाटक या दरवाजे का ऊपरी ट्रेक लिफ्ट कार के लिए प्रवेश को अवरुद्ध नहीं करना चाहिए। उन्हें सिमटवाँ या बंद पिकेट प्रकार के होने पर फाटक की पूर्ण विस्तारित अवस्था में पिकेट और ऊर्ध्वाधर के बीच 6 सेमी० से अधिक के अवकाश की अनुमति नहीं होगी।

(ग) अवतरण फाटक मजबूती से लगाए जाएंगे।

(घ) जहाँ अवतरण दरवाजा दो या अधिक पैनल युक्त हो वहां लिफ्ट कार दरवाजे और अवतरण फर्श के देहली कोर के निकटतम पैनल बीच का अवकाश 13 सेंटीमीटर से अधिक नहीं होना चाहिए और जहां अवतरण दरवाजा झूला दरवाजे के प्रकार का हो वहां ऐसे दरवाजे और लिफ्ट कार दरवाजे के बीच की दूरी 7.5 सेमी० से अधिक नहीं होनी चाहिए।

(ङ) लिफ्ट कार के देहली कोर और अवतरण फर्श के देहली कोर के बीच की दूरी 30 मिमी० से अधिक नहीं होनी चाहिए।

(च) अवतरण दरवाजों या फाटकों के मुख लिफ्ट कार से चौड़ा नहीं होना चाहिए।

(B) Governor tripping speed, where spring buffers are used.

Note:- The gravity stopping distance based on the gravity retardation from any initial velocity may be calculated according to the following formula, namely:- 'S= 5.1 V²'

Where 'S' is free fall in cm and 'V' is initial velocity in metres per second.

(b) Bottom car clearance –

When the car rests on its fully compressed buffer, there shall be a vertical clearance of not less than 60 cm between the floor of the lift-pit and the buffer striker plates or the lowest structural or mechanical part, equipment or device installed beneath the car platform, except the guide shoes, rollers, safety jaw blocks and platform apron or guard located within three hundred millimeters measured horizontally from the sides of the car platform when the car rests on its fully compressed buffers;

When the car rests on its fully compressed buffer, no part of the car or any equipment attached thereto shall strike any part of the lift-pit or any part of the equipment located therein.

(c) Top counterweight clearance –

The top counter-weight clearance shall be not less than the sum of the following four items, namely:-

(i) the bottom car runby;

(ii) the stroke of the car buffer used;

(iii) 15 cm; and

(iv) one half the gravity stopping distance based on-

(A) One hundred and fifteen percent of the rated speed, where oil buffers are used and no provision is made to prevent jump of counter-weight or car buffer engagement ; and

(B) Governor tripping speed, where spring buffers are used.

(d) Projection on lift- car-

When the lift-car cross-head is 60 centimeters from the nearest obstruction above it, no projection on the lift car shall strike any part of the overhead structures.

5. Landing gates and doors –

(a) All landing opening shall be protected by gate or doors which shall extend the full height and full width of the landing opening. These openings shall in no case be less than (68 cm) clear in width when the gates or doors are fully opened.

(b) All landings gates shall be at least 2m clear in height and the top track of the gate or door shall not obstruct the entrance to the lift car. They shall be, if collapsible, or a close picket type and no openings exceeding 6cm in width shall be permitted between pickets or verticals when the gate is fully extended.

(c) The landing gates shall be securely fixed.

(d) Where the landing door consists of two or more panels, the space between the panel nearest to the sill edge of the landing floor and the lift car door shall not exceed 13 centimeters, and where the landing door is a swing door, the distance between such door and the lift-car door shall not exceed 7.5 centimeters.

(e) The distance between the sill edge of the lift-car and the sill edge of the landing floor shall not exceed 30 millimeters.

(f) The opening for the landing gates or doors shall not be wider than the lift-car.

- (छ) स्वतः संवरण प्रकार के अवतरण फाटक या दरवाजों में ऐसी सुरक्षा युक्ति लगाई जाएगी कि लिफ्ट कार में प्रवेश करते या निकलते समय व्यक्ति को इसमें फंसकर चोट-ग्रस्त होने से बच सकें।
- (ज) सभी अवतरण फाटक या दरवाजे और उनके ट्रेक, दृष्टि पैनलों के अलावा, किसी बिंदु पर लगाए गए 34 किग्रा० के प्रणोद को सहन करने के योग्य होने चाहिए तथा इसके कारण इसमें स्थायी विकृति उत्पन्न नहीं होनी चाहिये और वे अपने रेतों से बाहर भी नहीं आने चाहिए।
- (झ) (क) अवतरण दरवाजे ठोस, हस्त प्रचालित प्रकार के होने और अवतरण दरवाजे के निकट या लिफ्ट कार के भीतर कोई संकेतक न लगे होने पर ऐसे सभी दरवाजों में दृष्टि पैनल लगे होने चाहिए।
 (ख) दृष्टि पैनल में काँच लगे होने पर, काँच अग्नि रोधी और सुरक्षित तारबद्ध होना चाहिए।
 (ग) सरकवाँ दरवाजे (स्लाइडिंग डोर) पर कोई प्रक्षेप या कोटर (दृष्टि पैनलों सहित) को न्यूनतम रखा जाना चाहिए ताकि दरवाजे के सरकवाँ हिस्से और किसी संरचना के स्थिर भाग में अंगुली को दबने से बचाया जा सके।
- (ञ) 24 मीटर से अधिक ऊँचाई वाले भवनों की लिफ्टों के लिए :-
 (i) अवतरण दरवाजों की अग्नि प्रतिरोधकता एक घंटे से कम की नहीं होनी चाहिए; और
 (ii) अग्नि लिफ्टों के लिए अवतरण दरवाजे पॉवर प्रचालित, स्वतः बंद ओर खुलने वाले प्रकार के होने चाहिए तथा शब्द "अग्नि लिफ्ट" (FIRE LIFT) प्रत्येक लिफ्ट के अवतरण दरवाजों पर रेडियम पेंट से लिखा जाना चाहिए। परन्तु 1500 किग्रा या इससे अधिक अनुबंधित भार पर प्रचालित होने के लिए डिजाइन माल-सह-यात्री लिफ्टों के मामले में पैरा की आवश्यकताओं में सरकार द्वारा छूट प्रदान की जा सकती है।

6. अवतरण फाटकों और दरवाजों के लिए पाशन युक्तियाँ

- (क) प्रत्येक अवतरण फाटक या दरवाजों में ऐसी विद्युत यांत्रिक पाशन युक्ति लगी होनी चाहिए जो इसके नीचे दी गयी संगत आवश्यकताओं को पूरा करती हों।
- (ख) (i) लिफ्ट कार को विशेष अवतरण जोन के भीतर पहुँचने से पूर्व अवतरण पार्श्व से अवतरण फाटक या दरवाजे को खोलना संभव नहीं होना चाहिए। फाटक या दरवाजे को आपात स्थिति में विशेष चाबी की सहायता से खोलने की व्यवस्था की जानी चाहिए और चाबी को संरक्षित अवस्था में रखा जाना चाहिए।
 (ii) अवतरण फाटकों या दरवाजों को बंद पाशित स्थिति में होने से पूर्व लिफ्ट कार को चालू करना या गतिशील बनाए रखना संभव नहीं होगा।
अपवाद:- लिफ्ट कार समतलन युक्ति दिए गए होने पर लिफ्ट कार को अवतरण जोन के भीतर लिफ्ट कार और अवतरण फाटकों या दरवाजों को खुला रखकर गति करने की अनुमति होती है।
टिप्पणी:- लिफ्ट दरवाजे को बंद माना जाएगा और दरवाजे को बाजू से 58 मिमी० के भीतर होने पर लिफ्ट कार को चलाया जा सकता है या मध्य में खुलने वाले दरवाजे के मामले में जब वे एक-दूसरे से 58 मिमी० के भीतर हो और ऐसी युक्ति लगी हो जिससे 58 मिमी. की सीमा में पहुँचने पर पुनः खुलने से रोकती है यह भी कि दरवाजा क्लोजर इस प्रकार का हो कि वे दरवाजे या दरवाजों को वस्तुतः बंद स्थिति में पहुँचा देता है।
- (iii) सभी पाशन युक्तियों के विद्युत और यांत्रिक भाग समुचित डिजाइन और निर्माण वाले होंगे। किसी निरीक्षण आवरण या आवरणों (कवर) का हटाना युक्ति के प्रचालन को प्रभावित नहीं करेगा सभी पाशन युक्तियों को उचित तरीके से अहाते में दृढ़ता पूर्वक लगाया जाएगा।
- (iv) अवतरण फाटकों या दरवाजों के लिए पाशन युक्तियाँ इस प्रकार डिजाइन होनी चाहिए कि फाटक या दरवाजा पाशित होने से पूर्व पाश सम्पर्क बंद न हो।
- (v) पाशन युक्ति में प्रयुक्त स्प्रिंग संपीडित अवस्था में और उचित प्रकार से आलंबित होना चाहिए।

- (g) The landing gates or doors which are self-closing shall be equipped with safety devices preventing injury by trapping persons while entering or leveling the lift-car.
- (h) All landing gates and doors and their tracks shall be capable of with-standing a thrust of 34 kg applied normally at any point excepting the vision panels, without causing permanent deformation or without being sprung from their guides.
- (i)
 - (a) Where the landing doors are solid and are manually operated and no indicators are provided either near the landing door or inside the lift-car, each of such doors shall be provided with a vision panel.
 - (b) Where the vision panel is provided with glass, such glass shall be fire-resistant and safety-wired.
 - (c) Any projection on or recess (including vision panels) in any sliding door shall be kept to the minimum so as to avoid finger trapping between the sliding part of the door and any fixed part of any structure.
- (j) For the lifts in buildings having height of more than 24 meters.
 - (i) the landing doors shall have fire resistance of not less than one hour; and
 - (ii) the landing door for fire lifts shall be power operated, automatic closing and opening type, and the words 'FIRE LIFT' shall conspicuously be displayed in red paint on lift landing doors on each floor. Provided that the requirement in para may be relaxed by Government in case of goods cum passenger lifts designed to operate at contract load of 1500 kg and above.

6. Locking devices for landing gates and doors

- (a) Every landing gate or door shall be fitted with an Electro-mechanical locking device which shall comply with the appropriate requirements given hereafter.
- (b)
 - (i) It should not be possible to open the landing gate or door from the landing side until the lift-car is within that particular landing zone. Provision shall be made for the opening of the gate or door in case of emergency by means of a special key, which shall be kept in a secured position.
 - (ii) It should not be possible to start the lift-car or keep it in motion unless all the landing gates or doors are locked in closed position.
Exception :- Where lift-car levelling device is provided, it is permitted to move the lift-car with the lift-car and landing gates or doors open within the landing zone.
Note:- The door shall be considered closed and the lift-car may be moved away from the landings when the door is within 58mm of the jamb, or in the case of center opening doors, when these are within 58mm of each other, provided an approved attachment is fitted which will effectively prevent the doors from being reopened after they reached a limit of 58mm and provided also that the door closer is of such a type as will eventually carry the door or doors to and lock it or them in the closed position.
 - (iii) The electrical and mechanical part of all locking devices shall be of substantial design and construction. The removal of any inspection cover or covers shall not affect the operation of a device.
 All locking devices shall be fixed securely to the enclosure by suitable means.
 - (iv) The locking devices for landing gates or doors shall be so designed that the lock contact is not closed until the gate or door is locked.
 - (v) Any springs used in the locking device shall be in compression and properly supported.

- (vi) पाशन युक्ति का संपर्क निर्माण ठोस और दृढ़ होने चाहिए तथा दक्षिणावर्त (धनात्मक रूप) में खुलना चाहिए तथा लिफ्ट कार के संचालन को रोकने के लिए अंतर्पाशन का प्रकार्य मात्र स्प्रिंग या स्प्रिंगों या गुरुत्व या विद्युत परिपथ के बंद होने पर निर्भर नहीं होना चाहिए।
- (vii) डिजाइन इस प्रकार का होना चाहिए कि कार्यशील पुर्जों का पर्याप्त घिसना पिटना असुरक्षित स्थिति उत्पन्न न करे या फाटक या दरवाजे के संचालन या इसकी फिटिंग्स से प्रचालन में बाधा न उत्पन्न करे।
- (viii) पाश के लिए संचालकों को वहन करने वाले मार्गदर्शी (कंडक्टर) या अनुबंध बाक्स बाक्सों के साथ दृढ़ता पूर्वक स्थापित तथा वैद्युत और यांत्रिक अविच्छिन्नता बनाए रखी जानी चाहिए।
- (ix) पाशन युक्ति को सक्रियण छड़ों या लीवरों के साथ, लिफ्ट कूप अहाते के अवतरण पार्श्व से बाधित होने से बचाया जाना चाहिए।
- (x) सभी लिफ्टों पर ऐसी युक्ति के लिए व्यवस्था की जानी चाहिए कि (लिफ्ट कार को) दूसरे तल के अवतरण जोन से गुजरते समय अवतरण फाटक या दरवाजे को खुलने से रोका जा सके।

7. लिफ्ट कार:-

- (क) लिफ्ट कारें पिंजरा काय, फाटकों या दरवाजों के द्वारा घिरा होना चाहिए। ऐसे अहाते स्पष्ट ऊँचाई में कम से कम 2 मी० तथा बिना किसी विवृति के किसी बिंदु पर लंबवत लगाए गए कम से कम 75 पाउंड के प्रणोद को सहन कर सके। यह कार फर्श या लिफ्ट कार ढांचे से इस प्रकार रक्षित होना चाहिए कि वह ढीला कार्य न करे या सामान्य सेवा में विस्थापित न हो। इसके लिए अंतस्छद ठोस या छिद्रित होनी चाहिए ताकि 68 किग्रा० वाले व्यक्ति को आलम्ब प्रदान करने के लिए समर्थ हो। अंतस्छद में कोई भी छिद्र 25 मिमी० व्यास वाले गोले को अस्वीकार कर देगा।
- (ख) लिफ्ट कार में निम्नलिखित के अलावा काँच का उपयोग नहीं किया जाना चाहिए:-
 - (i) प्रमाणपत्रों के लिए कवर
 - (ii) प्रकाश फिक्सर
 - (iii) कार प्रचालन से संबद्ध प्रयुक्त उपकरण
 - (iv) दृष्टि पैनलों और दर्पणों के लिए
 उक्त उद्देश्यों के लिए 930 वर्ग से०मी० से अधिक क्षेत्रफल में काँच का उपयोग किए जाने पर यह परतबंद प्रकार का होना चाहिए।
- (ख-1) लिफ्ट निरीक्षक द्वारा इस बात के लिए संतुष्ट होने पर कि कैम्पूल प्रकार की लिफ्ट कार के लिए काँच का उपयोग किया जा सकता है और इसे आग प्रतिरोध के लिए विशेष रूप से डिजाइन किया गया है और यह पूर्णतः पारदर्शी परतबंद प्रकार का है तो वह स्वयं द्वारा निर्धारित शर्तों के अधीन खंड (ख) के उपबंधों में छूट प्रदान कर सकता है।
- (घ) प्रत्येक लिफ्ट में दाब बटन द्वारा प्रचालित अलार्म सिग्नल लगा होना चाहिए। यह सिग्नल लिफ्ट कार में स्पष्ट स्थल पर स्थापित तथा स्पष्टतः चिह्नित होना चाहिए। यह अलार्म लिफ्ट मेन्स के अलावा वैद्युत मेन्स (मुख्य लाइन) से भी जुड़ा होना चाहिए तथा यह बाहर से स्पष्टतः श्रव्य होना चाहिए ताकि तलों के बीच ब्रेक डाउन होने पर सहायता प्राप्त की जा सके।
- (ङ) प्रत्येक कार के हेतु प्रत्येक फर्श पर पर्याप्त रोशनी प्रदान करने के लिए बत्ती लगायी जानी चाहिए और इसे प्रयोग के पूरे समय तक जलते रखा जाना चाहिए। ऐसी बत्ती लिफ्ट परिपथ से स्वतंत्र होनी चाहिए तथा बत्ती के लिए नियंत्रण स्विच मशीन कक्ष में मशीन के लिए मुख्य स्विच के निकट होना चाहिए।
- (च) प्रत्येक तल पर अवतरण फाटक के अभिगम को, प्रयोग के लिए लिफ्ट की पूरी उपलब्धता अवधि के दौरान रात में तथा, लिफ्ट निरीक्षक की इच्छानुसार, दिन को प्रकाशवान रखा जाना चाहिए।
- (छ) ठोस अहाता और दरवाजों वाली लिफ्टों और लिफ्ट कूप में पूर्णतः आवृत लिफ्ट कारों को विद्युत पंखों के द्वारा उचित रूप से संवातित रखा जाना चाहिए विद्युत पंखों को लिफ्ट की मुख्य लाइन से इतर विद्युत मुख्य लाइन से संयोजित तथा चालू हालत में बनाए रखा जाना चाहिए।

- (vi) The contacts of the locking device shall be of solid and sturdy construction and shall be opened positively and the functioning of the interlock to prevent movement of the lift-car shall not be solely dependent on the action of a spring or springs, not solely upon gravity, not upon the closing of an electric circuit.
- (vii) The design shall be such that reasonable wear and tear of working parts shall not create an unsafe condition or permit of interference with the operation of the lift by movement of the gate or door or its fittings.
- (viii) The conduit carrying the conductors to the lock or contact boxes shall be fixed securely to the boxes and shall maintain electrical and mechanical continuity.
- (ix) The locking device together with the actuating rods or levers shall be protected from interference from the landing side of the lift-well enclosure.
- (x) Provision shall be made on all lifts for device to prevent the opening of any landing gate or door while the lift-car is passing through a landing zone to another floor.

7. Lift Cars –

- (a) Lift-cars shall be enclosed on all sides by means of the cage body, gates or doors and such enclosures shall be at least 2m clear in height and sufficiently strong to withstand a thrust of at least 75 lbs applied normally at any point without deformation and it shall be so secured to the car-floor and lift-car frame that it cannot work loose or become displaced in ordinary service. There shall be provided a roof solid or perforated capable of supporting a weight of a man weighing 68 kg. Any perforation in the roof shall reject a 25mm diameter sphere.
- (b) Glass shall not be used in a lift-car except for the following purposes, namely:-
 - (i) covers for certificates,
 - (ii) lighting fixtures,
 - (iii) appliances used in connection with the operation of the car,
 - (iv) for vision panels and mirrors,
 Where the glass used for any of the said purposes is more than 930 square centimeters in dimension, it shall be of laminated type.
- (b-i) Where the Inspector of Lifts is satisfied that glass to be used is for a capsule-type lift car and it is specially designed for fire resistance and is of fully transparent laminated type, he may relax the provisions of clause (b), subject to such conditions as he may specify.
- (d) Every lift shall be provided with an alarm signal operated by a push button which shall be fixed in a conspicuous position in the lift-car and clearly marked. The alarm shall be wired from electric mains other than the lift mains and shall be clearly audible outside the lift-well in order to obtain assistance in case of a break-down of failure between the floors.
- (e) Every lift car shall be provided with a light to give sufficient illumination on the floor and such light shall be left burning during the whole time the lift is available for use. Such light shall be on a circuit independent of the lift circuits and the controlling switch for the light shall be in the machine room close to the main switch for the machine.
- (f) The approach to the landing gate on each floor shall be kept lighted during the whole time the lift is available for use at night, and during the day time, if so required by the Inspector of lifts.
- (g) Lift-cars having solid enclosure and doors and lift-cars installed in totally enclosed lift well shall be provided with adequate ventilation by means of an electric fan which shall be connected on electric mains other than the lift mains and shall always be maintained in working condition.

(ज) लिफ्ट कार के प्रत्येक प्रवेश पर दरवाजा या फाटक उपलब्ध कराया जाना चाहिए। प्रत्येक दरवाजे या फाटक लिफ्ट कार के मुख की पूरी ऊंचाई और चौड़ाई की रक्षा करेंगे और ये बिना किसी स्थाई विकृति के तथा गाइडों से बाहर न जाते हुए किसी बिन्दु पर लंबवत लगाए 34 कि.ग्रा. प्रणोद को सहन कर सकेंगे। फाटकों का प्रयोग किए जाने पर वे बंद पिकेट प्रकार के होने चाहिए तथा दरवाजे को पूर्णतः विस्तारित होने पर ऊर्ध्वाधरों के बीच 6 से० मी० से अधिक अवकाश की अनुमति नहीं होगी

(झ) प्रत्येक दरवाजे या फाटक के लिए विद्युत स्विच उपलब्ध करायी जाएगी जिससे लिफ्ट कार के दरवाजे या फाटक को उचित प्रकार से बंद करने से पूर्व इसे प्रारम्भ न किया जा सके या गतिशील अवस्था में न रखा जा सके। ऐसी स्विचें दरवाजे या फाटक को खुले रहने पर निश्चित रूप से खुली रहेंगी।

टिप्पणी - यह आवश्यकता लिफ्टकार दरवाजा या फाटक स्विच को लघुपथित पद्धति में करने से रोकती है ताकि स्वतः प्रचालित लिफ्ट दरवाजे या फाटक को खुला रखकर अवतरण तक कॉल न की जा सके।

(ञ) निरसित

(ट) निरसित

(ठ) लिफ्ट कार प्लेटफार्म फ्रेम (ढांचा) से निर्मित और इस आधार पर डिजाइन होगा कि अनुबंधित भार समान रूप से वितरित होगा। माल कार के लिए प्लेटफार्म लदान की विशेष प्रकृति के अनुसार डिजाइन किया जायेगा। न्यूनतम सुरक्षा गुणांक इस्पात के लिए 5 तथा काष्ठ के लिए 8 होगा।

(ड) प्रत्येक लिफ्ट कार के लिए एक आपात कालिक दरवाजा प्रदान किया जायेगा, उस समय जब एक लिफ्ट कूप में एक लिफ्ट प्रचालित हो रही हो तो अधःस्थ में या जहां एक लिफ्ट कूप में एक से अधिक लिफ्ट प्रचालित हो रही हो तो आसन्न लिफ्ट कार के निकट पार्श्व में लगाया जायेगा। आपातकालीन निकास के लिए परिस्थितियाँ उपयुक्त न होने पर सुरक्षा-गियर इस प्रकार का होना चाहिए कि इससे लिफ्ट कार को ऊपर करके मुक्त किया जा सके।

(ढ) शीर्ष निकास बाहर की ओर खुलना चाहिए और वे लिफ्ट-कार के ऊपर आरोपित सभी गियरों या उपकरणों से निर्बाधित होना चाहिए।

(ण) सभी आपातकालीन निकास दरवाजों या पैनलों के लिए विद्युत स्विच लगाई जानी चाहिए ताकि दरवाजों या पैनलों को खोलते या हटाते समय लिफ्ट को प्रचालित होने से रोका जा सके।

(त) लिफ्ट कार के ऊपर हैड लैंप के लिए उस पर कार्यरत व्यक्तियों के प्रयोग के हेतु एक प्लग सॉकेट प्रदान किया जाना चाहिए।

(थ) लिफ्ट कार समतलन युक्ति प्रयुक्त होने पर एग्रॉन को कार फर्श पर लगाया जाना चाहिए ताकि यह सुनिश्चित किया जा सके कि फर्श पर लिफ्ट कार को समतल करते समय देहली ओर अवतरण के बीच कोई अवकाश न रह सके।

(द) 24 मीटर से अधिक ऊँचे भवनों की लिफ्टों के लिए-

(i) फॉयर (अग्नि) लिफ्ट के लिए लिफ्ट कार का फर्श क्षेत्रफल 1.4 वर्ग मीटर से कम नहीं होना चाहिए।

(ii) लिफ्ट कार दरवाजों की अग्नि प्रतिरोधकता एक घंटा की होनी चाहिए।

(iii) फॉयर लिफ्ट के लिए लिफ्ट कार के दरवाजे पॉवर प्रचालित स्वतः बंद और खुलने वाले और अवतरण स्तर पर दरवाजे अवतरण दरवाजों के समक्रमित होने चाहिए।

टिप्पणी : परन्तु, 1500 किग्रा या इससे अधिक अनुबंधित भार पर प्रचालित होने के लिए डिजाइन माल सह-यात्री लिफ्टों के मामले में सरकार द्वारा पैरा (iii) की आवश्यकता में छूट प्रदान की जा सकती है।

8. लिफ्ट कार फ्रेम

(क) प्रत्येक लिफ्ट कार इस्पात गाटर के ऐसे पूर्ण फ्रेम में वहन की जानी चाहिए जो सुरक्षा गियर के प्रचालन को बिना किसी स्थायी विकृति के सहन करने के हेतु पर्याप्त दृढ़ हो।

(ख) लिफ्ट कार फ्रेम के घटक पुर्जों और उनके संयोजनों के सुरक्षा गुणांक, पदार्थ की अंतिम सामर्थ्य तथा उस पर लगाए गए स्थैतिक भार पर आधारित 5 से कम नहीं होना चाहिए।

(ग) लिफ्ट कार फ्रेम के ऊपर और नीचे दोनों ओर नवीकरणीय गाइड शूज या नवीकरणीय लाइनिंग वाले गाइड शूज लगाए जाने चाहिए।

(h) A door or gate shall be provided at each entrance of the lift car. Such doors or gates shall guard the full height and width of the lift car opening and shall be sufficiently strong to withstand a thrust of 34 kg applied normally at any point without permanent deformation and without their being sprung from their guides. Where gates are used they shall be of close picket type and no openings exceeding 6 cm in width shall be permitted between the verticals when the gate is fully extended.

(i) Each door or gate shall be provided with an electric switch which shall prevent the lift-car from being started or kept in motion unless the door or gate is properly closed. Such switches shall be opened positively when the door or gate is opened.

Note : This requirement prohibits the practice of short circuiting the lift-car door or gate switch to enable an unoccupied lift-car of an automatically operated lift to be called at a landing with the lift-car door or gate open.

(j) deleted

(k) deleted

(l) Lift-car platform shall be of framed construction and shall be designed on the basis of contract load evenly distributed. Platform for goods car shall be designed to suit the particular conditions of loading. The minimum factor of safety shall be 5 for steel and 8 for timber.

(m) Every lift-car shall be provided with an emergency exit which shall be fitted into the roof of the car in case where one lift operates in the lift-well or where more than one lift is installed in a lift-well, it shall be provided in the side adjacent to the adjoining lift-car. Where conditions will not allow the provision of an emergency exit, the safety-gear shall be of a type that can be released by hoisting up the lift-car.

(n) Top exit shall open outwards and shall be clear of all gear or equipment mounted on top of the lift-car.

(o) All emergency exit doors or panels shall be provided with an electric switch to prevent the lift from being operated when doors or panels are opened or removed.

(p) A plug socket shall be provided on top of the lift-car for a hand lamp for use by persons working thereon.

(q) When lift-car levelling devices are used, aprons shall be fitted to the car-floor to ensure that no space is permitted between the threshold and the landing whilst the lift-car is being levelled to a floor.

(r) For the lifts in buildings having height of more than 24 meters –

(i) Lift-car for fire lift shall have floor area of not less than 1.4 square meters;

(ii) Lift-car doors shall have fire resistance of one hour;

(iii) Lift-car for fire lift shall have power operated automatic closing and opening doors synchronised with landing doors while at landing level.

Note: Provided that requirement in para (iii) may be relaxed by government in case of goods-cum-passenger lifts designed to operate at a contract load of 1500 kgs and above.

8. Lift-car frame –

(a) Every lift-car shall be carried in a complete frame of steel girders which shall be sufficiently rigid to withstand the operation of the safety gear without permanent deformation.

(b) The factor of safety of the component parts of the lift-car frame and their connections shall be not less than 5 based on the ultimate strength of the material and the static load imposed on them.

(c) Renewable guide shoes or guide shoes with renewable linings shall be provided at the top and bottom of both sides of the lift-car frame.

9. लिफ्ट कारों में भार का उल्लेख

- (क) प्रत्येक लिफ्ट कार में सुरक्षित वहन किए जा सकने वाले व्यक्तियों की अधिकतम संख्या (68 किग्रा प्रति व्यक्ति के हिसाब से स्पष्ट स्थान पर लिखी जानी चाहिए। लिफ्ट कार में उक्त सीमा से अधिक व्यक्तियों को वहन नहीं किया जाएगा।
- (ख) माल लिफ्ट के लिए भार किलोग्राम में तथा व्यक्तियों की संख्या (68 किग्रा० प्रति व्यक्ति के भार के हिसाब से) भी दी जाएगी।

10. प्रतिभार

- (क) सभी प्रतिभारों को दृढ़ इस्पात गाइडों में यात्रा करनी चाहिये।
- (ख) यदि दो प्रतिभार एक ही गाइड में यात्रा कर रहे हों तो लिफ्ट कार प्रतिभार मशीन प्रतिभार के ऊपर तथा दोनों के बीच अवकाश 20 से० मी० से कम नहीं होना चाहिए। मशीन प्रतिभार की रज्जुओं को लिफ्ट-कार प्रतिभार से होकर गुजरने पर उन्हें धातु या अन्य उपयुक्त खोलों से ढका या रक्षित होना चाहिये। इस प्रकार के खोलों के सिरे "घंटीदार" (बेल्ट) प्रकार के तथा निलंबन रज्जुओं से दृढ़तापूर्वक जुड़े होने चाहिए और लिफ्ट कार प्रतिभार से 15 से० मी० से अधिक लम्बा (कम लंबा नहीं) होना चाहिए।
- (ग) यदि स्वतंत्र प्रतिभार का प्रयोग किया जाता है तो यह भार ऐसा नहीं होना चाहिए कि त्वरण या मंदन के दौरान निलंबन रज्जुओं में अनापेक्षित ढीलापन उत्पन्न करे।
- (घ) सभी प्रतिभार खंड इस्पात फ्रेम संरचना में वहन किए जाने चाहिए और वे सभी खंडों के छिद्रों से होकर गुजरने वाले कम से कम दो तान छड़ (टाई-रोड) द्वारा रक्षित होना चाहिए। प्रत्येक फ्रेम मेम्बर और अन्य फ्रेम मेम्बरों के साथ इसके संयोजन का सुरक्षा गुणांक निम्नलिखित से कम नहीं होना चाहिए।
- (i) इसके मेम्बर को पिटवां लोहा या इस्पात का होने पर-5, और
- (ii) इसके फ्रेम मेम्बर को ढलवां लोहे का होने पर-40
- (ङ) लिफ्ट गर्त में प्रतिभार की यात्रा मार्ग गर्त फर्श से 2 मीटर ऊंचे उपयुक्त अहाते के माध्यम से रक्षित होना चाहिए। बशर्ते यह कि गर्त फर्श से 30 सेमी० या प्रतिभार बफर के शीर्ष तक, जो भी उच्चतर हो, का अंतराल रखा जाना चाहिए।

11. गाइड

- (क) भवन में की जा रही प्रक्रियाओं की प्रकृति के परिणामस्वरूप अम्ल-धूम या ऐसे कारणों से इस्पात का उपयोग अनुपयुक्त होने के अलावा, लिफ्ट कार और प्रतिभार गाइडों के लिए दृढ़ इस्पात का उपयोग किया जाना चाहिए।
- (ख) 0.4 मीटर प्रति सेकेंड से अधिक चाल पर कार्य करने वाली लिफ्टों के लिए केवल विशेष "लिफ्ट T सैक्शन गाइड" का उपयोग किया जाना चाहिए और इन्हें मशीनित स्पिंगर और सांकेट या अन्य उपयुक्त माध्यम से जोड़ा जाएगा।
- (ग) गाइडें लिफ्ट कूप की पूरी लम्बाई तक अविच्छिन्न होना चाहिए और ऐसी डिजाइन और अवकाश वाली समुचित लौह या इस्पात ब्रेकिट या समतुल्य दृढ़कारक प्रदान किये जाने चाहिए कि सामान्य प्रचालन के अधीन गाइडें 6 मिमी० से अधिक विकेपित न हों।
- (घ) गाइडों को ऊपर लटकती सीढ़ियों से संयोजित होने पर स्थिरण की विधि ऐसी होनी चाहिए कि कोई उर्ध्वाधर प्रतिबन्ध गाइडों से सीढ़ियों का अंतरित न हो।
- (ङ) गाइडों की लम्बाई इतनी होनी चाहिए कि किसी भी कार या प्रतिभार गाइड शूज को गाइडों से बाहर जाना सम्भव न हो।
- (च) गाइड ब्रेकिट ओर पत्तियां, यदि कोई हो, इस्पात की होनी चाहिए और इसे लिफ्ट कूप अहाते से तब तक सीधे आलंबित या बद्ध नहीं किया जाना चाहिए जब तक कि दीवार का निर्माण इतना ताकतवर न हो कि वह लिफ्ट सेवा की सभी दशाओं के अन्तर्गत गाइडों पर पड़ने वाले प्रणोद को भली प्रकार सहन कर सके। दीवार में निर्मित बंध ब्लॉक के माध्यम से या विस्तार बोल्ट या ऐसी मोटाई ओर आकार के धातु (प्लेटों के) बोल्टों के माध्यम से बंधन किया जायेगा ताकि दीवार पर भार को समुचित ढंग से वितरित किया जा सके।

Load to be marked in lift-cars-

- (a) There shall be marked conspicuously in every lift-car the maximum number of persons (calculated at 68 kg per person) which it can safely carry. Persons in excess of the said limit shall not be carried in the lift-car.
- (b) For goods lift the load shall be given in kilograms and also in persons calculated at 68 kg per person.

10. Counter-weights –

- (a) All counter-weights shall travel in rigid steel guides.
- (b) If two counter-weights travel in the same guides, the lift-car counter-weight shall be above the machine counter-weight and the clearance between them shall not be less than (20 cm). Where the ropes of the machine counter-weight pass through the lift-car counter-weight, they shall be covered or protected by metal or other suitable sleeves. Such sleeves shall have 'belled' ends and be firmly attached to the suspension ropes, and be not less than 15 cm longer than the lift-car counter-weight.
- (c) If an independent counter-weight is used, it shall not be of such a weight as to cause undue slackening of any of the suspension ropes during acceleration or retardation.
- (d) All counter-weight sections shall be carried in a structural steel frame and shall be secured by at least two tie rods passing through holes in all the sections. The factor of safety of each frame member and its connection with other frame members shall not be less than:
 - (i) 5, where the member is of wrought iron and steel, and
 - (ii) 40, where the frame member is of cast iron.
- (e) The travel-way of the counter-weight in the lift-pit shall be protected by means of a suitable enclosure work up to a height of 2m from the floor of the pit. Provided that a gap of 30 centimeters or up to the top of the counter-weight buffer, whichever is higher, may be kept from the floor of the pit.

11. Guides –

- (a) The guides for the lift-car and the counter-weights shall be rigid and shall be of steel except where the nature of the processes carried on in the building renders such material unsuitable due to acid-fumes or similar causes.
- (b) In case of lift working at a speed exceeding 0.4 metre per second, special 'Lift T section Guides' only shall be used and they shall be joined by means of machined spigot and socket joints or other adequate means.
- (c) Guides shall be continuous throughout the entire length of the lift-well, and shall be provided with adequate iron or steel brackets or equivalent fixing of such design and spacing so that the guides shall not deflect more than 6mm under normal operation.
- (d) If the guides are attached to overhanging stairs, the method of fixing shall be such that no vertical stress is transferred from the guides to the stairs.
- (e) Guides shall be of such length that it will not be possible for any of the car or counter-weight guide shoes to run off guides.
- (f) Guide brackets and shims if any shall be of steel and shall not be directly supported and fastened to the lift-well enclosure wall unless such wall is of such construction and strength as to adequately withstand the thrust imposed on the guides under all conditions of the lift-service. The fastening shall be by means of bond blocks built into the wall or expansion bolts or through bolts with metal plates of such thickness and size as to adequately distribute the load on the wall.

- (छ) गाइडों और उनके स्थिरकों को, यदि उन्हें सुरक्षा गियर के साथ प्रदान किया गया है, पूर्णतः भरी लिफ्ट-कार या प्रतिभार को रोकते समय सुरक्षा गियर के अनुप्रयोग को सहन करने में सक्षम होना चाहिए।

on the inside of the drum.

12. बफर

- (क) स्प्रिंग या तेल बफर को लिफ्ट-कार के नीचे सीधे या उपर्युक्त कंक्रीट या इस्पात आधार वाले लिफ्ट गर्त के फर्श पर फिट की जानी चाहिए। परन्तु 0.25 मीटर प्रति सैकेंड से अनाधिक अनुबंधित चाल वाली लिफ्टों के लिए तेल प्रतिरोधी रबड़ बफर का प्रयोग किया जा सकता है।
- (ख) बफर का डिजाइन और निर्माण इस प्रकार का होना चाहिए कि वह अपनी स्ट्रोक सीमा के भीतर, तथा उस समय जब संघट्ट चाल अधिकतम चालन चाल के बराबर हो, अपने निर्धारित भार को वहन कर रही लिफ्ट कार की पूरी गतिज ऊर्जा को अवशोषित कर सके।
- (ग) 1.5 मीटर प्रति सैकेंड तक की निर्धारित चाल वाली लिफ्टों के लिए स्प्रिंग या तेल बफर का प्रयोग किया जा सकता है। 1.5 मीटर प्रति सैकेंड से अधिक की निर्धारित चाल वाली लिफ्टों के लिए तेल बफर का प्रयोग किया जाएगा।
- (घ) बफर के लिए स्प्रिंग को इस प्रकार डिजाइन किया जायेगा कि वे नियंत्रक की ट्रिपिंग चाल पर पूर्णतः भरी लिफ्ट कार की ऊर्जा अवशोषित करने के बाद स्थायी आकार न ले लें।
- (ङ) 91 मीटर प्रति मिनट से अधिक की अनुबंधित चाल वाली लिफ्टों के लिए तेल बफर या इसके समतुल्यों का प्रयोग किया जा सकता है।
- (च) नियंत्रक की ट्रिपिंग चाल पर आधारित तेल बफर की अधिकतम मंदन दर 24.54 मीटर/से० अर्थात् गुरुत्व मंदन का 2.5 गुना से अधिक नहीं होना चाहिए।
- (छ) सम्मिलित निलंबन रज्जुओं के सुरक्षा गुणांक निम्नलिखित से कम नहीं होने चाहिए :-

रज्जु चाल (मीटर में)	सुरक्षा गुणांक
2 मीटर प्रति सैकेंड	10
3.5 मीटर प्रति सैकेंड	11
7 मीटर प्रति सैकेंड	12

संकर्षण प्रकार के चालन के मामले में सुरक्षा गुणांक स्थैतिक अनुबंधित भार, धन लिफ्ट कार और उप-साधनों के भार पर आधारित होगा। ड्रम प्रकार की चालन मशीनों के मामले में सुरक्षा गुणांक की गणना गतिक दशाओं के साथ की जायेगी।

- (ज) तेल बफर के साथ एक ऐसी युक्ति प्रदान की जानी चाहिए जिससे उसके भीतर की तेल की मात्रा को सुनिश्चित किया जा सके।
- (झ) बफर को लिफ्ट कार के गुरुत्व केन्द्र के सापेक्ष सममित रूप से स्थापित किया जाना चाहिए और इसे इस प्रकार व्यवस्थित किया जाना चाहिये कि लिफ्ट कार सामान्य प्रचालन परिस्थितियों में इससे न टकरा सके।
- (ञ) बफर को, लिफ्ट कार के लिए यथा विनिर्धारित भार के नीचे, सममित रूप से प्रतिभार के नीचे स्थापित किया जायेगा।

13. निलम्बन रज्जु

- (क) लिफ्ट कार के लिए चेन का उपयोग नहीं किया जाएगा। संकर्षण चालन वाली किसी लिफ्ट के लिफ्ट कार और प्रतिभार के लिए प्रयुक्त स्वतंत्र निलंबन रज्जुओं की संख्या 3 तथा ड्रम चालन के लिए 2 से कम नहीं होनी चाहिए।
- (ख) प्रत्येक निलम्बन रज्जु को कार और प्रतिभार के साथ पृथक और स्वतंत्र रूप से दृढ़ किया जाना चाहिए। चरखी या समान उपाय से लिफ्ट कार या प्रतिभार को सरलतापूर्वक निलम्बित किया जाना केवल एक निलम्बन गिना जाना चाहिए।
- (ग) कुंडली अर्थात् वाइडिंग ड्रम से बंधी सभी रज्जुओं के लिए यह आवश्यक है कि लिफ्ट कार या प्रतिभार को इसकी अतियात्रा की अंतिम सीमा तक पहुंचाने के बाद कुंडली ड्रम पर डेढ़ फेरों से कम रज्जु शेष नहीं होनी चाहिए।

- (g) Guides and their fixing shall withstand the application of the safety gear when stopping a fully loaded lift-car or the counter-weight if provided with a safety gear.

12. Buffers –

- (a) Buffers of spring or oil shall be fitted under the lift-car directly or on the floor of the lift-pit with suitable concrete or steel foundation. Provided that, oil resistant rubber buffers may be used with lifts having contract speed not exceeding 0.25 metre per second.
- (b) Buffers shall be of such design and construction as to be able to absorb within the limits of their stroke the whole of the kinetic energy of the lift car carrying its rated load when the speed of impact is the maximum running speed.
- (c) Spring or oil buffers shall be used with lifts having a rated speed upto 1.5 metres per second. Oil buffers shall be used with lifts having a rated speed in excess of 1.5 metres per second.
- (d) Springs for the buffers shall be so designed that they will not take a permanent set upon absorbing the energy of the fully loaded lift car at governor tripping speed.
- (e) Oil buffers or their equivalent shall be used with lifts having a contract speed in excess of 91 m per minute.
- (f) The maximum rate of retardation of oil buffers, based on governor tripping speed, shall not be in excess of 24.54m per second i.e. 2.5 times gravity retardation.
- (g) The factor of safety of the combined suspension ropes shall not be less than the following namely-

<i>Rope speed in meters</i>	<i>Factors of Safety</i>
Upto 2 meters per second	10
3.5 meters per second	11
7 meters per second	12

The factor of safety shall be based on static contract load plus the weight of the lift-car and accessories in the case of traction type drive. In the drum type drive machines, the factor of safety shall be calculated with dynamic conditions.

- (h) Oil buffers shall be provided with a device for determining easily the amount of oil in them.
- (i) Buffers shall be placed symmetrically with respect to the center of gravity of the lift-car and shall be so arranged that the lift-car in normal circumstances of operation cannot strike them.
- (j) Buffers shall be fitted under the counter-weight similar to those specified for lift-car arranged symmetrically below the weight.

13. Suspension ropes-

- (a) Chain shall not be used for the suspension of a lift car. Not less than three independent suspension ropes shall be used for the lift car or counter-weight of any lift with traction drive, and not less than two independent ropes with drum drive.
- (b) Each suspension rope shall be, separately and independently fixed to the car and to the counter-weight. The simple suspension of the lift car or the counter-weight by means of a sheave or the like shall count as one suspension only.
- (c) All ropes anchored to a winding drum shall have not less than one and one half turns of the ropes on the winding drum when the lift car or counter weight has reached the extreme limit of its over-travel.

(घ) लिफ्ट कार और प्रतिभार रज्जुओं के कुंडली ड्रम सिरे ड्रम के भीतर क्लैपों के द्वारा सुरक्षित किए जाने चाहिए।

(ङ) प्रत्येक लिफ्ट कार या प्रतिभार रज्जु समान लम्बाई की तथा जोड़ रहित होनी चाहिए।

14. आपातकालीन सुरक्षा युक्तियाँ

- (क) प्रत्येक लिफ्ट के लिए लिफ्ट कार फ्रेम से सम्बद्ध तथा कार-प्लेटफार्म के ठीक नीचे स्थापित एक लिफ्ट-कार सुरक्षा गियर प्रदान किया जाना चाहिए। सुरक्षा गियर, लिफ्ट कार में पूरे अनुबंधित भार के साथ, लिफ्ट कार को रोकने और उसे सहन करने के योग्य होना चाहिए।
- (ख) सुरक्षा गियर के अनुप्रयोग के कारण कार प्लेटफार्म 6 मिमी० प्रति फुट से अधिक तल से बाहर नहीं होना चाहिए तथा तल को किसी भी दिशा में मापा जा सकता है।
- (ग) किसी भी सुरक्षा गियर को आरोही लिफ्ट कार या प्रतिभार को रोकने की अनुमति नहीं दी जायेगी, यदि अति-चाल के कारण आरोही लिफ्टकार को रोकना हो तो इस उद्देश्य के लिए प्रतिभार के साथ एक सुरक्षा गियर स्थापित किया जाना चाहिए। तथापि नियंत्रक मोटर परिपथ को खोल सकता है और आरोहण की दिशा में अतिचाल के मामले में ब्रेक लगा सकता है।
- (घ) सुरक्षा गियर लगाने के दौरान, इसे लगाने के लिए, या अवरोहण की दिशा में लिफ्ट कार की गति से किसी रज्जु के तनन में हुई किसी कमी से सुरक्षा गियर मुक्त नहीं होगा। लिफ्ट मशीन की दिशा को विपरीत करके सुरक्षा गियर को मुक्त करना स्वीकार्य है।
- (ङ) सुरक्षा गियर को प्रचालित होने पर यह स्वतः प्रचालन परिपथ को खोल देगा, और उपयुक्त व्यक्ति के लिए यह सम्भव होगा कि वह उपस्कर का अच्छी तरह से निरीक्षण करके आवश्यक सावधानी बरतने के बाद सुरक्षा गियर को मुक्त कर सके।
- (च) निलम्बन रज्जुओं के विफल होने पर या अवरोहण की दिशा में लिफ्ट की चाल पूर्व निर्धारित अधिकतम चाल से अधिक होने पर, उस समय चाल नियंत्रक लगाया गया हो, सुरक्षा गियर लिफ्ट कार को रोकने और उसे बनाये रखने के लिए प्रचालित होगा।
- (छ) प्रत्येक सुरक्षा गियर इसके निर्माण में प्रयुक्त स्प्रिंग से मुक्त रहकर घनात्मक और यांत्रिक रूप से प्रचालित होगा।
- (ज) शैफ्ट द्वारा प्रचालित कोई लीवर या कुत्ता (डॉग) कुंजियों द्वारा ऐसे शैफ्टों के साथ कुंजियित किया जाएगा या लिफ्ट निरीक्षक द्वारा अनुमोदित कोई अन्य सामान सुरक्षित युक्ति द्वारा स्थिर किया जाएगा।
- (झ) सुरक्षा गियर का डिजाइन इस प्रकार का होगा कि इसे दोन्नों गाइडों के लिए तथा समान रूप में ऐसी गाइडों के दोनों ओर प्रयोग में लाया जा सके।
- (ञ) सुरक्षा गियर के अनुप्रयोग के लिए प्रयुक्त कोई रज्जु स्वतंत्र शैफ्ट पर स्वतंत्र पुली के ऊपर से होकर जाएगी और उचित प्रकार से रक्षित होगी। ऐसे रज्जु कम व्यास के नहीं होने चाहिए तथा इस्पात या फास्फर ब्राज के बने होने चाहिए।
- (ट) लिफ्ट कार फ्रेम के कंपन के कारण सुरक्षा गियर का लगना सम्भव नहीं होगा।
- (ठ) तनाव, ऐंठन का बंकन से प्रभावित होने वाले सुरक्षा गियर के पुर्जे इस्पात द्वारा निर्मित होंगे।
- (ड) सुरक्षा गियरों से संबंधित ड्रमों और स्कू-शैफ्टों के सभी बियरिंग अ-लौह धातु के होंगे।
- (ढ) कार और प्रतिभार सुरक्षा युक्तियाँ पृथक नियंत्रकों द्वारा सक्रिय की जाएंगी। ऐसी व्यवस्था की जाएगी कि लिफ्ट कार सुरक्षा गियर को लगाने के 10% अधिक पर प्रतिभार सुरक्षा गियर लगाया जा सके।
- (ण) सुरक्षा गियर निम्नलिखित प्रकार के होंगे, नामतः :-
- (i) तात्क्षणिक प्रकार का, 200 फिट प्रति मिनट से अनधिक चाल तक के लिये सीमित (टाइप I)
 - (ii) क्रमिक फन्नी क्लैप टाइप, क्रमिक वर्धमान मंदन बल के साथ (जी. डब्ल्यू. सी)
 - (iii) नम्य गाइड क्लैप टाइप, स्थिर मंदन बल के साथ (एफ.जी.सी.)
 - (iv) 2.5 मीटर प्रति सैकेंड से अनाधिक चाल के लिए क्रमिक और तेल बफर सुरक्षा का सम्मिश्रण
- (त) कार या प्रतिभार की संबंधित दूरी (के भीतर) लिफ्टकार या प्रतिभार को रोकने के लिए डिजाइन किए गए सुरक्षा गियर

- (d) The winding drum end of the lift-car and counter-weight ropes shall be secured by clamps on the inside of the drum.
- (e) Every lift-car or counter-weight rope shall be in one length and free from joints.

14. Emergency Safety Devices –

- (a) Every lift shall be provided with a lift-car safety gear, attached to the lift-car frame and placed beneath the car-platform. The safety gear shall be capable of stopping and sustaining the lift-car with full contract load in the lift-car.
- (b) The application of the safety gear shall not cause the car-platform to become out of level in excess of 6mm per foot measured in any direction.
- (c) No safety gear shall be permitted to stop an ascending lift-car or counter-weight, if an ascending lift-car is to be stopped on account of over speed, a safety gear shall be fitted to the counter-weight for this purpose. The governor may, however, open the motor circuit and apply the brake in the event of over speed in the ascending direction.
- (d) When the safety gear is being applied, no decrease in the tension of any rope for applying the safety gear, or motion of the lift-car in the descending direction shall release the safety gear. It is permissible to release the safety gear by reversing direction of the lift machine.
- (e) When a safety gear comes into operation, it shall automatically open the operating circuit, and it shall be possible for a reasonable person to release the safety gear after a thorough inspection of the equipment after taking necessary precautions.
- (f) The safety gear shall operate to stop and sustain the lift-car in the event of failure of the suspension ropes, or in the event of the lift exceeding a predetermined maximum speed in the descending direction when a speed governor is fitted.
- (g) Every safety gear shall operate positively and mechanically independently of any springs used in its construction.
- (h) Any levers or dogs operated by shafts shall be keyed to such shafts by keys or fixed by some other equally secure device approved by the Inspector of Lifts.
- (i) The design of the safety gear shall provide for its application to both guides and to each side of such guides equally.
- (j) Any rope used for applying the safety gear shall be led over independent pulleys running on independent shafts and properly guarded. Such ropes shall be not less than in diameter and shall be of steel or phosphor bronze.
- (k) It shall not be possible for vibrations of the lift car frame to cause the safety gear to be applied.
- (l) Any part of a safety gear subject to tension, torsion or bending shall be made of steel.
- (m) All bearings for drums and screw shafts in connection with the safety gears shall be of non-ferrous metals.
- (n) Car and counter weight safety devices shall be actuated by separate governors. Provision shall be made to cause the application of the counterweight safety gear at not more than 10 percent in excess of that at which the lift-car safety gear applies.
- (o) The types of safety gear shall be of the following kinds, namely:-
 - (i) Instantaneous type limited to speed not exceeding 200 feet per minute (Type I).
 - (ii) Gradual wedge clamp type with gradual increasing retarding force (G.W.C.)
 - (iii) Flexible guide clamp type with constant retarding force (F.G.C.)
 - (iv) Combination of instaneous and oil buffer safety for speed not exceeding 2.5 meters per second.
- (p) Safety gears designed to stop the lift-car or counter-weight in a distance related to the car or counter-weight speed shall stop the lift-car with rated load or the counter-weight from

निर्धारित भार के साथ लिफ्ट कार को या विरामी दूरी की रेंज के भीतर नियंत्रक की ट्रिपिंग चाल से प्रति भार को निम्नलिखित सारणी में दिए अनुसार रोकेंगे।

व्याख्या:- इस उप-खंड के उद्देश्य के लिए "विरामी दूरी" का अर्थ सुरक्षा गियर द्वारा गाइडों पर निशानों से यथा प्रेक्षित किया गया वह वास्तविक सर्पण है।

सारणी

क्रम सं	नियंत्रक की ट्रिपिंग चाल (मीटर प्रति सेकेंड में)	विरामी दूरी (मिमी० में)	
		अधिकतम	न्यूनतम
1.	0.88	368	161
2.	1.00	401	173
3.	1.25	482	202
4.	1.5	582	237
5.	1.75	700	278
6.	2.00	836	326
7.	2.25	990	380
8.	2.5	1162	441

टिप्पणी:- क्रमिक फन्नी क्लैप और नम्य गाइड क्लैप टाइप की सुरक्षाओं के लिए लिफ्ट कार और प्रतिभार की सभी मध्यवर्ती चालों के लिए अधिकतम विरामी दूरी को निर्धारित करने के लिए निम्नलिखित सूत्र का प्रयोग किया जा सकता है:-

$$S1 = 245 V^2 + 256$$

$$S2 = 51 V^2 + 122$$

इस सूत्र में 'S1' अधिकतम विरामी दूरी मिमी. में प्रदर्शित करता है; 'S2' न्यूनतम विरामी दूरी मिमी. तथा 'V' नियंत्रक की ट्रिपिंग चाल मीटर प्रति सेकेंड में प्रदर्शित करता है।

- (ख) सुरक्षा जबड़ों (सेफटी जॉ) द्वारा गाइडों को पकड़ने तथा लिफ्ट कार को रोके जाने के पश्चात् किसी सुरक्षा गियर ड्रम से संलग्न रज्जु के ड्रम पर शेष रज्जु का परिमाण दो फेरों से कम नहीं होनी चाहिए।
- (घ) कोई सुरक्षा गियर अपने प्रचालन के लिए किसी परिपथ की पूर्णता या अनुरक्षण पर निर्भर नहीं होगा। सभी सुरक्षा गियर यांत्रिक रूप से लगाए जाएंगे।
- (ङ) लिफ्ट कार प्रतिभार सुरक्षा गियर के पकड़ पृष्ठ का उपयोग लिफ्ट कार या प्रतिभार को गाइड करने के लिए नहीं किया जाएगा परन्तु यह लिफ्ट के सामान्य प्रचालन के दौरान गाइडों से मुक्त रहकर चलेगा।

टिप्पणी - ऊर्ध्वाधर या पर्याप्त ऊर्ध्वाधर दिशा में यात्रा कर रही लिफ्टों के लिए पॉल या रैचिट का सुरक्षा गियर पर्याप्त नहीं माना जाना चाहिए।

15. अतिचाल नियंत्रक -

- (क) 5.5 मीटर से अधिक की यात्रा करने वाली लिफ्ट को एक ऐसे अति चाल नियंत्रक से सज्जित होना चाहिए जो लिफ्ट कार की चाल अवरोहण की दिशा में पूर्व निर्धारित सीमा से अधिक होने पर सुरक्षा गियर को लगाने के लिए प्रचालित हो जाएगा।
- (ख) नियंत्रक को ऐसे स्थान पर स्थापित किया जाएगा जो सरलतापूर्वक अभिगम्य और लिफ्टकार द्वारा अति यात्रा करने पर यह फंसे नहीं तथा नियंत्रक के पुर्जों की पूरी गति के लिए पर्याप्त अवकाश मौजूद है।
- (ग) नियंत्रक रज्जु का व्यास 8 मिमी. से कम नहीं होना चाहिए और इस्पात या फॉस्फर ब्रांज की तथा उपयुक्त निर्माण की होनी चाहिए।

the governor tripping speed within the range of stopping distances given in the table below.
Explanation – For the purpose of this sub-clause “the stopping distance” means the actual slide as observed from the markings on the guides made by the safety gear.

TABLE

Serial No	Governor tripping speed in meters per second	Stopping distance in millimeter	
		Maximum	Minimum
1.	0.88	368	161
2.	1.00	401	173
3.	1.25	482	202
4.	1.5	582	237
5.	1.75	700	278
6.	2.00	836	326
7.	2.25	990	380
8.	2.5	1162	441

Note – The following formula shall be used to determine the maximum stopping distances for gradual wedge clamp and flexible guide clamp type safeties for lift-car and counter weight for all intermediate speeds:-

$$S1 = 245 V^2 + 256$$

$$S2 = 51 V^2 + 122$$

In this formula, 'S1' represents the maximum stopping distance in millimeters; 'S2' represents the minimum stopping distance in millimeters and 'V' represents Governor tripping speeds in meters per second.

- (q) The rope attached to any safety gear actuating drum shall have not less than two turns of rope remaining on the drum after the safety jaws have gripped the guides and stopped the lift-car.
- (r) No safety gear shall depend on the completion or maintenance of an electric circuit for its operation. All safety gears shall be applied mechanically.
- (s) The gripping surfaces of lift-car or counter-weight safety gears shall not be used to guide the lift-car or counter-weight but shall run free of the guides during normal operation of the lift.
Note – A pawl or ratched shall not be held to constitute a sufficient safety gear for lifts travelling in a vertical or substantially vertical direction.

15. Over speed Governor

- (a) Every lift having a travel exceeding 5.5 m shall be equipped with an over speed governor device which will operate to apply the safety gear in the event of the speed of the lift car in the descending direction exceeding a predetermined limit.
- (b) The governor shall be placed where it is easily accessible and where it can not be struck by the lift-car in case of over travel and where there is sufficient space for the full movement of the governor parts.
- (c) Governor ropes shall be not less than 8mm in diameter and shall be of steel of phosphor bronze and of suitable construction.

(घ) नियंत्रक रज्जु और नियंत्रक चरखी द्वारा निर्मित संपर्क वक्र रज्जु तनन युक्ति के साथ मिलकर पर्याप्त आकर्षण प्रभाव उत्पन्न करता है ताकि नियंत्रक का उचित प्रचालन किया जा सके।

- (ङ) लिफ्ट के सामान्य प्रचालन के दौरान नियंत्रक की रज्जु नियंत्रक के जबड़े (गवर्नर जॉ) से निर्बाध बाहर निकलनी चाहिए।
- (च) नियंत्रक के जबड़े (गवर्नर जॉ) और उनकी आरोपिकाएं उस प्रकार डिजाइन की जानी चाहिए कि रज्जु के अनुप्रयोग के परिणाम स्वरूप रज्जु किसी कटने, फटने या विकृति से सुरक्षा गियर के उचित प्रचालन में कोई बाधा उत्पन्न नहीं होगी।
- (छ) मोटर नियंत्रण परिपथ और ब्रेक नियंत्रण परिपथ नियंत्रक के ट्रिप होने से पहले खुलने चाहिए।
- (ज) कार सुरक्षा गियरों के नियंत्रकों को, सुरक्षा गियर सक्रिय करने के लिए निम्नलिखित चाल पर समायोजित किया जाएगा:-
 - (i) 1 मीटर प्रति सेकेंड या इससे कम की निर्धारित चाल के लिए नियंत्रक की ट्रिपिंग चाल निर्धारित चाल का 140% या 0.88 मीटर प्रति सेकेंड, जो भी अधिक हो, होगी। निर्धारित चाल या 1 मीटर प्रति सेकेंड से अधिक की चाल के लिए नियंत्रक की अधिकतम ट्रिपिंग चाल निर्धारित चाल का 115% धन 0.25 मीटर प्रति सेकेंड होगी।
 - (ii) नियंत्रक की न्यूनतम ट्रिपिंग चाल का निर्धारित चाल का 115% होगी,
 - (iii) नियंत्रक के आधार पर या आधार से संलग्न पीतल की प्लेट पर नियंत्रक की उचित ट्रिपिंग चाल लिखी होगी।

16. श्लथ (स्लैक) रज्जु स्विच

- (क) कुंडली अर्थात् वाइंडिंग ड्रम मशीनों वाली सभी लिफ्टों में एक ऐसी प्रभावी श्लथ रज्जु स्विच लगी होनी चाहिए जो लिफ्ट कार की अवरोहण की दिशा यात्रा के दौरान अवरूद्ध होने पर पॉवर को बंद कर दे और मशीन को रोक दे।
- (ख) श्लथ रज्जु स्विचों का डिजाइन ऐसा होगा कि वे रज्जु में से श्लथ को निकालने के पश्चात् स्वतः रीसेट नहीं होगी।
- (ग) श्लथ रज्जु स्विचों के सक्रिय भागों को विवृत्त किया जाएगा ताकि अचानक इसके सम्पर्क में आने से बचा जा सके।

17. मशीन कक्ष तथा शिरोपरि संरचना

- (क) लिफ्ट कूप या अन्यत्र कार्य कर रहे उपकरणों और उपस्करों के अलावा लिफ्ट मशीन नियंत्रक और लिफ्ट अधिष्ठापन के अन्य सभी उपकरणों और उपस्करों को मशीन कक्ष में स्थापित किया जाएगा।
- (ख) मशीन कक्ष का डिजाइन इस प्रकार का होना चाहिए कि उपस्कर के सभी भागों तक निर्बाध और सरलतापूर्वक पहुँचा जा सके तथा किसी भी दशा में मशीन के चारों ओर 60 सेमी० से कम चौड़ा अवकाश न रहे। विभिन्न इकाइयों को निकालने या बदलने को सुकर बनाने की व्यवस्था की जानी चाहिए।
- (ग) मशीन कक्ष के फर्श को इस प्रकार डिजाइन और निर्मित किया जाएगा कि वह किसी भी बिन्दु पर उपस्कर के सर्वाधिक भारी भाग को सुरक्षापूर्वक वहन कर सके और यदि फर्श अहाता दीवार तक विस्तारित न हो तो खुले पार्श्व को उचित उपाय द्वारा समुचित ढंग से रक्षित किया जाएगा।
- (घ) मशीन कक्ष की उँचाई इतनी पर्याप्त होनी चाहिए ताकि उपस्कर के किसी भाग तक पहुँचा जा सके और मरम्मत तथा बदलने के लिए इसे निकाला जा सके और यह फर्श या मशीन के प्लेटफार्म (जो उँचा हो) से 1.98 मी० से कम उँची नहीं होनी चाहिए।
- (ङ) मशीन कक्ष के लिए स्थायी और शीर्ष लिफ्ट अवतरण से सीधे सुरक्षित और सरल अभिगम प्रदान किया जाएगा। प्रवेशद्वार का मुख पर्याप्त बड़ा होना चाहिए कि इसमें से मशीनरी के पुर्जों को निकालने और बदलने के लिए बाधा उत्पन्न न हो।
- (च) मशीन कक्ष का निर्माण दृढ़ तथा आर्द्रता रोधी (मौसम रोधी) होना चाहिए। यह प्रभावी ढंग से संवातित होना चाहिए ताकि कक्ष की आवश्यक ताप वृद्धि को रोका जा सके। इसके लिए पर्याप्त कृत्रिम उद्दीपन तथा कम से कम एक प्लग प्वाइंट प्रदान किया जाना चाहिए। बत्ती स्विच मशीन कक्ष के प्रवेश द्वार के निकट लगाई जानी चाहिए।

- (d) The arc of contact made by the governor rope and the governor sheave shall, in conjunction with the rope tension device, provide sufficient attractive effort to cause proper operation of the governor.
- (e) Governor ropes shall run clear of the governor jaws during the normal operation of the lift.
- (f) Governor jaws and their mountings shall be so designed that any cutting, tearing or deformation of the rope resulting from their application shall not prevent proper operation of the safety gear.
- (g) The motor control circuit and the brake control circuit shall be opened before the governor trips.
- (h) Governors for car safety gears shall be adjusted to actuate the safety gear at the following speed :-
 - (i) For rated speed of 1 meter per second or less, governor tripping speed shall be 140 percent of the rated speed or 0.88 meter per second, whichever is higher. For the rated speed or above 1 meter per second, the maximum governor tripping speed shall be 115 percent of rated speed plus 0.25 meter per second.
 - (ii) The minimum governor tripping speed shall be 115 percent of the rated speed.
 - (iii) The proper tripping speed of the governor shall be stamped on the governor base or on a brass plate attached to the base.

16. Slack Rope Switch

- (a) All lifts, having winding drum machines, shall be equipped with an effective slack rope switch which will cut off the power and stop the machine if the lift-car is obstructed in its travel in the descending direction.
- (b) Slack-rope switches shall be so constructed that they will not automatically reset when the slack in the ropes is removed.
- (c) Live parts of the slack-rope switches shall be enclosed to prevent accidental contact.

17. Machine rooms and overhead structure

- (a) The lift machine controller and all other apparatus and equipment of a lift installation, excepting such apparatus and equipment as functions in the lift well or other position shall be placed in the machine room.
- (b) The machine room shall be so designed as to allow free and easy access to all parts of the equipment and the width of clear around the machine shall in no case be less than 60 cm. Provision shall be made to allow the removal and replacement of various units.
- (c) The machine room floor shall be designed and constructed to carry safely at any point the heaviest part of the equipment and if the floor does not extend to the enclosing wall the open sides shall be adequately guarded by suitable means.
- (d) The height of the machine room shall be sufficient to allow any portion of the equipment to be accessible and removable for repairs and replacement and shall not be less than 1.98 m clear from the floor or the platform of machine whichever is higher.
- (e) The machine room shall be provided with easy and safe access which shall be permanent and direct from the top lift landing. The entrance door shall be of sufficient opening to allow for the removal and replacement of parts of the machinery therein.
- (f) The machine room shall be soundly constructed and shall be weather proof. It shall be ventilated effectively to prevent undue rise in the temperature of the room. It shall be provided with sufficient artificial illumination and at least one plug socket point. The switch for the light shall be fixed near the entrance of the machine room.

- (छ) मशीन कक्ष को पाशित नहीं किया जाएगा और यह मशीनरी और उपस्कर के प्रचालन और अनुरक्षण से संबंध व्यक्तियों के लिए ही अभिगम्य होगा। 250 वोल्ट डी.सी. या 125 बोल्ट ए.सी. से अधिक विद्युत दाब का उपयोग किए जाने पर दरवाजे के बाहर और मशीनरी के निकट खतरे की स्थाई नोटिस लगायी जाएगी।
- (ज) मशीन कक्ष का उपयोग लिफ्ट अधिष्ठापन से संबंधित मशीनरी के वेशन के अलावा भंडार कक्ष या किसी अन्य उद्देश्य के लिए नहीं किया जाना चाहिए।
- (झ) मशीन कक्ष में मशीनरी की जाँच के लिए नम्य वर्कशॉप युक्त एक छोटा विद्युतरोधित हैडलैप प्रदान किया जाएगा।

18. शिरोपरि पुली

शिरोपरि पुली, अति चाल नियंत्रक और इसी प्रकार की मशीनरी वाले स्थान की स्पष्ट ऊँचाई कम से कम 120 से० मी० (होनी चाहिए) तथा ये अनुरक्षण और मरम्मत के उद्देश्यों के लिए सरलतापूर्वक अभिगम्य होने चाहिए। इसमें उचित प्रकाश व्यवस्था की जानी चाहिए तथा फर्श या स्टेज पर इतनी जगह होनी चाहिए ताकि सुरक्षापूर्वक अनुरक्षण और मरम्मत कार्य किया जा सके। उन मामलों में जहाँ फर्श या स्टेज लिफ्ट कूप के पूरे क्षेत्र तक विस्तारित न हो वहाँ एक रेल गार्ड या इसके समान रोक लगायी जानी चाहिए।

19. मशीन आलम्ब

- (क) सभी मशीनों, पुलियों, अति-चाल नियंत्रकों तथा समान इकाईयों को आलंबित और दृढ़ किया जाएगा ताकि किसी मशीन के अग्र भाग को ढीला या विस्थापित होने से रोका जा सके। आलंबन बीम इस्पात या प्रबलित कंक्रीट का होना चाहिए।
- (ख) शिरोपरि बीम तथा उनके आलंबों पर भारों की गणना निम्नानुसार की जाएगी:
 - (i) यह माना जाएगा कि शिरोपरि बीम पर कुल भार - बीम पर टिके सभी उपस्करों का भार धन बीम पर निलंबित अधिकतम भार का दो गुना।
 - (ii) पैरा (i) के अनुसार सामग्री के अंतिम सामर्थ्य और भार पर आधारित सभी शिरोपरि बीमों और आलंबों के लिए सुरक्षा गुणांक निम्नलिखित से कम नहीं होना चाहिए।

इस्पात के लिए	= 5
प्रबलित कंक्रीट के लिए	= 7
- (ग) उप-धारा (I) के अनुसार परिकल्पित अधिकतम स्थैतिक भार के अधीन शिरोपरि बीम का विचलन (विस्तृति) (स्पैन के 1/1500) से अधिक नहीं होना चाहिए।
- (घ) किसी लिफ्ट की फ्रेम संरचना कार्य के लिए काष्ठ का उपयोग नहीं किया जाना चाहिए।

20. लिफ्ट मशीन -

- (क) घर्षण गियरिंग और क्लच यंत्रावली का उपयोग मुख्य गियर को हॉइस्टिंग ड्रम या चरखियों से संयोजित करने के लिए नहीं किया जाना चाहिए।
- (ख) पट्टा या चेन चालित मशीन का उपयोग लिफ्टकार को उठाने के लिए नहीं किया जाना चाहिए।
- (ग) प्रत्येक लिफ्ट मशीन में ऐसे ब्रेक लगे होने चाहिए जिन्हें प्रचालन युक्ति को बंद स्थिति में होने पर, तथा किसी कारण से पॉवर कटी होने पर यांत्रिक रूप से लगाया जा सके। यदि स्प्रिंगों का उपयोग किया जाता है तो वे समुचित आकार व निर्माण के होने चाहिए तथा संपीडित होने पर ही कार्य करने चाहिए।
- (घ) विद्युत लिफ्ट मशीनों के लिए विद्युत द्वारा मोचित ब्रेक प्रदान किए जाने चाहिए।
- (ङ) सामान्य प्रचालन में मोटर को पॉवर लगाने से पूर्व ब्रेक को मोचित नहीं किया जाना चाहिए।
- (च) ब्रेक के साथ लगी कोई आपातकालीन मोचक युक्ति सामान्य प्रचालन के दौरान ब्रेक को बंद (ऑफ) स्थिति में रोकने में सक्षम नहीं होना चाहिए।
- (छ) किसी भी भूसंपर्कन, लघु पथन (शॉर्ट सर्किट) या प्रति विद्युत वाहक बल (ई एम एफ) के कारण सामान्य प्रचालन के दौरान ब्रेक नहीं लगना चाहिए।

- (g) The machine room shall not be locked and shall be accessible only to those who are concerned with the operation and maintenance of the machinery or equipment. When the electrical pressure used is above 250 volts D.C. or 125 volts A.C., a danger notice shall be displayed permanently on the outside of the door and near the machinery.
- (h) The machine room shall not be used as a store room or for any purpose other than for housing the machinery connected with the lift installation.
- (i) The machine room shall be provided with an insulated portable hand lamp with workshop flexible for examining the machinery.

18. Overhead pulleys

The place in which overhead pulleys, over speed governors and similar machinery are fixed shall have a clear height of at least 120 cm and shall be easily accessible for maintenance and repair purposes. It shall be lighted adequately and shall be provided with a substantial floor or staging spacious enough to enable maintenance and repairs to be carried out in safety. In cases where the floor or staging does not extend to the full area of the lift-well, a guard rail or its equivalent shall be provided.

19. Machine Supports

- (a) All machines, pulleys, over speed governors and similar unit shall be supported and held to prevent any unit from becoming loose or displaced. Supporting beams shall be of steel or reinforced concrete.
- (b) The loads on over head beams and their supports shall be calculated as follows:
 - (i) The total load on over head beams shall be assumed as equal to all equipment resting on the beam plus twice the maximum load suspended from the beams.
 - (ii) The factor of safety for all overhead beams and supports based on the ultimate strength of the material and the load in accordance with paragraph (i) shall be not less than the following :-
 - For steel = 5
 - For reinforced concrete = 7
- (c) The deflection of the over head beams under the maximum static load calculated in accordance with sub-section (i) shall not exceed 1/1500 of the span.
- (d) Wood shall not be used for structural frame work of any lift.

20. Lift Machines

- (a) No friction gearing and clutch mechanism shall be used for connecting the main gear to the hoisting drum or sheaves.
- (b) No belt or chain driven machine shall be used to raise the lift-car. No worm gear having cast iron teeth shall be employed.
- (c) Every lift machine shall be equipped with brakes which shall be mechanically applied when the operating device is in the off position or when power is cut off from any cause. If springs are used they shall be of substantial size and construction and shall work in compression only.
- (d) Electric lift machines shall be provided with brakes released electrically.
- (e) No brake shall be released in normal operation until power has been applied to the motor.
- (f) Any emergency release device fitted to a brake shall not be capable of holding the brake in the 'off' position during normal operation.
- (g) No single earth fault, short circuit or counter E.M.F. shall prevent the brake from being applied during normal operation.

(ज) 24 मीटर से अधिक ऊँचे भवनों की फायर लिफ्टों को 1.0 मी०/सेकेंड की चाल पर या इससे अधिक पर कार्य करना चाहिए ताकि एक मिनट के भीतर भू-तल से शीर्षतल तक पहुंच सकें परन्तु 1500 कि०ग्रा० और अधिक के अनुबंधित भार पर प्रचालित होने के लिए डिजाइन किए गए माल-सह-यात्री लिफ्टों के मामले में इस आवश्यकता के संबंध में सरकार द्वारा छूट प्रदान की जा सकती है।

21. चरखियां और ड्रम -

- (क) सभी चरखियाँ और मुख्य पुलियां अधिमानतः डिस्क प्रकार की होनी चाहिए। अर (स्पोक) निर्माण का उपयोग किए जाने पर अर पर्याप्त क्रास सैक्शन युक्त तथा उचित रूप से दृढ़ किए होने चाहिए।
- (ख) चरखी का व्यास या ड्रम और अपवर्तक पुलियां भारतीय मानक विनिर्देश सं० 4666 - 1968 के खंड 17 के निबंधनों के अनुसार होनी चाहिए।
- (ग) उन स्थानों पर जहां ड्रम की चालन चरखी वर्म गियर के माध्यम से संयोजित हो वर्म गियर व्युत्क्रमणीय प्रकार का होना चाहिए।
- (घ) स्वर गियर और वर्म गियर की सामर्थ्य क्रमशः भारतीय मानक विनिर्देश 4460 और भारतीय मानक विनिर्देश के अनुसार होने चाहिए।
- (ङ) ड्रम, चरखियां और पुलियां ढलवाँ लौह इस्पात की तथा मशीनित रज्जु खांचों वाली होंगी और इसके लिए उचित फलैज प्रदान किए जाने चाहिए।
- (च) किसी लिफ्ट मशीन की चरखी ड्रम, वर्म पहिया या स्वर गियर इसके शैफ्ट या चालन इकाई से निम्नलिखित में से किसी एक विधि द्वारा जुड़े होंगे:-
 - (i) भारतीय मानक विनिर्देश सं० 14665 (भाग 3/धारा 1 और 2): 2000 के अनुसार निमग्न कुँजी (संक की)।
 - (ii) बी.एस.एस.46 भाग 2 (नया संस्करण) के अनुसार जोभिया (स्लाइन्स)
 - (iii) घुमावदार कसी फिटिंग वाले बोल्टों के माध्यम से चालन इकाई के शैफ्ट के अविभाजित भाग वाले फलैज के साथ राक्षित।
- (छ) चौबियों या अन्य घनात्मक संयोजनों के स्थान पर किसी सेट स्कू बंधक का उपयोग नहीं किया जाएगा।
- (ज) प्रत्येक लिफ्ट मशीन का मोटर या वर्म शैफ्ट इस प्रकार मध्य में होनी चाहिए कि वह हस्त लपेटन सुविधाएं प्रदान करे और इसके दोनों सिरों पर ऊपर या नीचे की दिशा के लिए उचित निशान लगे हों।

22. शैफ्ट

- (क) चरखी या पुलियों का वहन करने वाला ऐसा कोई शैफ्ट, जो अंध नेत्रकों या अन्य वेशन के बीच में स्थापित है, सोपानी: प्रकार का (होना चाहिए) अर्थात् प्रत्येक सिरे पर प्रवेश बिन्दु पर या इसके निकट व्यास में कम होना चाहिये।
- (ख) सोपानी प्रकार का होने पर व्यास की कमी वाले बिंदु पर इसकी त्रिज्या उचित होनी चाहिये।

23. नियंत्रक

- (क) धातु से धातु का सम्पर्क वाले गुरुत्व या स्प्रिंग-विवृत्त वे सम्पर्क जिनका उपयोग लिफ्ट मशीन को रोकने के लिए मुख्य परिपथ के वियोजन के लिए किया जाता है तो ऐसे परिपथ में कम से कम दो ब्रेक लगे होने चाहिए।
- (ख) बहुकला ए.सी. मोटर द्वारा प्रचालित प्रत्येक लिफ्ट मशीन को कलाव्युत्क्रमण या कला विफलता के विरुद्ध राक्षित होना चाहिए। यह मोटर जनरेटर सेटों में प्रयुक्त ए.सी. मोटरों के लिए लागू नहीं होगा।
- (ग) ऐसे संधारित्र, जिनका प्रचालन या विफलता असुरक्षित स्थिति पैदा करे, का स्थापन निषिद्ध होगा।
- (घ) अवतरण पाश परिपथ के लघु-परिसंचरण के लिए आपातकालीन स्टॉप स्विचों की व्यवस्था निषिद्ध होगी।
- (ङ) सभी नियंत्रण परिपथ फ्यूजयुक्त होंगे, या मुख्य परिपथों से अलग दोषों या अतिभार के विरुद्ध अन्यथा राक्षित होंगे।
- (च) किसी नियंत्रक प्रचालित परिपथ की वोल्टता भारतीय विद्युत नियम, 1956 में यथा परिभाषित निम्न दाब से अधिक नहीं होगी।
- (छ) हस्त रज्जु, लीवर या इसी प्रकार की युक्तियों से प्रचालित नियंत्रकों की अनुमति नहीं होगी।

- (h) Fire lifts in a building having more than 24 meters height, shall work at or above the speed of 1.0 meter/ sec so as to reach the top floor from ground level within one minute. Provided that this requirement may be relaxed by govt. in case of goods cum passenger lifts designed to operate at contract load of 1500 kg and above.

21. Sheaves and drums

- (a) All sheaves and leading pulleys shall preferably be of disc construction. If spoke construction is used, the spokes shall be of sufficient cross-section and properly stiffened.
- (b) The diameter of the drum of sheave and the diverter pulleys shall be in accordance with the terms of clause 17 of Indian Standard Specification No. 4666-1968.
- (c) Where the driving sheave of drum is connected through worm gear, the worm gear shall be of nonreversible type.
- (d) The strength of spur and worm gear shall be in accordance with Indian Standard Specifications 4460 and Indian Standard Specifications 3734 of 1966 respectively.
- (e) Drums, sheaves and pulleys shall be of cast iron steel and shall have machined rope grooves and be provided with suitable flanges.
- (f) The sheave, drum, Worm wheel or spur gear of any lift machine shall be fixed to its shaft or driving unit by one of the following methods :-
- (i) Sunk keys in accordance with Indian standard Specifications No. 14665 (part-3/Sec 1 & 2): 2000.
 - (ii) Splines in accordance with B.S.S. 46, part 2 (current edition)
 - (iii) Secured to a flange forming an integral part of the shaft of driving unit by means of turned tight-fitting bolts.
- (g) No set screw fastenings shall be used in lieu of keys or other positive connections.
- (h) The motor of each lift machine or the worm shaft shall be so between as to provided hand winding facilities and shall be suitably marked for the direction of up and down travel of the lift car.

22. Shafts

- (a) Any shaft carrying a sheave or pulleys and fitted between dead eyes or other housing shall be stepped i.e. reduced in diameter at or near the point of entry at each end.
- (b) Anywhere stepped shall be turned to a reasonable radius at the point of reduction in diameter.

23. Controllers

- (a) Where gravity or spring-opened contactors having metal to metal contacts are employed to open a main circuit to stop a lift machine such circuit shall have at least two independent breaks.
- (b) Each lift machine operated by a Polyphase A.C. motor shall be protected against phase reversal or phase failure. This shall not apply to A.C. Motors used in motor generator sets.
- (c) The installation of condensers, the operation or failure of which will cause an unsafe condition, shall be prohibited.
- (d) Provision of emergency stop switches for short-circuiting the landing lock circuit is prohibited.
- (e) All control circuit shall be fused, or otherwise protected against faults or overload, independently of the main circuits.
- (f) The voltage of any controller operating circuits shall not exceed low pressure as defined in the Indian Electricity Rules, 1956.
- (g) Controllers, operated by hand ropes, levers or similar devices shall not be permitted.

24. प्राचालन और प्रचालन युक्ति -

- (क) मोटर जनरेटर सेटों की विद्युत लिफ्ट मशीन के मुख्य परिपथ केबिलों में हाथ से प्रचालित मुख्य वियोजक स्विच अधिष्ठापित की जाएगी। यह स्विच मशीन या मोटर जनरेटर सेट के निकट लगायी जाएगी और इसके नियंत्रणों से दिखाई देनी चाहिए।
- (ख) डी.सी. पॉवर पूर्ति के साथ वियोजन स्विच और किसी परिपथ वियोजक को इस प्रकार व्यवस्थित, किया जाएगा कि मुख्य परिपथ के खुलने के समय ही ब्रेक कुंडली परिपथ खुले।
- (ग) विद्युत परिपथ की रूकावट कार की गति को रोक देगी या बाधित कर देगी।
- (घ) कोई भी नियंत्रण निम्नलिखित के लिए किसी विद्युत परिपथ की पूर्णता या अनुरक्षण पर निर्भर नहीं होना चाहिए :-
- (i) मोटर के लिए विद्युत पूर्ति का अंतरायण या टर्मिनल अवतरणों पर लिफ्ट कार को रोकने के लिए ब्रेक प्रयोग या आपातकालीन स्टॉप स्विच को प्रचालित होने पर लिफ्ट कार को रोकने के लिए;
- (ii) सुरक्षा गियर का प्रचालन: बशर्ते यह आवश्यकता गतिक ब्रेकिंग या चाल नियंत्रण युक्तियों के लिए लागू न हो।
- (ङ) नियंत्रण परिपथ को इस प्रकार व्यवस्थित किया जाएगा कि कोई भू-सम्पर्कन दोष या खुला परिपथ असुरक्षित स्थिति उत्पन्न नहीं करेगा।
- (च) स्वाचलित (दाब बटन प्रचालित) लिफ्टों को निम्नलिखित आवश्यकताएं पूरी करनी चाहिए :-
- (i) निरसित
- (ii) 0.75मी०/सेकेंड की चाल से प्रचालित स्वाचलित लिफ्ट की गति अवतरण पर रूकते समय 0.75 मी०/सेकेंड से स्वतः कम हो जाएगी।
- (iii) स्वाचलित लिफ्ट के मामले में स्प्रिंग का कोई भी प्रचालन या किसी अन्य विद्युत परिपथ की पूर्णता टर्मिनल अवतरणों पर लिफ्ट को रोकने के लिए ब्रेक परिपथ पर निर्भर नहीं होगी।
- (iv) चालू लिफ्ट-कार के पूरे उपयोग के दौरान अवतरण दाब बटन अप्रचालनीय रहेंगे (उपयोग करने वाले) व्यक्ति या व्यक्तियों द्वारा लिफ्ट को खाली करने और अवतरण फाटक या दरवाजों को बन्द होने तक अवतरण दाब बटन अप्रचालनीय बना रहेगा परन्तु पूर्व वरक परिपथ का उपयोग किए जाने पर दाब बटनों को उनके उद्देश्यों के लिए उपयोग में लाया जा सकता है परन्तु इसे लिफ्ट-कार की दिशा किसी भी प्रकार से प्रभावित नहीं करनी चाहिए।
- (v) लिफ्ट में सचल फर्श निर्माण का उपयोग किये जाने पर कार अहाते के भीतर का पूरा फर्श सचल होगा और इसके किरसी भी बिन्दू पर 14 किग्रा० का भार स्थापित करके प्रचालित किया जा सकेगा।
- (vi) सचल फर्श निर्माण वाली लिफ्ट कार में कोई हस्त रेल या सीट नहीं लगायी जायेगी।
- (छ) स्वतः नियंत्रित प्रत्येक लिफ्ट कार और लिफ्ट कार समतलन युक्ति वाली प्रत्येक लिफ्ट कार के लिए कार के भीतर की दाब बटनों से प्रचालित आपात विरामी युक्ति प्रदान की जानी चाहिए और यह लाल रंग से स्पष्ट चिन्हित होनी चाहिए।
- (ज) प्रत्येक लिफ्ट-कार के शीर्ष पर तथा लिफ्ट गर्त में हाथ से खोली और बंद की जा सकने वाली, एक आपातकालीन स्टॉप स्विच प्रदान की जानी चाहिए और यह स्पष्टतः चिन्हित होनी चाहिए।
- (झ) 0.5 मीटर/सेकेंड से अधिक की चालों के लिए ड्रम चालन मशीन का उपयोग नहीं किया जायेगा।
- (ञ) 1 मी०/से० और इससे अधिक चाल वाली सभी लिफ्टों के लिए एक अनुमोदित फर्श समतलन युक्ति प्रदान की जानी चाहिए।
- (ट) सिगनल घंटियां या इसी प्रकार के ऐसे उपकरण, जिन्हें लिफ्ट कार के संकेतकों के साथ मिलकर किसी भी तल से प्रचालित किया जा सकता है, लिफ्ट प्रचालकों द्वारा प्रचालित सभी लिफ्टों पर प्रदान की जानी चाहिए।
- (ठ) लिफ्ट-कार में एक से अधिक प्रचालन युक्तियों का प्रयोग किए जाने पर प्रचालन युक्तियों को इस प्रकार अंतः पाशित किया जाएगा कि एक समय में केवल एक ही युक्ति प्रभावी हो।
- (ड) 24 मीटर से अधिक ऊँचाई वाले भवनों में अग्नि (फायर) लिफ्ट का प्रचालन भूतल पर लिफ्ट द्वार के सन्निकट स्थित ग्लास

24. Operation and operating Device

- (a) A manually operated main disconnecting switch shall be installed in the main circuit cables of electric lift machines of motor-generator sets. This switch shall be placed close to and visible from the machine or motor-generator set it controls.
- (b) With D.C. power supplies, the disconnecting switch and any circuit breaker shall be so arranged that the brake coil circuit is opened at the same time that the main circuit is opened.
- (c) The interruption of the electrical circuit shall stop or shall prevent the movement of the car.
- (d) No control shall depend upon the completion or maintenance of an electric circuit for-
 - (i) The interruption of the power supply to the motor and the application of the brake to stop the lift car at terminal landings or to stop the lift-car when the emergency stop switch is operated;
 - (ii) The operation of the safety gear;
Provided that this requirement does not apply to dynamic breaking or to speed control devices.
- (e) Control circuit shall be so arranged that an earth fault or open circuit shall not create an unsafe conditions.
- (f) Automatic (push button operated) lifts shall conform to the following requirements :-
 - (i) deleted
 - (ii) Automatic lifts which travel at a speed over 0.75 m/sec shall automatically slow down to a speed of 0.75 m/sec when making a stop at any landing.
 - (iii) In the case of an automatic lift, no operation of a spring nor the completion of another electric circuit shall be depended upon to break the circuit to stop the lift at terminal landings.
 - (iv) the landings push buttons shall be inoperative during the whole time a occupied lift-car is in use. The landings push buttons shall remain inoperative until the person or persons using the lift have vacated the lift-car and the landing gate or door has been again-closed, except that in cases where a pre-selector circuit is used, the push buttons may be utilised for this purpose, provided they do not in any way interfere with the direction of the lift-car.
 - (v) if movable floor construction is used in the lift-car the entire floor within the car enclosure shall be movable and shall be operated when a weight of 14 kg is placed upon it at any point.
 - (vi) No hand rail or seat shall be fitted in the lift car with movable floor construction.
- (g) Every automatically controlled lift-car and every lift car having a lift-car levelling device shall be provided with emergency stopping device operated by a push button switch in the car and it shall be clearly marked in red.
- (h) An emergency stop switch, of manually opened and closed type, shall be provided on the top of every lift-car and in the lift pit and shall be marked conspicuously.
- (i) Drum drive machine shall not be used for speeds exceeding 0.5 m/sec.
- (j) All lifts travelling at a speed of 1 m/sec and over shall be provided with an approved floor levelling device.
- (k) Signal bells or similar apparatus, which can be operated from any floor in conjunction with an indicator in the lift-car, shall be provided on all lifts operated by lift operators.
- (l) When more than one operating device is used in a lift-car, the operating devices shall be so interlocked that only one device is effective at a time.
- (m) The operation of the fire lift in building having more than 24 meters height, shall be a simple

आवृत्त बॉक्स में अवस्थित सरल टांगल या दो बटनों द्वारा किया जाएगा। स्विच को चालू (ON) स्थिति में होने पर अवतरण कॉल बिन्दु अप्रचालनीय हो जाएगा तथा कार भूतल के लिए रिपोर्ट करेगी और वही स्थिति कार नियंत्रण पर बनी रहेगी। स्विच को बंद (off) स्थिति में होने पर लिफ्ट सामान्य ढंग से कार्य करना प्रारम्भ कर देगी।

25. बिजली के तार लगाना

- (क) लिफ्ट अधिष्ठापन से संबंधित सभी तार भारतीय विद्युत अधिनियम, 1910 के अधीन बनाए गए नियमों और विनियमों तथा बंबई अग्नि बीमा संगठन (बंबई फायर इंश्योरेंस एसोसिएशन) के नियमों और विनियमों के अनुसार अधिष्ठापित किए जाएंगे तथा जहां भी सम्भव हो सभी केबिलों की रक्षा के लिए धात्विक आवरण का उपयोग किया जाना चाहिए।
- (ख) सभी अनुगामी केबिल नम्य प्रकार के होंगे तथा बंबई अग्नि बीमा संगठन के विनियमों तथा भारतीय विद्युत नियम, 1956 के उपबंधों में निर्धारित विनिर्देशों का पालन करेंगे।
- (ग) मोटर को बिजली की पूर्ति करने वाले परिपथों को, नियंत्रण और सुरक्षा युक्तियों के संबंध में प्रयुक्त, किसी दोहरे या बहुकोड (मल्टीकोर) अनुगामी केबिल में शामिल नहीं किया जाना चाहिए।
- (घ) नियंत्रण परिपथ के लिए चालकों को समाहित करने वाले अनुगामी केबिल को प्रकाश और सिग्नल परिपथों के लिए चालकों को समाहित करने वाले अनुगामी केबिल से पृथक किया जाएगा।
- (ङ) लिफ्टों के लिए विद्युत पूर्ति मुख्य स्विच कक्ष से पृथक परिपथ पर होगी और इसे संबंधित लिफ्ट शैफ्ट के माध्यम से कवचित केबिल के द्वारा अलग से लिया जाएगा। कवचित केबिल का मार्ग आग से रक्षित होना चाहिए।

26. टर्मिनल सीमा स्विचें

- (क) प्रत्येक विद्युत लिफ्ट के लिए उच्च और निम्न टर्मिनल स्विचें इसे प्रकार व्यवस्थित की जानी चाहिए कि वे कार को सामान्य प्रचालन में प्राप्त किसी चाल से उच्चतम और निम्नतम अति यात्राओं के भीतर स्वतः रोक सके। इस प्रकार की सीमा स्विचें प्रचालन युक्ति, अन्तिम सीमा स्विचों और बफर से स्वतंत्र रहकर कार्य करेंगी।
- (ख) लिफ्ट कार के लिए टर्मिनल विरामी सीमा स्विचें लिफ्ट कूप या मशीन कक्ष में स्थापित की जानी चाहिए और ऐसी स्विचें लिफ्ट कार की गति द्वारा प्रचालन में लायी जानी चाहिए।
- (ग) सभी टर्मिनल सीमा स्विचों के संपर्क लिफ्ट-कार संचलन द्वारा धनात्मक रूप से ओर यांत्रिक रूप से खोले जाएंगे।
- (घ) टर्मिनल स्विचों को मशीन कक्ष में अवस्थित होने पर वे विरामी युक्ति पर आरोपित तथा इसके द्वारा प्रचालित होंगी तथा लिफ्ट कार के चालन से यांत्रिक रूप से संयोजित होगी तथा चालन साधन के रूप में घर्षण पर निर्भर नहीं होगी। एक ऐसी स्वचालित सुरक्षा युक्ति प्रदान की जाएगी जो मशीन को रोकेगी तथा विरामी युक्ति को कार रेल से टेप चैन, रज्जु या अन्य सामान युक्ति के माध्यम से यांत्रिक रूप से संयोजित किया जायेगा।
परन्तु तल नियंत्रण या स्वतः प्रचालित लिफ्ट का वरक इस आवश्यकता के अनुसार चालित होने पर प्रत्येक टर्मिनल तल के लिये तल विरामी सम्पर्क सामान्य टर्मिनल तल विरामी युक्ति के रूप में कार्य कर सकता है।

27. चरम या अंतिम सीमा स्विचें

- (क) सभी मामलों में विद्युत लिफ्टों को ऐसी व्यवस्थित चरम या अंतिम सीमा स्विचें प्रदान की जाएंगी ताकि लिफ्ट कार को शीर्ष और निम्न अवकाशों के भीतर, सामान्य प्रचालन युक्ति और टर्मिनल सीमा स्विचों से निरपेक्ष, तथा बफर को प्रचालित रखकर रोका जा सके। बफर की स्विचें इस प्रकार व्यवस्थित की जानी चाहिए कि स्विच का खुलना तथा बफर की आबद्धता यथा संभव साथ-साथ ही स्प्रिंग बफर लगाए जाने पर बफर आबद्ध होने से पूर्व स्विच खुलनी चाहिए।

toggle or two button switch situated in a glass fronted box adjacent to the lift at entrance level on ground floor. When the switch is 'ON' the landing call points shall become inoperative and car shall report to the ground floor and the same shall remain on car control only. When the switch is 'OFF' the lift shall return to normal working.

25. Electric wiring

- (a) All wiring in connection with the lift installation shall be installed in accordance with the rules and regulations made under the Indian Electricity Act, 1910, and the rules and regulations of the Bombay Fire Insurance Association, and metallic covering shall be used to protect all cables wherever possible.
- (b) All trailing cables shall be of flexible construction and shall comply with the specifications laid down in the regulations of the Bombay Fire Insurance Association and provisions of Indian Electricity Rules 1956.
- (c) Circuits which supply current to the motor shall not be included in any twin or multicore trailing cable used in connection with the control and safety devices.
- (d) A trailing cable which incorporates conductors for the control circuit shall be separate and distinct from that which incorporates conductors for lighting and signaling circuits.
- (e) The electric supply for the lifts shall be on separate circuit from the main switch rooms and shall be taken through armoured cable separately through respective lift shafts. The route of the armoured cable shall be safe from fire.

26. Terminal limit switches

- (a) Every electric lift shall be provided with upper and lower terminal limit switches arranged to stop the car automatically within the top and bottom over-travels from any speed attained in normal operation. Such limit switches are to act independently of the operating device, the ultimate or final limit switches and the buffers.
- (b) Terminal stopping limit switches may be fitted to the lift-car, in the lift-well, or in the machine room, and such switches shall be brought into operation by the movement of the lift-car.
- (c) The contacts of all terminal limit switches shall be opened positively and mechanically by the movement of the lift-car.
- (d) When terminal switches are situated in the machine room, they shall be mounted on and operated by stopping device mechanically connected to an drive by the lift-car without dependence upon friction as a driving means. An automatic safety switch shall be provided which will stop the machine, should the tape, chain, rope or other similar device, mechanically connecting the stopping device to the car fail.
Provided that when the floor controlling or selector of an automatically operated lift is driven in accordance with this requirement, the floor stopping contacts for each terminal floor may serve as normal terminal floor stopping devices.

27. Ultimate or Final Limit Switches

- (a) Electric lifts shall, in all cases, be provided with ultimate or final limit switches arranged to stop the lift-car automatically within the top and bottom clearances independently of the normal operating device and the terminal limit switches but with the buffers operative. The switches and the oil buffer shall be so arranged that the opening of the switch and the engagement of the buffer shall be as nearly simultaneous as is possible. When spring buffers are employed, the switch shall open before the buffers are engaged.

- (ख) चरम या अंतिम सीमा स्विचें यात्रा की दोनों दिशाओं में पॉवर के अधीन लिफ्ट के संचालन को रोकने का कार्य करेंगी और प्रचालन के पश्चात् उस समय तक खुली रहेंगी जब तक कि लिफ्ट कार को हस्त कुंडलीकरण द्वारा ऐसी स्थिति तक, जो सामान्य यात्रा की सीमा के भीतर हो, न पहुंचाया गया हो।
- (ग) चरम या अंतिम स्विचें लिफ्ट कूप में लिफ्ट-कार के संचालन द्वारा प्रचालित होंगी, वे लिफ्ट-कार पर आरोपित नहीं की जाएंगी।
- (घ) ड्रम मशीन वाली प्रत्येक लिफ्ट के लिए दो अंतिम सीमा स्विचें होंगी जिनमें से एक मशीन द्वारा तथा दूसरी लिफ्ट-कार के संचालन द्वारा प्रचालित होगी।
- (ङ) चरम या अंतिम सीमा स्विच, तब तक टर्मिनल सीमा स्विचों के रूप में नियंत्रक पर उसी रिले स्विच को नियंत्रित नहीं करेगी। जब तक नियंत्रक पर दो या अधिक पृथक और स्वतंत्र रिले स्विचें प्रदान न की गयी हों, इनमें से दो यात्रा की प्रत्येक दिशा में मोटर या ब्रेक परिपथ को पूर्ण करने के लिए बंद होंगी।
- उस समय जब चरम या अंतिम सीमा स्विचें प्रचालन युक्ति के रूप में उसी सीमा स्विच या स्विचों को या टर्मिनल सीमा स्विचों को नियंत्रित करती हों, उन्हें टर्मिनल सीमा स्विचों की विपरीत दिशा में नियंत्रण परिपथ में संयोजित किया जाएगा।
- (च) मोटर के मुख्य परिपथ को खोलने के लिए डिजाइन की गयी चरम सीमा स्विचें टर्मिनल सीमा स्विच के रूप में नियंत्रक पर उसी स्विच या स्विचों को नियंत्रित कर सकती है, परन्तु ऐसी चरम सीमा स्विचों को दिष्ट धारा की पॉवर पूर्ति के लिए लगाए जाने पर उनके लिए ब्रेक परिपथ को नियंत्रित करने के लिए, अतिरिक्त सम्पर्क प्रदान किए जाएंगे।
- (छ) सभी अंतिम या चरम सीमा स्विचों के सम्पर्क लिफ्ट कार के संचालन द्वारा धनात्मक रूप से तथा यांत्रिक रूप से खोले जाएंगे। सीमा स्विचों को प्रचालित करने वाले कैम धातु के होंगे।
- (ज) लिफ्ट कार को शिरोपरि संरचना के सम्पर्क में या पूर्णतः संपीडित बफर पर अलंबित होने पर टर्मिनल और चरम या अंतिम सीमा स्विचों को खुली स्थिति में रखा जाएगा।

28. परीक्षण

- (क) प्रत्येक नई लिफ्ट का अनुबंधित भार परीक्षण, लिफ्ट को सामान्य और नियमित प्रचालनों के लिए सेवा में प्रस्तुत करने से पूर्व, लिफ्ट निरीक्षक की उपस्थिति में उस इंजीनियर द्वारा, जिसे लिफ्ट के अधिष्ठापन का कार्य सौंपा गया है, किया जाएगा। यह परीक्षण यह निश्चित करने के लिए किया जाएगा कि क्या मशीनरी और सुरक्षा गियर विनिर्धारित सीमा के भीतर लिफ्ट कार में पूर्ण भार के साथ संतोषजनक ढंग से प्रचालित होंगे।
- (ख) ब्रेकों, सीमा स्विचों, बफर, सुरक्षा गियर या गियरों और चाल नियंत्रक यदि लगा है, को परीक्षण के दौरान सक्रिय किया जाएगा तथा बिजली के तार के संयोजनों का भूसंपर्कन विद्युत रोधन प्रतिरोध तथा सामान्य दृढ़ता के लिए परीक्षण किया जाएगा।
- (ग) संकर्षण चालन लिफ्टों के मामले में परीक्षण द्वारा यह सुनिश्चित किया जाएगा कि 1-1/2 गुणे भार के साथ अवरोहण पर रज्जु और चरखी के बीच का घर्षण पर्याप्त है।
- (घ) अतिचाल संपर्क या नियंत्रक पर कट-आउट को छोड़कर, रनवे परीक्षण सभी विद्युत उपकरणों को प्रचालित रखकर किया जाएगा। सीधे प्रत्यावर्ती धारा से प्रचालित लिफ्टों के लिए नियंत्रक को प्रायः अधिकतम चाल पर हाथ से ट्रिप किया जाएगा।
- (ङ) प्रत्येक अनुवर्ती निरीक्षण पर सुरक्षा गियर का परीक्षण लिफ्ट कार को स्थिर रखकर किया जाएगा और यह सुनिश्चित करने के लिए लिफ्ट कार को नीचे लाया जाएगा कि सुरक्षा गियर सही ढंग से कार्य कर रहा है।
- (च) सभी प्रचालन और समान युक्तियों के विद्युत पुंजों के विद्युत रोधन की परीक्षा की जाएगी कि वे एक मिनट के लिए कार्यकारी बोल्टता की 10 गुनी प्रत्यावर्ती परीक्षण वोल्टता, जो कि अधिकतम 2,000 वोल्ट होगी, को सहन कर सकेंगे तथा यह वोल्टता संपर्कों और समान भागों के बीच खुली अवस्था में तथा ऐसे संपर्कों और भूसंपर्कित भागों पर लगाकर जाँची जाएगी।

- (b) Ultimate or final limit switches shall act to prevent movement of the lift-car under power in both directions of travel and shall, after operating, remain open until the lift-car has been moved by hand winding to a position within the limits of normal travel.
- (c) Ultimate or final switches shall be operated by the movement of the lift-car in the lift-well; they shall not be mounted on the lift-car.
- (d) Every lift having drum machine shall have two final limit switches, one being operated by the machine and the other by the movement of the lift-car.
- (e) Ultimate or final limit switches shall not control the same relay switches on the controller as the terminal limit switches unless two or more separate and independent relay switches on the controller are provided, two of which shall be closed to complete the motor and brake circuit in each direction of travel. When the ultimate or final limit switches control the same relay switch or switches on the controller as the operating device, or the terminal limit switches they shall be connected in the control circuit on opposite sides to the terminal limit switches.
- (f) Ultimate limit switches designed to open the main circuit of the motor may control the same switch or switches on the controller as the terminal limit switches but when such ultimate limit switches are employed on direct current power supplies, they shall be provided with additional contacts to control the brake circuit.
- (g) The contacts of all final or ultimate limit switches shall be opened positively and mechanically by the movement of the lift-car. The cam or cams for operating the limit switches shall be of metal.
- (h) The terminal and the ultimate or final limit switches shall be held in open position when the lift-car is in contact with the overhead structure or resting on the fully compressed buffers.

28. Tests

- (a) A contract load test of each new lift shall be made by the Engineer, who is entrusted with the work of installing the lift, in the presence of the Inspector of Lifts, before such lift is put into service for normal and regular operations. This test shall be made to determine whether the machinery and safety gear will operate satisfactorily within the specified limits with full load in the lift-car.
- (b) The brakes, limit switches, buffers, safety gear or gears and speed governor if fitted, shall be made to function during the test, and the electrical wiring and connections shall be tested for earthing insulation resistance and general soundness.
- (c) In the case of traction drive lifts, it shall be ascertained by a trial descent with 1-1/2 times the full load whether the friction between the ropes and the sheave is sufficient.
- (d) The runway test shall be made with all electrical apparatus operative, except for the overspeed contact or cut-out on the governor. For lifts operating directly from alternating current the governor shall be tripped by hand at the maximum speed obtainable.
- (e) At each subsequent inspection the safety gear shall be tested with the lift-car stationary and the lift-car shall be lowered to ensure that the safety gear functions correctly.
- (f) The insulation of the electrical parts of all operating and similar devices shall be tested to withstand an alternating test-voltage equal to 10 times the working voltage for one minute, with a maximum of 2,000 volts applied between contacts or similar parts, in the open position and between such contacts and earthed parts.

29. सूचनाएं/नोटिसें

स्वचालित लिफ्टों के मामले में लिफ्ट कार में साफ दिखाई देने वाले स्थान पर निम्नलिखित सूचनाएं लगाई जाएंगी और इसके अलावा लिफ्ट कार में कोई और सूचना नहीं लगाई जाएगी-

- (i) यह लिफ्ट से अधिक व्यक्तियों द्वारा उपयोग में नहीं लायी जाएगी।
- (ii) लिफ्ट में प्रवेश करते समय/उससे बाहर निकलते समय अवतरण दरवाजों और कार दरवाजों को ठीक से बंद करें।
- (iii) लिफ्ट कार को उस समय न खोलें जब यह चल रही हो। लिफ्ट कार को अवतरण दरवाजे के सामने रुक जाने के बाद ही इसके दरवाजे को खोला जाना चाहिए।
- (iv) खतरे की स्थिति में, अलार्म बटन को दबाएं परन्तु लिफ्ट कार के दरवाजे को बंद अवस्था में छोड़ दें। लिफ्ट कार को अवतरण के समाने लाए जाने तक भीतर प्रतीक्षा करें तथा लिफ्ट कार के दरवाजे को पूर्णतः खुल जाने के बाद ही लिफ्ट कार से बाहर निकलने का प्रयत्न करें।
- (v) 12 वर्ष से कम आयु वाले बच्चों के साथ वयस्क न होने पर वे लिफ्ट का प्रयोग नहीं कर सकते।

Notices-

In case of automatic lifts the following notices shall be placed in conspicuous position in the lift-car and no other notices shall be fixed in the lift-car :-

- (i) The lift shall not be used by more than —— persons.
- (ii) On entering or leaving the lift-car , close properly the landing gate and the car-gate.
- (iii) Do not open the lift-car when the lift-car is moving. The gate should only be opened after the lift-car has stopped opposite a landing gate.
- (iv) In case of danger, press the alarm button but leave the lift-car gate closed. Wait inside until the lift-car is brought opposite a landing, and do not attempt to leave the lift-car until the landing gate is opened fully.
- (v) Children under 12 years of age shall not use the lift unless accompanied by an adult.

परिशिष्ट - V

डिजाइन और अभिन्यास

1. सामान्य

लिफ्टों की यातायात संभलाई क्षमताओं की गणना की विधि प्रथमतः कार्यालयी भवनों के लिए तैयार की गयी थी। इसके उपरान्त इसमें विस्तृत संशोधन किए गए ताकि यह मूल सिद्धांतों को परिवर्तित किए बिना अन्य अनुप्रयोगों के लिए अनुकूल हो सके। अब भी कार्यालयी भवनों के लिए अनुप्रयोग अति बार-बार प्रयुक्त होता है।

कार्यालयी भवन के लिए लिफ्ट अधिष्ठापन को सामान्यतः भवन को दी गयी दर पर आबाद करने के लिए डिजाइन किया गया है और इसके विचारणीय तीन मुख्य कारक निम्नलिखित हैं-

- (क) वह जनसंख्या या व्यक्तियों की संख्या जिनके लिए लिफ्ट की सेवा आवश्यक है,
- (ख) संभलाई क्षमता या इन व्यक्तियों द्वारा अपेक्षित अधिकतम प्रवाह दर,
- (ग) अंतराल या अपेक्षित सेवा की गुणवत्ता।

2. जनसंख्या

2.1 अंतिम उपभोक्ता से सर्वप्रथम यह सुनिश्चित किया जाना चाहिए कि भवन की कुल जनसंख्या क्या है और भविष्य में क्या इसे बढ़ने की संभावना है।

2.2 जनसंख्या का सही आंकड़ा प्राप्त न होने पर उस क्षेत्र से और संभावित जनसंख्या घनत्व के आधार पर मूल्यांकन किया जाना चाहिए। औसत जनसंख्या घनत्व एक व्यक्ति प्रति 4 वर्ग मी० से एक व्यक्ति प्रति 20 वर्ग मी० तक हो सकता है। अतः यह आवश्यक है कि संभावित जनसंख्या घनत्व संबंधी कुछ संकेत भवन के मालिक से प्राप्त किए जा सकते हैं। कोई संकेत संभव न होने पर सामान्य कार्यालयी भवनों के लिए क्षेत्र की संभावित जनसंख्या सामान्यतः 5 वर्ग मी० प्रति व्यक्ति के हिसाब से मान ली जाती है।

3. सेवा का परिमाण

सेवा का परिमाण ऊर्ध्वाधर परिवहन प्रणाली की यात्री संभलाई क्षमता की माप है। यह दिन के सर्वाधिक व्यस्ततम समय में प्रत्येक पाँच मिनट के दौरान संभाले गए कुल यात्रियों की संख्या के रूप में मापी जाती है। पाँच मिनट की आधार अवधि का प्रयोग इसलिए किया जाता है कि वह अति व्यावहारिक समय है जिसके दौरान यातायात का औसत निकाला जा सकता है। यात्री संभलाई क्षमता अनुमानित जनसंख्या का लगभग 10 से 15 प्रतिशत होनी चाहिए जो कि कार्यालयी भवन के विभिन्न अधिभोगियों के लिए भवन में 5 मिनट संभाली जाएगी और एकल उद्देश्य अधिभोग के कार्यालयी भवनों के लिए यह प्रतिशत 15 से 25 तक का होगा। आवासीय भवनों के लिए 7.5 प्रतिशत पर्याप्त है।

4. सेवा की गुणवत्ता

दूसरी ओर सेवा की गुणवत्ता सामान्यतः विभिन्न तलों पर यात्रियों के प्रतीक्षा समय के आधार पर मापी जाती है। इस पहलू के निर्धारण के लिए निम्नलिखित मार्गदर्शी सिद्धांत होंगे:

स्वीकार्य अंतराल या

गुणवत्ता की सेवा

20 से 25 सेकेंड तक

उत्कृष्ट

30 से 35 सेकेंड तक

अच्छा

35 से 40 सेकेंड तक

पर्याप्त

45 सेकेंड तक

खराब

45 सेकेंड से अधिक

असंतोषजनक

5. यातायात चरम

5.1 प्रातः की चरम अवधि के दौरान अधिकतम यातायात प्रवाह सामान्यतः किसी कार्यालय भवन में ऊर्ध्वाधर परिवहन के माप के रूप में प्रयुक्त होता है। सभी कार्यालयों के कर्मचारियों को अनुशासित होना अनिवार्य है और उनके लिए यह आवश्यक है कि वे समय से अपने स्थान पर पहुँचें। परिणामतः आवक यातायात प्रवाह अत्यधिक हो जाता है और आगमनकाल अल्प अवधि का होता है।

APPENDIX-V

DESIGN & LAYOUTS

General

Methods of calculating the traffic handling capabilities of lifts were first devised for office buildings. In due course detailed modifications were devised to suit other applications without altering the basic principles. The application to office buildings is still the most frequently used.

A lift installation for office building is normally designed to populate the building at a given rate and the three main factors to be considered are:

- (a) population or the number of people who require lift service,
- (b) handling capacity or the maximum flow rate required by these people,
- (c) interval or the quality of service required,

2. Population

2.1 The first point to be ascertained from the eventual occupier is the total building population and whether this is likely to increase in the future.

2.2 If a definite population figure is unobtainable an assessment should be made from the net area, and probable population density. Average population density can vary from about one person per 4 sqm to one person per 20 sqm. It is essential, therefore, that some indication of the probable population density should be obtained from the building owner. If no indication is possible population in the region of 5 sqm per person for general office buildings is usually assumed.

3 Quantity of Service

The quantity of service is a measure of the passenger handling capacity of a vertical transportation system. It is measured in terms of the total number of passengers handled during each five-minute peak period of the day. A five-minute base period is used as this is the most practical time over which the traffic can be averaged. The passenger handling capacity should be approximately 10 percent to 15 percent of the estimated population that has to be handled in the building in five minutes for diversified tenancy office building and 15 percent to 25 percent for single purpose occupancy office building. For residential buildings, 7.5 percent is sufficient.

4. Quality of Service

The quality of service on the other hand is generally measured by the passenger waiting time at the various floors. The following shall be guiding factor for determining this aspect:

Quality of service or

Acceptable Interval

20 to 25 seconds	Excellent
30 to 35 seconds	Good
35 to 40 seconds	Fair
40 to 45 seconds	Poor
Over 45 seconds	Unsatisfactory

5. Traffic Peaks

5.1 The maximum traffic flow during the morning peak period is usually used as a measure of the vertical transportation requirement in an office building. The employees of all offices are subject to discipline and are required to be at their place in time. Consequently, the incoming traffic flow is extremely high and the arrival time is over a short period.

5.2 कर्मचारियों के आगमन को अलग-अलग करके अधिकतम यातायात प्रवाह को कम करना कभी-कभी आवश्यक हो जाता है। यह चरम तथा लिफ्टों की आवश्यकता को भी कम कर देता है। परन्तु अनेक संगठन अलग-अलग करने पर आपत्ति कर सकते हैं और वे यह तरजीह दे सकते हैं कि सभी कर्मचारी एक समय पर पहुँचें चूँकि यह माना जाता है कि आगमन का अलग-अलग होना कारोबार के उचित समन्वय को प्रभावित कर सकता है।

6. क्षमता

एकल उद्देश्य वाले भवनों के लिए संस्तुत कार का न्यूनतम आकार वही उपयुक्त होगा जो 884 किग्रा० के ड्यूटी भार के लिए उपयुक्त हो। सामान्यतः बड़े कार्यालय भवनों के लिए 2040 किग्रा० तक की क्षमताओं वाली कारें आवश्यकतानुसार संस्तुत की जाती हैं।

7. चाल

यह अपेक्षित सेवा के परिणाम और वांछित सेवा की गुणवत्ता पर आधारित होती है। इसलिए चाल को दर्शाने के लिए कोई निश्चित सूत्र नहीं दिया जा सकता।

8. संस्तुत चालें

सामान्य मार्गदर्शी सिद्धांत निम्नलिखित हैं:

8.1 कार्यालय भवन यात्री लिफ्ट

क्रम सं०	तलों की संख्या	संस्तुत चाल
1.	4 से 5 तल तक	1 एम पी एस
2.	6 से 12 तल तक	1.5 एम पी एस
3.	12 तलों से अधिक	1.5 एम पी एस से अधिक

8.2 आवासी भवन यात्री लिफ्ट

क्रम सं०	तलों की संख्या	संस्तुत चाल
1.	4 से 8 तल तक	1 एम पी एस
2.	8 से 12 तल तक	1.5 एम पी एस
3.	12 तलों से अधिक	1.5 एम पी एस से अधिक

8.3 अस्पताल लिफ्ट (बिस्तर-सह-यात्री लिफ्ट)

क्रम सं०	तलों की संख्या	संस्तुत चाल
1.	4 तल तक	0.5 एम पी एस
2.	5 से 8 तल तक	0.75 एम पी एस
3.	8 तलों से अधिक	1 एम पी एस

8.4 माल लिफ्ट

क्रम सं०	तलों की संख्या	संस्तुत चाल
1.	6 तलों तक	0.5 एम पी एस
2.	6 तलों से अधिक	0.75 एम पी एस

टिप्पणी: (1) यात्री सह माल लिफ्टों की चाल यात्री लिफ्टों की चाल के समान होगी।

(2) वास्तविक चाल का परिकलन यातायात विश्लेषण के आधार पर किया जाएगा।

5.2 Sometimes it becomes necessary to reduce the maximum traffic flow by staggering the arrival of the employees so that different groups arrive at different times. This reduces the peak and also the requirement of lifts. However, many organizations may object to staggering and prefer to have all employees arrive at the same time since it is claimed that staggering will affect the proper co-ordination of business.

6. Capacity

The minimum size of car recommended for a single purpose buildings is one suitable for a duty load of 884 kg. Generally, for large office building cars with capacities up to 2040 kg are recommended according to the requirements.

7. Speed

It is dependent upon quantity of service required and the quality of service desired. Therefore, no set formulae for indicating the speed can be given.

8. Recommended Speeds

The following are general guidelines:

8.1 Office building Passenger lifts

S.No.	No. of Floors	Recommended Speed
1.	4 to 5 floors	1 MPS
2.	6 to 12 floors	1.5 MPS
3.	Above 12 floors	Above 1.5 MPS

8.2 Residential Building passenger lifts

S.No.	No. of Floors	Recommended Speed
1.	4 to 8 floors	1 MPS
2.	8 to 12 floors	1.5 MPS
3.	Above 12 floors	Above 1.5 MPS

8.3 Hospital Lifts (Bed cum passenger lifts)

S.No.	No. of Floors	Recommended Speed
1.	Upto 4 floors	0.5 MPS
2.	5 to 8 floors	0.75 MPS
3.	Above 8 floors	1 MPS

8.4 Goods Lifts

S.No.	No. of Floors	Recommended Speed
1.	Upto 6 floors	0.5 MPS
2.	Above 6 floors	0.75 MPS

Note: (1) For passenger cum goods lifts speed shall be followed as that of passenger lifts
 (2) Actual speed shall be worked out on the basis of traffic analysis)

9. अभिन्यास

यात्री लिफ्ट कार के स्वरूप और आकार का यातायात संभलाई के रूप में, दक्षता के साथ अलग-अलग संबंध है। इन लिफ्टों के अति उपयुक्त समानुपातों का अध्ययन यह दर्शाता है कि वास्तव में सर्वोत्तम समानुपात के निर्धारण में लिफ्ट कूप चौड़ाई मूल तत्व है। अर्थात् कार की चौड़ाई प्रवेश द्वार की चौड़ाई द्वारा निर्धारित होती है और कार की गहराई स्वीकार्य प्रति वर्ग मीटर लदान द्वारा विनियमित होती है। मध्य में खुलने वाले दरवाजे यात्री लिफ्टों के लिए सर्वाधिक व्यावहारिक तथा अति कुशल प्रवेश इकाईयां हैं

10. प्रातः काल के चरम समय के दौरान परिवहन और संभलाई क्षमता का निर्धारण

10.1 संभलाई क्षमता की गणना निम्नलिखित सूत्र द्वारा की जाती है।

$$H = \frac{300 \times Q \times 100}{T \times P}$$

जहाँ

H = संभलाई क्षमता, 5 मिनट की अवधि के दौरान संभाली गई चरम जनसंख्या के प्रतिशत के रूप में,

Q = कार में वहन किए गए यात्रियों की औसत संख्या

T = प्रतीक्षा अंतराल, और

P = चरम प्रातःकाल की अवधि के दौरान संभाली जाने वाली कुल जनसंख्या (यह लिफ्टों के विशेष बैंक द्वारा सेवित क्षेत्र से संबंधित है)।

'Q' का मान कार की विभाओं पर निर्भर होता है। यह ध्यान देने योग्य है कि कार प्रत्येक ट्रिप के दौरान सदैव अपनी अधिकतम क्षमता से नहीं भरी होती इसलिए 'H' की गणना के लिए 'Q' का मान कार की अधिकतम वहन क्षमता के 80% के रूप में लिया जाता है।

प्रतीक्षा अंतराल की गणना निम्नलिखित सूत्र द्वारा की जाती है :

$$T = \frac{RTT}{N}$$

जहाँ

T = प्रतीक्षा अंतराल;

N = लिफ्टों की संख्या, तथा

RTT = गमनाम्न काल (राउन्ड ट्रिप टाइम) अर्थात् प्रत्येक लिफ्ट द्वारा यात्रियों के पूरे भार को नीचले तल से लेने-विभिन्न ऊपरी तलों पर उन्हें छोड़ने तथा अगले ट्रिप के लिए नए यात्रियों को लेने के लिए भूतल तक वापस आने में अपेक्षित औसत समय है।

RTT निम्नलिखित प्रक्रियाओं के अपेक्षित समय का योग है :

(क) भूतल पर यात्रियों का प्रवेश,

(ख) प्रत्येक विसर्जन तल पर यात्रियों का निकास,

(ग) प्रत्येक प्रवर्तन प्रक्रिया से पूर्व दरवाजे बंद होने में लगा समय,

(घ) प्रत्येक विसर्जन प्रक्रिया पर दरवाजे के खुलने में लगा समय,

(ङ) त्वरण अवधि,

(च) विरामी और समतलन अवधि,

(छ) ऊपर जाते समय स्टॉपों के बीच पूर्ण निर्धारित चाल की अवधि, और

(ज) नीचे जाते समय स्टॉपों के बीच पूर्ण निर्धारित चाल की अवधि

यह पाया गया है कि संभलाई क्षमता प्रतीक्षा अंतराल के व्युत्क्रमानुपाती होती है और इस प्रकार RTT के समानुपाती होती है। लिफ्ट के RTT को 120 से 100 सेकेन्ड करने पर इसकी संभलाई क्षमता 20 प्रतिशत बढ़ जाती है। गमनागन काल को मात्र चाल को बढ़ाकर ही नहीं अपितु अवतरण और कार दरवाजों के खुलने और बंद होने, त्वरण, मंदन, समतलन और यात्री संचलन के डिजाइन को सुधार करके भी घटाया जा सकता है। इन कारकों की चर्चा नीचे की जा रही है।

(क) लिफ्ट कार के भीतर यात्रियों के प्रवेश और निकास के बीच लगने वाले समय को कम करने के लिए सर्वाधिक महत्वपूर्ण कारक दरवाजों का सही डिजाइन तथा कार की उचित चौड़ाई है। यह पाया गया है कि

9. Layout

The shape and size of the passenger lift car bears a distinct relation to its efficiency as a medium of traffic handling. A study of the most suitable proportions for these lifts reveal that the width of the lift well entrance is, in reality, the basic element in the determination of the best proportions. In other words, the width of the car is determined by the width of the entrance, and the depth of the car is regulated by the loading per square metre permissible. Centre opening doors are the most practicable and the most efficient entrance units for passenger lifts.

10. Determination of Transportation or Handling Capacity During the Morning Peak

10.1 The handling capacity is calculated by the formula:

$$H = \frac{300 \times Q \times 100}{T \times P}$$

Where

- H = handling capacity as the percentage of the peak population handled during 5 min period,
Q = average number of passengers carried in a car,
T = waiting interval, and
P = total population to be handled during peak morning period. (It is related to the area served by a particular bank of lifts)

The value of 'Q' depends on the dimensions of the car. It may be noted that the car is not loaded always to its maximum capacity during each trip and, therefore, for calculating 'H' the value of 'Q' is taken as 80 percent of the maximum carrying capacity of the car.

The waiting interval is calculated by the formula:

$$T = \frac{RTT}{N}$$

Where

- T = waiting interval;
N = number of lifts, and

RTT = round trip time, that is, the average time required by each lift in taking one full load of passengers from ground floor, discharging them in various upper floors and coming back to ground floor for taking fresh passengers for the next trip.

RTT is the sum of the time required in the following process:

- (a) Entry of the passengers on the ground floor,
- (b) Exit of the passengers on each floor of discharge,
- (c) Door closing time before each starting operation,
- (d) Door opening time on each discharging operation,
- (e) Acceleration periods,
- (f) Stopping and levelling periods,
- (g) Period of full rated speeds between stops going up, and
- (h) Period of full rated speeds between stops going down.

It is observed that the handling capacity is inversely proportional to the waiting interval which in turn is proportional to RTT. Reducing the RTT of a lift from 120 to 100 secs. increases its handling capacity by 20 percent.

The round trip time can be decreased not only by increasing the speed of the lift but also by improving the design of the equipment related to opening and closing of the landing and car doors, acceleration, deceleration, levelling and passenger movement. These factors are discussed below:

- (a) The most important factor in shortening the time consumed between the entry and the exit of the passengers to the lift car is the correct design of the doors and the

यात्रियों के आरामदायक प्रवेश और निकास के लिए अति उपयुक्त दरवाजे की चौड़ाई 1000 मिमी० तथा कार की चौड़ाई 2000 मिमी० है।

(ख) मध्य में खुलने वाले दरवाजों का उपयोग यात्री अंतरण समय को सुधारने में एक निश्चित कारक रहा है। इस प्रकार के दरवाजों का उपयोग करने से सामान्य नियम के अनुसार दरवाजों को पूरा खुलने के पहले ही यात्री चलना प्रारम्भ कर देते हैं। जबकि दूसरी और पार्श्व में खुलने वाले दरवाजों के यात्रियों को दरवाजे को पूरा खुलने का इंतजार करना पड़ता है।

मध्य में खुलने वाले दरवाजों का उपयोग दरवाजों की खुलने और बंद होने की समयावधि के पक्ष में भी है। दरवाजों की समान चाल के होते हुए भी मध्य में खुलने वाला दरवाजा पार्श्व में खुलने वाले दरवाजे से अधिक तेज होता है। निसंदेह मध्य में खुलने वाला दरवाजा लिफ्ट प्रचालन में परिवहन क्षमता में वृद्धि को प्रदर्शित करता है।

11.0 स्पष्टीकरण

व्यावसायिक भवन (कार्यालय भवन) में उपर्युक्त विचारण के उपयोग से संबंधित एक स्पष्ट उदाहरण नीचे दिया गया है :

1.	सकल क्षेत्रफल प्रति तल	:	1200 वर्ग मी०
2.	वास्तव में उपयोग करने योग्य क्षेत्रफल प्रति तल (माना 90%)	:	1080 वर्ग मी०
3.	भूतल सहित अवतरणों की संख्या	:	8
4.	अनुमानित जनसंख्या घनत्व	:	10 वर्ग मी० प्रति व्यक्ति
5.	जनसंख्या प्रति तल	:	1080/10= 108 व्यक्ति
6.	(i) भूतल के अलावा ऊपरी तलों की संभावित जनसंख्या	:	108x7 =756 व्यक्ति
7.	13 यात्रियों तथा 1.5 मी०/से० चाल वाली लिफ्ट का RTT	:	90 सेकेन्ड
8.	सामान्यतः एक लिफ्ट कार सदैव अपनी पूरी क्षमता से नहीं भरी होती इसलिए कार का लदान 80% मानकर कार में वहन किए गए यात्रियों की औसत संख्या (Q)	:	= 13 x 0.8= 10 यात्री
9.	लिफ्टों की संख्या (माना) (N)	:	2
10.	अतः प्रतीक्षा अंतराल (T)	:	RTT/ N= 90/2 =45 सेकेन्ड
11.	संभलाई क्षमता (H)	:	$\frac{300 \times Q \times 100}{T \times P}$

$$H = \frac{300 \times 10 \times 100}{45 \times 756} = 8.8 \%$$

इस मामले में परिमाण (H) और गुणवत्ता (T) दोनों संतोषजनक नहीं हैं। पर्याप्त अच्छी सेवा के लिए 'H' का मान लगभग 10 से 15% तक तथा 'T' लगभग 30 सेकेन्ड होना चाहिए अतः यह आवश्यक है कि हम लिफ्टों की संख्या को बढ़ाकर तीन कर दें।

अतः N =3 के आधार पर गणना करने पर

$$T = \frac{90}{3} = 30 \text{ सेकेन्ड}$$

$$H = \frac{300 \times 10 \times 100}{30 \times 750} = 13.2 \%$$

इस मामले में H और T दोनों अच्छे हैं,

उपर्युक्त उदाहरण में यह माना गया है कि लिफ्ट, भू अवतरण से ऊपर, प्रथम तल सहित सभी तलों की सेवा करेगी। परन्तु अधिकांश मामलों में लिफ्ट को इस प्रकार प्रोग्रामित किया गया है कि वह प्रथम तल को छोड़ दे। ऐसे मामले में (i) प्रथम तल के यात्रियों के उतरने और चढ़ने के समय के घटने और (ii) भूतल और द्वितीय तल अवतरणों के बीच उच्चतर औसत चाल के कारण RTT कम हो जाएगा। इसी प्रकार सात तलों के स्थान पर छह तलों की जनसंख्या की सेवा की जाएगी। इस प्रकार दो लिफ्टों से भी संतोषजनक 'H' और 'T' प्राप्त करना सम्भव हो सकता है।

proper car width. For comfortable entry and exit for passengers, it has been found that most suitable door width is 1000 mm and that of car width is 2000 mm.

(b) The utilization of centre opening doors has been a definite factor in improving passenger transfer time, since when using this type of door the passengers, as a general rule, begin to move before the doors have been completely opened. On the other hand, with a side opening door the passengers tend to wait until the door has completely opened before moving.

The utilization of centre opening doors also favours the door opening and closing time periods. Given the same door speed, the centre opening door is much faster than the side opening type. It is beyond doubt that the centre opening door represents an increase in transportational capacity in the operation of a lift.

11.0 Illustration

An example illustrating the use of the above consideration in respect of business building (office building) is given below:

1.	Gross Area per floor	:	1200 sqm
2.	Net useable area per floor (say 90%)	:	1080 sqm
3.	No. of landing including ground	:	8
4.	Assuming population density	:	10 sqm per person
5.	Population per floor	:	1080/10= 108 persons
6.	(i) Probable population on upper floors excluding ground floor	:	108x7 =756 persons
7.	Taking 13 passenger lift with 1.5 m/s, the RTT	:	90 sec
8.	A lift car is not normally loaded to its full capacity so assuming 80%. Loading of the car, the average number of passenger carried in a car (Q)	:	= 13 x 0.8= 10 persons
9.	Taking no. of lifts (N)	:	2
10.	Then Waiting Interval (T)	:	RTT/ N= 90/2 =45 sec
11.	Handling capacity (H)	:	$\frac{300 \times Q \times 100}{T \times P}$

$$H = \frac{300 \times 10 \times 100}{45 \times 756} = 8.8 \%$$

But neither the quantity (H) nor the quality (T) is satisfactory in this case. The value for H and T should be around 10 percent to 15 percent and around 30 seconds respectively for a service to be reasonably good. Therefore we need to increase the number of lifts to three.

Now let us work out on the basis of N =3.

$$T = \frac{90}{3} = 30 \text{ seconds}$$

$$H = \frac{300 \times 10 \times 100}{30 \times 750} = 13.2 \%$$

In this case both H as well as T are good.

In the above example, it has been assumed that the lift would serve all the floor including the first floor, above ground landing. But in most of the cases, lift is so programmed as to skip first floor. In such a case, the RTT will be lesser owing to (i) reduction in the loading and unloading time for the first floor passengers and (ii) higher average speed between the ground floor and the second floor landings. Similarly the population to be served will be of six floors instead of seven floors. However satisfactory 'H' & 'T' can be possibly attained even with two lifts.

यात्री लिफ्टों के लिए गर्त, शिरोपरि और मशीन-कक्ष के लिए संस्तुत विभाएं

(सभी विभाएं मिलीमीटर में)

चाल मी०/से०	0.70 तक	>0.70≤ 1.00	>1.00≤ 1.50	>1.50≤ 1.75	>1.75≤ 2.00	>2.00≤ 2.50
गर्त गहराई	1350	1500	1600	2150	2200	2500
शिरोपरि	4200	4250	4800	4800	5200	5400
मशीन कक्ष गहराई	D+2000			D+2500		
मशीन कक्ष चौड़ाई	C+1000		C+1200		C+1500	

टिप्पणियां

- कुल शिरोपरि विभाओं की गणना 2.3 मी कार की ऊँचाई के आधार पर की गयी है।
- हस्तचलित दरवाजों के मामले में, स्पष्ट द्वार अवतरण दरवाजे के हथके के प्रक्षेप के बराबर घट जाएगा।
- पीछे की ओर प्रतिभार तथा मध्य में खुलने वाली पॉवर प्रचालित लिफ्टों के लिए ऊपर दी गयी सभी विभाएं मुख्यतः वास्तुकारों और भवन योजनाकारों के लिए संस्तुत विभाएं हैं। विनिर्माता और क्रेता के बीच परस्पर सहमत परिवर्तन की अनुमति दी जाती है। परन्तु, परिवर्तन -
 - कार की भीतरी विभाएं विनिर्धारित अधिकतम क्षेत्र सीमा के भीतर होगी।
 - ऊपर की ओर प्रवेश चौड़ाई की अनुमति है।
 - नीचे की ओर प्रवेश चौड़ाई 100 मिमी० तक, जो कि न्यूनतम 700 मिमी० होगी, की अनुमति है।
- गर्त गहराई और शिरोपरि की विभाएं भार, चाल और ड्राइव के आधार पर विनिर्माता विशेष की डिजाइन के अनुसार भिन्न हो सकती है। गर्त गहराई, शिरोपरि और मशीन कक्ष के लिए संस्तुत विभाएं सारणी में दी गयी हैं। परन्तु गर्त गहराई और शिरोपरि इस प्रकार होनी चाहिए कि वे आई एस 14665 (भाग 2/धारा 1) के 4.5 के अनुसार नीचे और ऊपर के अवकाश की आवश्यकताओं की पुष्टि करें।

Recommended Dimensions of Pit, Overhead and Machine-Room of Passenger Lifts

All dimensions in millimeters

Speed in M/s	Upto 0.70	>0.70≤ 1.00	>1.00≤ 1.50	>1.50≤ 1.75	>1.75≤ 2.00	>2.00≤ 2.50
Pit depth	1350	1500	1600	2150	2200	2500
Overhead	4200	4250	4800	4800	5200	5400
Machine room Depth	D+2000			D+2500		
Machine room Width	C+1000		C+1200		C+1500	

Notes:

1. The total overhead dimensions has been calculated on the basis of car height of 2.3m.
2. In case of manually operated doors, clear entrance will be reduced by the amount of projection of handle on the landing door.
3. All dimensions given above for lifts having centre opening power operated doors with counterweight at rear, are recommended dimensions primarily for architects and building planners. Any variations mutually agreed between manufacturer and purchaser are permitted. However, variation in:
 - (i) Car inside dimensions shall be within the maximum area limits specified.
 - (ii) Entrance width on higher side is permitted.
 - (iii) Entrance width on lower side is permitted up to 100mm subject to minimum of 700mm.
4. Dimensions of pit depth and overhead may differ in practice as per individual manufacturer's design depending upon load, speed and drive. Recommended dimensions for pit depth, overhead and machine room for different lift speeds are given in Table. However, the pit depth and overhead shall be such as to conform to the requirements of bottom clearance and top clearance as per 4.5 of the IS 14665 (Part 2/Sec 1).

यात्री लिफ्ट की संस्तुत विभाएं

सभी विभाएं मिलीमीटर में

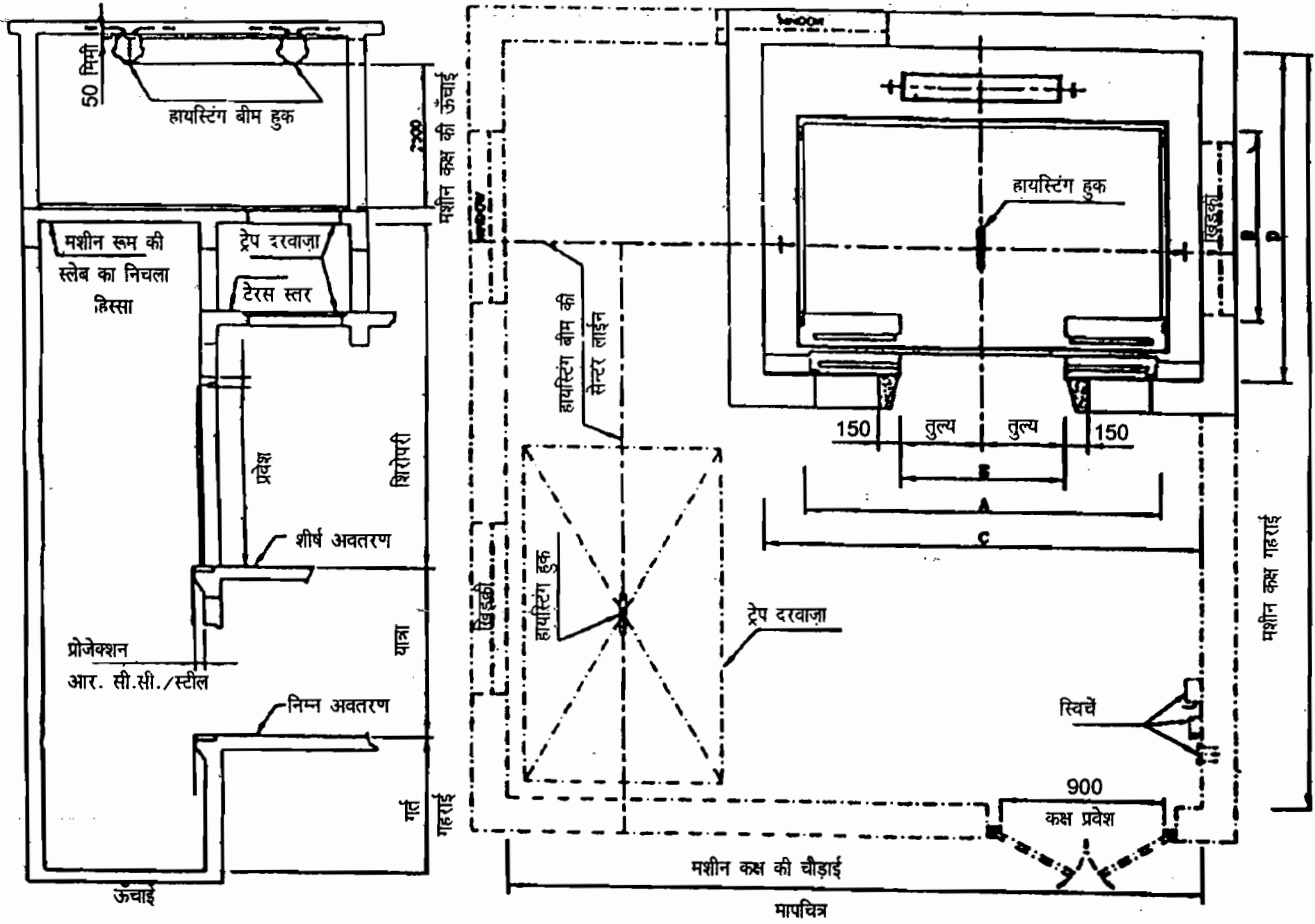

भार		कार पार्श्व		लिफ्ट कूप		प्रवेश
व्यक्ति	कि० ग्रा०	A	B	C	D	E
(1)	(2)	(3)	(4)	(5)	(6)	(7)
4	272	1100	700	1900	1300	700 (न्यूनतम)
6	408	1100	1000	1900	1700	700 (न्यूनतम)
8	544	1300	1100	1900	1900	800
10	680	1300	1350	1900	2100	800
13	884	2000	1100	2500	1900	900
16	1088	2000	1300	2500	2100	1000
20	1360	2000	1500	2500	2400	1000

माल लिफ्ट की संस्तुत की विभाएं

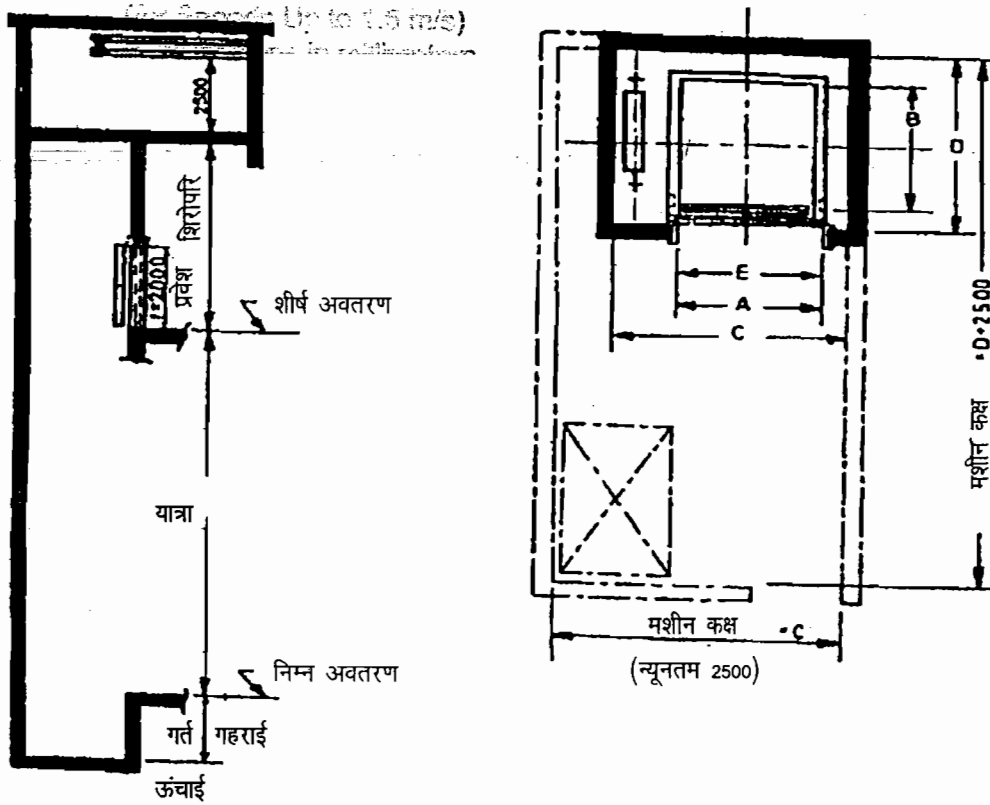

भार किग्रा०	कार के भीतर		लिफ्ट कूप		प्रवेश E
	A	B	C	D	
500	1100	1200	1900	1500	1100
1000	1400	1800	2300	2100	1400
1500	1700	2000	2600	2300	1700
2000	1700	2500	2600	2800	1700
2500	2000	2500	2900	2800	2000
3000	2000	3000	2900	3300	2000
4000	2500	3000	3400	3300	2500
5000	2500	3600	3400	3900	2500

टिप्पणियां

1. मशीन कक्ष की चौड़ाई लिफ्ट कूप की चौड़ाई 'C' जो कि न्यूनतम 2500 मिमी० होगी, के बराबर होनी चाहिए।
2. कुल हेडरूम (शीर्ष कक्ष) की गणना 2.2 मी० कार ऊंचाई के आधार पर की गयी है।
3. स्पष्ट प्रवेश चौड़ाई ऊर्ध्वाधर उत्थापन कार-दरवाजे तथा ऊर्ध्वाधर द्विविभाजक अवतरण दरवाजों पर आधारित होती है। सिमटवाँ मध्य-छड़ दरवाजों के लिए स्पष्ट प्रवेश चौड़ाई 200 मिमी० घटा दी जाएगी। (अधिकतम 1800 मिमी०)।
4. ऊपर दी गयी सभी विभाएं मुख्यतः वास्तुकारों और भवन योजनाकारों के लिए संस्तुत विभाएं हैं। ऐसे परिवर्तन की अनुमति दी जाती है जिसपर विनिर्माता और क्रेता के बीच परस्पर सहमति हो। परन्तु कार के भीतर की विभाओं में परिवर्तन आई एस 14665 (भाग 3/धारा 1) में यथा विनिर्दिष्ट अधिकतम क्षेत्र सीमाओं के भीतर होगा।
5. गर्त गहराई और शिरोपरि की विभाएं भार, चाल और ड्राइव (चालन) के आधार पर विनिर्माता विशेष की डिजाइन के अनुसार भिन्न हो सकती हैं। परन्तु गर्त गहराई और शिरोपरि इस प्रकार होनी चाहिए कि वे आई एस 14665 (भाग 2/धारा 1) के अनुसार नीचे और ऊपर के अवकाश की आवश्यकताओं को पुष्टि करें।

Recommended Dimensions of Goods Lifts

(सुझावित्तु आकारांतर ५)

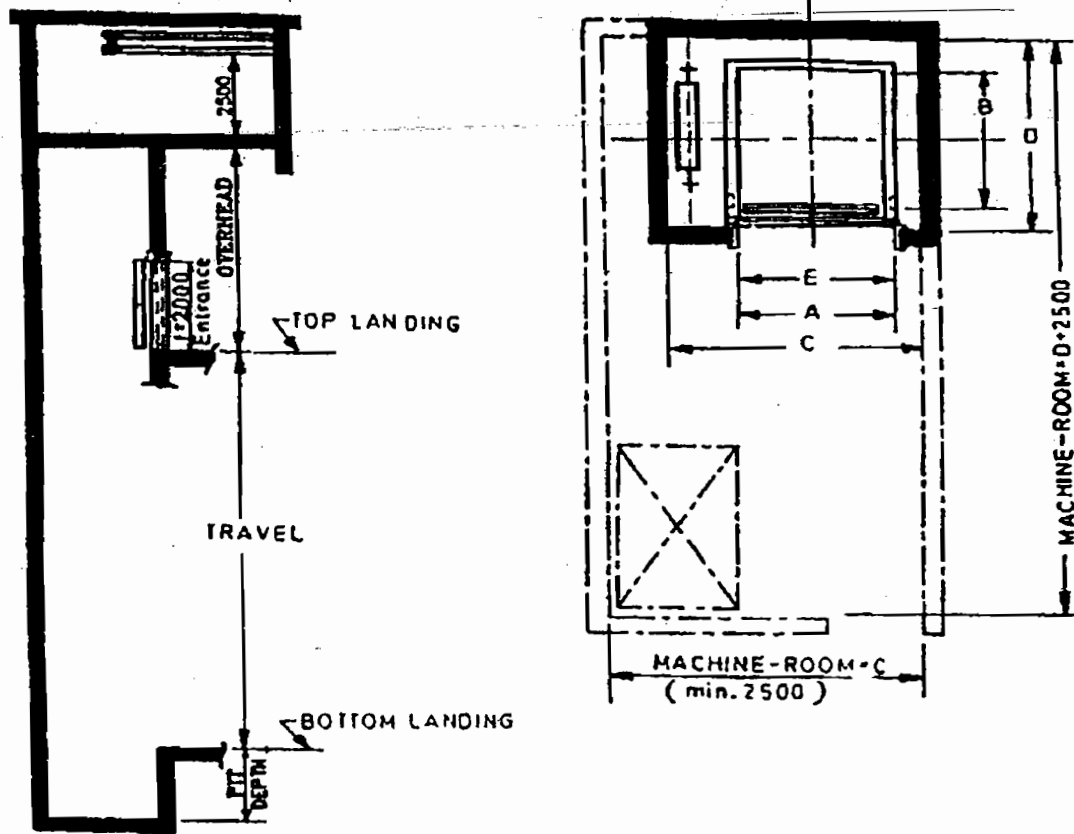

Load Kg.	Car Inside		Lift Well		Entrance
	A	B	C	D	E
500	1100	1200	1900	1500	1100
1000	1400	1800	2300	2100	1400
1500	1700	2000	2600	2300	1700
2000	1700	2500	2600	2800	1700
2500	2000	2500	2900	2800	2000
3000	2000	3000	2900	3300	2000
4000	2500	3000	3400	3300	2500
5000	2500	3600	3400	3900	2500

Notes:

1. The width of machine room shall be equal to the lift well width 'C' subject to minimum of 2500 mm.
2. The total headroom has been calculated on the basis of a car height of 2.2 m.
3. Clear entrance width 'E' is based on vertical lifting car-door and vertical biparting landing doors. For collapsible mid-bar doors the clear entrance width will be reduced by 200mm (maximum 1800mm)
4. All dimensions given above are recommended dimensions primarily for architects and building planners. Any variations mutually agreed between manufacturer and purchaser are permitted. However, variation in car inside dimensions shall be within the maximum area limits specified in IS 14665 (Part3/Sec 1).
5. Dimensions of pit depth and overhead may differ in practice as per individual manufacturer's design depending upon load, speed and drive. However, the pit depth and overhead shall be such as to conform to the requirements of bottom clearance and top clearance of IS 14665 (Part2/Sec 1).

अस्पताल लिफ्टों के लिए संस्तुत विभाएं
(1.5 मी०/से० तक चालों के लिए)
(सभी विभाएं मिली मीटर में)

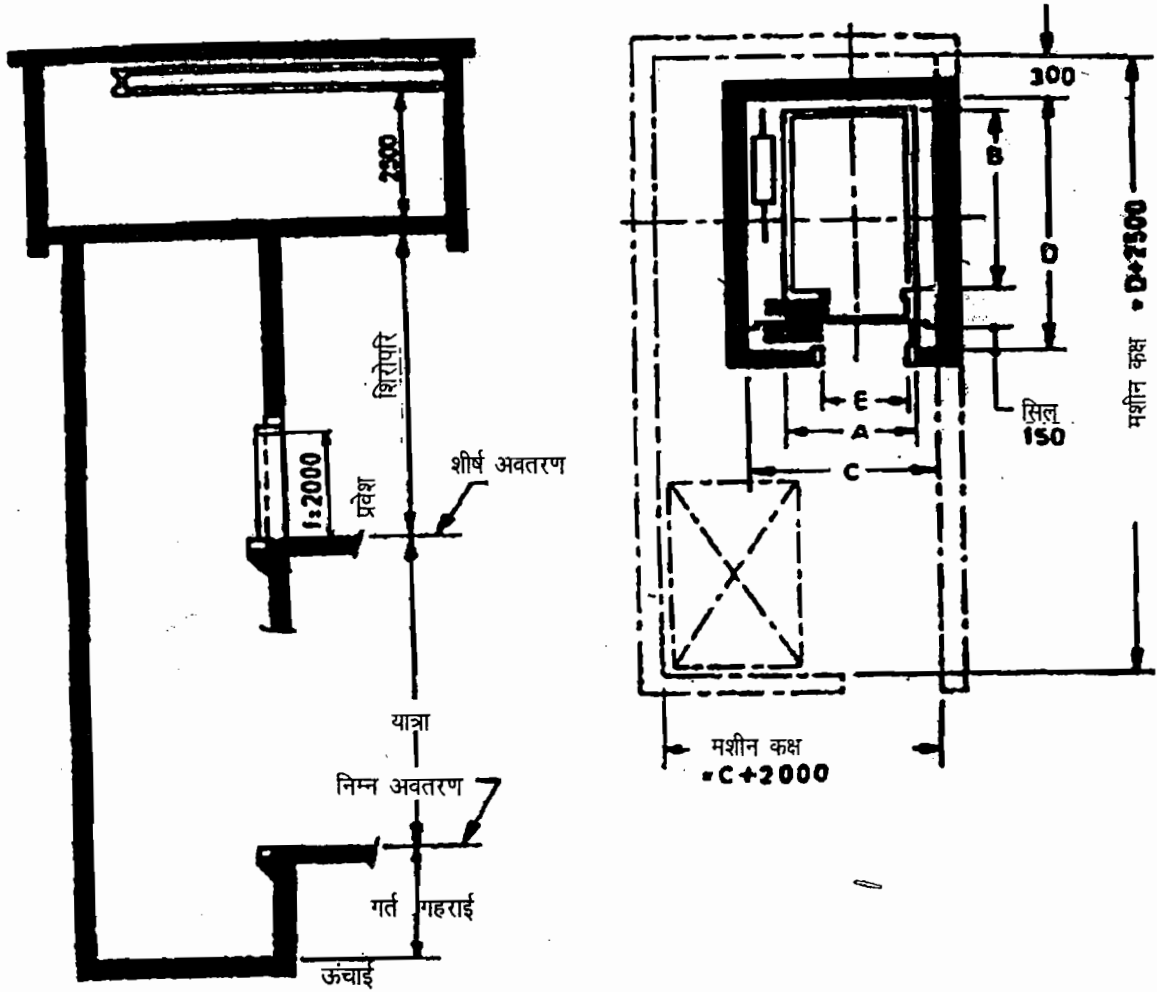

भार		कार के भीतर		लिफ्ट कूप		प्रवेश
व्यक्ति	कि० ग्रा०	A	B	C	D	E
15	1020	1000	2400	1800	3000	800
20	1360	1300	2400	2200	3000	1200
26	1768	1600	2400	2400	3000	1200

टिप्पणियां :

- कुल हेडरूम की गणना 2.2 मी० कार की ऊंचाई के आधार पर की गयी है।
- हस्तचालित दरवाजों के मामले में स्पष्ट प्रवेश अवतरण दरवाजे पर हत्ये के प्रक्षेप के बराबर घट जाएगा।
- यद्यपि 15 व्यक्तियों वाली लिफ्ट मानक नहीं है फिर भी लिफ्ट की कमतर क्षमता, जिसका उपयोग छोटे अस्पतालों में किया जा सकता है, को इसमें शामिल किया गया है।
- ऊपर दी गयी सभी विभाएं मुख्यतः वास्तुकारों और भवन योजनाकारों के लिए संस्तुत विभाएं हैं। ऐसे परिवर्तन की अनुमति दी जाती है जिसपर विनिर्माता और क्रेता के बीच परस्पर सहमति हो। परन्तु कार के भीतर की विभाओं में परिवर्तन आई एस 14665 (भाग 3/धारा 1) में यथा विनिर्दिष्ट अधिकतम क्षेत्र सीमाओं के भीतर होगा।
- गर्त गहराई और शिरोपरि विभाएं भार, चाल और ड्राइव (चालन) के आधार पर विनिर्माता विशेष की डिजाइन के अनुसार भिन्न हो सकती हैं। परन्तु गर्त गहराई और शिरोपरि इस प्रकार होनी चाहिए कि वे आई एस 14665 (भाग 2/धारा 1) के अनुसार नीचे और ऊपर के अवकाश की आवश्यकताओं को पुष्टि करें।

Recommended Dimensions of Hospital Lifts
(for Speeds Up to 1.5 m/s)
All dimensions in millimeters

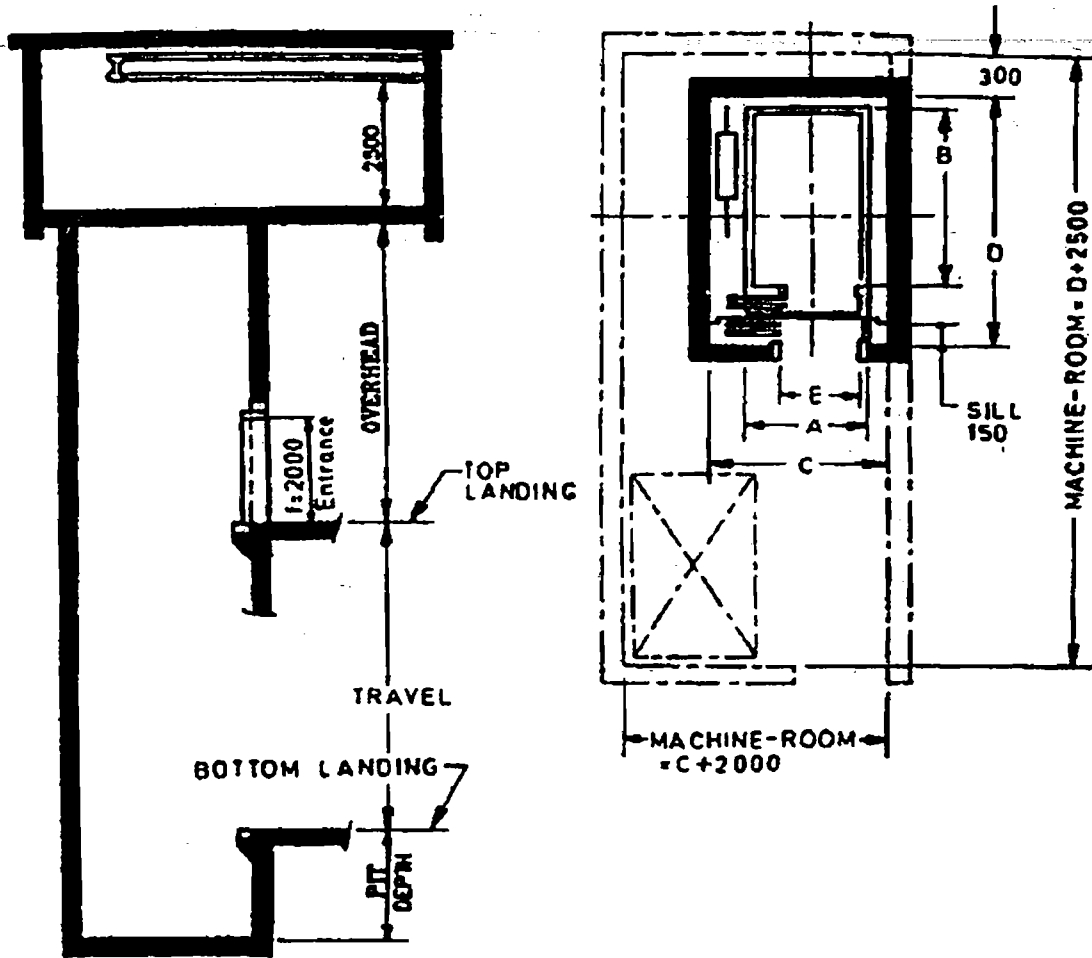

Load		Car Inside		Lift Well		Entrance
Persons	Kg	A	B	C	D	E
15	1020	1000	2400	1800	3000	800
20	1360	1300	2400	2200	3000	1200
26	1768	1600	2400	2400	3000	1200

Notes:

1. The total headroom has been calculated on basis of car height of 2.2 m.
2. In the case of manually operated doors, clear entrance will be reduced by the amount of projection of handle on the landing door.
3. Although 15 persons capacity lift is not standard one, this is included to cover lifts of smaller capacity which can be used in small hospitals.
4. All dimensions given above are recommended dimensions primarily for architects and building planners. Any variations mutually agreed between manufacturer and purchaser are permitted. However, variation in car inside dimensions shall be within the maximum area limits specified in IS 14665 (Part 3/Sec 1).
5. Dimensions of pit depth and overhead may differ in practice as per individual manufacturer's design depending upon load, speed and drive. However, the pit depth and overhead shall be such as conform to the requirements of bottom clearance and top clearance of IS 14665 (Part 2/Sec 1).

सेवा लिफ्टों की संस्तुत विभाएं

(सभी विभाएं मिली मीटर में)

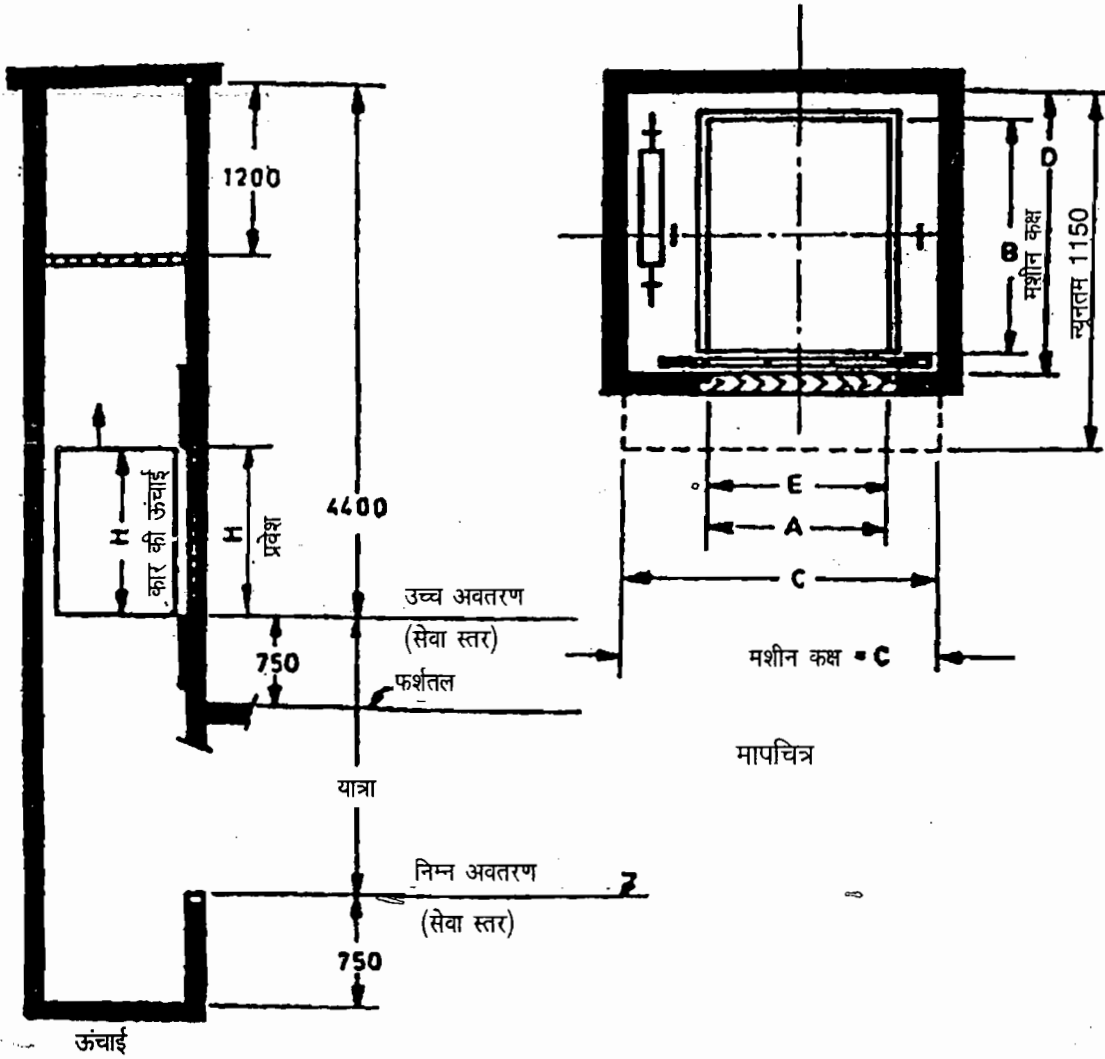

भार	कार के भीतर			लिफ्ट कूप		प्रवेश
कि०ग्रा०	A	B	H	C	D	E
100	700	700	800	1200	900	700
150	800	800	900	1300	1000	800
200	900	900	1000	1400	1100	900
250	1000	1000	1200	1500	1200	1000

टिप्पणियां : प्रवेश चौड़ाई 'E' ऊर्ध्वाधर द्विविभाजक दरवाजों की व्यवस्था की कल्पना पर आधारित है. (सामान्यतः किसी कार में नहीं दिया जाता)।

परिशिष्ट - VI

अग्नि सुरक्षा संबंधी आवश्यकताएं

लिफ्ट की सामान्य आवश्यकताएँ निम्नानुसार होंगी:

1. लिफ्ट आहाते की दीवारों की आग रेटिंग 2 घंटे की होनी चाहिए; लिफ्ट शैफ्ट में क्षेत्र शीर्ष पर वेंट, जो कि 0.2 मी² से कम न हो, होना चाहिए।
2. लिफ्ट मोटर कक्ष अधिमानतः शैफ्ट शीर्ष पर अवस्थित होगा और कक्ष के फर्श द्वारा शैफ्ट से विलगित होगा।
3. लिफ्ट आहाते में अवतरण दरवाजों का आग प्रतिरोध एक घंटे से कम का नहीं होना चाहिए।
4. एक लिफ्ट बैंक पर लिफ्टों की संख्या 4 से अधिक नहीं होनी चाहिए। बैंक का प्रत्येक शैफ्ट 2 घंटे आग रेटिंग वाली दीवार से पृथक किया होना चाहिए।
5. लिफ्ट कार दरवाजे की आग प्रतिरोध रेटिंग एक घंटे की होनी चाहिए।
6. 15 मी० या उससे अधिक ऊँचाई वाले भवनों के लिए सिमटवां दरवाजों की अनुमति नहीं होगी और इसके दरवाजे टोस तथा कम से कम 1 घंटे आग प्रतिरोध की क्षमता का होना चाहिए। यदि लिफ्ट शैफ्ट और लॉबी भवन के कोर में स्थित हों तो लॉबी में 25 और 30 Pa के बीच तथा लिफ्ट शैफ्ट में 50 Pa घनात्मक दाब बनाए रखा जाएगा। वातानुकूलन तंत्र स्वतः आग अलार्म के साथ कार्य करेगा; इसे यांत्रिक रूप से प्रचालित करना भी संभव होगा।
7. यदि लॉबी भवन के कोर में अवस्थित हो तो इससे निकलने का मार्ग एक घंटे आग प्रतिरोध क्षमता वाले स्वतः संवरक धूम रोधक दरवाजे से होकर होगा।
8. सामान्य लिफ्ट तहखाने से संपर्क नहीं रखेगी। परन्तु यदि लिफ्ट का तहखाने से संपर्क है तो तहखाने की लिफ्ट लॉबी मद (6) के अनुसार दाबानुकूलित तथा मद (7) के अनुसार स्वतः संवरक होगी।
9. भूतल स्तर पर भूसंपर्कन स्विच (स्विचें) सभी लिफ्टों पर उपलब्ध करायी जानी चाहिए ताकि अग्निशमन सेवा लिफ्टों को भू-संपर्कित कर सके।
10. 30 मी० या इससे अधिक ऊँचाई वाले भवनों के लिए लिफ्ट कारों में टेलीफोन या अन्य संचार सुविधाएं उपलब्ध करायी जाएंगी। लिफ्टों के लिए संचार प्रणाली भवन के अग्निशमन नियंत्रण कक्ष से जुड़ी होगी।
11. लिफ्ट लॉबी फर्श में ढलान जैसी उपयुक्त व्यवस्था की जानी चाहिए ताकि अग्निशमन के दौरान प्रयुक्त जल को किसी अवतरण पर लिफ्ट शैफ्ट में प्रवेश करने से रोका जा सके।
प्रत्येक तल पर या लिफ्ट के निकट ऐसा संकेत चिपकाया या बनाए रखा जाना चाहिए कि, जब तक अन्यथा अनुदेश न हो, आग लगने पर सीढ़ियों का प्रयोग करें। संकेत में प्रत्येक तल पर सीढ़ियों की स्थिति दर्शाई जानी चाहिए। सभी लिफ्टों के लिए, हस्त प्रचालित स्विच के माध्यम से परिवर्तनीय, विद्युत पूर्ति का वैकल्पिक स्रोत प्रदान किया जाना चाहिए।
12. फॉयर लिफ्ट - सभी लिफ्टों में फॉयर मैन स्विच दी जाएगी और इसे फॉयर लिफ्ट कहा जाएगा।
13. आग लगने की स्थिति में केवल फायर मैन ही फॉयर लिफ्ट को प्रचालित करेगा। सामान्य दशा में इसका उपयोग अन्य व्यक्ति भी कर सकते हैं।

APPENDIX -VI

FIRE SAFETY REQUIREMENTS

General requirements of lifts shall be as follows:

1. Walls of lift enclosures shall have a fire rating of 2 hours; lifts shafts shall have a vent at the top, of area not less than 0.2 m².
2. Lift motor room shall be located preferably on top of the shaft and separated from the shaft by the floor of the room.
3. Landing doors in lift enclosures shall have a fire resistance of not less than one hour.
4. The number of lifts in one lift bank shall not exceed 4. Individual shafts in a bank shall be separated by a wall of 2 hours fire rating.
5. Lift car door shall have a fire resistance rating of one hour.
6. For building 15m in height or above, collapsible gates shall not be permitted for lifts and shall have solid doors with fire resistance of a least 1 hour. If the lift shaft and lobby is in the core of the building, a positive pressure between 25 and 30Pa shall be maintained in the lobby and a positive pressure of 50 Pa shall be maintained in the lift shaft. The mechanism for pressurisation shall act automatically with the fire alarm; it shall be possible to operate this mechanically also.
7. Exit from the lift lobby, if located in the core of the building, shall be through a self-closing smoke stop door of half an hour fire resistance.
8. Lift shall not normally communicate with the basement. If, however, lifts are in communication, the lift lobby of the basements shall be pressurised as in (6), with self-closing door as in (7).
9. Grounding switch (es), at ground floor level, shall be provided on all the lifts to enable the fire service to ground the lifts.
10. Telephone or other communication facilities shall be provided in lift cars for building of 30m in height and above. Communication system for lifts shall be connected to fire control room for the building.
11. Suitable arrangements such as providing slope in the floor of lift lobby shall be made to prevent water used during fire fighting etc. at any landing from entering the lift shafts.

A sign shall be posted and maintained on every floor at or near the lift indicating that in case of fire, occupants shall use the stairs unless instructed other wise. The sign shall also contain a plan for each floor showing the locations of the stairways. Alternate source of power supply shall be provided for all the lifts through a manually operated changeover switch.

12. Fire Lifts- All lifts shall be provided with fire man's switch and shall be termed as 'Fire Lifts'.
13. In case of fire, only fireman shall operate fire lifts. In normal course, it may be used by other persons.

परिशिष्ट - VII

रोधिका मुक्त आवश्यकताएं

1. उप-विधि के अनुसार जहां भी लिफ्ट की आवश्यकता हो पहिएदार कुर्सी के उपभोक्ता के लिए, भारतीय मानक ब्यूरो द्वारा संस्तुत 13 व्यक्तियों की क्षमता वाली लिफ्ट के लिए निम्नलिखित पिंजरा विभा युक्त कम से कम एक लिफ्ट की व्यवस्था की जाएगी।

स्पष्ट भीतरी गहराई	:	1100 मिमी०
स्पष्ट भीतरी चौड़ाई	:	2000 मिमी०
प्रवेश द्वार चौड़ाई	:	900 मिमी०
2. एक हस्त रेल, जो फर्श तल से 900 मिमी० उपर 600 मिमी० से कम लम्बी न हो, नियंत्रण पैनल से सटी लगायी जानी चाहिए।
3. लिफ्ट लॉबी की भीतरी माप 1800 x 2000 मिमी० या अधिक होगी।
4. स्वतः संवरक दरवाजे बंद होने का न्यूनतम समय 5 सेकेंड तथा संवरण चाल 0.25 मी०/से० से अधिक नहीं होनी चाहिए।
5. पिंजरे के भीतरी भाग में एक ऐसी युक्ति प्रदान की जाएगी जो श्रव्य रूप से यह फर्श पर दर्शाए कि पिंजरा पहुंच गया है और यह संकेत दे कि प्रवेश या निकास के लिए पिंजरे का दरवाजा खुला है या बन्द ।
6. लिफ्टों के बाहर ब्रेल संकेतक लगाये जायेंगे।

APPENDIX –VII

(एन सी ई आर 1430 मीटर में)

BARRIER FREE REQUIREMENTS

1. Wherever lift is required as per by-laws, provision of at least one lift shall be made for the wheel chair user with the following cage dimensions of lift recommended for passenger lift of 13 persons capacity by Bureau of Indian Standards.
Clear internal depth : 1100 mm
Clear internal width : 2000 mm
Entrance door width : 900 mm
2. A hand rail not less than 600mm long at 900mm above floor level shall be fixed adjacent to the control panel.
3. The lift lobby shall be of an inside measurement of 1800 x 2000 mm or more.
4. The time of an automatically closing door should be minimum 5 seconds and the closing speed should not exceed 0.25 M/Sec.
5. The interior of the cage shall be provided with a device that audibly indicate the floor the cage has reached and indicate that the door of the cage for entrance/exit is either open or closed.
6. The Braille signage will be posted outside the lifts.

परिशिष्ट - VIII

सार्वजनिक भवनों में लिफ्टों की सुरक्षा - सी.वी.सी. की रिपोर्ट

सार्वजनिक भवनों में लिफ्टों की सुरक्षा से संबंधित सभी मामलों के संबंध में गहराई तक जाने के लिए सरकार द्वारा मुख्य तकनीकी परीक्षण, केन्द्रीय सतर्कता आयोग की अध्यक्षता में एक व्यवसायिक तकनीकी समिति गठित की गयी थी, इसके सदस्य सी.वी.सी. भारतीय मानक ब्यूरो सहित अन्य विभागों से लिए गए थे। समिति ने सार्वजनिक भवनों में शत प्रतिशत सुरक्षा सुनिश्चित करने के लिए निम्नलिखित सुझाव दिए हैं। इन सिफारिशों को सूचना, मार्ग निर्देश तथा अनुपालन के लिए शहरी विकास और गरीबी उन्मूलन मंत्रालय द्वारा ए.वी. शृंखला परिपत्र सं० 822 (ता० 25.10.2001) के तहत परिचालित किया गया था-

1. लिफ्टों में दुर्घटनाओं के संभावित कारणों की जाँच करते समय यह पाया गया कि यदि लिफ्ट फर्श तल से दूर रुक जाती है तो लिफ्ट में प्रदान किए गए पदाग्र गार्डों की कम लम्बाई के कारण देहली (सिल) और पदाग्र गार्ड के नीचले सिरे के बीच अधिक अंतराल रहने की सम्भावना होती है। अवतरण देहली तथा पदाग्र गार्ड के नीचले कोर के अंतराल को कम करने के लिए, ताकि दुर्घटनाबस अंतराल में गिरने से बचा जा सके, यह सिफारिश की जाती है कि 1.5 एम पी एस चाल वाली लिफ्टों के लिए पदाग्र गार्ड की न्यूनतम लंबाई 700 मि.मी. तथा 1.5 एम.पी.एस. से अधिक चाल वाली लिफ्टों के लिए 1000 मिमी० होनी चाहिए।
2. दुर्घटनाओं का और अधिक संभावित कारण कार का (बिजली फेल हो जाने के कारण) फर्श तल से दूर रुक जाने पर निचले तल का अवतरण दरवाजा पाश को खोलने का प्रयास हो सकता है। चूँकि आई एस 14665 (भाग 2/धारा 1) : 2000 पैरा 10.9.1 में उल्लिखित अनुसार बिजली फेल होने पर संवातन में सुधार या घुटन से बचने के लिए दरवाजे को खोला जा सकता है, इसलिए फंसे हुए व्यक्तियों के बीच यह प्रवृत्ति होती है कि वे विद्युत यांत्रिक लैच द्वारा खोले जा सकने वाले किसी सुगम अवतरण दरवाजे को खोलने का प्रयास करें, (इसका) कारण यह है कि कार का दरवाजा खुला होने पर पाश तक पहुंचा जा सकता है। घबराहट में इस प्रकार के प्रयास के परिणाम स्वरूप दुर्घटनावश लिफ्ट गर्त में गिर सकती है फंसे यात्री अवतरण दरवाजे को खोलने का प्रयास न करें यह सुनिश्चित करने के लिए विद्युत यांत्रिक लैच को इस प्रकार डिजाइन किया जाना चाहिए कि वह कार यात्रियों की पहुंच से बाहर हो या उन्हें दिखाई न दे।
3. यद्यपि आई एस 14665 (भाग 2/धारा 1) : 2000 का पैरा 8.4.3 आपात सिग्नल या कार के भीतर टेलीफोन की व्यवस्था के लिए सुझाव देता है परन्तु सामान्य अनुभव से यह देखा गया है कि समय के साथ किसी एक या अन्य कारणों से ये युक्तियां निष्क्रिय हो जाती हैं। अतः कम से कम एक युक्ति के सदैव सक्रिय रखने क उद्देश्य से वैकल्पिक व्यवस्था के रूप में यह सिफारिश की जाती है कि न्यूनतम दो कनेक्शनों वाले टेलीफोन - एक प्रचालक कक्ष में तथा दूसरा गार्ड कक्ष में तथा आपात सिग्नल दोनों की व्यवस्था की जानी चाहिए, साथ ही लिफ्ट कारों में पूर्ति स्रोत के रूप में पुनः चार्ज करने योग्य बैटरियां लगाई जानी चाहिए।
4. आपात सिग्नलों के लिए प्रयुक्त युक्ति में ऐसी विशेषता शामिल होनी चाहिए कि वह कार यात्रियों को तत्काल प्रतिपुष्टि करे कि युक्ति ने ठीक ढंग से कार्य किया है ओर सिग्नल आशदित एजेंसी को भेजा जा चुका है।
5. लिफ्ट कार को निकटतम अवतरण दरवाजों तक लाने के लिए उद्दृष्टि स्वचालित बचाव युक्तियों (ए आर डी) का प्रयोग चयनात्मक रूप से किया जाता है और यह समान्यतः अधिक यातायात वाले व्यापारिक भवन के लिए ही सीमित होती है। परन्तु बिजली का बार-बार फेल होना एक सामान्य बात है। यह सिफारिश की जाती है कि सार्वजनिक भवनों की सभी लिफ्टों में ए.आर.डी. की व्यवस्था को अनिवार्य किया जाना चाहिए।
6. विद्युत शक्ति द्वारा प्रचालित उपस्करों और मशीनरियों के लिए पूर्ति के नियमित स्रोत से बिजली का बार-बार फेल होना चिन्ता का मुख्य कारण रहा है। अतः पूर्ति का आपातोपयोगी स्रोत अपरिहार्य हो गया है। यद्यपि व्यापारिक भवनों में सामान्यतः पूर्ति की आपातोपयोगी व्यवस्था करायी जाती है परन्तु आवासीय भवनों में आपातोपयोगी पूर्ति की व्यवस्था को अब भी बहुत कम प्राथमिकता दी जाती है। विद्युत विफलता के कारण दुर्घटनावश किसी प्रकार के फंसाव से बचने के लिए आवासीय भवनों में, लिफ्टों के बैक-अप के लिए, ए एम एक पैन्ल युक्त, उपयुक्त क्षमता के डी.जी. सेटों की व्यवस्था की जानी चाहिए।

APPENDIX -VIII

SAFETY OF LIFTS IN PUBLIC BUILDINGS -CVC' REPORT

A Technical Committee of professionals under the Chairmanship of Chief Technical Examiner, Central Vigilance Commission having members from CVC and other departments including Bureau of Indian Standards was constituted by the Government to go into depth regarding all the related issues of safety of lifts in public buildings who gave following recommendations for ensuring hundred percent safety of lifts in public buildings. These recommendations were circulated for information, guidance and compliance by Ministry of Urban Development & Poverty Allevation vide A.V.series circular No. 822 dt. 25.10.2001:-

1. While examining the possible causes of accidents in lifts, it was found that in case the lift car stops away from the floor level, there is a possibility of wide gap left between the sill and the lower edge of the toe guard due to smaller length of toe guards provided in the lifts. In order to reduce the gap between the landing sill and lower edge of toe guard so as to prevent any accidental fall through the gap, it is recommended that the minimum length of toe guard should be 700mm for lifts with speeds of 1.5 mps and 1000 mm for lifts with speeds above 1.5 mps.
2. Another potential cause of accidents could be the attempts made to open the landing door lock of lower floor in case the car stops away from floor level due to power failure. Since the car door can be opened in case of power failure so as to improve the ventilation and avoid claustrophobic situations etc. as outlined in IS 14665 (part 2/sec 1) : 2000 para 10.9.1; there is a tendency among trapped passengers to make attempts to open any accessible landing door which can be opened by a electromechanical latch in the landing doors as the lock is accessible through open car doors. This attempt in panic may result in accidental fall into the lift pit. In order to ensure that the trapped passenger do not attempt opening the landing door, the electromechanical latch should be so designed that it is inaccessible or invisible to the passengers in the car.
3. Though para 8.4.3 of IS 14665 (part 2/sec 1) : 2000 recommends for provision of either an emergency signal or a telephone inside the car but as a general experience, it is seen that over a period of time these devices become inoperative due to one reasons or the other. Therefore, in order to have at least one device of communication functioning at all the times, as an alternative arrangement, it is recommended that the provision of both i.e. telephone with minimum two connections-one at the operator's room and other at guard room and the emergency signal with re-chargeable batteries as source of supply be made in the lift cars.
4. The device used for emergency signals should incorporate a feature that gives a immediate feedback to the car passengers that the device has worked properly and the signal has been passed on to the intended agency.
5. The Automatic Rescue Devices (ARD) meant for the purpose of bringing the lift car to the nearest landing doors, are being used selectively and is generally restricted to commercial building having heavy traffic. However, frequent power failures being the common phenomenon, it is recommended that provision of ARD should be made mandatory in all the lifts in public buildings.
6. Frequent power failure from regular sources of supply has been a major cause of concern for the equipments and machinery driven by electric power. Therefore, standby source of supply has become indispensable. Though in commercial building the standby supply is generally provided but in residential buildings, the provision of standby supply is still a lower priority. In order to avoid any accidental trapping because of power failure, in residential buildings, DG sets of suitable capacity with AMF panel should be provided as back up for the lifts.

7. कार में चढ़ते या उतरते समय दरवाजों को अकस्मात् बंद होने से बचने के लिए दरवाजों में सामान्यतः अवरक्त सेल प्रदान किए जाते हैं। परन्तु यह अनुभव किया गया है कि दरवाजों को अधिक समय तक खुले रखने के लिए छिद्रों को बंद आदि करके युक्तियों को छेड़ने की सम्भावना रहती है। इससे बचने के लिए यह सिफारिश की जाती है कि लिफ्ट दरवाजों में इसकी पूरी ऊँचाई को ढकते हुए टेम्पर रोधी पर्दा प्रदान किया जाना चाहिए।
8. सामान्यतः यह देखा गया है कि संगत आई. एस. के प्रावधान के अनुसार करें और न करें के अनुदेशों को लिफ्ट कारों में लगाया तो गया है परन्तु उनका प्रदर्शन का स्थान अस्पष्ट है या उनका आकार बहुत छोटा है या वे केवल एक ही भाषा में हैं। इन अनुदेशों को आशादित लक्ष्य प्राप्त करने के लिए, और मात्र संगत आई एस खंड के अनुपालन के लिए ही नहीं, यह सुझाव दिया जाता है कि इन्हें स्पष्ट स्थान पर लगाया जाए, इनकी लिपि बड़ी एवं समझने योग्य और इसे हिन्दी, अंग्रेजी तथा क्षेत्रीय भाषा में लिखा जाना चाहिए।
9. दाब बटन/फोन/अलार्म के नाम, उद्देश्य और संख्यांकन स्पष्ट प्रदर्शित किए जाने चाहिए और ये उपर्युक्त मद (8) में दर्शाए गए अनुदेशों के क्रम में होने चाहिए। यहाँ यह भी उल्लेख करना उचित होगा कि बटनों को अधिक समय तक लगातार उपयोग में लाने से बटनों की संख्याएं और संकेत क्षीण हो जाते हैं। इसे क्षीणन-रोधी बनाने के लिए आवश्यक निवारक उपाय किए जा सकते हैं।
10. उपर्युक्त मद (8) और (9) में सुझाए गए, अनुसार यात्री लिफ्ट कारों में रिकार्ड की गयी श्रव्य क्लीपिंग प्रदान की जाने की सम्भावना पर विचार किया जा सकता है। क्लीपिंग निरंतर चल सकती है और यात्रियों की सुरक्षा के लिए करें और न करें के अनुदेशों को हिन्दी, अंग्रेजी और क्षेत्रीय भाषा में दिया जा सकता है।
11. प्रत्येक लिफ्ट कार में स्पष्ट स्थान पर, निर्धारित भार तथा यांत्रिकों की अधिकतम स्वीकार्य संख्या लिखी एक भार (लोड) प्लेट, अतिभार अलार्म के साथ, लगाई जानी चाहिए।
12. पहचान के उद्देश्य से अवतरण दरवाजे के बाहर, कार के भीतर ओर मशीन कक्ष में लिफ्ट संख्या दर्शायी जानी चाहिए। इस संख्या का प्रयोग से मी./ निवारक अनुरक्षण के लिए मशीन कक्ष से प्रचालन के लिए तथा किसी दुर्घटना, आदि की रिपोर्ट देने के लिए सन्दर्भ के रूप में किया जा सकता है।
13. लिफ्ट अधिष्ठापन से संबंधित सभी विद्युत पूर्ति लाइनें और उपकरण इस प्रकार निर्मित, अधिष्ठपित, रक्षित, कृत और अनुरक्षित किए जाते हैं कि वे उसमें मौजूद व्यक्ति के लिए कोई खतरा उत्पन्न न करें। इसके लिए सभी खुले भागों को विधिवत विद्युत रोधित किए जाने चाहिए और उपस्करों को आई.एस. : 3043 में की गयी सिफारिशों के अनुसार तथा भारतीय विद्युत नियमों के नवीनतम उपबंधों की पुष्टि करते हुए सुरक्षित भूसंपर्कित किया जाना चाहिए।
14. मशीन कक्षों तथा लिफ्ट उपस्कर वाले अन्य कक्षों में पर्याप्त प्रकाश व्यवस्था की जानी चाहिए। लक्स स्तर कम से कम 20 लक्स होना चाहिए पूरी लिफ्ट में पर्याप्त प्रकाश की व्यवस्था अनिवार्य बनायी जानी चाहिए।
15. संगत आई.एस. विनिर्देशों के उपबंधों के अनुसार आग नियंत्रण अभ्यास करने के हेतु लिफ्ट का प्रयोग करने के लिए फायरमैन नियंत्रण/स्विच की व्यवस्था अनिवार्य की जानी चाहिए।
16. कुछ घटनाएं ऐसी भी हुई हैं। जिनमें मशीनरी की विफलता के कारण दुर्घटनाएं हुई हैं। यह मशीनरी की विफलता अकुशल कार्मिक को तैनात करने या उपस्कर की गलत संभलाई आदि जैसे मानव विफलता के कारण हुई है। ऐसी घटनाओं के कारण बिना अनुभवी और कम प्रतिष्ठित फर्मों को अनुरक्षण/प्रचालनों के कार्य को सौंपने में पूर्ववर्ती खामी या तदर्थवाद रहा है। अनुरक्षण और प्रचालन का कार्य केवल कुशल व्यक्तियों को नियोजित करने वाली प्रतिष्ठित और अनुभवी एजेंसियों को ही सौंपा जाना चाहिए। यथा संभव लिफ्ट के विनिर्माता को अनुरक्षण और प्रचालन कार्य देने पर विचार किया जाना चाहिए ताकि प्रणाली को अधिक जिम्मेवार बनाया जा सके।

7. In order to avoid accidental closure of doors while boarding or alighting the car, normally infrared cells are provided in the doors. But it has been experienced that there is a possibility of tampering with the devices by blocking the holes etc. to keep the doors open for longer time. To avoid this, it is recommended that a tamper proof infrared curtain covering the entire height of the door should be provided in the lift doors.
8. It is seen generally, that though the instruction on DO's and Don'ts, as per provision of the relevant IS, are displayed in lift cars but the same are either displayed in inconspicuous location, or are very small in size or are in one language only. To make these instructions serve the intended purpose, and not a mere compliance of relevant IS clause; it is suggested that these instructions should be displayed at a conspicuous location with larger and understandable script and should be written in Hindi, English and regional language.
9. The name, purpose and numbering of the push buttons/ phone/ alarm should be displayed clearly and in the same sequence as indicated in the instructions shown against point (8) above, it is worthwhile to mention here that due to long and continuous use of buttons, the numbering and indications on the buttons get faded over a period of time. Necessary preventive arrangement may be made to make the same as fade-proof.
10. Apart from the written instructions in the lift cars as suggested against point (8) and (9) above, possibility of providing recorded audio clipping in the passenger cars may be considered. The clippings may run continuously and sequentially in Hindi, English and regional language giving instructions on DO's and Don'ts for safety of the passengers.
11. A load plate along with overload alarm, giving the rated load and permissible maximum number of passengers should be fitted in each lift car in a conspicuous position.
12. For the purpose of identification, the lift number should be displayed outside the landing door, inside the car and in the machine room. This numbering may be used as reference for the purpose of routine/ preventive maintenance, for operating from machine rooms and reporting of any incidents etc.
13. All the electrical supply lines and apparatus in connection with the lift installation should be so constructed, installed, protected, worked and maintained that there may be no danger to persons there from. To do that, all the exposed parts should be duly insulated, equipments should be securely earthed in accordance with the recommendations made in IS: 3043 and also in conformity with the latest provisions of Indian Electricity rules.
14. The machine rooms and all other rooms containing lift equipment should be provided with adequate illumination. The lux level should be at least 200 lux. Provision of adequate lighting in the entire lift shaft should be made mandatory.
15. The provision of fireman's control / switch for the purpose of using the lift for carrying out fire control exercise as per provisions of relevant IS specifications should be made mandatory.
16. There have been quite a few instances, wherein the accidents do occur due to machinery failure which in turn is attributed to the human failure occurred in one or the other form like deploying of unskilled personnel or due to mishandling of the equipments etc. The reasons for such occurrences are the inherent shortcomings and adhocism in the award of the work of maintenance/ operations to inexperienced and less reputed firms. The task of maintenance and operation should be entrusted to reputed and experienced agencies, who deploy only skilled persons. As far as possible the manufacturer of the lift should be considered for undertaking maintenance and operation so as to make the system more accountable.

17. कुछ ऐसे मामले भी हैं। जिनमें फसे यात्रियों को बाहर निकालने की बचाव कार्रवाई के दौरान गम्भीर घातक दुर्घटनाएं हुई हैं। ऐसी दुर्घटनाएं अनुपयुक्त बचाव प्रचालन संभलाई या बचाव उद्देश्य के लिए उपेक्षित उप साधनों की अपर्याप्तता के कारण हुई हैं। ऐसी घटनाओं से बचने के उद्देश्य से दृढ़तापूर्वक यह सिफारिश की जाती है कि बचाव प्रक्रिया में लगे कार्मिक पूर्णतः सज्जित तथा बचाव प्रक्रिया संभलाई में प्रशिक्षित होने चाहिए। यह अनिवार्य है कि बचाव अभ्यास आई एस 14665 (भाग -2) धारा 1: 2000 के पैरा 10.10 में दिए गए अनुदेशों के अनुसार किया जाना चाहिए।
18. यह आवश्यक समझा गया है कि सभी विवरणों यथा, लिफ्ट संख्या प्रचालकों/अनुरक्षण कार्मिकों के नाम और पते, अनुरक्षण और प्रचालन कार्य हाथ में लेने वाली एजेंसी का विवरण तथा लिफ्ट का नेमी/निवारक अनुरक्षण के विवरण, की एक लॉग बुक रखी जाए। लॉगबुक सक्षम प्राधिकारी द्वारा और यदि लिफ्ट आवासी क्षेत्र में अधिष्ठापित है तो निवासी प्रतिनिधि द्वारा विधिवत प्रमाणिक की जानी चाहिए।
19. सभी लिफ्टों के लिए नकली ड्रिल अभ्यास अनिवार्य बनाए जाने चाहिए और वह वार्षिक अनुरक्षण संविदाओं का अंग होना चाहिए। पूर्व निर्धारित समयांतराल पर नियमित नकली ड्रिल संचालित करने का उत्तरदायित्व ए.एम.सी. लेने वाली एजेंसी का होगा और निवासी प्रतिनिधियों द्वारा इसे विधिवत जांचा जाना चाहिए। ऊपर के पैराओं में दिए गए सभी सुझाव संगत आई एस विनिर्देशों के अलावा और / या उसके साथ माने जाने चाहिए और यह नहीं समझा जाना चाहिए कि लिफ्टों के लिए किसी संगत आई एस विनिर्देश का अधिक्रमण कर दिया गया है। किसी प्रकार के टकराव की स्थिति में कार्यान्वय के लिए अधिक कठोर उपायों पर विचार किया जा सकता है।

17. There are some cases in which serious fatal accidents happened during rescue operation for taking out the trapped passengers. Such accidents occur due to improper handling of rescue operation or inadequate accessories required for rescue purpose. In order to avoid such occurrences, it is strongly recommended that personnel engaged for rescue operation should be fully equipped and trained in handling the rescue operation. It is essential to carry out the rescue exercise in accordance with the instruction contained in para 10.10 IS-14665 (part2/ Sec1): 2000.
18. It is felt necessary to maintain a log book containing all the details viz. Lift number, names and addresses of the operators/ maintenance personnel, details of the agency undertaking maintenance and operation and details of Routine/ Preventive maintenance of lifts etc. The logbook should be duly authenticated by a competent authority and also by a representative of residence in case the lift is installed in residential area.
19. The mock drill exercise for all the lifts should be made mandatory and should form part of Annual Maintenance Contracts. The responsibility of conducting mock-drills on regular pre-decided periodicity should lie with the agency undertaking the AMC, and the same should be duly vetted by the resident's representatives.

All the suggestions brought out in the above para should be considered in addition to and /or in conjunction with the relevant IS specifications and may not be deemed to have superseded any IS specification relevant to the lifts. In case of any clash the more stringent measure should be considered for implementation purpose.

लिफ्ट कारों में और लिफ्ट अवतरणों पर हिन्दी/अंग्रेजी में प्रदर्शित किए जाने वाले अनुदेश

आवासीय भवनों के लिए यात्री लिफ्ट

क्र० सं०	कार के भीतर	क्र० सं०	कार के बाहर
1.	लिफ्ट सं०	1.	लिफ्ट सं०
2.	क्षमता कि.ग्रा. व्यक्ति	2.	क्षमता-----व्यक्ति लिफ्ट प्रचालक सहित अधिक भार न लायें।
3.	धूम्रपान निषेध।	3.	कार के भीतर धूम्रपान वर्जित है।
4.	दाब बटन/स्विचों को ठीक से प्रचलित करें।	4.	यात्री अपने जोखिम पर यात्रा करें।
5.	लिफ्ट दरवाजों के सहारे से न खड़े हों।	5.	अवतरण दरवाजों को बलात न खोलें।
6.	बाहर जाने से पहले देखें।	6.	लिफ्ट के भीतर और बाहर जाने से पूर्व देखें।
7.	ब्रेक डौउन पर घबराएं नहीं अलार्म बटन दबाएं और प्राधिकृत स्टाफ के अनुदेशों का पालन करें।	7.	12 वर्ष से कम के बच्चों को लिफ्ट का उपयोग करने की अनुमति तभी दी जाएगी जब उनके साथ व्यस्क/प्रचालक हो।
		8.	लिफ्ट के लिए केवल विनिर्धारित यात्रियों और कुल अनुमेय भार तक वाली वस्तुओं की ही अनुमति दी जाएगी।
		9.	लिफ्ट में भारी वस्तुएं ले जाते समय फर्श या दीवारों को क्षतिग्रस्त होने से बचाने के लिए जूट की बोरी या ऐसे ही पदार्थ के उपयुक्त पैड का उपयोग किया जाना चाहिए। ऐसी तेज नोक या काँटेदार वस्तुओं, जिनसे लिफ्ट की दीवारों या फर्श को अधिक क्षति हो सकती है, को लिफ्ट में ले जाने की अनुमति नहीं होगी।
		10.	एल पी गैस के कंटेनर उचित प्रकार से सीलबन्द और रिसाव रोधी होने पर ही उन्हें ले जाने की अनुमति होगी। एक बार में एक से अधिक सिलिंडर की अनुमति नहीं होगी। एल० पी० गैस वहन करते समय एल पी गैस के प्रतिनिधि के अलावा किसी अन्य यात्री को अनुमति नहीं दी जाएगी।
		11.	सह-यात्रियों को आपत्ति न होने पर पालतू जानवर ले जा सकते हैं।
		12.	आग लगने पर लिफ्ट का प्रयोग न करें।
		13.	(अगर कोई) शिकायत, हो तो को भेजें।
		14.	प्रचालन का समय

**INSTRUCTION TO BE DISPLAYED IN HINDI/ ENGLISH IN
THE LIFT CARS AND LIFT LANDINGS**

Passenger Lift for Residential Buildings

<i>S.No.</i>	<i>Inside the Car</i>	<i>S.No.</i>	<i>Outside the Car</i>
1.	Lift Number	1.	Lift number
2.	Capacity.....Kg. Persons.....	2.	Capacity..... persons i/c lift operator. Do not overload.
3.	No smoking	3.	Smoking not permitted inside the car.
4.	Operate push buttons/ switches correctly	4.	Passenger travel at their own risk.
5.	Do not lean against lift door.	5.	Do not force open the landing doors.
6.	Watch before stepping out.	6.	Watch before you step into and out of the lift car.
7.	Do not panic in the event of break down. Press alarm button & follow instruction of authorised staff.	7.	Children below 12 years are allowed to use lift only if accompanied by adults/ operators.
		8.	Passenger and article(s) upto the total permissible load specified for the lift will only be allowed.
		9.	When heavy articles are taken in the lift suitable padding with gunny bags or other similar material should be used around the article to avoid damage to floor or walls. Articles with sharp projecting points or nails which will seriously damage the walls and flooring of the lift shall not be permitted.
		10.	L.P. Gas shall be permitted if the containers are properly sealed and leak proof. Not more than one cylinder shall be permitted at a time. While carrying L.P. gas apart from the representative of gas agency, no additional passenger shall be allowed.
		11.	Pet animals may be carried if co-passengers do not object.
		12.	Avoid use of lift during fire.
		13.	Complaint if any may be sent to.....
		14.	Hours of operation.....

लिफ्ट कारों में और लिफ्ट अवतरणों पर हिन्दी/अंग्रेजी में प्रदर्शित किए जाने वाले अनुदेश ।

गैर आवासीय भवनों के लिए यात्री लिफ्ट

क्र० सं०	कार के भीतर	क्र० सं०	कार के बाहर
1.	लिफ्ट सं०	1.	लिफ्ट सं०
2.	क्षमता कि.ग्रा.व्यक्ति	2.	क्षमता व्यक्ति
3.	धूम्रपान निषेध	3.	कृपया पंक्ति में खड़े हों।
4.	दाब बटन/स्विचों को ठीक से प्रचालित करें	4.	कार के भीतर धूम्रपान वर्जित है।
5.	लिफ्ट दरवाजों के सहारे न खड़े हों	5.	यात्री अपने जोखिम पर यात्रा करें।
6.	बाहर जाने से पहले देखें।	6.	लिफ्ट को साफ सुथरा रखें।
7.	ब्रेक डौउन पर घबराएं नहीं अलार्म बटन दबाएं और प्राधिकृत स्टाफ के अनुदेशों का पालन करें।	7.	अवतरण दरवाजों को बलात न खोलें।
		8.	लिफ्ट के भीतर और बाहर जाने से पूर्व देखें।
		9.	भारी वस्तु सामान ले जाने की अनुमति नहीं है।
		10.	आग लगने पर लिफ्ट का प्रयोग न करें।
		11.	अगर कोई शिकायत हो तो को भेजें।
		12.	प्रचालन का समय.....

INSTRUCTION TO BE DISPLAYED IN HINDI/ ENGLISH IN
THE LIFT CARS AND LIFT LANDINGS

Passenger Lift for Non-Residential Buildings

S.No.	Inside the Car	S.No.	Outside the Car
1.	Lift number	1.	Lift number.....
2.	Capacitykg. Persons.....	2.	Capacity.....persons.....
3.	No smoking	3.	Please stand in 'Q'
4.	Operate push buttons/ switches correctly.	4.	Smoking not permitted inside the car.
5.	Do not lean against the lift door.	5.	Passenger travel at their own risk.
6.	Watch before stepping out.	6.	Please keep the lift neat and clean
7.	Do not panic in the event of breakdown. Press alarm buttons and follow instructions of authorised staff	7.	Do not force open the landing door.
		8.	Watch before you step into and out of the lift car.
		9.	Heavy article/ luggage not allowed.
		10.	Avoid use of lift during fire.
		11.	Complaints if any may be sent to.....
		12.	Hours of operation.....

लिफ्ट कारों में तथा लिफ्ट अवतरणों पर हिन्दी/अंग्रेजी में प्रदर्शित किए जाने वाले अनुदेश

FOR THE LIFT CARREIERS AND PASSENGERS IN HINDI/ENGLISH

गैर आवासीय भवनों के लिये माल लिफ्ट

क्र० सं०	कार के भीतर	क्र० सं०	कार के बाहर
1.	लिफ्ट सं०	1.	लिफ्ट सं०
2.	क्षमता कि.ग्रा.	2.	क्षमता कि०ग्रा०।
3.	धूम्रपान निषेध	3.	कार के भीतर धूम्रपान वर्जित है।
4.	लिफ्ट प्रचालक के अलावा कोई अन्य व्यक्ति लिफ्ट को नहीं चलाएगा।	4.	लिफ्ट प्रचालक के अलावा कोई अन्य व्यक्ति लिफ्ट को नहीं चलाएगा।
5.	ब्रेक डाउन के समय घबराएं नहीं अलार्म बटन दबाएं और प्राधिकृत स्टॉफ के अनुदेशों का पालन करें।	5.	अवतरण दरवाजे को बलात न खोलें।
		6.	लिफ्ट कार के भीतर और बाहर जाने से पूर्व देखें।
		7.	आग लगने पर कार का प्रयोग न करें।
		8.	अगर कोई शिकायत हो तो.....को भेजें।
		9.	प्रचालन का समय.....

**INSTRUCTION TO BE DISPLAYED IN HINDI/ ENGLISH IN
THE LIFT CARS AND LIFT LANDINGS**

आवासीय भवनों के लिए राफ़्ट लिफ्ट

Goods Lift for Non-Residential Buildings

S.No.	Inside the Car	S.No.	Outside the Car
1.	Lift number.....	1.	Lift number.....
2.	Capacity.....Kg.	2.	Capacity.....kg
3.	No smoking	3.	Smoking not permitted inside the car.
4.	None other than the lift operator shall operate the lift.	4.	None other than lift operator shall operate the lift.
5.	Do not panic in the event of break down. Press alarm button and follow instructions of authorised staff.	5.	Do not force open the landing door.
		6.	Watch before you step into and out of the lift car.
		7.	Avoid use of lift during fire.
		8.	Complaints if any may be sent to.....
		9.	Hours of operation.....

**लिफ्ट कार के भीतर और लिफ्ट अवतरण पर हिन्दी/अंग्रेजी में प्रदर्शित किए जाने वाले अनुदेश
अस्पताल की लिफ्टें**

क्र० सं०	कार के भीतर	क्र० सं०	कार के बाहर
1.	लिफ्ट सं०	1.	लिफ्ट सं०
2.	क्षमता कि.ग्रा. व्यक्ति	2.	क्षमता कि०ग्रा० व्यक्ति।
3.	धूम्रपान निषेध	3.	कार के भीतर धूम्रपान वर्जित है।
4.	लिफ्ट प्रचालक के अलावा कोई अन्य व्यक्ति लिफ्ट को प्रचालित नहीं करेगा।	4.	यह लिफ्ट चिकित्सकों/मरीजों के लिए है।
5.	ब्रेक डाउन के समय घबराएं नहीं अलार्म बटन दबाएं और प्राधिकृत स्टाफ के अनुदेशों का पालन करें।	5.	लिफ्ट प्रचालक के अलावा कोई अन्य व्यक्ति लिफ्ट को प्रचालित नहीं करेगा।
		6.	लिफ्ट दरवाजे को बलात न खोलें।
		7.	लिफ्ट कार के भीतर और बाहर जाते समय देखें।
		8.	आग लगने पर लिफ्ट का प्रयोग न करें।
		9.	अगर कोई शिकायत हो तो.....को भेजें।
		10.	प्रचालन का समय.....

**INSTRUCTION TO BE DISPLAYED IN HINDI/ ENGLISH
IN THE LIFT CARS AND LIFT LANDINGS**

Hospital Lifts

S.No.	Inside the Car	S.No.	Outside the Car
1.	Lift number.....	1.	Lift number.....
2.	Capacity.....Kg. Persons.....	2.	Capacity.....kg., Persons.....
3.	No smoking	3.	Smoking not permitted inside the car.
4.	None other than the lift operator shall operate the lift.	4.	Lift available for Doctors/ Patients only.
5.	Do not panic in the event of break down. Press alarm button and follow instructions of authorised staff.	5.	None other than the lift operator shall operate the lift.
		6.	Do not force open the landing door.
		7.	Watch before you step into and out of the lift car.
		8.	Avoid use of lift during fire.
		9.	Complaints if any may be sent to.....
		10.	Hours of operation.....

परिशिष्ट - IX

लिफ्ट और एस्केलेटर अधिष्ठापनों से सम्बद्ध भारतीय मानकों की सूची

1.	विद्युत संकर्षण लिफ्ट भाग-1 यात्री, माल, सेवा और अस्पताल लिफ्टों की परिरेखी विभाओं के लिए मार्गदर्शी सिद्धांत	आई.एस. 14665 (भाग-1): 2000
2.	विद्युत संकर्षण लिफ्ट भाग-2, अधिष्ठापन, प्रचालन और अनुरक्षण के लिए व्यवहार संहिता धारा -1 यात्री और माल लिफ्ट धारा -2 सेवा लिफ्ट	आई.एस. 14665 (भाग-2/धारा 1 और 2) : 2000
3.	विद्युत संकर्षण लिफ्ट भाग-3 सुरक्षा नियम धारा-1 यात्री और माल लिफ्ट धारा-2 सेवा लिफ्ट	आई.एस. 14665 (भाग-3/धारा 1 और 2) : 2000
4.	विद्युत संकर्षण लिफ्ट भाग-4 घटक	आई.एस. 14665 (भाग-4/ धारा 1 से 9 तक) : 2000
5.	विद्युत संकर्षण लिफ्ट भाग-5 निरीक्षण मैनुअल	आई.एस. 14665 (भाग-5) : 1999
6.	एस्केलेटरो के अधिष्ठापन और अनुरक्षण के लिए व्यवहार संहिता (फरवरी 2001 में चौथा पुर्नमुद्रण)	आई.एस. 4591-1968 (1996 में पुनः पुष्ट)
7.	द्रवचलित लिफ्ट के अधिष्ठापन और अनुरक्षण के लिए व्यवहार संहिता।	आई.एस. 14671-1999
8.	हॉयस्टवे दरवाज-पाशों के लिए विशिष्टियां	आई. एस. 7754-1975
9.	लिफ्टों, एस्केलेटरो और सचल भागों की डिजाइन, अधिष्ठापन, परीक्षण और प्रचालन के नियम	आई.एस. 1735-1975

APPENDIX IX

LIST OF INDIAN STANDARDS CONNECTED WITH LIFT & ESCALATOR INSTALLATIONS

1.	Electric Traction Lifts Part -1 Guidelines for outline Dimensions of passenger , goods, service and hospital lifts	IS 14665 (Part-1):2000
2.	Electric Traction Lifts Part-2 Code of Practice for installation operation and maintenance Section-1 Passenger and Goods Lifts Section-2 Service Lift	IS 14665 (Part-2/Sec 1&2):2000
3.	Electric Traction Lifts Part -3 Safety Rules Section -1 Passenger & Goods Lifts Section-2 Service Lifts	IS 14665 (Part-3/Sec 1&2):2000
4.	Electric Traction Lifts Part-4 Components	IS 14665 (Part-4 /Sec 1to9):2001
5.	Electric Traction Lifts Part-5 Inspection Manual	IS 14665 (Part-5):1999
6.	Code of Practice for Installation and maintenance of Escalators (Fourth Reprint February 2001)	IS 4591-1968 (Reaffirmed 1996)
7.	Code of Practice for Installation and maintenance of Hydraulic Lift	IS 14671-1999
8.	Specifications for hoistway door-locks	IS 7754 -1975
9.	Rules for the design, installation testing and operation of lifts, escalators and moving parts	IS 1735 -1975

परिशिष्ट - X

नमूना एन आई टी

(टिप्पणी: कार्य की आकस्मिकता के आधार पर एन आई टी अनुमोदन प्राधिकारी नमूना एन आई. टी. में परिवर्तन कर सकता है)

APPENDIX -X

Specimen NIT

(Note: The NIT approving authority may make changes in the specimen NIT depending upon the contingency of work).

एन आई टी
(भाग -I)

तकनीकी सह - वाणिज्यिक बोली

**NIT
(Part-I)**

Technical Cum Commercial Bid

अनुक्रमणिका

क्र.सं०	मद	पृष्ठ सं०	अभ्युक्तियां
1.	एन.आई. टी. सी.पी. डब्ल्यू० डी०-6		एन.आई.टी. अनुमोदन प्राधिकारी द्वारा संलग्न किया जाए।
2.	प्रेस अधिसूचना		
3.	सी.पी.डब्ल्यू. डी 7/8 अनुसूची, अद्यतन संशोधन परिचियों के साथ		एन.आई.टी. अनुमोदन प्राधिकारी द्वारा संलग्न किया जाए।
4.	वाणिज्यिक और अतिरिक्त शर्तें		
5.	लिफ्टों के लिए अतिरिक्त विशिष्टियां		
6.	तकनीकी विवरण		
7.	कार्य अनुसूची		

INDEX

S.No.	Item	Page No.	Remarks
1.	NIT CPWD 6		To be attached by NIT approving authority
2.	Press Notification		
3.	CPWD7/8 Schedule alongwith upto date correction slips		To be attached by NIT approving authority
4.	Commercial and Additional Conditions		
5.	Additional Specifications for Lifts		
6.	Technical Particulars		
7.	Schedule of work		

प्रेस अधिसूचना केन्द्रीय लोक निर्माण विभाग

- भारत के राष्ट्रपति की ओर से कार्यापाल इंजीनियर (विद्युत) अधोलिखित कार्य की पूर्व - अर्हता के लिए निम्नलिखित से आवेदन पत्र आमंत्रित करता है।
- (i) सी.पी.डब्ल्यू. डी. में पंजीकृत विद्युत संविदाकार
 - (ii) ऐसे संविदाकार जो संगत - लिफ्ट वर्ग के लिए सी. पी. डब्ल्यू. डी. की अनुमोदित सूची में शामिल हैं।
 - (iii) ऐसे फर्म जो लिफ्ट कार्यों के लिए विशेषज्ञ हैं।
2. कार्य में की पूर्ति, अधिष्ठापन परीक्षण और प्रवर्तन शामिल है।
3. कार्य का विवरण :
कार्य का नाम
.....
.....
अनुमानित लागत
बयाना
निविदा की लागत
4. ऐसी फर्मों को, जो संगत.....लिफ्ट वर्ग के लिए सी.पी.डब्ल्यू.डी. की अनुमोदित सूची में शामिल नहीं है, निम्नलिखित पूर्व - अर्हता मापदंड पूरे करने होंगे
“आशयित निविदाकार ने केन्द्रीय सरकार/राज्य सरकार/केन्द्रीय सरकार के सार्वजनिक क्षेत्र के उपक्रम/केन्द्रीय सरकार के स्वायत्त निकायों में.....के पश्चात् विगत पाँच वर्षों में अपने नाम पर कम से कम ऐसी 2(दो).....लिफ्टों के कार्य, जिनमें प्रत्येक की लागत.....रूपये से कम न हो, संतोषजनक ढंग से पूरा कर लिया है।
5. आवेदन पत्र के साथ ग्राहक विभाग के अधिकारी, जो कि कार्यापालक इंजीनियर या इसके समकक्ष से कम रैंक का न हो द्वारा जारी किया गया समापन प्रमाणपत्र प्रस्तुत किया जाएगा।
समापन प्रमाणपत्र में निम्नलिखित स्पष्टतः दर्शाए जाने चाहिए:
(क) कार्य समापन की तारीख
(ख) कार्य की प्रकृति
(ग) और यह भी कि कार्य को संतोषजनक ढंग से पूरा किया गया है।
6. फर्मों को यह सलाह दी जाती है कि वे अपने आवेदन पत्र के साथ वैध आई टी सी सी और डब्ल्यू सी टी सी सी/बिक्री कर विभाग में कार्य संविदा पर पंजीकरण तथा एक सगान दर से कर वसूली के लिए वचनबंध की एक प्रति के साथ सभी संगत दस्तावेजों की प्रमाणित प्रतियां संलग्न करें।
7. अनुलग्नकों सहित आवेदन पर सीलबंद लिफाफे में जमा किया जाएगा तथा लिफाफे के ऊपर “..... पर नियत, कार्य.....(कार्यापालक इंजीनियर के कार्य का नाम भरना है) के लिए पूर्व अर्हता आवेदन- पत्र”- लिखा जाएगा।
8. कार्य की निविदा प्रस्तुत करने के लिए इच्छुक फर्म तारीख.....को अपराह्न 3.00 बजे तक अपने आवेदन पत्र जमा कर सकती हैं। उसे उसी दिन फर्मों के उन प्रतिनिधियों की उपस्थिति में जो कि उपस्थित रहना चाहें, अपराह्न 3.30 बजे खोला जाएगा।
9. किसी आवेदन को बिना कोई कारण बताए अस्वीकार या स्वीकार करने का अधिकार विभाग के पास सुरक्षित है।
10. निविदा कागजों की बिक्री और उसके खुलने की तारीख की सूचना केवल उन्हीं फर्मों को दी जाएगी जिनके आवेदन पत्र सक्षम प्राधिकारी द्वारा अपेक्षानुसार, अनुमोदित हैं।

PRESS NOTIFICATION

CENTRAL PUBLIC WORKS DEPARTMENT

Executive Engineer(E) _____, on behalf of President of India invites applications for Pre-qualification of under mentioned work from the following:

- (i) CPWD Registered Electrical Contractors,
- (ii) Contractors who are in CPWD approved list in appropriate class for Lifts _____.
- (iii) The firms which are specialised in Lifts works.

2. The work involves supply, installation, testing and commissioning of _____

3. Particulars of the work:

Name of work _____

Estimated cost _____

Earnest money _____

Cost of tender _____

4. The firms who are not approved in CPWD in appropriate class for Lifts _____ works will have to fulfill the following pre-qualification criteria:

"The intending tenderer should have completed satisfactorily at least 2 (two) similar Lift _____ works, in their own name each costing not less than Rs. _____ each in the last 5 years after _____ in Central Govt/ State Govt/ Central Govt. Public Sector Undertaking/ Central Govt. Autonomous Bodies".

5. Completion certificates issued by the Officer of the Client Department of the rank of Executive Engineer or equivalent will have to be furnished along with the application. The Completion certificate must clearly indicate:

- (a) The date of completion of work
- (b) Nature of work,
- (c) That the work has been completed satisfactorily.

6. The firms are advised to enclose attested copies of all relevant documents along with valid ITCC and WCTCC/ Works contract tax registration with sales tax department and a copy of undertaking for recovery of tax at flat rate with their application failing which their applications are liable to be rejected.

7. **The application along with the enclosures shall be submitted in a sealed envelope which shall be superscribed "P.Q.application for the work _____ (EE to fill up the name of the work) "due on _____.**

8. The firms who wish to tender for the work, may submit their application by 3.00 PM on _____. The same shall be opened at 3.30 PM on the same day in the presence of representatives of the firms who would like to be present.

9. The department reserves the right to reject or accept any application without assigning any reason.

10. The date of sale and opening of tender papers will be intimated to those firms only whose applications are approved by the competent authority in due course.

वाणिज्यिक और अतिरिक्त शर्तें

1.0 सामान्य

- 1.1 इस विशिष्टि में विनिर्माण, प्रेषण से पूर्व यथावश्यक परीक्षण, स्थल पर सुपुर्दगी, तैयारी संबंधी सभी कार्य, संयोजन और अधिष्ठापन, प्रवर्तन लिफ्टों एस्केलटरो को प्रचालन में डालना शामिल है।
- 1.2 अवस्थिति
लिफ्टें/ एस्केलटर.....पर अधिष्ठापित किए जाएंगे (एन. आई. टी. अनुमोदन प्राधिकारी द्वारा भरा जाएगा)
- 1.3 कार्य - वैद्युत कार्यों के लिए सी. पी. डब्ल्यू. डी. के सामान्य विनिर्देश (भाग III लिफ्ट -2003) के अनुसार तथा प्रभारी इंजीनियर के निर्देशों के अनुसार निष्पादित किया जाएगा। इन अतिरिक्त विनिर्देशों को उपर्युक्त के साथ मिलाकर पढ़ा जाए परिवर्तनों के मामले में उन अतिरिक्त शर्तों में दी गयी विशिष्टियां लागू होंगी। परन्तु, चूंकि ये कार्य के लिए मात्रा अनुसूची के साथ पढ़े जाने हैं इसलिये इन अतिरिक्त विनिर्देशों और शर्तों के लिये कुछ भी अतिरिक्त भुगतान नहीं किया जाएगा।
- 1.4 निविदाकार निविदा प्रस्तुत करने से पूर्व अपने हित में स्थल पर जाएगा तथा स्वयं स्थल की दशाओं/संबंधी जानकारी प्राप्त करेगा।
- 1.5 विभाग द्वारा कोई टी एण्ड पी जारी नहीं किया जाएगा तथा उसके लिए कोई अन्य भुगतान भी नहीं किया जाएगा।

2.0 वाणिज्यिक शर्तें

2.1 संविदा का प्रकार

इस निविदा द्वारा सौंपा जाने वाला कार्य एकल कार्य संविदा समझा जाएगा।

2.2 निविदाएं जमा करना तथा उसका खुलना

2.2.1 निविदा दो भागों में है:

- (क) भाग - I - तकनीकी - सह.वाणिज्यिक बोली
(ख) भाग - II - कीमत बोली

2.2.2 तकनीकी-सह-वाणिज्यिक भाग के निविदा दस्तावेज केवल सक्षम प्राधिकारी द्वारा पूर्व-अर्हताप्राप्त आवेदकों को ही जारी किए जाएंगे। बिक्री प्राप्ति तथा सीलबन्द तकनीकी-सह-वाणिज्यिक बोलियों के खुलने की तारीख की सूचना अग्रिम रूप में ऐसे सभी निविदाकारों को दी जाएगी। तकनीकी -सह-वाणिज्यिक भाग निम्नलिखित के साथ पूर्ण रूप में निविदाकारों द्वारा जमा किया जाएगा :

- (i) सभी निबंधन और शर्तों की स्वीकृति के लिए विधिवत हस्ताक्षरित पूर्ण निविदा दस्तावेज (भाग-I), सी.पी.डब्ल्यू. डी. द्वारा खरीदे अनुसार, इसमें कार्य अनुसूची (कीमत को बिना दर्शाए) भी शामिल है।
(ii) एक सेवा वचनबंध कि संविदाकार अपनी कीमत बोली के साथ रूपये की बयाना राशि, विभाग द्वारा जब कभी भी मांग की जाए, जमा करेगा।
(iii) परिशिष्ट 'क' के अनुसार सभी उपस्करों और सामग्रियों का पूर्ण तकनीकी विवरण

2.2.3 निविदाकारों को यह सलाह दी जाती है कि वे तकनीकी विशिष्टियों/मदों, एन आई टी की वाणिज्यिक निबन्धन और शर्तों यथा भुगतान की शर्तें, गारंटी, माध्यस्थ खंड, शुद्धि आदि, से विचलित न हों।

Commercial and Additional Conditions

1.0 General

1.1 This specification covers manufacture, testing as may be necessary before despatch, delivery at site, all preparatory work, assembly and installation, commissioning putting into operation of Lifts & Escalators.

1.2 Location

The Lifts / Escalators will be installed at _____ (To be filled by NIT approving authority)

1.3 The work shall be executed as per CPWD General Specifications for Electrical Works (Part III Lifts & Escalators-2003) as per relevant IS and as per directions of Engineer-in-Charge. These additional specifications are to be read in conjunction with above and in case of variations, specifications given in this Additional conditions shall apply. However, nothing extra shall be paid on account of these additional specifications & conditions as the same are to be read along with schedule of quantities for the work.

1.4 The tenderer should in his own interest visit the site and familiarise himself with the site conditions before tendering.

1.5 No T&P shall be issued by the Department and nothing extra shall be paid on account of this.

2.0 Commercial Conditions

2.1 Type of contract

The work to be awarded by this tender shall be treated as indivisible works contract.

2.2 Submission and opening of Tenders:

2.2.1 The tender is in two parts :

- (a) Part I – Technical cum commercial Bid
- (b) Part II – Price Bid

2.2.2 Tender documents for Technical-cum-commercial part will be issued to only those applicants who are pre-qualified by the competent authority. The date of sale, receipt and opening of the sealed technical-cum-commercial bids will be notified to all such tenderers in advance. The technical-cum-commercial part will have to be submitted by the tenderers complete with the following:

- (i) Complete tender documents (part-I), as purchased from CPWD including the schedule of work (without indicating the price) duly signed for acceptance of all terms and conditions.
- (ii) An undertaking that the contractor will deposit earnest money amounting to Rs. _____ along with their price-bid as and when desired by the department.
- (iii) Complete technical particulars of all equipment & materials as per list attached.

2.2.3 The tenderers are advised not to deviate from the technical specifications/ items, commercial terms and conditions of NIT like terms of payment, guarantee, arbitration clause, escalation etc.

- 2.2.4 फार्म सी.पी. डब्ल्यू. डी-6 में यथा विनिर्दिष्ट नियत तारीख और समय पर निविदाकारों या उनके उन प्राधिकृत प्रतिनिधियों की उपस्थिति में, जो उपस्थित रहना चाहें केवल तकनीकी-सह-वाणिज्यिक बोली ही खोली जाएगी।
- 2.2.5 तकनीकी-सह-वाणिज्यिक बोली की सवीक्षा/मूल्यांकन विभाग द्वारा आवश्यकतानुसार किसी एजेंसी से परामर्श करके किया जाएगा। यदि ऐसा पाया जाता है कि निविदाकार की तकनीकी-सह-वाणिज्यिक बोली एन आई टी की विशिष्टियों के अनुरूप नहीं है और/या इसमें अनेक विचलन मौजूद हैं तो विभाग के पास इस प्रकार के फर्म (फर्मों) की तकनीकी बोली को बिना निवदा कार (निविदाकारों) को सूचित किये अस्वीकार करने का अधिकार सुरक्षित है।
- 2.2.6 विभाग द्वारा मांगे गए आवश्यक स्पष्टीकरण विभाग द्वारा इसके लिये निर्धारित समय भीतर निविदाकार द्वारा प्रस्तुत किए जाएंगे। निविदाकार विभाग के अधिकारी (अधिकारियों) के साथ चर्चा के लिए जब कभी भी वांछित हो अपना प्रतिनिधि प्रतिनियुक्त करेगा। विभाग के विचार में यदि निविदाकार अपेक्षित स्पष्टीकरण प्रस्तुत करने के लिए अनापेक्षित (अधिक) समय ले रहा हो तो वह बिना कोई सूचना के बोली को अस्वीकार कर सकता है।
- 2.2.7 सभी निविदाकारों से स्पष्टीकरण प्राप्त करने के पश्चात्, अपेक्षित होने पर विभाग तकनीकी ओर वाणिज्यिक शर्तों/विशिष्टियों को संशोधित कर सकता है और निविदाकारों को यह सूचित करेगा कि किसकी तकनीकी-सह-वाणिज्यिक बोलियाँ स्वीकार्य हैं। निविदा का भाग-II केवल उन्हीं फर्मों को जारी किया जाएगा। कीमत बोली खुलने की तारीख और समय पहले ही सूचित किया जाएगा।
- 2.2.8 निविदा का भाग-II अर्थात् कीमत बोली निविदाकारों के उन प्रतिनिधियों जिन्हें वे प्रस्तुत करना चाहें, कि उपस्थिति में कार्यपालक इंजीनियर (विद्युत) द्वारा खोला जाएगा।
- 2.2.9 निविदाकार को निम्नानुसार दो पृथक सीलबंद लिफाफों वाले सीलबंद लिफाफे में निविदा बोली जमा करना होगा:
- पहला लिफाफा: निर्धारित तरीके से.....रु० की बयाना राशि सीलबंद लिफाफे के ऊपर कार्य का नाम तथा शब्दों में "ई. एम. डी. राशि" लिखी जानी चाहिए। ई. एम. डी. (भारतीय रिजर्व बैंक (आर.बी.आई.) द्वारा गारंटी प्राप्त अनुसूचित/राष्ट्रीयकृत बैंक के डिमांड ड्राफ्ट-या पे ऑर्डर के रूप में तथा कार्यपालक इंजीनियर (विद्युत) के पक्ष में आहरण योग्य होना चाहिए।
 - दूसरा लिफाफा : कीमत बोली (निविदा का भाग-II) सीलबंद लिफाफे पर कार्य का नाम तथा शब्दों में "कीमत बोली" लिखा जाना चाहिए। इसमें विभाग द्वारा जारी की गयी विधिवत भरी गयी और हस्ताक्षरित कीमत बोली (निविदा का भाग-II) होगा
- 2.2.10 निविदाकारों को अपनी दरें केवल विभाग द्वारा जारी किए गए कीमत बोली (निविदा का भाग-II) में ही भरनी होंगी। ऐसी निविदाएं जिसमें बोलियां किसी और प्रारूप में दी गयी हैं अस्वीकार की जा सकती हैं। लागत सार को भी भरना आवश्यक होगा।
- 2.2.11 निविदा खोलने वाला अधिकारी बयाना राशि वाले लिफाफे को पहले खोलेगा। बयाना राशि सही रूप में पाए जाने पर ही अधिकारी कीमत बोली वाले दूसरे लिफाफे को खोलने के लिए आगे बढ़ेगा। बयाना राशि सही रूप में न पाए जाने पर कीमत और बोली पर विचार नहीं किया जाएगा।
- 2.2.12 कीमत बोली में, चाहे जो भी हो, कोई शर्त नहीं होनी चाहिए। किसी निविदा में किसी शर्त का उल्लेख होने पर, इसमें उनके कीमत भाग में सशर्त छूट भी शामिल है, निविदा को तुरन्त अस्वीकार कर दिया जाएगा।
तकनीकी बोली स्वीकार कर लिए जाने तथा विभाग द्वारा कीमत बोली खोलने का निर्णय कर लिए जाने के बाद, निविदाकार को किसी शर्त को वापस लेने या संशोधित करने की अनुमति नहीं होगी।

- 2.2.4 The technical cum commercial bid only, shall be opened first on the due date and time, as specified in form CPWD-6 in the presence of tenderers or their authorised representatives who wish to remain present.
- 2.2.5 Scrutiny/ evaluation of the Technical-cum-commercial bid shall be done by the department in consultation with any agency as deemed necessary. In case it is found that the technical-cum-commercial bid of a tenderer is not in line with NIT specifications, requirements and/or contains many deviations, the department reserves the right to reject the technical bid of such firms (s) without making any reference to the tenderer (s).
- 2.2.6 Necessary clarifications required by the department shall have to be furnished by the tenderer within the time given by the department for the same. The tenderer will have to depute his representative to discuss with the officer(s) of the department as and when so desired. In case, in the opinion of the department a tenderer is taking undue long time in furnishing the desired clarifications, his bid will be rejected without making any reference.
- 2.2.7 After obtaining clarifications from all the tenderers, the department may modify the technical & commercial conditions/ specifications if required, and will intimate the tenderers whose technical cum commercial bids are acceptable. The part-II of the tender i.e. price bid will be issued to only these firms. The date and time of opening of price-bid will be intimated in advance.
- 2.2.8 The part II of the tender i.e. price bid will be opened by the Executive Engineer (E) in the presence of the representatives of the tenderers who wish to be present.
- 2.2.9 The contractor shall be required to submit the price bid in a sealed envelope containing two separate sealed envelopes as under:
- (i) First envelope : Earnest money amounting to Rs. _____ in prescribed manner. The name of work and the words "EMD amount" should be written on top of this sealed cover. EMD should be in shape of DD or pay order of a scheduled/ nationalised bank guaranteed by RBI and drawn in favour of Executive Engineer (E), _____
 - (ii) Second envelope: Price Bid (Part II of tender) . The name of work and the words "Price Bid" should be written on top of the sealed cover. It shall contain:-
"Price bid (Part II of tender) as issued by the department duly filled & signed."
- 2.2.10 The tenderers will have to fill up their rates only in the price bid (part II of tender) issued by the department. Tenders in which the price bids are given in any other format are liable to be rejected. The abstract of cost will be required to be filled in.
- 2.2.11 The officer opening the tender shall first open the envelope containing earnest money. If the earnest money is found to be in order, only then the officer shall proceed further with the opening of second envelope containing price bid. In case the Earnest money deposited is not in order, the price bid shall not be considered.
- 2.2.12 In the price bid, there shall be no conditions whatsoever. In case any tenderer mentions any condition including conditional rebates in their price part, tender shall be rejected forthwith.
A tenderer will also not be allowed to withdraw or modify any condition at a time after the technical bids have been accepted and the decision to open the price bid has been taken by the department.

2.2.13 विभाग के पास बिना कोई कारण बताए किसी या सभी बोलियों को अस्वीकार करने तथा नई कीमतें/निविदाएं, जैसा भी मामला हो, मंगाने का अधिकार सुरक्षित है।

3.0 भुगतान की शर्तें

निविदा में शामिल विभिन्न मदों के लिए निम्नलिखित संविदा प्रतिशत दरें उसमें दर्शाए कार्य चरण पर देय होगी।

3.1 प्रारम्भिक निरीक्षण तथा यथानुपात आधार की अच्छी दशा में स्थल पर सुपुर्दगी के पश्चात् 80 %

3.2 अधिष्ठापन सभी प्रकार से पूर्ण होने के पश्चात् 10%

3.3 परीक्षण प्रवर्तन, परीक्षण चालन तथा लाभकारी उपयोग के लिये विभाग को सौंपने के पश्चात् शेष 10%।

3.4 प्रतिभूति जमा : प्रत्येक चालू तथा अंतिम बिल से कुल देय राशि का 10% प्रतिभूति जमा के रूप में काट लिया जाएगा। प्रतिभूति की अधिकतम राशि 5 लाख रुपये होगी। जमा की गयी बयाना राशि को इस प्रतिभूति जमा के सामने समायोजित किया जाएगा। प्रतिभूति जमा राशि संविधा में निर्धारित गारंटी अवधि की समाप्ति पर जारी की जाएगी। परन्तु संविदाकार द्वारा निर्धारित प्रारूप में अनुसूचित बैंक से कुल प्रतिभूति जमा मूल्य की गारंटी प्रस्तुत किये जाने पर प्रतिभूति जमा के रूप में बिलों से कोई कटौती नहीं की जाएगी। बैंक गारंटी को गारंटी, अवधि की समाप्ति तक वैध रखा जाएगा।

4. दरें

4.1 निविदाकार द्वारा उद्धृत दरें निश्चित होंगी तथा इसमें सभी कर कार्य संविदा करों सहित, शुल्क, उगाही (लेवी) तथा पैकिंग, अग्रसरण, बीमा, भाड़ा और सुपुर्दगी अधिष्ठापन, परीक्षण, प्रवर्तन आदि स्थल पर अस्थाई निर्माण संबंधी भंडारण, जोखिम, अधिप्रभार, सामान्य दायित्व/उत्तरदायित्व तथा स्थानीय प्राधिकारियों प्राधिकरणों से निपटान के सभी प्रभार शामिल हैं। परन्तु इन निरीक्षण का शुल्क विभाग द्वारा वहन किया जाएगा।

4.2 निविदाकार को सौंपने की तारीख के बाद 12 माह तक निवारक अनुरक्षण करना होगा। इसके लिए कोई अतिरिक्त भुगतान नहीं किया जाएगा।

4.3 चुंगी शुल्क का पृथक भुगतान नहीं किया जाएगा परन्तु मांग किए जाने पर विभाग द्वारा चुंगी छूट प्रमाण-पत्र प्रदान किया जा सकता है। परन्तु यदि संबंधित प्राधिकारियों द्वारा छूट प्रमाणपत्र जारी नहीं किया गया है तो विभाग चुंगी शुल्क की प्रतिपूर्ति के लिए दायी नहीं होगा।

5.0 निविदा की पूर्णता

सभी विविध उपस्कर, फिटिंग्स यूनिट ऐसेम्बली, उप-साधन, हार्डवेयर मदें, आधार बोल्ट, विद्युत संयोजनों के लिए टर्मिनल लुग्स, उपस्कर तथा कार्य घटकों के कुशल संयोजन और अधिष्ठापन के लिए आवश्यक तथा उपयोगी सभी अन्य मदें निविदा में शामिल समझी जाएंगी भले ही निविदा दस्तावेजों में विशेष रूप से उनका उल्लेख किया गया हो या नहीं।

6.0 ऐसी मद/उपस्कर के लिए जिसके लिए विनिर्माता के कार्यस्थल पर प्रारंभिक निरीक्षण किया जाना आवश्यक हो, संविदाकार प्रेषण से पूर्व विनिर्माता के कार्य स्थलपर उपस्करों के परीक्षण की तारीख की सूचना देगा। विभाग के पास यह अधिकार सुरक्षित है कि वह कारखाने में संविदाकार अर्थात् फेब्रीकेशन कार्य का निरीक्षण कर सके तथा सफल निविदाकार को इसकी व्यवस्था करनी होगी। सफल निविदाकार ऐसे परीक्षणों/निरीक्षणों के लिए प्रस्तावित तारीखों के संबंध में अग्रिम रूप में विभाग के

2.2.13 The department reserves the right to reject any or all the price bids and call for fresh prices/ tenders as the case may be without assigning any reason.

3.0 Terms of Payment :

The following percentage of contract rates for the various items included in the contract shall be payable against the stage of work shown herein.

3.1 80% after initial inspection and delivery at site in good condition of pro-rata basis.

3.2 10% after completion of installation in all respect.

3.3 Balance 10% will be paid after testing, commissioning trial run & handing over to the department for beneficial use.

3.4 Security Deposit : Security Deposit shall be deducted from each running bill and the final bill to the extent of 10% of the gross amount payable subject to maximum limit of 5% of the tendered value of work. The earnest money deposit shall be adjusted against this security deposit. The security deposit shall be released on the expiry of guarantee period stipulated in the contract.

4. Rates:

4.1 The rates quoted by the tenderer, shall be firm and inclusive of all taxes (including works contract taxes), duties and levies and all charges for packing forwarding, insurance, freight and delivery, installation, testing, commissioning etc. at site i/c temporary constructional storage, risks , over head charges general liabilities/ obligations and clearance from local authorities. However, the fee for these inspections shall be borne by the department.

4.2 The contractor has to carry out routine & preventive maintenance for 12 months from the date of handing over. Nothing extra shall be paid.

4.3 Octroi duty shall not be paid separately but octroi exemption certificate can be furnished by the department on demand. However, the department is not liable to re-imburse the octroi duty in case exemption certificates are not honoured by the concerned authorities.

5.0 Completeness of tender :

All sundry equipment, fittings, unit assemblies, accessories, hardware items, foundation bolts, termination lugs for electrical connections, and all other items which are useful and necessary for efficient assembly and installation of equipment and components of the work shall be deemed to have been included in the tender irrespectively of the fact whether such items are specifically mentioned in the tender documents or not.

6.0 For item/ equipment requiring initial inspection at manufacturer's works' the contractor will intimate the date of testing of equipments at the manufacturer's works before despatch. The department also reserves the right to inspect the fabrication job at factory and the successful tenderer has to make the arrangement for the same. The successful tenderer shall give sufficient advance notice regarding the dates proposed for such tests/ inspection to the department's representative(s) to facilities his presence during testing/ fabrication. The Engineer-in-charge at his discretion may

प्रतिनिधि (प्रतिनिधियों) को सूचित करेगा ताकि वे आसानी से परीक्षण/संविचन के दौरान उपस्थित हो सकें प्रभारी इंजीनियर स्वेच्छा से ऐसे परीक्षण संविचन को देख सकता है इंजीनियर के दौरे की लागत विभाग द्वारा वहन की जाएगी। स्थल पर प्रेषण से पूर्व विनिर्माता के परिसर में संविदाकार द्वारा भी उपस्कर का निरीक्षण किया जा सकता है।

7.0 सामग्रियों का भंडारण और अभिरक्षा

विविध सामग्रियों तथा उत्पादन उपस्करों के भंडारण के लिए यदि उपलब्ध हो तो लिफ्ट मशीन कक्ष का उपयोग किया जा सकता है अन्यथा एजेंसी को स्वयं इसकी व्यवस्था करनी होगी। भंडारण के लिए विभाग द्वारा कोई पृथक स्थान उपलब्ध नहीं कराया जाएगा। भंडारों की निगरानी और देख भाल तथा उनकी सुरक्षित अभिरक्षा का उत्तरदायित्व विभाग द्वारा अधिष्ठापन को अंतिम रूप में हाथ में लेने तक संविदाकार का होगा।

8.0 भवन की देख-रेख

विभिन्न उपस्करों तथा कार्य घटकों की संभलाई तथा अधिष्ठापन के समय संविदाकार द्वारा यह सावधानी बरती जानी चाहिए कि भवन को कोई क्षति न हो। वह अपनी लागत पर सभी क्षतियों की मरम्मत करने तथा उसे मूल परिष्कृत रूप में वापस लाने के लिए उत्तरदायी होगा। वह अधिष्ठापन के कारण उत्पन्न होने वाली अवांछित तथा अवशिष्ट सामग्रियों को कार्य स्थल से अपनी लागत पर हटाएगा

9.0 समापन अवधि

निविदा दस्तावेजों में दर्शायी गयी..... माह की समापन अवधि आयोजना, डिजाइन तैयार करने, पूर्ति, अधिष्ठापन, परीक्षण, प्रवर्तन तथा प्रभारी इंजीनियर की संतुष्टि तक पूरी प्रणाली को सौंपने संबंधी पूरे कार्य के लिए है।

10.0 निष्पादन गारंटी:

10.1 निविदा अन्य बातों के साथ-साथ निम्नलिखित की गारंटी देगी :-

(क) प्रयुक्त सामग्रियों की गुणवत्ता, सामर्थ्य और निष्पादन।

(ख) प्रचालन की सभी विनिर्दिष्ट दशाओं के अधीन सभी भागों पर सुरक्षित यांत्रिक और वैद्युत प्रतिबल।

(ग) अनुरक्षण अवधि के दौरान संतोषजनक प्रचालन।

10.2 सफल विनिदाकार को, ठेका अनुबंध के ठीक निष्पादन के लिए ठेके में अन्यत्र उल्लिखित अन्य डिपोजिट्स से अलग, निविदा राशि के 5 प्रतिशत की एक अपरिवर्तनीय निष्पादन (परफार्मेंस) गारंटी, इस उद्देश्य के पत्र जारी होने से 15 दिन के भीतर प्रस्तुत करनी होगी। यह गारंटी, भारत सरकार के प्रतिभूति प्रपत्र पर या आवधिक जमा प्राप्तियाँ या भारतीय स्टेट बैंक अथवा किसी अनुसूचित बैंक के गारंटी बांड्स के निर्धारित प्रपत्र में देनी होगी। प्रारंभिक रूप से यह निष्पादन गारंटी कार्य-सम्पन्नता के लिए नियत अवधि के 60 दिन बाद तक के लिए मान्य होगी। तत्पश्चात् सक्षम प्राधिकारी द्वारा कार्य-सम्पन्नता प्रमाण पत्र दिए जाने तक इस बैंक-गारंटी को मान्य रखा जाए।

11.0 गारंटी

11.1 सभी उपस्कर विभाग द्वारा अधिष्ठापन को हाथ में लेने की तारीख के बाद 12 महीने की अवधि के लिए असंतोषजनक निष्पादन और/या दोषपूर्ण डिजाइन, कर्म कौशल, सामग्री के कारण भंग (ब्रेक डाउन) के विरुद्ध गारंटी होंगे। गारंटी अवधि के दौरान दोषपूर्ण पाए गए उपस्कर या घटक या इसका कोई भाग बिना किसी लागत के प्रभारी इंजीनियर की संतुष्टि तक तुरंत बदला जाएगा या उसकी मरम्मत की जाएगी। विभाग द्वारा यदि ऐसा समझा जाता है कि इसे करने में संविदाकार द्वारा अनापेक्षित विलम्ब किया जा रहा है तो विभाग द्वारा इसे संविदाकार के जोखिम और लागत पर करवाया जा सकता है। इस संबंध में प्रभारी इंजीनियर का निर्णय अंतिम होगा।

witness such testing/ fabrication. The cost of the Engineer's visit to the factory will be borne by the Department. Also equipment may be inspected at the Manufacturer's premises, before despatch to the site by the contractor.

7.0 Storage and custody of materials:

The Lift machine room may be used for storage of sundry materials and erection equipments if available or else the agency has to make his own arrangement. No separate storage accommodation shall be provided by the department. Watch and ward of the stores and their safe custody shall be the responsibility of the contractor till the final taking over of the installation by the department.

8.0 Care of the Building:

Care shall be taken by the contractor while handling and installing the various equipments and components of the work to avoid damage to the building. He shall be responsible for repairing all damages and restoring the same to their original finish at his cost. He shall also remove at his cost all unwanted and waste materials arising out of the installation from the site of work.

9.0 Completion of period

The completion period of _____ months indicated in the tender documents is for the entire work of planning, designing, supplying, installation, testing, commissioning and handing over of the entire system to the satisfaction of the Engineer-in-charge.

10.0 Performance Guarantee:

10.1 The tender shall guarantee among other things, the following

- (a) Quality, strength and performance of the materials used.
- (b) Safe mechanical and electrical stress on all parts under all specified conditions of operation.
- (c) Satisfactory operation during the maintenance period.

10.2 The successful tenderer shall submit an irrevocable performance guarantee of 5% of the tendered amount in addition to other deposits mentioned elsewhere in the contract for his proper performance of the contract agreement within 15 days of issue of letter of intent. This guarantee shall be in the form of government securities or fixed deposit receipts or guarantee bonds of any scheduled bank or the State Bank of India in the specified format. The performance guarantee shall be initially valid up to the stipulated date of completion plus 60 days beyond. This bank guarantee kept valid till the recording of completion certificate for the work by the competent authority.

11.0 Guarantee

11.1 All equipments shall be guaranteed for a period of 12 months from the date of taking over the installation by the department against unsatisfactory performance and/or break down due to defective design, workmanship of material. The equipments or components, or any part thereof, so found defective during guarantee period shall be forthwith repaired or replaced free of cost, to the satisfaction of the Engineer-in-Charge. In case it is felt by the department that undue delay is being caused by the contractor in doing this, the same will be got done by the department at the risk and cost of the contractor. The decision of the Engineer-in-Charge in this regard shall be final.

12. **विद्युत पूर्ति:**
अधिष्ठापन उद्देश्य के लिए विभाग द्वारा बिना किसी प्रकार के 415 वोल्ट, 3 कला, 4 तार, 50 हर्ट्ज की ए. सी. पूर्ति के बिजली के कनेक्शन दिए जाएंगे।
13. **जल पूर्ति**
विभाग द्वारा एक बिन्दु पर जल पूर्ति उपलब्ध करायी जाएगी।
14. **डाटा मैनुअल और आरेख निविदाकारों द्वारा प्रस्तुत किए जाएंगे**
- 14.1 **निविदा के साथ :** निविदाकार निविदा के साथ विस्तृत तकनीकी साहित्य, प्रस्ताव के मूल्यांकन और मूल्यनिरूपण के लिए पम्पलैट और निष्पादन डाटा प्रस्तुत करेगा।
- 14.2 **कार्य अधिनिर्णय के पश्चात्**
सफल निविदाकार को अधिष्ठापन प्रारम्भ करने से पूर्व कार्य अधिनिर्णय के एक माह के भीतर निम्नलिखित आरेख प्रस्तुत करना होगा -
- (क) सभी सामान्य विन्यास आरेखन
(ख) सामान्यतः यथावश्यक ऐसे उपस्कर के लिए आधार, भार आँकड़े, अवस्थिति आदि के विवरण जो उनके कार्य के लिए अन्य एजेंसियों को आवश्यक हों। आँकड़ों में गाइडों पर भार का विभाजन, लिफ्ट गतों पर बफर की प्रतिक्रिया, मशीन कक्ष, लिफ्ट कूप में टेक बिन्दुओं पर प्रतिक्रिया आदि शामिल होंगे।
(ग) उत्पादन उद्देश्यों के लिए आपेक्षित विभाओं के साथ प्रत्येक इकाई/इकाइयों के ग्रुप के लिए पूर्ण विन्यास विभाएँ
(घ) ऐसी कोई अन्य आरेख (ड्राइंग) सूचना जिसका विशेष रूप से ऊपर उल्लेख नहीं किया गया है परन्तु संविदाकार द्वारा कार्य के लिए आवश्यक समझी जाए।
- 15.0 सफल निविदाकार को पर्याप्त समय पूर्व उपस्कर की सभी मर्दों के लिए अधिष्ठापन, समायोजन, प्रचालन और अनुरक्षण यथा निवारक अनुरक्षण और त्रुटि शोधन संबंधी विनिर्माताओं के विस्तृत अनुदेश और मैनुअलों के साथ-साथ सभी संगत डाटा शीट, अतिरिक्त पुर्जों की सूची तथा मरम्मत, संयोजन और समायोजन आदि के लिए कर्मशाला पद्धति, सभी तीन प्रतियों में प्रस्तुत करना चाहिए।
- 16.0 **बाह्य कार्य**
- 16.1 कार्य में अधिष्ठापन को पूर्ण करने के लिए पर्यवेक्षण और सभी आवश्यक सामग्रियों सहित पूर्ण श्रम और विभाग द्वारा अपेक्षित परीक्षण और समायोजन भी शामिल हैं। पूर्ण अधिष्ठापन शब्द का अर्थ मात्र विशिष्टियों में शामिल संयंत्र और उपस्करों की मुख्य मर्दें ही नहीं हैं अपितु अधिष्ठापन के पूर्ण कार्य निष्पादन तथा संतोषजनक चालन के आवश्यक सभी आनुषंगिक विविध घटक शामिल हैं, इसके साथ ही इसमें सभी विन्यास चार्ट भी शामिल हैं भले ही इस संविदा से संबंधित दस्तावेज में विस्तृत रूप से इनका उल्लेख किया गया है या नहीं।
- 16.2. उपस्कर के अधिष्ठापन, नींव, दीवारों या फर्शों में द्वार बनाने, तथा उनकी मूल अवस्था में वापस लाने के लिए आवश्यक छोटे निर्माण कार्य। यथावश्यक परिष्कर और अभिपूरण (ग्राउटन) आदि।
- 16.3. समापन तथा सौंपने की तारीख से एक वर्ष के लिए अनुरक्षण।
- 16.4. कार्य टर्न-की परियोजना है। परियोजना समापन के लिए आवश्यक कोई मद, जो गलती से छूट गयी है, उल्लिखित दरों के भीतर निष्पादित की जाएगी।

12. Power Supply

Electric service connection of 415 V, 3 phase, 4 wire, 50 Hz, Ac supply shall be provided by the Deptt. for installation purpose free of charge.

13. Water Supply

Water supply shall be made available by the department at one point.

14. Data Manual and Drawings to be furnished by the tenderers:

14.1 With Tender: The tenderer shall furnish alongwith the tender, detailed technical literature, pamphlets and performance data for appraisal and evaluation of the offer.

14.2 After Award of work

(i) The successful tenderer would be required to submit the following drawings within a month of award of work for approval before commencement of installation.

(a) All general arrangement drawings.

(b) Details of foundations for the equipment, load data, location etc. of various assembled equipment as may be needed generally by other agencies for purpose of their work. The data will include breaking load on guides, reaction of buffers on lift pits reaction on support points in machine room, lift well etc.

(c) Complete layout dimensions for every unit/ group of units with dimensions required for erection purposes.

(d) Any other drawing/ information not specifically mentioned above but deemed to be necessary for the job by the contractor.

15.0 The successful tenderer should furnish well in advance three copies of detailed instructions and manuals of manufacturers for all items of equipments regarding installation, adjustments operation and maintenance i/c preventive maintenance & trouble shooting together with all the relevant data sheets, spare parts catalogue and workshop procedure for repairs, assembly and adjustment etc. all in triplicate.

16.0 Extent of work

16.1 The work shall comprise of entire labour including supervision and all materials necessary to make a complete installation and such tests and adjustments and commissioning as may be required by the department. The term complete installation shall not only mean major items of the plant and equipments covered by specifications but all incidental sundry components necessary for complete execution and satisfactory performance of installation with all layout charts whether or not those have been mentioned in details in the tender document in connection with this contract.

16.2 Minor building works necessary for installation of equipment, foundation, making of opening in walls or in floors and restoring to their original condition, finish and necessary grouting etc. as required.

16.3 Maintenance (Routine & preventive) for one year from date of completion and handing over.

16.4 The work is turn key project. Any item required for completion of the project but left in-advertantly shall be executed with- in the quoted rates.

- 17.0. निरीक्षण और परीक्षण
- 17.1. सभी नेमी दस्तावेजों की प्रतियां तथा विनिर्माता परिसर में उपस्कर के किए गए टाइप-टेस्ट के प्रमाणपत्र प्रभारी इंजीनियर और परेषिती को प्रस्तुत किए जाएंगे।
- 17.2. कार्य को सभी प्रकार से पूर्ण करने के पश्चात् संविदाकार अधिष्ठापन को परीक्षण और प्रचालन के लिए प्रस्तुत करेगा।
- 18.0 वैधता
निविदाएं कीमत बोली खुलने की तारीख से 90 दिनों की अवधि के लिए स्वीकृति के लिए वैध होगा।
- 19.0. विनियमों तथा भारतीय मानकों का अनुपालन
- 19.1. सभी कार्य इन विशिष्टियों में शामिल कार्यों से संबंधित कानूनों तथा भारतीय मानकों, दोनों के संगत विनियमों के अनुसार किया जाएगा। विशेषतः उपस्कर और अधिष्ठापन निम्नलिखित का पालन करेंगे:
- कारखाना अधिनियम
 - भारतीय विद्युत नियमावली
 - आई एस और बी एस मानक, यथा लागू
 - कर्मकार प्रतिकार अधिनियम
 - स्थानीय निकायों जैसे सी. ई. ए, एन. डी. एम. सी. आदि द्वारा निश्चित कानूनी मापदण्ड
- 19.2. इस विशिष्टि का कुछ भी यह अर्थ नहीं देगा कि सफल निविदाकार को उपस्कर की डिजाइन, विनिर्माण और अधिष्ठापन, तथा इस समय लागू कानूनी विनियमों तथा सुरक्षा संहिताओं के अनुसार सभी-उपसाधनों के लिए उसके उत्तरदायित्व से छूट प्रदान की जा सके।
- 19.3 सफल निविदाकार स्वयं द्वारा नियोजित श्रमिकों के संबंध में सुरक्षा विनियमों के कानूनी प्रावधानों तथा विभागीय सुरक्षा संहिताओं की आवश्यकताओं के पालन की व्यवस्था करेगा। ऐसी सुरक्षा आवश्यकताएं उपलब्ध कराने में विफल होने पर निविदाकार प्रत्येक चूक के लिए 50 रुपये का अर्थदंड देने के लिए उत्तरदायी होगा; इसके अलावा विभाग को यह स्वतंत्रता होगी कि वह निविदाकार की लागत पर सुरक्षा आवश्यकताओं की व्यवस्था करें तथा निविदाकार से उसकी लागत वसूल करे।
- 20.0 क्षतिपूर्ति
सफल निविदाकार सदैव अपने कार्य संविदा के परिणाम की क्षतिपूर्ति करेगा। सफल निविदाकार भारतीय कानून और विनियमों के अनुसार किसी कारण से होने वाली दुर्घटना के लिए उत्तरदायी होगा और विभाग उत्पादन, निर्माण तथा सफल निविदाकार के पर्यवेक्षण में उपस्करों तथा सहायक उपस्करों के प्रचालन से हुई किसी दुर्घटना या क्षति के लिए या इससे उत्पन्न किसी दावे के लिए उत्तरदायी नहीं होगा उसके लिए निविदाकार ही उत्तरदायी होगा। सफल निविदाकार, जोखिम को शामिल करने के लिए यथावश्यक तृतीय पक्ष बीमा सहित, सभी प्रकार का बीमा कराएगा। सफल निविदाकार को उपर्युक्त के कारण कुछ भी अतिरिक्त भुगतान नहीं किया जाएगा।
- 21.0 उत्पादन औजार
उत्पादन - उद्देश्यों से उपस्करों को उतारने तथा स्थानांतरित करने के लिए विभाग द्वारा कोई औजार या टैकिल उपलब्ध नहीं कराए जाएंगे। सफल निविदाकार इन सभी सुविधाओं के लिए अपनी स्वयं की व्यवस्था करेगा।
- 22.0 अन्य एजेंसियों से सहयोग
सफल निविदाकार भवन निर्माण में संलग्न उन संविदाकारों और एजेंसियों, यदि कोई हो, के साथ सहयोग करेगा तथा सभी तकनीकी सूचनाओं का भुक्त आदान-प्रदान करेगा ताकि इस संविदा कार्य का निष्पादन निर्बाध रूप से किया जा सके। ऐसे

17.0 Inspection and testing:

17.1 Copies of all documents of routine and type test certificates of the equipment, carried out at the manufacturers premises shall be furnished to the Engineer-in-charge and consignee

17.2 After completion of the work in all respect the contractor shall offer the installation for testing and operation.

18.0 Validity

Tenders shall be valid for acceptance for a period of 90 days from the date of opening of price bid.

19.0 Compliance with Regulations and Indian standards

19.1 All works shall be carried out in accordance with relevant regulation, both statutory and those specified by the Indian Standards related to the works covered by this specifications. In particular, the equipment and installation will comply with the following:

(i) Factories Act.

(ii) Indian Electricity Rules

(iii) I.S. & BS Standards as applicable

(iv) Workmen's compensation Act

(v) Statutory norms prescribed by local bodies like CEA, NDMC etc.

19.2 Nothing in this specification shall be construed to relieve the successful tenderer of his responsibility for the design, manufacture and installation of the equipment with all accessories in accordance with currently applicable statutory regulations and safety codes.

19.3 Successful tenderer shall arrange for compliance with statutory provisions of safety regulations and departmental requirements of safety codes in respect of labour employed on the work by the tenderer. Failure to provide such safety requirement would make the tenderer liable for penalty of Rs. 50/- for each default. In addition, the department will be at liberty to make arrangement for the safety requirements at the cost of tenderer and recover the cost thereof from him.

20.0 Indemnity

The successful tenderer shall at all times indemnify the department, consequent on this works contract. The successful tenderer shall be liable, in accordance with the Indian Law and Regulations for any accident occurring due to any cause and the department shall not be responsible for any accident or damage incurred or claims arising therefrom during the period of erection, construction and putting into operation the equipments and ancillary equipment under the supervision of the successful tenderer in so far as the latter is responsible. The successful tenderer shall also provide all insurance including third party insurance as may be necessary to cover the risk. No extra payment would be made to the successful tenderer due to the above.

21.0 Erection Tools

No tools and tackles either for unloading or for shifting the equipments for erection purposes would be made available by the department. The successful tenderer shall make his own arrangement for all these facilities.

22.0 Cooperation with other agencies

The successful tender shall co-ordinate with other contractors and agencies engaged in the construction of building, if any, and exchange freely all technical information so as to make the execution of this works contract smooth. No remuneration should be claimed from the department for

तकनीकी सहयोग के लिए किसी प्रकार के परिश्रमिक का दावा नहीं किया जाएगा। यदि किसी अन्य एजेंसी को अनुचित बाधा उत्पन्न होती है, और इस कार्य के दौरान सफल निविदाकार द्वारा सहयोग और समन्वय के हेतु पूर्ण हुए किसी कार्य को खंडित करके पुनः शुरू किया जाता है तो इस पर होने वाले व्यय को सफल निविदाकार से वसूला जाएगा और यह तब किया जाएगा जब खंडित हिस्से को मूल दशा या विशिष्टि में वापस लाने संबंधी कार्य सफल निविदाकार द्वारा स्वयं नहीं किया गया हो।

23.0 अग्रिम जुटाना

इस कार्य के लिए किसी (जुटाव) अग्रिम का भुगतान नहीं किया जाएगा।

24.0 बीमा और भंडारण

सभी परेषण पूर्तिकार की लागत पर एक माल गोदाम से दूसरे माल गोदाम तक के गंतव्य तक विधिवत बीमाकृत होंगे बीमा कवर उपस्कर को सौंपने, विधिवत अधिष्ठापित करने, परीक्षण और प्रवर्तन के समय तक वैध होगा।

25.0 गंतव्य पर उपस्कर ठीक होने का सत्यापन

संविदाकार यह प्रमाणित करने के लिए सभी संगत दस्तावेज, प्रस्तुत करेगा कि विनिर्माता से प्रमाणिक उपस्कर की पूर्ति और अधिष्ठापन किया गया है।

26.0 पेंट करना

इसमें अधिष्ठापन के खुले हुए सभी लोहे के कार्य को पेंट करने की लागत शामिल है। सभी उपस्कर कार्य स्थल के लिए प्रेषित किए जाने से पूर्व पेंट किए जाएंगे।

27.0 प्रशिक्षण

कार्यों की परिधि में स्थल पर दो व्यक्तियों को जॉब तकनीकी प्रशिक्षण देना शामिल है। इसके लिए कुछ भी अतिरिक्त भुगतान नहीं किया जाएगा।

28.0 अनुरक्षण

28.1 अधिष्ठापन को सौंपने के बाद एक वर्ष की गारंटी अवधि के लिए कार्य की किसी आकस्मिकता को पूरा करने के लिए पर्याप्त प्रशिक्षित और अनुभवी स्टाफ उपलब्ध कराया जाएगा।

28.2 विनिर्माताओं के सुझाव के अनुसार, अधिष्ठापन को हाथ में लेने की तारीख से एक वर्ष के लिए नेमी तथा निवारक, अनुरक्षण कार्य किया जाएगा तथा इसका रिकार्ड रखा जाएगा।

29.0 व्याख्याकारी विशिष्टियां

विशिष्टियों की व्याख्या करते समय प्रतिवादों के मामले में निम्नलिखित अवरोही क्रम में महत्व दिया जाएगा:

- (क) परिमाणों की अनुसूची
- (ख) तकनीकी विशिष्टियां
- (ग) आरेख (ड्राइंग) यदि कोई हो
- (घ) सामान्य विनिर्देश
- (ङ) संगत आई एस कोड या आई एस कोड उपलब्ध न होने पर अन्य अन्तर्राष्ट्रीय कोड

30.0 कार्य अनुसूची के उप-शीर्ष ॥ अर्थात् 1 वर्ष की गारंटी अवधि के पश्चात् 5 वर्षों के लिए वृहत अनुरक्षण, के लिए सफल निविदाकार के साथ एक पृथक पूरक करार किया जाएगा। वृहत अनुरक्षण का भुगतान तिमाही आधार पर तिमाही की समाप्ति पर किया जाएगा।

such technical cooperation. If any unreasonable hindrance is caused to other agencies and any completed portion of the work has to be dismantled and re-done for want of cooperation and coordination by the successful tenderer during the course of work, such expenditure incurred will be recovered from the successful tenderer if the restoration work to the original condition or specification of the dismantled portion of the work was not undertaken by the successful tenderer himself.

23.0 Mobilization Advance

No mobilization advance shall be paid for this work.

24.0 Insurance and Storage

All consignments are to be duly insured upto the destination from warehouse to warehouse at the cost of the supplier. The insurance covers shall be valid till the equipment is handed over duly installed, tested and commissioned.

25.0 Verification of correctness of Equipment at Destination

The contractor shall have to produce all the relevant records to certify that the genuine equipment from the manufacturers has been supplied and erected.

26.0 Painting

This shall include cost of painting of entire exposed iron work complete in the installation. All equipments works shall be painted at the works before despatch to the site.

27.0 Training

The scope of works includes on job technical training of two persons at site. Nothing extra shall be payable on this account.

28.0 Maintenance

28.1 Sufficient trained and experienced staff shall be made available to meet any exigency of work during the guarantee period of one year from the handing over of the installation.

28.2 The maintenance, routine as well as preventive for one year from the date of taking over the installation as per manufacturers recommendation shall be carried out and the record of the same shall have to be maintained.

29.0 Interpreting Specifications

In interpreting the specifications, the following order of decreasing importance shall be followed in case of contradictions :

- (a) Schedule of quantities
- (b) Technical specifications
- (c) Drawing (if any)
- (d) General Specifications
- (e) Relevant IS or other international code in case IS code is not available.

30.0 A separate supplementary agreement shall be made with the successful tenderer for sub head II of schedule of work i.e. Comprehensive Maintenance for 5 years after guarantee period of 1 year. The payment for comprehensive maintenance shall be made quarterly after the end of each quarter.

यात्री/माल-सहयात्री/माल/यात्री-सह-बेड लिफ्टों के लिए अतिरिक्त विशिष्टियां

- | | |
|---|--|
| 1. लिफ्ट का प्रकार | *यात्री/माल-सह-यात्री/माल/यात्री-सह-बेड लिफ्टें |
| 2. आवश्यक लिफ्टों की संख्या (स्थान वार) | एन. आई. टी. अनुमोदन प्राधिकारी द्वारा भरा जाए। |
| 3. भार: व्यक्तियों की संख्या | एन. आई. टी. अनुमोदन प्राधिकारी द्वारा भरा जाये। |
| 4. निर्धारित चाल | एन.आई.टी. अनुमोदन प्राधिकारी द्वारा भरा जाये। |
| 5. यात्रा मीटर में | एन. आई. टी. अनुमोदन प्राधिकारी द्वारा भरा जाये। |
| 6. सेवित तलों की संख्या | एन. आई. टी. अनुमोदन प्राधिकारी द्वारा भरा जाये। |
| 7. (क) लिफ्ट कूप का भीतरी आकार | **एन. आई. टी. अनुमोदन प्राधिकारी द्वारा भरा जाये। |
| (ख) गर्त की गहराई | एन. आई. टी. अनुमोदन प्राधिकारी द्वारा भरा जाये। |
| (ग) हैड कक्ष | एन. आई. टी. अनुमोदन प्राधिकारी द्वारा भरा जाये। |
| 8. लिफ्ट-कार का निर्बाध भीतरी आकार | एन. आई. टी. अनुमोदन प्राधिकारी द्वारा भरा जाये। |
| 9. लिफ्ट मशीन कक्ष की विभाएं | एन. आई. टी. अनुमोदन प्राधिकारी द्वारा भरा जाये। |
| 10. प्रतिभार की स्थिति | *कार के पीछे/पार्श्व में |
| 11. मशीन कक्ष की स्थिति | लिफ्ट शैफ्ट के ऊपर |
| 12 (क) नियंत्रण का प्रकार | माइक्रोप्रोसेसर आधारित ए.सी. परिवर्ती बोल्टता परिवर्ती आवृत्ति |
| (ख) प्रचालन का प्रकार | सरल (सिम्पलैक्स/चयनात्मक - परिचर के साथ/बिना सामूहिक प्रचालन द्विक सामूहिक चयनात्मक प्रचालन/स्वचालित गुप पर्यवेक्षी नियंत्रण । |
| (ग) विभव रहित सम्पर्क | लिफ्ट की प्रत्येक तल स्थिति तथा ऊपर और नीचे की गति के लिए विभव रहित सम्पर्क नियंत्रक में उपलब्ध कराए जाएंगे जिसका उपयोग बाद की तारीख में स्वचालित प्रणाली तैयार करने के लिए किया जा सकता है। |
| 13. कार प्रवेश दरवाजा | |
| (क) संख्या | एन आई टी अनुमोदन प्राधिकारी द्वारा भरा जाए। |
| (ख) आकार | एन आई टी अनुमोदन प्राधिकारी द्वारा भरा जाए। |
| (ग) दरवाजों की किस्म | *क्षैतिज सरकवाँ मध्य खुल्ला / अंत:सर्पी |
| (घ) कार केवल सामने की ओर खुली या खुली | केवल सामने की ओर |

**ADDITIONAL SPECIFICATIONS FOR PASSENGER/GOODS CUM PASSENGER/
GOODS/ PASSENGER CUM BED LIFTS**

सर्वोच्च न्यायालय के आदेशानुसार न्यायिक प्रक्रिया के अंतर्गत प्रस्तावित शर्तों और
परिचालनी को अंतिम रूप दिया गया है।

- | | |
|---|--|
| 1. Type of Lift | *Passenger/ Goods cum passenger/ Goods/ Passenger cum bed lifts |
| 2. Number of lifts required (Location wise) | To be filled by NIT approving authority |
| 3. Load : Number of persons | To be filled by NIT approving authority |
| 4. Rated speed | To be filled by NIT approving authority |
| 5. Travel in meters | To be filled by NIT approving authority |
| 6. Number of floors served | To be filled by NIT approving authority |
| 7. (a) Inside size of lift well | ** To be filled by NIT approving authority |
| (b) Pit Depth | To be filled by NIT approving authority |
| (c) Head room | To be filled by NIT approving authority |
| 8. Clear inside size of lift car | To be filled by NIT approving authority |
| 9. Dimension of lift machine room | To be filled by NIT approving authority |
| 10. Position of counter weight | *At the back / side of the car |
| 11. Position of machine room | At the top of lift shaft |
| 12. (a) Type of control | Microprocessor based AC variable voltage variable frequency. |
| (b) Type of operation | Simplex selective – collective operation with / without attendant / Duplex collective selective operation with / without attendant/ Automatic group supervisory control. |
| (c) Potential free contacts | Potential free contacts for each floor position and up and down movement of the lift shall be provided in the controller which can be used for the building automation system at later date. |
| 13. Car entrance door | |
| (a) Number | To be filled by NIT approving authority |
| (b) size | -do- |
| (c) type of doors | * Horizontal sliding- center opening/ telescopic |
| (d) Car open in front only or open | In front only |

14. निर्माण डिजाइन और कार काय
कार्य का परिष्करण

TECHNICAL PARTICULARS

15. सिगनल प्रणाली का प्रकार

16. अवतरण प्रवेश

- (क) विभिन्न तलों पर अवतरण प्रवेश की स्थिति
- (ख) संख्या
- (ग) आकार
- (घ) दरवाजों का प्रकार
- (ङ) लिफ्ट के ठीक/खराब होने के संकेत

17. विद्युत पूर्ति

18. क्या नियन्त्रण परिपथों के लिए धारा रहित तार उपलब्ध है।

19. स्थल पर आरम्भ करने के लिए प्रस्तावित तारीख

20. समापन की प्रस्तावित तारीख

21. अधिष्ठापन स्थल पर पर्यावरण सम्बन्धी दर्शा

22. भण्डार के लिए स्थान उपलब्ध कराया जाता है

23. अतिरिक्त मद, यदि कोई हो

विशेष आवश्यकता के मामले में सामान्य विनिर्देशों के अनुसार एन आई टी अनुमोदन प्राधिकारी निर्धारित कर सकता है।

- (क) कार में तथा सभी अवतरणों पर डिजिटल तल स्थिति संकेतक (कार/अवतरण दरवाजों के ऊपर प्रदान किया जायेगा)।
- (ख) कार में तथा सभी अवतरणों पर यात्रा दिशा संकेतक (कार/अवतरण दरवाजों के ऊपर प्रदान किया जायेगा)।
- (ग) कार के पहुंचने से पूर्व दो दिन या अधिक कारों के लिए सभी अवतरणों पर घंटा और दृश्य संकेत।
- (घ) कार के भीतर अतिभार चेतावनी श्रव्य एवं दृश्य संकेतक (अतिभार होने पर लिफ्ट चालू नहीं होनी चाहिए)।
- (ङ) बैटरी चालित अलार्म घंटी तथा आपात बत्ती
- (च) कार में म्लानता रोधी दीप्त बटन तथा इन्टर काम युक्त कार प्रचालन पैनल
- (छ) सभी अवतरणों पर दीप्त हाल बटन
- (ज) भूतल पर फायरमैन स्विच

सभी दरवाजे एक ही ओर

एन आई टी अनुमोदन प्राधिकारी द्वारा भरी जाए।

एन आई टी अनुमोदन प्राधिकारी द्वारा भरी जाए।

*क्षैतिज सरकवाँ मध्य खुला अतः सर्पी

लिफ्ट अवतरण के ऊपर एक उपयुक्त बाक्स जिसमें दो भाषाओं हिन्दी व अंग्रेजी में "लिफ्ट खराब है" लिखा हो। लेड दीप्त सभी तलों पर एक साथ जलनी चाहिए।

- (क) पावर 415 वोल्ट ए.सी. 3 कला 50 हर्टज 4 तार प्रणाली
- (ख) प्रकाश व्यवस्था 230 वोल्ट ए.सी. 50 हर्टज

हाँ

एन आई टी अनुमोदन प्राधिकारी द्वारा भरा जाए।

एन आई टी अनुमोदन प्राधिकारी द्वारा भरा जाए।

गर्मी की दशा

शीत की दशा

मानसून की दशा

समुद्र तल से अधिक ऊँचाई

हाँ मशीन कक्ष में

*जो विकल्प लागू न हो उसे काट दें।

**माल सह यात्री लिफ्ट के लिए लिफ्ट कूप के भीतरी आकार का निश्चय करते समय परिशिष्ट V (पृष्ठ 90) में यथा उल्लिखित माल के निकटतम आकार के लिए लिफ्ट कूप विभाओं पर विचार किया जायेगा।

14.	Construction design and finish of car body work	As per General specifications in case of special requirements NIT approving authority may specify.
15.	Type of signal system	<ul style="list-style-type: none"> (a) Digital floor position indicator in the car and at all landings (to be provided above the car/ landing doors. (b) Travel direction indicator in the car and at all landings (to be provided above the car/ landing doors) (c) Gongs & visual indication on all landings for pre arrival of the car for two or more cars. (d) Overload warning Audio & Visual indicator, inside the car (lift should not start on overload) (e) Battery operated alarm bell and emergency light. (f) Car operating panel with fade proof luminous buttons in car and with intercom (g) Luminous hall buttons at all landings. (h) Fireman's switch at ground floor
16.	Landing entrance	
	(a) Location of landing entrance in different floors	All doors on the same side.
	(b) Number	To be filled by NIT approving authority
	(c) size	-do-
	(d) type of doors	* Horizontal sliding- center opening/ telescopic
	(d) Lift in use/ lift out of order sign.	A suitable box above the lift landing with LED illuminated bilingual (in English & Hindi) sign of "LIFT OUT OF ORDER" coming up simultaneously at all floors.
17	Electric Supply	<ul style="list-style-type: none"> (a) Power :- 415 V, AC, 3 phase, 50 Hz, 4 wire system (b) Lighting ; 230 V, AC, 50 Hz
18	Is neutral wire available for control circuits	Yes
19	Proposed date for commencement on site	To be filled by NIT approving authority
20	Proposed date for completion	To be filled by NIT approving authority
21	Environmental condition at site of installation	<ul style="list-style-type: none"> Summer condition Winter condition Monsoon condition Height above sea level
22	Storage space provided	Yes in the machine room
23	Additional item, if any	_____

* Delete the option which is not applicable.

** While deciding the inside size of lift well for goods cum passenger lift, dimensions of lift well for nearest size of goods lift as mentioned in appendix-V (page 90) shall be considered.

तकनीकी विवरण

क्रम सं.	विस्तृत विवरण
(क)	<p>सामान्य</p> <ol style="list-style-type: none"> 1. विनिर्माता का नाम 2. विनिर्माता देश का नाम 3. क्षमताएं (व्यक्ति/भार) 4. सेवा 5. यात्रा की गति 6. यात्रा की ऊँचाई 7. सेवित तलों की संख्या 8. दरवाजों की संख्या 9. प्रतिभार की स्थिति 10. समतलवा विधि का प्रकार
(ख)	<p>मशीन</p> <ol style="list-style-type: none"> 1. मशीन की स्थिति 2. मोटर 3. इसके प्रचालन के लिए उपयुक्त विद्युत पूर्ति के विवरण
(ग)	<p>ब्रेक</p> <ol style="list-style-type: none"> 1. प्रकार
(घ)	<p>कार और दरवाजे</p> <ol style="list-style-type: none"> 1. कार की बाहरी विभाएं (माप) 2. भीतरी निर्बाध विभाएं 3. कार का निर्माण 4. कार अतः क्षेत्र का डिजाइन/प्रकार 5. फ्लोरिंग विवरण 6. कार के भीतर की व्यवस्था और फिटिंग 7. कार दरवाजे <ul style="list-style-type: none"> (क) आकार (ख) प्रचालन (ग) निर्माण डिजाइन और परिसज्जा 8. अवतरण दरवाजे <ul style="list-style-type: none"> (क) आकार (ख) प्रचालन (ग) निर्माण डिजाइन और परिसज्जा
(ङ)	<p>सुरक्षा युक्तियां</p> <ol style="list-style-type: none"> 1. कार सुरक्षा प्रकार 2. प्रतिभार सुरक्षा प्रकार 3. कार प्रकार में दरवाजा अंतः पाश 4. अवतरण प्रकार में द्वार पाश
(च)	<p>प्रस्ताव में शामिल अन्य सुरक्षाये</p>

TECHNICAL PARTICULARS

<i>Sl. No.</i>	<i>Particulars of Details</i>
A.	General : <ol style="list-style-type: none">1. Name of Manufacturer.2. Country of Manufacture.3. Capacities (Persons/ Weight).4. Service5. Speed of Travel6. Height of Travel.7. No. of Floors served.8. No. of openings.9. Position of counterweight.10. Type of Levelling method.
B.	Machine: <ol style="list-style-type: none">1. Position of Machine2. Motor3. Electric supply particulars for which it is suitable for operation
C.	Brake <ol style="list-style-type: none">1. Type
D.	Car and Doors: <ol style="list-style-type: none">1. Outside dimensions of car.2. Inside clear dimensions.3. Construction of car4. Design/ type of enclosure of car.5. Details of flooring6. Attachment and fitting inside the car7. Car Doors:<ol style="list-style-type: none">(a) Size(b) Operation(c) Construction , Design & finish8. Landing Doors :<ol style="list-style-type: none">(a) Size(b) Operation(c) Construction , design & finish
E.	Safety Devices: <ol style="list-style-type: none">1. Car safety-type2. Counter weight safety-type3. Door inter locks in car-type4. Door locks in landing-type.
F.	Other Safeties included in the offer:

लागत सार

उपशीर्ष -I रु०
उपशीर्ष -II रु०
कुल राशि रु०

(..... रु०)

टिप्पणी : ऐसी निविदायें जिसमें कोई शर्त जैसे सशर्त छूट शामिल हो अस्वीकार कर दी जायेगी।

ABSTRACT OF COST

SUB HEAD I

Rs.

SUB HEAD II

Rs.

Total amount

Rs.

(Rupees.....)

Note: Tenders with any condition including that of conditional rebates shall be rejected forthwith.

(क) यात्री लिफ्टों के लिए कार्य अनुसूची

कार्य का नाम

क्रम संख्या	विवरण	मात्रा	दर	इकाई	राशि
1.	<p>उपशीर्ष - I एम.पी.एस./ 1.5 एम.पी.एस.(चाल चयन के लिए) विशिष्टियों का पैरा 8 देखें कि अनुबंधित चाल तथा विभिन्न तलों को सेवा प्रदान करने वाली मौजूदा लिफ्ट शैफ्ट से संलग्न विस्तृत विवरणों के अनुसार *4 यात्री (272 किग्रा)/6 यात्री (408 किग्रा)/ 8 यात्री (544 किग्रा)/10 यात्री (680 किग्रा)/13 यात्री (884 किग्रा)/16 यात्री (1088 किग्रा) / 20 यात्री (1360 किग्रा.) लिफ्टों की पूर्ति, अधिष्ठापन परिक्षण और प्रवर्तन नियमानुसार होगा।</p> <p>लिफ्टों की अवस्थिति - (i) चाल1 एम.पी.एस. /1.5 एम.पी.एस (ii) तल (iii) यात्रा मीटर (लगभग) (iv) रोक (स्टॉप) और द्वार (v) नियंत्रक : ए सी परिवर्ती वोल्टता और परिवर्ती आवृत्ति (vi) शुल्क अनुरक्षण रहित बैटरियों सहित, यथावश्यक, स्वचालित बचाव साधन (vii) प्रचालन : माइक्रोप्रोसेसर आधारित एकल स्वचालित दाब बटन/सिम्पलैक्स चयनात्मक सामूहिक/दोहरी सामूहिक चयनात्मक/परिचर सहित/रहित (viii) पॉवर - 415 वोल्ट, 3 कला, 50 हर्ट्ज 4 तार प्रणाली। (ix) दरवाजों का प्रकार (क) कार : पॉवर प्रचालित, मध्य द्वार कैतिज सरकवां जंगरोधी इस्पात खरोंच रोधी (मून रॉक फिनिश) (ख) अवतरण दरवाजे : अनुमोदित रंग की फुहार रंगाई से परिसज्जित एम एस दरवाजे</p> <p>टिप्पणी : तटवर्ती क्षेत्रों में इस्पात के जंगरोधी खरोंच रोधी अवतरण दरवाजों (मून टॉक फिनिश) की अनुमति दी जाएगी।</p>	सं०			
2.	<p>लिफ्ट कार में नियंत्रण पैनल से सटी फर्श तल से 900 मिमी० की ऊँचाई पर एक हस्त रेल, जिसकी लम्बाई 600 मिमी० से कम न हो, लगायी जाएगी।</p>	सेट			
3.	<p>उत्पाक सेवा वाले तल पर कार के गुजरते या रुकते समय उत्तोलक मार्ग (हाइस्टवे) में उत्पाक की स्थिति की सूचना प्रदान करने के लिए कार में वाक सूचना प्रणाली</p>	सेट			
	उप शीर्ष - I का योग				

(A) SCHEDULE OF WORK for Passenger Lifts

NAME OF WORK:

S.No.	Description	Qty	Rate	Unit	Amount
1.	<p>Sub Head I Supplying, installation, testing & commissioning of *4 passenger (272 kg)/ 6 passenger (408 kg)/ 8 passenger (544 kg)/ 10 passenger (680 kg)/ 13 passenger (884 kg)/ 16 passenger (1088 kg)/ 20 passenger (1360 kg) lifts having contract speed of 1 MPS/ 1.5 MPS (Refer para 8 of specifications for selection of speed) serving different floors in the lift shaft as per detailed specifications enclosed and as under :- Location of Lifts : _____ (i) Speed _____ 1MPS/ 1.5 MPS (ii) Floors _____ (iii) Travel _____ Meters (approx.) (iv) Stops & opening _____ (v) Controller: A.C. variable voltage & variable frequency (vi) Automatic rescue device complete with dry maintenance free batteries as required. (vii) Operation : Microprocessor based single automatic push button/ simplex selective collective/ duplex collective selective with / without attendant (viii) Power – 415 V, 3 phase, 50 Hz, 4 wires system (ix) Type of doors (a) Car : Power operated, centre opening horizontal sliding stainless steel scratch proof (moon rock finish) (b) Landing doors : MS doors finished with spray painting of approved shade. Note: In coastal areas stainless steel scratch proof (moon rock finish) landing doors shall be permitted)</p>	Nos.			
2.	A hand rail not less than 600mm long at 900mm above floor level to be fixed adjacent to control panel in the lift car.	Set			
3.	Voice announcement system in the car to announce the position of the elevator in the hoistway as the car passes or stops at a floor served by the elevator.	Set			
	Total of Sub Head I				

क्रम संख्या	विवरण	मात्रा	दर	इकाई	राशि
1.	उप-शीर्ष -II 5 वर्षों के लिए लिफ्टों का वृहत अनुरक्षण जिसमें खराब होने के न्यूनतम समय के भीतर घिसी हुई मर्दों की मरम्मत/बदलना तथा एक वर्ष की गारंटी अवधि के पूरा होने के पश्चात् मर्द के मरम्मत/बदलने की वारंटी और गारंटी शामिल है।	1 जॉब			
	उप-शीर्ष-II का योग				
	महा योग				

टिप्पणी: मर्द 2 और 3 बाधामुक्त आवश्यकताओं के लिए उद्दिष्ट है (परिशिष्ट -VII देखें) जिसमें भवन में 13 यात्रियों की लिफ्ट में कम से कम एक में व्यवस्था की जाए।

*विकल्प जो लागू न हो उसे काट दें।

S.No.	Description	Qty	Rate	Unit	Amount
	Sub Head II				
1.	Comprehensive maintenance of lifts which include routine, preventive & break down maintenance for period of five years including repair/ replacement of worn out items with minimum downtime and warranty & guarantee of repaired / replaced items after completion of one year guarantee period.	1 Job			
	Total of Sub Head II				
	Grand Total				

Note: Item No. 2 & 3 are meant for barrier free requirements (ref. Appendix VII) wherein provisions are to be made at least in one 13 passenger lift in the building.

* Delete the option which is not applicable.

(ख) माल-सह-यात्री लिफ्टों के लिए कार्य अनुसूची

कार्य का नाम

क्रम संख्या	विवरण	मात्रा	दर	इकाई	राशि
1.	<p>उपशीर्ष - I</p> <p>1 एम पी एस/1.5 एम पी एस की अनुबंधित चाल वाली लिफ्ट के मौजूदा लिफ्ट शैफ्ट में *500 कि.ग्रा./1000 कि.ग्रा./ 1500 कि.ग्रा./2000 कि.ग्रा./2500 कि.ग्रा./ 3000 कि.ग्रा./4000 कि.ग्रा./5000 कि.ग्रा./ क्षमता की लिफ्ट-पूर्ति, अधिष्ठापन, परीक्षण और प्रवर्तन की संलग्न विशिष्टियों के अनुसार तथा नीचे दिए अनुसार होगा।</p> <p>लिफ्टों की अवस्थिति -</p> <p>(i) चाल1 एम.पी.एस. /1.5 एम.पी.एस</p> <p>(ii) तल</p> <p>(iii) यात्रा मीटर (लगभग)</p> <p>(iv) रोक (स्टॉप) और द्वार</p> <p>(v) नियंत्रक : ए सी परिवर्ती वोल्टता और परिवर्ती आवृत्ति</p> <p>(vi) शुष्क अनुरक्षण रहित बैटरियों सहित, यथाआवश्यक स्वचालित बचाव साधन</p> <p>(vii) प्रचालन : माइक्रोप्रोसेसर आधारित एकल स्वचालित दाब बटन/सिम्लैक्स चयनात्मक/दोहरी सामूहिक चयनात्मक/परिचर सहित/रहित</p> <p>(viii) पॉवर - 415 वोल्ट, 3 कला, 50 हर्ट्ज 4 तार प्रणाली।</p> <p>(ix) दरवाजों का प्रकार</p> <p>(क) कार : पॉवर प्रचालित, मध्य में खुलने वाला क्षैतिज सरकवां जंगरोधी इस्पात खरोंच रोधी (मून रॉक फिनिश)</p> <p>(ख) अवतरण दरवाजे : अनुमोदित रंग की फुहार रंगाई से परिसज्जित एम एस दरवाजे</p> <p>टिप्पणी : तटवर्ती क्षेत्रों में इस्पात के जंगरोधी खरोंच रोधी अवतरण दरवाजों (मून टॉक फिनिश) की अनुमति दी जाएगी।</p>	सं०			
2.	<p>लिफ्ट कार में नियंत्रण पैनल से सटी फर्श तल से 900 मि.मी. की ऊँचाई पर एक हस्त रेल, जिसकी लम्बाई 600 मिमी० से कम न हो, लगायी जाएगी।</p>	सेट			
3.	<p>उत्थापक सेवा वाले तल पर कार के गुजरते या रुकते समय उत्तोलक मार्ग (हाइस्टवे) में उत्थापक की स्थिति की सूचना प्रदान करने के लिए कार में वाक सूचना प्रणाली</p>	सेट			
	उप शीर्ष -I का योग				

(B) SCHEDULE OF WORK for Goods-cum-Passenger Lifts

NAME OF WORK:

S.No.	Description	Qty	Rate	Unit	Amount
	Sub Head I				
1.	<p>Supplying, installation, testing & commissioning of *500 kg/ 1000 kg/ 1500 kg/ 2000 kg/ 2500 kg/ 3000 kg/ 4000 kg/ 5000 kg Goods cum passenger lift having contract speed of 1 MPS/ 1.5 MPS in the existing lift shaft as per detailed specifications enclosed and as under :-</p> <p>Location of Lifts : _____</p> <p>(i) Speed _____ 1MPS/ 1.5 MPS</p> <p>(ii) Floors _____</p> <p>(iii) Travel _____ Meters (approx.)</p> <p>(iv) Stops & opening _____</p> <p>(v) Controller: A.C. variable voltage & variable frequency</p> <p>(vi) Automatic rescue device complete with dry maintenance free batteries as required.</p> <p>(vii) Operation : Microprocessor based single automatic push button/ simplex selective collective/ duplex collective selective with / without attendant</p> <p>(viii) Power – 415 V, 3 phase, 50 Hz, 4 wires system</p> <p>(ix) Type of doors</p> <p>(a) Car : Power operated centre opening horizontal sliding stainless steel scratch proof (moon rack finish)</p> <p>(b) Landing doors : MS doors finished with spray painting of approved shade.</p> <p>Note: In coastal areas stainless steel scratch proof (moon rock finish) landing doors shall be permitted)</p>	Nos.			
2.	A hand rail not less than 600mm long at 900mm above floor level to be fixed adjacent to control panel in the lift car.	Set			
3.	Voice announcement system in the car to announce the position of the elevator in the hoistway as the car passes or stops at a floor served by the elevator.	Set			
	Total of Sub Head I				

क्रम संख्या	विवरण	मात्रा	दर	इकाई	राशि
1.	उप-शीर्ष -II 5 वर्षों के लिए लिफ्टों का वृहत् अनुरक्षण जिसमें खराब होने के न्यूनतम समय के भीतर घिसी हुई मदों की मरम्मत/बदलना तथा एक वर्ष की गारंटी अवधि के पूरा होने के पश्चात् मद की मरम्मत/बदलने की वारंटी और गारंटी शामिल है।	1 जॉब			
	उप-शीर्ष-II का योग				
	महा योग				

टिप्पणी: मद 2 और 3 बाधामुक्त आवश्यकताओं के लिए उद्दिष्ट हैं (परिशिष्ट -VII देखें) जिसमें भवन में 13 यात्रियों की लिफ्ट में कम से कम एक में व्यवस्था की जाए।

*विकल्प जो लागू न हो उसे काट दें।

S.No.	Description	Qty	Rate	Unit	Amount
	Sub Head II				
1.	Comprehensive maintenance of lifts which include routine, preventive & break down maintenance for period of five years including repair/ replacement of worn out items with minimum downtime and warranty & guarantee of repaired / replaced items after completion of one year guarantee period.	1 Job			
	Total of Sub Head II				
	Grand Total				

Note: Item No. 2 & 3 are meant for barrier free requirements (ref. Appendix VII) wherein provisions are to be made at least in one 13 passenger lift in the building.

* Delete the option which is not applicable.

(ग) माल लिफ्टों के लिए कार्यों की अनुसूची

क्रम संख्या	विवरण	मात्रा	दर	इकाई	राशि
1.	<p>उपशीर्ष - I</p> <p>0.5 एम पी एस/0.75 एम पी एस (पैरा-चाल चयन के लिए विशिष्टियां देखें) की अनुबंधित चाल वाली लिफ्ट शैफ्ट में, संलग्न विस्तृत - विवरणों के अनुसार *500 कि.ग्रा./1000 कि.ग्रा./1500 कि.ग्रा./2000 कि.ग्रा./2500 कि.ग्रा./3000 कि.ग्रा./4000 कि.ग्रा./5000 कि.ग्रा. क्षमता की माल लिफ्ट संबंधी पूर्ति, अधिष्ठापन, परीक्षण और प्रवर्तन निम्नानुसार होगा।</p> <p>लिफ्टों की अवस्थिति -</p> <p>(i) चाल - 0.5 एम पी एस/0.75 एम पी एस</p> <p>(ii) तल</p> <p>(iii) यात्रा - मीटर (लगभग)</p> <p>(iv) रोक (स्टॉप) और द्वार</p> <p>(v) नियंत्रक : ए सी परिवर्ती वोल्टता और परिवर्ती आवृत्ति</p> <p>(vi) प्रचालन : माइक्रोप्रोसेसर आधारित एकल स्वचालित दाब बटन/सिम्प्लैक्स चयनात्मक सामूहिक/दोहरी, सामूहिक चयनात्मक परिचर सहित/रहित</p> <p>(vii) पॉवर - 415 वोल्ट, 3 कला, 50 हर्ट्ज, 4 तार प्रणाली</p> <p>(viii) दरवाजों के प्रकार</p> <p>(क) कार : पॉवर प्रचालित मध्य में खुलने वाला क्षैतिज सरकवां जंगरोधी इस्पात खरोंच रोधी (मून रॉक फिनिश)</p> <p>(ख) अवतरण दरवाजा : अनुमोदित रंग की फुहार रंगाई से परिसज्जित एम एस दरवाजे</p> <p>टिप्पणी : तटवर्ती क्षेत्रों में इस्पात के जंगरोधी, खरोंच रोधी अवतरण दरवाजों (मून रॉक फिनिश) की अनुमति दी जाएगी।</p>				
	उप-शीर्ष-: का योग				

(C) SCHEDULE OF WORK for goods lifts

NAME OF WORK:

S.No.	Description	Qty	Rate	Unit	Amount
1.	<p>Sub Head I</p> <p>Supplying, installation, testing & commissioning of *500 kg/ 1000 kg/ 1500 kg/ 2000 kg/ 2500 kg/ 3000 kg/ 4000 kg/ 5000 kg Goods lift having contract speed of 0.5 MPS/ 0.75 MPS (Refer para — specifications for selection of speed) in the existing lift shaft as per detailed specifications enclosed and as under :- Location of Lifts : _____</p> <p>(i) Speed _____ 0.5MPS/ 0.75 MPS</p> <p>(ii) Floors _____</p> <p>(iii) Travel _____ Meters (approx.)</p> <p>(iv) Stops & opening _____</p> <p>(v) Controller: A.C. variable voltage & variable frequency</p> <p>(vi) Operation : Microprocessor based single automatic push button/ simplex selective collective/ duplex collective selective with / without attendant</p> <p>(vii) Power – 415 V, 3 phase, 50 Hz, 4 wires system</p> <p>(viii) Type of doors</p> <p>(a) Car : Power operated centre opening horizontal sliding stainless steel scratch proof (moon rack finish)</p> <p>(b) Landing door: MS doors finished with spray painting of approved shade.</p> <p>Note: In coastal areas stainless steel scratch proof (moon rock finish) landing doors shall be permitted)</p>	Nos.			
	Total of Sub Head I				

क्रम संख्या	विवरण	मात्रा	दर	इकाई	राशि
1.	उपशीर्ष-II 5 वर्षों के लिए लिफ्टों का वृहत अनुरक्षण जिसमें खराब होने के न्यूनतम समय के भीतर घिसी हुई मदों के मरम्मत/बदलना तथा एक वर्ष की गारंटी अवधि के पूरा होने के पश्चात मद की मरम्मत/बदलने की वारंटी और गारंटी शामिल है।	1 जॉब			
	उप-शीर्ष-II का योग				
	महायोग				

*विकल्प जो लागू न हो उसे काट दें।

S.No	Description	Qty	Rate	Unit	Amount
1.	Sub Head II Comprehensive maintenance of lifts which include routine, preventive & breakdown maintenance for period of five years including repair/ replacement of worn out items with minimum downtime and warranty & guarantee of repaired / replaced items after completion of one year guarantee period.	1 Job			
	Total of Sub Head II				
	Grand Total				

* Delete the option which is not applicable.

(घ) बेड सह-यात्री लिफ्ट (अस्पताल लिफ्ट) के लिए कार्य अनुसूची

कार्य का नाम

क्रम संख्या	विवरण	मात्रा	दर	इकाई	राशि
1.	<p>उपशीर्ष - I</p> <p>0.5 एम.पी.एस./0.75 एम पी एस/1 एम पी एस अनुबंधित चाल तथा विभिन्न तलों को सेवा प्रदान करने वाली मौजूदा लिफ्ट शैफ्ट में, संलग्न विस्तृत विवरणों के अनुसार, *15 यात्री (1020 कि.ग्रा.) /20 यात्री (1360 कि.ग्रा.)/26 यात्री (1768 कि.ग्रा.) सह बेड लिफ्टों की पूर्ति, अधिष्ठापन, परीक्षण और प्रवर्तन निम्नानुसार होगा-</p> <p>लिफ्टों की अवस्थिति -</p> <p>(i) चाल 0.5/0.75/01.00 एम पी एस</p> <p>(ii) तल</p> <p>(iii) यात्रा मीटर (लगभग)</p> <p>(iv) रोक (स्टॉप) और द्वार</p> <p>(v) नियंत्रक : ए सी परिवर्ती वोल्टता और परिवर्ती आवृत्ति</p> <p>(vi) शुष्क अनुरक्षण रहित बैटरियों सहित, यथावश्यक, स्वचालित बचाव साधन</p> <p>(vii) प्रचालन : माइक्रोप्रोसेसर आधारित एकल स्वचालित दाब बटन/सिम्पलैक्स चयनात्मक सामूहिक/दोहरी सामूहिक चयनात्मक/परिचर सहित/रहित</p> <p>(viii) पॉवर - 415 वोल्ट, 3 कला, 50 हर्ट्ज 4 तार प्रणाली।</p> <p>(ix) दरवाजों का प्रकार</p> <p>(क) कार : स्वाचालित पॉवर प्रचालित, टेलिस्कोपिक क्षैतिज सरकवां इस्पात जंगरोधी खरोंच रोधी (मून टॉक फिनिश)</p> <p>(ख) अवतरण दरवाजे : अनुमोदित रंग की फुहार रंगाई से परिसज्जित एम एस दरवाजे</p> <p>टिप्पणी : तटवर्ती क्षेत्रों में इस्पात के जंगरोधी खरोंच रोधी आवरण दरवाजों (मून रॉक फिनिश) की अनुमति दी जाएगी।</p>	सं०			
2.	लिफ्ट कार में नियंत्रण पैनल से सटी फर्श तल से 900 मिमी. की ऊँचाई पर एक हस्त रेल, जिसकी लम्बाई 600 मिमी० से कम न हो, लगायी जाएगी।	सेट			
3.	उत्थापक सेवा वाले तल पर कार के गुजरते या रुकते समय उत्तोलक मार्ग (हाइस्टवे) में उत्थापक की स्थिति की सूचना प्रदान करने के लिए कार में वाक सूचना प्रणाली	सेट			
	उप शीर्ष -I का योग				

(D) SCHEDULE OF WORK for bed cum passenger lift (Hospital lifts)

NAME OF WORK:

S.No.	Description	Qty	Rate	Unit	Amount
1.	<p>Sub Head I Supplying, installation, testing & commissioning of *15 passenger (1020 kg)/ 20 passenger (1360 kg)/ 26 passenger (1768 kg) cum bed lifts having contract speed of 0.5 MPS/ 0.75 MPS/1 MPS serving different floors in the existing lift shaft as per detailed specifications enclosed and as under :- Location of Lifts : _____</p> <p>(i) Speed _____ 0.5/ 0.75 /1 MPS (ii) Floors _____ (iii) Travel _____ Meters (approx.) (iv) Stops & opening _____ (v) Controller: A.C. variable voltage & variable frequency (vi) Automatic rescue device complete with dry maintenance free batteries as required. (vii) Operation : Microprocessor based single automatic push button/ simplex selective collective/ duplex collective selective with / without attendant (viii) Power – 415 V, 3 phase, 50 Hz, 4 wires system (ix) Type of doors (a) Car : Automatic Power operated , Telescopic horizontal sliding stainless steel scratch proof surface(moon rock finish) (b) Landing doors: MS.doors finished with spray painting of approved shade. Note: In coastal areas stainless steel scratch proof (moon rock finish) landing doors shall be permitted)</p>	Nos.			
2.	A hand rail not less than 600mm long at 900mm above floor level to be fixed adjacent to control panel in the lift car.	Set			
3.	Voice announcement system in the car to announce the position of the elevator in the hoistway as the car passes or stops at a floor served by the elevator.	Set			
	Total of Sub Head I				

क्रम संख्या	विवरण	मात्रा	दर	इकाई	राशि
1.	उप-शीर्ष -II 5 वर्षों के लिए लिफ्टों का वृहत अनुरक्षण जिसमें खराब होने के न्यूनतम समय के भीतर घिसी हुई मदों की मरम्मत/बदलना तथा एक वर्ष की गारंटी अवधि के पूरा होने के पश्चात् मद के मरम्मत/बदलने की वारंटी और गारंटी शामिल है।	1 जॉब			
	उप-शीर्ष-II का योग				
	महा योग				

टिप्पणी: मद 2 और 3 बाधामुक्त आवश्यकताओं के लिए उद्दिष्ट है (परिशिष्ट -VII देखें) जिसमें भवन में 13 यात्रियों की लिफ्ट में कम से कम एक में व्यवस्था की जाएगी।

*विकल्प जो लागू न हो उसे काट दें।

S.No.	Description	Qty	Rate	Unit	Amount
	Sub Head II				
1.	Comprehensive maintenance of lifts which include routine, preventive & break down maintenance for period of five years including repair/ replacement of worn out items with minimum downtime and warranty & guarantee of repaired / replaced items after completion of one year guarantee period.	1 Job			
	Total of Sub Head II				
	Grand Total				

Note: Item No. 2 & 3 are meant for barrier free requirements (ref. Appendix VII) wherein provisions are to be made at least in one bed cum passenger lift in the building.

* Delete the option which is not applicable.

एन आई टी
(भाग -II)

कीमत बोली

NIT
(Part-II)

Price Bid

WORK:

लागत सार

उपशीर्ष -I रु०

उपशीर्ष -II रु०

कुल राशि रु०

(..... रु०)

टिप्पणी : ऐसी निविदायें जिसमें कोई शर्त जैसे सशर्त छूट शामिल हो अस्वीकार कर दी जायेगी।

ABSTRACT OF COST

SUB HEAD I Rs.

SUB HEAD II Rs.

Total amount Rs.

(Rupees.....)

Note: Tenders with any condition including that of conditional rebates shall be rejected forthwith.

(क) यात्री लिफ्टों के लिए कार्य अनुसूची

कार्य का नाम					
क्रम संख्या	विवरण	मात्रा	दर	इकाई	राशि
1.	<p>उपशीर्ष - I</p> <p>एम.पी.एस./ 1.5 एम.पी.एस.(चाल चयन के लिए) विशिष्टियों का पैरा 8 देखें कि अनुबंधित चाल तथा तथा विभिन्न तलों को सेवा प्रदान करने वाली मौजूदा लिफ्ट शैफ्ट से संलग्न विस्तृत विवरणों के अनुसार *4 यात्री (272 किग्रा)/ 6 यात्री (408 किग्रा)/ 8 यात्री (544 किग्रा)/10 यात्री (680 किग्रा)/ 13 यात्री (884 किग्रा.) /16 यात्री (1088 किग्रा.)/ 20 यात्री (1360 किग्रा.) लिफ्टों की पूर्ति अधिष्ठापन परिक्षण और परिवर्तन नियमानुसार होगा।</p> <p>लिफ्टों की अवस्थिति -</p> <p>(i) चाल1 एम.पी.एस. /1.5 एम.पी.एस</p> <p>(ii) तल</p> <p>(iii) यात्रा मीटर (लगभग)</p> <p>(iv) रोक (स्टॉप) और द्वार</p> <p>(v) नियंत्रक : ए सी परिवर्ती वोल्टता और परिवर्ती आवृत्ति</p> <p>(vi) शुष्क अनुरक्षण रहित बैटरियों सहित, यथावश्यक, स्वचालित बचाव साधन</p> <p>(vii) प्रचालन : माइक्रोप्रोसेसर आधारित एकल स्वचालित दाब बटन/सिम्पलैक्स चयनात्मक सामूहिक/दोहरी सामूहिक चयनात्मक/परिचर सहित/रहित</p> <p>(viii) पॉवर - 415 वोल्ट, 3 कला, 50 हर्ट्ज 4 तार प्रणाली।</p> <p>(ix) दरवाजों का प्रकार</p> <p>(क) कार : पॉवर प्रचालित, मध्य द्वार कैतिज सरकवां जंगरोधी इस्पात खरोंच रोधी (मूल रॉक फिनिश)</p> <p>(ख) अवतरण दरवाजे : अनुमोदित रंग की फुहार रंगाई से परिसज्जित एम एस दरवाजे</p> <p>टिप्पणी : तटवर्ती क्षेत्रों में इस्पात के जंगरोधी दरवाजों (मून रॉक फिनिश) की अनुमति दी जाएगी।</p>	सं०			
2.	<p>लिफ्ट कार में नियंत्रण पैनल से सटी फर्श तल से 900 मिमी. की ऊँचाई पर एक हस्त रेल, जिसकी लम्बाई 600 मिमी० से कम न हो, लगायी जाएगी।</p>	सेट			
3.	<p>उत्थापक सेवा वाले तल पर कार के गुजरते या रुकते समय उल्लोलक मार्ग (हाइस्टवे) में उत्थापक की स्थिति की सूचना प्रदान करने के लिए कार में वाक सूचना प्रणाली</p>	सेट			
	उप शीर्ष - I का योग				

(A) SCHEDULE OF WORK for Passenger Lifts

NAME OF WORK:

S.No.	Description	Qty	Rate	Unit	Amount
1.	<p>Sub Head I Supplying, installation, testing & commissioning of *4 passenger (272 kg)/ 6 passenger (408 kg)/ 8 passenger (544 kg)/ 10 passenger (680 kg)/ 13 passenger (884 kg)/ 16 passenger (1088 kg)/ 20 passenger (1360 kg) lifts having contract speed of 1 MPS/ 1.5 MPS (Refer para 8 of specifications for selection of speed) serving different floors in the lift shaft as per detailed specifications enclosed and as under :- Location of Lifts : _____ (i) Speed _____ 1MPS/ 1.5 MPS (ii) Floors _____ (iii) Travel _____ Meters (approx.) (iv) Stops & opening _____ (v) Controller: A.C. variable voltage & variable frequency (vi) Automatic rescue device complete with dry maintenance free batteries as required. (vii) Operation : Microprocessor based single automatic push button/ simplex selective collective/ duplex collective selective with / without attendant (viii) Power – 415 V, 3 phase, 50 Hz, 4 wires system (ix) Type of doors (a) Car : Power operated, centre opening horizontal sliding stainless steel scratch proof (moon rock finish) (b) Landing doors : MS doors finished with spray painting of approved shade. Note: In coastal areas stainless steel scratch proof (moon rock finish) landing doors shall be permitted)</p>	Nos.			
2.	A hand rail not less than 600mm long at 900mm above floor level to be fixed adjacent to control panel in the lift car.	Set			
3.	Voice announcement system in the car to announce the position of the elevator in the hoistway as the car passes or stops at a floor served by the elevator.	Set			
	Total of Sub Head I				

क्रम संख्या	विवरण	मात्रा	दर	इकाई	राशि
1.	उप-शीर्ष -II 5 वर्षों के लिए लिफ्टों का वृहत अनुरक्षण जिसमें खराब होने के न्यूनतम समय के भीतर घिसी हुई मर्दों की मरम्मत/बदलना तथा एक वर्ष की गारंटी अवधि के पूरा होने के पश्चात् मद के मरम्मत/बदलने की वारंटी और गारंटी शामिल है।	1 जॉब			
	उप-शीर्ष-II का योग				
	महा योग				

टिप्पणी: मद 2 और 3 बाधामुक्त आवश्यकताओं के लिए उद्दिष्ट हैं (परिशिष्ट -VII देखें) जिसमें भवन में 13 यात्रियों की लिफ्ट में कम से कम एक में व्यवस्था की जाए।

*विकल्प जो लागू न हो उसे काट दें।

S.No.	Description	Qty	Rate	Unit	Amount
	Sub Head II				
1.	Comprehensive maintenance of lifts which include routine, preventive & break down maintenance for period of five years including repair/ replacement of worn out items with minimum downtime and warranty & guarantee of repaired / replaced items after completion of one year guarantee period.	1 Job			
	Total of Sub Head II				
	Grand Total				

Note: Item No. 2 & 3 are meant for barrier free requirements (ref. Appendix VII) wherein provisions are to be made at least in one 13 passenger lift in the building.

* Delete the option which is not applicable.

(ख) माल-सह-यात्री लिफ्टों के लिए कार्य अनुसूची

कार्य का नाम	क्रम संख्या	विवरण	मात्रा	दर	इकाई	राशि
	1.	<p>उपशीर्ष - I</p> <p>1 एम पी एस/1.5 एम पी एस अनुबंधित चाल वाली माल सहयात्री लिफ्ट के मौजूदा लिफ्ट शैफ्ट में *500 कि.ग्रा./1000 कि.ग्रा./ 1500 कि.ग्रा./2000 कि.ग्रा./2500 कि.ग्रा./ 3000 कि.ग्रा./4000 कि.ग्रा./5000 कि.ग्रा./ क्षमता की लिफ्ट-पूर्ति, अधिष्ठापन, परीक्षण और प्रवर्तन संलग्न विस्तृत विवरणों के अनुसार तथा निम्न अनुसार होगा।</p> <p>लिफ्टों की अवस्थिति -</p> <p>(i) चाल1 एम.पी.एस. /1.5 एम.पी.एस</p> <p>(ii) तल</p> <p>(iii) यात्रा मीटर (लगभग)</p> <p>(iv) रोक (स्टॉप) और द्वार</p> <p>(v) नियंत्रक : ए सी परिवर्ती वोल्टता और परिवर्ती आवृत्ति</p> <p>(vi) शुष्क अनुरक्षण रहित बैटरियों सहित, यथावश्यक, स्वचालित बचाव साधन</p> <p>(vii) प्रचालन : माइक्रोप्रोसेसर आधारित एकल स्वचालित दाब बटन/सिम्पलैक्स चयनात्मक/दोहरी सामूहिक/चयनात्मक/ परिचर सहित/रहित</p> <p>(viii) पॉवर - 415 वोल्ट, 3 कला, 50 हर्ट्ज 4 तार प्रणाली।</p> <p>(ix) दरवाजों का प्रकार</p> <p>(क) कार : पॉवर प्रचालित, मध्य में खुलने वाला क्षैतिज सरकवां जंगरोधी इस्पात, खरोंच रोधी (मून रॉक फिनिश)</p> <p>(ख) अवतरण दरवाजे : अनुमोदित रंग की फुहार रंगाई से परिसज्जित एम एस दरवाजे</p> <p>टिप्पणी : तटवर्ती क्षेत्रों में इस्पात के जंगरोधी खरोंच रोधी अवतरण दरवाजों (मून रॉक फिनिश) की अनुमति दी जाएगी।</p>				
	2.	<p>लिफ्ट कार में नियंत्रण पैनल से सटी फर्श तल से 900 मिमी. की ऊँचाई पर एक हस्त रेल, जिसकी लम्बाई 600 मिमी० से कम न हो, लगायी जाएगी।</p>	सेट			
	3.	<p>उत्थापक सेवा वाले तल पर कार के गुजरते या रुकते समय उत्तोलक मार्ग (हाइस्टवे) में उत्थापक की स्थिति की सूचना प्रदान करने के लिए कार में वाक सूचना प्रणाली।</p>	सेट			
		उप शीर्ष -I का योग				

(B) SCHEDULE OF WORK for Goods-cum-Passenger Lifts

NAME OF WORK:

S.No.	Description	Qty	Rate	Unit	Amount
1.	<p>Sub Head I</p> <p>Supplying, installation, testing & commissioning of *500 kg/ 1000 kg/ 1500 kg/ 2000 kg/ 2500 kg/ 3000 kg/ 4000 kg/ 5000 kg Goods cum passenger lift having contract speed of 1 MPS/ 1.5 MPS in the existing lift shaft as per detailed specifications enclosed and as under :-</p> <p>Location of Lifts : _____</p> <p>(i) Speed _____ 1MPS/ 1.5 MPS</p> <p>(ii) Floors _____</p> <p>(iii) Travel _____ Meters (approx.)</p> <p>(iv) Stops & opening _____</p> <p>(v) Controller: A.C. variable voltage & variable frequency</p> <p>(vi) Automatic rescue device complete with dry maintenance free batteries as required.</p> <p>(vii) Operation : Microprocessor based single automatic push button/ simplex selective collective/ duplex collective selective with / without attendant</p> <p>(viii) Power – 415 V, 3 phase, 50 Hz, 4 wires system</p> <p>(ix) Type of doors</p> <p>(a) Car : Power operated centre opening horizontal sliding stainless steel scratch proof (moon rack finish)</p> <p>(b) Landing doors : MS doors finished with spray painting of approved shade.</p> <p><i>Note: In coastal areas stainless steel scratch proof (moon rock finish) landing doors shall be permitted)</i></p>	Nos.			
2.	A hand rail not less than 600mm long at 900mm above floor level to be fixed adjacent to control panel in the lift car.	Set			
3.	Voice announcement system in the car to announce the position of the elevator in the hoistway as the car passes or stops at a floor served by the elevator.	Set			
	Total of Sub Head I				

क्रम संख्या	विवरण (THE RESPONSIBILITY OF PERSONS for goods was)	मात्रा	दर	इकाई	राशि
1.	उप-शीर्ष -II 5 वर्षों के लिए लिफ्टों का वृहत अनुस्क्षण जिसमें खराब होने के न्यूनतम समय के भीतर घिसी हुई मदों की मरम्मत/बदलना तथा एक वर्ष की गारंटी अवधि के पूरा होने के पश्चात् मद की मरम्मत/बदलने की वारंटी और गारंटी शामिल है।	1 जॉब			
	उप-शीर्ष-II का योग				
	महा योग				

टिप्पणी: मद 2 और 3 बाधामुक्त आवश्यकताओं के लिए उद्दिष्ट है (परिशिष्ट -VII देखें) जिसमें भवन में 13 यात्रियों की लिफ्ट में कम से कम एक में व्यवस्था की जाएगी।

*विकल्प जो लागू न हो उसे काट दें।

S.No.	Description	Qty	Rate	Unit	Amount
	Sub Head II				
1.	Comprehensive maintenance of lifts which include routine, preventive & break down maintenance for period of five years including repair/ replacement of worn out items with minimum downtime and warranty & guarantee of repaired / replaced items after completion of one year guarantee period.	1 Job			
	Total of Sub Head II				
	Grand Total				

Note: Item No. 2 & 3 are meant for barrier free requirements (ref. Appendix VII) wherein provisions are to be made at least in one 13 passenger lift in the building.

* Delete the option which is not applicable.

(ग) माल लिफ्टों के लिए कार्यों की अनुसूची

कार्य का नाम					
क्रम संख्या	विवरण	मात्रा	दर	इकाई	राशि
1.	<p>उपशीर्ष - I</p> <p>0.5 एम पी एस/0.75 एम पी एस (पैरा-चाल चयन के लिए विशिष्टियां देखें) की अनुबंधित चाल वाली लिफ्ट शैफ्ट में, संलग्न विस्तृत - विवरणों के अनुसार* 500 कि.ग्रा./1000 कि.ग्रा./1500 कि.ग्रा./2000 कि.ग्रा./2500 कि.ग्रा./3000 कि.ग्रा./4000 कि.ग्रा./5000 कि.ग्रा. क्षमता की लिफ्ट संबंधी पूर्ति, अधिष्ठापन, परीक्षण और प्रवर्तन निम्नानुसार होगा।</p> <p>लिफ्टों की अवस्थिति -</p> <p>(i) चाल - 0.5 एम पी एस/0.75 एम पी एस</p> <p>(ii) तल</p> <p>(iii) यात्रा - मीटर (लगभग)</p> <p>(iv) रोक (स्टॉप) ओर द्वार</p> <p>(v) नियंत्रक : ए सी परिवर्ती वोल्टता और परिवर्ती आवृत्ति</p> <p>(vi) प्रचालन : माइक्रोप्रोसेसर आधारित एकल स्वचालित दाब बटन/सिम्पलैक्स चयनात्मक सामूहिक/दोहरी, सामूहिक चयनात्मक परिचर सहित/रहित</p> <p>(vii) पॉवर - 415 वोल्ट, 3 कला, 50 हर्ट्ज, 4 तार प्रणाली</p> <p>(viii) दरवाजों के प्रकार</p> <p>(क) कार : पॉवर प्रचालित मध्य में खुलने वाला क्षैतिज सरकवां जंगरोधी इस्पात खरोंच रोधी (मून रॉक फिनिश)</p> <p>(ख) अवतरण दरवाजा : अनुमोदित रंग की फुहार रंगाई से परिसज्जित एम एस दरवाजे</p> <p>टिप्पणी : तटवर्ती क्षेत्रों में इस्पात के जंगरोधी, खरोंच रोधी अवतरण दरवाजों (मून रॉक फिनिश) की अनुमति दी जाएगी।</p>				
	उप-शीर्ष- I का योग				

(C) SCHEDULE OF WORK for goods lifts

NAME OF WORK:

S.No.	Description	Qty	Rate	Unit	Amount
1.	<p>Sub Head I</p> <p>Supplying, installation, testing & commissioning of *500 kg/ 1000 kg/ 1500 kg/ 2000 kg/ 2500 kg/ 3000 kg/ 4000 kg/ 5000 kg Goods lift having contract speed of 0.5 MPS/ 0.75 MPS (Refer para — specifications for selection of speed) in the existing lift shaft as per detailed specifications enclosed and as under :- Location of Lifts : _____</p> <p>(i) Speed _____ 0.5MPS/ 0.75 MPS</p> <p>(ii) Floors _____</p> <p>(iii) Travel _____ Meters (approx.)</p> <p>(iv) Stops & opening _____</p> <p>(v) Controller: A.C. variable voltage & variable frequency</p> <p>(vi) Operation : Microprocessor based single automatic push button/ simplex selective collective/ duplex collective selective with / without attendant</p> <p>(vii) Power – 415 V, 3 phase, 50 Hz, 4 wires system</p> <p>(viii) Type of doors</p> <p>(a) Car : Power operated centre opening horizontal sliding stainless steel scratch proof (moon rack finish)</p> <p>(b) Landing door: MS doors finished with spray painting of approved shade.</p> <p><i>Note:</i> In coastal areas stainless steel scratch proof (moon rock finish) landing doors shall be permitted)</p>	Nos.			
	Total of Sub Head I				

क्रम संख्या	विवरण	मात्रा	दर	इकाई	राशि
1.	उपशीर्ष-II 5 वर्षों के लिए लिफ्टों का वृहत अनुरक्षण जिसमें खराब होने के न्यूनतम समय के भीतर घिसी हुई मर्दों के मरम्मत/बदलना तथा एक वर्ष की गारंटी अवधि के पूरा होने के पश्चात् मद की मरम्मत/बदलने की वारंटी और गारंटी शामिल है।	1 जॉब			
	उप-शीर्ष-II का योग				
	महायोग				

*विकल्प जो लागू न हो उसे काट दें।

S.No.	Description	Qty	Rate	Unit	Amount
	Sub Head II				
1.	Comprehensive maintenance of lifts which include routine, preventive & breakdown maintenance for period of five years including repair/ replacement of worn out items with minimum downtime and warranty & guarantee of repaired / replaced items after completion of one year guarantee period.	1 Job			
	Total of Sub Head II				
	Grand Total				

* Delete the option which is not applicable.

(घ) बेड सह-यात्री लिफ्ट (अस्पताल लिफ्ट) के लिए कार्य अनुसूची

क्रम संख्या	विवरण	मात्रा	दर	इकाई	राशि
1.	<p>उपशीर्ष - I</p> <p>0.5 एम.पी.एस./0.75 एम पी एस/1 एम पी एस अनुबंधित चाल तथा विभिन्न तलों को सेवा प्रदान करने वाली मौजूद लिफ्ट शैफ्ट में, संलग्न विस्तृत विवरणों के अनुसार, *15 यात्री (1020 कि.ग्रा.)/20 यात्री (1360 कि.ग्रा.)/26 यात्री (1768 कि.ग्रा.)सह बेड लिफ्टों की पूर्ति, अधिष्ठापन, परीक्षण और प्रवर्तन निम्नानुसार होगा-</p> <p>लिफ्टों की अवस्थिति -</p> <p>(i) चाल 0.5/0.75/01.00 एम पी एस</p> <p>(ii) तल</p> <p>(iii) यात्रा मीटर (लगभग)</p> <p>(iv) रोक (स्टॉप) और द्वार</p> <p>(v) नियंत्रक : ए सी परिवर्ती वोल्टता और परिवर्ती आवृत्ति</p> <p>(vi) शुष्क अनुरक्षण रहित बैटरियों सहित, यथावश्यक, स्वचालित बचाव साधन</p> <p>(vii) प्रचालन : माइक्रोप्रोसेसर आधारित एकल स्वचालित दाब बटन/सिम्पलैक्स चयनात्मक सामूहिक/दोहरी सामूहिक चयनात्मक परिचर सहित/रहित</p> <p>(viii) पॉवर - 415 वोल्ट, 3 कला, 50 हर्ट्ज 4 तार प्रणाली।</p> <p>(ix) दरवाजों का प्रकार</p> <p>(क) कार : स्वाचालित पॉवर प्रचालित, टेलिस्कोपी क्षैतिज सरकवां इस्पात जंगरोधी खरोंच रोधी पृष्ठ (मून रॉक फिनिश)</p> <p>(ख) अवतरण दरवाजे : अनुमोदित रंग की फुहार रंगाई से परिसज्जित एम एस दरवाजे</p> <p>टिप्पणी : तटवर्ती क्षेत्रों में इस्पात के जंगरोधी खरोंच रोधी अवतरण दरवाजों (मून रॉक फिनिश) की अनुमति दी जाएगी।</p>	सं०			
2.	लिफ्ट कार में नियंत्रण पैनल से सटी फर्श तल से 900 मिमी० की ऊँचाई पर एक हस्त रेल, जिसकी लम्बाई 600 मिमी० से कम न हो, लगायी जाएगी।	सेट			
3.	उत्पाक सेवा वाले तल पर कार के गुजरते या रुकते समय उत्तोलक मार्ग (हाइस्टवे) में उत्पाक की स्थिति की सूचना प्रदान करने के लिए कार में वाक सूचना प्रणाली	सेट			
	उप शीर्ष -I का योग				

(D) SCHEDULE OF WORK for bed cum passenger lift (Hospital lifts)

NAME OF WORK:

S.No.	Description	Qty	Rate	Unit	Amount
1.	<p>Sub Head I -----</p> <p>Supplying, installation, testing & commissioning of *15 passenger (1020 kg)/ 20 passenger (1360 kg)/ 26 passenger (1768 kg) cum bed lifts having contract speed of 0.5 MPS/ 0.75 MPS/1 MPS serving different floors in the existing lift shaft as per detailed specifications enclosed and as under :-</p> <p>Location of Lifts : _____</p> <p>(i) Speed _____ 0.5/ 0.75 /1 MPS</p> <p>(ii) Floors _____</p> <p>(iii) Travel _____ Meters (approx.)</p> <p>(iv) Stops & opening _____</p> <p>(v) Controller: A.C. variable voltage & variable frequency</p> <p>(vi) Automatic rescue device complete with dry maintenance free batteries as required.</p> <p>(vii) Operation : Microprocessor based single automatic push button/ simplex selective collective/ duplex collective selective with / without attendant</p> <p>(viii) Power – 415 V, 3 phase, 50 Hz, 4 wires system</p> <p>(ix) Type of doors</p> <p>(a) Car : Automatic Power operated , Telescopic horizontal sliding stainless steel scratch proof surface(moon rock finish)</p> <p>(b) Landing doors: MS doors finished with spray painting of approved shade.</p> <p><i>Note: In coastal areas stainless steel scratch proof (moon rock finish) landing doors shall be permitted)</i></p>	Nos.			
2.	A hand rail not less than 600mm long at 900mm above floor level to be fixed adjacent to control panel in the lift car.	Set			
3.	Voice announcement system in the car to announce the position of the elevator in the hoistway as the car passes or stops at a floor served by the elevator.	Set			
	Total of Sub Head I				

क्रम संख्या	विवरण	मात्रा	दर	इकाई	राशि
1.	उप-शीर्ष -II 5 वर्षों के लिए लिफ्टों का वृहत् अनुरक्षण जिसमें खराब होने के न्यूनतम समय के भीतर घिसी हुई मदों की मरम्मत/बदलना तथा एक वर्ष की गारंटी अवधि के पूरा होने के पश्चात् मद की मरम्मत/बदलने की वारंटी और गारंटी शामिल है।	1 जॉब			
	उप-शीर्ष-II का योग				
	महा योग				

टिप्पणी: मद 2 और 3 बाधामुक्त आवश्यकताओं के लिए उद्दिष्ट है (परिशिष्ट -VII देखें) जिसमें भवन में 13 यात्रियों की लिफ्ट में कम से कम एक में व्यवस्था की जाएगी।

*विकल्प जो लागू न हो उसे काट दें।

S.No.	Description	Qty	Rate	Unit	Amount
	Sub Head II				
1.	Comprehensive maintenance of lifts which include routine, preventive & break down maintenance for period of five years including repair/ replacement of worn out items with minimum downtime and warranty & guarantee of repaired / replaced items after completion of one year guarantee period.	1 Job			
	Total of Sub Head II				
	Grand Total				

Note: Item No. 2 & 3 are meant for barrier free requirements (ref. Appendix VII) wherein provisions are to be made at least in one bed cum passenger lift in the building.

* Delete the option which is not applicable.

1

2