



सत्यमेव जयते

**GOVERNMENT OF GUJARAT  
BHAVNAGAR MUNICIPAL CORPORATION  
DIST: BHAVNAGAR**

**NAME OF WORK:**

**PROPOSED DOG HOME SHELTER & ANIMAL VACCINATION CENTRE  
AT NARI ROAD, KUMBHARWADA, BHAVNAGAR, DIST.  
BHAVNAGAR**

**STANDARD BIDDING DOCUMENT PROCUREMENT OF CIVIL  
WORKS**

**EXECUTIVE ENGINEER,  
BUILDING DEPARTMENT  
BHAVNAGAR MUNICIPAL CORPORATION  
DIST: BHAVNAGAR**

## Index

<b>Sr No</b>	<b>Section</b>	<b>Description</b>	<b>Page No</b>
1		Invitation for Bid (IFB)	3
2	Section -1	Instructions to Bidders	6
3	Section -2	Qualification Information	27
4	Section -3	Conditions of Contract	34
5	Section -4	Contract Data	61
6	Section -5	Technical Specification	71
7	Section -6	Form of Bid	77
8	Section -7	Bill of Quantities	80
9	Section -8	Securities and Other Forms	83
10	Section -9	Drawings	95
11	Section -10	Documents to be furnished by Bidder	96

**INVITATION FOR BID**  
**(IFB)**

## NATIONAL COMPETITIVE BIDDING

1. The **EXECUTIVE ENGINEER, BHAVNAGAR MUNICIPAL CORPORATION** invites bids for the construction of works detailed in the table. The bidders may submit bids for any or all of the following works.

**TABLE**

Pack age No	Name of work	Approximate value of works (Rs.)	Bid security (Rs.)/ EMD (Rs)	Cost of document/ Tender Fee (Rs)	Period of completion	Class of Registration / Category of contractor if required
1	2	3	4	5	6	7
1	<b>PROPOSED DOG HOME SHELTER &amp; ANIMAL VACCINATION CENTRE AT NARI ROAD, KUMBHARWADA, BHAVNAGAR, DIST. BHAVNAGAR</b>	<b>68855313.00/- (Excl. of GST)</b>	<b>688553.00/-</b>	<b>12000.00 + 2160.00 (18% gst) = 14160.00 in the Form of DD only/-</b>	<b>30 (Thirty) Months including Monsoon period</b>	<b>"A" Class &amp; Above and Special in Building Construction</b>

2. Prospective / Interested bidder may download the Bid Documents from website <https://www.tender.nprocure.com> free of cost till the Time and Date as mentioned on online NIT at website [https:// www.tender.nprocure.com](https://www.tender.nprocure.com)

3. However, Bidder who is submitting the Bid Online will have to pay the Bid Document Fee / Tender Fee through Demand Draft only of any Schedule Bank payable at **BHAVNAGAR, DIST: BHAVNAGAR** and in favour of **EXECUTIVE ENGINEER, BHAVNAGAR MUNICIPAL CORPORATION** Once the Bid is received online, Bid Document / Tender Fee will not be refundable. As Per GoG R&B Department's Circular No. PARACH/102/000/IB/221/ (59)/C Dated. 24/01/2007

The Demand Draft for Bid Document / Tender fee and FDR / Bank Guarantee against Bid Security / EMD shall be submitted in electronic format through online (by scanning) while uploading the bid, this submission shall mean that bid document / tender fee and Bid Security / EMD has been received. Accordingly, the offer of only those shall be opened whose Bid Document / Tender Fee and Bid Security / EMD have been received electronically. However, for the purpose of realization of Demand Draft, and FDR / Bank Guarantee bidder shall send the same in original through R.P.A.D. so as to reach to #'**EXECUTIVE ENGINEER, BHAVNAGAR MUNICIPAL CORPORATION**, within 7 Days from the last day of bid submission.

Penetrative action for not submitting Demand Draft / FDR / Bank Guarantee in original to EXECUTIVE ENGINEER / Tender Inviting Authority by bidder shall be initiated. **WRD GR No. PRC-102014-1-MI Cell-K.1 Dated: 29/10/2014**

4. Bids received online, will be opened on the time, date and place as specified in the online NIT at website [www.tender.nprocure.com](http://www.tender.nprocure.com) in the presence of the bidders or their authorized representatives, who wish to remain present.

If the office happens to be closed on the day of opening of the bids as specified, the bids will be opened on the next working day at the same time and venue.

5. ~~As pre bid meeting will be held on /02/2024 at 11.30 hrs. at the office of the EXECUTIVE ENGINEER, BHAVNAGAR MUNICIPAL CORPORATION~~ to clarify the issues and to answer questions on any matter that may be raised at that stage as stated in clause 9.2 of 'instructions to Bidders' of the bidding documents.

6. Bid Security (EMD) is equal to 1% of Estimated Amount put to bid / tender and should be rounded off to the next thousand rupees.

7. Other Information is as under:

A. Agencies can prepare and edit their offers a number of times before the end of the tender submission date and time. After the tender submission date and time, the bidder cannot



modify / edit / withdraw their submitted offer in any case. No written or online request in this regard shall be granted.

- B. Offers in physical form will not be accepted in any case.
- C. Demand Draft purchased by the other than bidder and issued after the last date of submission of Bids, will not be considered or accepted.
- D. The cost incurred by the contractor for this offer for clarification or attending discussion, conferences or site visits will not be reimbursed by the Employer or Engineer-in-Charge.
- E. Conditional tender shall not be accepted.
- F. Any changes, addition, alternation made in the prescribed form attached with tender are liable to be rejected.
- G. Any change in format or conditional Bank Guarantee will not be accepted and the bidder will be considered non-responsive.
- H. All the bidders are instructed to fill in information strictly in accordance with the format given in the checklist / qualification document / tender document.
- I. It is mandatory for the bidders to supply each and every information as asked strictly in electronic format at appropriate places only.
- J. Blank / insufficient information shall be treated as nil information and shall result in disqualification.
- K. Even if the bidder has been qualified in a similar or larger size of project in the past, it shall not be deemed to be a ground / reason for not giving required information for this work / bid.
- L. Information supplied for earlier projects shall not be considered while evaluation of this bid. The Government will not ask for any other information, unless it is found absolutely necessary by the competent authority.
- M. If found necessary, the contractor will be intimated for negotiation,

**# For the works costing up to Rs. 7.5 crore (WRD Works), Rs. 7.0 crore (ROAD/ BRIDGE/ BUILDING WORKS), Rs. 0.5 Crore (Electrical Works) kindly refer to GoG NWRWS&K Department's Circular No. Paracha/1097/1397(11)/pa.fa./ MICELL(k-1) dated 18/01/2018 and Dated 30/09/2022**

For the works costing under Rs. 7.5 crore for Construction work of Water Resources Department, Rs. 7.0 crore for Roads, Bridges and Building and Rs. 050 crore for Electrical work following documents shall be submitted in electronic format only through online by scanning and the (i) Bid Document Fee / Tender Fee (ii) Bid Security / EMD should be sent in original to the Tender opening authority through RPAD, so as to reach the EXECUTIVE ENGINEER within 7 days from last day of submission of Bid.

- (i) Scanned copy of Bid Document Fee / Tender Fee
- (ii) Scanned copy of Bid Security / EMD ~~or Valid EMD Exemption Certificate of Appropriate Class of Registration of Approved Contractors~~
- (iii) Registration Certificate of Appropriate Class
- ~~(iv) Registration Certificate of special category – Building and Category I / II / III, If Required~~
- (v) GST Number and Pan card.
- (vi) Work Experience, if necessary .....
- (vii) Other Documents, as per P.Q. required ...

**SECTION - 1**  
**INSTRUCTIONS TO BIDDERS**  
**(ITB)**

## Section 1: Instructions to Bidders

(i)

### Table of Clauses

	Page No.		Page No.
<b>A. General</b>		<b>D. Submission of Bids</b>	
1. Scope of Bid	8	19. Sealing & Marking of Bids	18
2. Source of Funds	8	20. Deadline for Submission of Bids	18
3. Eligible Bidders	8	21. Late Bids	18
4. Qualification of the Bidder	8	22. Modification and Withdrawal of Bids	18
5. One Bid per Bidder	12		
6. Cost of Bidding	12	<b>E. Bid Opening and Evaluation</b>	
7. Site Visit	12	23. Bid Opening	19
		24. Process to be Confidential	20
<b>B. Bidding Documents</b>		25. Clarification of Financial Bids	20
8. Content of Bidding Documents	13	26. Examination of Bids and Determination of Responsiveness	20
9. Clarification of Bidding Documents	13	27. Correction of Errors	20
10. Amendment of Bidding Documents	14	28. Deleted	21
		29. Evaluation and Comparison of Financial Bids	21
<b>C. Preparation of Bids</b>		30. Deleted	21
11. Language of Bid	15		
12. Documents Comprising the Bid	15	<b>F. Award of Contract</b>	
13. Bid Prices	15	31. Award Criteria	22
14. Currencies of Bid and Payment	16	32. Employer's Right to Accept any Bid and to Reject any or all Bids	22
15. Bid Validity	16	33. Notification of Award and Signing of Agreement	22
16. Bid Security	16	34. Performance Security	22
17. Alternative Proposals by Bidders	17	35. Advance Payment and Security	23
18. Format and Signing of Bid	17	36. Dispute Review Expert	23
		37. Correct or Fraudulent Practices	23

## A. GENERAL

### 1. **Scope of Bid**

- 1.1 The Employer (Named in Appendix to ITB) invites bids for the Construction of works (as defined in these documents and referred to as 'the works') detailed in the table given in IFB. The bidders may submit bids for any or all of the works detailed in the table given in IFB.
- 1.2 The successful bidder will be expected to complete the works by the intended completion date specified in the Contract data.
- 1.3 Throughout these bidding documents, the terms 'bid' and 'tender' and their derivatives (bidder/ tenderer, bid / tender, bidding/ tendering, etc.) are synonymous.

### 2. **Source of Funds**

- 2.1 The expenditure on this project will be met from the budget of Govt. of Gujarat / Govt. of India for centrally sponsored projects.

### 3. **Eligible Bidders**

- 3.1 This Invitation for Bids is open to all eligible bidders.
- 3.2 All bidders shall provide in Section 2, Forms of Bid and Qualification Information, a statement that the Bidder is neither associated, nor has been associated, directly or indirectly, with the consultant or any other entity that has prepared the design, specifications, and other documents for the Project or being proposed as Project Manager for the Contract. A firm that has been engaged by the Employer to provide consulting services for the preparation or supervision of the works, and any of its affiliates, shall not be eligible to bid.

### ~~4. **Qualification of the Bidder**~~

- ~~4.1 All bidders shall provide in Section 2, Forms of Bid and Qualification Information, a preliminary description of the proposed work method and schedule, including drawings and charts, as necessary. The proposed methodology should include a program of construction backed with equipment planning and deployment duly supported with broad calculations and quality assurance procedures proposed to be adopted justifying their capability of execution and completion of work as per technical specifications, within stipulated period of completion.~~

4.2 Deleted

4.3 Deleted

4.4 Deleted

### **4.5 QUALIFICATION CRITERIA:**

**(Applicable for the works which require Pre-Qualification) As Per GoG NWRWS & K Department's Circular No. Paracha/1097/1397(11)/pa.fa./MICELL(k-1) Dated 18/01/2018**

- 4.5.1 Qualification will be based on Applicant's meeting all the following minimum pass/fail criteria regarding the Applicant's general and particular experience, personnel and equipment capabilities and financial positions, as demonstrated by the applicant's responses in the forms attached to the letter of application ( specified requirement for joint ventures are given under para 4.6 below ) Subcontractors experience and resources shall not be taken in to account in determining the applicants compliance with the qualifying criteria

To qualify for more than one contract, the applicant must demonstrate having experience and resources sufficient to meet the aggregate of the qualification criteria for each contract given in paragraphs 4.5.4, 4.5.5 and 4.5.9 below

#### 4.5.2 Base year and Escalation

The base year shall be taken as Current financial year

Following enhancement factors will be used for the costs of works executed and the financial figure to a common base value for works completed in India.

<u>Year</u>	<u>Financial Year</u>	<u>Multiplying factor</u>
Base year of inviting tender	2023-2024	1.00
-1	2022-2023	1.10
-2	2021-2022	1.21
-3	2020-2021	1.33
-4	2019-2020	1.46
-5	2018-2019	1.61

Applicant should indicate actual figures of costs and amount for the works executed by them without accounting for the above-mentioned factors.

In case the financial figures and value of completed works are in foreign currency the above enhanced multiplying factors will not be applied. Instead, the current market exchange rate (State Bank of India BC Selling rate as on the last date of submission of the bid) will be applied for the purpose of conversion of the amount in foreign currency into India rupees.

#### 4.5.3. General Experience.

The Applicant shall meet with the following minimum criteria:

- (a) Achieved a minimum annual financial turnover (defined as billing for works in progress and completed in all classes of civil engineering Construction works only) in any one year, over the last five years of the annual value of Contract/Contract applied for
- ~~(b) Experience in successfully completing or substantially completing at least one contract of similar work (Road works) of at least 40 percent of the value of proposed contract within the last five financial years.~~

~~The works may have been executed by the applicant as prime contractor or as a member of a joint venture or as a nominated sub-contractor. As subcontractor, he should have acquired the experience of execution of all major items of works under the proposed contract. In case a project has been executed by a joint venture, weight towards experience of the project would be given to each joint venture in proportion to their financial participation in the joint venture if work executed jointly otherwise as per the scope of work define in Joint Venture agreement.~~

~~Substantially completed works means those works which are at least 90 % completed as on the date of submission (i.e. gross value of work done up to the last date of submission is 90 % or more of the original contract price) and continuing satisfactorily.~~

~~For these, a certificate from the employers shall be submitted along with the application incorporating clearly the name of the work, contract value, billing amount, date of commencement of works, satisfactory performance of the contractor and any other relevant information.~~

~~(the experience certificate should be signed by the officer not below the rank of EE)~~

- (c) Contractor should have completed 60% of quantity of principal items of work like

concrete, earthwork, masonry, etc. within last five financial years. Certificate of competent authority of work done with detail shall be produced.

#### **4.5.4. Personnel Capabilities.**

Availability for his work of personnel with adequate experience as required; as per Appendix.

#### **4.5.5. Equipment Capabilities**

Based on the studies carried out by the Engineer, the minimum suggested major equipment to attain the completion of works in accordance with the prescribed construction schedule are shown in the Appendix.

The bidders should, however, undertake their own studies and furnish with their bid, a detailed construction planning and methodology supported with layout and necessary drawings and calculations to allow the employer to review their proposals. The numbers, types and capacities of each plant/equipment shall be shown in the proposals along with the cycle time for each operation for the given production capacity to match the requirements.

#### **4.5.6. Financial Position**

The Applicant should give undertaking that he has access to, or has available, liquid assets (aggregate of working capital, cash in hand and uncommitted bank guarantees) and / or credit facilities at least 25 percent of the value of the contract / contracts applied.

**4.5.7.** The audited balance sheets for the last five years should be submitted, which must demonstrate the soundness of the applicant's financial position, showing long - term profitability including an estimated financial projection for the next two years, if necessary, the employer will make inquiries with the applicant's bankers.

#### **4.5.8. Litigation History**

The Applicant should provide accurate information on any litigation or arbitration resulting from contracts completed or under execution by him over the last five financial years. A consistent history of awards against the Applicant or any partner of a joint venture may result in failure of the applicant.

#### **4.5.9. Disqualification**

Even though the applicants meet the above criteria, they are subject to be disqualified if they have:

Made misleading or false representation in the forms, statements submitted, and / or Record of poor performance such as abandoning the work, rescinding of contract for which the reasons are attributable to the non - performance of the contractor; consistent history of litigation awarded against the applicant or financial failure due to bankruptcy. The rescinding of contract of a joint venture on account of reasons other than non - performance, such as Most Experienced partner of joint venture pulling out, court directions leading to breaking up of a joint venture before the start of work, which are not attributable to the poor performance of the contractor will, however, not affect the qualification of the individual partners.

#### **#4.6 — JOINT VENTURE: (Maximum 3 Members i.e. 1 Lead & 2 Others) (Applicable only for estimated project cost of 50 Crore and above)**

**4.6.1.** — Joint ventures must comply with the following requirement:

(a) — Following are the minimum qualification requirements:

(i) — ~~The lead partner shall meet not less than 50 percent of all criteria given in para 4.5.3 & 4.5.6 above. The joint venture must collectively satisfy the criteria of para 4.5.3 & 4.5.6 above. The experience of the other joint venture partners shall be considered if it is not less than 30 percent of the qualifying criteria in para 4.5.3 &~~

4.5.6 above.

- (ii) ~~Individually each member must satisfy the requirements of para 4.5.7 & 4.5.8 above.~~
- (b) ~~Bid shall be signed so as to legally bind all partners, jointly and severally, and shall be submitted with a copy of the joint venture agreement providing the joint and several liabilities with respect to the contract.~~

~~4.6.2. Qualification of a joint venture does not necessarily qualify any of its partners individually or as a partner in any other joint venture. In case dissolution of a joint venture, each one of the constituent firms may qualify if they meet all the qualification requirements, subject to the written approval of the Employer.~~

**4.7. Bid Capacity.**

~~Applicants who meet the minimum qualification criteria will be qualified only if their available bid capacity at the expected time of bidding is more than the total estimated cost of the works. The available bid capacity will be calculated as under:~~

~~**Assessed Available Bid Capacity = (A\*N\*2-B), where**~~

~~A = Maximum value of work executed in any one year during the last five years (updated to the price level of the year indicated in appendix) taking into account the completed as well as works in Progress.~~

~~B = Value at current price level of the existing commitments and ongoing works to be completed during the next 1 Years (period of completion of work for which bids are invited); and~~

~~N = Number of years prescribed for completion of the works for which the bids are invited.~~

~~**Note: - In Case of joint venture, the available bid capacity will be applied for each partner to the extent of his proposed participation in the execution of the work.**~~

**4.8 Even though the bidders meet the above qualifying criteria, they are subject to be disqualified if they have:**

- Made misleading or false representation in the forms, statements and Attachments the submitted in proof the qualification requirements; and / or
- Record of poor performance such as abandoning the works, not properly completing the contract, inordinate delay in completion, litigation history, or financial failures etc.; and/ or
- Participated in the previous bidding for the same work and had quoted unreasonably high bid prices and could not furnish rational justification to the employer.

**5. One bid per bidder**

5.1. Each bidder shall submit only one bid for one package. A bidder who submits or participates in more than one bid (other than as a subcontractor or in cases of alternatives that have been permitted or requested) will cause all the proposals with the bidder's participation to be disqualified.

**6. Cost of Bidding**

6.1. The bidder shall bear all costs associated with the preparation and submission of his Bid, and the Employer will in no case be responsible and liable for those costs.

**7. Site Visit**

- 7.1. The Bidder, at the Bidder's own responsibility and risk is encouraged to visit and examine the Site of work and its surrounding and obtain all information that may be necessary for preparing the Bid and entering into a contract for construction of the Works.  
The costs of visiting the site shall be at the Bidder's own expense.



## B. BIDDING DOCUMENTS

### 8. Content of Bidding Documents

- 8.1 The set of bidding documents comprises the documents listed below and addenda issued in accordance with Clause 10:

Section	Particulars	Volume No.
-	Invitation for Bids	I
1	Instructions to Bidders	
2	Qualification Information, and other forms	
3	Conditions of Contract	
4	Contract Data	
5	Technical Specifications	II
6	Form of Bid	III
7	Bill of Quantities	
8	Securities and other forms	
9	Drawings	IV
10	Documents to be furnished by bidder	V

- 8.2. Volumes I, II, III and IV are available online and documents to be furnished by the bidder in compliance to section 2 will be prepared by him and furnished as Volume- V in two parts (refer clause 12).
- 8.3. The bidder is expected to examine carefully all instructions, conditions of contract, contract data, forms, terms, technical specifications, bill of quantities, forms, Annexes and drawings in the Bid Document. Failure to comply with the requirements of Bid Documents shall be at the bidder's own risk. **Pursuant to clause 26 hereof**, bids which are not substantially responsive to the requirements of the Bid Documents shall be rejected.

### 9. Clarification Bidding Documents

- 9.1 A prospective bidder requiring any clarification of the bidding documents may notify the Employer in writing or through E-mail at the Employer's address indicated in the invitation to bid. The Employer will respond to any request for clarification which he received earlier than 15 days prior to the deadline for submission of bids. Employer's response will be published on website including a description of the enquiry but without identifying its source.

#### 9.2. Pre-bid meeting

- 9.2.1. The bidder or his official representative is invited to attend a pre-bid meeting which will take place at the address, venue, time and date as indicated in the appendix.

- 9.2.2. The purpose of the meeting will be to clarify issues and to answer questions on any matter that may be raised at that stage.
- 9.2.3. The bidder shall be required to submit any questions in writing or e-mail to reach the Employer not later than 03 days before the meeting.
- 9.2.4. Minutes of the meeting, including the question raised (Without identifying the source of enquiry) and the responses given will be published without delay on the tender website i.e. [www.tender.nprocure.com](http://www.tender.nprocure.com). Any modification of the bidding documents listed in sub-Clause 8.1 which may become necessary as a result of the pre-bid meeting shall be made by the Employer exclusively through the issue of an Addendum pursuant to Clause 10 and not through the minutes of the pre-bid meeting.
- 9.2.5. Non-attendance at the pre-bid meeting will not be a cause for disqualification of a bidder.

#### **10. Amendment of Bidding Documents**

- 10.1 Before the deadline for submission of bids, the Employer may modify the bidding documents by issuing addenda.
- 10.2. Any addendum thus issued shall be part of the bidding documents. The Employer will assume no responsibility for the same.
- 10.3. To give prospective bidders reasonable time in which to take an addendum into account in preparing their bids, the Employer may, at his discretion, extend as necessary the deadline for submission of bids, in accordance with Sub-Clause 20.2 below.

## C. PREPARATION OF BIDS

### 11. Language of the Bid

11.1 All documents relating to the bid shall be in the English language.

### 12. Documents Comprising the Bid

12.1. The bid be submitted by the bidder as Volume V of the bid document (refer Clause 8.1) shall be in two separate parts:

**Part I shall be named "Technical Bid" and shall comprise**

- (i) Bid Security in the form specified in Section 8
- (ii) Qualification Information and supporting documents as specified in Section 2
- (iii) Certificates, undertakings, affidavits as specified in Section 2
- (iv) Any other information pursuant to Clause 4.5 of these instructions
- (v) Undertaking that the bid shall remain valid for the period specified in Clause 15.1

**Part II shall be named "Financial Bid" and shall comprise**

- (i) Form of Bid as specified in Section 6
- (ii) Priced Bill of Quantities for items specified in Section 7

12.2. The Bidder shall submit the details / information pertaining to each part i.e. technical as well as financial and must be submitted online only.

12.3. Following documents will be deemed to be part of the bid.

Section	Particulars	Volume No.
	<b>Invitation for Bids (IFB)</b>	
1	Instruction to Bidders	Volume I
3	Conditions of Contract	
4	Contract Data	
5	Specifications	Volume II
9	Drawings	Volume IV

### 13. Bid Prices

13.1 The Contract shall be for the whole works as described in Sub-Clause 1.1, based on the priced Bill of Quantities submitted by the Bidder.

13.2 The bidder shall fill in rates and prices and line-item total (both in figures and words) for all items of the Works described in the Bill of Quantities along with total bid price (Both in figures and words). Items for which no rate or price is entered by the bidder will not be paid for by the Bill of Quantities.

13.3 All duties, taxes, and other levies except GST payable by the contractor under the contract, or for any other cause shall be included in the rates, prices and total Bid Price submitted by the Bidder. (GST will be paid extra)

13.4 Deleted

~~13.5 The rates and prices quoted by the bidder are subject to adjustment during the performance of the Contract in accordance with the provisions of Clause 47 of the Condition of Contract (Irrespective of the time limit and Bid Amount)~~

#### **14. Currencies of Bid and Payment**

14.1 The unit rates and the prices quoted by the bidder shall be entirely in Indian Rupees. All payments shall be made in Indian Rupees.

#### **15. Bid Validity**

15.1 Bids shall remain valid for a period of not less than 120 days after the deadline date for bid submission specified in Clause 20.

15.2 In exceptional circumstances, prior to expiry of the original time limit, the Employer may request that the bidders may extend the period of validity for a specified period. A bidder may refuse the request without forfeiting his bid security. A bidder agreeing to the request will not be required or permitted to modify his bid, but will be required to extend the validity of his security for a period of the extension, and in compliance with Clause 16 in all respects.

#### **16. Bid Security**

16.1. The Bidder shall furnish, as part of his Bid, a Bid security in the amount as shown in column 4 of the table of IFB for this particular work. This Bid security shall be in Favor of Employer as named in Appendix and may be in one of the following forms;

a. Bank Guarantee from any scheduled Indian bank, in the format given in Volume III. **(Bank Guarantee is applicable only for Bid Estimated Amount of 01 Crore and above) and Bank** Guarantee of Schedule and Private Banks shall be considered as per GoG Finance Department's Circular No. FD/MSM/e- file/4/2023/0057/D.M.O. Date 21/04/2023 or as per their latest amendment.

b. Fixed Deposit Receipt issued by any Scheduled Indian Bank or a foreign Bank approved by the Reserve Bank of India.

#### **OR**

# A Valid Bid Security / EMD Exemption Certificate issued by (1) Road & Building Department or (2) Narmada Water Resources, Water Supply and Kalpsar Department of Govt of Gujarat. **Exemption Certificate is applicable only when Registration Certificate of Appropriate Class and Category of Approved Contractors is required as eligible criteria of bidder.**

16.2. Bank guarantees (and other instruments having fixed validity) issued as surety for the bid shall be valid for 45 days beyond the validity of the bid i.e. total validity of 120+45 = 165 Days

16.3. Any bid not accompanied by an acceptable Bid Security and not secured as indicated in Sub-Clauses 16.1 and 16.2 above shall be rejected by the Employer as non-responsive.

16.4. The Bid Security of unsuccessful bidders will be returned within 28 days of the end of the bid validity period specified in Sub-Clause 15.1

16.5 The Bid Security of the successful bidder will be discharged when the bidder has signed the Agreement and furnished the required Performance Security.

16.6. The bid Security may be forfeited

(a) If the Bidder withdraws the bid after Bid opening during the period of Bid validity.

(b) If the Bidder does not accept the correction of the Bid Price, if any or

(c) In the case of a successful Bidders, if the Bidder fails the specified time limit to

(i) Sign the Agreement; or

- (ii) Furnish the requirement Performance Security.
- (d) #If found necessary, the bidder will be intimated for negotiation, He will be intimated maximum three times within the validity period for negotiation, If contractor does not respond in time, his Bid Security (EMD) will be forfeited and his tender will be rejected. Punitive action will be taken on such contractors. (As per GoG R&B Dept's Gr. No. S/22/2017/639/D, Dt.08/06/2018)

**17. Alternative Proposals by Bidders.**

- 17.1. Bidders shall submit offers that fully comply with the requirements of the bidding documents, including the conditions of contract (including mobilization advance or time for completion), basic technical design as indicated in the drawing and specifications. Conditional offers or alternative offers will not be considered further in the process of tender evaluation.

**18. Format and Signing of Bid**

- 18.1. The Bidder shall prepare documents comprising the bid as described in Clause 12 of these Instructions to bidder as the "Technical Bid "and "Financial Bid" in separate parts to be uploaded.

## **D. SUBMISSION OF BIDS**

**19. Deleted**

**20. Deadline for Submission of the Bids**

20.1. Complete Bids must be received online by the Employer at the tender website specified above not later than the date indicated in appendix.

20.2. The Employer may extend the deadline for submission of bids by issuing an amendment in accordance with Clause 10, in which case all right and obligation of the Employer and the bidders previously subject to the original deadline will then be subject to the new deadline.

**21. Deleted**

**22. Modification and Withdrawal of Bids**

22.1. Bidders may modify or withdraw their bids online before the deadline prescribed in Clause 20 or pursuant to Clause 23.

22.2 Deleted

22.3. No bid shall be modified or withdrawn after the deadline for submission of Bid.

22.4. Withdrawal or modification of a bid between the deadline for submission of bids and the expiration of the original period of bid validity specified in Clause 15.1 above or as extended pursuant to Clause 15.2 may result in the forfeiture of the Bid security pursuant to Clause 16.

## **E. BID OPENING AND EVALUATION**

### **23. Bid Opening**

- 23.1 The Employer will open all the Bids received including modifications made pursuant to Clause 22, in the presence of the Bidders or their representatives who choose to attend at time, date and the place specified in Appendix in the manner specified in Clauses 20 and 23.3, In the event of the specified date of Bid opening being declared a holiday for the Employer, the Bids will be opened at the appointed time and location on the next working day.
- 23.2. Deleted.
- 23.3. The “Technical Bid” shall be opened. The amount, form and validity of the bid security furnished with each bid will be announced. If the bid security furnished does not conform to the amount and validity period as specified in the invitation for bid (ref. Column 4 and paragraph 3), and has not been furnished in the form specified in Clause 16, the technical bid will not be opened.
- 23.4. (i) Subject to confirmation of the bid security by the issuing Bank, the bids accompanied with valid bid security will be taken up for evaluation with respect to the Qualification information and other information furnished in part I of the bid pursuant to Clause 12.1.
- (ii) If required, the bidder will be asked in writing to clarify his Qualification Documents with respect to any required clarification.
- (iii) The bidders will respond in not more than 7 days of issue of the clarification letter.
- (iv) Immediately (usually within 3 or 4 days), on receipt of these clarification the Evaluation Committee will finalize the list of responsive bidders whose financial bids are eligible for consideration.
- 23.5. Deleted
- 23.6 At the time of opening of “Financial Bid”, the names of the bidders were found responsive in accordance with Clause 23.4(iv) will be announced. The bids of only these bidders will be opened. The responsive Bidders’ names, the Bid prices, the total amount of each bid, any discount and such other details as the Employer may consider appropriate, will be announced by the Employer at the opening.
- 23.7 the time of opening of “Financial Bid”, the names of the bidders were found responsive in accordance with Clause 23.4(iv) will be announced. The bids of only these bidders will be opened. The responsive Bidders’ names, the Bid prices, the total amount of each bid, any discount, and such other details as the Employer may consider appropriate, will be announced by the Employer at the opening.
- 23.8 In case bids are invited for more than one package, the order for opening of the “Financial Bid” shall be in order of Estimated number of Bids from highest to lowest.
- 23.9 The Employer shall prepare minutes of the Bid opening, including the information disclosed to those present in accordance with Sub-Clause 23.6.

**24 Process to be Confidential**

24.1 Information relating to the examination, clarification, evaluation, and comparison of Bids and recommendations for the award of a contract shall not be disclosed to Bidders or any other persons not officially concerned with such process until the award to the successful Bidder has been announced. Any effort by Bidder to influence the Employer's processing of Bids or award decisions may result in the rejection of his Bid.

**25. Clarification of Financial Bids**

25.1. To assist in the examination, evaluation, and comparison of Bids, the Employer may, at his discretion, ask any Bidder for clarification of his Bid, including breakdowns of unit rates. The request for clarification and the response shall be in writing or by e-mail, but no change in the price or substances of the Bid shall be sought, offered, or permitted except as required to confirm the correction of arithmetic errors discovered by the Employer in the evaluation of the Bids.

25.2 Subject to sub-clause 25.1, no Bidder shall contact the Employer on any matter relating to his Bid opening to the contract is awarded. If the Bidder wishes to bring additional information to the notice of the Employer, it should do so in writing.

25.3. Any effort by the Bidder to influence the Employer in the Employer's bid evaluation, bid comparison or contract award decision may result in the rejection of the Bidders' bid.

**26. Examinations of Bids and Determination of Responsiveness**

26.1 During the detail evaluation of "Technical Bid", the Employer will determine whether each Bid (a) meets the eligibility criteria defined in Clause 3 and 4; (b) has been properly signed; (c) is accompanied by the required securities and; (d) is substantially responsive to the requirements of the Bidding document. During the detailed evaluation of the "Financial Bid", the responsiveness of the bids will be further determined with respect to the remaining bid conditions, i.e., priced bill of quantities, technical specifications, and drawings.

26.2 A substantially responsive "Financial Bid" is one which confirms all the terms, conditions and specifications of bidding documents, without material deviation or reservation. A material deviation or reservation is one (a) which affects in any substantial way the scope, quality, or performance of the Works; (b) which limits in any substantial way, inconsistent with the Bidding documents, the Employer's rights or the Bidder's obligations under the Contract; or (c) whose rectification would affect unfairly the competitive position of other Bidders presenting substantially responsive Bids.

26.3 If a "Financial Bid" is not substantially responsive, it will be rejected by the Employer, and may not subsequently be made responsive by correction or withdrawal of the non-conforming deviation or reservation.

**27. Deleted**



**28. Deleted**

**29. Evaluation and Comparison of Financial Bids**

29.1. The Employer will evaluate and compare only the Bids determined to be substantially responsive in accordance with Sub-Clause 26.2.

29.2. Deleted.

29.3. The Employer reserves the right to accept or reject any variation or deviation. Variation and deviations and other factors, which are in excess of the requirements of the Bidding documents or otherwise result in unsolicited benefits for the Employer, shall not be taken in to account in Bid evaluation.

~~29.4. The estimated effect of the price adjustment conditions under Clause 47 of the Conditions of Contract, during the period of implementation of the Contract, will not be taken in to account in Bid evaluation.~~

29.5. If the Bid of the successful Bidder is seriously unbalanced in relation to the Engineer's estimate of the cost of work to be performed under the contract the Employer may require the Bidder to produce detailed consistency of those prices with the construction methods and schedule proposed. After evaluation of the price analyses, the Employer may require that the amount of the performance security set forth in Clause 34 be increased at the expense of the successful /bidder to a level sufficient to protect the Employer against financial loss in the event of default of the successful Bidder under the Contract.

29.6. A bid which contains several items in the bill of Quantities which are unrealistically priced low and which cannot be substantiated satisfactorily by the bidder may be rejected as non-responsive.

**30. Deleted**

## F. AWARD OF CONTRACT

### 31. Award Criteria

31.1. Subject to Clause 32, the Employer will award the contract to the Bidder whose Bid has been determined.

- (i) to be substantially responsive to the Bidding documents and who has offered the lowest evaluated Bid Price; and
- (ii) to be within the available bid capacity adjusted to account for his bid price which is the lowest evaluation in any of the packages opened earlier than the one consideration.

In no case, the contract shall be awarded to any bidder whose available bid capacity is less than the evaluated bid price, even if the said bid is the lowest evaluated bid. The contract will in such cases be awarded to the next lowest bidder at his evaluation bid price.

### 32. Employer's Right to Accept any Bid and to Reject any or all Bids

32.1. Notwithstanding Clause 31, the Employer reserves the right to accept or reject any Bid, and to cancel the Bidding process and reject all Bids, at any time prior to the award of contract, without thereby incurring any liability to the affected bidder or Bidder or any obligation to inform the affected Bidder or Bidders of the grounds for the Employer's action.

### 33. Notification of Award and Signing of Agreement

33.1. The Bidder whose Bid has been accepted will be notified of the award by the Employer prior to expiration of the Bid validity period by cable, telex or facsimile confirmed by registered letter. This letter (hereinafter and in the condition of contract called the "Letter of Acceptance") will state the sum that the Employer will pay the Contractor in consideration of the execution, completion, and maintenance of the Works by the Contractor as prescribed by the Contract (hereinafter and in the Contract called the "Contract Price").

33.2. The notification of award will constitute the formation of the contract, subject only to the furnishing of a performance security in accordance with the provisions of Clause.

33.3. The Agreement will incorporate all agreements between the Employer and the successful Bidder. It will be signed by the Employer and to the successful Bidder, within 28 days following the notification of award along with the Letter of Acceptance. Within 21 days of receipt, the successful Bidder will sign the Agreement and deliver it to the Employer.

33.4. Upon the furnishing by the successful Bidder of the Performance Security, the Employer will promptly notify the other Bidders that their Bids have been unsuccessful.

### 34. Security Deposit:

#### A. (Total 5.0% of contract value, this will be deposited as under)

- i. Initial S. D. @ 2.50% of contract value: 2.50 % of contract  
(Not less than EMD) in cash or in the value.  
Form of pay order / DD / FDR / Bank  
Guarantee (From the Nationalized Bank  
encashable at BHAVNAGAR Only)
- ii. To be deducted from current bills at: 2.50 % of contract  
10.00% to build up remaining 2.50% value.  
Of SD value

**Total Deposit at 5.00% of contract: 5.00 % of contract value value**

**B. Performance Guarantee**

Performance Guarantee @ 5.00% of actual work amount in form of F.D.R. of Nationalized or Scheduled bank / N.S.C. / Narmada Bond pledged in Favor of Commissioner, Municipal Corporation, Bhavnagar. (To be submitted on completion of work & before final bill payment) Performance guarantee will be released after defect liability period is over.

**34. Performance Security**

~~34.1. (A) Within 10 (Ten) days of receipt of Letter of Acceptance, the successful Bidder shall furnish to the Employer an irrevocable and unconditional guarantee from a Bank in the form set forth in Section 8 (the "Performance Security") for an amount equal to 5% (five percent) of its Contract Price. In case of bids mentioned below, the successful Bidder, along with the Performance Security, shall also furnish to the Authority an irrevocable and unconditional guarantee from a Bank in the same form given at Section 8 towards an Additional Performance Security (The "Additional Performance Security") for an amount calculated as under:~~

~~(a) If the Contract Price offered by the Selected Bidder is lower than 10% but up to 20% of the Estimated Project Cost, then the Additional Performance Security shall be calculated @ 20% of the difference in the (i) Estimated Project Cost (as mentioned in Bid Document) Minus 10% of the Estimated Project Cost and (ii) Contract Price offered by the selected Bidder.~~

~~(b) If the Contract Price offered by the Selected Bidder is lower than 20% of the Estimated Project Cost, then the Additional Performance Security shall be calculated @ 30% of the difference in the (i) Estimated Project Cost (as mentioned in Bid Document) Minus 10% of the Estimated Project Cost and (ii) Contract Price offered by the selected Bidder.~~

~~(c) This Additional Performance Security shall be treated as part of the Performance Security.~~

~~(B) The Performance Security shall be valid beyond 60(sixty) days of the Defects Liability Period and the Additional Performance Security shall be valid beyond 28 (twenty-eight) days of Project Completion Date.~~

~~34.2. If the performance security is provided by the successful Bidder in the form of a Bank Guarantee, it shall be issued either (a) at the Bidder's option, by a Nationalized/Scheduled Indian bank or (b) by a foreign bank located in India and acceptable to the Employer. As per GoG Finance Department's Circular No. FD/MSM/e file/4/2023/0057/D.M.O. Date 21/04/2023 or as per their latest amendment.~~

~~34.3. Failure of the successful Bidder to comply with the requirement of Sub-Clause 34.1 shall constitute sufficient grounds for cancellation of the award and forfeiture of the Bid Security.~~

**35 Advance Payment and Security**

35.1 The Employer will provide an Advance payment on the Contract Price as stipulated in the Conditions of Contract, subject to maximum amount, as stated in the Contract Data.

**36. Deleted**

**37. Corrupt or Fraudulent Practices**

37.1 The Employer will reject a proposal if it determines that the Bidder recommended for award has engaged in corrupt or fraudulent practices in completing for the

contract in question and will declare the firm ineligible, either indefinitely or for a stated period of time, to be awarded a contract with National Highways Authority of India/ State PWD and any other agencies, if it at any time determines that the firm has engaged in corrupt or fraudulent practices in completing for the contractor, or in execution.

37.2 Furthermore, Bidders shall be aware of the provision stated in Sub- Clause 59.2 of the Conditions of Contract.

## APPENDIX TO ITB

### Clause Reference

### With respect to

### Section -I

1.	The Name of the Employer is <b>EXECUTIVE ENGINEER, BHAVNAGAR MUNICIPAL CORPORATION</b>	[ Cl.1.1]
2.	The last five financial years.	
1.	<b>2022-2023</b>	
2.	<b>2021-2022</b>	
3.	<b>2020-2021</b>	
4.	<b>2019-2020</b>	
5.	<b>2018-2019</b>	
3.	This Annual Financial Turnover Amount is Rs. --	[Cl.4.5.3 (a)]
4.	Value of Work is <b>Rs. 68855313.00/- (Excl. of GST)</b>	
5.	Deleted	
6.	The cost of electric work is Rs. <b>Rs. 68855313.00/- (Excl. of GST)</b>	
7.	The cost of water supply / sanitary works is Rs. 0.00/-	
8.	Liquid assets and / or availability of credit facilities is Rs. --	[Cl.4.5.6]
9.	Price level of the financial year <b>2023-24</b>	[Cl. 4.5.2]
10.	The pre-bid meeting will take place at	[Cl. 9.2.1]
11.	The technical Bid will be opened at the office of the <b>EXECUTIVE ENGINEER, BHAVNAGAR MUNICIPAL CORPORATION</b> ..... AM/PM AS PER NIT	
12.	Address of the Employer: <b>EXECUTIVE ENGINEER, BHAVNAGAR MUNICIPAL CORPORATION</b> <b>Email id-</b> building.bmcgujarat@gmail.com	
13.	Deleted	
14.	The bid should be submitted latest by as stated on online NIT	[Cl. 20.1 & 20.2]
15.	The bid will be opened at as stated on online NIT at website <a href="https://www.tender.nprocure.com">https:// www.tender.nprocure.com</a>	[Cl. 23.1]
16.	The Bank Draft in Favor of " <del><b>EXECUTIVE ENGINEER, BHAVNAGAR MUNICIPAL CORPORATION</b></del> "	
17.	Deleted	
18.	Escalation factors (for the cost of works executed and financial figure to a common base value) for works completed	[Cl.4.5.2]

<u>Year</u>	<u>Financial Year</u>	<u>Multiplying factor</u>
Base year of inviting tender	2023-2024	1.00
-1	2022-2023	1.10
-2	2021-2022	1.21
-3	2020-2021	1.33
-4	2019-2020	1.46
-5	2018-2019	1.61

## LIST OF KEY PLANT & EQUIPMENT TO BE DEPLOYED ON CONTRACT WORK

[Reference CL. 4.5.5]

The contractors shall also give a list of machineries in his possession and which they propose to use on the work.

<b>Sr. No.</b>	<b>Plant or Machinery</b>	<b>Location</b>	<b>Age of Machinery (maximum 15 years)</b>	<b>Make</b>	<b>Capacity</b>	<b>Approximate Value</b>	<b>Remark</b>
<b>1</b>	<b>2(a)</b>	<b>2(b)</b>	<b>3</b>	<b>4</b>	<b>5</b>	<b>6</b>	<b>7</b>

## **List of Key Personnel to be deployed on Contract Work**

### **(Reference Cl. 4.5.4)**

#### **# Employment of a qualified site Engineer by the Contractor.**

The Contractor shall employ full-time technically qualified staff during the execution of this work as under: -

1. **Two graduate Civil Engineers and three diploma Civil Engineers when cost of the work to be executed is more than Rs.50 lakhs.**
2. One graduate & two Diploma, Civil Engineers when the cost of the work to be executed is more than Rs.15 lakhs but less than Rs.50 lakhs.
3. Minimum Two Diploma Civil Engineer when the cost of work is less than Rs.15 lakhs but more than Rs.5 lakhs.
4. Minimum One Diploma Civil Engineers for the work when the cost of work to be executed is less than Rs. 5 lakhs. The Engineer so employed for the Government work must have sufficient experience to handle the work independently. Such an Engineer shall have to stay at the site of work and he shall not be entrusted with other duty except this work.

In case the contractor or partner of the contractor firm is a Civil Graduate Engineer, Employment of a separate Engineer will not be necessary provided that the Engineer partner himself attends the execution of the work on the site.

Within 15 days of issue of work-order the Contractor will have to furnish to the Deputy Engineer-in-charge of the work the Name, Qualifications, copy of marksheet, Colour Photograph and the appointment order issued such engineers engaged for this contract work. If 15 days after issue of work order such designated Site Engineers do not resume or do not remain present on site of work, the recovery at the rate of **Rs.15,000-00 per month per Engineer** will be made from the bills/deposit/dues of the contractor. **Such recovery shall be non-refundable.**



**SECTION - 2**  
**QUALIFICATION INFORMATION**

## QUALIFICATION INFORMATION

The information to be filled in by the Bidder in the following pages will be used for the purpose of post qualification as provided for in Clause 4 of the Instruction to Bidders. This information will not be incorporated in the Contract.

### 1. For Individual Bidders

1.1 Constitution or legal status of Bidder (Attach Copy)

Place of registration \_\_\_\_\_

Principal place of business \_\_\_\_\_

Power of attorney of signatory of Bid

(Attach)

1.2 Total value of Civil engineering constructions Work performed in the last five years (In Rs. Lakhs)

2022-2023  
2021-2022  
2020-2021  
2019-2020  
2018-2019

1.3.1 Work performed as prime contractor, work performed in the past as a nominated sub-contractor will also be considered the sub-contract involved execution of all main items of work described in the bid documents, provided further that all other qualification criteria are satisfied (in the same name) on works of a similar nature over the last five years\*\* and in current year before the submission of the bid.

Project Name	Name of the Employer	Description of work	Contract No.	Value of contract (Rs. Crore)	Date of issue of work order	Stipulated period of completion	Actual date of completion*	Remark explaining reasons for delay & work Completed

\*Attach certificate(s) from the Engineer(s) in-charge

\*\* Immediately preceding the financial year in which bids are received.

1.3.2 Quantities of work executed as prime contractor, work performed, in the past as a nominated sub-contractor, will also be considered provided the sub-contract involved execution of all main items of work described in the bid document, provided, further that all other qualification criteria are called (in the same name and style) in the last five years\*\* and in current year before the submission of the bid.

Year	Name of the work	Name of the Employer	Quantity of work performed (Cum/MT)				Remarks* (indicate contract Ref) contract Ref)
			Cement Concrete (Including RCC & PCC) ITEM 1	Rubble Pitching ITEM 2	Earth Works ITEM 3	Bituminous Work	
20 - 20							
20 - 20							
20 - 20							
20 - 20							
20 - 20							

1.4 Information on Bid Capacity (works for which bids have been submitted and works which are yet to be completed) as on the date of this bid.

(A) Existing commitments and on-going works:

Description of works	Place & State	Contract No.	Name & Address of Employer	Value Contract (Rs. Cr)	Stipulated Period of Completion	Value of Works* remaining to be completed (Rs. Cr)	Anticipated of completion
1	2	3	4	5	6	7	8

\*Attach certificate (s) from the Engineer(s) in-charge

\*\* Immediately preceding the financial year in which bids are received.

1.5 Availability of key items of Contractors Equipment for carrying out the works (Ref. Clause 4.5.5). The Bidder should list all the information requested below.

Item of Equipment	Requirement		Availability Proposals			Remarks (from whom to be purchased
	NO	Capacity	Owned/ Leased to be procured	Nos./ Capacity	Age/ Conditions	

1.6 Qualifications and experience of key personnel required for administration and execution of the contract. Attach biographical data. Refer also to Sub Clause 9.1 of the Conditions of Contract.

Position	Name	Qualification	Year of Experience (General)	Year of experience in the proposed position
Project Manager				

Etc.				

1.7 Proposed sub-contract and firms involved

Sections of the works	Value of Sub-Contractor	Sub-Contractor (Name & Address)	Experience in similar work

Attach copies of certificates on possession of valid license for executing water supply/ sanitary work/ building electrification works.

- 1.8 Financial reports for the last five years: balance sheets, profit and loss statements, auditors' reports (in case of companies/corporations), etc. List them below and attach copies.
- 1.9 Evidence of access to financial resources to meet the qualification requirements: cash in hand, lines of credit, etc. List them below and attach copied documents.
- 1.10 Name, address, and telephone, telex, and fax numbers of the Bidders bankers who may provide references if contacted by the Employer.
- 1.11 Information on Litigation history in which the Bidder is involved.

Other Party (ies)	Employer	Cause of Dispute	Amount Involved	Remarks showing Present Status

1.12. Statement of compliance under the requirements of Sub Clause 3.2 of the instruction to Bidders. (Name of Consultant engaged for project preparations is\* .....)

---



---

- 1.13 Proposed work method and schedule. The Bidder should attach descriptions, drawings and charts as necessary to comply with the requirements of the Bidding documents. (Refer ITB Clause 4.1)
- 1.14 Programme

**2. Deleted**

**3. Additional Requirements**

3.1 Bidders should provide any additional information required to fulfil the requirements of Clause 4 of the Instructions to the Bidders, if applicable.

- (i) Affidavit
- (ii) Undertaking

\* Fill the name of consultant

**SAMPLE FORMAT FOR EVIDENCE OF ACCESS  
TO OR AVAILABILITY OF CREDIT FACILITIES**

(CLAUSE 4.5.6 OF ITB)

**BANK CERTIFICATE**

This is to certify that M/s. \_\_\_\_\_ is a reputed company with a good financial standing.

If the contract for the work, namely \_\_\_\_\_ is awarded to the above firm, we shall be able to provide overdraft/credit facilities to the extent of Rs \_\_\_\_\_ to meet their working capital requirements for executing the above during the contract period.

\_\_\_\_\_

(Signature) Name of

Bank

Senior Bank Manager

Address of the Bank

## AFFIDAVIT

1. I, the undersigned, do hereby certify that all the statements made in the required attachments are true and correct.
  
2. The undersigned also hereby certifies that neither our firm M/s. \_\_\_\_\_  
\_\_\_\_\_ have not abandoned any work of Government of Gujarat/Government of India/any Board or Corporation under Government of Gujarat/Government of India nor any contract awarded to us for such works have been rescinded, during last five years prior to the date of this bid.
  
3. The undersigned hereby authorize(s) and request (s) any bank, person, firm or corporation to furnish pertinent information deemed necessary and requested by the Department to verify this statement or regarding any (our) competence and general reputation.
  
4. The Undersigned understands and agrees that further qualifying information may be requested, and agrees to furnish any such information at the request of the Department/ Project implementing agency.

\_\_\_\_\_

(Signed by an Authorized Officer of the Firm)

\_\_\_\_\_  
Title of Officer

\_\_\_\_\_  
Name of Firm

\_\_\_\_\_  
Date

## UNDERTAKING

I, the undersigned do hereby undertake ..... that our firm M/s \_\_\_\_\_  
\_\_\_\_\_ would invest a minimum cash up to 25% of the  
value of the work during implementation of the contract.

\_\_\_\_\_  
\_\_\_\_\_ (Signed by  
an Authorized officer of the firm)

\_\_\_\_\_  
Title of officer

\_\_\_\_\_  
Name of firm

\_\_\_\_\_  
DATE



**SECTION - 3**  
**CONDITIONS OF CONTRACT**

# Conditions of Contract

## Table of Contents

		Page No.			
<b>A</b>	<b>General</b>		<b>D.</b>	<b>Cost Control</b>	
1	Definitions	37	37	Bill of Quantities	49
2	Interpretation	38	38	Changes in the Quantities	49
3	Language and Law	39	39	Variations	49
4	Engineer's Decisions	39	40	Payments for Variations	49
5	Delegations	39	41	Cash Flow Forecasts	50
6	Communications	39	42	Payment Certificates	51
7	Sub-Contractors	39	43	Payments	51
8	Other Contractors	39	44	Compensations Events	51
9	Personnel	40	45	Tax	52
10	Employer's & Contractor Risk	40	46	Currencies	52
11	Employers Risks	40	47	Price Adjustment	52
12	Contractor's Risk	40	48	Retention	52
13	Insurance	40	49	Liquidated damages	53
14	Site Investigations Reports	41	50	Bonus	54
15	Queries about the Contract	41	51	Advance Payment	54
16	Contractors to Construct the works	41	52	Securities	55
17	The Works to be Completed by the Intended Completion Date	41	53	Deleted	55
18	Approval by the Engineer	41	54	Cost of Repair	55
19	Safety	41			
20	Discoveries	42	<b>E.</b>	<b>Finishing the Contract</b>	
21	Possession of the Site	42	55	Completion	56
22	Access to the Site	42	56	Taking Over	56
23	Instructions	42	57	Final Account	56
24	Disputes	42	58	Operating and Maintenance manuals	56
25	Procedure for Disputes	43			
26	Deleted	43	59	Terminations	56
			60	Payment upon Terminations	57
<b>B.</b>	<b>Time Control</b>		61	Property	58
27	Programme	44	62	Release from Performance	58
28	Extensions of the Intended completion date	44			
29	Deleted	44	<b>F.</b>	<b>Special Conditions of Contract</b>	
30	Delays Ordered by the Engineer	44	63	Labour	59
			64	Compliance with labour regulations	59
31	Management Meetings	45	65	Arbitration	62
32	Early Warning	45			
<b>C.</b>	<b>Quality Control</b>				
33	Identifying Defects	46			
34	Tests	48			
35	Correction of Defects	48			
36	Uncorrected Defects	48			

## CONDITIONS OF CONTRACT

### A. GENERAL.

#### 1. Definitions

- 1.1 Terms which are defined in the Contract Data are not also defined in the Conditions of Contract but keep their defined meaning.

**Bill of Quantities** means the priced and completed Bill of Quantities forming part of the Bid

**Compensation Events** are those defined in Clause 44 hereunder

The **Completion Date** is the date of completion of the Works as certified by the Engineer in accordance with Sub Clause 55.1

The Contract is the contract between the Employer and Contractor to execute, complete and maintain the Works **till the completion of Defects Liability Period**. It consists of the documents listed in Clause 2.3 below.

The **Contract data** defines the documents and other information which comprise the Contract.

The **Contractor** is a person or corporate body whose Bid to carry out the Work has been accepted by the Employer.

The **Contractor's Bid** is the completed Bidding document submitted by the Contractor to the Employer and includes Technical and Financial Bids.

The **Contract Price** is the price stated in the Letter of Acceptance and thereafter as adjusted in accordance with the provisions of the Contract.

**Days** are calendar days: **months** are calendar months.

The **Defects Liability Period** is the period named in the Contract Data and calculated from the Completion Date.

The **Employer** is the party who will employ the Contractor to carry out the works.

**The Engineer** is the person named in the Contract Data (or any other competent person appointed and notified to the contractor to act in replacement of the Engineer) who is responsible for supervising the Contractor, administering the Contract, certifying payments due to the Contractor, issuing and valuing Variations to the Contract, awarding extensions of time, and valuing the Compensations Events.

**Equipment** is Contractor's machinery and vehicles brought temporarily to the site to construct the Works.

The **Initial Contract Price** is the Contract Price listed in the Employer's Letter of Acceptance.

The **Intended Completion Date** is the date on which it is intended that the Contractor shall complete the Works. The Intended Completion Date is specified in the Contract Data. The Intended Completion Date may be revised only by the Engineer by issuing an extension of time.

**Materials** are all supplies, including consumables, used by the contractor for incorporation in the works.

**Plant** is any integral part of the work which is to have mechanical, electrical, electronic or chemical or biological functions.

The **Site** is the area defined as such in the Contract Data.

**Site Investigation Reports** are those which were included in the Bidding documents and are factual interpretive reports about the surface and subsurface conditions at the site.

**Specifications** means the Specifications of the works included in the Contract and any modification or addition made or approved by the Engineer.

The **Start Date** is given in the Contract Data. It is the date when the Contractor shall commence execution of the works. It does not necessarily coincide with any of the Site Possession Dates.

A **Subcontractor** is a person or corporate body who has a Contract with the Contractor to carry out a part of the work in the Contract which includes work on the Site.

**Temporary Works** are works designed, constructed, installed, and removed by the Contractor which are needed for construction or installation of the Works.

A **Variation** is an instruction given by the Engineer, which varies the Works. The

**Works** are what the Contract requires the Contractor to construct, install, and turn over to the Employer, as defined in the Contract Data.

## 2. **Interpretation**

2.1 In interpreting these Conditions of Contract, singular also means plural, male also means female or neuter and the other way around. Headings have no significance. Words have their normal meaning under the language of the Contract unless specifically defined. The Engineer will provide instructions clarifying queries about Conditions of Contract.

2.2 If sectional completion is specified in the Contract Data, references in the Conditions of Contract to the Works, the Completion date, and Intended Completion Date apply to any Section of the Works (other than references to the Completion Date and Intended Completion date for the whole works)

2.3 The documents forming the Contract shall be interpreted in the following order of priority

- (1) Agreement
- (2) Letter of Acceptance, notice to proceed with works
- (3) Contractor's Bid

- (4) Contract Data
- (5) Conditions of Contract including Conditions of Contract
- (6) Specifications
- (7) Drawings
- (8) Bills of quantities and
- (9) Any other document listed in the Contract Data as forming part of the Contract.

**3. Language and Law**

3.1 The language of the Contract and the law governing the Contract are stated in the Contract Data.

**4. Engineers Decisions**

4.1 Except where otherwise specifically stated, the Engineer will decide contractual matters between the Employer and the Contractor in the role representing the Employer.

**5. Delegation**

5.1 The Engineer may delegate any of his duties and responsibilities to other people after notifying the Contractor and may cancel any delegation after notifying the Contractor.

**6. Communications**

6.1 Communications between parties which are referred to in the conditions are effective only when in writing. A notice shall be effective only when it is delivered (in terms of Indian Contract Act).

**7. Sub-Contracting**

7.1 The Contractor may subcontract any portion of work, up to a limit specified in contract data, with the approval of the engineer but may not assign the Contract without the approval of the Employer in writing. Subcontracting shall not alter the Contractor's obligations. **Sub-contracting of supply or specific items of work is not allowed.**

7.2 The sub-contractor must be registered in appropriate class and category for the part of work to be subcontracted.

**8. Other Contractors**

8.1 The Contractor shall cooperate and share the Site with other contractors, public authorities, utilities and the Employer between the dates given in the Schedule of other Contractor. The Contractors shall as refer to in the Contract Data, also provide facilities and services for them as described in the Schedule. The employer may modify the schedule of other contractors and shall notify the contractor of any such modifications.

## **9. Personnel**

- 9.1 The Contractor shall employ the key personnel named in the Schedule of Key Personnel as referred to in the Contract Data to carry out the functions stated in the Schedule or other personnel approved by the Engineer. The Engineer will approve any proposed replacement of key personnel only if their qualifications, abilities, and relevant experience are substantially equal to or better than those of the personnel listed in the Schedule.
- 9.2 If the engineer asks the Contractor to remove a person who is a member of the Contractor Staff or his work force stating the reasons the Contractor shall ensure that the person leaves the Site within seven days and has no further connection with the work in the Contract.

## **10. Employer's and Contractors Risks**

- 10.1 The Employer carries the risk which these Contract states are Employer's risks, and the Contractor carries the risks which these Contracts states are Contractor's risk.

## **11. Employer's Risks**

- 11.1 The employer is responsible for the excepted risks which are (a) in so far as they directly affect the execution of the Works, the risks of war, hostilities, invasion, act of foreign enemies, rebellion, revolution, insurrection or military or usurped power, civil war, riot commotion or disorder (unless restricted to the Contractor's employees), and contamination from any nuclear fuel or nuclear waste or radioactive toxic explosive.

## **12. Contractor's Risks**

- 12.1 All risks of loss of or damages to physical property and of personal injury and death which arise during and in consequence of the performance of the Contract other than the excepted risks are the responsibility of the Contractor.

## **13. Insurance**

- 13.1 The Contractor shall provide, in the joint names of the Employer and the Contractor, insurance cover from the Start date to the end of the Defects Liability Period, in the amounts and deductibles stated in the Contract data for the following events which are due to the Contractor's risks:
- (a) Loss of or damage to the works, Plant and materials,
  - (b) Loss of or damage to Equipment
  - (c) Loss of or damages of property (except the Works, Plant, Materials and Equipment) in connection with the Contract; and
  - (d) Personal injury or death.
- 13.2 Policies and certificates for insurance shall be delivered by the Contractor to the Engineer for the Engineer's approval before the Start Date. All such insurance shall provide for compensation to be payable in the types and proportions of currencies required to rectify the loss or damage incurred.

13.3 If the Contractor does not provide any of the policies and certificates required, the Employer may affect the insurance which the Contractor should have provided and recover the premiums the Employer has paid from payments otherwise due to the Contractor or, if no payment is due, the payment of the premiums shall be a debt due.

13.4 Alterations to the terms of an insurance shall not be made without the approval of the Engineer.

13.5 Both parties shall comply with any conditions of the insurance policies.

#### **14. Site Investigation Report**

14.1 The Contractor in preparing the Bid shall rely on any site Investigation reports referred to in the Contract Data, supplemented by any information available to the Bidder.

#### **15. Queries about the Contract data**

15.1 The engineer will clarify queries on the Contract Data

#### **16. Contractor to Construct the Works**

16.1 The Contractor shall construct and install the works in accordance with the specification and Drawings.

#### **17. The Works to be completed by the Intended Completion Date**

17.1 The Contractor may commence execution of the Works on the Start Date and shall carry out the Works in accordance with the programme submitted by the Contractor, as updated with the approval of the Engineer, and complete them by the Intended Completion date

#### **18. Approval by the Engineer**

18.1 The Contractor shall submit Specifications and Drawings showing the proposed Temporary works to the Engineer, who is to approve them if they comply with the Specifications and drawings.

18.2 The Contractor shall be responsible for design of temporary works.

18.3 The Engineer's approval shall not alter the contractor responsibility for design of the Temporary works.

18.4 The Contractor shall obtain approval of third parties to the design of the Temporary works where required.

18.5 All Drawings prepared by the Contractors for the execution of the temporary or permanent work are subject to prior approval by the Engineer before their use.

#### **19. Safety**

19.1 The Contractor shall be responsible for the safety of all activities on the Site.

## 20. Discoveries

20.1 Anything of historical or other interest or of significant value unexpectedly discovered on the site is the property of the Employer. The contractor is to notify the engineer of such discoveries and carry out the Engineer's instructions for dealing with them.

## 21. Possession of the Site

21.1 The Employer shall give possession of all parts of the site to the Contractor. If possession of a part is not given by the date stated in the Contract Data the Employer is deemed to have delayed the start of the relevant activities and this will be a Compensation Event.

21.2 If within 25% of the time limit of the project, 80% of possession of the site is not handed over to the Contractor, then contractor/ Employer may fore-close the contract. Contractor/Employer has to foreclose the work within 30 days after lapse of 25%-time limit and after 30 days foreclosure option will be closed.

## 22. Access to the Site

22.1 The Contractor shall allow the Engineer and any person authorized by the Engineer access to the Site, to any place where work in connection with the Contract is being carried out or is intended to be carried out and to any place where materials or plants are being manufactured/ fabricated/ assembled for the works.

## 23. Instructions

23.1 The Contractor shall carry out all instructions of the Engineer pertaining to works which comply with the applicable laws where the site is located.

23.2 The Contractor shall permit the Employer to inspect the Contractor's accounts and records relating to the performance of the Contractor and to have them audited by auditors appointed by the Employer, if so required by the Employer.

## 24. Disputes

24.1 If the Contractor is of the view that a decision taken by the Engineer was either outside the authority given to the Engineer by the Contract or that the decision was wrongly taken, the decision shall be referred to **THE COMMISSIONER (BHAVNAGAR MUNICIPAL CORPORATION)** within 14 days of the notification of the Engineer's decision. If the issue is not resolved, any party can refer the matter for conciliation within 15 days from the decision given by **THE COMMISSIONER (BHAVNAGAR MUNICIPAL CORPORATION)**.

24.2

(a) For the work up to Rs.100 Cr., if any of the parties is not satisfied with the decision of the # **THE COMMISSIONER (BHAVNAGAR MUNICIPAL CORPORATION)**, both the parties have to refer to the Chief Engineer concern for the conciliation process.

(b) For the work more than Rs.100 Cr., if any of the parties is not satisfied with the decision of the # **THE COMMISSIONER (BHAVNAGAR MUNICIPAL CORPORATION)**, both the parties have to refer to the #Secretary, Water Resources Department, Government of Gujarat for the



conciliation process.

If the dispute is not resolved through the conciliation process, he may refer the dispute to Gujarat Public Works Contract Dispute Arbitration Tribunal. If the Contractor fails to refer a claim / dispute to the Higher Authority within 14 days of the notification of the Engineer's decision, the Contractor shall not be entitled to any additional payment/claim if he doesn't follow the above sequence in stipulated time and he should not stop the work.

**25. Procedure for Disputers**

25.1 The arbitration shall be conducted in accordance with the arbitration procedure stated in the Special Conditions of Contract.

**26. Deleted**

## **B. TIME CONTROL**

### **27. Programme**

- 27.1 Within the time stated in the Contract Data the Contractor shall submit to the Engineer for approval a Programme showing the general methods, arrangements orders, and timing for all the activities in the works along with monthly cash flow forecast.
- 27.2 An update of the Programme shall be a programme showing the actual progress achieved on each activity and the effect of the progress achieved on the timing of the remaining work including any changes to the sequence of the activities.
- 27.3 The Contractor shall submit to the Engineer, for approval an updated programme at intervals no longer than the period stated in the Contract data. If the Contractor does not submit an updated programme within this period, the Engineer may withhold the amount stated in the Contract data from the next payment after the date on which the overdue programme has been submitted.
- 27.4 The Engineer's approval of the programme shall not alter the Contractor's obligations. The Contractor may revise the programme and submit it to the Engineer again at any time. A revised programme is to show the effect of Variations and Compensations events.
- 27.5 When the project is delayed by 15% or three months from the scheduled progress, the contractor has to revise the project program and submit it to the engineer-in-charge and Consultant. It outlines the contractor's new approach and the need for additional resources so that the project can be completed within the stipulated time frame.

### **28. Extension of the Intended Completion Date**

- 28.1 The Engineer shall extend the Intended Completion Date if a compensation Event occurs or a Variation is issued which makes it impossible for completion to be achieved by the Intended Completion Date without the Contractor taking steps to accelerate the remaining work and which would cause the Contractor to incur additional cost.
- 28.2 The Engineer shall decide whether and by how much to extend the Intended Completion Date within 35 days of the Contractor asking the Engineer for a decision upon the effect of a compensation event or Variation and submitting full supporting information. If the Contractor has failed to give early warning of a delay or has failed to cooperate in dealing with a delay, the delay by this failure shall not be considered in assessing the new Intended Completion Date.
- 28.3 The Engineer shall within 14 days of receiving full justification from the contractor for extension of Intended Completion Date refer to the Employer his decision. The employer shall in not more than 21 days communicate to the engineer the acceptance or otherwise of the Engineer's decision. If the employer fails to give his acceptance, the Engineer shall not grant the extension and the contractor may refer the matter under Clause 24.1

### **29. Deleted**

### **30. Delays Ordered by the Engineer**

- 30.1 The Engineer may instruct the Contractor to delay the start or progress of any activity within the works.

**31. Management Meetings**

- 31.1 Either the Engineer or the Contractor may require the other to attend a management meeting. The business of a management meeting shall be to review the plans for remaining work and to deal with matters raised in accordance with the early warning procedure.
- 31.2 The Engineer shall record the business of management meetings and is to provide copies of his record to those attending the meeting and to the Employer. The responsibility of the parties for actions to be taken is to be decided by the Engineer either at the management meeting or after the management meeting and stated in writing to all who attended the meeting.

**32. Early Warning**

- 32.1 The Contractor is to warn the Engineer at the earliest opportunity of specific likely future events or circumstances that may adversely affect the quality of the work, increase the Contract price or delay the execution of works. The Engineer may require the contractor to provide an estimate of the expected effect of the future event or circumstance on the contract price and completion date. The estimate is to be provided by the Contractor as soon as reasonably possible.
- 32.2 The Contractor shall cooperate with the Engineer in making and considering proposals for how the effect of such an event or circumstance can be avoided or reduced by anyone involved in the work and in carrying out any resulting instruction of the Engineer.

## C. QUALITY CONTROL

### Identifying Defects/ Defect liability period

33.1 Defect liability period: The contractor shall be responsible to make good and remedy at his own expense any defect which may develop or may be noticed before the period mentioned hereunder from the certified date of completion. The Engineer in charge shall give the contractor a notice in writing about the defects and the contractor shall make good the same within 15 days of receipt of the notice. In the case of failure on the part of the contractor, the Engineer-in-charge may rectify or remove or re-execute the work at the risk & cost of the contractor. The Engineer-in-charge shall be entitled to appropriate the whole or any part of the amount of security deposit towards the expenses, if any, Incurred by him in rectification, removal or re-execution. The Defects Liability period shall be as under....

(a) For all works costing up to Rs. 50,000 (amount put to tender), the period shall be 3 Months from the certified date of completion.

(b) For all works costing more than Rs. 50,000 and up to Rs. 1 crore (amount put tender), the period shall be 12 (Twelve) months from the certified date of completion or one monsoon, whichever is later.

(c) For major projects costing more than Rs. 1 crore, the period shall be 36 Months from the certified date of completion which should include three monsoons.

(d) For original building works the defect liability period will be 4 years or elapse of 4 monsoon period following date of possession of building taken over by user agency following the certified date of completion, whichever is later.

For the purpose of deciding the monsoon period, the 30th September shall be treated as the last date.

Modified vide R & B D Circular No. PAC-11-102008-2076-N dated 31/8/2009, PRCH/102013(2976) 2759-N, Dated 27/05/2013 and Circular No.TNC/10/2016/Clause 17A (Correction/(1)C Dated 12/05/2016]

Free maintenance guarantee period for works of Road/Bridge construction

For resurfacing work of road free maintenance guarantee period one year from the date of completion.

In case of widening of the road/strengthening of the road/bridge, the contractor shall have to give four years free maintenance guarantee from the certified date of completion. During this period the contractor shall visit the site every six months along with the concerned Section Officer / Deputy EXECUTIVE ENGINEER and will examine the work already carried out in this contract like road work, jungle cutting, side shoulders, side gutter, road furniture, patta etc. and will prepare Km. wise inspection report duly signed by all concerned and any defect observed shall be done within 15 days by the contractor at his risk and cost as per the direction of Engineer in charge. The contractor needs to do videography of these visits and require to submit at the time of release of FMG. If B.T. the surface during

the maintenance period of 4 years is worn out then agency shall have to provide renewal coating as per tender item as directed by the Engineer-in- charge. The amount equivalent to 5% of each running bill shall be withheld and will be released after the free maintenance guarantee period (i.e. 4 years) is over.

However, this amount shall be released against fixed deposit or bank guarantee pledged in the name of EXECUTIVE ENGINEER after completion certificate of work is issued.

The flakiness and elongation index (combined) for coarse aggregates under no circumstances shall exceed the allowable limit set forth in the relevant clause for the material in question.

2% of the amount eligible for the payment of bituminous items shall be withheld till the miscellaneous items like earthwork in embankment / cutting for side shoulders, side gutters, kilometer / indicator / guard stones, sign boards etc. are completed in all respect by the contractor. After completion of the miscellaneous items, the above said 2% withheld amount shall be released.

(Govt. of Gujarat's G.R. No.: TNC-10-2013-3(Part-3)/C, Dtd. 13/12/2013).

Videography for the surface under Maintenance Guarantee is to be done as per Govt. letter No.: SSR/10/2015-16/26/C, Dtd. 26/11/15 for the work costing more than Rs. 5.00 Crore.

Setting up of adequate laboratory & deployment of quality engineers.

The contractor shall have to set up the laboratory with adequate equipment. Till the setting up of adequate laboratory is completed & reported of this to the engineer (subject to due verification by engineer's representative) by contractor in writing, Rs.2,00,000/- shall be withheld. The qualified quality Engineer shall be deployed exclusively for this contract by the contractors. If quality Engineer is not deployed by contractor within one month after the date of work order, the amount equivalent to Rs.20,000 per month shall be recovered till the actual deployment of quality engineer. The amount so recovered towards the deployment of quality engineers shall not be refunded.

Asphalt work will have to be cross checked as per G.R. No.: RGN/60/2006/35/C, dtd.31/05/07 before final bill is paid.

Maintenance during Construction Period

During the Construction Period, the Contractor shall maintain, at his own risk and cost, the existing lane(s) of the road so that the traffic worthiness and safety thereof are at no time materially inferior as compared to their condition 10 (ten) days prior to the date of the Agreement, and shall undertake the necessary repair and maintenance works for this purpose; provided that the Contractor may, at his cost, interrupt and divert the flow of traffic if such interruption and diversion is necessary for the efficient progress of works and conforms to Good Industry Practice; provided

further that such interruption and diversion shall be undertaken by the Contractor only with the prior written approval of the EXECUTIVE ENGINEER which approval shall not be unreasonably withheld. For the avoidance of doubt, it is agreed that the Contractor shall at all times be responsible for ensuring safe operation of the road.

The Engineer shall check the Contractor's work and notify the Contractor of any defects that are found. Such checking shall not affect the Contractor's responsibilities the Engineer may instruct the Contractor to search for a Defect and to uncover and test any work that the Engineer considers may have a Defect.

Tests

If the engineer instructs the Contractor to carry out a test not specified in the Specification to check whether any work has a Defect and the test shows that it does, the Contractor shall pay for the test and any samples. If there is no defect the test shall be a Compensation Event.

#1% of the amount of work done for works up to Rs. 10 crore of estimate cost should be deducted from R.A. Bill of the contractor for testing the quality of material workmanship. Whereas for estimated cost of works more than 10 crores, the charges for testing of quality of material workmanship shall be deducted from R.A. bill of contractor as per actual charges. As Per GoG NWRWS & K Department's Circular No. PARCH/132023/401/MICELL Dated: 05/10/2023

Agency has to establish testing laboratory on site for the various test to be carried out in the work for this purpose agency shall construct a pukka laboratory building with all facility on site at location specified by the engineer in charge.

#### Correction of defects

The engineer shall give notice to the Contractor of any defects before the end of the defects Liability Period, which begins at Completion and is defined in the contract data. The Defects Liability Period shall be extended for as long as Defects remain to be corrected.

Every time notice of a Defect is given, the Contractor shall correct the notified defect within the length of time specified by the Engineer's notice.

#### Uncorrected Defects

If the Contractor has not corrected a defect within the time specified in the Engineer's notice, the Engineer will assess the cost of having the Defect corrected, and the Contractor will pay this amount.

## **D. COST CONTROL**

### **34. Bill of Quantities**

- 34.1 The bill of Quantities shall contain items for the constructions, installation, testing and commissioning work to be done by the Contractor.
- 34.2 The bill of Quantities is used to calculate the Contract price. The Contractor is paid for the quantity of the work done at the rate in the Bill of Quantities for each item.

### **35. Change in the Quantities**

- 35.1 The Engineer shall have power to make any alterations in or addition to the original specifications, drawings, designs and instructions that may appear to him to be necessary or advisable during the progress of the work and the contractor shall be bound to carry out the work in accordance with any instruction in this connection which may be given to him in writing signed by the Engineer and such alteration shall not invalidate the contract and any additional work which the contractor may be directed to do in the manner above specified as part of the work shall be carried out by the contractor on the same conditions in all respects on which he agreed to do the main work and at the same rate as are specified in the tender for the main work.

Except that when the quantity of any item exceeds the quantity as in the tender by more than 130%, the contractor will be paid for the quantity in excess of 130%, at the rate entered in the SOR of the year during which the excess in quantity is first executed.

### **36. Variations**

- 36.1 All Variations shall be included in updated programmes produced by the Contractor.

### **40. Payments for Variations**

- 40.1 If the additional or altered work includes any class of work for which no rate is specified in this contract, then such class of work shall be carried out as under.

- (i) At the rate derived from the item within the contract which is comparable to the one involving additional or altered class of work; where there are more than one comparable items, the item of the contract which is nearest in comparison with regard to class or classes of the work involved shall be selected and the decision of the EXECUTIVE ENGINEER as to the nearest comparable item shall be final and binding on the contractor.
- (ii) If the rate cannot be derived in accordance with (i) above, such class of works shall be carried out at the rate entered in the Schedule of Rates of the division for the year in which the tender was received, increased or decreased by the percentage by which the tender amount is more or less as compared to the amount arrived at the rates in the "Schedule of Rates" of the Division in the year in which the tender was received. If the Schedule of rates of the Division does not contain all the items, the percentage increase or decrease of the tender shall be calculated considering such items which were included in the "Scheduled Rates" of the division for the year and for materials consumed on such item the rate to be charged would be the

basic rate taken into account for fixing the rate in S.O.R. referred to above.

- (iii) If it is not possible to arrive at the rate from (i) and (ii) above, such class of work shall be carried out at the rate decided by the competent authorities on the basis of detailed rate analysis after hearing the contractor before a Committee of two Superintending Engineers stationed at the same place or the nearest place.

402 If the additional or altered work, for which no rate is entered in the "Schedule of Rates" of the Division is ordered to be carried out before the rate is agreed upon, then the contractor shall within seven days of the date of receipt by him of the order to carry out the work, inform the Engineer-in-charge of the rate, which it is his intention to charge for such class of work and if the Engineer in charge does not agree to this rates, he shall by notice in writing be at liberty to cancel his order to carry out such class of work and arrange to carry it out in such manner as he may consider it advisable, provided always that if the contractor shall commence work or incur any expenditure in regard thereof before the rates shall have been determined as lastly herein before mentioned, then in such cases he shall only be entitled to be paid in respect of the work carried out or expenditure incurred by him prior to the date of the determination of the rate as aforesaid according to such rate or rates as shall be fixed by the Engineer-in-charge. In the event of the dispute, the decision of the EXECUTIVE ENGINEER of the Circle shall be final.

Where, however, the work is to be executed according to the designs, drawings and specifications recommended by the contractor and accepted by the competent authority, the alternation above referred to shall be within the scope of such designs, drawings and specifications appended to the tenders.

The time limit for the completion of the work shall be extended in the proportion that the increase in the cost occasioned by alterations bears to the cost of the original work and the certificate of the Engineer-in-charge as to such proportion shall be final and conclusive.

#### **41. Cash Flow Forecasts**

41.1 When the programme is updated, the contractor is to provide the engineer with an updated cash flow forecast.

#### **42. Payment certificates.**

42.1 The Contractor shall submit to the Engineer monthly statements of the estimated value of the work completed less the cumulative amount certified previously.

42.2 The Engineer shall check the Contractor's monthly statement within 14 days and certify the amount to be paid to the Contractor after taking in to account any credit or debit for the month in question in respect of materials for the works in the relevant amounts and under conditions set forth in sub-clause 32.3 of the Contract Data (secured Advance).

42.3 The value of work executed shall be determined by the Engineer.

42.4 The value of work executed shall comprise the value of the quantities of the items in the Bill of Quantities completed.

42.5 The value of work executed shall include the valuation of variations and compensation events.

42.6 The Engineer may exclude any item certified in a previous certificate or reduce the proportion of any item previously certified in any certificate in the light of later



information

### **43. Payments**

43.1 Payments shall be adjusted for deductions for advance payments, retention, other recoveries in terms of the contract and taxes at source, as applicable under the law. The Employer shall pay the Contractor the amounts certified by the Engineer within 28 days of the date of each certificate.

43.2 Payment of GST (prevailing rates) on the amount payable under the contract to the Contractor will be made by the Employer. Hence, it is the responsibility of the contractor to pay the GST to the concerned Authority.

43.3 Items of the works for which no rate or price has been entered in will not be paid by the Employer and shall be deemed covered by other rates and prices in the Contract.

### **44. Compensation events**

44.1 The following are compensation Events unless they are caused by the Contractor:

(a) The Employer does not give access to a part of the Site by the site Possession date stated in Contract data to the Contractor

44.2 In case of compensation event occurs and it prevents the work being completed beyond the Intended Completion Date then Authority will approve EOT with eligible contractual price escalation.

### **45. Tax**

45.1 The rates quoted by the Contractor must be inclusive of all taxes prevailing on due date of bid submission **except GST**. However, any subsequent changes in the tax structure by Government after due date of bid submission will be compensated (+/- ) on availability or submission of actual documentation. Contractor will have to intimate Engineer regarding changes occurred in the tax structure after bid submission. If the contractor fails to provide such information and if any financial obligation may arise due to change in tax structure, same will be recovered from the contractor.

45.2 GST will be paid separately on the bills. Hence, it is the responsibility of the contractor to pay the GST to the concerned Authority.

### **46. Currencies.**

46.1 All payment shall be made in Indian Rupees.

### **47. Price Adjustment**

~~47.1 Contract price shall be adjusted for increase or decrease in rates and price of labour, materials, fuels and lubricants in accordance with the following principles and procedures and as per formula given in the contract data:~~

~~(a) The price adjustment shall apply for the work done from the start date given in the contract data up to end of the initial intended completion date or extensions granted by the Engineer and shall not apply to the work carried out beyond the stipulated time for reasons attributable to the contractor.~~

~~(b) The price adjustment shall be determined during each month from the formula given in the contract data.~~

~~(c) Following expressions and meanings during to the work done during each month~~

~~R = Total value of work done during the month. It would include the amount of secured advance granted, if any, during the month less the amount of secured advance recovered, if any during the month. It will exclude value for works executed under variations for which price adjustment will be worked separately based on the terms mutually agreed.~~

~~47.2 To the extent that full compensation for any rise or fall in costs to the contractor is not covered by the provisions of this or other clause in the contract, the unit rates and prices included in the contract shall be deemed to include amounts to cover the contingency of such other rise or fall in costs.~~

## **48. Retention**

48.1 The Employer shall retain from each payment due to Contractor the proportion stated in the Contract Data until Completion of the whole of the Works.

48.2 On Completion of the whole of the Works half the total amount retained is repaid to the Contractor and half when the Defects Liability Period has passed and the Engineer has certified that all Defects notified by the Engineer to the Contractor before the end of this period have been corrected.

48.3 On completion of the whole works, the contractor may substitute retention money with an “on demand” Bank guarantee.

In case, Contractor requests for refund of the Retention Money deducted by the Employer under the provision of this clause, Employer shall consider the said request of the Contractor provided that the refund hereunder shall be made in tranches of not less than 1% (One Percent) of the Contract Price and Contractor furnishes an irrevocable and unconditional Bank guarantee for an equal amount substantially in the format of Bank Guarantee for Performance Guarantee enclosed with SBD and valid up to 60 day beyond the scheduled / extended Defects Liability Period. On completion of the whole works, the contractor has however an option to submit a fresh irrevocable and unconditional Bank Guarantee for an amount equal to 5% of the total value of work executed substantially in the format of Bank Guarantee for Performance Guarantee enclosed with SBD and valid up to 60 days beyond the Defect Liability Period and yet refund the Retention Money Bank Guarantee submitted for refund of Retention Money.

## **49. Liquidated Damages**

49.1 The Contractor shall pay liquidated damages to the Employer at the rate per day stated in the Contract Data for each day that the Completion Date is later than the Intended Completion Date (for the whole works or the milestone as stated in the contract data). The total amount of liquidated damages shall not exceed the amount defined in the Contract Data. The Employer may deduct liquidated damages from payment due to the Contractor. Payment of liquidated damages does not affect the Contractor’s liabilities.

49.2 If the Intended Completion Date is extended after liquidated damages have been paid, the Engineer shall correct any overpayment of liquidated damages by the Contractor by adjusting the next payment certificate. The Contractor shall not be

entitled for any interest on the over payment calculated from the date of payment to the date of repayment.

493 If the contractor fails to comply with the time for completion as stipulated in the tender, then the contractor shall pay to the employer the relevant sum stated in the Contract Data as Liquidated damages for such default and not as penalty for everyday or part of day which shall elapse between relevant time for completion and the date stated in the taking over certificate of the whole of the works on the relevant section, subject to the limit stated in the contract data.

The employer may, without prejudice to any other method of recovery deduct the amount of such damages from any monies due or to become due to the contractor. The payment or deduction of such damages shall not relieve the contractor from his obligation to complete the works on from any other of his obligations and liabilities under the contract.

494 If, before the Time for Completion of the whole of the Works or, if applicable any Section, a Taking Over Certificate has been issued for any part of the Works or of a Section, the liquidated damages for delay in completion of the remainder of the Works or of that Section shall, for any period of delay after the date stated in such Taking-Over-Certificate, and in the absence of alternative provisions in the Contract, be reduced in the proportion which the value of the part so certified bears to the value of the whole of the Works or Section, as applicable. The provisions of this Sub-clause shall only apply to the rate of liquidated damages and shall not affect the limit thereof.

## **50 Bonus**

~~50.1 If the contractor achieves completion of the whole of the works prior to the intended Completion Date prescribed in Contract Data the Employer shall pay to the contractor a sum stated in Contract Data as bonus for every completed month but subjected to maximum amount as stated in Contract Data; which shall elapse between the date of completion of all items of works as stipulated in the contract, including variations ordered by the Engineer and the time prescribed in Clause 17.~~

~~50.2 Bonus shall be paid only to works amounting to above INR 5 crore with time limit of the works is equal or more than 6 months. The bonus would be paid as under~~

<del>% of Time Saved</del>	<del>% of Initial Contract Price entitled for Bonus</del>
<del>50 %</del>	<del>5%</del>
<del>40 %</del>	<del>4%</del>
<del>30 %</del>	<del>3%</del>
<del>20 %</del>	<del>2%</del>
<del>10 %</del>	<del>1%</del>
<del>Less than 10%</del>	<del>0%</del>

## **51. Advance Payment.**

~~51.1 The Employer shall make advance payment (not to be paid less than two instalments except in special circumstances for which the reason to be Recorded in writing) to the Contractor of the amounts stated in the Contract Date by the date stated in the Contract Date, against provision by the Contractor of an Unconditional Bank Guarantee in a form and by a bank acceptable to the Employer in amounts and currencies equal to be at least 110% of the advance payment. The guarantee shall remain effective until the advance payment has been repaid, but the amount of the guarantee shall be progressively reduced by the amounts repaid by the Contractor. The Mobilization advance would be deemed as interest bearing advance at an interest rate of 10 % to be compounded, quarterly.~~

~~51.2 The Contractor is to use the advance payment only to pay for Equipment, plant and Mobilization expenses required specifically for execution of the Works. The Contractor shall demonstrate that advance payment has been used in this way by supplying copies of invoices or other documents to the engineer.~~

~~51.3 The advance payment shall be repaid by deduction proportionate amount from payments otherwise due to the Contractor, following the schedule of completed percentages of the Works on a payment basis. No account shall be taken of the advance payment or its repayment in assessing valuations of work done, variations, price adjustments, Compensation Events, or Liquidated damages.~~

514 Deleted

## **52. Securities**

52.1 The performance Security (including additional security for unbalanced bids) shall be provided to the Employer no later than the date specified in the Letter of Acceptance and shall be issued in an amount and form and by a bank or surety acceptable to the Employer, and denominated in Indian Rupees. The performance Security shall be valid until a date 60 days from the date of expiry of Defects Liability Period and the additional security for unbalanced bids shall be valid until a date 28 days from the date of issue of the certificate of completion.

## **53. Deleted**

## **54. Cost of Repairs.**

54.1 Loss or damage to the Works or Materials to be incorporated in the Works between the Start date and the end of Defects Correction periods shall be remedied by the Contractor at the Contractor's cost if the loss or damages arises from the Contractor's acts or omissions.

## **E. FINISHING THE CONTRACT**

### **55. Completion**

55.1 The Contractor shall request the Engineer to issue a Certificate of Completion of the works and the Engineer will do so upon deciding that the work is completed.

### **56. Taking Over**

56.1 The Employer shall take over the Site and the Works within seven days of the Engineer issuing a certificate of Completion.

### **57. Final Account**

57.1 The Contractor shall supply to the Engineer a detailed final account of the total amount that the Contractor considers payable as full and final settlement of all claims under the Contract for items before the end of the Defects Liability Period. The Engineer shall issue a Defect Liability Certificate and certify any final payment that is due to the Contractor within 56 days of receiving the Contractor's account if it is correct and complete. If it is not, the Engineer shall issue within 56 days a schedule that states the scope of the corrections or additions that are necessary. If the Final Account is still unsatisfactory after it has been resubmitted, the Engineer shall decide on the amount payable to the Contractor and issue a payment certificate, within 56 days of receiving the Contractor's revised account.

57.2 If reversal in characteristic of tender (L1 becoming L2) on account of excesses and savings in final account is observed, the Engineer/Employer shall be at liberty to restrict the final payment of BOQ items to the lowest amount evaluated of the bids considering the final quantities and the rates quoted including the rebates if any. Payment of variation items shall however be made at the rates approved by the Employer, within 90 days from the physical completion of work.

### **58. Operating and Maintenance Manuals**

58.1 If "as built" drawings and/or operating and maintenance manuals are required, the Contractor shall supply them by the dates stated in the Contract data.

58.2 If the Contractor does not supply the Drawings and/or manuals by the dates stated in the Contract data, or they do not receive the Engineer's approval, the Engineer shall withhold the amount stated in the Contract Data from payments due to the Contractor.

### **59. Termination**

59.1 The Employer or the Contractor may terminate the Contract if the other party causes a fundamental breach of the Contract.

59.2 Fundamental breaches of Contract include, but shall not be limited to the following:

1. The contractor stops work for 28 days when no stoppage of work is shown on the current programme and the stoppage has not been authorized by the Engineer
2. The Engineer instructs the Contractor to delay the progress of the Works and the instructions is not withdrawn within 28 days;
3. The Employer or the Contractor is made bankrupt or goes into liquidation other than for a reconstructions or amalgamation
4. A payment certified by the Engineer is not paid by the Employer to the Contractor within 56 days of the date of the Engineer's certificate
5. The Engineer gives Notice that failure to correct a particular Defect is a fundamental breach of Contract and the Contractor fails to correct it within a reasonable period of time determined by the Engineer;
6. The Contractor does not maintain a security which is required;
7. The Contractor has delayed the completion of works by the number of days for which the maximum amount of liquidated damages can be paid as defined in the Contract data; and
8. If the Contractor, in the judgment of the Employer has engaged in corrupt or fraudulent practices in competing for or in executing the Contract.

For the purpose of this paragraph: "corrupt practice" means the offering, giving, receiving or soliciting of anything of value to influence the action of a public official in the procurement process or in contract execution. "Fraudulent practice" means a misrepresentation of facts in order to influence a procurement process or the execution of a contract to the detriment of the borrower, and includes collusive practice among Bidders (prior to or after bid submission) designed to establish bid prices at artificial non-competitive levels and to deprive the Borrower of the benefits of free and open competition.

59.3 When either party to the Contract gives notice of a breach of contract to the Engineer for a cause other than those listed under Sub Clause 59.2 above, the Engineer shall decide whether the breach is fundamental or not.

59.4 Notwithstanding the above, the employer may terminate the Contract for convenience.

## **60. Payment upon Termination**

60.1 If the Contract is terminated because of a fundamental breach of Contract by the Contractor, the Engineer shall issue a Certificate for the value of the work done less advance payments received up to the date of the issue of the

certificate, less other recoveries due in terms of the contract, less taxes due to deducted at source as per applicable law and less the percentage to apply to the work not completed as indicated in the Contract data. Additional Liquidated Damages shall not apply. If the total amount due to the Employer exceeds any payment due to the Contractor the difference shall be a debt payable to the Employer.

- 60.2 If the Contract is terminated at the Employer's convenience or because of a fundamental breach of Contract by the Employer, the Engineer shall issue a certificate for the value of the work done, the cost of balance material brought by the contractor and available at site, the reasonable cost of removal of equipment, repatriation of the Contractor's personnel employed solely on the works, and the Contractor's cost of protecting and securing the Works and less advance payment received up to the date of the certificate, less other recoveries due in terms of the contract and less taxes due to deducted at source as per applicable law.

**61. Property**

- 61.1 All materials on the Site, Plant Equipments, Temporary Works and Works are deemed to be property of the Employer, if the Contract is terminated because of a Contractor's default.

**62. Release from Performance**

- 62.1 If the Contract is frustrated by the outbreak of war or by any other event entirely outside the control of either the Employer or the Contractor the Engineer shall certify that the Contract has been frustrated. The Contractor shall make the Site safe and stop work as quickly as possible after receiving this certificate and shall be paid for all work carried out before receiving it and for any work carried out afterwards to which commitment was made.

**F. SPECIAL CONDITIONS OF CONTRACT**

**63. LABOUR**

The Contractor shall, unless otherwise provided in the Contract, make his own arrangements for the engagement of all staff and labour, local or other, and for their payment of housing, feeding and transport.

The Contractor shall, if required by the Engineer, deliver to the Engineer a return in detail, in such form and at such intervals as the Engineer may prescribe, showing the staff and the numbers of the several classes of labour from time to time employed by the Contractor on the site and such other information as the Engineer may require.

**64. COMPLIANCE WITH LABOUR REGULATIONS**

During continuance of the contract, the Contractor and his sub-contractor shall abide at all times by all existing labour enactments and rules made thereunder, regulations, notification and bye laws of the State or central Government or local authority and any other labour law (including rules), regulations, bye laws that may be passed or notifications that may be issued under any labour law in future either by the State or the Central Government or the local authority. Salient features of some of the major labour laws that are applicable to the construction industry are given below. The Contractor shall keep the Employer indemnified in case any action is taken against the Employer by the competent authority on account of contravention of any of the provisions of any Act or rules made thereunder, regulations or notifications including amendments. If the Employer is caused to pay or reimburse, such amounts as may be necessary to cause or observe, or for observance of the provisions stipulated in the notifications/bye laws/Acts/Rules/regulations including amendments, if any, on the part of the Contractor, the Engineer/employer shall have the right to deduct any money due to the Contractor including his amount of performance security. The Employer/Engineer shall also have the right to recover from the Contractor any sum required or estimated to be required for making good the loss or damage suffered by the Employer.

The employees of the Contractor and the Sub-Contractor in no case shall be treated as the employees of the Employer at any point to time.



SALIENT FEATURES OF SOME MAJOR LABOUR AND OTHER LAWS APPLICABLE TO ESTABLISHMENTS ENGAGED IN BUILDING AND OTHER CONSTRUCTIONS WORK

- A) **Workmen Compensation Act 1923** :- The Act provides for compensation in case of injury by accident arising out of and during the course of employment.
- B) **Payment of Gratuity Act. 1972** :- Gratuity is payable to an employee under the Act on satisfaction of certain conditions on separation if an employee has completed 5 years service or more on death, the rate of 15 days wages for every completed year of service. The Act is applicable to all establishments employing 10 or more employees.
- C) **Employees P.F. and Miscellaneous Provision Act 1952**:- The Act Provides for monthly contributions by the employer plus workers @ 10% or 8.33% The benefits payable under the Act are :
1. Pension or family pension on retirement or death, as the case maybe.
  2. Deposit linked insurance on the death in harness of the worker.
  3. Payment of P.F. accumulation on retirement/death etc.
- D) **Maternity Benefit Act 1951** :- The Act provides for leave and some other benefits to women employees in case of confinement or miscarriage etc.
- E) **Contract Labour (Regulation & Abolition) Act 1970**: The Act provides for certain welfare measures to be provided by the Contractor to contract labour and in case the Contractor fails to provide, the same are required to be provided, by the Principal Employer by Law. The principal Employer is required to take Certificate of Registration and the Contractor is required to take license from the designated Officer. The Act is applicable to the establishments or Contractor of Principal Employer, if they employ 20 or more contract labour.
- F) **Minimum Wages Act 1948** :- The Employer is supposed to pay not less than the Minimum Wages fixed by appropriate Government as per provisions of the Act, if the employment is a scheduled employment. Construction of Building, Roads, Runways are scheduled employment.
- G) **Payments of wages Act 1936**:- It lays down as to by what date the wages are to be paid, when it will be paid and what deductions can be made from the wages of the workers.
- H) **Equal remunerations Act 1979**:- The Act provides for payment of equal wages for work of equal nature to Male and Female workers and for not making discrimination against female employees in the matter of transfer, training and promotions etc.
- I) **Payments of Bonus Act 1965** :- The Act is applicable to all establishments employing 20 or more employees. The Act provides for payments of annual bonus subject to a minimum of 8.33% of wages and maximum of 20 % of wages to employees drawing Rs. 3500/- per month or less. The bonus to be paid to employees getting Rs, 2500/- per month or above Rs. 3500/- per month shall be worked out by taking wages as Rs. 2500/- per month only. The Act does not

apply to certain establishments. The newly set-up establishments are exempted for five years in certain circumstances. Some of the State Governments have reduced the employment size from 20 to 10 for the purpose of applicability of this Act.

- J) **Industrial Disputes Act 1947** :- The Act lays down the machinery and procedure for resolutions of Industrial disputes, in what situations a strike or lock-out becomes illegal and what are the requirements for laying off or retrenching the employees or closing down the establishment.
- K) **Industrial employment (standing Orders) Act 1946** :- It is applicable to all establishments employing 100 or more workmen (employment size reduced by some of the State and Central Government to 50). The Act provides for laying down rules governing the conditions of employment by the Employer on matters provided in the Act and get the same certified by the designated Authority.
- L) **Trade Unions Act 1926**:- The Act lays the procedure for registration of trade unions of workmen and employers. The Trade Unions registered under the Act have given certain immunities from civil and criminal liabilities.
- M) **Child Labour (Prohibition & Regulation Act 1986**:- The Act prohibits employment of children below 14 years of age in certain occupations and process and provides for regulation of employment of children in all other occupations and processes. Employment of Child labour is prohibited in Building and Construction Industry.
- N) **Inter - State Migrant workmen's (Regulation of Employment & Conditions of service) Act 1979**:- The Act is applicable to an establishment which employs 5 or more inter-state migrant workmen through an intermediary (who has recruited workmen in one state for employment in the establishment situated in another state).The inter-state migrant workmen, is an establishment to which this Act becomes applicable, are required to be provided certain facilities such as housing, medical aid, traveling expenses from home up to the establishment and back, etc.
- O) **The Building and Other Construction workers (Regulation of employment and Conditions of Service) Act 1996 and the Cess Act of 1996**:- All the establishments who carry on any building or other constructions work and employ 10 or more workers are covered under this Act.  
All such establishments are required to pay cess at the rate not exceeding 2% of the cost of construction as may be modified by the government. The Employer of the establishment is required to provide safety measures at the Building or construction work and other welfare measures, such as canteens, First Aid facilities, Ambulance, Housing accommodations for workers near the workplace etc. The Employer to whom the Act applies has to obtain a registration certificate from the Registering Officers appointed by the Government.

P) **Factories Act 1948 :-** The Act lays down the procedure for approval of plans before setting up a factory, health and safety provisions, welfare provisions, working hours, annual earned leave and rendering information regarding accidents or dangerous occurrences to designated authorities. It is applicable to premises employing 10 persons or more with aid of power or 20 or more persons without the aid of power engaged in the manufacturing process.

Q) **Royalty charges-**The contractor shall pay the royalty to the competent authority as per rule. The **royalty** charges paid shall be borne by the contractor and shall not be reimbursed by the Employer.

R) **Following Pollution control Acts and amendments made thereof from time to time shall be applicable.**

1. Water (Preservation and control of Pollution) Act, 1974
2. Air (Prevention and Control of Pollution Act 1981
3. Environmental (Protection) Act 1986

The contractor must commit to adopting Environmental management plan for best energy use, waste management, the reduction of pollution as in EMS (Environmental Management system) ISO-14001-2015

#### 65. **ARBITRATION (GCC Clause 24)**

The procedure for arbitration will be as follows: -

24.1 If the Contractor is of the view that a decision taken by the Engineer was either outside the authority given to the Engineer by the Contract or that the decision was wrongly taken, the decision shall be referred to **EXECUTIVE ENGINEER (BHAVNAGAR MUNICIPAL CORPORATION)** within 14 days of the notification of the Engineer's decision. If the issue is not resolved, any party can refer the matter for conciliation within 15 days from the decision given by the #Superintending Engineer.

24.2

(a) For the work up to Rs.100 Cr., if any of the parties is not satisfied with the decision of the #**EXECUTIVE ENGINEER (BHAVNAGAR MUNICIPAL CORPORATION)** both the parties have to refer to the # **THE COMMISSIONER (BHAVNAGAR MUNICIPAL CORPORATION)** concerned for the conciliation process.

(b) For the work more than Rs.100 Cr., if any of the parties is not satisfied with the decision of the Superintending Engineer, both parties have to refer to the #Secretary, Water Resources Department, Government of Gujarat for the conciliation process.

If the dispute is not resolved through the conciliation process, contractor may refer the dispute to Gujarat Public Works Contract Dispute Arbitration Tribunal. If the Contractor fails to refer a claim / dispute to the Higher Authority within 14 days of the notification of the Engineer's decision, the Contractor shall not be entitled to any additional payment/claim if he doesn't follow the above sequence in stipulated time. However, during such period, he would not stop the work in any case.

**SECTION - 4**  
**CONTRACT DATA**

## #CONTRACT DATA

Clause Reference With  
respect to section 3

Item marked "N/A" do not apply to this Contract.

1.	The Employers is	[CL.1.1]
Name: <b>EXECUTIVE ENGINEER, BHAVNAGAR MUNICIPAL CORPORATION</b>		
Address: <b>EXECUTIVE ENGINEER, BHAVNAGAR MUNICIPAL CORPORATION</b>		
Name of authorized Representative (will be intimated later)		
2.	The Engineer is <b>EXECUTIVE ENGINEER, BHAVNAGAR MUNICIPAL CORPORATION</b>	
Name of Authorized Representative: <b>EXECUTIVE ENGINEER</b>		
3.	<b>The Defects Liability Period is 04 (Four) years from the date of completion.</b>	[CL.1.1&33]
4.	The Start Date shall be <b>1<sup>st</sup></b> days for the date of issue of the Notice to proceed with the work.	[CL.1.1]
5.	The Intended Completion Date for the whole of the works is <b>4 (Four) Months</b> after start of work with the following milestones:	[CL.1.1,17&2]
	Milestone dates: <u>Physical works to be completed Period from the start date</u> <b>Physical works to be completed Period from the start date</b> <b>Milestone-1 i.e. 25% 09 Months.</b> <b>Milestone-2 i.e. 50% 18 Months.</b> <b>Milestone-3 i.e. 75 % 24 Months.</b> <b>Milestone-4 i.e. 100% 30 Months.</b>	[CL.2.2& 49.1]
6.	The Site <b>is located at Bhavnagar, Dist. Bhavnagar</b>	[CL.1.1]
7.	The name and identification number of the Contract is:	[CL.1.1]
8.	The works consist of <b>PROPOSED DOG HOME SHELTER &amp; ANIMAL VACCINATION CENTRE AT NARI ROAD, KUMBHARWADA, BHAVNAGAR, DIST. BHAVNAGAR</b> With items as per B.O.Q. The works shall, inter alia, include the following, as Specified or as directed:	[CL.1.1]

	<b>(A) Road Works</b>	
	Site clearance; setting – out and layout; widening of existing carriageway and strengthening including camber corrections; construction of new road/ Parallel service road; bituminous pavements remodeling/ construction of Junctions, intersections, bus bays, lay-bays; supplying and placing of drainage Channels, flumes, guard posts and guard other related items; construction/extension of cross drainage works, bridge, approaches and other related stones; protective works for roads/bridge; all aspects of quality assurance of various components of the works; rectification of The defects in the completed works during the Defects Liability Period; submission of “As- built” drawings and any other related documents; and other item of work as may be required to be carried out for completing the work in accordance with the drawings and the provisions of the contract and to ensure safety.	
	<b>(B) Bridge Works</b> Site clearance; setting out, provision of foundations, piers abutments and bearing; prestressed/reinforced cement concrete superstructure; wearing coat, hand railings, expansion joints, approach slabs, drainages spouts/ down take pipes, arrangements for fixing light posts, water mains, utilities etc.; provision of suitably designed protective works; providing wing/return walls; provision of road markings, road signs etc.; all aspects of quality assurance; clearing the site and handing over the works on completion; rectification of the defects during the Defects Liability Period and submission of “As-built” drawings and other related documents; and other items of work as may be required to be carried out for completing the works in accordance with the drawings and the provisions of the contract and to Insure safety	
	<b>(C) Other Items</b>	[CL.1.1]
	Any Other Items as required to fulfill all contractual obligations as per the Bid documents.	
10.	The following documents also form part of the Contract: _____As per clause 2-3_____	[CL.2.3(9)]
11.	The law which applies to the Contract is the law of Union of India	[CL.3.1]
12.	The language of the Contract documents is English	[CL.3.1]
13.	Limit of subcontracting 25% of the Initial Contract Price	[CL.7.1]
14.	The Schedule of Other Contractors	[CL.8]
15.	The Schedule of Key Personnel As per Annex – II to Section I	[CL.9]
16.	The minimum insurance cover for physical property, injury and death is Rs. 5 lakhs per occurrence with the number of occurrences limited to four. After each occurrence, the contractor will pay an additional premium necessary to make insurance valid for four occurrences always.	[CL13]
17.	Site Investigation report	[CL.14]
18.	The Site Possession dates shall be .....	[CL.21]
19.	The period for submission of programme for approval of the engineer shall be 21 days from the issue of Letter of Acceptance.	[CL. 27.1]
20.	The period between program updates will be ..... days.	[CL.27.3]

21.	The amount to be withheld for late submission of an updated programme shall be Rs. .... lakhs	[CL. 27.3]
22.	<p>The following events shall also be Compensation Events Substantially adverse ground conditions encountered during the course of execution of work not provided for in the bidding document.</p> <p>(i) Removal of underground utilities detected subsequently</p> <p>(ii) Significant changes in classification of soil requiring additional mobilization by the contractor, e.g. ordinary soil to rock excavation,</p> <p>(iii) Removal of unsuitable material like marsh, debris dumps, etc. not caused by the contractor.</p> <p>(iv) Artesian conditions</p> <p>(v) Seepage, erosion landslide</p> <p>(vi) River training requiring protection of permanent work</p> <p>(viii) Presence of historical, archeological or religious structures, monuments interfering with the works</p> <p>(viii) Restriction of access to ground imposed by civil, judicial, or military authority</p>	[CL. 44]
23.	The currency of the Contract is Indian Rupees	[CL. 46]
24.	<p><del><b>The formula (c) for adjustment of prices are as under:-</b></del></p> <p><del>• If any of the commodities like Cement, Steel or Bitumen are not found applicable in a work, the weight component of that commodities (i.e. 'Cement' (Pc), 'Steel' (Ps) or 'Bitumen' (Pb) as indicated in SBD for the purpose of Price Adjustment} shall be clubbed with the weight component of 'Other Material' (Pm), such that the gross % weight of the components shall remain as 100%.</del></p> <p><del>R = value of work as defined in Clause 47.1 of Conditions of Contract</del></p> <p><del><b>Adjustment for labour component</b></del></p> <p><del>(i) Price adjustment for increase or decrease in the cost due to labour shall be paid in accordance with the following formula:-</del></p> <p><del><math display="block">VL = 0.85 \times (PI/100) \times R \times (Li - L0)/L0</math></del></p> <p><del>VL = Increase or decrease in the cost of work during the month under consideration due to changes in rates for local labour</del></p> <p><del>L0 = The consumer price index for industrial workers for the State on 28 days preceding the scheduled date of opening of technical Bids as published by Labour Bureau, Ministry of Labour, Government of India</del></p> <p><del>Li = The consumer price index for industrial workers for the State for the month under consideration as published by the Labour Bureau, Ministry of Labour, Government of India.</del></p> <p><del>PI = Percentage of labor component of the work.</del></p>	[CL.47]
	<p><del><b>Adjustment for cement component-</b></del></p> <p><del>(ii) Prices adjustment for increase or decrease in the cost of cement procured by the contractor-</del></p> <p><del><math display="block">Vc = 0.85 \times (Pc/100) \times R \times (Ci - C0)/C0</math></del></p>	

	<p><math>V_c</math> = Increase or decrease in the cost of work during the month under consideration due to changes in rates for cement-</p> <p><math>C_0</math> = The all India wholesale price index for Ordinary Portland Cement on 28 days preceding the scheduled date of opening of technical bid as published by the <b>Office of the Economic Adviser, Department for Promotion of Industry and Internal Trade, Ministry of Commerce &amp; Industry.</b></p> <p><math>C_i</math> = The all India average wholesale price index for Ordinary Portland Cement for the month under consideration as published by <b>Office of the Economic Adviser, Department for Promotion of Industry and Internal Trade, Ministry of Commerce &amp; Industry.</b></p> <p><math>P_c</math> = Percentage of cement component of the work</p>	
	<p><b>Adjustment for steel component</b></p> <p>(iii) Price adjustment for increase or decrease in the cost of steel procured by the contractor shall be paid in accordance with the following formula-</p> $V_s = 0.85 \times (P_s/100) \times R \times (S_i - S_0)/S_0$ <p><math>V_s</math> = Increase or decrease in the cost of work during the month under consideration due to changes in the rates for steel</p> <p><math>S_0</math> = The all-India wholesale price index for steel (<b>Mild Steel - Long Products Rebars</b>) on 28 days preceding the date of opening of Bids as published by the <b>Office of the Economic Adviser, Department for Promotion of Industry and Internal Trade, Ministry of Commerce &amp; Industry.</b></p> <p><math>S_i</math> = The all India average wholesale price index for steel (<b>Mild Steel - Long Products Rebars</b>) for the month under consideration as published by <b>Office of the Economic Adviser, Department for Promotion of Industry and Internal Trade, Ministry of Commerce &amp; Industry.</b></p> <p><math>P_s</math> = Percentage of steel component of the work</p> <p>Note : For the application of this clause, the index of <b>Mild Steel - Long products Rebars</b> has been chosen to represent the steel group.</p>	
	<p><b>Adjustments of bitumen component</b></p> <p>(iv) Price adjustment for increase in the cost of bitumen shall be paid in accordance with the following formula</p> $V_b = 0.85 \times (P_b/100) \times R \times (B_i - B_0)/B_0$ <p><math>V_b</math> = Increase or decrease in the cost of work during the month under consideration due to changes in rates for bitumen-</p> <p><math>B_0</math> = The official retail price of bitumen at the IOC depot at the nearest centre on the day 28 days prior to the scheduled date of opening of technical bid-</p> <p><math>B_i</math> = The official retail price of bitumen of IOC depot at the nearest centre for the 15th day of the month under consideration-</p> <p><math>P_b</math> = Percentage of bitumen component of the work</p>	
	<p><b>Adjustment of POL (fuel and lubricant) component</b></p> <p>(v) Price adjustment for increase or decrease in cost of POL (fuel and lubricant) shall be paid in accordance with the following formula-</p> $V_l = 0.85 \times (P_l/100) \times R \times (F_i - F_0)/F_0$ <p><math>V_l</math> = Increase or decrease in the cost of work during the month under consideration due to changes in rates for fuel and lubricants-</p>	



	<p><math>F_0</math> = The official retail price of High Speed Diesel (HSD) at the existing consumer pumps of IOC at the nearest centre on the day 28 prior to the date of opening of Bids.</p> <p><math>F_i</math> = The official retail price of HSD at the existing consumer pumps of IOC at the nearest centre for the 15<sup>th</sup> day of the month of the under consideration.</p> <p><math>P_r</math> = Percentage of fuel and lubricants component of the work</p> <p>Note: For the application of this clause, the price of High Speed diesel Oil has been chosen to represent the fuel and lubricants group.</p>	
	<p><b>Adjustment for Construction Machinery</b></p> <p>(vi) Price adjustment for increase or decrease in the cost of plant and Machinery spare procured by the Contractor shall be paid in accordance with the following formula-</p> $V_p = 0.85 \times (P_p/100) \times R \times (P_i - P_0)/P_0$ <p><math>V_p</math> = Increase or decrease in the cost of work during the month under consideration due to changes in rates for plant and machinery spares</p> <p><math>P_0</math> = The all India wholesale price index for <b>manufacturer of machinery for mining, quarrying and Construction</b> for the month under consideration as published <b>Office of the Economic Adviser, Department for Promotion of Industry and Internal Trade, Ministry of Commerce &amp; Industry.</b></p> <p><math>P_i</math> = The all India average wholesale price index for <b>manufacturer of machinery for mining, quarrying and Construction</b> for the month under consideration as published <b>Office of the Economic Adviser, Department for Promotion of Industry and Internal Trade, Ministry of Commerce &amp; Industry.</b></p> <p><math>P_p</math> = Percentage of plant and machinery spares component of the work.</p> <p>Note: For the application of this clause, index of Heavy Machinery and parts has been chosen to represent the Plant and Machinery Spares group</p>	
	<p><b>Adjustment of other materials Component</b></p> <p>(vii) Price adjustment for increase or decrease in cost of local materials other than cement, steel, bitumen and POL procured by the contractor shall be paid in accordance with the following formula-</p> $V_m = 0.85 \times (P_m/100) \times R \times (M_i - M_0)/M_0$ <p><math>V_m</math> = Increase or decrease in the cost of work during the month under consideration due to change in rates for local materials other than cement, steel, bitumen and POL.</p> <p><math>M_0</math> = The All Indian wholesale price index (all commodities) on 28 days preceding the scheduled date of opening of technical Bids, as published by the <b>Office of the Economic Adviser, Department for Promotion of Industry and Internal Trade, Ministry of Commerce &amp; Industry.</b></p> <p><math>M_i</math> = The All India wholesale price index (all commodities) for the month under consideration as published by the <b>Office of the Economic Adviser, Department for Promotion of Industry and Internal Trade, Ministry of Commerce &amp; Industry.</b></p> <p><math>P_m</math> = Percentage of local material components (other than cement, steel, bitumen and POL) of the work.</p> <p>The following percentage will govern the price adjustment for the entire contract-</p> <ol style="list-style-type: none"> <li>1. Labour - <math>P_l</math> .....%</li> <li>2. Cement - <math>P_c</math> .....%</li> <li>3. Steel - <math>P_s</math> .....%</li> <li>4. Bitumen - <math>P_b</math> .....%</li> <li>5. POL - <math>P_f</math> .....%</li> <li>6. Plant &amp; Machinery Spares <math>P_p</math> .....%</li> </ol>	

	7. Other Materials - Pm .....%		
	-----		
	Total 100 %		
	-----		
25.	The proportion of payments retained (retention money) shall be 6% from each bill subject to a maximum of 5% of final contract price.		{CL. 48}
26.	Amount of Liquidated damages for delay in completion of works	For Whole of work {CL.49} (1/2000) th of the Initial contract price, rounded off to the nearest Thousand, per day. For sectional Completion (wherever specified In item 6 of Contract data) (1/2000) th of initial contract price for #5 km Section, rounded off to the nearest thousand per day.	
27.	Maximum limit of liquidated damages For delay in completion work	10 percent of the Initial {CL. 49} Contract Price rounded off to the nearest thousand	
28.	Amount of Bonus for early completion	Amount of bonus for early completion of work shall be given as per CL.50 of Section 3	
29.	Maximum limit of bonus for early Completion of work	5 percent of the Contract {CL. 50} Price	
30.	The amount of the advance payment are:-		{CL. 51 & 52}
	<b>Nature of Advances</b>		<b>Amount (Rs.) Conditions to Be fulfilled</b>
i	Mobilization	10% of the contract Price	On submission of unconditional Bank Guarantee. (to be drawn before the end of 20% of the contract period). The contractor may furnish four bank guarantees of 2.5 % of each valid for the full period.
ii	Equipment	90% for new and 50% of depreciated value for old equipment. Total amount will be subject to a maximum of 5% of the Contract Price.	After equipment is brought to site (provided the Engineer is satisfied That the equipment is required for performance of the contract) and on submission of unconditional Bank Guarantee for amount of advance.
iii	Secured Advance for Non-persish able material Brought to site	<b>Deleted</b>	

(The advance payment will be paid to the Contractor no later than 28 days after fulfilment of the above conditions).

### 31. Repayment of advance payment for mobilization and equipment {CL. 51.3}

The advance loan shall be repaid with percentage deduction from the interim payments certified by the Engineer under the Contract. Deduction shall commence in the next Interim Payment Certificate following that in which the total of all such payments to the Contractor has reached not less than 20 percent of the Contract Price or 6 (six) months from the date of payment of first instalment of advance, whichever period concludes earlier, and shall be

made at the rate of 20 percent **(collectively for both Mobilization Advance and Equipment Advance)** of the amounts of all Interim Payment Certificate until such time as the loan has been repaid, always provided that the loan shall be completely repaid prior to the expiry of the original time for completion pursuant to Clause 17 and 28.

32. Deleted

33. The securities shall be for the following minimum amounts equivalent {CL. 52}

As a percentage of the Contract Price:

Performance Security for 5 percent of contract price plus Rs. .... (to be decided after evaluation of the bid) as additional security in terms of ITB Clause 29.5

The standard form of Performance security acceptable to the Employer shall be an unconditional Bank Guarantee of the type as presented in Section 8 of the Bidding Documents.

34. The Schedule of Operating and maintenance Manuals.....N/A. {CL. 58}

35. The date by which “as- built” drawings (in scale as directed) in 2 sets {CL. 58} are required within 28 days of the issue of certificate of completion of the whole or section of the work, as the case may be.

36. The amount to be withheld for failing to supply “as built” drawings {CL. 58} by the Date required is Rs. .... Lakhs.

37. The following events shall also be fundamentals breach of contract: {CL.59.2} “The Contractor has contravened Sub- clause 7.1 and Clause 9 of GCC”

38. The percentage to apply the value of the work not completed representing {Cl 60} the Employer’s additional cost for completing the Works shall be 20 per cent.

**SECTION - 5**  
**TECHNICAL SPECIFICATION**  
**(Attached Separately)**

## SPECIFICATION OF MATERIALS

### **M-1 Water:**

1.1 The water shall not be salty or blackish and shall be clean, reasonably clear and free from objectionable quantities of silt and traces of oil and injurious alkalis, salty materials organic matter and other deleterious material which will either weaken the mortar of concrete or cause off florescence or attack the steel in R.C.C. Containing for transport, storage and handling of water shall be clean. Water shall conform to the Standard Specification IS-456-2000.

1.2 If required by the Engineer-in-charge, it shall be tested by comparison with distilled water. Comparison shall be made by means of standard cement tests for soundness, time of setting and mortar strength as specified in IS-269-1976 or latest revision. Any indication of unsoundness changes in time of setting by 30 minutes or more or decrease of more than 10 percent in strength of mortar prepared with water sample when compared with the results obtained with mortar prepared with distilled water shall be sufficient cause for rejection of water under test.

1.3 Water for curing mortar, concrete should not be too acidic or too alkaline. It shall be free of elements which significantly affect the hydration reaction or otherwise interfere with the hardening of mortar or concrete during curing or those which produce objectionable stains or other unsightly deposits on concrete or mortar surfaces.

1.4 Hard and bitten water shall not be used for curing.

1.5 Potable water will generally find suitable for curing of concrete.

1.6 For soluble impurities the following table represents the maximum permissible values.

Organic	0.02%
Inorganic	0.30%
Sulphate	0.05%
Chlorides	0.10 %
PH Value	6 to 8

For details IS : 456-2000 shall also be referred.

### **M-2 Cement:**

(a) Only Ordinary Portland Cement (OPC) of approved brand shall be used for all items of mortar, concrete and RCC work from approved cement plants as per Clause 17.1(A) of Volume One-B.

(b) Contractor shall only be permitted to use Ordinary Portland Cement (OPC) from approved cement manufacturer approved by the SSNNL. The contractor shall note this and arrangement for procurement of cement shall have to be made accordingly.

However, if required Nigam may direct to the contractor for the use of any kind of suitable cement confirming to relevant IS on the basis of the test results of soil in contact with the concrete, water and aggregates during the course of execution.

The contractor shall have to make arrangements for procurement of cement from approved manufactures accordingly.

(c) The contractor shall create a suitable and adequate infrastructure for procuring, handling, storing and conveying of cement at site as approved by the Engineer-in-charge.

(d) The cement to be used on work shall be brought sufficient in advance before using the cement in works so that SSNNL can conduct minimum required test to ascertain its quality. The Contractor shall also furnish the manufacturer's test results conducted at the factory site in the manufacturer's quality control laboratory for each batch of cement which is brought to the site.

Frequency for cement testing (Physical properties) are as under as per IS : 3535-1986.

(e) Cement older than 90 days shall not be used unless the test results satisfy the minimum strength requirement.

**M-3 Sand:**

Weight of lot in tonne	No. of Samples to be taken	Remarks
Up to 20	2	The frequency for chemical testing for cement to be decided by the Engineer-In-Charge as per requirement
21 to 50	3	
51 to 100	4	
101 to 200	5	
201 to 300	6	
301 to 500	7	

**1 Fine Aggregate**

**(i) General**

(a) All the aggregates shall conform to IS : 383-1970, or its latest version and as directed by Engineer-In-Charge. Sand to be used shall be natural as obtained from the riverbed and the maximum size shall be limited to 4.75 mm. Fine aggregates will be tested for their gradation, specific gravity, water absorption, fineness modulus, soundness, petro-graphic analysis, deleterious constituents and alkali aggregate reactivity. Due allowance shall be made if at the time of mixing, the sand is wet. The exact extent of such allowance or bulkage shall depend upon the quantity of moisture in sand and it shall be decided by the Engineer-In-Charge.

**(ii) Quality**

(a) Sand shall consist of hard, inert, dense, durable and uncoated siliceous gritty materials. It shall be free from injurious amount of dust, lumps soft and flaky particles, shale, alkali, organic matter, loam and other deleterious substances. The maximum percentage of each of the deleterious substance in sand as delivered to the mixer shall not exceed the following values Limits of deleterious material

(i)	Coal & lignite	1.0 Percent by weight
(ii)	Clay lumps	1.0 Percent by weight
(iii)	Material finer than 75 micron I.S sieve	3.0 Percent by weight
(iv)	Shale	1.0 Percent by weight
(v)	Total of percentages of all deleterious material (except Mica)	5.0 Percent by weight

(b) Sand shall be free from injurious amount of organic impurities and sand that are producing a colour (obtained by dissolving 9 grams of chemically pure (c.p.) ferric chloride and 1 gram of (c.p.) cobalt chloride in 100 ml of water to which one third ml of hydro chloric

acid has been added) darker than the standard in the test (organic test) for organic impurities shall be rejected.

(iii) Grading

(a) Sand shall be well graded so as to impart good workability and good finishing. Sieve analysis of natural sand shall conform to the following limits of gradation.

IS Sieve	Cumulative percentage of weight passing through sieve
10 mm	100
4.75 mm	92-100
2.36 mm	75-92
1.18 mm	55-82
600 microns	30-64
300 microns	10-40
150 microns	3-10

(b) Deviations from the prescribed limits of cumulative percentage retained on sieve 10 mm, 4.75 mm, 2.36 mm, 1.18 mm, 600-micron, 300 micron and 150 micron IS sieves shall be permitted provided total of such deviations do not exceed 5 percent. No deviation from the prescribed limit shall be permitted for cumulative percentage retained on 600 micron IS Sieve.

(iv) Fineness Modulus

(a) Sand shall have a fineness modulus between 2.4 to 3.0 subject to the gradation specified in the preceding paragraph.

The modulus shall be computed by adding cumulative percentage of sand retained on the standard screens 4.75 mm, 2.36 mm, 1.18 mm, 600-micron, 300-micron, 150-micron IS sieves and dividing the sum by 100. Gradation of sand shall be so controlled that the fineness modulus of at least 9 out of 10 consecutive test samples of finished sand shall not vary by more than 0.10 from the average of 10 test samples. Sand having any deviation from the specified range of gradation and fineness modulus shall not be permitted to be used in work without the written permission of the Engineer-In-Charge.

(V) Testing

The following testing frequencies shall be maintained for the same source of Fine Aggregates :

Sr. No.	Name of Test	Minimum number of tests specified
1.	Gradation for fineness Modulus	Daily one test. If the variation of daily F.M. values is more than 0.1, then frequencies may be increased
2.	Silt Content	Daily one test
3.	Moisture Content	Daily one test
4.	Sp. gravity and water absorption soundness, alkali-aggregate reactivity, Petrographic examination	Twice in a concreting working season.

(vi) Storage

All sand shall be stored on the site of work in such a manner as to prevent intrusion of foreign matter.

**M-4 Stone Coarse Aggregate for Nominal Mix Concrete:**

4.1 Coarse aggregate shall be of machine crushed stone of black trap or equivalent and be hard, strong, dense, durable, clean and free from skin and coating likely to prevent proper adhesion of mortar.

4.2 The aggregate shall generally be cubical in shape. Unless special stones of particular quarries are mentioned aggregates shall be machine crushed from the best black trap or equivalent hard stone as approved. Aggregate shall have no deleterious reaction with cement. The size of the coarse aggregate for plain cement concrete and ordinary reinforced cement concrete shall generally be as per the table given below. However, in case of reinforced cement concrete the maximum limit may be restricted to 6 mm less than the minimum lateral clear distance between bars or 6 mm less than the cover whichever is smaller.

**TABLE**

I.S. sieve Design-n-ation	Percentage passing for single sized aggregates of Nominal size			I.S. sieve Design-n-ation	Percentage passing for single sized aggregates of Nominal size		
	40 mm	20 mm	16 mm		40 mm	20 mm	16 mm
80 mm	--	--	--	12.5 mm	--	--	--
63 mm	100	--	--	10 mm	0.5	0.20	0.30
40 mm	85-100	100	--	4.75mm	--	0.5	0.5
20 mm	0-20	85-100	100	2.35 mm	--	--	--

Note : This percentage may be varied somewhat by the Engineer-in-charge / Architect appointed by the SSNNL when considered necessary for obtaining better density and strength of concrete.

4.3 The grading test shall be taken in the beginning and at the change of source of materials. The necessary tests indicated in I.S. 383-1970 and I.S. 456-1978 shall have to be carried out



to ensure the acceptability. The aggregates shall be stored separately and handled in such a manner as to prevent the intermixing of different aggregates. If the aggregates are covered with dust, they shall be washed with water to make, them clean.

#### 4.4 Testing.

The following testing frequencies shall be maintained for the same source of coarse aggregates.

Sr. No.	Name of Test	Minimum number of tests specified.
1	Gradation	Daily one test for each nominal size of aggregates.
2	Water Content	Daily one test for each nominal size of aggregates.
3	Silt Content	Daily one test for each nominal size of aggregates.
4	Sp. gravity and water Absorption, Impact or Abrasion value, Density, Soundness, Alkali aggregate reactivity, Petro-graphic examination.	Twice in a concreting working season.

#### 4.5 Storage

- (a) The aggregate shall be stacked in such a way as to prevent the admixture of foreign materials such as soil, vegetable matter etc. Heaps of fine and coarse aggregates shall be kept separate. When different sizes of fine or coarse aggregate are procured separately, they shall be stored in separate stockpiles, sufficiently away from each other to prevent the materials at the edge of the piles from getting intermixed.
- (b) The aggregates shall be stockpiled adjacent to the mixer site so as to require minimum rehandling and labour when conveyed to the mixer.
- (c) The aggregates shall be placed on a dry hard patch of ground if available otherwise a platform of planks or plain galvanized iron sheets or alternatively on a floor of dry bricks or a thin layer of lean concrete.
- (d) The aggregates shall be kept free of dirt, rubbish, papers, vegetable matter etc.
- (e) To minimize moisture variations the stock piles shall be spread over as large in area as possible but kept low and fairly uniform in height preferably 1.25 to 1.50 meter and the lowest layer of about 30 cm height shall be allowed to act as drainage layer and not used till the

**SECTION - 6**  
**FORM OF BID**

**FORM OF BID**

Description of the Works:

-----  
-----  
-----

BID

To :

Address :

- 1. We offer to execute the Works described above and remedy any defects therein in conformity with the conditions of Contract, specification, drawings, Bill of Quantities and Addenda for the sum (s) of

\_\_\_\_\_  
\_\_\_\_\_  
(----- )

- 2. We undertake, if our Bid is accepted, to commence the Works as soon as is reasonably possible after the receipt of the Engineer's notice to commence, and to complete the whole of the Works in the Contract within the time stated in the document.
- 3. We agree to abide by this Bid for the period of 120 Days from the date fixed for receiving the same, and it shall remain binding upon it and may be accepted at any time before the expiration of that period.
- 4. Unless and until a formal Agreement is prepared and executed this Bid, together with your written acceptance thereof, shall constitute a binding contract between us.
- 5. We understand that you are not bound to accept the lowest or any tender you may receive.

Dated this----- day of----- 20

Signature ----- in the capacity of-----  
----- duly authorized to sign bids for and on behalf of-----  
-----

(in block capitals or typed)

Address

---

---

Witness

---

---

Address

---

---

Occupation

---

---

**SECTION - 7**  
**BILL OF QUANTITIES**

## BILL OF QUANTITIES

### Preamble

1. The bill of Quantities shall be read in conjunction with the Instructions to Bidder, Conditions of Contract, Technical Specifications and Drawings.
2. The quantities given in the Bill of Quantities are estimated and provisional, and are given to provide a common basis for bidding. The basis of payment will be the actual quantities of work ordered and carried out, as measured by the Contractor and verified by the Engineer and valued at the rates and prices tendered in the priced Bill of Quantities, where applicable, and otherwise at such rates and prices as the Engineer may fix within the terms of the Contract.
3. The rates and prices tendered in the priced Bill of Quantities shall, except in so far as it is otherwise provided under the Contract, include all constructional plant, layout, supervision, materials, erection, maintenance, insurance, profit, taxes and duties, together with all general risks, liabilities and obligations set out or implied in the Contract.
4. The rates and prices shall be quoted entirely in Indian Currency.
5. A rate or prices shall be entered against each item in the Bill Quantities, whether quantities are stated or not. The cost of Items against which Contractor has failed to enter a rate or price shall be deemed to be covered by other rates and prices entered in the Bill of Quantities (in case of Item rate contract).
6. The whole cost of complying with the provisions of the Contract shall be included in the items provided in the priced Bill of Quantities, and where no Items are provided the cost shall be deemed to be distributed among the rates and prices entered for the related items of Work.
7. General direction and descriptions of work and materials are not necessarily repeated or summarized in the Bill of Quantities. References to the relevant sections of the contract documentation shall be made before entering rates or prices against each item in the Bill of Quantities.
8. The method of completed work of payment shall be in accordance with the specification for Road and Bridge works. For building works specifications for building are to be followed.
9. Errors will be corrected by the Employer for any arithmetic errors pursuant to **Clause 29** of the Instructions to Bidder.
10. Rock is defined as all materials which, in the opinion of the Engineer, required blasting, or the use of metal wedges and sledgehammers, or the use of compressed air drilling for its removal, and which cannot be extracted by ripping with a tractor of at least 150 kw with a single rear mounted heavy duty ripper.

**BILL OF QUANTITIES**

**(A) Percentage Rate Tender (Up to INR 50 Cr.)**

Item No	Description of Item (with brief specification and reference to book of specifications)	Quantity	Unit	Rate In figures	Amount
	<b>Attached Separately</b>				

I/We am/are willing to carry out the work at..... % above/below percent (Should be written in figures and words) of the estimated rate mentioned above. Amount of my /our tender works out as under.

Estimated amount put to tender

Estimated amount put to tender

Deduct.....% below

Add.....% Above

Net

Net

In words

In words

**(B) For Item Rate Tender (For above INR 50 Cr.):**

Item No	Description of Item (with brief specification and reference to book of specifications)	Quantity	Unit	Rate		Amount
				In figures	In Words	

(A) Total Tendered Amount

(B) Rebate on above tendered amount (if any) % (in figure) .....  
(in words) .....

(C) Net Tendered Amount (A-B) (in figure) .....  
(in words) .....

#

1	The Contractor shall exhibit a board with brief details of work as directed by the Engineer-In-Charge for which no extra payment shall be made.
2	The labour cess will be deducted as per prevailing rules i.e. 1% of the work done.
3	GST and Income tax TDS will be deducted at a source while making payments of bills
4	In all R.C.C. Items in Rate Analysis Standard Cement Consumption has been taken as per Govt. G.R. NO.: MIS102010/17/K1 Dated:30/07/2018 as stated in S.O.R. therefore in R.C.C. items where there is a change as per actual mix design the cost of difference of cement consumption have been deducted from the rate of original item at the rate of input rate mentioned in all the tender.

**SECTION - 8**  
**SECURITIES AND OTHER FORMS**



**BID SECURITY (BANK GUARANTEE)**

WHEREAS, ----- (name of Bidder) (hereinafter called the "The Bidder") has submitted his bid Dated ----- (Date) for the construction of ----- (Name of Contractor hereinafter called "the Bid")

KNOW ALL PEOPLE by these presents that We ----- (name of Bank) of----- (name of country) having our registered office at ----- ( hereinafter called "the bank") are bound unto ----- (name of Employer) (hereinafter called "The Employer") in the sum of ----- \* for which payment well and truly to be made to the said Employer the Bank itself, his successors and assigns by these presents.

SEALED with the Common Seal of the said Bank this ----- day of----- 20

THE CONDITIONS of these obligations are:

(1) If after Bid opening the Bidder withdraws his bid during the period of Bid validity specified in the Form of Bid;

(ii) **Or**

(2) If the Bidder has been notified of the acceptance of his bid by the Employer during the period of Bid Validity:

A Fails or refuses to execute the Form of Agreement in accordance with the Instructions to Bidders, if required; or

B. Fails or refuse to furnish the Performance Security, in accordance with the Instructions to Bidders; or

C. does not accept the correction of the Bid Price pursuant to Clause 27 (Correction of Errors)

We undertake to pay to the Employer up to the above amount upon receipt of his first written demand, without the employer having to substantiate his demand, provided that in his demand the Employer will note that the amount claimed by him is due to him owing to the occurrence of one or any of the three conditions, specifying the occurred conditions or conditions.

This Guarantee will remain in force up to and including the date ----- \*\*  
days after the deadline for submission of Bids as such the deadline is stated in the  
Instructions to Bidders or as it may be extended by the Employer, notice of which  
extension (s) to the Bank is hereby waived. Any demand in respect of this  
guarantee should reach the Bank not later than the above date

DATE -----

SIGNATURE-----

WITNESS -----

SEAL -----

---

(Signature, name and address)

\* The Bidder should insert the amount of the guarantee in words and figures  
denominated in Indian Rupees. This figure should be the same as shown in  
Clause 16.1(Bid Security) of the Instructions to Bidders.

**\*\*45 days** after the **end of the validity period** of the Bid. Date should be inserted  
by the Employer before the Bidding documents are issued.

**PERFORMANCE SECURITY**

TO,

----- (Name of Employer)  
----- (Address of Employer)  
-----

WHEREAS ----- (name and address of contractor) (hereafter called "the Contractor") has undertaken, in pursuance of Contracts No. ----- dates ----- to execute ----- (name of Contract and brief description of Works) (hereinafter called "The Contract")

AND WHEREAS it has been stipulated by you in the said Contract that the Contractor shall furnish you with a Bank Guarantee by a recognized bank for the sum specified therein as security for compliance with his obligation in accordance with the Contract.

AND WHEREAS we have agreed to give the Contractors such a bank Guarantee:

NOW THEREFORE we hereby affirm that we are the Guarantor and responsible to you on behalf of the Contractor, up to a total of ----- (amount of guarantee)\* ----- (in words), such sum being payable in types and proportions of currencies in which the Contract prices is payable, and we undertake to pay you, upon your first written demand and without cavil or argument, any sum or sums within the limits of ----- (amount of guarantee) as aforesaid without your needing to prove or to show grounds or reasons for your demand for the sum specified therein.

We hereby waive the necessity of your demanding the said debt from the contractor before presenting is with the demand.

We further agree that no change or addition to or other modification of the terms of the Contract to of the Works to be performed thereunder or of any of the Contract documents which may be made between your and the Contractor shall in any way release us from any liability under this guarantee, and we hereby waive notice of any such charge, addition or modifications.

This guarantee shall be valid until 60 days from the date of expiring of the Defect Liabilities period.

Signature and Seal of the guarantor -----

Name of Bank -----

Address -----

Date -----

\*An amount shall be inserted by the Guarantor, representing the percentage the Contract price specified in the Contract denominated in Indian Rupees.

**ADDITIONAL PERFORMANCE SECURITY**

[Clause 34.1. (A)]

TO,

----- (Name of Employer)  
----- (Address of Employer)  
-----

WHEREAS ----- (Name and address of contractor) (hereafter called "The Contractor") has undertaken, in pursuance of Contracts No. ----- dates ----- to execute ----- (Name of Contract and brief description of Works) (hereinafter called "The Contract")

AND WHEREAS it has been stipulated by you in the said Contract that the Contractor shall furnish you with a Bank Guarantee by a recognized bank for the sum specified therein as security for compliance with his obligation in accordance with the Contract.

AND WHEREAS we have agreed to give the Contractors such a bank Guarantee:

NOW THEREFORE we hereby affirm that we are the Guarantor and responsible to you on behalf of the Contractor, up to a total of ----- (amount of guarantee) ----- (in words), such sum being payable in types and proportions of currencies in which the Contract prices is payable, and we undertake to pay you, upon your first written demand and without cavil or argument, any sum or sums within the limits of ----- (amount of guarantee) as aforesaid without your needing to prove or to show grounds or reasons for your demand for the sum specified therein.

We hereby waive the necessity of your demanding the said debt from the contractor before presenting is with the demand

We further agree that no change or addition to or other modification of the terms of the Contract to of the Works to be performed thereunder or of any of the Contract documents which may be made between your and the Contractor shall in any way release us from any liability under this guarantee, and we hereby waive notice of any such charge, addition or modifications.

This guarantee shall be valid until **28 days** from the project completion date.

Signature and Seal of the guarantor -----

Name of Bank -----

Address -----

Date -----

**BANK GUARANTEE FOR ADVANCE PAYMENT**

TO,

----- (Name of Employer)

----- (Address of Employer)

----- (Name of Contractor)

Gentlemen:

In accordance with the provisions of the Conditions of Contract, sub-clause 51.1 ("Advance Payment") of the above mentioned Contract, ----- (name and address of Contractor) (hereinafter called "the Contractor") shall deposit with----- (name of Employer) a bank guarantee his proper and faithful performance under the said Clause of the Contract in an amount of----- (amount of Guarantee)\* - -----in words).

We, the----- (bank of financial institution), as instructed by the Contractor, agree unconditionally and irrevocably to guarantee as primary obligator and not as Surety merely, the payment to ----- (name of Employer) on his first demand without whatsoever right of obligation on our part and without his first claim to the Contractor, in the amount not exceeding --- ----- (amount of guarantee)\* ----- (in words)

We further agree that no change or addition to or other modifications of the terms of the Contractor or Works to be performed thereunder or of any of the Contract documents which may be made between ----- (name of Employer) and the Contractor, shall in any way release us from any liability under this guarantee, and we hereby waive notice of any such change, addition or modifications.

This guarantee shall remain valid and in full effect from the date of the advance payment under the Contract until ----- (name of employer) receives full repayment of the same amount from the contractor.

YOUR'S TRULY

Signature and Seal \_\_\_\_\_

Name of Bank/ Financial Institution \_\_\_\_\_

Address \_\_\_\_\_ Date \_\_\_\_\_

\* An amount shall be inserted by that Bank or Financial Institution representing the amount of the Advance Payment, and denominated in Indian Rupees.

**Letter of Acceptance**

(Letter head paper of the Employer)

To, \_\_\_\_\_(date)  
\_\_\_\_\_  
\_\_\_\_\_(Name and address of the Contractor)  
\_\_\_\_\_  
\_\_\_\_\_

Dear Sir,

This is to notify you that your Bid dated \_\_\_\_\_for execution of the \_\_\_\_\_(Name of the contract and identification number, as given in the Instructions to Bidders) for the Contract Price of Rupees \_\_\_\_\_ ( \_\_\_\_\_) (amount in words and figures) as corrected and modified in accordance with the Instructions to Bidders\* is hereby accepted by our agency.

You are requested to furnish performance security, in the form detailed in para 34.1 of ITB for an amount equivalent to Rs.\_within **10 days** of the receipt of this letter of acceptance up to beyond **60 days** from the date of expiry of defects Liability period i.e. up to \_\_\_\_\_and the Additional Performance Security for an amount equivalent to Rs. \_\_\_\_\_shall be valid beyond 28 (twenty-eight) days of Project Completion Date i.e. up to \_\_\_\_\_and sign the contract, failing which action as stated in Para 34.3 of ITB will be taken.

Yours Faithfully

Authorized Signature  
Name and title of Signatory  
Name of Employer

---

\* Delete "Corrected and" or and modified if only one of these actions applies. Delete as corrected and modified in accordance with the Instructions to Bidders, if corrections or modifications have not been affected.

**Issue of Notice to proceed with the work**

(Letterhead of the Employer)

To, \_\_\_\_\_ (date)

\_\_\_\_\_(Name and address of the Contractor)

\_\_\_\_\_

\_\_\_\_\_

Dear Sirs,

Pursuant to your furnishing the requisite security in ITB Clause 34.1 and signing of the Contract for the construction of \_\_\_\_\_

\_\_\_\_\_

\_\_\_\_\_ at a bid Price of Rs.

\_\_\_\_\_.

You are hereby instructed to proceed with the execution of the said works in accordance with the contract documents.

Yours faithfully

(Signature, name and title of signatory authorized  
To sign on behalf of Employer)

## AGREEMENT FORM

This agreement, made on the \_\_\_\_\_ day of \_\_\_\_\_ between \_\_\_\_\_ (name and address of Employer) (Hereinafter called "the Employer) and \_\_\_\_\_ (name and address of contractor) hereinafter called "the Contractor" of the other part.

Whereas the Employer is desirous that the Contractor execute

\_\_\_\_\_  
Name and identification number of contract (hereinafter called "the works") and the employer has accepted the Bid by the Contractor for the execution and completion of such works and the remedying of any defects therein, at a cost of Rs.

\_\_\_\_\_  
NOW THIS AGREEMENT WITNESSETH AS FOLLOWS

1. In this Agreement, words and expression shall have the same meanings as are respectively assigned to them in the conditions of contract hereinafter referred to and they shall be deemed to form and be read construed as part of this Agreement.
2. In Consideration of the payment to be made by the Employer to the contractor as hereinafter mentioned, the Contractor hereby covenants with the Employer to executive and complete the works and remedy any defects therein in conformity in all aspects with the provisions of the contracts.
3. The employer hereby covenants to pay the Contractor in consideration of the execution and completion of the works and the remedying the defects wherein contract price or such other sum as may become payable under the provisions of the Contract at the times and in the manner prescribed by the contract.
4. The Following documents shall be deemed to form and be ready and construed as part of this Agreement viz
  - i ) letter of Acceptance
  - ii ) Notice to proceed with the works:
  - iii ) Contractor's Bid



- iv ) Conditions of contract: General and Special
- v ) Contract Data
- vi) Additional conditions
- vii ) Drawings
- viii ) Bill of Quantities and
- ix ) Any other documents listed in the Contract data as forming part of the Contract.

In witness whereof the parties there to have caused this Agreement to be executed the day and year first before written

The Common seal of \_\_\_\_\_

Was hereunto affixed in the presence of :

Signed, sealed and Delivered by the said \_\_\_\_\_

---

In the presence of

Binding signature of Employer \_\_\_\_\_

Binding Signature of Contractor \_\_\_\_\_

**UNDERTAKING**  
**(For Investment)**

I, the undersigned do hereby undertake that our firm M/s  
..... would invest a minimum cash up  
to **25%** of the value of the work during implementation of the contract.

\_\_\_\_\_  
(Signed by an Authorized officer of the firm)

\_\_\_\_\_  
Title of officer

\_\_\_\_\_  
Name of firm

\_\_\_\_\_  
DATE

**UNDERTAKING  
(For Validity)**

I, the undersigned do hereby undertake that our firm M/s .....  
..... agree to abide by this bid for a period     day for date fixed  
for receiving the same and it shall be binding on us and may be accepted at any time before  
the expiration of that period.

\_\_\_\_\_  
(Signed by an Authorized officer of the firm)

\_\_\_\_\_  
Title of officer

\_\_\_\_\_  
Name of firm

\_\_\_\_\_  
DATE

**SECTION - 9**  
**DRAWINGS**  
**(Attached Separately)**

**SECTION - 10**  
**DOCUMENTS TO BE FURNISHED BY BIDDER**

**Documents Submit By Bidder along with tender documents**  
**(Also Upload along online during Bid Submission)**

<b>Sr. No.</b>	<b>Name of Documents.</b>	<b>Reference Clause.</b>	<b>Reference Format Page No.</b>
1	Bid Document Fee/Tender Fee	As per NIT	-
2	Bid Security / EMD or Valid EMD Exemption Certificate or in terms of Bank guarantee (valid 165 days from the date of bid submission) of Appropriate Class of Registration of Approved Contractors	As per Table of IFB Refer clause no. 16 for provision of Bank guarantee	-
3	Registration Certificate of Appropriate Class	As per NIT	-
4	GST Number and Pan card	As per NIT	-
5	A solvency certificate of an 20% of the Tender Amount of Scheduled Bank or Nationalized Bank or Bank Approved for Government business	As per NIT	-
6	Copy of Partnership Deed or Memorandum as well as Articles of Association	As per NIT	-
7	Power of Attorney (if Applicable)	As per NIT	-
8	Last Three Financial Year IT Return.	As per NIT	-
9	Undertaking for Engaging Technical Staff & Machineries	As per NIT	98
10	Information regarding any litigation in which the applicant is involved	As per NIT	99
11	Turn Over (as per P.Q.)	As per ITB Clause no 4.7 Bid Capacity	100
12	Details of “works on hand” and “works tendered by bidder, found lowest (l1) & works likely to be awarded (for Bid Capacity Evaluation)	As per ITB Clause no 4.7 Bid Capacity	101
13	Undertaking on statement of compliance of clause 3.2	-	102
14	Affidavit	-	103
15	Form of Bid	-	
16	Undertaking for bid Validity	-	

**UNDERTAKING FOR ENGAGING TECHNICAL STAFF & MACHINERIES**

I/We.....Age..... Business (Name of Firm)  
.....Address.....  
..... Hereby declare, that if our offer for the work of  
.....  
..... would accepted by the competent authority & Awarded to us, I/We will engage & employ the technical staff and machineries on site of work, required to complete the work successfully within time limit.

Signature of Bidder

Place:-.....

Date:-.....

**INFORMATION ON LITIGATION HISTORY**

Other Party (ies)	Employer	Cause of Dispute	Amount Invol	Remarks showing Present

DATE:  
BIDDER

SIGNATURE OF

**Notes:**

1. Describe Company's history of litigation or arbitration from contract executed in the last ten years or currently under execution. Please indicate for each case the year, name of employer, cause of litigation, matter in dispute, disputed amount, and whether the award was for or against the company.
2. Please add any further information that you may consider to be relevant to the evaluation of your application. If you wish to attach other documents, please list below:



## **DETAILS OF LAST FIVE YEAR'S CIVIL ENGINEERING WORKS TURNOVER**

1	Name of Firm		
2	Name of Partner/ Director		
3	Turnover for the Last Five Years, the Contract Receipts of Civil Engineering works.		
Sr. No.	Year	Multiplying Factor	Annual Turnover (Rs in Lakhs)
(1)	2018-2019	1.61	
(2)	2019-2020	1.46	
(3)	2020-2021	1.33	
(4)	2021-2022	1.21	
(5)	2022-2023	1.10	
(6)	2023-2024 (Base year)	1.00	

Signature

(Stamp of Chartered Accountant)

Unique Document Identification  
Number: -

### **Notes:**

1. Bidder shall also attach completion certificate (preferably in form-3A) for all the works listed in above table.

**DETAILS OF “WORKS ON HAND” AND “WORKS TENDERED BY BIDDER, FOUND LOWEST (L1) & WORKS LIKELY TO BE AWARDED”**

Sr. No.	Name of Work	Place	PART- I Work on Hand					PART-II Works tendered by bidder, found lowest (L1) & Works likely to be awarded				Remarks
			Tendered amount Rs, in Lakh	Date of issue of Work order	Stipulated period of completion (date)	Cost of work remaining to be executed as on the preceding month to the bid invitation month. Rs, in Lakh	Cost of work remaining to be executed During the time limit of an invited bid Rs. In Lakh	Tender Cost Rs. In Lakh	Time limit of work In Months	Date when decision is expected for award of work	Cost of work to be executed during the time limit of the invited bid. Rs, in Lakh	
[1]	[2a]	[2b]	[3]	[4]	[5]	[6]	[7]	[8]	[9]	[11]	[12]	[13]
1												
2												
3												

DATE:

SIGNATURE OF BIDDER

**Notes:**

1. For Part-I, the bidder shall furnish necessary certificates/documents from the concerned department.
2. In Part-II, the bidder shall furnish information for the other tenders wherein bidder's offer is found L1.

**UNDERTAKING ON STATEMENT OF COMPLIANCE OF CLAUSE 3.2**

I/We.....Age.....  
Business (Name of Firm) .....  
Address .....  
Hereby declare, that for the work of .....

.....  
I/We (Bidder) is neither associated, nor has been associated, directly or indirectly, with the consultant or any other entity that has prepared the design, specifications, and other documents for the Project or being proposed as Project Manager for the Contract. A firm that has been engaged by the Employer to provide consulting services for the preparation or supervision of the works, and any of its affiliates, shall not be eligible to bid.

Signature of Bidder

Place:- .....

Date:- .....

---

## AFFIDAVIT

1. I, the undersigned, do hereby certify that all the statements made in the required attachments are true and correct.
2. The undersigned also hereby certifies that neither our firm M/s. \_\_\_\_\_  
\_\_\_\_\_ have not abandoned any work of Government of Gujarat/Government of India/any Board or Corporation under Government of Gujarat/Government of India nor any contract awarded to us for such works have been rescinded, during last five years prior to the date of this bid.
3. The undersigned hereby authorize(s) and request (s) any bank, person, firm or corporation to furnish pertinent information deemed necessary and requested by the Department to verify this statement or regarding any (our) competence and general reputation.
4. The Undersigned understands and agrees that further qualifying information may be requested, and agrees to furnish any such information at the request of the Department/ Project implementing agency.

\_\_\_\_\_  
(Signed by an Authorized Officer of the Firm)

\_\_\_\_\_  
Title of Officer

\_\_\_\_\_  
Name of Firm

\_\_\_\_\_  
Date

**Letter of transmittal signed by authorized signatory**  
**(MODEL AUTHORISATION LETTER TO BE PROVIDED BY THE AUTHORISED**  
**SIGNATORY OF THE COMPANY/FIRM/OTHER ASSOCIATION OF PERSONS, ETC. ON ITS**  
**LETTER HEAD)**

**TO BE PROVIDE AFTER ISSUE OF WORK ORDER**

I/We..... do hereby authorize  
Mr./Ms..... whose signature is set out below,  
to represent me/us in connection with obtaining for the work of  
..... He/she is duly authorized to sign all necessary  
correspondence in this regard on our behalf His/her explanations / statements will be  
binding on me/us without exception.

SPECIMEN SIGNATURE OF AUTHORISED  
SIGNATORY

(Signature of Authorizing Authority)

Name & Designation (with seal)

Place:  
Date:

# BHAVNAGAR MUNICIPAL CORPORATION



## Bid Documents For

PROPOSED DOG HOME SHELTER & ANIMAL VACCINATION CENTRE  
AT NARI ROAD, KUMBHARWADA, BHAVNAGAR, DIST. BHAVNAGAR

## NOTICE INVITING TENDER & QUALIFICATION CRITERIA

**ARCHITECTS:**  
MANISH RUPARELIA PVT. LTD.  
901-902, Time Square,  
Ayodhya Circle, 150 Feet Ring  
Road, Rajkot 360 006

**EXECUTIVE ENGINEER**  
Building Department  
Bhavnagar Municipal Corporation  
Mangalsinhji Road,  
Bhavnagar – 364 001

**BHAVNAGARMUNICIPALCORPORATION****NoticeInvitingOn-LineTender****TenderNoticeNo. BUILDING / E-1/ 2024-25**

<b>DepartmentName</b>	:	<b>BuildingDepartment</b>
<b>IFBNo.</b>	:	<b>BUILDING / E-1/ 2024-25</b>
<b>NameofProject</b>	:	SJMMSVY
<b>NameofWork</b>	:	PROPOSED DOG HOME SHELTER & ANIMAL VACCINATION CENTRE AT NARI ROAD, KUMBHARWADA, BHAVNAGAR, DIST. BHAVNAGAR
<b>TenderType</b>	:	Open – Percentage rate Tender
<b>EstimatedContractValue(INR)</b>	:	<b>Rs.68855313.00/- (Excl. of GST)</b>
<b>PeriodofCompletion(inmonth)</b>	:	30 (Thirty) Months including Monsoon period
<b>BidderNationality</b>	:	LCB (LocalCompetitionBidding)
<b>QualificationOfBidder</b>	:	DulyregisteredwithR&BinClass“A” Class & Above and Special in Building Construction
<b>BidCall(Nos)</b>	:	<b>1</b>
<b>TenderCurrencyType</b>	:	Single
<b>TenderCurrencySettings</b>	:	IndianRupee(INR)
<b>JointVenture/Consortium</b>	:	N.A.
<b>Rebate</b>	:	N.A.
<b>AmountDetails</b>		
<b>BidDocumentFee</b>	:	Rs.12000.00 + 2160.00 (18% gst) = 14160.00 in the Form of DD only/- (Rs. Fourteen Thousand One Hundred and Sixty Only)
<b>BidDocumentFeePayableTo</b>	:	Commissioner, Municipal Corporation, Bhavnagar
<b>BidSecurity /EMD(INR)</b>	:	Rs.688553.00/- (Rs. Six Lakhs Eighty-Eight Thousand Five Hundred Fifty-Three Only.) (only D.D.)

<b>Bid Security/EMD in favour of</b>	: Commissioner, Municipal Corporation, Bhavnagar
<b>Tender Dates</b>	
<b>Bid Document Downloading Start Date</b>	: Dt. 28/11/2024
<b>Bid Document Downloading End Date</b>	: Dt. 19/12/2024 18:00
<b>Pre-Bid Meeting &amp; Time</b>	: Dt. 05/12/2024 11:45Am (office of the City Engineer, Municipal Corporation, Bhavnagar)
<b>Last Date &amp; Time of Online Bid Submission</b>	: Dt. 19/12/2024 18:00
<b>Physical Submission of EMD Document Fee PQ Bid &amp; Supporting all documents</b>	: Dt. 19/12/2024 to Dt. 26/12/2024 up to 06:10pm office of the Executive Engineer, Building Department, BMC-Bhavnagar
<b>Opening of PQ Bid (Online) &amp; Technical Bid</b>	: Dt. 27/12/2024, 17:00
<b>Penalty</b>	0.10 % of contract value per day to the maximum amount of 10% of contract value
<b>Opening of Price Bid (Online)</b>	: Intimation through letter.
<b>Bid Validity Period</b>	: 180 Days
<b><u>Qualification of Bidder:</u></b>	<p>Tenderer shall be required to submit the enlisted documents in hard copy along with the Qualification Bid. If documents are insufficient or it does not match the required criteria mentioned below, then the Price Bid of the tenderer shall not be opened.</p> <p>Mainly tenderer shall fulfill following Technical &amp; Financial pre-qualification criteria as a main contractor. The tenderer shall fulfill the following all points A to Q requirements / experiences for qualification.</p> <p>A. The Bidder must have achieved average annual turnover during last three financial years, ending on 31st March 2024 of Rs. 206.57 LACS.</p>



B. The Bidders shall have positive Net worth for latest financial year (2023-24) of Rs. 68.86 LACS as on 31st March 2024.

C. The Bidder must have experience of successful completion of similar work on its own in India within last 7 years as on date of bid submission

(a) One Project of minimum value Rs. 80% of the Project Value

OR

(b) Two Projects of minimum value Rs. 50% of the Project Value each

OR

(c) Three Projects of minimum value 40% of the Project Value of each

Note: Similar work shall mean Construction of Building Work as mentioned in tender documents in any of government organizations only. like R&B/Govt./Semi Govt./PSUs/Government Undertaking /Government Companies Department

D. Available Bid Capacity (ABC) - must be more than the estimated tender cost. Note: Available Bid Capacity (ABC) will be derived by the following method. ABC is calculated as  $ABC = 2 * A * N - B$

Where,

A = Maximum value of works executed in any one year during the last five years (updated to present price level by applying enhancement factor) taking into account the completed as well as works in progress.

N = Number of years prescribed for completion of the works for which tenders are invited. i.e.  $12/12 = 1.00$

B = Value of existing commitments and on-going work to be completed during that next year (period of completion of the works for the tenders are invited.)

Note: The statements/certificate showing the value of existing commitments and ongoing works as well as the stipulated period of completion remaining for each of the works listed should be signed by the respective Employer or his authorized representative, not below the rank of an Executive Engineer or equivalent.

- E. The cost of materials supplied by the Government / Clients shall not be taken into account for experience purpose.
- F. An attested copy of registration with R&B etc. **Registration required: "A" Class & Above and Special in Building Construction. Bank Solvency of Current Financial Year (2024-25) (20% of Tender amount.) of any Nationalized/Scheduled Bank except Co-operative Bank.**
- G. Following enhancement factors will be used for the cost of works executed and financial figures to arrive at common base for the value of the works completed in India. Cut off month shall be considered from month of tenders submission.

Year	Multiplying factor
Immediate last year of the assessment year*	1.1
Second	1.21
Third	1.33
Fourth	1.46
Fifth	1.61
Sixth	1.77
Seventh	1.95

\*Here assessment year shall be reckoned from year and month in which

tender is submitted.

- H. The experience of Joint Venture/Back-to-back work/Nominated Sub-contractors by agencies shall not be considered.
- I. The Bidders should submit Solvency Certificate minimum value of Rs. (20% of Tender amount.) issued by schedule bank / Nationalized bank only and should be valid for at least up to six months from the date of submission.  
(Considering validity as 1 year from date of issue of Solvency Certificate)
- J. The Bidders should submit the list of the works already completed during last 7 years in prescribed Performa and attested copies of certificates issued by head of the office concerned for completed work.
- K. The Bidders shall submit Declaration regarding the work on hand with the bidder in prescribed Performa. Attested copies of work orders, interim certificate if any shall also be attached as supporting document for above.
- L. The Bidders shall submit the attested copy of partnership deed, power of attorney, etc.
- M. Joint Ventures shall not be allowed.
- N. Even though the Bidder meets the above criteria, they are subject to be disqualified if they have
  - i) Made misleading or false presentations in the forms, statements and attachments submitted in proof of the qualification requirements; and/or
  - ii) During verification if it is found from client that of poor performance such as abandoning the works, for financial

	<p>failure or abnormal delay in work etc.</p> <p>iii) Regarding Litigation, in case where Bidder or JV partner or MOU Partner is involved in illegal practice like any activities of corruption, coercive practice or debarred/blacklisted in last 2 years by Any Govt / Organization in respect of performance of Bidder / MOU partner / JV partner, BMC authority requires that bidders under this contract, observe the highest standard of ethics during the procurement and execution of such contracts.</p> <p>(1) Will reject a proposal for award if it determines that the bidder has engaged in any corrupt or fraudulent practices in competing for this contract in past history and</p> <p>(2) Will reject a proposal if it found debarred/blacklisted by any State Govt. / Govt. of India / Semi Government / PSU in last 10 years.</p> <p>iv) The bidder or MOU partner shall not be under any Insolvency Bankruptcy code (IBC) resolution process at National Company Law Tribunal (NCLT) or undergo any Corporate Debt Restructuring (CDR) mode in the past 10 years in India from the date of the submission of the bid.</p> <p>O. The Bidders shall note that in case the Bidder/MO U partner is blacklisted/stated as defaulter/ barred participating in tenders by any of government agencies / semigovernment agencies/PSU in India during last 10 years then in that case, the Bidder will be disqualified though the bidder satisfies all the pre-qualification conditions mentioned</p>
--	--

above, and the bidder will be debarred for next 3 years from participating in tender process for BMC.

- P. Bidders should be selected based on quality work done by them and if necessary tender committee will inspect bidders ongoing and completed work.
- Q. The decision of the commission to quality the bidder will be the final.
- R. Conditional Tenders will be outrightly rejected.
- S. The applicant must submit this confirmation letter on Rs. 300.00 stamp paper with notary for Operating and Maintenance of proposed work shall include labour, all materials, plants, plants casualities, fertilizers, pesticides, tools, watering security of premises shall be responsibility of the Tenderer during the course of work and 2 years after the time of completion certificate from authority and all charges for the same borne by the Contractor (Tenderer). 1% from every running bill shall be deducted towards SECURITY DEPOSITE of Operating and Maintenance of proposed work. ~~IT WILL BE RELEASED AFTER COMPLETION PERIOD OF 24 MONTHS OF O & M.~~
- T. If work is not completed within time limit, penalty of 0.10% per will be deducted from running bill and it will be upto 10%.
- U. FDR For EMD and SD, or bank guarantee issued by state bank of India will not be accepted. Bidder should submit FDR or bank guarantee issued by a non-nationalized bank only.
- V. Bidders shall quote the rate with all taxes including GST. No extra payment for GST will be done by BMC.

	<p><b>VARIATION IN QUANTITIES</b></p> <p>Schedule of prices contain estimated quantities and actual quantities as executed becomes payable at agreed rates. However, accepted rates will be valid till variation in quantities up to any extent of the quantities so specified.</p> <p>W. Other terms and conditions of the tenders shall be read and considered as a part of the tender documents. The rates/prices quoted by the bidders will be final and any sort of escalation will not be considered.</p> <p>Note: Star Rate, Price Escalation, price Variation in any items of Schedule-B / Extra item will Not be given by Bhavnagar Municipal Corporation. If Same will be stated in any Bid Documents will not be Considered.</p>
<p><b><u>Remarks</u></b></p>	<p>: Only Offer of those shall be opened whose EMD &amp; Tender Fee evidence is received electronically along with the bids. However, for the purpose of realization of Demand Draft, bidders shall send them in original through RPAD/Speed Post/Reg. A.D. so as they reach to the office of Executive Engineers</p> <p>- Building Dept., Bhavnagar Municipal Corporation, Bhavnagar during office hours between Dt. 19/12/2024 to Dt. 26/12/2024. Penetrative action shall be imposed for not submitting the supporting documents in original to E.E. by bidder. All the successful bids, if possible, will be physical document opened on 27/12/2024, 17:00 in presence of tender committee at the City Engineer's Office, Commercial stage will be opened after approved tender document Bhavnagar Municipal Corpo</p>

	<p>ration, Bhavnagar. <b>FDR FOR EMD OR SD, OR BANK GAURANTEE issued by state bank of India will not be accepted</b></p>
<p><b>General Terms &amp; Conditions</b></p>	<p>: Bidders who wish to participate in this E-Tender will have to procure valid digital certificate as per information Technology Act 2000. Bidders can procure this certificate from any of the Government approved certifying agency i.e. (n) CodeSolution.</p> <p><b>DOWNLOAD OF TENDER DOCUMENT:</b></p> <p>The tender document for this work is available only in digital format which can be downloaded free of cost by the bidder.</p> <p><b>SUBMISSION OF TENDER:</b></p> <p>Tenderer shall submit their offer in electronic format on above mentioned website on or before the scheduled date and time as mentioned, after Digitally Signing the same.</p> <p>Bidders shall upload the tender documents after submitting the DD details for tender fees and EMD in form of DD/Bank Guarantee detail online. The Demand Draft toward Tender Document fees can be submitted along with Earnest Money Deposit before the due date as specified above.</p> <p>This should be as per details given online and it should be drawn before last date of the uploading of the tender.</p> <p>The intending bidders shall have to submit the following documents in Physical form along with the EMD and tender fees.</p> <p>(a) Documents required for evaluation as sought in different annexure dully digitally signed.</p>

(b) Powerofattorney.

(c) Company's profile and certificate of Registration of company under the law.

The Bidder should submit price Bid digitally only.

**Price bid in physical form shall Not be accepted** and any such offer if received by Bhavnagar Municipal Corporation same will be outrightly rejected.

Technical bid in physical form is not required to be submitted by all bidders. However, non-submission of technical bid does not absolve bidders from and liability of the tender. Only successful bidders have to submit the technical bid duly signed in physical form upon intimation from BMC.

**OPENING OF TENDER:**

The Technical Bid will be opened on the specified date online on website [www.tender.nprocure.com](http://www.tender.nprocure.com). Bidders or their representative who wish to participate in online tender opening can log on to [www.tender.nprocure.com](http://www.tender.nprocure.com) on the due date and time, mark their presence and participate in online tender opening. Bidders who wish to remain present at Bhavnagar Municipal Corporation, only one representative of each firm will be allowed to remain present.



**Information  
for online participation**

1. Internet site address for e-Tendering activities will be [www.tender.nprocure.com](http://www.tender.nprocure.com)
2. Interested bidders can view detailed tender notice and download tender documents from the above-mentioned website.
3. Bidders who wish to participate in online tender have to register with the website through the "New User Registration" link provided on the home page. Bidder will create login id & password on their own in registration process.
4. Bidders who wish to participate in this tender need to procure Digital Certificate as per Information Technology Act-2000 using that they can digitally sign their electronic bids. Bidders can procure the same from many of the CCA approved certifying agencies, or they may contact (n) code Solution at below mentioned address and they will assist them in procuring the same. Bidders who already have a valid Digital Certificate need not to procure the same. In case bidders need any clarification regarding online participation, they can contact  
M/S (n) code Solution  
301, G.N.F.C. Info Tower,  
Near Grant Bhagwati Hotel,  
Ahmedabad 380015, India.  
Tel: +917926857316  
Tel: +917926857317  
Tel: +917926857318  
E-Mail:  
URL: [www.tender.nprocure.com](http://www.tender.nprocure.com)
5. Bidders who wish to participate in e-Tender need to fill data in predefined forms of tender fee, EMD, PQ (Technical) or experienced details and Price bid only.

	<p>6. Bidders should upload scan copies of referenced documents in support of their eligibility of the bid.</p> <p>7. After filling data in predefined forms bidders need to click on final submission link to submit their encrypted bid.</p> <p>Bidders can also submit Document Fees, EMD, Technical bid document &amp; Reference Documents in hard copy if such instructions are given by tendering authority.</p>
<b>Officer Inviting Bids</b>	<b>Executive Engineer, Building Department, Bhavnagar Municipal Corporation, Bhavnagar.</b>
<b>Bid Opening Authority Members in committee</b>	<b>(1) City Engineer (2) Executive Engineer (Building Department.) (3) Chief Accountant (4) Chief Auditor</b>
<b>Address</b>	<b>Building Department, Municipal Corporation, Sir Mangal Singhji Road, Bhavnagar</b>
<b>Contact Person</b>	<p>For further details of any query regarding the tender Contact to:</p> <p>Executive Engineer (Building Department), Bhavnagar Municipal Corporation.,  Sir Mangal Singhji Road,  Bhavnagar-364001  Mobile no. 8128207404  E-mail: <a href="mailto:building.bmcgujarat@gmail.com">building.bmcgujarat@gmail.com</a></p>

Date : 00/11/2024  
Place: Bhavnagar

**Executive Engineer  
Building Department  
Bhavnagar Municipal Corporation**

# BHAVNAGAR MUNICIPAL CORPORATION

## DIST. BHAVNAGAR

**Name of Work :** PROPOSED DOG HOME SHELTER & ANIMAL VACCINATION CENTRE AT NARI ROAD, KUMBHARWADA, BHAVNAGAR, DIST. BHAVNAGAR

### SCHEDULE - "B-1"

Item No.	Quantities Estimated but may be more or less	Item Description	Estimated Rates		Unit	Total Amount according to estimated quantities.
			in Figure	in Words		
1	2	3	4	5	6	7
<b>CIVIL WORK</b>						
1		Boring, providing and installing cast in situ single under reamed piles of specified diameter and length upto pile cap in ready mix M300 cement concrete laying in position Ready Mixed M-300 grade concrete for reinforced cement concrete work, using cement content as per approved Design Mix manufactured in fully automatic batching plant and transported to site of work in transit mixer for a lead to site location having continuous agitated mixer, manufactured as per mix design of specified grade for reinforced cement concrete work				

Item No.	Quantities Estimated but may be more or less	Item Description	Estimated Rates		Unit	Total Amount according to estimated quantities.
			in Figure	in Words		
1	2	3	4	5	6	7
	1104.00	including pumping of R.M.C. from transit mixer to site of laying including cost of admixtures in recommended proportions as per IS: 9103 to accelerate/ retard setting of concrete, improve workability without impairing strength and durability as per direction of the Engineer-in-charge. Without Fly Ash (Min cement level as per latest IS 456 shall be maintained) (Cement level 475 kg). To carry a safe working load not less than specified, excluding the cost of steel reinforcement but including the cost of boring with bentonite solution and the length of the pile to be embedded in pile cap etc. all complete. (Length of pile for payment shall be measured up to the bottom of pile cap): For 450 mm dia. pile for all inclusive Labour & materials etc.	1426.12	Rupees One Thousand Four Hundred TwentySix Paise Twelve Only	Rmt	1574436.48
2		Boring, providing and installing cast in situ single under reamed piles of specified diameter and length upto pile cap in ready mix M300 cement concrete laying in position Ready Mixed M-300 grade concrete for reinforced cement concrete work, using cement content as per approved Design Mix manufactured in fully automatic batching plant and transported to site of work in transit mixer for a lead to site location having continuous agitated mixer, manufactured as per mix design of specified grade for reinforced cement concrete work				

Item No.	Quantities Estimated but may be more or less	Item Description	Estimated Rates		Unit	Total Amount according to estimated quantities.
			in Figure	in Words		
1	2	3	4	5	6	7
	1644.00	including pumping of R.M.C. from transit mixer to site of laying including cost of admixtures in recommended proportions as per IS: 9103 to accelerate/ retard setting of concrete, improve workability without impairing strength and durability as per direction of the Engineer-in-charge. Without Fly Ash (Min cement level as per latest IS 456 shall be maintained) (Cement level 475 kg). To carry a safe working load not less than specified, excluding the cost of steel reinforcement but including the cost of boring with bentonite solution and the length of the pile to be embedded in pile cap etc. all complete. (Length of pile for payment shall be measured up to the bottom of pile cap): For 380 mm dia. pile for all inclusive Labour & materials etc.	977.68	Rupees Nine Hundred SeventySeven SixtyEight Only Paise	Rmt	1607305.92
3		Boring, providing and installing cast in situ single under reamed piles of specified diameter and length upto pile cap in ready mix M300 cement concrete laying in position Ready Mixed M-300 grade concrete for reinforced cement concrete work, using cement content as per approved Design Mix manufactured in fully automatic batching plant and transported to site of work in transit mixer for a lead to site location having continuous agitated mixer, manufactured as per mix design of specified grade for reinforced cement concrete work				

Item No.	Quantities Estimated but may be more or less	Item Description	Estimated Rates		Unit	Total Amount according to estimated quantities.
			in Figure	in Words		
1	2	3	4	5	6	7
	696.00	including pumping of R.M.C. from transit mixer to site of laying including cost of admixtures in recommended proportions as per IS: 9103 to accelerate/ retard setting of concrete, improve workability without impairing strength and durability as per direction of the Engineer-in-charge. Without Fly Ash (Min cement level as per latest IS 456 shall be maintained) (Cement level 475 kg). To carry a safe working load not less than specified, excluding the cost of steel reinforcement but including the cost of boring with bentonite solution and the length of the pile to be embedded in pile cap etc. all complete. (Length of pile for payment shall be measured up to the bottom of pile cap): For 230 mm dia. pile for all inclusive Labour & materials etc.	485.81	Rupees Four Hundred EightyFive Paise EightyOne Only	Rmt	338123.76
4	1452.26	Excavation for foundation up to 1.5 Meter depth including sorting out and stacking of useful materials and disposing of excavated stuff up to any lead. (a) For Loose or Soft soil and any sort of soil	117.08	Rupees One Hundred Seventeen Paise Eight Only	m3	170030.60
5	17683.51	Filling in foundation and plinth with murrum or selected soil in layers of 20cm. thickness including watering, ramming and consolidating etc. complete.	289.07	Rupees Two Hundred EightyNine Paise Seven Only	m3	5111772.24
6	291.97	Filling in foundation and plinth with black garden soil in any thickness completed.	273.71	Rupees Two Hundred SeventyThree Paise SeventyOne Only	m3	79915.11
7	99.81	Brick work using common burnt clay building bricks having crushing strength not less than 35 kg./Sq. Cm. in foundation and plinth in Cement Mortar 1:6 (1-Cement : 6-fine sand) (B) Conventional	4021.03	Rupees Four Thousand TwentyOne Paise Three Only	m3	401339.00

Item No.	Quantities Estimated but may be more or less	Item Description	Estimated Rates		Unit	Total Amount according to estimated quantities.
			in Figure	in Words		
1	2	3	4	5	6	7
8	194.54	Providing and laying cement concrete 1:2:4 (1-Cement : 2-Coarse sand : 4-graded stone aggregates 20 mm nominal size) and curing complete excluding cost of formwork in (A) Foundation and Plinth	3697.92	Rupees Three Thousand Six Hundred NinetySeven Paise NinetyTwo Only	m3	719393.36
9	278.76	Providing laying Controlled cement concrete M-250 and curing complete including the cost of form work and excluding cost of reinforcement for reinforced concrete work in : RCC Column Footings	4693.47	Rupees Four Thousand Six Hundred NinetyThree Paise FourtySeven Only	m3	1308351.70
10	42.11	Providing laying Controlled cement concrete M-250 and curing complete including the cost of form work and excluding cost of reinforcement for reinforced concrete work in : RCC Column up to Plinth Level.	7237.66	Rupees Seven Thousand Two Hundred ThirtySeven Paise SixtySix Only	m3	304777.86
11	152.09	Providing laying Controlled cement concrete M-250 and curing complete including the cost of form work and excluding cost of reinforcement for reinforced concrete work in : RCC Columns for Ground Floor	7237.66	Rupees Seven Thousand Two Hundred ThirtySeven Paise SixtySix Only	m3	1100775.71
12	212.74	Providing laying Controlled cement concrete M-250 and curing complete including the cost of form work and excluding cost of reinforcement for reinforced concrete work in : RCC Plinth beams	5440.87	Rupees Five Thousand Four Hundred Fourty Paise EightySeven Only	m3	1157490.68
13	103.06	Providing laying Controlled cement concrete M-250 and curing complete including the cost of form work and excluding cost of reinforcement for reinforced concrete work in : RCC Floor Beams at GF Slab level.	5875.17	Rupees Five Thousand Eight Hundred SeventyFive Paise Seventeen Only	m3	605495.02

Item No.	Quantities Estimated but may be more or less	Item Description	Estimated Rates		Unit	Total Amount according to estimated quantities.
			in Figure	in Words		
1	2	3	4	5	6	7
14	265.26	Providing laying Controlled cement concrete M-250 and curing complete including the cost of form work and excluding cost of reinforcement for reinforced concrete work in : RCC Slabs & Landings	6064.04	Rupees Six Thousand SixtyFour Paise Four Only	m3	1608547.25
15	14.75	Providing laying Controlled cement concrete M-200 and curing complete including the cost of form work and excluding cost of reinforcement for reinforced concrete work in : RCC Staircase.	6662.97	Rupees Six Thousand Six Hundred SixtyTwo Paise NinetySeven Only	m3	98278.81
16	7.86	Providing laying Controlled cement concrete M-200 and curing complete including the cost of form work and excluding cost of reinforcement for reinforced concrete work in : RCC lintel	6153.93	Rupees Six Thousand One Hundred FiftyThree Paise NinetyThree Only	m3	48369.89
17	101234.50	Providing and CRS TMT bar FE 500 reinforcement for R.C.C. work and including bending, binding & placing in position completed up to floor two level.	79.25	Rupees SeventyNine Paise TwentyFive Only	Kg.	8022834.13
18	48216.00	Providing & Fixing fusion bonded Epoxy coated steel, coating not less than 175 micron and up to 300 micron thickness on TMT Bar FE 500D reinforcement for R.C.C. work including cutting, bending, binding and placing in position as per IS-13620-1993/ASTM-775 M including testing of coating at plant and all taxes (A) 10mm to 16mm dia bar	86.38	Rupees EightySix Paise ThirtyEight Only	Kg.	4164898.08
19	28.51	(ii) Uncoursed Rubble Masonry with hard stone of approved quality in foundations and plinth in Cement Mortar 1:5 (1-cement : 5-coarse sand) including levelling up etc. complete	2542.31	Rupees Two Thousand Five Hundred FourtyTwo Paise ThirtyOne Only	Cum	72481.26



Item No.	Quantities Estimated but may be more or less	Item Description	Estimated Rates		Unit	Total Amount according to estimated quantities.
			in Figure	in Words		
1	2	3	4	5	6	7
20	567.41	Brick work using common burnt clay building bricks having crushing strength not less than 35 kg./Sq.Cm. in in superstructure above plinth level upto floor two level in Cement Mortar 1:6 (1-Cement : 6-fine sand) (B) Conventional	4289.33	Rupees Four Thousand Two Hundred EightyNine Paise ThirtyThree Only	m3	2433808.74
21	135.99	Half brick masonry in common brunt clay building bricks having crushing strength not less than 35Kg/Sq.Cm. in Cement mortar 1:5 (1-Cement : 5-coarse sand) in superstructure above floor two level (B) Conventional	629.82	Rupees Six Hundred TwentyNine Paise EightyTwo Only	m2	85649.22
22	3176.39	20mm thick <b>sand faced cement plaster</b> on walls up to 10 meter above ground level consisting of 12mm thick backing coat of C.M. 1:3 (1-cement : 3- fine sand) and 8 mm thick finishing coat of C.M. 1:1 (1-cement : 1-sand) etc. complete.	326.11	Rupees Three Hundred TwentySix Paise Eleven Only	m2	1035852.54
23	3577.59	Providing 15mm thick cement plaster in single coat on rough (Similar) side of single or half brick walls for interior plastering up to floor two level and finished even and smooth in (i) C.M. 1:3 (1-cement : 3- sand)	186.13	Rupees One Hundred EightySix Paise Thirteen Only	m2	665896.83
24	1263.13	Providing 10mm thick cement plaster in single coat on brick/concrete walls for interior plastering up to floor two level and finished even and smooth in (i) C.M. 1:3 (1-cement : 3- sand)	163.53	Rupees One Hundred SixtyThree Paise FiftyThree Only	m2	206559.65

Item No.	Quantities Estimated but may be more or less	Item Description	Estimated Rates		Unit	Total Amount according to estimated quantities.
			in Figure	in Words		
1	2	3	4	5	6	7
25	3300.47	Finishing wall with base coats of wall primer of approved brands and above <b>weather proof exterior emulsion paint</b> on wall surface (Two coats) to give an required shape even shade after thoroughly brushing the surface to remove all dirt, and remains of loose powdered materials etc. complete	131.06	Rupees One Hundred ThirtyOne Paise Six Only	m2	432559.60
26	4840.72	Applying Two coats of Birla or Asian Acrylic Lappy (putty) and two coats of primer of approved brand and manufacture on new wall surface to give an even shade including thoroughly brushing the surface free from mortar dropping and other foreign matter and sand papered smooth.	40.60	Rupees Fourty Paise Sixty Only	m2	196533.23
27	2058.18	Wall painting (two coats) with plastic emulsion paint of approved brand and manufacture on undecorated wall surface to give an even shade including thoroughly brushing the surface free from mortar dropping and other foreign matter and sand papered smooth	78.91	Rupees SeventyEight Paise NinetyOne Only	m2	162410.98
28	2658.46	White washing with lime on wall surface (two coats) to give an even shade including thoroughly booming the surface to remove all dirt, dust; mortar drops and other foreign matter.	12.09	Rupees Twelve Paise Nine Only	Sqm	32140.78
29	7360.93	Painting One coat of primer and two coats Enamel paint on new steel and other metal surface with enamel paint, brushing, interior to give an even shade including cleaning the surface an even shade including cleaning the surface of all dirt, dust and other foreign matter.	122.81	Rupees One Hundred TwentyTwo Paise EightyOne Only	m2	903995.81

Item No.	Quantities Estimated but may be more or less	Item Description	Estimated Rates		Unit	Total Amount according to estimated quantities.
			in Figure	in Words		
1	2	3	4	5	6	7
30	176.20	Providing and fixing pre-cast concrete kerb stone of Gray cement based concrete block 30cm length, 30cm height and 15cm thick of M200 grade concrete as per approved design and including excavation for fixing in proper line and level, filling the joint with C:M 1:3 (1 cement : 3 fine sand) etc complete.	383.38	Rupees Three Hundred EightyThree Paise ThirtyEight Only	Rmt	67551.56
31	541.00	Supply & plantation of shrubs are to be planted as per the detailed planting drawing and specify distance, labour charges, for digging of pit as per detailed specification filling of organic manure, fertilizer, insecticides etc. and planting of plant as shown in the drawing, filling the pit, proper pressing and watering.	260.58	Rupees Two Hundred Sixty Paise FiftyEight Only	No	140973.78
32	40.00	Tree plantation are to be planted as per the detailed planting drawing, labour charges, for digging of pit as per detailed specification filling of organic manure, fertilizer, insecticides etc. and planting of plant as shown in the drawing, filling the pit, proper pressing, supporting and watering. complete (A) (Average height 8 to 10 feet of plant will be considered.)	915.06	Rupees Nine Hundred Fifteen Paise Six Only	No.	36602.40
33	574.29	Fabrication for railings, gates etc using MS square pipes of 12 gauge of Asian, TATA or equivalent make	116.15	Rupees One Hundred Sixteen Paise Fifteen Only	Kg	66703.78

Item No.	Quantities Estimated but may be more or less	Item Description	Estimated Rates		Unit	Total Amount according to estimated quantities.
			in Figure	in Words		
1	2	3	4	5	6	7
34	9.85	Providing and laying Granite slab (18mm thick) slab flooring over 20mm (Average) thick base of cement mortar 1:6 (1-cement : 6-Coarse sand) or L.M. 1:1.5 laid over and jointed with grey cement slurry including rubbing and polishing complete (Basic Granite rate shall be 250/Sft) (A) Granite slab 18mm thick	2418.55	Rupees Two Thousand Four Hundred Eighteen Paise FiftyFive Only	m2	23822.72
35	3.46	Providing and laying 18mm thick Granite slab in riser of steps Dedo and pillars laid 10mm thick Cement Mortar 1:3 (1-Cement : 3-Coarse Sand) and jointed with Grey Cement Slurry including rubbing and polishing complete.	2502.78	Rupees Two Thousand Five Hundred Two Paise SeventyEight Only	m2	8659.62
36	5.00	Providing and fixing Gun metal check or non-return full way wheel valve. (E) 40mm Dia	663.43	Rupees Six Hundred SixtyThree Paise FourtyThree Only	No	3317.15
37	1776.13	Providing and laying coloured glazed tiles of the size 300 mm x 200 mm x 8 mm/300 mm x 450 mm x 8 mm in skirting, risers of steps and Dedo on 10 mm. thick cement plaster 1:3 (1 cement : 3 coarse sand) & jointed with white cement slurry.	1417.37	Rupees One Thousand Four Hundred Seventeen Paise ThirtySeven Only	Sqm	2517433.38

Item No.	Quantities Estimated but may be more or less	Item Description	Estimated Rates		Unit	Total Amount according to estimated quantities.
			in Figure	in Words		
1	2	3	4	5	6	7
38	58.00	Constructing brick masonry chamber for under ground C.I. Inspection chamber and bends with bricks having crushing strength not less than 35 Kg/cm <sup>2</sup> in cm. 1:5 C.I. Cover with frame (light duty) 455 mm. X 610 mm. Internal dimensions, total weight of cover with frame to be not less than 38 Kgs. weight of cover 23 Kg. and wt. of frame 15 Kg) R.C.C. top slab with 1:2:4 mix (1 cement : 2 coarse sand : 4 graded stone aggregate 20 mm. size) foundation concrete 1:5:10 inside plaster 15 mm. thick with cement mortar 1:3 finished smooth with a floating coat of neat cement on walls & abed concrete etc. complete (I) inside dimensions, 455 mm. 610 mm. And 450 mm. Deep for single pipe line.	2932.93	Rupees Two Thousand Nine Hundred ThirtyTwo Paise NinetyThree Only	Each	170109.94
39	4.00	Providing and fixing 600 mm. X 450 mm. Bevelled edge mirror of superior glass mounted on 6 mm. Thick A.C, sheet or plywood sheet and fixed to wooden plugs with C.P. brass screws and washers	833.74	Rupees Eight Hundred ThirtyThree Paise SeventyFour Only	EA	3334.96
40	8.49	Providing and fixing FRP frame size 100 X 50mm and 28mm thick FRP depress panel shutter having extra reinforcement on sides & edges in gel coat finish. The core of the shutter & frame is to be filed up with injected fire retardant grade polyuthene foam done in situ along with embedded wooden pieces for stiffening & also taking hinges & fixtures. the whole FRP frame & shutter is to be water proof weather proof, termite proof & resistance to mild acid/alkali. rates are to be inclusive of s.s. hinges with necessary screw & aluminium fixtures & fastnings & fastener sleeve.	2377.77	Rupees Two Thousand Three Hundred SeventySeven Paise SeventySeven Only	m <sup>2</sup>	20187.27

Item No.	Quantities Estimated but may be more or less	Item Description	Estimated Rates		Unit	Total Amount according to estimated quantities.
			in Figure	in Words		
1	2	3	4	5	6	7
41	31.08	Providing and fixing 35mm thick shutter for doors, windows and clerestory windows including Indian teak wood frames 12cm x 7cm. Size including anodized aluminium fixtures and fastenings including primer coat of approved quality and two coats of oil painting etc, complete. (ii) Fully Panelled.	5338.31	Rupees Five Thousand Three Hundred ThirtyEight Paise ThirtyOne Only	m2	165914.67
42	369.85	Providing and laying polished Kota stone slab flooring over 20mm (Average) thick base of cement mortar 1:6 (1-cement : 6-coarse sand) or L.M. 1.1.5 (1-Lime putty : 1.5-coarse sand) laid over and jointed with grey cement slurry mixed with pigment to match the shade of slab including rubbing and polishing etc. complete. (A) 25mm thick	971.96	Rupees Nine Hundred SeventyOne Paise NinetySix Only	m2	359479.41
43	4.00	Providing and fixing C.P. brass waste for wash basin or sink (A) 32mm Dia	67.92	Rupees SixtySeven Paise NinetyTwo Only	EA	271.68
44	5.00	Providing and fixing water closet squatting pan (European Type type W.C. Pan) size 580 mm. (Earth work, Bed concrete foot rests and trap to be measured and paid for separately.) (A) Vitreous china (I) Long pattern white colour	1303.71	Rupees One Thousand Three Hundred Three Paise SeventyOne Only	No.	6518.55
45	3.00	Providing and fixing urinal approved quality connecting the urinal with waste pipe, trap etc. complete (A) White earthen ware flat back or corner type size 430mm x 260mm x 350 mm	1036.28	Rupees One Thousand ThirtySix Paise TwentyEight Only	No.	3108.84

Item No.	Quantities Estimated but may be more or less	Item Description	Estimated Rates		Unit	Total Amount according to estimated quantities.
			in Figure	in Words		
1	2	3	4	5	6	7
46	4.00	Providing and fixing washbasin with single hole for pillar tap with C.I. or M.S. brackets painted white including sutting holes and making good the same but excluding fittings. (A) Vitreous China	1414.19	Rupees One Thousand Four Hundred Fourteen Paise Nineteen Only	No.	5656.76
47	7.00	Providing and fixing screw down bib taps of following size : (A) Brass screw down bib tap polished bright (I) 15mm dia.	186.83	Rupees One Hundred EightySix Paise EightyThree Only	EA	1307.81
48	7000.00	Providing Erecting and fixing coated PVC. (ISI) water tank of required capacity each with all necessary fittings and connection etc. complete on terrace.	3.95	Rupees Three Paise NinetyFive Only	Lt.	27650.00
49	874.80	Providing and laying broken china mosaic flooring for terrace using 12 mm to 20 mm broken pieces of glazed tiles to be laid over cement mortar 1:3 to plain or slope and to be tempered to bring mortar crème out up to surface using white cement including rounding off junctions and extending them up to 15cm along the wall clearing with water and oxalic acid etc. as directed	747.29	Rupees Seven Hundred FourtySeven Paise TwentyNine Only	m2	653729.29

Item No.	Quantities Estimated but may be more or less	Item Description	Estimated Rates		Unit	Total Amount according to estimated quantities.
			in Figure	in Words		
1	2	3	4	5	6	7
50	26.78	Providing and fixing window having extruded aluminum Colour Powder Coated section frame main outer size 95mm x 24mm x 1.17mm @ wt. of 0.738 Kg/mt, horizontal Three track member size 92mm x 31.75mm x 1.30mm @ Wt.1.07 Kg/mt, vertical member of size 92mm x 31.75mm x 1.50mm, @ Wt. 1.06 Kg/mt with sliding shutters of horizontal member size 40 mm x 18mm x 1.29mm @ wt. of 0.456 Kg/mt, vertical member of size 40mm x 18mm x 1.29 mm @ wt.of 0.456Kg/mt with 5 mm thick transparent bronze colour tinted float glass with powder coated aluminum fittings and fixtures and transparent silicon sealant glass fixing to frame as per details etc.	1591.88	Rupees One Thousand Five Hundred NinetyOne Paise EightyEight Only	m2	42630.55
51	100.00	Providing laying and jointing in true line and level 40mm dia. U.P.V.C. Pipe (SCH- 40) for cold water including fittings make PRINCE / SUPREME / ASTRAL / FINOLEX or equivalent as approved by Engineer In Charge. Pipe shall be fixed on the wall with the help of clamp at every two metre C/C or shall be concealed as directed including necessary fittings etc. including testing of pipe and joints and fixing the same with adhesive solvent, including cost of all materials.	148.12	Rupees One Hundred FortyEight Paise Twelve Only	m	14812.00



Item No.	Quantities Estimated but may be more or less	Item Description	Estimated Rates		Unit	Total Amount according to estimated quantities.
			in Figure	in Words		
1	2	3	4	5	6	7
52	150.00	Providing, laying and jointing in true line and level 25mm dia. U.P.V.C. Pipe (SCH-40) line including fitting as approved by Engineer-in-Charge. Pipe shall be fixed on the wall with the help of clamp at every two meter C/C or shall be concealed as directed including necessary fittings etc. including testing of pipe and joints and fixing the same with adhesive solvent, including cost of all materials. (D) 25mm Dia pipe	91.84	Rupees NinetyOne Paise EightyFour Only	Rmt	13776.00
53	323.00	Providing, laying and jointing in true line and level 50mm dia. U.P.V.C. Pipe (SCH-40) line including fitting as approved by Engineer-in-Charge. Pipe shall be fixed on the wall with the help of clamp at every two meter C/C or shall be concealed as directed including necessary fittings etc. including testing of pipe and joints and fixing the same with adhesive solvent, including cost of all materials. (D) 50mm Dia pipe	195.67	Rupees One Hundred NinetyFive Paise SixtySeven Only	Rmt	63201.41
54	50.00	Providing laying and jointing in true line and level 32mm dia. U.P.V.C. Pipe (SCH- 40) for cold water including fittings make PRINCE / SUPREME / ASTRAL / FINOLEX or equivalent as approved by Engineer In Charge. Pipe shall be fixed on the wall with the help of clamp at every two metre C/C or shall be concealed as directed including necessary fittings etc. including testing of pipe and joints and fixing the same with adhesive solvent, including cost of all materials.	119.15	Rupees One Hundred Nineteen Paise Fifteen Only	Rmt	5957.50

Item No.	Quantities Estimated but may be more or less	Item Description	Estimated Rates		Unit	Total Amount according to estimated quantities.
			in Figure	in Words		
1	2	3	4	5	6	7
55	100.00	Providing laying and jointing in true line and level 15mm dia. U.P.V.C. Pipe (SCH- 40) for cold water including fittings make PRINCE / SUPREME / ASTRAL / FINOLEX or equivalent as approved by Engineer In Charge. Pipe shall be fixed on the wall with the help of clamp at every two metre C/C or shall be concealed as directed including necessary fittings etc. including testing of pipe and joints and fixing the same with adhesive solvent, including cost of all materials.	72.65	Rupees SeventyTwo Paise SixtyFive Only	Rmt	7265.00
56	150.00	Providing, laying and jointing in true line and level 110 diameter U.P.V.C (Type B) conforming to IS 13592-1992 with one end plain and other end socketed with rubber ring, & fittings conforming to ISI 14735-1999 of approved make for drainage system pipe line, pipe shall be jointed with each other with rubber lubricant, pipe shall be fixed on wall using of PVC clamp of the size 110 mm diameter x 149 mm length x 145 mm heigh at every 2000 mm centre to centre or shall be concealed in walls as directed including necessary fittings such as bends, shoes etc. including testing of pipes and joints and jointed with adhesive solvent cement including cost of all materials.	835.15	Rupees Eight Hundred ThirtyFive Paise Fifteen Only	Rmt	125272.50
57	35.00	Providing and fixing PVC SWR Nahni trap IS 14735 for drain - 100 mm diameter with Jali of the following nominal diameter of self cleansing design with C.I screed down or hinged grating including the cost of cutting and making good the walls.	558.36	Rupees Five Hundred FiftyEight Paise ThirtySix Only	EA	19542.60

Item No.	Quantities Estimated but may be more or less	Item Description	Estimated Rates		Unit	Total Amount according to estimated quantities.
			in Figure	in Words		
1	2	3	4	5	6	7
58	5.00	Providing and fixing Kitchen sink with C.I. or M.S. brackets, painted white including cutting holes in walls and making good the same but excluding fittings. (C) Vitreous China Sink. (i) 600mm x 450mm x 150mm size	2280.27	Rupees Two Thousand Two Hundred Eighty Paise TwentySeven Only	EA	11401.35
59	5.00	Providing and fixing brass screw down stop (A) 15 mm. Dia	205.83	Rupees Two Hundred Five Paise EightyThree Only	EA	1029.15
60	6.00	Providing and fixing Pillar Tap, capstan head, screw down high pressure with screws, shanks and back nuts (A) 15 mm. Dia	308.73	Rupees Three Hundred Eight Paise SeventyThree Only	EA	1852.38
61	125122.60	Fabrication and fixing in position of required pattern with M.S. flats at required spacings and frame all-round, square or round bars with round headed bolts and nuts or by screws	101.18	Rupees One Hundred One Paise Eighteen Only	Kg	12659904.67
62	1986.09	Providing and laying cement concrete flooring 1:2:4 (1-cement : 2-coarse sand : 4-graded stone aggregate 20mm nominal size) laid in one layer and finished with a floating coat of neat cement. (B) 50mm thick.	322.93	Rupees Three Hundred TwentyTwo Paise NinetyThree Only	Sqm	641368.04
63	17.31	Providing and fixing in position collapsible steel shutters with vertical channels 20 x 10 x 2 mm braced with flat iron diagonals 20 x 5 mm size with top and bottom rails of T_rin 40x 40 x 6 mm with 38mm dia, steel pulleys complete with bolts, nuts, locking arrangements, stoppers handles including applying a priming coat of red lead paint.	5825.33	Rupees Five Thousand Eight Hundred TwentyFive Paise ThirtyThree Only	Qun	100836.46

Item No.	Quantities Estimated but may be more or less	Item Description	Estimated Rates		Unit	Total Amount according to estimated quantities.
			in Figure	in Words		
1	2	3	4	5	6	7
64	697.84	Providing, Supplying and Laying Rubble Stone Soiling for Foundation Base as per directed by Engineer-in-charge & as per Specifications and preparing surface complete.	947.38	Rupees Nine Hundred FourtySeven Paise ThirtyEight Only	Cum	661119.66
65	2.00	Providing sock pit of 5.00 Cu.M. Volume including excavating and filling brickbats with dry masonry work at top for 45cm. height including covering the top with stone including providing vatas in C.M. 1:3 with finishing curing etc. complete as directed.	3372.19	Rupees Three Thousand Three Hundred SeventyTwo Paise Nineteen Only	EA	6744.38
66	2.00	Construction of Septik tank of size 3.60 X 1.15 X 1.50 including Excavation, BBCC, RCC, Reinforcement, Bela Mosanary, Finished by Providing 15 mm plaster in cement mortor (1-cement : 3-coarse sand) etc. complete As Per Drawing.	64612.73	Rupees SixtyFour Thousand Six Hundred Twelve Paise SeventyThree Only	EA	129225.46
67	330.97	Providing and fixing 1.20 Metre high fencing with 2.0 Metre long M.S. Angle posts 40mm x 40 mm x 6 mm and oil painting 3 coats fixed at 2.5 Mt, C/c. with five Horizontan lines and two diagonals of galvanised steel barbed wire weighting 9.38 Kg. per 100 Metre, strained and fixed to posts with G.I, staples including fixing the posts in Bela Masonary with 0.125cum C.C 1:5:10 etc complete.	389.25	Rupees Three Hundred EightyNine Paise TwentyFive Only	Rmt	128830.07
68	175.17	Supply & Fixing all material as per required for Rain Water Harvesting like a Pebbles Stones, granular stone, bricks bats & Fly ash Bricks and Brick Partition Walls as per Given Drawing & Engineer-in-charge instraction etc. complete.	1767.82	Rupees One Thousand Seven Hundred SixtySeven Paise EightyTwo Only	Cum	309669.03

Item No.	Quantities Estimated but may be more or less	Item Description	Estimated Rates		Unit	Total Amount according to estimated quantities.
			in Figure	in Words		
1	2	3	4	5	6	7
69	182.00	Supplying and fixing reinforced concrete heavy duty non-pressure pipes with collars for culverts carrying heavy traffic as per IS 458-1991 specifications including setting the pipes in C.M. 1:2 watering and laying (to level or slopes) of class NP3 of following internal diameters. (i) 300mm dia.	649.92	Rupees Six Hundred FourtyNine Paise NinetyTwo Only	Rmt	118285.44
70	286.80	Providing and Fixing of Birds Safety net Nylon Material durable in all Whether fixing in proper with necessary screw and all complete as per Engineer-in-charge Directions.	119.54	Rupees One Hundred Nineteen Paise FiftyFour Only	Sqm	34284.07
71	171.72	Providing and Fixing 6 mm thick Lexan Polycarbonate multi wall roofing sheet fixed with hilti screw and rubber silicon sealer and aluminium strip of size 50 x 3 mm etc complete as directed by Engineer in charge.	1441.90	Rupees One Thousand Four Hundred FourtyOne Paise Ninety Only	Sqm	247603.07

Item No.	Quantities Estimated but may be more or less	Item Description	Estimated Rates		Unit	Total Amount according to estimated quantities.
			in Figure	in Words		
1	2	3	4	5	6	7
<b>SELF SUPPORTED TRUSS LESS ROOF</b>						
1		Providing and fixing of Self Supported Structure Truss Less Roofing systems with proper overlapping and seaming b/w different sheets without making holes or preventing the overturning the roof by wind addition made up from superior quality, structural grade steel. Base metal width 912 mm, Steel Grade : Grade D and Thickness 0.90 mm BMT, 1.25 mm APT with tolerance of +/- 0.04 mm, Regular Modified Polyester Color Coated Galvalume Steel having Profiled width of 625 mm +/- 10mm.				
	2384.97	Design, supply, & fabrication of self supported single span arch roof fabricated from mechanically seamed manufactured by Hydraulic Machines to profiles of Galvalume Cold Rolled Structural Steel coils as per standard ASTM A792, Steel Sheet, Aluminum-Zinc Alloy Coated by Hot-Dip Process. The work should be carried out by experienced agency only. The rate of item is including fitting as per standard specification.	2110.90	Rupees Two Thousand One Hundred Ten Paise Ninety Only	Sqm	5034433.17
2	24.00	Hangers/ Clamps for laying of cable and suspending bulbs/ lights.	262.20	Rupees Two Hundred SixtyTwo Paise Twenty Only	No	6292.80
3	12.00	Providing and fixing of 24 Inch Dia Turbo Ventilators made from Alluminium 42nos Vanes and stainless steel bearing with Polycarbonate base including fixing in roof as and where directed by Engineer in charge etc.	16387.25	Rupees Sixteen Thousand Three Hundred EightySeven Paise TwentyFive Only	No	196647.00

Item No.	Quantities Estimated but may be more or less	Item Description	Estimated Rates		Unit	Total Amount according to estimated quantities.
			in Figure	in Words		
1	2	3	4	5	6	7
4	2384.97	Supply of 19 mm thick Expanded Polyethylene Closed Cell Foam insulation materials NFR laminated with both sides of Metpet Foils (Metpet Foil + Closed-cell foam + Metpet Foil)	277.75	Rupees Two Hundred SeventySeven Paise SeventyFive Only	m2	662425.42

Item No.	Quantities Estimated but may be more or less	Item Description	Estimated Rates		Unit	Total Amount according to estimated quantities.
			in Figure	in Words		
1	2	3	4	5	6	7
<b>ELECTRIFICATION WORK</b>						
1		Point wiring for Tissino / Modular secondary light point with 2-1.5 sq.mm & earth wire of 1.5 sq.mm (green) both are of ISI marked 1.1 KV grade FRLS PVC insulated multi strand copper wires, in below type of pipe to be erected complete with earth continuity and necessary connection with primary light with accessories erected on Metal/ PVC/ wooden box covered with 3 mm thick PC (Polycarbonate) / Acrylic sheet for open / concealed wiring. with necessary Lamp holder / ceiling rose / H.D.Connector as directed.				
	142.00	(f) with medium class Rigid PVC pipe and accessories erected concealed in wall/ceiling complete	151.50	Rupees One Hundred FiftyOne Paise Fifty Only	Pt.	21513.00
2		Point wiring for Light/ Bell with 2-1.5 sq.mm & earth wire of 1.5 sq.mm (Green) both are of ISI marked 1.1 KV grade FRLS PVC insulated multi strand copper wires up to 10 mtr length, in below type of pipe erected with 6A Modular type switch/ bell push & accessories and earth continuity of following type, erected on PVC/ Metallic/ Wooden box, single mounting base frame covered with textured/ metallic/ white front plate modules erected on/ in wall/ ceiling as per pipe erected, with necessary Lamp holder/ ceiling rose / H.D.Connector as directed.				
	403.00	(f) with medium class Rigid PVC pipe and accessories erected concealed in wall/ceiling complete	449.45	Rupees Four Hundred FortyNine Paise FortyFive Only	Pt.	181128.35



Item No.	Quantities Estimated but may be more or less	Item Description	Estimated Rates		Unit	Total Amount according to estimated quantities.
			in Figure	in Words		
1	2	3	4	5	6	7
3		Point wiring for FAN with 2-1.5 sq.mm & earth wire of 1.5 sq.mm (Green) both are of ISI marked 1.1 KV Grade FRLS PVC insulated multi strand copper wires up to 10 mtr length, in below type of pipe erected with 6A Modular type switch and hum free EME step type electronic fan regulator mounted and accessories with earth continuity of following type erected on PVC / Metallic/ Wooden box, single mounting base frame covered with textured/metallic/white front plate modules erected on / in wall / ceiling as per pipe erected. with necessary ceiling rose / H.D.Connector as directed.				
	82.00	(f) with medium class Rigid PVC pipe and accessories erected concealed in wall/ceiling complete	629.23	Rupees Six Hundred TwentyNine Paise TwentyThree Only	Pt.	51596.86
4		Point wiring for Individual Plug with & earth wire of 1.5 sq.mm (Green) both are of ISI marked 1.1 KV grade FRLS PVC insulated multi strand copper wires up to 10 mtr length, in below type of pipe erected complete with Modular type switch & 5 pin Plug erected on PVC / Metallic/Wooden box covered with appropriate front plate modules erected on / in wall / ceiling as per pipe erected with following type of accessories. [I] For 6A Plug and 6 a switch with 2-1.5 sq.mm Cu. Wire from nearby switchboard/mcb db board				
	44.00	(f) with medium class Rigid PVC pipe and accessories erected concealed in wall/ceiling complete	473.69	Rupees Four Hundred SeventyThree Paise SixtyNine Only	Pt.	20842.36

Item No.	Quantities Estimated but may be more or less	Item Description	Estimated Rates		Unit	Total Amount according to estimated quantities.
			in Figure	in Words		
1	2	3	4	5	6	7
5		Point wiring for Individual Plug with & earth wire of 1.5 sq.mm (Green) both are of ISI marked 1.1 KV grade FRLS PVC insulated multi strand copper wires up to 10 mtr length, in below type of pipe erected complete with Modular type switch & 5 pin Plug erected on PVC / Metallic/ Wooden box covered with appropriate front plate modules erected on / in wall / ceiling as per pipe erected with following type of accessories. [II] For 16A Plug and 16 amp switch with 2-2.5 sq.mm Cu. Wire from mcb db board.				
	53.00	(f) with medium class Rigid PVC pipe and accessories erected concealed in wall/ceiling complete	697.91	Rupees Six Hundred NinetySeven Paise NinetyOne Only	Pt.	36989.23
6		Point wiring for Individual Plug with & earth wire of 1.5 sq.mm (Green) both are of ISI marked 1.1 KV grade FRLS PVC insulated multi strand copper wires up to 10 mtr length, in below type of pipe erected complete with Modular type switch & 5 pin Plug erected on PVC / Metallic/ Wooden box covered with appropriate front plate modules erected on / in wall / ceiling as per pipe erected with following type of accessories. [III] For 16A Plug and 16 amp switch with 2-4 sq.mm Cu. Wire with 2.5 sq.mm (green) earthing wire from mcb d b board.				
	10.00	(f) with medium class Rigid PVC pipe and accessories erected concealed in wall/ceiling complete	818.10	Rupees Eight Hundred Eighteen Paise Ten Only	Pt.	8181.00

Item No.	Quantities Estimated but may be more or less	Item Description	Estimated Rates		Unit	Total Amount according to estimated quantities.
			in Figure	in Words		
1	2	3	4	5	6	7
7	85.00	Point wiring for on board Looped Plug with 6A Modular type switch & 5 pin socket erected on PVC/ Metallic/ Wooden box, single mounting base frame covered with textured /metallic/ white front plate modules erected on/ in wall /ceiling with following type accessories	241.39	Rupees Two Hundred FourtyOne Paise ThirtyNine Only	Pt.	20518.15
8		Point wiring for Two Way Controlled Light Point with 2-1.5 sq.mm & earth wire of 1.5 sq.mm (green) both are of ISI marked 1.1 KV grade FRLS PVC insulated multi strand copper wires erected in below type of pipe with 6A Modular type switches and following type of accessories erected on PVC / Metallic/ Wooden box, single mounting base frame covered with textured / metallic/ white front plate modules erected on / in wall/ ceiling as per pipe erected. with necessary batten/angle holder or ceiling rose or H.D. Connector as directed.				
	9.00	(f) with medium class Rigid PVC pipe and accessories erected concealed in wall/ceiling complete	560.55	Rupees Five Hundred Sixty Paise FiftyFive Only	Pt.	5044.95
9		Providing and erecting Mains with 1.1 KV grade FRLS PVC insulated ISI marked stranded Copper conductor wire in following type of pipe to be erected concealed in / flushed on wall/ ceiling, with 1.5 sq. mm copper conductor FRLS PVC insulated stranded wire of green colour for earth continuity of following size				
	1233.00	(A) With medium class Rigid PVC pipe and accessories (b) 2 wire 2.5 sq. mm	78.78	Rupees SeventyEight Paise SeventyEight Only	Mtr.	97135.74

Item No.	Quantities Estimated but may be more or less	Item Description	Estimated Rates		Unit	Total Amount according to estimated quantities.
			in Figure	in Words		
1	2	3	4	5	6	7
10	5.00	Providing following type of Modular Type Accessories mounted with PVC/ metallic/ Wooden box, single mounting base frame covered with textured/ metallic/ white front plate, modules erected with necessary connections as per site situation directed by Engineer In charge.	390.87	Rupees Three Hundred Ninety Paise EightySeven Only	Ea.	1954.35
11		Supplying and erecting LED indoor fittings with LEDs of wattage 0.2 Watt to 0.5 Watt assembled on single MCPCB, with housing used as a heat sink shall be made of thick sheet Steel conforming to IS: 513/ CRCA/ aluminium die cast powder coated and high U.V. & corrosion resistance with diffuser with company mark/ name 160V to 270V, Power Factor more than 0.95, THD < 15%, CCT 3000K to 6500K, Luminaire efficacy > 85 lumens/ watt, LED driver efficiency > 85 % (fitting required LM-79 & LM-80 Certificates) (NOTE: Below description have shown ranges of Wattage capacity of LED fittings. The Engineer incharge may select any wattage capacity between the ranges shown.)				
	3.00	(A) Tube Light with integral driver (i) 5-10 Watts, Surge-2 KV, IP-20, conventional 1 to 2 feet	165.64	Rupees One Hundred SixtyFive Paise SixtyFour Only	Ea.	496.92
12	4.00	(A) Tube Light with integral driver (iv) 22-24 Watts, Surge - 2KV, IP-20, conventional 4 feet	373.70	Rupees Three Hundred SeventyThree Paise Seventy Only	Ea.	1494.80

Item No.	Quantities Estimated but may be more or less	Item Description	Estimated Rates		Unit	Total Amount according to estimated quantities.
			in Figure	in Words		
1	2	3	4	5	6	7
13		Supplying and erecting LED indoor fittings with LEDs of wattage 0.2 Watt to 0.5 Watt assembled on single MCPCB, with housing used as a heat sink shall be made of thick sheet Steel conforming to IS: 513/ CRCA/ aluminium pressure die cast powder coated and high U.V. & corrosion resistance with diffuser housed in aluminium casted body with company mark/ name 160V to 270V, Power Factor more than 0.95, THD < 15 %, CCT 3000K to 6500K, Luminaire efficacy > 85 lumens/watt, LED driver efficiency > 85% (fitting required LM-79 & LM-80 Certificates) (NOTE: Below description have shown ranges of Wattage capacity of LED fittings. The Engineer incharge may select any wattage capacity between the ranges shown.)				
	220.00	(A) Square/ Circular shaped Surface/ Recessed Mount Downlight with provision for spring loaded mounting clips complete. IP20 (ii) 11-15 watts, Surge-2 KV	427.23	Rupees Four Hundred TwentySeven Paise TwentyThree Only	Ea.	93990.60

Item No.	Quantities Estimated but may be more or less	Item Description	Estimated Rates		Unit	Total Amount according to estimated quantities.
			in Figure	in Words		
1	2	3	4	5	6	7
14		Supplying and erecting LED indoor fittings with LEDs of wattage 0.2 Watt to 0.5 Watt assembled on single MCPCB, with housing used as a heat sink shall be made of thick sheet Steel conforming to IS: 513/ CRCA/ aluminium pressure die cast powder coated and high U.V. & corrosion resistance with diffuser housed in aluminium casted body with company mark/ name 160V to 270V, Power Factor more than 0.95, THD < 15 %, CCT 3000K to 6500K, Luminaire efficacy > 85 lumens/watt, LED driver efficiency > 85% (fitting required LM-79 & LM-80 Certificates) (NOTE: Below description have shown ranges of Wattage capacity of LED fittings. The Engineer incharge may select any wattage capacity between the ranges shown.)				
	26.00	(B) LED Panel Light with provision for Plane front frame with translucent cover fixed to housing complete. IP20 (vi) 36 watts, 24" x 24", Surge- 2KV	1794.77	Rupees One Thousand Seven Hundred NinetyFour Paise SeventySeven Only	Ea.	46664.02

Item No.	Quantities Estimated but may be more or less	Item Description	Estimated Rates		Unit	Total Amount according to estimated quantities.
			in Figure	in Words		
1	2	3	4	5	6	7
15		Supplying and erecting LED street light /Flood light fittings with High power White LEDs wattage of 3 Watt and above assembled on single MCPCB, efficiency more than 130 lm/w and corrosion free High pressure die cast aluminum housing with smooth finish powder coated and heat sink extruded aluminium with diffuser and Polycarbonate optics/ lenses, with toughened glass with company mark/name engraved or embossed 160 to 270V, Power Factor more than 0.95, THD < 10 %, CCT 3000K to 5700K, Uniformity ratio >0.45, Luminaire efficacy> 100 lumens/watt. LED driver efficiency > 85 %. (fittings required LM-79 & LM-80 certificates) (NOTE: Below description have shown ranges of Wattage capacity of LED fittings. The Engineer incharge may select any wattage capacity between the ranges shown.)				
	36.00	(A) Street Light (IP-65), Surge protection-4KV integral and, Light must have 440VAC line supply with over-voltage protection. (ii) above 48 to 60 Watts	4997.48	Rupees Four Thousand Nine Hundred NinetySeven Paise FourtyEight Only	Ea.	179909.28

Item No.	Quantities Estimated but may be more or less	Item Description	Estimated Rates		Unit	Total Amount according to estimated quantities.
			in Figure	in Words		
1	2	3	4	5	6	7
16		Supplying and erecting LED street light/Flood light fittings with High power White LEDs wattage of 3 Watt and above assembled on single MCPCB, efficiency more than 130 lm/w and corrosion free High pressure die cast aluminum housing with smooth finish powder coated and heat sink extruded aluminium with diffuser and Polycarbonate optics/ lenses, with toughened glass with company mark/ name engraved or embossed 160 to 270V, Power Factor more than 0.95, THD < 10 %, CCT 3000K to 5700K, Uniformity ratio >0.45, Luminaire efficacy > 100 lumens/watt. LED driver efficiency > 85 %. (fittings required LM-79 & LM-80 certificates) (NOTE: Below description have shown ranges of Wattage capacity of LED fittings. The Engineer incharge may select any wattage capacity between the ranges shown.)				
	2.00	(C) Post Top Lantern LED fitting comprises of finish cast aluminum spigot and spun aluminum canopy fixed with opal polycarbonate, pipe arrangement for vertical mounting driver and accessories wired upto terminal block. IP 65 (ii) 32-40W	4819.72	Rupees Four Thousand Eight Hundred Nineteen Paise SeventyTwo Only	Ea.	9639.44
17	1.00	Providing Approved make Triple Pole Metal Clad Switch Fuse Unit 415/500V. with HRC fuse of suitable load and neutral link conforming to IS (a) 200 A	8012.33	Rupees Eight Thousand Twelve Paise ThirtyThree Only	Ea.	8012.33
18	1.00	Erection & connection Charges for 200A/ 250A/ 300A/ 325A/ 400A HRC TPN as following (b) Erection on New angle iron frame duly painted with red oxide.	197.96	Rupees One Hundred NinetySeven Paise NinetySix Only	Ea.	197.96



Item No.	Quantities Estimated but may be more or less	Item Description	Estimated Rates		Unit	Total Amount according to estimated quantities.
			in Figure	in Words		
1	2	3	4	5	6	7
19	10.00	Providing and erecting Approved make Four pole moulded case circuit breaker having breaking capacity ICU of 25KA. at 415V, having normal current rating up to 25 A to 100A. with Fixed thermal & magnetic release suitable to work on A.C. supply 50 c/s. with all internal connections, spreader tinned copper & complete erected in existing 16 G.M.S. housing. ICS=100% of ICU only Cat III	6173.12	Rupees Six Thousand One Hundred SeventyThree Paise Twelve Only	Ea.	61731.20
20	2.00	Providing and erecting Approved make Four pole moulded case circuit breaker having breaking capacity ICU of 35 KA. at 415 V. having normal current rating 125A. with Fixed thermal & magnetic release suitable to work on A.C. supply 50 c/s. with all internal connections, spreader tinned copper & complete erected in existing 16 G.M.S. housing. ICS=100% of ICU only Cat III	8055.76	Rupees Eight Thousand FiftyFive Paise SeventySix Only	Ea.	16111.52
21	1.00	Providing and erecting Approved make Four pole moulded case circuit breaker having breaking capacity ICU of 35 KA. at 415 V. having Normal current rating 200A.with variable Thermal & magnetic release suitable to work on A.C.supply 50 c/s. with all internal connections, spreader tinned copper & complete erected in existing 16 G.M.S. housing ICS=100% of ICU only Cat III	16221.61	Rupees Sixteen Thousand Two Hundred TwentyOne Paise SixtyOne Only	Ea.	16221.61

Item No.	Quantities Estimated but may be more or less	Item Description	Estimated Rates		Unit	Total Amount according to estimated quantities.
			in Figure	in Words		
1	2	3	4	5	6	7
22	2.00	Supplying and erecting triple pole & neutral 440V/500V panel mounting Copper Busbars with four equal Nos. of electrolyte bus having current density not more than 1.6 Amp./sq.mm (Rated current/cross section area) duly wrapped with colour insulating tape for phase sequence of following current carrying capacity, erected with necessary bus bar supports/ insulators, main cable socket to each bar, erected in existing cubical panel with necessary connections. (B) Suitable for 200 Amp. capacity	3202.71	Rupees Three Thousand Two Hundred Two Paise SeventyOne Only	Rmtr	6405.42
23	156.00	providing and erecting Miniature circuit breaker single pole 6A to 25A suitable to operate on 240 V A.C. system and having breaking capacity 10 KA to be erected in existing box. confirming to IS 8828/1996 with ISI Mark	112.11	Rupees One Hundred Twelve Paise Eleven Only	Ea.	17489.16
24	12.00	Providing & erecting 240 V MCB double pole switch for motor & inductive load (C Curve) having 10 KA breaking capacity & confirms to IS : 8828 in existing box having following capacity (A) 6 to 32 Amp.	299.97	Rupees Two Hundred NinetyNine Paise NinetySeven Only	Ea.	3599.64
25	6.00	Providing & erecting 415 V MCB Four Pole for Motor & Inductive Load (C Curve) having 10KA breaking capacity & confirms to IS :8828 in existing box having following capacity (c) 63 Amp.	737.30	Rupees Seven Hundred ThirtySeven Paise Thirty Only	Ea.	4423.80
26	2.00	Providing & erecting 415 V MCB three Pole for Motor & Inductive Load (C Curve) having 10KA breaking capacity & confirms to IS :8828 in existing box having following capacity (a) 6 to 32 Amp.	587.82	Rupees Five Hundred EightySeven Paise EightyTwo Only	Ea.	1175.64

Item No.	Quantities Estimated but may be more or less	Item Description	Estimated Rates		Unit	Total Amount according to estimated quantities.
			in Figure	in Words		
1	2	3	4	5	6	7
27	2.00	Providing and erecting Sheet Steel powder coated MCB distribution board - flush / surface mounted fitted with busbar, neutral link, earth bar and DIN rail, Conforms to IS 8623-1 & 3, IEC 61439-1 & 3 without MCB to house appropriate nos. of MCBs.(The DBs should be used of same company of MCB to be used) suitable for (A) single phase incoming and horizontal single phase outgoing (b) sheet steel double door (IP-43) (iii) 8 way	1152.41	Rupees One Thousand One Hundred FiftyTwo Paise FourtyOne Only	Ea.	2304.82
28	6.00	Providing and erecting Sheet Steel powder coated MCB distribution board - flush / surface mounted fitted with busbar, neutral link, earth bar and DIN rail, Conforms to IS 8623-1 & 3, IEC 61439-1 & 3 without MCB to house appropriate nos. of MCBs.(The DBs should be used of same company of MCB to be used) suitable for (B) three phase incoming and single phase horizontal type outgoing Per phase isolation type (PPI) (b) sheet steel double door (iii) 8 way	3412.79	Rupees Three Thousand Four Hundred Twelve Paise SeventyNine Only	Ea.	20476.74
29	27.00	providing and erecting Approved make RCCBs conforming to IS: 12640 and having sensitivity of 30 mA and Short Circuit withstand capacity of 10 KA and suitable for operation on single phase 240V, 50Hz. having characteristic of quick action & tripping with all advance feature & do not incorporate any electronic component. for following Max. rating erected as directed (ii) 40Amps. DP Cat. III	2235.13	Rupees Two Thousand Two Hundred ThirtyFive Paise Thirteen Only	Ea.	60348.51

Item No.	Quantities Estimated but may be more or less	Item Description	Estimated Rates		Unit	Total Amount according to estimated quantities.
			in Figure	in Words		
1	2	3	4	5	6	7
30	8.00	Providing and erecting metallic vitrified danger notice board as per language suggested by engineer incharge for MEDIUM VOLTAGE installation to be erected as per IS 2551.	69.69	Rupees SixtyNine Paise SixtyNine Only	Ea.	557.52
31	12.00	Providing and erecting Annealed bare Copper wire 8 to 16 SWG.	794.87	Rupees Seven Hundred NinetyFour Paise EightySeven Only	Kg.	9538.44
32		Supplying & erecting earth pit of minimum bore dia.150mm size approved make Earthing Electrode consisting Pipe-in-Pipe Technology as per IS 3043-1987 made of corrosion free hot dipped G.I.Pipes having Outer pipe dia of 50mm having 80-200 Micron galvanising, Inner pipe dia of 25 mm having 200-250 Micron galvanising, connection terminal dia of 12mm with constant ohmic value surrounded by highly conductive compound with high charge dissipation suitable for following type of applications with chamber and heavy duty cover.				
		(A) (approved make OEM has to submit test certificate including value of earth resistance of installation duly stamped and signed by agency and officer Incharge has to ensure the value of earthing resistane mentioned in test Certificate) & having back filling compound of (B) Inner chemical (CCM Compound)- Resistivity:- 0.2 ohm / meter testing as per IEC 62561-2017, Voltage drop:- < 1 volt at no load & dry form, Sulphar content:- <2% (C) Back fill Compound:- Earthing compound should be capable to retain moisture for long time Necessary test report must be submitted by Agency.				

Item No.	Quantities Estimated but may be more or less	Item Description	Estimated Rates		Unit	Total Amount according to estimated quantities.
			in Figure	in Words		
1	2	3	4	5	6	7
	2.00	(a) For Electrical Installation up to 440V in normal soil Length of pipe - 1 Mtr Back filling compound - 1 Nos Bag of 15 Kg.	4591.46	Rupees Four Thousand Five Hundred NinetyOne Paise FourtySix Only	Ea.	9182.92
33	4.00	(c) For Electrical Installation covering Transformer Neutrals, Lightning arrester Earthing, A.C.Plant & Sensitive Computer System (like Automation, SCADA) i.e independent Earthing in normal soil. Length of Pipe : 3.00 mtrs Back filling Compound : 2 nos Bags of 25 Kg.	8636.51	Rupees Eight Thousand Six Hundred ThirtySix Paise FiftyOne Only	Ea.	34546.04
34		Providing & erecting weather proof, dust & vermin proof, floor mounted front operated outdoor type double door cubical panel board necessary IP-54 and above protection as per approval from engineer incharge made from 14 SWG thick CRC M.S. sheet for outer body & doors, 16 SWG thick CRC M.S.sheet for internal partitions with necessary accesories, supporting angles/flats channel including cutting, bending, drilling, welding, riveting with internal partitions & cable alley as per requirements & instruction of engineer-in-charge with erection of				
		supplied switch gears, BUSBARS, suitable size of inter connecting PVC copper wire/copper-aluminium strips, rubber grommets, rib, bakelite control fuses/ MCB for measuring instruments, earth bus & earth bolts, foundation flange - bolts-base Plates, sufficient nos. of hinged doors, handles with locking arrangement and rubber gasket, heavy duty end terminal connection, danger notice board, necessary ventilation, earthing strip complete. The Panel shall be painted with epoxy powder coating.				

Item No.	Quantities Estimated but may be more or less	Item Description	Estimated Rates		Unit	Total Amount according to estimated quantities.
			in Figure	in Words		
1	2	3	4	5	6	7
	6.00	(The rates excludes the cost of switchgears, bus bars, inter connecting mains & Copper Aluminium strips, meters, Fuses etc. The dimension shall be measured excluding base beams) The panel shall be supplied with following approved manufacturers with following size. (A) locally fabricated panel board (i) with 350 mm depth	11466.53	Rupees Eleven Thousand Four Hundred SixtySix Paise FiftyThree Only	Sqm	68799.18
35	680.00	Providing and erecting XLPE (IS:7098) (I)-88 ISI armoured cable Aluminium conductor for 1.1KV. to be laid on wall with necessary clamps or in existing trench/ pipe of following size of cables. (B) 2 core 6 Sq. mm	90.90	Rupees Ninety Paise Ninety Only	Mtr.	61812.00
36	55.00	Providing and erecting XLPE (IS:7098) (I)-88 ISI armoured cable multistrand Aluminium conductor for 1.1 KV. to be laid on wall with necessary clamps or in existing trench/ pipe of following size of cables (D) 3 1/2 core 70 Sq. mm (35 Sq.mm 1/2 core)	372.69	Rupees Three Hundred SeventyTwo Paise SixtyNine Only	Mtr.	20497.95
37	340.00	Providing and erecting XLPE (IS:7098)(I)-88 ISI armoured cable multistrand Aluminium conductor for 1.1 KV. to be laid on wall with necessary clamps or in existing trench / pipe of following size of cables (B) 4 core 25 Sq. mm	188.87	Rupees One Hundred EightyEight Paise EightySeven Only	Mtr.	64215.80
38	90.00	Making trench in soft soil of suitable width of 90 cm deep for laying cable or locating the fault all over the run and back filling the same and making the surface as normal ground.	46.46	Rupees FourtySix Paise FourtySix Only	Mtr.	4181.40

Item No.	Quantities Estimated but may be more or less	Item Description	Estimated Rates		Unit	Total Amount according to estimated quantities.
			in Figure	in Words		
1	2	3	4	5	6	7
39	70.00	Providing & laying approved make Double walled corrugated pipes (DWC) of polyethylene (conforming to IS 14930 II) with necessary connecting accessories of same material at required depth in existing trench for laying of cable. below ground / road surface for enclosing cable (A) 50 mm outer dia	62.62	Rupees SixtyTwo Paise SixtyTwo Only	Mtr.	4383.40
40	35.00	Providing & laying approved make Double walled corrugated pipes (DWC) of polyethylene (conforming to IS 14930 II) with necessary connecting accessories of same material at required depth in existing trench for laying of cable. below ground/ road surface for enclosing cable (C) 90mm outer dia	95.95	Rupees NinetyFive Paise NinetyFive Only	Mtr.	3358.25
41	68.00	Providing and, fixing heavy duty flange type brass cable gland with rubber ring for PVC insulated armoured cable complete with out going tails, insulating tape etc for following size of cables. (A) 2 to 4 core 2.5/4 Sq. mm	33.33	Rupees ThirtyThree Paise ThirtyThree Only	Ea.	2266.44
42	4.00	Providing and, fixing heavy duty flange type brass cable gland with rubber ring for PVC insulated armoured cable complete with out going tails, insulating tape etc for following size of cables. (B) 2 to 4 core 6 Sq. mm	38.38	Rupees ThirtyEight Paise ThirtyEight Only	Ea.	153.52
43	12.00	Providing and, fixing heavy duty flange type brass cable gland with rubber ring for PVC insulated armoured cable complete with out going tails, insulating tape etc for following size of cables. (E) 2 to 4 core 25 Sq. mm	51.51	Rupees FiftyOne Paise FiftyOne Only	Ea.	618.12

Item No.	Quantities Estimated but may be more or less	Item Description	Estimated Rates		Unit	Total Amount according to estimated quantities.
			in Figure	in Words		
1	2	3	4	5	6	7
44	6.00	Providing and fixing heavy duty flange type brass double compression type cable gland with rubber ring for PVC insulated armoured cable complete with out going tails, insulating tape etc for following size of cables. (C) 3 & 1/2 core 70 Sq. mm	103.02	Rupees One Hundred Three Paise Two Only	Ea.	618.12
45	144.00	Solder less crimping type Aluminium lugs conforming to IS suitable for cable of following size evenly crimped with high pressure tool & connected to switchgear terminals with brass/ cadmium plated nut bolts in an approved manner. (A) 1.5/ 2.5/4/6 Sq.mm	6.06	Rupees Six Paise Six Only	Ea.	872.64
46	48.00	Solder less crimping type Aluminium lugs conforming to IS suitable for cable of following size evenly crimped with high pressure tool & connected to switchgear terminals with brass/cadmium plated nut bolts in an approved manner. (C) 16/25 Sq.mm.	15.15	Rupees Fifteen Paise Fifteen Only	Ea.	727.20
47	6.00	Solder less crimping type Copper lugs conforming to IS suitable for cable of following size evenly crimped with high pressure tool & connected to switchgear terminals with brass/ cadmium plated nut bolts in an approved manner. (D) 25 Sq.mm.	15.15	Rupees Fifteen Paise Fifteen Only	Ea.	90.90
48	18.00	Solder less crimping type Copper lugs conforming to IS suitable for cable of following size evenly crimped with high pressure tool & connected to switchgear terminals with brass/cadmium plated nut bolts in an approved manner. (E) 35/50 Sq.mm.	22.22	Rupees TwentyTwo Paise TwentyTwo Only	Ea.	399.96



Item No.	Quantities Estimated but may be more or less	Item Description	Estimated Rates		Unit	Total Amount according to estimated quantities.
			in Figure	in Words		
1	2	3	4	5	6	7
49	79.00	Supply, Installation, Testing and Commissioning of suitable sweep, BEE 5 Star rated, Ceiling fan with Brush Less Direct Current (BLDC) permanent ferrite magnet Motor, class of insulation: B, Rust free 3 nos. Aluminium blades, 2 nos. canopies, shackle kit with earthing provision, copper winding, Power factor not < 0.9, Service Value (CMM/W) minimum 6.85, Air delivery minimum 215 CMM, 350 RPM, 230v (tolerance as per IS : 374-2019), THD < 10%, with remote unit for Speed Control and all remaining accessories including safety pin, nut bolts, washers, temperature rise = 75 degree C (Max.), suitable for 140 to 285 Voltage and rectifier circuit with surge, over current and overload protection, 50 Hz, Single phase AC Supply, earthing etc. Complete as required. [Make shall be approved by Engineer in Charge] (B) 1200 mm Sweep (48")	2885.57	Rupees Two Thousand Eight Hundred EightyFive Paise FiftySeven Only	Ea.	227960.03
50	207.00	Supplying and erecting 19 / 20 mm. nominal bore Medium Class M.S. Pipe down rod erected duly painted for fan complete with proper insulation without leakage and earthing.	108.07	Rupees One Hundred Eight Paise Seven Only	Mtr.	22370.49
51	10.00	Supplying & erecting fan hook box of 10 mm M.S. round bar bounded to the RCC bars up to 50mm length each side and pierced through a 16 Gauge M.S. box / Heavy Duty PVC box complete erected concealed in Ceiling with necessary finishing.	108.07	Rupees One Hundred Eight Paise Seven Only	Ea.	1080.70
52	10.00	Providing Fan clamp of 30 x 5 mm flat of required length & 10 mm M.S. Bolt & Nuts erected with necessary hook of 10 mm M.S. Round Bar.	98.98	Rupees NinetyEight Paise NinetyEight Only	Ea.	989.80

Item No.	Quantities Estimated but may be more or less	Item Description	Estimated Rates		Unit	Total Amount according to estimated quantities.
			in Figure	in Words		
1	2	3	4	5	6	7
53	10.00	Providing 2.5mm.thick laminated acrylic sheet to cover the fan hook or Fan box.	18.18	Rupees Eighteen Paise Eighteen Only	Ea.	181.80
54	5.00	Supplying & erecting single phase approved make industrial exhaust fan suitable for medium duty ring mounted low noise operation suitable for medium duty having following dia size and maximum speed in RPM [A] 305 mm dia 900 RPM	2054.34	Rupees Two Thousand FiftyFour Paise ThirtyFour Only	Ea	10271.70
55	192.00	Supplying & erecting approved make 230V, 50 Hz Operating Voltage low noise decorative Roof Mounting Exhaust fan having square frame and Slitted guard with mounting accessories, necessary pipings and fittings. (A) 300x300x200mm with 1250 RPM	4280.38	Rupees Four Thousand Two Hundred Eighty Paise ThirtyEight Only	Ea.	821832.96
56	5.00	Providing suitable M.S. louver shutter of the Exhaust fan.	368.65	Rupees Three Hundred SixtyEight Paise SixtyFive Only	Ea.	1843.25
57	5.00	Supplying & erecting electro galvanised G.I. wire micro mesh jali cover of grade 304 required size with suitable wooden frame duly fitted in wall outside of exhaust fan for insect protection.	634.28	Rupees Six Hundred ThirtyFour Paise TwentyEight Only	Sq. Mtr	3171.40
58	5.00	Providing recess in wall or window frame suitable for erection of Exhaust fan complete with plastering and colour washing to match the colour of the wall or window complete with expanded metal in order to render the fitting in accessible and the room water-proof.	189.88	Rupees One Hundred EightyNine Paise EightyEight Only	Ea.	949.40

Item No.	Quantities Estimated but may be more or less	Item Description	Estimated Rates		Unit	Total Amount according to estimated quantities.
			in Figure	in Words		
1	2	3	4	5	6	7
59	9.00	Supplying and erecting approved make double ball bearing oscillating type Heavy duty bracket fan with Aluminium Blades A.C. 230V. 50cy/s wall mounted with height adjustment and rotary tilting device complete with guard, wall bracket, mounting accessories as directed. (A) 450mm	4950.01	Rupees Four Thousand Nine Hundred Fifty Paise One Only	Ea.	44550.09
60	34.00	Supplying & erecting approved make SMC press moulded composite FRP. loop-in, loop-out approx. 2mm thick box complete with Bakelite connector strip 5way (3P+N+E), DIN rail for mounting mob & hinged doors as per requirement having locking arrangements with mounting clamp with nuts, bolts & washers suitable for erection on pole with cable clamps& earth bolt of following size of box. (B) 250mm x 200mm x 100mm [deep]	515.10	Rupees Five Hundred Fifteen Paise Ten Only	Ea.	17513.40
61	34.00	Supplying and erecting B class galvanised iron pipe 32 mm outside dia 45 cm long duly welded on 20 cm x 20 cm x 3 mm thick M.S. base plate, erected on wall or corner for mounting street light luminaire with necessary hardware materials duly painted.	343.40	Rupees Three Hundred FourtyThree Paise Fourty Only	Ea	11675.60

Item No.	Quantities Estimated but may be more or less	Item Description	Estimated Rates		Unit	Total Amount according to estimated quantities.
			in Figure	in Words		
1	2	3	4	5	6	7
62	5.00	Providing and erecting <u>Inverter</u> based approved make split air-conditioning unit consisting of condensing unit with variable speed fan motor, inverter type hermetically sealed rotary compressor with accessories etc. duly connected separately erected evaporating unit and blower motor with its accessories by means of extra supplied proper insulated copper tubing, drain PVC pipes suitable for (cost includes Eco Friendly green gas charging and 15A plug top & Remote Control & MS Stand) with necessary core cutting. (2) For 4/5 Star Rating of current year (B) for 1.5 ton capacity- Premium Cat.	45980.25	Rupees FourtyFive Thousand Nine Hundred Eighty Paise TwentyFive Only	Ea.	229901.25
63	2.00	Providing & Erecting full SS Body (SS 304) Split type water cooler having storage capacity 160 to 175 Ltr. (Tank SS 304) & Cooling capacity 150 ltr. Per hour @ an ambient temp of 35°C. The outlet temp. of the water should drop by 15°C within a hour, The water cooler should be comprising of hermetically sealed Reciprocating compressor with R134A, fan motor, Copper Condensing unit with company fabricated Outdoor Unit water tank surrounded by evaporating coil, thermostats, relay etc. complete with necessary copper tube & Insulation, M.S Chanel Stand with Painting for water tank & M.S. Powder Coated Stand for Outdoor unit with Installation. With DPELCB and 4 Way DB Box with accessory Three core Cord for connection.	51143.37	Rupees FiftyOne Thousand One Hundred FourtyThree Paise ThirtySeven Only	Ea.	102286.74

Item No.	Quantities Estimated but may be more or less	Item Description	Estimated Rates		Unit	Total Amount according to estimated quantities.
			in Figure	in Words		
1	2	3	4	5	6	7
64	2.00	Supplying & erecting reverse osmosis (RO) water purification system with M.S. powder coated pedestal frame, prefilter housing carbon filter suitable buster DC pump, auto low & high pressure switches with following size of LPH capacity & erected as directed [E] 200 LPH with 1 phase/3 phase Raw water pump of 1000LPH @ 2.5kg/cm2 (1 No - Kirloskar/CRI/Lubi), Dual media filter 10"x54" (1 No), Micron cartridge filter 20" x 2.5" - (1No), High pressure pump 1000LPH @ 10kg/cm2 (1No - Shimge /CRI /Lubi), RO Membrane housing with RO membrane of 40*40 - ( 1 No), RO pressure tube 4" x 1E-(1No), 0-1200LPH Rotameter-(2 Nos). Recovery Rate 50%.	78061.89	Rupees SeventyEight Thousand SixtyOne Paise EightyNine Only	Ea.	156123.78
65	2.00	Supplying and erecting Direct on line starter with 30 Amp. (resistive @ 230v) power relay and with 2 to 5/4 to 10/8 to 20 amp. Range C.T. Operated electronic overload relay in engineering grade plastic enclosure for 3 ph 415v 50 HZ A.C. motor up to 7.5 HP with high voltage protection (above 480v) and under voltage protection (below 330v) current sensing single phasing protection. Reverse phasing protection, inverse current characteristic overload protection with indication for On, OL, HV, LV SPP in a single unit with feather touch start / stop push button, high temperature with standing Bakelite terminals complete erected on P.W. Block with necessary connection. [Cat.II]	2168.47	Rupees Two Thousand One Hundred SixtyEight Paise FourtySeven Only	Ea	4336.94

Item No.	Quantities Estimated but may be more or less	Item Description	Estimated Rates		Unit	Total Amount according to estimated quantities.
			in Figure	in Words		
1	2	3	4	5	6	7
66	2.00	Supplying and erecting approved make panel mounting type Digital Voltmeter having 3 digits LED display, 0 to 750 AC Volts range erected on existing panel board with all connection, wiring etc .with manufacturers calibration certificate.	1275.63	Rupees One Thousand Two Hundred SeventyFive Paise SixtyThree Only	Ea.	2551.26
67	2.00	Supplying and erecting approved make panel mounting type Digital Ammeter having 3 digits LED display, external CT operated, calibrated for 0 to 1000 Amps suitable to operate on 500 Volt AC, erected on existing panel board with all connection, wiring etc. with manufacturers calibration certificate.	1558.43	Rupees One Thousand Five Hundred FiftyEight Paise FourtyThree Only	Ea.	3116.86
68	6.00	Providing & erecting L.T. Current Transformer with bar primary 50/5 to 1000/5 ratio 15 VA burden erected in existing CRCA box duly secured with insulating materials connected to the meter	274.72	Rupees Two Hundred SeventyFour Paise SeventyTwo Only	Ea.	1648.32
69	6.00	Supplying and erecting approved make suitable panel indicator LED type lamp, lens cover, complete erected with necessary connections.	43.43	Rupees FourtyThree Paise FourtyThree Only	Ea.	260.58
70	1.00	Providing & erecting open well horizontal mono block pump set with cast iron body, complete for three phase submersible motor having [D] For 5 HP 3 phase open well horizontal mono block pump set suitable for 1350 LPM to 310 LPM @ 10 to 42 Mtr head suitable for 50/65 mm dia delivery pipe	18746.61	Rupees Eighteen Thousand Seven Hundred FourtySix Paise SixtyOne Only	Ea.	18746.61

Item No.	Quantities Estimated but may be more or less	Item Description	Estimated Rates		Unit	Total Amount according to estimated quantities.
			in Figure	in Words		
1	2	3	4	5	6	7
71	1.00	Supplying & erecting approved make Automatic liquid level controller 6A. with sensor testing as per instruction of Engineer in charge on site complete with wiring connection with existing wires, with copper conductor from pump to upper and lower tank.	2355.32	Rupees Two Thousand Three Hundred FiftyFive Paise ThirtyTwo Only	Ea.	2355.32
72	1.00	S.I.T.C. submersible pump set suitable for bore of 100 mm. dia. or more having three phase motor capacity not more than 5 H.P. with following capacity. Lifting and Lowering taken extra. (A) (25 stage) 120 to 125 LPM discharge at 155 to 120 mtrs. head respectively suitable for 50 mm dia. delivery pipe	26894.28	Rupees TwentySix Thousand Eight Hundred NinetyFour Paise TwentyEight Only	Ea.	26894.28
73	1.00	Lowering of submersible motor pump set at the depth of following, complete with required. Nos. and size of casing pipes erected by means of proper chain pulley block & pipe wrenches after checking of threads of each pipe with coupling to take the load of the pump set and pipe assembly filled up with water (B) Above 60 mtrs. and Up to 120 mtrs.	2568.43	Rupees Two Thousand Five Hundred SixtyEight Paise FourtyThree Only	Per Job	2568.43
74	1.00	Lowering of submersible motor pump set at the depth of following, complete with required. Nos. and size of casing pipes erected by means of proper chain pulley block & pipe wrenches after checking of threads of each pipe with coupling to take the load of the pump set and pipe assembly filled up with water (D) For Open well Horizontal submersible pump set for sump well (i) 1 HP to 5 HP	856.48	Rupees Eight Hundred FiftySix Paise FourtyEight Only	Per Job	856.48

Item No.	Quantities Estimated but may be more or less	Item Description	Estimated Rates		Unit	Total Amount according to estimated quantities.
			in Figure	in Words		
1	2	3	4	5	6	7
75	200.00	Providing and erecting ISI marked PVC insulated PVC Sheathed Flat flexible Submersible copper cable approved make of following Size. (C) 3 Core x 4 Sq. mm	146.45	Rupees One Hundred FourtySix Paise FourtyFive Only	Mtr.	29290.00
<b>FURNITURE AND COMPUTER</b>						
1	4.80	Supplying And Installatin of Office Table of 740mm Height. Table Top Made from 25 mm Thick Pre-laminated Particle board. Side Panels Made from 25 mm Thick Pre-laminated Particle board. All the edges are sealed with 2 mm thick PVC Edge band. The drawers are provided with suitable slides for smooth operation. All the pedestal drawers are centrally locked with a single key. <b>(Measured L X W)</b>	12356.34	Rupees Twelve Thousand Three Hundred FiftySix Paise ThirtyFour Only	Sqm	59310.43
2		Supplying and Installation of High back chair : High Back Rev. Chair -Upholstered with Leatherette seat made up of 12 mm +/- 1 mm thick hot pressed Mr grad plywood and back in two Pieces - 12 mm inner Back and 6 mm in Rear Back. Moulded polyurethane foam used in making seat with moulded density 45+/- 2 kg/m <sup>3</sup> . Back is made out of 32 Density Block Foam covered with 14 mm thick 32 density foam sheet (Block foam).				
	1.00	The mechanism of the chair have following features : 360° revolving, synchro Mechanism, Tilt tension adjustable, multi position locking, Overall dimensions of Chair - Width of Chair - 640 mm, Depth of chair 640 mm as measured from base below. Height of back from ground - min 1170 mm to max 1270 mm. Seat height - min 480 mm to max 580 mm.	7668.93	Rupees Seven Thousand Six Hundred SixtyEight Paise NinetyThree Only	EA	7668.93



Item No.	Quantities Estimated but may be more or less	Item Description	Estimated Rates		Unit	Total Amount according to estimated quantities.
			in Figure	in Words		
1	2	3	4	5	6	7
3	11.00	Supplying and providing Visitor chair : Over all Size - 400W X 450D X 900H MM. Seat size : 400W X 450D MM. Back Size : 400W X 300H MM. pipe structure of MS CRCA finish 16 gauge round pipe having a diameter of 32 mm. Proper high-density rubber bush provided at all four legs, seat & back upholstered with fabric.	3941.02	Rupees Three Thousand Nine Hundred FortyOne Paise Two Only	EA	43351.22
4	3.00	Providing, Supplying and commissioning of Desktop Computer with LED Screen 22" having Resolution 1920 X 1080, CPU Specifications of intel i5 10400 processor, Windows Latest Operating system with life time liecence and all complete as per attach separate document with standard company keyboard and mouse.	36661.99	Rupees ThirtySix Thousand Six Hundred SixtyOne Paise NinetyNine Only	Set	109985.97
5	2.00	Providing, Supplying and commissioning of Brother HL-L2321D laser Mono Computer Printer for A4 paper size and all complete as per given instruction of Engineer-in-charge.	14298.57	Rupees Fourteen Thousand Two Hundred NinetyEight Paise FiftySeven Only	Set	28597.14

Item No.	Quantities Estimated but may be more or less	Item Description	Estimated Rates		Unit	Total Amount according to estimated quantities.
			in Figure	in Words		
1	2	3	4	5	6	7
<b>CCTV CAMERA</b>						
1	14.00	Providing & Installation of <b>(APPROVED MAKE ONLY)</b> 2 MP IP CCTV camera	5055.05	Rupees Five Thousand FiftyFive Paise Five Only	Nos	70770.70
2	1.00	Providing & Installation of <b>(APPROVED MAKE ONLY)</b> 8 MP IP Bullet CCTV camera	29497.05	Rupees TwentyNine Thousand Four Hundred NinetySeven Paise Five Only	Nos	29497.05
3	2.00	Providing & Installation of <b>(APPROVED MAKE ONLY)</b> 2 MP Omni Direction IP Dome CCTV camera	10610.05	Rupees Ten Thousand Six Hundred Ten Paise Five Only	Nos	21220.10
4	2.00	Providing & Fixing 16 channel NVR with 2 Sata (APPROVED MAKE ONLY)	12221.00	Rupees Twelve Thousand Two Hundred TwentyOne Only	Nos	24442.00
5	3.00	Providing 4TB Sueveillance Hard Disk (APPROVED MAKE ONLY)	10887.80	Rupees Ten Thousand Eight Hundred EightySeven Paise Eighty Only	Nos	32663.40
6	3.00	Providing & Fixing 8 Port POE Switch with POE Box (similar hifcous or secureye) (APPROVED MAKE ONLY)	19341.50	Rupees Nineteen Thousand Three Hundred FourtyOne Paise Fifty Only	Nos	58024.50
7	16.00	Providing & Fixing 5 X 5 PVC Junction Box (APPROVED MAKE ONLY)	55.55	Rupees FiftyFive Paise FiftyFive Only	Nos	888.80
8	40.00	Providing & Fixing RJ 45 Connectors (APPROVED MAKE ONLY)	22.22	Rupees TwentyTwo Paise TwentyTwo Only	Nos	888.80

Item No.	Quantities Estimated but may be more or less	Item Description	Estimated Rates		Unit	Total Amount according to estimated quantities.
			in Figure	in Words		
1	2	3	4	5	6	7
9	1.00	Providing & Fixing 3U Rack for Junction (APPROVED MAKE ONLY)	1610.95	Rupees One Thousand Six Hundred Ten Paise NinetyFive Only	Nos	1610.95
10	500.00	Providing & Fixing PVC Pipe as per required all Accessories (APPROVED MAKE ONLY)	25.55	Rupees TwentyFive Paise FiftyFive Only	Mtr	12775.00
11	600.00	Providing & erecting of CAT 6 Cable (APPROVED MAKE ONLY)	58.88	Rupees FiftyEight Paise EightyEight Only	Mtr	35328.00
12	1.00	Providing & Fixing 43" LED TV Display (APPROVED MAKE ONLY)	55550.00	Rupees FiftyFive Thousand Five Hundred Fifty Only	EA	55550.00
13	1.00	Providing and Fixing 8 Port GIGA Switch (APPROVED MAKE ONLY)	3110.80	Rupees Three Thousand One Hundred Ten Paise Eighty Only	No	3110.80
<b>FIRE AND SAFETY</b>						
1	1.00	Supplying, Installation, Testing and Commisioning of modern Conventional Fire alarm penal with all standard accessories 4 Zone	105545.00	Rupees One Lakh Five Thousand Five Hundred FourtyFive Only	No.	105545.00
2	6.00	Supplying, Installation, Testing and Commisioning of Single action Manual Pull Station. Shock and Vibration Resistant, Pull Down Lever Remains Down until Reset.	611.05	Rupees Six Hundred Eleven Paise Five Only	No.	3666.30
3	6.00	Supplying, Installation, Testing and Commisioning of Conventional Sounder, Complete with Junction Box for mooting on surface, Cable lugs at Ends, cable Comperission glands, cable tags and Ferruling.)	611.05	Rupees Six Hundred Eleven Paise Five Only	No.	3666.30

Item No.	Quantities Estimated but may be more or less	Item Description	Estimated Rates		Unit	Total Amount according to estimated quantities.
			in Figure	in Words		
1	2	3	4	5	6	7
4	6.00	Supplying, Installation, Testing and Commissioning of ON / OFF Switch for each floor.	455.51	Rupees Four Hundred FiftyFive Paise FiftyOne Only	No.	2733.06
5	1.00	Supplying, Installation, Testing and Commissioning of heavy duty medium voltage cable as per specification & IS 7098 part - I, 2C X 1.5 Sqmm Flexible cable (finolex, Polycab)	166650.00	Rupees One Lakh SixtySix Thousand Six Hundred Fifty Only	Lot	166650.00
6	1.00	Alarm System Labour Charges	49995.00	Rupees FortyNine Thousand Nine Hundred NinetyFive Only	Lot	49995.00
7	12.00	Smoke Detector	1388.75	Rupees One Thousand Three Hundred EightyEight Paise SeventyFive Only	Nos.	16665.00
8	19.00	Providing and Fixing ISI Marked portable fire extinguisher, 4.5 kg CO2 type fire extinguishers complete in all respect including initial fill and wall suspension brackets & shall conform to IS 15683	3555.20	Rupees Three Thousand Five Hundred FiftyFive Paise Twenty Only	No.	67548.80
9	19.00	Providing and Fixing ISI marked Fire Extinguisher, Dry Chemical powder type capacity 6 kgs conforming to IS :15683 including first fill & wall suspension bracket.	2110.90	Rupees Two Thousand One Hundred Ten Paise Ninety Only	No.	40107.10
10		Design, supply & installation of safety signage made of zinc base glow in the dark rigid sheet with high luminous with pasted on 3 mm thick on rigid PVC foam sheet.				

Item No.	Quantities Estimated but may be more or less	Item Description	Estimated Rates		Unit	Total Amount according to estimated quantities.
			in Figure	in Words		
1	2	3	4	5	6	7
10.1	15.00	Fire Point, 18" x 6"	277.75	Rupees Two Hundred SeventySeven Paise SeventyFive Only	EA	4166.25
10.2	15.00	In Case Of fire,Fire 18" X 6"	277.75	Rupees Two Hundred SeventySeven Paise SeventyFive Only	EA	4166.25
10.3	15.00	EMERGENCY Exit 18" x 6"	277.75	Rupees Two Hundred SeventySeven Paise SeventyFive Only	EA	4166.25

Item No.	Quantities Estimated but may be more or less	Item Description	Estimated Rates		Unit	Total Amount according to estimated quantities.
			in Figure	in Words		
1	2	3	4	5	6	7
<b>PAVER BLOCK ROAD</b>						
1	1025.90	Box cutting the road surface as required for direction by engineer-in-charge to proper slope and camber for making a base for road work including removing the excavated stuff and depositing on the road side slope as directed up to any lead.	104.20	Rupees One Hundred Four Paise Twenty Only	m3	106898.78
2	513.00	Providing and laying compacted WBM 150mm thick of grade II by using machine crushed B.T. metal of size 45mm to 63mm, with using 13% screening 13.2 size and 7% stone dust as binding materials, including spreading watering and consolidation with all lead and lift.	777.70	Rupees Seven Hundred SeventySeven Paise Seventy Only	m3	398960.10
3	342.00	Providing and laying controlled cement concrete M.150 for curing complete excluding cost of formwork and reinforcement for reinforced concrete work in (A) Foundations, footings, Base of columns and Mass concrete	3910.10	Rupees Three Thousand Nine Hundred Ten Paise Ten Only	m3	1337254.20
4	3993.20	Providing and fixing pre-cast Rubber Dye / steel Dye inter locking concrete block 60mm thick with grade of concrete M300 pneumatic compressed / vibrated mechanically and as per approved design Confirming to IS 15658 : 2006 including 35 mm Sand layer for levelling and filling the joint with sand in proper line and level as per guidelines of IRC : SP 63-2018 etc. Complete.	686.90	Rupees Six Hundred EightySix Paise Ninety Only	Sqm	2742929.08
<b>Total</b>						<b>68855312.92</b>

Item No.	Quantities Estimated but may be more or less	Item Description	Estimated Rates		Unit	Total Amount according to estimated quantities.
			in Figure	in Words		
1	2	3	4	5	6	7

**One percent of the Estimated cost of work put to tender shall be recovered from the running bills of the contractor as testing charges, after deducting the cost of material proposed in scheduled-A at basic rate. One percent labour cess will be deducted from contractor's bill.**

I/ We am/are willing to carry out the work at \_\_\_\_\_% above / below \_\_\_\_\_%

below / above the estimated rates mentioned above amount of my / our tender works out as under :-

Estimated amount put to tender :

Rs. \_\_\_\_\_.

Add \_\_\_\_\_% above \_\_\_\_\_.

Rs. \_\_\_\_\_.

Net Rs. \_\_\_\_\_.

In words Rs. \_\_\_\_\_.

Estimated amount put to tender :

Rs. \_\_\_\_\_.

Deduct \_\_\_\_\_% below \_\_\_\_\_.

Rs. \_\_\_\_\_.

Net Rs. \_\_\_\_\_.

In words Rs. \_\_\_\_\_.

**Signature of contractor**

**EXECUTIVE ENGINEER  
BUILDING DEPARTMENT  
BHAVNAGAR MUNICIPAL CORPORATION**

Item No.	Quantities Estimated but may be more or less	Item Description	Estimated Rates		Unit	Total Amount according to estimated quantities.
			in Figure	in Words		
1	2	3	4	5	6	7

**Notes :**

- 1) All the work shall be carried out as per specification on the division or as directed.
- 2) Rates quoted includes clearance of site (prior to commencement of work and at its closed) in all respects and held gross for under all conditions, site moisture weather etc.
- 3) The Contractor shall exhibits a board as per Govt. circular No. 2DK – 3277 / 1657 N Dt. 26-01-73 with detail of specification and details of work and amount involved at site without any payment as directed by the Engineer in charge.
- 4) Testing of materials be as per statement attached with the Specifications, the materials shall be tested at least 10% in G.E.R.I. Bill for testing shall be paid by Contractor.
- 5) One precent of estimated cost put to tender for this work shall be recovered from the contract payments as "LABOUR CESS". In terms of the Gujarat Government Gazette Extra ordinary dated 12.12.04. Implementation of building and other construction workers regulation of equipments and conditions of service Act-1996)
- 6) Photographs of before work and after work will be submitted by the contractor at the time of each bill submission.
- 7) The contractor is solely responsible to bare all applicable taxes. exept GST. and department will not entertain any contractor representation to reimburse any financial burden due to applicable taxes : exept GST.
- 8) The contractor shall submit all paid taxes, royalty challans at the time of the final bill.

**Signature of contractor**

**EXECUTIVE ENGINEER  
BUILDING DEPARTMENT  
BHAVNAGAR MUNICIPAL CORPORATION**



# **BHAVNAGAR MUNICIPAL CORPORATION**



**Bid Documents For**  
**PROPOSED DOG HOME SHELTER & ANIMAL VACCINATION**  
**CENTRE AT NARI ROAD, KUMBHARWADA, BHAVNAGAR, DIST.**  
**BHAVNAGAR**

## **TECHNICAL & COMMERCIAL BID**

**ARCHITECTS:**  
**MANISH RUPARELIA PVT. LTD.**  
901-902, Time Square,  
Ayodhya Circle, 150 Feet Ring Road,  
Rajkot 360 006

**EXECUTIVE ENGINEER**  
Building Department  
Bhavnagar Municipal Corporation  
Mangalsinhji Road,  
Bhavnagar – 364 001

## **INTRODUCTION**

### **TENDER NO.**

The owner, M/s. Bhavnagar Municipal Corporation, Bhavnagar (hereinafter referred to as Employer or Owner) Propose to Develop Dog Home Shelter, with area development & landscaping at Nari Road, Kumbharwada, Bhavnagar.

Name of Work: PROPOSED DOG HOME SHELTER & ANIMAL VACCINATION CENTRE AT NARI ROAD, KUMBHARWADA, BHAVNAGAR, DIST. BHAVNAGAR

### **INTRODUTION:**

The site of work is a fast-developing area where in develop garden is proposed and to achieve timely completion and quality eligible bidders is to be appointed, who shall execute the work in scheduled time.

**THE ESTIMATED COST OF PROPOSED WORK IS APPROXIMATELY RS. 68855313.00/- (Excl. of GST) (Inclusive of materials and labour)**

**THE WORK IS TO BE COMPLETED WITHIN A PERIOD OF 30 (Thirty) Months including Monsoon period**

In view of the above and to get resourceful and experienced agencies (Contractors or Bidders), it is necessary to get them pre-qualified for the work under reference on the basis of the documents submitted by the contractors as asked by Bhavnagar Municipal Corporation.

With a view to select a competent agency for development of Dog Home Shelter tender documents are issued. The Tender Documents include Technical Bid / Prequalification Bid. Only the tenders of the tenderers who are qualified in the Technical Bid / Prequalification Bid will be considered for further evaluation. The tenderers (bidders) are requested to send all the required documents as mentioned in the Technical Bid / Prequalification Bid.

Decision of the Bhavnagar Municipal Corporation regarding pre- qualification based on the documents furnished by the bidders / contractors will be final and binding to all the bidders and no correspondence will be entertained from any of the bidders in this regard.

The Bhavnagar Municipal Corporation reserves the right to reject any or all the Technical Bids for pre-qualification without assigning any reasons thereof.

All decision to award the work will be made by employer. The Architect / consultant of the Bhavnagar Municipal Corporation will prepare / verify all necessary plans, drawings, sections etc. The Consultants of the Bhavnagar Municipal Corporation and/or the engineer or any other officer authorized by the employer will protect the interest of the employer. He represents the employer for the work under this contract.

The Architect / Engineer or any other Officer authorized by the Bhavnagar Municipal Corporation is entitled to ask the contractor to discontinue any work which does not meet the expected and/or specified standards. The work already executed may be rejected and asked to be removed for the said reasons. The contractor has to do his work strictly accordingly to the plans/drawings, estimates and specifications appended herewith which together with general conditions, commercial terms and specifications, scheduled of items, technical specifications, data sheet of respective sections and bid purpose drawings, bill of quantities and contract agreement will be called "Document of Contract".

The selected tenderer will have to enter into an agreement with the Bhavnagar Municipal Corporation on a stamp paper of Rs.300 to be provided by the selected tenderer in the form approved by the Bhavnagar Municipal Corporation covering all terms and conditions inter alia that are advertised and stated in this tender form and those which may be agreed upon or modified by both parties during subsequent correspondence / discussions / negotiations.

The tenderers are requested to send along with the tender the solvency certificate (format attached) for 20% of project estimate which would not be earlier than (April) 2023, from any Nationalized Bank, any scheduled bank like HDFC, AXIS, ICICI & IDBI Bank only.

**Dated Signature &  
Contractor**

**Signature & Stamp of the  
Stamp of the Employer**

**NOTE: In case of any discrepancy, the tender notice (NIT- Notice Inviting Tender) published on "nprocure.com" shall prevail.**

- 1.** A bidder registered either in DGS&D, SSI, and NSIC or in the Central/State Govt. undertaking is not exempted by this Bhavnagar Municipal Corporation for paying EMD, SD, etc. As well as no price preferences over the quoted rate will be considered.
- 2.** Bidders are requested to visit the site before quoting the tender.
- 3.** Tender will be considered only of those parties having Provident Fund Number received from Regional Provident Fund Commissioner's office and Permanent Account Number of Income Tax, GST No. And qualified as per Pre-Qualification criteria/ bid.
- 4.** Tender documents are only available in electronic form. The bidder should submit all the forms electronically only. Hard copy of the supporting documents should reach to the office of Executive Engineer, building department, as mentioned in NIT
- 5.** Tender Fee is non-refundable.
- 6.** Only the tenders of the tenderers who are qualified in the Technical Bid / Prequalification Bid will be considered for further evaluation.
- 7.** The Bhavnagar Municipal Corporation reserves the right to allot the work in parts to more than one agency whose Technical Bid is qualified for the work.

Issued to M/s. \_\_\_\_\_

## **INSTRUCTIONS TO THE TENDERER**

(To be read & studied before quoting the Tender)

- (1)** Only one authorized representative of the tenderers will be allowed to remain present at the time of opening of the Technical Bid / Prequalification Bid and also the Price bid. Authorized representative must come with his company's Authority letter and with attested signature of their presentative recommending him to allow to remain present at the time of opening of their spectate bids, failing which no representative will be allowed to remain present at the time of opening of the bids.
- (2)** The tenderers are required to visit the site along with the purchased tender copy, to study the actual working condition before submitting the offer.
- (3)** The total works under this tender is with "providing, constructing, erecting and laying/fixing as well as testing & commissioning" the entire work of project. In the event of missing of above phrase in the description of schedule of quantities will not mean that the client will supply materials and tenderer has to deploy only labour for completing all the items.
- (4)** No escalation in price / rate will be allowed on any ground. Even if there is a delay incomplection of the work due to client, extension in time limit may be granted with an explicit understanding that no price escalation will be paid.
- (5)** In absence of detailed specifications, the work should be carried out based on either relevant IS code and /or fair engineering practice prevailing in the market.
- (6)** All the rates quoted by the tenderer must be inclusive of all taxes, duties, S/T, transportation, labour, sales tax, turn over tax, loading, unloading at site etc. GST will be paid as actual at the prevailing rate in the respective quarter.
- (7)** Successful tenderer will have to submit three copies of the detailed bar chart in the manners per the proforma issued by the client, for timely completion of the work.
- (8)** Before execution of work bidders shall submit drawings (Shop drawings) and execute work only after approval from consultants.
- (9)** Bidders are advised to read the instruction, evaluation norms and other terms and conditions described in this document under different chapters carefully

before making their offer. In case of any doubt, they may seek clarification from Executive Engineer, Bhavnagar Municipal Corporation.

- (10) Star Rate, Price Escalation, price Variation in any items of Schedule-B / Extra item will Not be given by Bhavnagar Municipal Corporation.**

**If Same will be stated in any Bid Documents will not be Considered.**

#### **THE TENDER AND THE OFFER:**

It is a two-bid system. The bid is required to be submitted on line at <http://www.tender.nprocure.com> by the date and time prescribed in the tender notice as under:

#### **PRELIMINARY BID / TECHNICAL BID:**

- To be submitted online about the details of Tender document, fee and EMD.
- Technical bid documents are to be submitted on line. However, the documents required to be submitted in support of experience, financial position, status of the bidder, information regarding machinery and equipment owned by the bidders, etc. as well as tender fee and EMD in the described form shall be placed in sealed cover super-scribed "Technical Bid, Tender No. and Name of work", should be submitted separately to Executive Engineer, Bhavnagar Municipal Corporation, before stipulated time otherwise tender will not be considered for further evaluation.

#### **PRICE BID:**

- To be submitted on line before stipulated time.

#### **OPENING OF BIDS**

- a.** E-tendering procedure is explained in detail in Pre – Qualification Data Sheet.
- b.** Preliminary bids will be opened after verification of receipt of payment towards Tender document fee and EMD. The bidders will have to view it on their computers on date and time notified in tender notice.
- c.** On verification of the supporting documents, technical qualification of the bidders will be assessed. The successful bidders will be communicated the

date and time of online opening of price bids by fax or telephone or email. However, all the bidders will be able to view the price bids online on their computers.

**CORRIGENDUM:**

Sometimes issue of corrigendum may be necessary to clarify doubts raised or to make some corrections. All such corrigendum shall be displayed on website <http://www.tender.nprocure.com> only. **The bidders are therefore advised to refer this website from time to time to themselves updated.**

Tenders will be opened in Two Bid system, i.e. Technical or Prequalification Bid and Price Bid. First the Technical or Prequalification Bid will be opened on the date of opening of the tender in the presence of the tenderer. The Bhavnagar Municipal Corporation will scrutinize the same and the Price Bids will be opened only of those tenderers, who qualify themselves in Technical or Prequalification Bid. The technically qualified tenderers (Prequalified Tenderers) will be being formed regarding the date, time and venue for the opening of the Price Bid.

**Executive Engineer  
Building Department  
Bhavnagar Municipal Corporation**

- (11)** If demand draft of EMD is not enclosed in the sealed technical bid cover, the tender will not be considered for scrutiny and will be summarily rejected.
- (12)** The tenderer will have to submit 'NO DEMAND CERTIFICATE' along with the final bill of the work, as per the Proforma given in this document.
- (13)** Successful tenderer will have to enter in to the agreement with the Bhavnagar Municipal Corporation on an appropriate stamp paper of Rs. 300/- (to be provided by the contractor) after accepting the Letter of Intent and having agreed to and accepted the terms and conditions of the tender.
- (14)** No page from the tender documents shall be defaced or detached. Also no correction in the tender documents shall be made by the tenderer. Any comments which the tenderer desires to make, shall not be placed on the tender documents, but shall take the form of a separate statement, as brief as possible, and giving reference to pages and clauses of the tender documents.

**(15)** Tender documents consist of:

**VOLUME – 1:**

**PART – 1: B-2 form**

**PART – 2: INTRODUCTION AND FORMS**

- (a)** Introduction
- (b)** Instructions to Tenderers
- (c)** Articles of Agreement
- (d)** Additional Conditions
- (e)** Special Note
- (f)** Declaration – I
- (g)** Declaration - II
- (h)** Mode of Payment (Of running Bills)
- (i)** No Demand Certificate
- (j)** Legal Provisions - Appendix - II
- (k)** Tax Laws - Appendix - III

**PART – 3: PREQUALIFICATION DATA SHEETS**

- (a)** Pre-qualification data sheet
- (b)** Schedule – B – B.1.1
- (c)** Schedule – B – B.1.2
- (d)** Schedule – B – B.1.3
- (e)** Schedule – B – B.1.4
- (f)** Schedule – B – B.1.5

**VOLUME – 2:**

**(A) TECHNICAL SPECIFICATION:**

- (a) Civil work**
- (b) Electrical work**



**(c) Filter plant & technical details**

- (c-1)** Appendix – 1. Technical Data. (Swimming Pool recirculating pump)
- (c-2)** Appendix – 2. Technical Data. (Swimming Pool Filter)
- (c-3)** Appendix – 3. List of Approved makes
- (c-4)** Appendix – 4. List of Approved makes for M.C.C.
- (c-5)** Appendix – 5. Running cost of filtration plant for 12 hours per day Competition Pool

**(d) O & M Specification**

**(B) PRICE BID**

(C-1) Schedule of quantities for Equipment's, Electrification work and accessories.

**(C) Drawings.**

- (16)** Schematic Drawing is attached with the tender.
- (17)** Submission of tender will be the conclusive evidence that the tenderer has fully satisfied him as to the nature and scope of the work to be done, site conditions, and all other factors affecting the performance of the contract and the price and also as to the terms and conditions of the contract.
- (18)** Access to the site during tender period may be arranged by appointment on application to the employer.
- (19)** The tender notice along with the tender documents as detailed together with any other documents as may be hereafter mutually agreed to by the parties, will form the contract agreements referred to above.
- (20)** Should the tenderer find any discrepancy, omission, ambiguity or conflict in or among the documents forwarded or be in doubt as to their meaning and interpretation, such matter should be called to the attention of the employer and architect/consulting engineer Bhavnagar not later than 7 days prior to the date of submission of tender. On receipt of such queries the architect/consulting engineers will issue a clarification which will also form a part of the contract. Neither the employer nor the Engineer-In- Charge/architect/consulting engineer

will be responsible for any oral instructions.

- (21)** The tenderer, if so, required by the Engineer-in-Charge/ architect/ consulting engineer will have to submit detailed computations showing the figures on which the unit and overall rates are based.
- (22)** The tenderer is expected to quote rate for each item after careful analysis of the cost involved for the execution and performance of each item considering all the conditions of contract and the specifications. In case it is noticed that the rates quoted by the tenderer for any item are unusually high or low it will be sufficient cause for the rejection of the tender unless the architect/consulting engineer is convinced about the reasonableness of the rates on scrutiny of the analysis for such rates to be furnished by the tenderer on demand.
- (23)** The rates should be written both in figures and in words. In case of any difference between rates in figures and words, the rates in words will prevail.
- (24)** Tenderers must disclose the names of their partners, if any, in the particular contract. Any tenderer failing to do so will render himself liable to have his earnest money deposit forfeited and the contract, if entered into, cancelled at any time during its currency.
- (25)** If it is found that two or more persons who are connected with one another either financially or as principal and agent or master and servant have tendered under different names for the same contract without disclosing their connections, then such tenders will be rejected and the earnest money deposit forfeited. Any contract entered into under such conditions is also liable to be cancelled.
- (26)** In case the tenderer is a joint stock company, the contract must be affixed with the seal of the company in the presence of witnesses and signed by two Directors or by persons duly authorized to sign the contract for the company under a power of attorney. The tenderer shall produce a certified copy of such power of attorney at the time of making the agreement.
- (27)** The tenderer shall enclose a list of plants and equipment which he / they propose to employ to execute the work covered by this tender. The list should show separately the plant and machinery that is available with him/them and those which are proposed to be acquired for this work.
- (28)** All the documents forwarded herewith are to be returned with the tender. The

tenderer must fill in all blank spaces in the form of tender and sign in long hand as and where shown. Only the principal authorized to make the contract, should sign the tender, and execute the contract on behalf of the tenderer.

- (29)** The tenderer must be very careful to deliver a Bonafede tender. Such a tender must propose any other condition than those laid down in this Document.
- (30)** Any tender who proposes alterations to any of the conditions laid down, or which proposes any other conditions of any description whatever is liable to be rejected.
- (31)** The tenderers shall have to quote for all the items of all the Schedules of Bills of Quantities of the tender document. Incomplete tenders are liable to be rejected.
- (32)** The tenderer shall quote balanced rates for all the items. The quantities given in the tender are merely for the guidance of the tenderer and may vary on either side up to any extent during actual execution. Some of the items may be added, deleted, omitted or altered during actual execution of work. No claim whatsoever shall be entertained on the account of variation in the quantities. Speculative tender is liable to be rejected.
- (33)** The contractors will accept the minimum of unit rates (Rate Only Items) quoted by the prequalified bidders whose Price Bids are considered.
- (34)** Bidders can prepare & edit their number of times before tender submission date & time. After tender submission date & time, bidder cannot edit their offer submitted in any case. No written or online request in this regard shall be granted.
- (35)** Tender fee, EMD and other document received later than the time specified will not be accepted in any case and the bid of that bidder shall be considered non responsive.

For and on behalf of owner

Signature and Stamp of the tenderer

Signature of the Owner



## QUALIFICATION CRITERIA FOR TENDERERS

### Eligibility Criteria

#### A For Civil / Electrical Works (Lead partner)

##### A-1 Physical criteria

i) Experience of having successfully completed similar works during last 7 years ending last day of month previous to the one in which applications are invited should be either of the following

a. Three similar completed works costing not less than the amount equal to 40% of the estimated cost.

**or**

b. Two similar completed works costing not less than the amount equal to 50% of the estimated cost.

**or**

c. One similar completed work costing not less than the amount equal to 80% of the estimated cost.

##### A-2 Financial criteria

i) Average Annual financial turnover during the last 3 years, ending 31st March of the previous financial year, should be at least 30% of the estimated cost. Proof for the same from registered chartered accountant shall have to be produced.

### 2 **General Experience**

**2.1** The bidder shall meet the following minimum criteria:

(1) The bidders shall have financial capability and having annual average turnover of last three years of a minimum Rs. 100 Lacs (One crore)

(2) Execution of at least three similar types of works with satisfactory completion & operation.

### 3 **Financial Position**

**3.1** The audited balance sheets for the last three years should be submitted and must demonstrate the soundness of the bidder's financial position, showing long-term profitability.

#### **4 Litigation History**

**4.1** The bidder should provide accurate information on any litigation history or arbitration resulting from contracts completed or under execution by him over the last ten years. This should also include such cases, which are in process/progress. A consistent history of awards against the bidder or any partner of a joint venture may result in failure of the bid. In case the bidder has not provided such information and has come to the notice of the Authority, the tender will be rejected at whatsoever stage and in such case all the losses that will arise out of this issue will be recovered from the tenderer/contractor and he will not have any defense for the same.

**4.2** Even though the bidders meet the above criteria, they are subject to be rejected, if they have:

- Made misleading or false representation in the form, statements and attachments submitted, and / or
- Record of poor performance such as abandoning the work, not properly completing the contract, inordinate delays in completion, litigation history, or financial failures etc.

#### **5 Brand names**

Specific reference in the specifications any materials by manufacturer's name (as per Appendix 3 & 4), or catalogue shall be considered as establishing a standard or quality and performance and not as limiting competition, and the tenderer in such cases, will not at his option freely use any other product.

#### **6 Operation cost evaluation**

In comparing tenders, Bhavnagar Municipal Corporation shall consider such factors as the time of completion; efficiency and reliability of method proposed, compliance with the specifications, relative quality, the operation cost, maintenance cost and replacement cost of plant will also be taken into consideration in evaluation of tender.

Running cost of the plant proposed by the tenderer for a period of 15 years (fifteen) shall be taken into consideration in comparison between all tenderers. Corporation / Architect reserves the right to award contract to such a tenderer whose plant is more efficient in running cost after such comparison irrespective whether the bid price is higher than the other tenderers.

**7** Latest Copy of (issued on or after 01/04/2016) solvency certificate for amount not less than Rs. 20% of estimate of any Nationalized Bank or / IDBI / ICICI / HDFC / AXIS Bank or any Scheduled Bank.

## **FORM OF TENDER**

**To Sir,**

- 1.0** Having visited the site and examined the Tender Documents comprising of General Conditions of Contract, Special Conditions of Contract, Specifications, Tender Notice, Instructions to Tenderers, Form of Tender, Articles of Agreement, Additional Conditions, Notes on Bill of Quantities, Schedule Bills of Quantities and drawings, I/We the undersigned, offer to execute the works specified in the aforesaid documents and shall complete the same within the time limit specified therein, in conformity with the said tender documents and with such materials as are to be provided for.
- 2.0** Should this tender be accepted, I/We agree:
- (a)** That I/We shall abide by and fulfill all the terms and provisions of the conditions contained in the aforesaid documents which have been read by me/us and explained to me/us, so far as applicable or in default thereof to forfeit and pay to the Employer or their successors the sums of money mentioned in the said documents.
  - (b)** That I/We shall execute all the works referred to in the said documents upon the terms and conditions contained or referred to therein at the rates contained in the aforesaid documents or at such other rates as may be fixed under the provisions of these conditions and also to carry out such other works or items of works, as may be ordered on me/us, which are not contained in the aforesaid documents at the rates contained in the aforesaid documents or at such other rates as may be fixed under the provisions of these conditions.
  - (c)** That the amount which has been deposited by me/us as earnest money, the full value of which is to be absolutely forfeited to the Employer or their successors, should I/We fail to commence the works specified or should I/We not deposit the full amount of security deposit specified in the aforesaid documents, in accordance with the said Conditions of Contract, otherwise the said amount shall be retained by the Employer as on account of such security deposit as provided for in the aforesaid documents.
- 3.0** We undertake, if our tender is accepted, to commence the works within 15 days of receipt of the Owner's / Consultants order to commence, and to



complete and deliver the whole of the works comprised in the contract within the time limits specified in the tender notice/LOI calculated from the date of issue of work order to commence the work/letter or intent plus 15 days mobilization period or from the date of handing over of the site, whichever is later.

- 4.0** We agree to abide by 'this tender for the period of 180 days from the last date fixed for receiving the same and it shall remain binding upon us and may be accepted at any time before the expiration of that period.
- 5.0** Unless and until a formal agreement is prepared and executed, this tender, together with your written acceptance thereof, shall constitute a binding contract between us.
- 6.0** We understand that you are not bound to accept the lowest or any tender you may receive.
- 7.0** If our tender is accepted, I/We shall refer all disputes arising during execution of work to Jurisdiction-court, Bhavnagar only.

Date This \_\_\_\_\_ day of \_\_\_\_\_ 20\_\_\_\_\_

Witness: \_\_\_\_\_

\_\_\_\_\_ (Signature)

Signature & Stamp of the Tenderer

Name \_\_\_\_\_

Address \_\_\_\_\_

Occupation \_\_\_\_\_

The above tender is hereby accepted by me on behalf of the Owner on this Day \_\_\_\_\_ of \_\_\_\_\_ 20\_\_\_\_\_

Witness \_\_\_\_\_  
(Signature)

\_\_\_\_\_ For and on behalf of Owners

Name \_\_\_\_\_

Address \_\_\_\_\_

Occupation \_\_\_\_\_

# **ARTICLES OF AGREEMENT**

**( D R A F T )**

**(NOTE: These Articles of Agreement shall be signed by the successful Tenderer (contractor) and the Owners on a Non-Judicial Stamp Paper of Rs. 300.00 The Stamp Paper shall be bought by the Contractor).**

ARTICLES OF AGREEMENT made at\_\_\_\_on the\_\_\_\_\_day of\_\_\_\_BETWEEN\_\_\_\_  
\_\_\_\_\_(hereinafter referred to as the "Employer" or "Owner" which expression shall include his heirs, executors, administrators and assignees) of the one part and\_\_\_\_  
\_\_\_\_\_ (here in after referred to as the "Contractor" or the "Tenderer" which expression shall include his heirs, executors, administrators and assignees) of the other part.

WHEREAS the Employer is desirous of constructing/Executing the project and have caused drawings, Specifications and Bills of Quantities describing the work to be done, to be prepared by or under the guidance of the Architect, Bhavnagar (hereinafter referred to as the Architect/Consultants) and

WHEREAS the said Tender Documents (as detailed in para13 of Instructions to Tenderers) inclusive of the Specifications and the Priced Bills of Quantities have been signed by or on behalf of the parties hereto, and

WHEREAS the Contractor has agreed to execute upon and subject to the conditions set herein, the works shown upon the "said drawings" and described in the "said Specifications" and the "said Priced Bills of Quantities" (all together hereinafter referred to as "The Conditions").

AND WHEREAS the Contractor has submitted the Initial security deposit Rs. (Rupees) **5%** of the contract value (including EMD) in form of DD/B.G. both of Nationalize bank, any scheduled bank like HDFC, AXIS, ICICI & IDBI Bank except state bank of India only in favoring Municipal Commissioner, Bhavnagar Municipal Corporation.

## **NOW IT IS HEREBY AGREED AS FOLLOWS:**

- 1.** In consideration of the payment to be made to the contractor as hereinafter provided, he shall upon and subject to the said conditions execute and complete the works shown upon the said drawings and described by or referred to in the said Specifications, the Priced Bills of Quantities and such further detailed

drawings and/or instructions as may be furnished to him by the Architect/Consulting Engineer.

2. The Employer shall pay the Contractor such sums as shall become payable to him in terms of the Conditions at the time and in the manner specified in the Conditions.
3. The terms "Owner - Bhavnagar Municipal Corporation/ Employer - Municipal Commissioner, Bhavnagar Municipal Corporation" in the Conditions shall mean Executive Engineer building section Bhavnagar Municipal Corporation Architect shall mean, Architect, Bhavnagar or in the event of his death or ceasing to be the Architect/Consulting Engineer for the purpose of this Contract such other person as shall be nominated for the purpose by the Employer not being a person to whom the Contractor shall object for reasons considered to be sufficient by the Employer. Provided always that no person(s) subsequently appointed to be the Architect or Consulting Engineer under this Contract shall be entitled to disregard or overrule any decision or approval or direction given or expressed in writing by the (previous) Architect/Consulting Engineer for time being.
4. The Contract or the work is as referred to in para 13 of Instructions to Tenderers and all other subsidiary works connected herewith within the same site as may be ordered to be done from time to time by the Architect/Consulting Engineer for the time being although such works may not be shown on the said drawings or described in the said Specifications or the Priced Bills of Quantities.
5. The Employer through their Architects or Consulting Engineer reserve to themselves the right of altering the said drawings and nature of the work and of adding to or omitting any items or works or of having portions of the same carried out departmentally or otherwise and such alterations or variations shall be carried out without prejudice to this contract.
6. This Contract comprises of the following documents:

**VOLUME – 1:**

**PART – 1: B-2 Form**

**PART – 2: INTRODUCTION AND FORMS**

**PART – 3: PREQUALIFICATION SHEETS MoU PARTNER**

## **VOLUME – 2:**

### **(A) TECHNICAL SPECIFICATION**

#### **(a) CIVIL**

#### **(b) ELECTRICAL**

#### **(c) FILTER PLANT AND DATA SHEET**

**(c-1)** Appendix – 1. Technical Data. (Swimming Pool recirculating pump)

**(c-2)** Appendix – 2. Technical Data. (Swimming Pool Filter)

**(c-3)** Appendix – 3. List of Approved makes

**(c-4)** Appendix – 4. List of Approved makes for M.C.C.

**(c-5)** Appendix – 5. Running cost of filtration plant for 12 hours per day Competition Pool

#### **(d) O & M Specification**

### **(B) PRICE BID**

(B-1) Schedule of quantities for Equipment, Electrification work and accessories.

### **(C) DRAWINGS**

All the said documents shall be read and construed together as forming part of this contract, and the parties hereto will respectfully abide by and submit themselves to the conditions and stipulations and perform the contract on their parts respectively

- 7.** All disputes arising out of or in any way connected with this contract shall be deemed to have arisen in Bhavnagar and only the Court at Bhavnagar shall have jurisdiction to determine the same.
- 8.** The several parts of this Contract have been read and fully understood by me, the undersigned.

IN WITNESS WHEREOF the parties hereto have hereunder set their hands  
this \_\_day of \_\_\_\_\_ 20\_\_.

\_\_\_\_\_  
Signed by the said Employer

\_\_\_\_\_  
Signed by the said Contractor

\_\_\_\_\_  
In the presence of

\_\_\_\_\_  
In the presence of

Name\_\_\_\_\_

Name \_\_\_\_\_

Address\_\_\_\_\_

Address\_\_\_\_\_

Occupation\_\_\_\_\_

Occupation\_\_\_\_\_

\_\_\_\_\_

## **ADDITIONAL CONDITIONS**

- 1.0** The tenderers shall have to quote for all the items of all the Schedule/Bills of Quantities of the Tender Document. Incomplete tenders are liable to be rejected.
- 2.0** The tenderer shall quote balanced rates for all the items. The quantities given in the tender are merely for the guidance of the tenderer and may vary on either side unto any extent during actual execution. Some of the items may be added, deleted, omitted or altered during actual execution of work. No claim whatsoever shall be entertained on the account of variation in quantities. **Speculative tender is liable to be rejected.**
- 3.0** The Owners through their Architect/Consultant reserve the right to award the work to one or more tenderers; in part or in full. The Owners' decision regarding splitting the work amongst more than one tenderer or otherwise shall be binding, conclusive and final.
- 4.0** List of Approved Makes has been specified for various materials/items in the Tender Documents. Consultants at their discretion may make changes (add or delete) in such list during the execution of the contract.
- 5.0** The contractor shall maintain registers as mentioned below and other registers as instructed by the Consultant from time to time and these shall be made available to the Consultants for verification whenever required by the Consultants.
  - (a)** Joint measurements of work.
  - (b)** Ground levels, contours etc.
  - (c)** Day to day labor employment and labor register
  - (d)** Assets register
  - (e)** Daily work register
  - (f)** Welding roster
  - (g)** Site instruction book
  - (h)** Daily progress report
  - (i)** Any other documents required by Engineer in charge or client's representative

**6.0** Contractor shall employ at least one or more qualified Engineer having sufficient experience for civil work as well as landscaping work.

<b>Civil work</b>	<b>BE Civil with two-year experience</b>	<b>01</b>



## **SPECIAL NOTES**

The bidder **should note that the special clauses brought out in this Chapter of "Special Notes Sheet" will hold good and govern the contract.** In case if similar conditions / clauses elsewhere in tender document conflict with the clauses of this Chapter, the clauses mentioned in this Chapter will prevail and govern the contract.

1. Required quantity of materials and equipment for the contracted work will be procured by contractor from open market time to time- Bhavnagar Municipal Corporation shall not be responsible for any rise-fall of cost in any materials at any stage.
2. Electric power and water for the construction, erection, Installation, testing and commissioning purpose will be in the scope of contractor.
3. As such water required for any other purpose i.e. at Contractor's own colony including Labour Camp will have to be arranged by contractor himself. Electricity power also will be arranged by contractor himself.
4. Bhavnagar Municipal Corporation is not in position to spare any quarters for contractor's use or any piece of land for labour Camp. Contractor will make his own arrangement. Only minimum land for site office storage space and land required for batching plant will be spared at site.
5. **Rates quoted shall be inclusive of all current taxes/duties and levies and any variation in taxes or new taxes imposed will not be claimed/paid, during the contractual period namely excise and if applicable other taxes.**
6. The drawing attached with tender is for bid purpose only. The quoted rates should hold good for working as per "Construction Drawings" ("Equipments drawings") released / approved from time to time.
7. Rates quoted shall be inclusive of all current taxes / duties, sales tax, VAT and Cess, Royalty and levies and all other charges and rates to complete the work excluding GST. No separate charges will be paid on this account, if the rates of current taxes, sales tax, VAT etc undergo any revision during contractual completion date, the same shall be allowed as statutory variation. However, if any variation takes place after contractual date of completion, the same shall not be allowed even if delayed are accepted by bidder.

No statutory variation shall be admitted, if current taxes, sales tax / duties, cess, labourcess, VAT etc. become payable because of exceeding the prescribed limit for turnover of your firm after the date of offer.

**8. TEMPORARY OFFICE, WORKSHOPS, STORES ETC:**

The Contractor shall during the progress of the work provide, erect and maintain at his own expense all necessary temporary workshops, stores, offices etc., as are required for the proper and efficient execution of the work. The planning, setting and execution of the buildings shall be to the approval of the Owner / Architect / Consulting Engineer and these shall at all times be kept tidy and in a clean and sanitary condition to the entire satisfaction of the Owner/Architect/Consulting Engineer, at the Contractor's expense.

**9. TEMPORARY OFFICE FOR RESIDENT ENGINEER:**

The Contractor shall provide and maintain, free of cost, a small temporary office as specified by the Architect/Consultant on the site for the resident engineer. The office shall be furnished with one writing table, two chairs, and an electric fan. All fees and other charges legally payable to municipal and/or other authorities for the temporary office shall be paid by the Contractor as and when and in the manner required by prescribed rules and regulations of the authorities concerned.

This shall be from prior to commencement of the work till actual completion of the project and finalization of final bill of the contractor. If instructed to do so by the Owner/Architect/Consulting Engineer, the structure shall be demolished and debris removed from the site, during the course of construction or after the completion of works.

- 10.** Extension of time limit will be considered only in cases when any delay is not attributable to the Contractor.
- 11.** In overall interest of project and for better co-ordination, Engineer-in-Charge may ask the Contractor to stop the work for time being for which no compensation will be paid.
- 12.** Date of start shall be reckoned within 15 days from date of issue of Letter of intent.

- 13.** Extra items, as and when necessary, shall be executed only after asked to do so, and the rates for same shall be derived from similar item of the existing contract and if it is not possible to do so, the rate would be derived from prevailing market rates considering total 15% towards overheads, supervision, profit etc.
- (a)** If any extra items are required to be carried out for the said of the work, Bidder has to recognize the same well in advance so that during the execution of work. The whole work may not be affected.
- (b)** Any extra item will have to be executed only after the approval of Office of Bhavnagar Municipal Corporation.
- 14.** Main Roads planned for ultimate use during operation and maintenance of plant shall be construed as and when planned. Contractor can use the same. However, the contractor will arrange internal approaches to individual buildings.
- 15.** Security deposit will be refunded on demand within 3 months on completion of defect liability period of 03 Years.
- 16.** Ceiling for penalty for late completion of work shall be 0.10% of contract value per day. The maximum penalty amount shall not exceed 10% of total contract value.
- 17. Mobilization Advance will not be paid No advance against material brought to site will be paid.**
- 18.** Clarifications/queries if any by the bidder should be sent well in advance before due date as mentioned in Tender Notice at the following addresses in a Sealed Cover, super scribing the name of work and due date.

**Executive Engineer, Building Department**  
**Bhavnagar Municipal Corporation, Bhavnagar- 364 001**

In case a pre-bid meeting is called, the decisions taken and recorded during the pre-bid meeting, will be final and will form part of the contract document and shall be binding to the bidders. Thereafter, while submitting Technical Bid/Price Bid envelopes (on due date specified in tender notice) no deviations are expected and bidders in their Technical Bid part shall confirm to this effect that they have quoted the prices, based on the specifications without any deviations, either technical / commercial

## **DECLARATION - I**

From:

Letter No.

Date:

To,

Municipal Commissioner

Bhavnagar Municipal Corporation

Bhavnagar

SUB: PROPOSED DOG HOME SHELTER & ANIMAL VACCINATION CENTRE AT NARI ROAD, KUMBHARWADA, BHAVNAGAR, DIST. BHAVNAGAR

Dear Sir,

I/we have carefully gone through and clearly understood the Tender Notice and Tender Form and have tendered to execute and satisfactorily complete the whole of the work strictly in accordance with the said Tender Form.

I/we hereby solemnly declare that any of our partners severally and/or individually or our firm/company have not been put any time in the past on the black list either by the Government of India/Government of Gujarat/Government of India Undertaking / Government of Gujarat Undertaking/Any other State Government Undertaking. I/we hereby further agree that if the Bhavnagar Municipal Corporation comes to know subsequently, after awarding the work under this tender to me/us to our firm/our company that any of our partners either individually or severally, or our firm/company was black listed by any of the states agencies, Bhavnagar Municipal Corporation shall be entitled to take any actions against us severally or individually or our firm/company in this regard in any manner that may be deemed fit by the Bhavnagar Municipal Corporation.

Yours faithfully,

Signature & Stamp of the Contractor

## DECLARATION - II

From:

Letter No.

Date:

To,

Municipal Commissioner

Bhavnagar Municipal Corporation

Bhavnagar.

SUB: PROPOSED DOG HOME SHELTER & ANIMAL VACCINATION CENTRE AT NARI ROAD,  
KUMBHARWADA, BHAVNAGAR, DIST. BHAVNAGAR

Dear Sir,

I/we having carefully gone through and clearly understood the Introduction, Tender Notice, documents to be enclosed and sent along with this tender, plans, specifications, conditions of contract etc. for the above-mentioned work, do hereby tender to execute and complete the whole of the work strictly in accordance with the said plans and specifications and conditions of contract at the rates set out in the priced schedule and quantities attached hereto.

I/we agree to finish the whole of the work as per instructions within months (as per NIT) from expiry of 15 days from the date of issue of Letter of Intent or actual commencement of the work whichever is earlier.

We have deposited Earnest Money (As per NIT) It is understood by me/us that the lowest or any tender will not necessarily be accepted and that no reasons shall be given for such non-acceptance.

We agree to keep our offer open for 180 days or for a further period as would be desired by the Bhavnagar Municipal Corporation from the date of opening of the tender.

We agree to all the terms and conditions of the tender.

Yours faithfully,

Signature & stamp of contractor

## **MODE OF PAYMENT (OF RUNNING BILLS)**

Contractor shall submit interim bills and paid as mentioned below:

### **A Civil work:**

**(1)** As per progress of work done on site - minimum bill amount Rs. Fifteen lacs

### **B Plant Mechanical and Electrical work**

- 1)** 50% on supply of material at site
- 2)** 25% on installation of items
- 3)** 10% on completion of testing
- 4)** 15% on commissioning of plant in all respect.

Each running bill becomes payable after deducting following:

- A) Income Tax and T.D.S. on Works Contract Tax (VAT) as per Provisional Respective Act.
- B) Security Deposit & Retention Money.
- C) Cost of any service / material provided by the employer.
- D) Other deductions like labour welfare cess and any other, if any.

**Note:** Earnest Money Deposit (EMD), Security Deposit (SD), & Retention Money (RM) will not bear any interest.

The contractor shall have to fulfill and abide by the provision of Labour Laws, Contract Labour Regulations and Abolition Act, 1970 (Contract Act 37 of 1970) pertaining to the employment and labour.

## **NO DEMAND CERTIFICATE**

To,

Municipal Commissioner

Bhavnagar Municipal Corporation Bhavnagar.

Name Of Work:- PROPOSED DOG HOME SHELTER & ANIMAL VACCINATION CENTRE  
AT NARI ROAD, KUMBHARWADA, BHAVNAGAR, DIST. BHAVNAGAR

Tender No \_\_\_\_\_

Dear Sir:

We \_\_\_\_\_ hereby certify that we have received the payment of all our bills in full and final settlement of our claims in respect of Tender No. PROPOSED DOG HOME SHELTER & ANIMAL VACCINATION CENTRE AT NARI ROAD, KUMBHARWADA, BHAVNAGAR, DIST. BHAVNAGAR

The payment received by us is in full and final settlement of our all the claims towards the amount with respect to the work under reference.

Hence, we do not have any outstanding claim against Bhavnagar Municipal Corporation for the work under reference. We shall not claim any further amount from Bhavnagar Municipal Corporation in future, either one way or the other.

This certificate is given without any prejudice and in the presence of two witnesses.

Signature & Address of Witnesses (1) \_\_\_\_\_

Signature & Stamp of the Firm (2) \_\_\_\_\_

## **LEGAL PROVISION - APPENDIX - II**

### **CONTRACTORS TO ABIDE BY FOLLOWING LEGAL PROVISIONS**

#### **1 Labour Laws:**

- (a)** Person below the age of 18 years shall not be employed for the work
- (b)** No female worker shall be employed in the night shift between 7 p.m. to 6 a.m. Contractor shall maintain a valid **labour license** under the Contract Labour (Regulation and Abolition) Act for employing necessary manpower to be required by him. In the absence of such license shall be liable to be terminated without assigning any reasons thereof.
- (c)** The contractor shall at his own expenses comply with all labour laws and keep Bhavnagar Municipal Corporation indemnified in respect thereof. Some of the major liabilities under various labour and industrial laws which the contractor shall comply with are as under:
  - (1)** Payment of deposit in respect of each contract labour at prevalent rate with the Office of Commissioner of Labour as per the Contract Labour (Regulation and Abolition Act).
  - (2)** Payment of Compensation in case of accidental injury.

The above are some of the major liabilities of the contractor in addition to other liabilities prescribed underwrite the various labour laws in force from time to time from Statutory Authorities like State Government / Government of India which the contractor shall have to comply with.

#### **2 Maintenance of registers and records:**

The contractor shall employ adequate number of experienced staff at site for daily supervision and for maintenance of various registers and records required under the law and contract. No payment for supervision shall be admissible.

#### **3 Contractor to Indemnify Bhavnagar Municipal Corporation (BMC):**

The contractor shall indemnify Bhavnagar Municipal Corporation and every member officer and employees of Bhavnagar Municipal Corporation also.



Engineer-in-charge and his staff against all actions, proceedings, claims, demands, costs and expenses whatsoever arising out of or in connection with the matters referred in herein above elsewhere and against all actions, proceeding claims, demands, costs and expenses which may be made against Bhavnagar Municipal Corporation or Government for or in respect of or for performance of his obligation under the contract documents. Bhavnagar Municipal Corporation shall not be liable for or in respect of or in consequence of any accident or injury to any workman or other person in the employment of the contractor or his sub-contractor, and the contractor shall indemnify and keep indemnified Bhavnagar Municipal Corporation against all such damage and composition and against all claims, demands, proceedings costs, charges and expenses, whatsoever in respect thereof or in relation thereto.

**4 Workmen's Compensation and Employer's Liability Insurance:**

Insurance shall be affected for all the contractor's employees engaged in the performance of this contract. If any of the work is subject, the contractor shall require the sub-contractor to provide workmen's compensation and Employers Liability, Insurance of the letters employees unless such employees are covered under the Contractor's Insurance.

**5 Bhavnagar Municipal Corporation's Right to Terminate Contracts:**

Bhavnagar Municipal Corporation reserves the right to terminate this rate contract at any time during its pendency without giving notice of termination or any reasons thereof.

**6 Bhavnagar Municipal Corporation's Right to Deduct from Contractor's Bills:** Bhavnagar Municipal Corporation will be entitled to deduct directly from the bills to be paid to the contractor any sum or sums payable by the end which sum / sums BhavnagarMunicipal Corporation is required default in respect of all liabilities referred to in aboveclauses.

**7 Indebtedness and Liens:**

**(a)** The Contractor shall indemnify and save harmless the Purchaser and/or the Consulting Engineers from all Claims, demands, causes of actions or suits of whatever nature arising out of the services, labour and materials furnished by the Contractor or his sub- contractors, for the work, and from labourer materials, workmen and mechanics liens upon the property upon which the

work is located arising out of the services, labour and materials furnished by the Contractor or any off his subcontractors under the work, and shall keep said property free and clear of all liens claims and encumbrance arising from the performance of the work by the Contractor his sub-contractor.

- (b)** The Contractors shall have the right to contest the Validity or amount of any such lien, if the Contractor shall contest the validity or amount of any such lien, then upon the Final determination of such question, any judgment which may be rendered against the Contractor shall be promptly paid and he shall procure the release of such lien. Pending the discharge of any such lien of record and notice thereof to the Purchaser, the Purchaser may retain out of any moneys then due to the Contractor an amount sufficient to discharge such lien and to reimburse the Purchaser for any cost or expense incurred in any action or proceeding for the enforcement or removal thereof. The Contractor agrees to reimburse the Purchaser for all moneys paid and expenses incurred by the Purchaser in discharging such liens or in connection with any action or proceedings for the removal or reinforcement of same.
- (c)** Before receiving final payment for his work, the Contractor shall certify and furnish proof satisfactory to the Purchaser that all material and equipment embodied in the work and labour costs incurred therein have been fully paid and discharged.
- (d)** The Contractor shall include a provision satisfying the requirements of this clause as a part of any and all sub-contracts entered into for the work or any portion thereof.

## **8 Liability for Damages:**

- (a)** The Contractor shall, during the progress of the work, properly cover up and protect the plant from damage by exposure to the weather and shall take every reasonable, proper, timely and useful precaution against theft, accident or damage to the same from any cause and shall be and remain answerable and liable for theft and for all accidents or damage thereto which, may arise or be occasioned by the acts or omissions of the Contractor, of his workman or sub-contractors, and all losses and damages to the plant arising there from shall be made good in a complete and substantial manner by and at the sole cost of the Contractor and to the

reasonable satisfaction of the Purchaser.

- (b)** In the case of loss or damage to any portion of the plant delivered on the site arising from or occasioned by causes for which the Contractor is not responsible under these conditions the same shall, if required by the Purchaser, be made good by the Contractor in like manner, but the value thereof shall be paid by the Purchaser, such value to be agreed between the Contractor and the Purchaser, or in default of agreements as settled by arbitration. The value of the portion of the plant so lost or damaged or any balance of such contract value remaining unpaid, as the case may be shall be determined in the same way a change in scope of the contract pursuant to provision hereto.
- (c)** Provided that the Contractor shall not be liable under the contract for any loss of profit or loss of contract or any claims made against the Purchaser not already provided for in the contract, nor for any injury or damage caused by or arising from the acts of the purchaser or of other or due to circumstances over which the Contractor has no control nor shall his total liability for loss, damage, or injury exceed the total value of the Contract.

**9 Indemnity:**

- (a)** The Contractor shall indemnify and keep indemnified the Purchaser all actions, suits, claims and demands for injury or damage to any person or any property whatsoever which may arise out of or in consequence of the execution or maintenance of the work under the Contract and against all claims, demands, proceedings, damages, costs, charges and expenses whatsoever in respect of or in relation thereto. In case the Purchaser either alone or jointly with the contractor shall be called upon by a court of law to make good any such loss or damages, or to pay compensation, (including that payable under the provision of the workmen's compensation Act) to any person or persons sustaining damage, as aforesaid by reason of any act, or any negligence or omissions on the part of the Contractor, the amount which the purchaser may be required to pay in respect thereof and the amount of any costs or charges including legal costs and charges in connection with legal proceedings which may be incurred in reference thereto, shall be recovered by the Purchaser from the Contractor.
- (b)** The Purchaser shall not be liable for any damages or compensation payable

at law in respect of or in consequence of any accident or injury to workmen or other persons in the employment of the Contractor or any subcontractor, and the Contractor shall indemnify and save harmless the purchaser against all such damages and compensation and against claims, demands, proceedings, costs, charges and expenses whatsoever in respect thereof or in relation thereto. In Contract they shall, while so employed be considered for all purposes as the employees of the Contractor, and this notwithstanding that their salaries or wages may be paid by the Purchaser.

**10 Laws, Regulation and Permits:**

The supplier shall comply with all applicable laws, ordinances, codes, approved standards, rules and regulations, and shall procure all necessary municipal and governmental permits, licenses and inspection and shall pay all fees and charges in connection with the manufacture and sale or item and/or items covered by the contract and/or purchase order. The supplier shall save the purchaser and the consulting engineers harmless as a result of any in actions thereof.

The following are some of the major Government of India Acts and Regulations concerning approvals of new plants and machinery.

**(a)** The Indian Electricity Act.

**TAX LAWS - APPENDIX - III CONTRACTOR TO ABIDE BY FOLLOWING TAX LAWS:**

**(a) General Taxes:**

The Contractor shall be responsible for and shall pay out of his own, moneys, all taxes, dues, fees, cesses, octroi and charges payable to Central or State Governments or dues payable on material purchased by him or constructional plant **provided by him for the works**, and on all materials brought by him on the site and used for the works and shall indemnify the purchaser against any liability on account of any such taxes, dues, fees, cess, octroi and charges.

**(b) Income-Tax:**

The Contractor and his employees shall bear and pay all Income-Taxes, corporate and personnel, super tax or any other Indian tax as may be payable by him on the amounts payable to him under the contract. If for any reason whatsoever the purchaser is called upon to pay in respect of the Contractor's or his employees income, any income-tax, any tax under Income-tax Act or any tax under any other law in force in India, then the Contractor shall be bound and liable to reimburse and pay to the Purchaser the amount of such tax so paid by the purchaser and the Contractor further agrees that the Purchaser will also be entitled to recover and reimburse to himself the amount of such tax out of the fees, remuneration or any other sum payable by him to the Contractor under the Contract.

**(c) Taxes in respect of Workmen:**

The Contractor shall provide and maintain workmen's compensation insurance coverage to provide compensation benefits in the event of injury of employees in the course of work under the contract.

**(i) Liability under the Workmen's Compensation Act:**

The Contractor shall at all times identify the Purchaser against any claims which may be made under the Workmen's Compensation Act, 1923 or any statutory modification thereof or otherwise for or in respect of any damages or compensation payable in consequence of any accident or injury sustained by any workman or other person whether in the employment of the Contractor or not.

**(ii) Liability under the employee's State Insurance Act 1948:**

Where the Contract is in connection with the Purchaser's work office coming under the purview of the Employee's State Insurance Act, 1948, the Contractor shall make necessary deduction from the monthly emoluments of his staff employed on the Contract at the prescribed rate and remit the aggregate amount monthly to the Purchaser together with the Employer's (Contractor's) contribution as required under the Act and together with the standard form duly filled in as required under the Act.

**(iii) Liability under the Employees Provident Fund Act, 1951:**

Where the contract is in connection with the purchaser's works office coming under purview of the employees provident Fund Act, 1951, the Contractor shall make necessary deduction from the monthly emoluments of his staff employed on the Contract at the prescribed rate and remit the aggregate amount monthly to the purchaser together with the Employer's (Contractor's) Contribution as required under the Act, and together with the standard forms duly filled in required under the Act.

# **BHAVNAGAR MUNICIPAL CORPORATION**



## **Bid Documents For**

**PROPOSED DOG HOME SHELTER & ANIMAL VACCINATION CENTRE  
AT NARI ROAD, KUMBHARWADA, BHAVNAGAR, DIST. BHAVNAGAR**

## **CIVIL TECHNICAL SPECIFICATIONS**

**ARCHITECTS:  
MANISH RUPARELIA PVT. LTD.  
901-902, Time Square,  
Ayodhya Circle, 150 Feet Ring Road,  
Rajkot 360 006**

**EXECUTIVE ENGINEER  
Building Department  
Bhavnagar Municipal Corporation  
Mangalsinhji Road,  
Bhavnagar – 364 001**

## **TECHNICAL SPECIFICATIONS**

### **GENERAL**

In the specifications, "as directed" / "Approved" shall be taken to mean 'as directed' / 'approved' by the Engineer-in-Charge.

Wherever a reference to any Indian Standard appears in the specifications, it shall be taken to mean as a reference to the latest edition of the same in force on the date of agreement.

Approval to the samples of various materials given by the Engineer-in-charge shall not absolve the contractor from the, responsibility of replacing defective material brought on site of materials used in the work found defective at a later date. The contractor shall have no claim to any payment of compensation whatsoever on account of any such materials being rejected by the Engineer-in-charge.

The contract rate of the item of work shall be for the work completed in all respects.

No collection of materials shall be made before it is got approved form the Engineer-in-charge.

Collection of approved materials shall be done at site of work in a systematic manner. Materials shall be stored in such a manner as to prevent damage, deterioration or intrusion of foreign matter and to ensure the preservation of their quality and fitness for the work.

Materials, if and when rejected by the Engineer-in-charge, shall be immediately removed from the site of work.

No materials shall be stored before, during and after execution of structures in such a way as to cause or lead to damage of overloading of the various components of the structure.

All tools, templates, machinery and equipment for correct execution of the work as well as for checking lines, levels, alignment of the works during execution shall be kept in sufficient numbers and in good working condition on the site of the work.

The mode, procedure and manner of execution shall be such that it does not cause damage or over loading of the various components of the structure during execution of after completion of the structure.

Special modes of construction not adopted in general Engineering practice, if proposed to be adopted by the Contractor shall be considered only if the contractor provides satisfactory evidence that such special mode of construction is safe, sound and helps in speedy construction and completion of work to the required strength and quality.

Acceptance of the same by the Engineer-in-charge shall not, however, absolve the



contractor of the responsibility of any adverse effects and consequences of adopting the same in the course of execution of completion of the work.

All installations pertaining to water supply and fixtures thereof as well as drainage lines and sanitary fittings shall be deemed to be completed only after giving satisfactory tests by the Contractor.

The contractor shall be responsible for observing the rules and regulation imposed under "Minor Minerals Act", and such other laws and rules prescribed by Government from time to time.

All necessary safety measures and precaution (including those laid down in the various relevant India Standards) shall be taken to ensure the safety of men, materials and machinery on the works as also of the work itself.

The testing charges of all materials shall be borne by the Contractor.

Approval to any of the executed items for the work does not in any way relieve the contractor of his responsibility for the correctness, soundness and strength of the structure as per the drawings and specification.

## **MATERIALS**

### **M-1. WATER**

Water shall not be salty or brackish and shall be clean, reasonably clear and free from objectionable quantities of silt and trace of oil and injurious alkalis, salts, organic matter and other deleterious material which will either weaken the mortar or concrete or cause efflorescence or attack the steel in RCC Container for transport, storage and handling of water shall be clean, water shall conform to the standards specified in I.S. 456-2000.

If required by Engineer-in-charge, it shall be tested by comparison with distilled water. Comparison shall be made by means of standard cement tests for soundness, time of setting and mortar strength as specified in I.S. 269-1979. Any indication of unsoundness, change in time of setting by 30 minutes or more or decrease of more than 10 per cent in strength of mortar prepared with water sample when compared with the results obtained with mortar prepared with distilled water shall be sufficient cause for rejection of water under test.

Water for curing mortar, concrete of masonry should not be too alkaline. It shall be free of elements that significantly affect the hydration reaction or otherwise interfere with the hardening of concrete during curing of those which produce objectionable stains or other unsightly deposits on concrete or mortar surfaces.

Hard and bitter water shall not be used for curing.

Potable water will be generally found suitable for curing mortar or concrete.

### **M-2. LIME**

Lime shall be hydraulic lime as per I.S. 712-1973. Necessary test shall be carried out as per I.S. 6932 (Part 1 to X), 1973.

The following field tests for lime are to be carried out:

- (A) A very rough idea can be formed about the type of lime by its visual examination i.e. if lime bears pure white color lime in form of porous lumps or dirty white color indicates quick lime, and solid lumps are the un-burnt lime stone.
- (B) Acid tests for determining the carbonate content in lime, excessive amount of impurities and rough determination of class of lime.

Storage shall comply with I.S.: 721-1973. The slaked lime, if stored, shall be kept in a weather proof and damp-proof shed with impervious floor and sides to protect it against rain, moisture, weather and extraneous materials mixing with it. All time that has been damaged in any way shall be rejected materials shall be removed from site of work.

Field-testing shall be done according to I.S.: 1624-1974 to show the acceptability of materials.

### **M-3. CEMENT**

Cement shall be 53 Grade Ordinary Portland cement as per I.S.: 12269-1976 and 43 Grade Ordinary Portland Cement as per I.S.: 8112-1976.

### **M-4. WHITE CEMENT**

The white cement shall conform to I.S. 80412-E 1978.

### **M-5. COLORED CEMENT**

Colored cement shall be with white of gray Portland cement as specified in the item of the work.

The pigments used for colored cement shall be of approved quality and shall not exceed 10 % of cement used in the Mix. The mixture of pigment shall be properly grounded to have a uniform color and shade. The pigments shall have such properties to provide for durability under exposure to sunlight and weather.

The pigment shall have the property such that it is neither affected by the cement nor detrimental to it.

### **M-6. SAND**

Sand shall be natural sand, clean, well graded, hard strong durable and gritty particle free from injurious amounts of dust clay, kankar nodules, soft of flaky particles, shale, alkali, salts organic matter, loam, mica of other deleterious substances and shall be got approved from the Engineer- in- charge. The sand shall not contain more than 8 percent of silt as determined by field test. If necessary, the sand shall be washed to make it clean.

### **M-7. COARSE SAND**

The fineness modules of coarse sand shall not be less than 2.5 and shall not exceed

3.0. The sieve analysis of coarse sand shall be as under:

I.S. Sieve Designation	Percentage by weight passing Sieve	I.S. Sieve Designation	Percentage by weight passing sieve
4.75 mm	100	600 microns	30-100
2.36 mm	90-100	300 microns	5-70
1.18 mm	70-100	150 microns	0-50

The crushing strength of grit will be such as to allow the concrete in which it is used to build up the specified strength of concrete.

The necessary test for grit shall be carried out as per the requirement of I.S. 2386 (Parts I to VII) 1963 as per instructions of the Engineer-in-charge. The necessity of test

#### **FINE SAND**

The fineness modulus shall not exceed 1.0. The sieve analysis of fine sand shall be as under:

I.S. Sieve Designation	Percentage by weight passing Sieve	I.S. Sieve Designation	Percentage by weight passing sieve
4.75 mm	100	600 microns	40-85
2.36 mm	100	300 microns	5-50
1.18 mm	70-100	150 microns	0-10

#### **M-8. STONE GRIT**

Grit shall consist of crushed, or broken stone and be hard strong, dense, durable, clean, of proper gradation and free from skin of coating likely to prevent adhesion of mortar. Grit shall generally be cubical in shape and as far as possible flaky elongated pieces shall be avoided. It shall generally comply with the provisions of I.S. 383-1970. Unless special stone of particular quarries is mentioned, grit shall be obtained from the best black trap or equivalent hard stone as approved by the Engineer-in-charge. The grit shall have no deleterious reaction with cement.

The grit shall conform to the following gradation as per sieve analysis.

I.S. Sieve Designation	Percentage by weight passing Sieve	I.S. Sieve Designation	Percentage by weight Passing sieve
12.50 mm	100	4.75 micron	0-20
10.00 mm	85-100	2.36 micron	0-25

Crushing strength of grit will be such as to allow the concrete in which it is used to built up the specified strength of concrete.

The necessary tests for girt shall carried out as per the requirements of IS. 2386 (Part I to VII) 1963, as per instructions of the Engineer-in-charge. The necessity of test will be decided by the engineer-in-charge.

### **M-9. CINDER**

Cinder is well burnt furnace residue, which has been fused of sintered into lumps of varying sizes.

Cinder aggregates shall be well burnt furnace residue obtained from furnace using call fuel only. It shall be sound clean free form clay, dirt, ash of other deleterious matter.

The average grading for cinder aggregates shall be mentioned below.

I.S. Sieve Designation	Percentage by weight passing Sieve	I.S. Sieve Designation	Percentage by weight passing sieve
20.00 mm	100	4.75 micron	70
10.00 mm	86	2.36 micron	52

### **M-10. LIME MORTAR**

Lime shall conform to specification S-2. Water shall conform to specifications S-1. Sand: Sand shall conform to specifications S-6.

Proportion of Mix: Mortar shall consist of such proportion of slaked lime and sand as may be specified in the item. The asked lime and sand be measured by volume.

Proportion of Mortar: Lime mortar shall be prepared by wet process as per I.S. 1625-1971 power driven the 180 revolutions with sufficient water. Water shall be added as required during grinding (care being taken not to add more water) that will bring the mixed material to a consistency of stiff paste. Thoroughly wetted sand shall then be

added evenly and the mixture ground for another 180 revolutions.

Storage: Mortar shall always be kept damp, protected from sun and rain till used up, covering it by tarpaulin or open sheds.

Use: All mortar shall be used as soon as possible after grinding. It should be used on the day on which it is prepared. In no case mortar made earlier than 36 hours shall be permitted for use.

#### **M-11. CEMENT MORTAR**

Water: Water shall conform to specification S-1. Cement: Cement shall conform to specification S-3. Sand: Sand shall conform to S-6.

Proportion of Mix: Cement and sand shall be mixed to specified proportion; sand being measured by measuring boxes. The proportion of cement will be by volume on the basis of 50 kg/Bag of cement being equal to 0.0342 m<sup>3</sup>. The mortar may be hand mixed or machine mixed as directed.

Preparation of Mortar: In hand mixed mortar cement and sand in the specified proportions shall be thoroughly mixed dry on a clean impervious platform by turning over at least 3 times or more till a homogenous mixture of uniform color is obtained. Mixing platform shall be so arranged that no deleterious extraneous material shall get mixed with mortar or mortar shall flow out. While mixing, the water shall be gradually added and thoroughly mixed to form a stiff plastic mass of uniform color so that each particle of sand shall be completely covered with a film of wet cement ratio shall be adopted as directed.

The mortar so prepared shall be used within 30 minutes of adding water. Only such quantity of mortar shall be prepared as can be used within 30 minutes.

#### **M-12. STONE COARSE AGGREGATE FOR NOMINAL MIX CONCRETE**

Coarse aggregate shall be machine-crushed stone of black trap or equivalent and be hard, strong, dense, durable, clean and free from skin and coating likely to prevent proper adhesion of mortar.

The aggregate shall generally be cubical in shape. Unless special stones of particular quarries are mentioned aggregates shall be machine crushed from the best black trap or equivalent hard stone as approved. Aggregate shall have no deleterious reaction with cement. The size of the coarse aggregate for plain cement concrete and ordinary reinforced cement concrete shall generally be as per the table given below. However,

in case of reinforced cement concrete the maximum limit may be restricted to 6 mm less than the minimum lateral clear distance between bars of 6 mm less than the cover, whichever is smaller.

I.S. sieve	Percentage passing for single sized aggregates of nominal size			I.S. sieve Designation sized	Percentage passing for single sized aggregates of nominal size		
80 mm	---	---	---	12.5 mm	---	---	---
63 mm	100	---	---	10 mm	0.5	0.02	0.30
40 mm	85-100	100	---	4.75 mm	---	0.5	0.5
20 mm	0-20	85-100	100 mm	2.35	---	---	---
16 mm	---	---	85-100				

**Note:**

This percentage may be varied somewhat but Engineer-in-charge when considered necessary for obtaining better density and strength of concrete.

The grading test shall be taken in the beginning and at the change of source of materials. The necessary test indicated in 1.5.: 383-1970 and I.S. 456-2000 shall have to be carried out to ensure the acceptability. The aggregates shall be stored separately and handled in such a manner as to prevent the intermixing of different aggregates. If the aggregates are covered with dust, they shall be washed with water to make them clean.

The necessary tests indicate in I.S. 383-1970 and I.S. 456-2000 shall have to be carried out to ensure the acceptability of the material.

If aggregate is covered with dust, it shall be washed with water to make it clean.

**M-13. BLACK TRAP FOR EQUIVALENT HARD STONE COURSE**

Aggregate for Design Mix Concrete: Coarse aggregate shall be of machine crushed stone of black trap or equivalent hard stone and be hard strong dense, durable clean and free from skin and coating likely to prevent proper adhesion of mortar.

The aggregate shall generally be cubical in shape. Unless special stones of particular quarries are mentioned, aggregates shall be machine crushed from the

Best, black trap or equivalent hard stone as approved. Aggregate shall have no

deleterious reaction with cement.

The necessary tests indicated in I.S. 383-1970 and I.S. 456-1978 shall have to be carried out to ensure the acceptability of the material.

If aggregate is covered with dust, it shall be washed with water to make it clean.

#### **M-14. BRICK BATS AGGREGATE**

Brickbat aggregate shall be broken from well burnt or slightly over burnt and dense brick. It shall be homogeneous in texture roughly cubical in shape, clean and free from dirt of any other foreign material. The brickbats shall be of 40 mm to 50 mm size unless otherwise specified in the item. The under-burnt or over-burnt brick bats shall not be allowed.

The brickbats shall be measured by volume by suitable boxes or as directed.

#### **M-15. BRICKS**

Bricks shall be locally available first-class bricks. Bricks shall be of size of (9" x 4 3/8" x 2 3/4") 225 x 110 x 75 mm unless otherwise specified. In all masonry works bricks of class designation 35 are to be used.

Only bricks of one standard size shall be used on one work. The following tolerances shall be permitted in the conventional size adopted in a particular work.

Length	1/8" (3.0 mm)
Width	1/16" (1.50 mm)
Height	1/16" (1.50 mm)

The crushing strength of the bricks shall not be less than 35 kg/cm<sup>2</sup>. The average water absorption shall not be more than 20 percent by weight. Necessary tests for crushing strength and water absorption etc. shall be carried out as per I.S. 3495 (Part I to IV) 1976.

#### **M-16. STEEL TMT Fe500**

TMT bars reinforcement for RCC work shall conform to I.S. 432 (part-II) 1966 and shall be of tested quality. It shall also comply with relevant part of I.S. 456-2000.

All the reinforcement shall be clean and free from dirt, paint, and grease, mill scale or loose or thick rust at the time of placing.



### **M-17. HIGH TENSILE STEEL WIRE**

The high tensile wires for the use in pre-stressed concrete work shall conform to I.S. 2090-1962. The tensile strength, of the high tensile steel bars shall be as specified in the item. In absence of the given strength, the minimum strength shall be taken as per Para 6.1 of I.S. 1985-1962.

Testing shall be done as per I.S. requirements.

The high tensile steel shall be free from loose mill scale, rust oil, grease, or any other harmful matter. Cleaning of steel bars may be carried out by immersion in solvent solution, wire brushing or passing through a pressure box containing carborundum.

The high tensile wire shall be obtained from manufactures in coil having diameter not less than 350 times the diameter of wire itself so that wire springs back straight on being uncoiled.

### **M-18. MILD STEEL BINDING WIRE**

The mild steel wire shall be of 1.63 mm or 1.22 mm (16 or 18 gauges) diameter and shall conform to I.S. 280-1972.

The use of black wire will be permitted for binding reinforcement bars. It shall be free from rust, oil paint, grease, loose mill scale or any other undesirable coating that may prevent adhesion of cement mortar.

### **M-19. STRUCTURAL STEEL**

All structural steel shall conform to I.S. 2062-1965. The steel shall be free from the defects mentioned in I.S. 226-1975 and shall have a smooth finish. The material shall be Rivet bars shall conform to I.S. 1148-1973.

When the Contractor supplies the steel, test certificates of the manufactures shall be obtained according to I.S. 226-1975 and other relevant Indian Standards.

### **M-20. SHUTTERING**

The shuttering shall be either of wooden planking of 30 mm minimum thickness with or without steel lining or of steel plates stiffened by steel angles. The shuttering shall be supported on battens and beams and props of vertical bellies properly cross-braced together so as to make the centering rigid. In place of bellie props, brick pillar of adequate section built in mud mortar may be used.

The form work shall be sufficiently strong and shall have camber, so that it assumes correct shape after deposition of the concrete and shall be able to resist force caused by vibration of live load of men working over it and other incidental loads associated with it. The shuttering shall have smooth and even surface and its joints shall not permit leakage of cement grout.

If at any stage of work during or after placing concrete in the structure, the form work sags or bulges out beyond the required shape of the structure, the concrete shall be removed and work redone with fresh concrete and adequately rigid formwork. The complete formwork shall be got inspected by and got approved from the Engineer-in-charge, before the reinforcement bars are placed in position.

The props shall consist of bulgies having 100 mm minimum diameter measures at maximum length and 80 mm at thin end and shall be placed as per design requirement. These shall rest squarely on wooden sole plates 40 mm thick and minimum bearing area if 0-10 m<sup>2</sup> lay on sufficiently hard base.

Double wedges shall further be provided between the sole plate and the wooden props so as to facilitate tightening and easing of shuttering without jerking the concrete.

The timber used in shuttering shall not be so dry as to absorb water from concrete and swell or bulge nor as green or wet as to shrink after creation. The timber shall be properly sawn and planed on the sides and surface coming in contact with concrete / wooden formwork with metal sheet lining of steel plates stiffened by steel angles shall be permitted.

As far as practicable, clamps shall be used to hold the forms together and use of nails and spikes avoided.

The surface of timber shuttering that would come in contact with concrete shall be well wetted and coated with soap solution before the concreting is done. Alternatively coat of raw linseed oil of approved manufacturer may be applied in place of soap

Solution. In case of steel shuttering either soap solutions or raw linseed oil shall be applied after thoroughly cleaning the surface. Under no circumstances black or burnt oil shall be permitted.

The shuttering for beams and slabs shall have camber of 4 mm per meter (1 in 250) or as directed by the Engineer-in-charge so as to offset the subsequent deflection. For cantilevers, the camber at free end shall be 1/750 of the projected length or as directed by the Engineer-in-charge.

## **M-21. GLASS**

All glass shall be of the best quality, free from specks, bubbles, smokes, veins, air holes blisters and other defects. The kind of glass to be used shall be mentioned in the item of specification or in special provisions or as shown in detailed drawings. Thickness of glass panels shall be uniform to the specifications of different kinds of glass shall be as under:

- (A) In absence of any specified thickness or weight in the item of detailed specifications of the item of work, sheet glass shall be weighing 7.5 kg/m<sup>2</sup> for panes up to 600 mm x 600 mm.
- (B) For panes larger than 600 mm x 600 mm and up to 800 mm x 800 mm the glass weighing not less than 8.75 kg/m<sup>2</sup> shall be used. For biggest panes up to 900 mm x 900 mm glass weighing not less than 11.25 kg/m<sup>2</sup> shall be used.
- (C) Sheet glass shall be patent flattened glass of best quality and for glazing and framing purpose shall conform to I.S. 1761-1960. Sheet glass of the specified colors shall be used, if so shown on detailed drawings or so specified. For important buildings and for panes with any dimension over 900 mm plate glass of specified thickness shall be used.

Glass shall be fluted or frosted glass as may be specified as required. The thickness and type of glass shall be as per details on drawings or as specified or as directed.

## **M-22. FIXTURES AND FASTENINGS GENERAL**

- A. The fixtures and fastenings, that is, butt hinges, tee and strap hinges, sliding door bolts, tower bolts, door latch, bath room latch, handles, door stoppers, casement window fasteners, casement stays and ventilators catch shall be made of the metal as specified in the item of its specifications.
- B. They shall be of iron, brass, aluminum, chromium-plated iron, chromium-plated brass, copper oxidized iron, and copper oxidized brass or anodized aluminum as specified.
- C. The fixtures shall be heavy, medium or light type. The fixtures and fastenings shall be smooth finished and shall be such as will ensure ease of operation.
- D. The samples of fixtures and fastenings shall be got approved as regards quality and shape before providing them in position.
- E. Brass and anodized aluminum fixtures and fastenings shall be bright finished.

### **M-23. HOLDFASTS**

Holdfasts shall be made from mild steel flat 30 cm length and one of the holdfasts shall be bent at right angle and two nos. of 6 mm diameter holes shall be made in it for fixing it to the frame with screws. At the other end, the holdfast shall be forked and bent at right angles in opposite directions.

### **M-24. BUTT HINGES**

Railway standard heavy type butt hinges shall be used when so specified Tee and strap hinges shall be manufactured from MS Sheet.

### **M-25. SLIDING DOOR BOLTS (ALDROPS)**

The aldrops as specified in the item shall be used and shall be got approved.

### **M-26. DOOR LATCH**

The size of door latch shall be taken as the length of latch.

### **M-27. BATHROOM LATCH**

Bathroom latch shall be similar to tower bolt.

### **M-28. HANDLE**

The size of the handles shall be determined by the inside grip of the handles. Handles shall have a base plate of length 50 mm more than the size of the handle.

### **M-29. DOOR STOPPERS**

Door catch shall be fixed at a height of about 900 mm from the floor level so that one part of the catch is fitted on the inside of the shutter and the other part is fixed in the wall with necessary wooden plug arrangements for appropriate fixing. The catch shall be fixed 20 mm inside his face of the door for easy operation of catch.

### **M-30. CASEMENT WINDOW FASTENER**

Casement window fastener for single leaf window shutter shall be left or right handled as directed.

### **M-31. CASEMENT STAYS (STRAIGHT PEG STAY)**

The stays shall be made from a channel section having three holes at appropriate position so that the window can be opened either fully or partially as directed. Size of

the sty shall be 250 mm to 300 mm as directed.

### **M-32. OIL PAINTS**

- A. Oil paints shall be of the specified color and shade, and as approved. The ready mixed paints shall only be used. However, if ready mixed paint or specific shade or tint is not available, white ready mixed paint with approved strainer will be allowed, in such a case, the contractor shall ensure that the shade of the paint so allowed shall be uniform.
- B. All the paints shall meet with following general requirements:
- I. Paint shall not show excessive setting in a freshly opened full can and shall easily be re-dispersed with a paddle to a smooth homogeneous state. The paint shall show no curdling, levering, caking or color separation and shall be free from lumps and skins.
  - II. The paints as received shall brush easily, possess good leveling properties and show no running or sagging tendencies.
  - III. The paint shall not skin within 48 hours in three quarters filled closed container.
  - IV. The paint shall dry to a smooth uniform finish free from roughness, grit, unevenness and other imperfections.
- C. Ready mixed paint shall be used exactly as received from the manufacturers and generally according to their instructions and without any admixtures whatsoever.

### **M-33. ENAMEL PAINTS**

The French-polish of required tint and shape shall be prepared with the below mentioned ingredients and other necessary materials.

(a) Denatured spirit of approved quality, (b) Chandra's, (c) Shellac, (d) Pigment the French polish so prepared shall conform to I.S.: 348 - 1968.

**Item No. 13 : Excavation for foundation up to 1.5 Meter depth including sorting out and stacking of useful materials and disposing of excavated stuff up to any lead. (a) For Loose or Soft soil**

**Item No. 14 : Excavation for foundation up to 1.5 m depth including sorting**

**out and stacking of useful materials and disposing off the excavated stuff up to any lead. (B) Dense or Hard soil**

**Item No. 15 :** Excavation for foundation up to 1.5 m depth including sorting out and stacking of useful materials and disposing off the excavated stuff up to any lead. (C) Hard Murrum

**Item No. 16 :** Excavation for foundation for depth from 1.5 m to 3.0 m including sorting out and stacking of useful materials and disposing off the excavated stuff up to any lead. (C) Hard Murrum

**1.0. General:**

- 1.1. Any soil which generally yields to the application of pickaxes and shovels, spades, rakes or any such ordinary excavating implement or organic soil, gravel silt, sand turf loam, clay, peat etc., fall under this category.
- 1.2. **Dense or Hard Soil:** Any soil which generally require close application of picks or jumpers or scarifiers to loosen it stiff clay, gravel and rubble stone etc. fall under this category.
- 1.3. **Hard Murrum:** The hard Murrum shall be clean of good binding quality and of approved quality obtained from approved quarries, of disintegrated rocks which contain siliceous material and nature mixture of clay of calcareous origin. The size of hard Murrum shall not be more than 20 mm.

Workmanship: The relevant specification of item No. 16 shall be followed except that the excavation work shall be carried out with 1.5 M. to 3.0 M. lift in hard Murrum.

**2.0. Clearing the site:**

- 2.1. The site on which the structure is to be built shall be cleared and all obstructions, loose stone, materials and rubbish of all kind, bush, wood and trees shall be removed as directed. The materials so obtained shall be property of the Government and be conveyed and stacked as directed within 50 M. lead. The roots of the trees coming in the sides shall be cut and coated with hot asphalt.
- 2.2. The rate of site clearance is deemed to be included in the rate of earth work for which no extra will be paid.

**3.0. Setting Out:** After clearing the site, the center lines will be given by the Engineer-in-charge. The contractor shall assume full responsibility for alignment, elevation and dimension of each and all parts of the work. Contractor shall supply laborers, materials, etc. required for setting out the reference marks and bench marks and shall maintain them as long as required for setting out reference marks and bench marks and shall maintain them as long as required and directed.

**4.0. Excavation:** The excavation in foundation shall be carried out in true line and level and shall have the width and depth as shown in the drawings or as directed. The contractor shall do the necessary shoring and shutting or providing necessary slopes to a safe angle, at his own-cost. The payment for such precautionary measures shall be paid separately if not specified. The bottom of the excavated area shall be 1 evened both longitudinally and transversely as directed by removing and watering as required. No earth filling will be allowed for bringing it to level, if mistake or any other reason excavation is made deeper or wider than shown on the plan or directed. The extra depth or width shall be made up with concrete of same proportion as specified for the foundation concrete at the cost of the contractor. The excavation up to 1.5 m. depth shall be measured under this item.

**5.0. Disposal of the excavated stud:**

- 5.1. The excavated stuff of the selected type shall be used in filling the trenches and plinth or leveling the ground in layer including ramming and watering etc.
- 5.2. The balance of the excavated quantity shall be removed by the contractor from the site of work to a place as directed with lead up to 50 M. and all lift.

**6.0. Mode of measurement and payment:**

- 6.1. The measurement of excavation in trenches for foundation shall be made according to the sections of trenches shown on the drawing or as per sections given by the Engineer-in-charge. No payment shall be made for surplus excavation made in excess of above requirements or due to slopping and sloping back as found necessary on account of conditions of soil, and requirements of safety.
- 6.2. The rate shall be for a unit of one cubic meter.

**Item No. 17 : Filling in foundation and plinth with Murrum or selected soil in layers of 20cm. thickness including watering, ramming and**

**consolidating etc. complete. (up to 10 ton)**

**Item No. 18 : Filling in foundation and plinth with black garden soil in any thickness completed.**

**1.0. Materials:**

1.1. Murrum shall be clean, of good binding quality, and of approved quality obtained from approved pots/quarries of disintegrated rocks which contain silicones materials and natural mixture of clay of calcareous origin. The size of Murrum shall not be more than 20 mm.

**2.0. Workmanship:**

2.1. The relevant specifications of item No. 4.12 shall be followed except that the Murrum or selected soil shall be filled in foundation and plinth in 20 cms. layers including consolidating, ramming, watering, dressing etc. complete.

**3.0. Mode of measurement and payment:**

3.1. The relevant specifications of item No. 4.12 shall be followed.

3.2. The rate includes cost of collecting and carting Murrum/or selected earth of approved quality with all lead and labour required for filling in trenches and plinth.

3.3. The rate shall be for a unit of one cubic meter.

**DISMANTLING: ITEM 0 TO 0**

**1.0 Dismantling steel work including dismembering and stacking the materials with air leads and lifts. (item 0)**

**1.1. MATERIALS**

The relevant specifications of item No. 1.1 shall be followed except that the dismantling of steel work shall be carried out.

**1.2 MODE OF MEASUREMENTS AND PAYMENT**

The weight of the member shall be computed from standard table unless the actual weight can be readily determined.

Riveted works where rivets are required to be cut.



The same shall be carried out under this item and nothing extra shall be paid.

In framed still gate, the weight of any covering material or filling such as iron sheets and expanded metal shall be added to the weight of the main articles if such covering is not ordered to be taken out separately.

The rate includes stacking the materials as and were directed with all leads and lifts. The rate shall be for a unit of one Kg.

**2.0 Demolition of brick work & stone masonry including stacking of serviceable materials and disposal of unserviceable materials with all lead and lift. (II) In cement mortar.**

**2.1 WORKMANSHIP**

The demolition shall consist of demolition of one or more parts of the building as specified or shown by the engineer in charge. Demolition implies taking up or down or breaking up. This shall consist of demolishing whole or part of work including all relevant items as specified or shown by the engineer in charge.

The demolition shall always be planned beforehand shall be done in reverse order to the one in which the structure was constructed. This scheme shall be got approved from the Engineer-in-charge before starting the work. This however will not absolve the contractor from the responsibility of proper and safe demolition.

Necessary propping, shoring and under pinning shall be provided for the safety of the adjoining work or property, which is to be left intact, before dismantling and demolishing is taken up and the work shall be carried out in such a way that no damage is caused to the adjoining property.

Wherever required, temporary enclosures or partitions shall also be provided. Necessary precautions shall be taken to keep the dust nuisance down as and where necessary.

Dismantling shall be commenced in a systematic manner. All materials which are likely to be damaged by dropping from a height or demolishing roof plaster, masonry plaster etc. shall be carefully dismantled first. The dismantled articles shall be properly stacked as directed.

All materials obtained from demolition shall be the property of Government unless otherwise specified and shall be kept in safe custody until handed over to

the Engineer-in-charge.

Any serviceable materials, obtained during dismantling or demolition shall be separated out and stacked properly as directed with all lead and lift. All unserviceable materials, rubbish etc., shall be stacked as directed' by the Engineer-in-charge.

On completion of work, the site shall be cleared of all debris rubbish and cleaned as directed.

## **2.2 MODE OF MEASUREMENTS AND PAYMENT**

Measurements of all work except hidden work shall be taken before demolition or dismantling and no allowance for increase in bulk shall be allowed. The demolition of plaster shall be measured under this item. Specification for deduction for voids, openings etc. shall be on same basis as that employed for construction of work,

The rate shall include cost of all labour involved and tools used in demolishing and dismantling including scaffolding. The rate shall also include the charges for separating out and stacking the serviceable materials properly and disposing the unserviceable materials with all lead and lift.

The rate also includes for temporary shoring for the safety of the portion not required to be pulled down or of adjoining property and providing temporary enclosures or portions were considered necessary.

The rate shall be for a unit of one cubic meter.

## **3.0 Demolition of R.C.C. work including stacking of serviceable materials and disposal of unserviceable materials with all lead and lift for R.C.C. work**

### **3.1 WORKMANSHIP**

The demolition shall consist of demolition of one or more parts of the building as specified or shown by the engineer in charge. Demolition implies taking up or down or breaking up. This shall consist of demolishing whole or part of work including all relevant items as specified or shown by the engineer in charge.

The demolition shall always be planned beforehand shall be done in reverse order to the one in which the structure was constructed. This scheme shall be got approved from the Engineer-in- charge before starting the work. This

however will not absolve the contractor from the responsibility of proper and safe demolition.

Necessary propping, shoring and under pinning shall be provided for the safety of the adjoining work or property, which is to be left intact, before dismantling and demolishing is taken up and the work shall be carried out in such a way that no damage is caused to the adjoining property.

Wherever required, temporary enclosures or partitions shall also be provided. Necessary precautions shall be taken to keep the dust nuisance down as and where necessary.

Dismantling shall be commenced in a systematic manner. All materials which are likely to be damaged by dropping from a height or demolishing roof plaster, masonry plaster etc. shall be carefully dismantled first. The dismantled articles shall be properly stacked as directed.

All materials obtained from demolition shall be the property of Government unless otherwise specified and shall be kept in safe custody until handed over to the Engineer-in-charge.

Any serviceable materials, obtained during dismantling or demolition shall be separated out and stacked properly as directed with all lead and lift. All unserviceable materials, rubbish etc., shall be stacked as directed' by the Engineer-in-charge.

On completion of work, the site shall be cleared of all debris rubbish and cleaned as directed.

**4.0 Dismantling of inside cement plaster including racking the masonry joints as per direction of engineer in charge. The rate includes necessary excavation below plinth. up to 15 cm or as per instruction of engineer in charge and plastering of that portion shall be dismantled and making good the disturbed ground and stacking useful materials as directed & disposing of the unserviceable materials with all lead & lift etc. complete, as directed.**

**4.1 WORKMANSHIP:**

The demolition shall consist of demolition of one or more parts of the building as specified or shown in the drawings. Demolition implies taking up or down or breaking up. This shall consist of demolishing whole or part of work including all

relevant item as specified or shown in the drawings.

The demolition shall always be planned before hand and shall be done in reverse order of the one in which the structure was constructed. This scheme shall be got approved from the Engineer-in-charge before starting the work. This however will not absolve the contractor from the responsibility of proper and safe demolition.

Necessary dropping, shoring and under pinning shall be provided for the safety of the adjoining work or property, which is to be left intact, before dismantling and demolishing is taken up and the work shall be carried out in such a way that no damages is caused to the adjoining property.

Wherever required, temporary enclosures or partitions shall also be provide 1. Necessary precautions shall be taken to keep the dust nuisance down as and where necessary.

Dismantling shall be commenced in a systematic manner. All materials which are likely to be damaged by dropping from a height or demolishing roof, masonry etc. shall be carefully dismantled first. The dismantled articles shall be properly stacked as directed.

All materials obtained from demolition shall be the property of Government unless otherwise specified and shall be kept in safe custody until handed over to the Engineer-in-charge.

Any serviceable materials, obtained during dismantling or demolition shall be separated out and stacked properly as directed, with all lead and lift. All unserviceable materials, rubbish etc. shall b stacked as directed by the Engineer-in-charge.

On completion of work, the site shall be cleared of all debris rubbish and cleaned as directed.

#### **4.2 MODE OF MEASUREMENT & PAYMENT:**

Measurements of all work except hidden work shall be taken before demolition dismantling and no allowance for increase in bulk shall be allowed. The demolition of lime concrete shall be measured under this item. Specification for deduction for voids, openings etc. shall be on same basis as that employed for construction of work.

All work shall be measured in decimal system as fixed in its place subject to the following limits, unless otherwise stated hereinafter: (a) Dimensions shall be measured to the nearest 0.01 mt. (b) Area shall be worked out to the nearest 0.01 sq. mt. (c) Cubical connection shall be worked out to the nearest 0.01 Cum.

The rate shall include cost of all labour involved and tools used in demolishing and dismantling including scaffolding. The rate shall also include the charges for separating out and stacking the serviceable materials properly and disposing the unserviceable materials with all lead and lift. The rate also includes for temporary storing for the safety of the portion not required to be pulled down or of adjoining property and providing temporary enclosures or partitions were considered necessary.

The rate shall be for a unit of one square meter.

### **Item No: 0 TO 0 JUNLGE CUTTING, EARTH WORK, FILLING, SOLING,**

#### **1. EXTENT AND INTENT**

The work under this section covers all operations listed below concerning the civil work and the site development work.

- a. Clearing and grubbing
- b. Grading
- c. Excavation including removal of top soil
- d. Filling and back filling
- e. Removal and disposal of surplus material
- f. Bringing sweet earth from outside where required
- g. Hard stone soling to floors and paving

The Contractor shall provide all materials, labour, equipment, operations and incidental necessary and required for the completion of all aspects of work listed above as called for in the drawings and specifications.

#### **2. GENERAL**

The Contractor shall visit the site, and decide for himself the nature of the ground and the subsoil to be excavated. No claim of extras will be entertained in consequence of any misunderstanding or incorrect information or ignorance of

existing conditions.

### **3. ANTIQUITIES**

Any ancient carvings, relics, coins or other curiosities discovered during the excavation or other work shall remain the property of the Owner and shall be handed over to the EIC.

### **4. EXCAVATED MATERIALS**

Any sand, gravel or similar useful materials obtained from excavation site shall be the property of the Owner and shall not be disposed of or used in the construction of the works without prior written consent of the EIC. It is the intention of this contract that all benefits accruing from materials within the site shall pass to the Owner and the fair market price of any such material disposed of or used shall be alleged to the Owner by the Contractor and the contract sum adjusted accordingly.

Borrow pits shall not be dug on the site without the prior written consent of the EIC.

### **5. CLEARING**

The Contractor shall clear the site of all rubbish and unwanted civil work. All disused foundation drains or other obstructions met with during excavation shall be dug out and cleared at Contractor's own expense.

### **6. BENCHMARKS**

The Contractor shall erect sufficient permanent benchmarks in suitable locations for all the works before starting work, from which all the important levels shall be laid out. A qualified surveyor shall be engaged by the Contractor to locate all buildings, paths, roads, utility lines, etc. Contractor shall provide all pegs, flags, pillars and labour required for setting out.

### **7. EXCAVATION**

Excavation for foundations, footings, trenches, paving, walkways, etc., as called for on the drawings shall be generally made to net widths required by the drawings. "Battering" or "Benching" to the sides of excavation shall have prior approval of the EIC. Extra excavations (i.e. excavations beyond the limits required by the drawings), "battering" and "benching" carried out without the prior approval of the EIC will not be measured, and such unauthorized

excavations shall be filled up to the proper level with concrete of the same type and mix as for foundations or as ordered by the EIC at Contractor's own expense.

**8. EXCAVATION IN ROCK**

All rock excavation shall be carried out with the help of crowbars, chiseling or burning. Blasting shall not be carried out without the written permission of the EIC, roughly level or shelf bottom, as required and avoid shattering or removing rock beyond authorized lines and grades.

**9. STACKING OF SOIL**

Excavated materials shall be placed at a distance of more than 1.5 meters from the edge of the trench, of half the depth of the trench, whichever is more.

**10. WATER IN EXCAVATION**

All water, which may accumulate in excavation from all causes, is to be baled, pumped out or otherwise removed. No extra payment shall be made if otherwise specified. Adequate pumping or other facilities shall be employed to keep all excavation clear of water constantly. Care shall be taken to see that the water is not discharged where it will cause damage to the work or other property or cause inconvenience in the legitimate use of the property. During excavation, the Contractor shall take particular care to avoid damage to drains, water mains, underground work and services. Should any damage be done, the EIC and Structural Designer are to be notified immediately and the damage made good at the Contractor's expense. Pipes, cables, etc. met with during the excavation are to be properly slung or otherwise supported.

**11. NOTIFICATION TO PMC/TPI**

The Contractor shall notify Team leader of PMC/TPI when excavation is ready for inspection and no foundation shall be put in before they have approved the excavation. He shall give the team leader of PMC/TPI at least three working days' notice.

**12. PROTECTION**

The Contractor shall protect the excavation from the effect of harmful weather or other damage or make good such damages to the satisfaction of team leader of PMC/TPI.

### **13. DRESSING**

Pit and trench bottoms shall be smoothed and tightly rammed to a uniform surface.

### **14. FILL MATERIAL**

Fill materials required for fill and back fill shall be subject to the approval of the EIC and Structural Designer. Fill materials shall be hard and free from all soft or spongy material. Clods or rocks over 20 cm in greatest dimension shall not be placed within 30 cm of grade. No material over 8 cm in size shall be placed in the upper 15 cm of fill. Fill under floors, terraces and concrete beds shall be free of saltpeter, white ants etc.

#### **EARTH FILLING (BY EXCAVATED EARTH)**

The work shall be taken up after the building has reached up to plinth stage or the floorlevel, as the case may be. The space between the walls shall be filled in with the approved earth (excavated earth) in layers of 150mm to 200mm (6" to 8") thick to required level, each layer watered and consolidated properly before putting next layer. No lumps, clods or rubbish are to be used in filling. After filling, the area to be flooded with water for a day to enable the filling to be thoroughly consolidated and allowed to get sufficiently dry after which ramming and leveling as directed by Engineer shall be done. Filling in basement over raft foundation will also come under this item.

#### **EARTH FILLING (EARTH BROUGHT FROM OUTSIDE)**

If the earth has to be bought from outside of the site, the rate includes the purchase cost of the earth, loading and unloading, its carting from outside to site, octroi, levy royalty or any other form of taxes as per prevailing rules, screening if necessary, spreading in 150mm to 200mm (6" to 8") layers and watering, ramming and consolidating with 10 ton roller, if it not possible then through electric compactors of adequate capacity. Each layer prior to putting next layers as per the instruction of Engineer. The earth shall be got provided prior to bring on site. The earth shall be free from tree roots, weeds, big stones, and other objectionable materials liable to decay.

#### **CINDER FILLING**

The work shall be carried out after the building is constructed up to plinth or the floor level or at terrace or toilet sunk slab level as the case may be and the



space required is filled up with cinder brought from outside to the required level and then it is properly watered and consolidated in the layers of 150 mm (6") wood ash, dirt and foreign matters. Cinder should be ground fine and screened through sieve of 9 meshes per Sq.Cm. (64 meshes per sq. in) and residue in the sieve should be rejected. Cinder shall not contain more than 10% of un-burnt carbon (combustible matter).

#### **15. FILL COMPACTION**

The fill shall be spread in layers not exceeding 15 cm thick and each layer shall be watered and thoroughly consolidated with a ten (10) ton roller. At locations where rolling is not possible, the filling shall be carried out in layers not exceeding 15 cm thick and each layer rammed with heavy hammers till the required level is reached. The fill shall then be flooded with water for at least 24 hours, allowed to dry and then rammed and consolidated again. The finished surfaces shall be formed to correct lines, levels, slopes, shapes etc. as required. Fills at building structures, walk paths etc. shall not be executed until all foundations, footings etc. have been inspected and approved by the EIC.

Return and fill in around foundations, walls etc. as described above and bring grades up to either original ground levels or as required by the drawings when different from original grades.

#### **16. FINISH GRADING**

Finish grading shall be done with fertile topsoil over those area notes as 'planting' on the plans. Depths of topsoil shall be 15 cm minimum. The EIC shall approve the topsoil before placement.

#### **17. REMOVAL**

Removal of excavated materials includes the separation of the useful from the useless portion (what is useful and what is useless is left to the sole discretion of the EIC) and depositing the former in regular heaps and removal of the latter. Surplus earth, if any and useless spoil shall be carted away from the site and disposed as directed at Contractor's cost. Disposal shall be at authorized dumping grounds only.

#### **18. PLANKING, STRUTTING AND SHORING**

The Contractor shall be responsible to adopt such measures as may be needed to uphold the sides of excavation and protect excavation against the sides of

public utilities and services and other structures. The rates for excavation shall include use and waste of timber or steelwork, as planking and strutting including walls, struts and open or close poling boards as directed by the EIC.

## **19. HARD-CORE**

Hard-core (stone soling) under floors and other locations where called for, shall be approved hard broken stones 50 mm and down. The stones shall be hand packed in position, interstices between stones packed with smaller chips and the surface thoroughly, rolled with a 10-ton roller, with frequent watering. The surface shall then be blinded with Murrum, watered thoroughly and consolidated with a 10-ton roller to required grade and profiles. Earth shall on no account to be used for making god or blinding purposes. Where rolling as described above is not possible, the consolidation shall be carried out using heavy hand rammers and light manually operated rollers. The consolidated thickness shall be as shown on the drawings.

### **Item No: - 11, 12, 30**

**Providing FE-500 TMT (Code 1786-2008) reinforcement for RCC work including cutting bending, binding and placing in position for All floor (Ground and First Floor)**

#### **1.0. Materials:**

**1.1.** Cold twisted steel bars (high yield strength steel deformed bars) shall conform to M-16. Mild steel binding wires shall conform to M-18.

#### **2.0. Workmanship:**

**2.1.** The work shall consist of furnishing and placing reinforcement to the shape and dimensions shown as on the drawings or as directed.

**2.2.** Steel shall be clean and free from rust and loose mill scale at the time of fixing in position and subsequent concreting.

**2.3.** Reinforcing steel shall conform accurately to the dimensions given in the bar bending schedules shown on relevant drawings. Bars shall be bent cold to specified shape and dimensions or as directed using a proper bar bender, operated by hand or power to attain proper radius of bends. Bars shall not be bent or straightened in a manner that will injure the material. Bars bent during transport or handling shall be straightened before being used on the work. They

shall not be heated to facilitate bending. Unless otherwise specified, a 'U' type hook at the end of each bar shall invariably be provided to main reinforcement. The radius of the bend shall not be less than twice the diameter of the round bar and the length of straight part of the bar beyond the end of the curve shall be at least four times the diameter of the round bar. In case of bars which are not round and in case of deformed bars, the diameter shall be taken as the diameter of circle having an equivalent effective area. The hooks shall be suitably encased to prevent any splitting of the concrete.

- 2.4.** All the reinforcement bars shall be accurately placed in exact position shown on the drawings and shall be securely held in position during placing of concrete by annealed binding wire not less than 1 mm in size, and by using stay blocks or metal chair spacers, metal hangers, supporting wires or other approved devices at sufficiently close intervals. Bars shall not be allowed to sag between supports nor displaced during concreting or any other operations of the work. All devices used for positioning shall be of non-corrodible material. Wooden and metal supports shall not extend to the surface of concrete, except where shown on drawings. Placing bars on layers of freshly laid concrete as the work progresses for adjusting bar spacing shall not be allowed. Pieces of broken stone or brick and wooden blocks shall not be used. Layers of bars shall be separated by spacer bars, precast mortar blocks or other approved devices. Reinforcement after being placed in position shall be maintained in a clean condition until completely embedded in concrete. Special care shall be exercised to prevent any displacement of reinforcement in concrete already placed. To prevent reinforcement from corrosion, concrete cover shall be provided as indicated on drawings. All the bars protruding from concrete and to which other bars are to be spliced and which are likely to be exposed for a period exceeding 10 days shall be protected by a thick coat of neat cement grout.
- 2.5.** Bars crossing each other where required shall be secured by binding wires (annealed) of size not less than 1 mm in such manner that they do not slip over each other at the time of fixing and concreting.
- 2.6.** As far as possible, bars of full length shall be used. In case this is not possible, overlapping of bars shall be done as directed. When practicable, overlapping bars shall not touch each other, but be kept apart by 25 mm. or 1.25 times the maximum size of the coarse aggregate whichever is greater by concrete between them. Where not feasible, overlapping bars shall be bound with annealed wires not less than 1 mm. thick twisted tight. The overlaps shall be staggered for different bars and located at points along the span where neither

shear nor bending movement is maximum.

- 2.7.** Whenever indicated on the drawings or desired by the Engineer-in-charge, bars shall be joined by couplings which shall have a cross-section sufficient to transmit the full stresses of bars. The ends of the bars that are joined by coupling shall be upset for sufficient length so that the effective cross section at the base of threads is not less than normal cross section of the bar. Threads shall be standard, threads. Steel for coupling shall conform to I.S. 226.
- 2.8.** When permitted or specified on the drawings, joints of reinforcement bars shall be butt-welded so as to transmit their full stresses. Welded joints shall preferably be located at points when steel will not be subject to more than 75 per cent of the maximum permissible stresses and welds so staggered that at any one section not more than 20 percent of the rods are welded. Only electric arc welding), using a process which excludes air from the molten metal and conforms to any or all other special provisions for the work shall be accepted. Suitable means shall be provided for holding bars securely in position during welding. It shall be ensured that no voids are left in welding and when welding is done in two or three stages, previous surface shall be cleaned properly. Ends of the bars shall be cleaned of all loose scale, rust, grease, paint and other foreign matter before welding. Only competent welders shall be employed on the work. The M.S. electrodes used (or welding shall conform to I.S. 814. Welded pieces of reinforcement shall be tested. Specimen shall be taken from the actual site and their number and frequency of test shall be as directed.

**The above specifications shall be followed except that the cold twisted steel bars shall be used with or without hooks at the ends. Deformed bars without hooks shall, however, comply with relevant anchorage requirements.**

**3.0. Mode of measurement and payment:**

- 3.1.** For the purpose of calculating consumption, wastage shall not be permitted beyond 5percent. Excess consumption over 5% will be charged at penal rate.
- 3.2.** Reinforcement shall be measured in length excluding overlaps (as per GR No. PDW-10-2017-01-C, date 15), separately for different diameter as actually used in the work. Where welding or coupling is resorted to, in place of lap joints, such joints shall be measured for payment as equivalent length of overlap as per design requirement. From the length so measured, the weight of reinforcement

shall be calculated in tonnes on the same basis of as per M-18 even though steel is Supplied to the contractor by the department on actual weight. Length shall include hooks at the ends. Wastage and annealed steel wire for binding shall not be measured and the cost of these items shall be deemed to be included in the rate for reinforcement.

**3.3.** The rate for reinforcement includes cost of steel binding wires its carting from Department a store to work site, cutting, bending, placing, binding and fixing in position as shown on the drawings and as directed. It shall also include all devices for keeping reinforcement in approved position, cost of joining as per approved method and all wastage and spacer bars

**3.4.** The rate shall be for a unit of One Kg.

**Item No.10 : Providing and laying controlled cement concrete M-250 for R.C.C. bored piles of 1.20 Mt. diameter including ramming, vibrating and finishing complete.**

**Item No. 20 : Providing and laying cement concrete 1:2:4 (1-Cement : 2-Coarse sand : 4-graded stone aggregates 20 mm nominal size) and curing complete excluding cost of formwork in (A) Foundation and Plinth**

**Item No. 21 : Providing laying Controlled cement concrete M-250 and curing complete including the cost of form work and excluding cost of reinforcement for reinforced concrete work in : RCC Column Footings**

**Item No. 22 : Providing laying Controlled cement concrete M-250 and curing complete including the cost of form work and excluding cost of reinforcement for reinforced concrete work in : RCC Column up to Plinth Level.**

**Item No. 23 : Providing laying Controlled cement concrete M-250 and curing complete including the cost of form work and excluding cost of reinforcement for reinforced concrete work in : RCC Columns for Ground Floor**

**Item No. 24 : Providing laying Controlled cement concrete M-250 and curing complete including the cost of form work and excluding cost of reinforcement for reinforced concrete work in : RCC Plinth beams**

**Item No. 25 : Providing laying Controlled cement concrete M-250 and curing complete including the cost of form work and excluding cost of reinforcement for reinforced concrete work in : RCC Floor Beams at GF Slab level.**

**Item No. 26 : Providing and laying cement concrete 1:3:6 (1-Cement : 3-Coarse sand : 6-crushed stone aggregates 20 mm nominal size) and curing complete including cost of formwork in (A) Wall Caps / Coping**

**Item No. 27 : Providing laying Controlled cement concrete M-250 and curing complete including the cost of form work and excluding cost of reinforcement for reinforced concrete work in : RCC Slabs & Landings**

**Item No. 28 : Providing laying Controlled cement concrete M-200 and curing complete including the cost of form work and excluding cost of reinforcement for reinforced concrete work in : RCC Staircase.**

**Item No. 29 : Providing laying Controlled cement concrete M-200 and curing complete including the cost of form work and excluding cost of reinforcement for reinforced concrete work in : RCC lintel**

## **CONCRETE WORK (PLAIN & REINFORCED)**

### **1. EXTENT AND INTENT**

The Contractor shall provide all labour, materials, operations, equipment and incidentals necessary and required for the completion of all concrete work called for.

### **2. GENERAL**

It is the intent of this specification to ensure that all concrete placed at various locations on the job should be durable and strong. It should wear well and be practically impervious to water. It should be free from such defects as shrinkage, cracking, honeycombing, all plain and reinforced concrete shall conform in all respects to Indian standard 456-2000.

### **3. MATERIALS**

Cement: Ordinary Portland Cement of 53 Grade conforming to IS: 12269-1976 shall be used. Cement shall have uniform color. Cement shall be fresh when

delivered at site. Consignment shall be used in order of delivery. Admixtures (such as accelerators, retarders, waterproofing compounds, etc.,) shall be as far as possible avoided, where its use is considered unavoidable it may be used only if approved by the EIC and subject to IS: 456-2000.

Water: Water used for mixing concrete shall be in accordance with clause 4/3 of IS: 456- 2000. The Contractor shall produce Test Results for the mixing of water used on the job, when requested by the EIC.

Aggregates: Aggregates (fine and coarse) should be had and should not contain materials that are likely to decompose or change in volume when exposed to water or to affect the reinforcement. All aggregates shall be clean and free from organic impurities. The aggregates shall be free from coatings or dust and clay. Coarse aggregate shall be machine crushed hard stone and fine aggregate shall be coarse river sand, and both obtained from approved source. Aggregates shall be screened and washed by mechanically operated equipment, if the deleterious materials content exceeds 5 percent by volume. All aggregates used shall conform to IS: 383-1979. If the aggregates are wet, due allowance shall be made for bulking in accordance with IS: 2386-1963 (Part III)

Unless otherwise specified, the size of coarse aggregates shall conform to clause 4.2 of IS: 456-2000.

All aggregates shall be suitably graded from the maximum certified gauge to the minimum. The Contractor shall submit a sieve analysis of the aggregates to be used on the works and maintain a regular record of sieve analysis during the currency of the work. The grading of the aggregates will be determined from these sieve analyses to produce maximum density of concrete. All expenses of sieve analysis, mix design and trial mix shall be borne by the Contractor.

#### **4. STORAGE**

Cement shall be stored in accordance with clause 5.1 of IS: 269V1967. Any cement, which has become wet, show any sign of caking, or deterioration, or contamination of any kind shall not be used, and shall be immediately removed from the site. Fine and coarse aggregates shall be stored in separate open bins sorted to sizes. The bins shall have brick wall of adequate thickness and floor paved with flat bricks.

#### **5. BATCHING**

In the case of ordinary concrete, aggregates shall be measured by volume,

cement by weight (density of cement assumed to be 1.44 kg/liter. (A. 50-kg bag of cement contains 35 liters). Mixing water shall be measured in graduated liter cans.

## 6. MIX PROPORTIONS

All concrete not specifically designated as controlled concrete shall be treated as ordinary concrete of nominal mix as specified. Where nominal concrete mixes are described as 1:11 / 2:3, 1:2:4, 1:3:6, 1:4:8, etc., the figures denote the relative properties of cement, dry sand and graded stone aggregate respectively. For example, concrete of nominal mix 1:2:4 shall mean a mix of 1 part cement, 2 parts of washed dry coarse sand and 4 parts crushed graded stone aggregate, the proportion being volumetric.

The cement shall be measured by weight, and aggregates shall be measured in properly constructed gauge boxes. If sand is wet, necessary allowance shall be made for bulking. The size of aggregates shall be 20 mm and downgraded suitably to achieve dense concrete.

All aggregates and cement shall be measured by weights in approved high-batching equipment and water shall be measured in graduated, liter cans.

Grade of Concrete	Minimum Compressive Strength Preliminary (Trial) Cubes	of 15 cm Cubes at 28 days Test Work Test Cubes
M 150	200 kg/cm <sup>2</sup>	150 kg/cm <sup>2</sup>
M 200	260 kg/cm <sup>2</sup>	200 kg/cm <sup>2</sup>
M 250	320 kg/cm <sup>2</sup>	250 kg/cm <sup>2</sup>
M 300	380 kg/cm <sup>2</sup>	300 kg/cm <sup>2</sup>
M 350	440 kg/cm <sup>2</sup>	350 kg/cm <sup>2</sup>

## 7. WATER-CEMENT RATIO

The water-cement ratio shall be carefully controlled throughout the work. This calls for a regular check on the equipment used for measuring water. Only guaranteed liter-cans shall be used for this purpose.

In the case of 'ordinary' concrete, the maximum value of water-cement ratio shall be 0.50 and in the case of 'controlled' the water-cement ratio as determined by the mix design shall be strictly adhered to. While determining



the amount of mixing water, moisture content of aggregates shall be taken into account. Additional water if water, moisture content of aggregates shall be taken into account. Additional water if used to improve to workability shall be accompanied by an equal volume of cement. In any case, such additional use of water shall be subject to approval of the EIC.

## **8. MIXING**

All concrete, whether plain or reinforced, ordinary or controlled, shall be mixed in a standard type box mixer, having minimum drum speed of 60 peripheral meters per minute. The cement and aggregates shall be first mixed dry until all articles of aggregate are coated with cement. Mixing water shall be added and mixing continued for at least two to twelve minutes to form concrete of a uniform color and consistency.

## **9. TRANSPORTATION**

Concrete shall be placed in its final position within 20 minutes of mixing. The Contractor shall arrange his mixer position and a method of transportation to ensure that this period is not exceeded under any circumstance. Transportation should be smooth and free from jolting, so that there is no segregation or loss of any of the ingredients.

## **10. PLACING CONCRETE**

The forms shall be well wetted before placing concrete. Concrete should not be dropped from a height greater than 1 meter. Properly constructed chute shall be used in such cases where it is necessary to exceed this height. Concrete must be thoroughly worked into the forms so that they are entirely filled; reinforcing bars adequately and tightly surrounded and entrained air released from the mass of concrete. Placing shall be carried out by hand punning as well as vibrators in the manner directed by EIC. Concrete should not be moved any considerable distance in the molds, being consolidated as nearly as possible in the place where it is dumped. The full depth of any lift shall be replaced at one pouring. In casting beams or other deep sections, concrete shall not be placed in layers.

## **11. CONSOLIDATION**

All plain and reinforced concrete shall be consolidated by means of mechanical vibration. Adequate number of vibrators shall be used to ensure full compaction of concrete in about 10 minutes of placing. If immersion vibrators are used,

these shall be inserted at places not exceeding half meter apart until it is immersed to the full depth of concrete. Wherever possible shutter vibrators shall be used and the Contractor shall design his shuttering so that this can withstand form vibration. Care shall be taken to ensure that concrete is not over-vibrated to avoid segregation. In addition to mechanical vibration, sufficient hand tools must be used to ensure full consolidation around reinforcement and at all edges and corners.

## **12. TESTING**

Testing of Cube: Specimens of the concrete used in the work shall be taken at intervals for crushing strength and density measurements. Test cubes shall be made and tested strictly in accordance with IS: 456-2000 and IS: 516-1964. Three to six cubes should be made for each sampling, subject to minimum requirements specified in Table V of IS: 456-2000. However, cubes shall be taken for all important structural members as directed by the EIC regardless of the quantity of concrete involved in such members or volume of concrete laid on any particular day. They should be taken out of the moulds 24 hours after casting and stored in a moist condition until the time of test. The Contractor shall carry out the tests as described above under the direction of EIC and all expenses of cubes, testing and other incidentals shall be borne by the Contractor.

All concrete the test results of which fall below the "Acceptance Criteria for Concrete" listed under table V of IS: 456-2000 shall be classified as substandard concrete. All such substandard concrete shall be removed and replaced with concrete of specified strength at the Contractor's own cost and risk.

## **13. INSERTS**

The Contractor shall fix all necessary inserts such as steel plates, pipe sleeves, bolts, etc., and make provision for holes, pockets, dowels, etc., in the shuttering of concrete work, to enable subsequent fixing of supports, brackets, ceilings, pro-cast members, etc., as indicated on the drawing or as required by EIC.

## **14. CURING OF CONCRETE**

All exposed faces of concrete shall be covered with Hessian, sand or similar material, which shall be kept continuously, wet for a period of at least 15 days after casting. Horizontal surfaces shall be cured with the help of cement mortar bunds filled with water. After removal of Hessian or sand all concrete surface

shall be kept well wetted by applying water at intervals for a further period of at least three weeks.

## **15. REINFORCEMENT**

Steel Reinforcement shall be either mild steel quality conforming to Grade I of IS: 432- 1966 or High yield Strength Deformed Bars with a guaranteed minimum yield strength of 4250 kg or 5000 kg per m<sup>2</sup> as called for on the drawings, conforming to IS: 1786-1966 or IS: 1139-1966. Fabric reinforcement where called for in topping slab or precise concrete units shall be of hard drawn mild steel mesh conforming to IS: 1566-1967. The make of the reinforcement will be from the Manufacturers listed herewith (1) Malhotra, (2) TATA, (3) Sirhind, (4) SAIL, (5) Vizag. Bars shall be free from mill scale, loose rust, oil or paint. The reinforcement bar-ending schedule shall be prepared by the Contractor and submitted to the Structural Designer for his scrutiny and his concurrence obtained before commencing minimum cover as shown on structural drawings. Steel shall be rigidly held in place with the help of 18-gauge annealed steel wire. Cement mortar (1:2) cover blocks of required shape, MS chairs and spacers bars shall be used in order to ensure accurate positioning of reinforcement. All joints in mild steel reinforcement upto and including 16- mm diameter shall be overlapped. The lengths of overlap for tension and compression joints shall be as indicated on structural drawings. Joints in mild steel reinforcement above 16-mm diameter may be welded if permitted by the EIC in writing.

## **16. COVER TO REINFORCEMENT**

Care shall be taken to maintain the correct cover to reinforcement. Unless otherwise specified on the drawings, the following minimum cover (exclusive of rendering or other decorative finish) shall be provided in all reinforce concrete work.

- a. At each end of a reinforcing bar not less than 25 mm nor less than twice the diameter of bar.
- b. For longitudinal reinforcing bar in a beam neither less than 25 mm nor less than the diameter of bar.
- c. For longitudinal reinforcing bar in a column not less than 40 mm in the case of columns less than 250 mm thick, minimum cover shall be 25 mm.
- d. For tensile, compressive shear reinforcement in a slab not less than 13 mm nor less than the diameter of bar.

- e. For Vertical or horizontal reinforcement in concrete walls not less than 25 mm nor less than diameters of bar.
- f. For main or subsidiary reinforcement in concrete footings and pile caps not less than 50 mm.
- g. The minimum cover for any reinforcement steel including stirrups and ties wires shall not be less than 13 mm under any circumstances.

For concrete members exposed to the atmospheric action or harmful chemicals (as in the case of concrete in contact with earth faces with such chemicals), acid vapor, saline atmosphere, sulfurous smoke, etc., covers given above shall be increased by 15 mm to 40 mm as directed by EIC. For concrete members of water retaining structures, covers for reinforcement shall be as stipulated in IS: 3370-(part II) - 1965.

## **17. FORMWORK**

Formwork shall be rightly constructed of minimum 40 mm thick wrought, timer planking or steel plates or plywood. Timber used for shuttering shall be free from loose knots. Shuttering faces in contact with concrete shall be free from adhering grout, Projecting nails, splits or other defects that may mar the concrete surface. The shuttering shall be erected on battens, beams and steel props properly cross braced so as to make the form work rigid. Formwork shall be erected to line and levels and to the shapes required in the work and shall carry, without deformation, the full weight of wet concrete and other live loads. It should also withstand the effect of vibration without deflection, bulging, distortion or loosening of its component parts. The Contractor shall be responsible for sufficiency and adequacy of all formwork, centering and moulds.

Details of centering and formwork shall be subject to approval of the EIC. The completed formwork shall also be subject to approval by the EIC before placement of reinforcement. The formwork shall be designed so that the soffits of slabs and the sides of beams may be removed first leaving the formwork to the soffits of beams and their supports in position. Wedges shall be, so provided as to allow accurate adjustment of form works and its easy removal.

All joints shall be sufficiently tight to prevent leakage of grout. Chamfer fillets shall be provided at all corners wherever called for on the drawings. Clean-out holes shall be provided at the bottom of all column and pier formwork and care shall be taken to remove any rubbish, wood shavings or any other foreign materials before concreting. Temporary supports shall be provided as required

and / or ordered by EIC.

Form work for water tanks, basements and other locations and facias, parapets and other similar vertical members shall be held tightly by means of firm ties of suitable length. The ties shall be approved design and type and have a minimum strength of 1500 kg. The ties shall be free of lugs, cones, washes, etc., which level a hole larger than 20 mm diameter or depressions back of exposed surface of concrete.

#### **18. SURFACE TREATMENT OF SHUTTERING**

The Surface of shuttering exposed to concrete shall be coated with shuttering oil of approved manufacture. Shuttering oil shall be applied before placing reinforcement. The shuttering shall be thoroughly cleaned and oiled before each use.

#### **19. REMOVAL OF FORMWORK**

All form shall be kept in position until expiry of a minimum Period after concreting as specified below:-

- |   |         |
|---|---------|
| i. Forms supporting sides of beams, walls and columns | 2 days  |
| ii. Bottom of slab up to 4.50m span                   | 7 days  |
| iii. Bottom of slabs above 4.50m span                 | 14 days |
| iv. Bottom of beam up to 6.00m span                   | 14 days |
| v. Bottom of beam above 6.00m span                    | 21 days |

#### **20. SURFACE FINISH OF CONCRETE**

All formwork, centering and shuttering used for unexposed concrete work shall be rigid and straight, so as to produce all concrete members true to line level and plumb within a tolerance of + 3 mm. Only cement mortar rendering of maximum thickness 6 mm may be permitted as finishing to concrete surfaces except where terrazzo, ceramic tile or other finish are specified. All concrete surfaces scheduled to receive either plaster or similar finish shall be chipped as required if so directed by the EIC. Shuttering, centering and formwork to be used for all exposed concrete work (like exposed columns, beams, ribs, slabs chhajjas, facias, etc.) shall be of such finish and rigidity as to produce all faces fair and smooth true to line, level and plumb. No. rendering or touching up shall be permitted on these faces.

## **21. DEFECTS IN CONCRETE**

Immediately on removal of formwork, the Contractor shall examine the surface of concrete, and any honeycombs or other defects shall be brought to the notice of the EIC. The acceptability or otherwise of such defective concrete shall be at the sole discretion of the EIC who may direct the Contractor to repair the defective work or ask for demolition and replacement of such defective work at the risk, and cost of the Contractor.

## **22. PROTECTION OF CONCRETE**

All concrete shall be protected from damage by workers, equipment, overload or any other cause for a minimum period of 20 days from the date of casting.

All edges corners and projections of concrete members likely to be damaged shall be protected by means of wooden cover fillets.

## **23. ENGINEER**

It is essential that the engineer who is in charge of the construction of all concrete work, whether plain or reinforced shall be well experienced in this class of work and shall work in relation to the permanent bench marks established at the site.

**Item No. 19 : White Stone Bela Masonry block in course in Sub structure with stone of approved quality in Cement mortar 1:6 (1-cement : 6-coarse sand) including packing the joints etc. complete. (more than 10 ton)**

**Item No. 31 : White Stone Bela Masonry block in course in super structure with stone of approved quality in lime mortar 1:6 (1-cement : 6-coarse sand) including packing the joints etc. complete. (up To 10 ton)**

**Item No. 32 : White Stone Bela Masonry block partition wall up to 15 cm thickness in cement mortar 1:4 (1-cement : 4-coarse sand) (more than 10 ton)**

### **1.0. Materials:**

The stone or Bela shall be white hard sand stone Bela or block. The stone shall be sound hard rough and durable. it shall be free from skin. Thickness of Bela or block shall not be less than 15 cms or as directed. The mortar used shall consist

one part of cement and 6 or 4 parts of fine sand cement mortar shall conform to 1:6 or 1:4.

## **2.0. Workmanship:**

### **2.1. Dressing of stone:**

Stone shall be chiseled dressed on all the sides so that all size sides shall be in a rectangular shape and all the stones shall be so dressed that the bulging of the exposed face shall not project nor depression from the general wall surfaces. The size of Bela or block shall be as per thickness of the wall to be constructed or as directed.

### **2.2. Laying:**

All the stone shall be sufficiently wetted before laying to prevent absorption of water from mortar. All connected walls in a structure shall normally be raised up uniformly and regularly. The vertical joint shall not be allowed and also it shall not be more than 12 mm in thickness.

**2.3.** Proper bonding shall be made by laying Bela or block side by side each other with cement mortar on bed as well as in between two Bela or block vertically.

### **2.4. Bond stones:**

Bond stones or through stones running right across the thickness of the wall shall be provided in walls up to 450 mm thick. In thicker walls two Bellas or blocks over laying each other by at least 150 mm each other shall be provided across the thickness of the wall to form bond stone, such bond stone shall be at least one for every 10 sq mt area of the wall surface.

### **2.5. Joints:**

All the joints shall be completely filled up with mortar and their thickness shall not exceed by 12 mm. When plastering or pointing is not required to be done, the joints shall be struck flush and finished, simultaneously while laying the stone. Otherwise, the joints shall be raked to a minimum depth of 20 mm during process of laying while mortar is still green.

### **2.6. Scaffolding:**

Single or double scaffolding shall be used. It shall be strong and sound. The holes left in masonry for supporting shall be made good before plastering.

## **2.7. Curing:**

Green work shall be cured for a period of 7 days continuously.

## **3.0. Mode of measurements and payment:**

**3.1.** The work shall be measured on the basis of finish dimensions. No deduction shall be made nor extra payment shall be made for the following:

- (a) Ends of joints, beams, posts, girders, rafters, purlins, trusses, corbels etc. each up to 500 sq. cms. in section
- (b) Opening each up to 0.10 Sqm.
- (c) Small plates and bed plates, bearing of and like up to 10 cms depth (bearing or floor and roof slabs shall be deducted from masonry)
- (d) Drain holes and recesses for cement block to embedded hold fasts for doors and windows etc.

**3.2.** The rate shall be for a unit of one cubic meter

## **Item No: 0 to 0**

### **BRICK WORK**

#### **1. EXTENT AND INTENT**

The Contractor shall provide all labour, materials, operations, equipment and incidentals necessary and required for the completion of all brickwork called for.

#### **2. GENERAL**

Bricks and tiles shall be of selected quality, thoroughly burnt without being vitrified, of uniform deep red or copper color, regular in shape and size and shall have sharp and square sides and edges and parallel faces to ensure uniformity in the thickness of the courses of brickwork. They shall be free from cracks, chips, flaws, stones or lumps of any kind.

#### **3. BRICKS**

Bricks used in the works shall conform to the requirements laid down in IS: 1077. Bricks shall be locally available first-class bricks. Bricks shall be of size 9" x 4 1/2" X 2 3/4" (22.9 cm x 11.1 cm x 7.0 cm) or conventional bricks unless



otherwise specified. In all masonry work bricks of class designation 35 are to be used.

#### **4. SAMPLES**

Samples of each type of brick and tiles taken at random from the load shall be deposited with the EIC for his approval before being used in the work. All subsequent deliveries shall be up to the standard of the sample approved.

#### **5. SOAKING OF BRICKS AND TILES**

All bricks and tiles shall be thoroughly soaked before use, in specially prepared vats, tubs or tanks for not less than two hours and until air bubbles stop being given off. After soaking, bricks and tiles shall be kept on wooden planks or brick platforms to avoid earth being smeared on them.

#### **6. MORTAR**

Mortar for all brickwork shall consist of cement and clean, sharp coarse sand.

#### **7. CEMENT**

Portland cement conforming to IS: 269-1967 shall be used, unless otherwise specified. Cement shall be fresh when delivered at site.

#### **8. SAND**

Sand shall be clean, not too fine nor too coarse and shall fall within the grading zone I to IV given in table III of IS: 383-1963.

#### **9. WATER**

Water used for mixing mortar shall be in accordance with clause 4.3 of IS: 456-2000.

#### **10. MIX PROPORTION**

The mortar shall consist of one part cement and 6 parts sand for brickwork and tile work 240 mm thick and above. For brick piers, half brick walls and honey combed brickwork the mortar mix shall consist of one part cement and four parts sand.

#### **11. MORTAR MIXING**

Mixing of mortar shall be done in mechanical mixer. Hand mixing shall be resorted to only when specifically permitted by the EIC. Cement and sand shall be mixed dry thoroughly and then water shall be added gradually. Wet mixing shall be continued till mortar of the consistency of a stiff paste and uniform color is obtained. Only the quantity of mortar which can be used up within 30 minutes of its mixing shall be prepared at a time.

## **12. LAYING BRICKWORK**

All brickwork shall be built in English / Flemish bond. Each brick shall be set with bed and vertical joints filled thoroughly with mortar. Selected bricks shall be used for the face work. The walls shall be taken up to truly plumb. All courses shall be laid truly horizontal and vertical joints shall be truly vertical. Vertical joints in alternate course shall come directly over the other. The thickness of brick courses shall be kept uniform and for this purpose wooden straight edge with graduation giving thickness of each brick course including joint shall be used. Necessary tools comprising of wooden straight edge, mason's spirit level, square, foot rule, plumb line and pins etc. shall be frequently and fully used by the mason to ensure that the walls are taken up true to plumb, line and levels.

Both the faces of walls of thickness greater than 23 cm shall be kept in proper plane. All the connected brickwork shall be carried up nearly at one level and no portion of the work shall be raised more than one meter above the rest of the work. Any dislodged brick shall be removed and reset in fresh mortar. Before commencing the brickwork, the Contractor shall confer with other tradesmen / agencies to ensure that all pipes, conduit, drains, sleeves, bolts hanger, or any other materials necessary to be installed in the brickwork at the time it is built, have been fixed or provided for.

## **13. JOINTS**

Bricks shall be so laid that all joints are full of mortar. The thickness of joints shall not be more than 10 mm. The face joints shall be raked to a minimum depth of 12 mm by a raking tool during the progress of the work when the mortar is still green, so as to provide proper key for the plaster or pointing to be done. Where plastering or pointing is not to be done, the face of brickwork shall be cleaned duly and mortar droppings removed.

## **14. REINFORCED BRICKWORK**

Brickwork under 11.5 cm thick shall be reinforced with 6mm M.S. Bar – 2 Nos.

at every fourth course. 6mm M.S. Bar shall be embedded thoroughly in cement mortar at every fourth course. It shall be cast in or securely fixed to adjoining columns or walls.

#### **15. CURING**

All fresh brickwork shall be protected from the effects of sun, rain, etc., by suitable covering. All brickwork shall be kept constantly mist on all the face for at least ten days.

#### **16. SCAFFOLDING**

Unless otherwise instructed by the EIC, double scaffolding having two sets of vertical supports shall be provided for all building work. The supports shall be sound, strong and tied together with horizontal pieces over which the scaffolding planks shall be fixed.

The Contractor shall be responsible for providing and maintaining sufficiently strong scaffolding so as to withstand all loads likely to come upon it.

#### **17. OPENINGS**

Openings in brickwork for air-conditioning ducts, grills, pipes etc. shall be provided at the time of laying brickwork.

#### **18. CAULKING**

After installation of piping, conduits, grilles etc. all openings left around pipes, conduits, grilles etc. shall be checked and caulked with cement mortar to render the whole work vermin proof and tidily finished.

#### **19. TESTING**

comprehensive strength, water absorption tests a dimension test has to be carried out as per the relevant I.S. specifications for purchase of every one lakh bricks or part thereof, at the cost of Contractor from the Government approved laboratory as directed by the EIC.

#### **Item No: 0 to 0**

**Uncoursed Rubble Masonry with hard stone of approved quality in foundations and plinth in Cement Mortar 1:6 (1 cement : 6-coarse sand including levelling up etc. complete**

## **1. Materials**

Stones for the works shall be of the specified variety, which are hard, durable, fine grained and uniform in colour (for superstructure work) free from veins, flaws and other defects. Quality and work shall conform to the requirements specified in IS: 1597 (Part-I). The percentage of water absorption shall not exceed 5 percent as per test conducted in accordance with IS: 1124. The Contractor shall supply sample stones to the LOCAL BODY for approval. Stones shall be laid with its grains horizontal so that the load transmitted is always perpendicular to the natural bed.

Cement-sand mortar for stone masonry works shall be in the proportion of 1:6. Materials and preparation of mortar shall be as specified in clause 7.2.1.

## **2. Workmanship**

For All Works below ground level the masonry shall be random rubble uncoursed with ordinary quarry dressed stones for the hearting and selected quarry dressed stones for the facing.

For all works above ground level and in superstructure the masonry shall be random rubble uncoursed, well bonded, faced with hammer dressed stones with squared quoins at corners. The bushings on the face shall not be more than 40 mm on an exposed face and on the face to be plastered it shall not project by more than 12 mm nor shall it have depressions more than 10 mm from the average wall surface.

Face stones shall extend back sufficiently and bond well with the masonry. The depth of stone from the face of the wall inwards shall not be less than the height or breadth at the face. The length of the stone shall not exceed three times the height and the breadth on base shall not be greater than three-fourths the thickness of wall nor less than 150 mm. The height of stone may be up to a maximum of 300 mm. Face stones or hearting stones shall not be less than 150 mm in any direction.

Chips and spalls shall be used wherever necessary to avoid thick mortar joints and to ensure that no hollow spaces are left in the masonry. The use of chips and spalls in the hearting shall not exceed 20 percent of the quantity of stone masonry. Spalls and chips shall not be used on the face of the wall and below hearting stones to bring them to the level of face stones.

The maximum thickness of joints shall not exceed 20 mm. All joints shall be

completely filled with mortar. When plastering or pointing is not required to be done, the joints shall be struck flush and finished as the work proceeds. Otherwise, the joints shall be raked to a minimum depth of 20 mm by a raking tool during the progress of the work while the mortar is still green.

Through or bond stones shall be provided in walls up to 600 mm thick and in case of walls above 600 mm thickness, a set of two or more bond stones overlapping each other by at least 150 mm shall be provided in a line from face to back. In case of highly absorbent types of stones (porous lime stone and sand stone, etc.) the bond stone shall extend about two-thirds into the wall and a set of two or more bond stones overlapping each other by at least 150 mm shall be provided. Each bond stone or a set of bond stones shall be provided for every 0.5 sqm of wall surface.

All stones shall be sufficiently wetted before laying to prevent absorption of water from the mortar. All connected walls in a structure shall be normally raised uniformly and regularly. However, if any part of the masonry is required to be left behind, the wall shall be raked back (and not saw toothed) at an angle not exceeding 45deg. Masonry work shall not be raised by more than one meter per day.

Green work shall be protected from rain by suitable covering. Masonry work shall be kept constantly moist on all the faces for a minimum period of seven days for proper curing of the joints.

Type of scaffolding to be used shall be as specified in clause 7.2.2.

The stone pitching work shall be done in workmanlike manner for straight or on slope in true line levels.

**3. Curing:**

All the complete work shall be cured with gunny bag and water for 7 days.

**4. Measurement:**

The completed work shall be measured and paid in Cu-Mt.

**Item No. 53 : Providing and fixing FRP frame size 100 X 50mm and 28mm thick FRP depress panel shutter having extra reinforcement on sides & edges in gel coat finish. The core of the shutter & frame is to be filed up with injected fire-retardant grade**

polyethene foam done in situ along with embedded wooden pieces for stiffening & also taking hinges & fixtures. the whole FRP frame & shutter is to be water proof weather proof, termite proof & resistance to mild acid/alkali. rates are to be inclusive of S.S. hinges with necessary screw & aluminum fixtures & fastenings & fastener sleeve.

**Item No. 54 :** Providing and fixing 35mm thick shutter for doors, windows and clerestory windows including Indian teak wood frames 12cm x 7cm. Size including anodized aluminum fixtures and fastenings including primer coat of approved quality and two coats of oil painting etc., complete. (ii) Fully Panelled.

**Item No. 78 :** Providing and fixing in position collapsible steel shutters with vertical channels 20 x 10 x 2 mm braced with flat iron diagonals 20 x 5 mm size with top and bottom rails of T rin 40 x 40 x 6 mm with 38mm Dia, steel pulleys complete with bolts, nuts, locking arrangements, stoppers handles including applying a priming coat of red lead paint.

**Item No. 64 :** Providing and fixing window having extruded aluminum Colour Powder Coated section frame main outer size 95mm x 24mm x 1.17mm @ wt. of 0.738 Kg/mt, horizontal Three track member size 92mm x 31.75mm x 1.30mm @ Wt.1.07 Kg/mt, vertical member of size 92mm x 31.75mm x 1.50mm, @ Wt. 1.06 Kg/mt with sliding shutters of horizontal member size 40 mm x 18mm x 1.29mm @ wt. of 0.456 Kg/mt, vertical member of size 40mm x 18mm x 1.29 mm @ wt. of 0.456Kg/mt with 5 mm thick transparent bronze colour tinted float glass with powder coated aluminum fittings and fixtures and transparent silicon sealant glass fixing to frame as per details etc.

#### **4.0 CARPENTER AND JOINTER:**

##### **4.1 TIMBER:**

All timber shall be as per relevant specification mentioned in the section of materials.

The timber for frames and shutters for doors, windows, ventilators shall be of

first class, sound, well-seasoned, Balsar teak wood / C.P. teak wood or other specified and approved quality wood and shall be free from knots, shakes, fissures, flaws, sun cracks and other defects.

All timber for carpentry and joinery in contact with masonry or concrete shall be coal tarred before fixing. All exposed faces of timber shall receive a primer coat before erection. The rate shall be inclusive of one coat of primer and three coats of approved quality and shade of flat enamel paint.

Unless otherwise specified all doorframes shall have six M.S. flat holdfasts and window frames shall have four holdfasts. Holdfast shall be provided to the ventilators, if directed.

When door/window frames are to be fixed to R.C.C. column or R.C.C. wall, holdfast shall be substituted by suitable arrangements such as coach screws, rowl bolts etc. to secure frames to R.C.C. column or R.C.C. wall, as directed by Architects.

Frames and shutters shall not be painted or erected before being approved by Architect.

#### **4.1.1 CARPENTRY WORK:**

The timber shall be properly planned and wrought in a workman like manner. Joints shall be true and properly fit, assembled accurately and clamped together so as to make square, flat, and close joints.

No timber shall be painted, tarred without the previous permission of the Architects / Engineer-in-Charge, no glue or wedges shall be allowed to be used and all woodwork before being erected shall be passed by Architects/Engineer-in-Charge.

In wrought timber, tolerance of 1.5 mm will be allowed for each wrought face of size specified except where described as "finished" in which case they shall have to be the full dimensions. The rate, for wood work, shall include the cost of all sawing, planning, framing, labor and materials and fixing and supply of all traps, bolts, nails, spikes, keys, wedges, pins, screws, glues, etc. necessary for the framing and fixing joints, Portions inserted in the masonry / floor shall not be allowed for the measurements.

#### **4.1.2 JOINERY:**

Doorframe shall be of such dimensions as directed by the Architects/ Consulting Engineers. They shall be properly framed and mortised and tenoned together and set in masonry by means of M.S. / wrought iron holdfasts. The parts hidden in the masonry shall be well tarred or coated with solignum-paint. The frame shall be rebated by 13 mm up to the face thickness of shutters on one side if the shutter is on one side and to be molded as per design. The other side of the frame shall be rebated if there are shutters on both the sides.

#### **4.1.3 T.W. DOOR OR WINDOW FRAME:**

T.W. shall be of good quality as specified above. Frame size shall be of 150 x 63 mm or 127x 76 mm as specified in Bills of Quantities. Rebate and grooves shall be made for receiving shutters, grills, plaster etc. as per drawing.

#### **4.1.4 WOODEN FLUSH DOOR SHUTTERS (SOLID CORE TYPE):**

Solid core flush shutters shall be of commercial or teak veneered type as specified in the item, of approved quality and manufactured by approved manufacturers. The finished thickness of the shutter shall be as mentioned in the tender items, Face veneer shall be of the pattern and color approved by Architects and as per approved sample, which shall be deposited in the office of Architects for reference, The shutters will be provided with T.W. lipping.

The framework shall be measured in Smt. from outside to outside of frame and shall be priced per unit of Smt. The rate shall include fixtures and fastening as required and specified in Table -4.1.

#### **4.1.5 PANELLED SHUTTERS:**

The exact shape for frame shall be as per Architects/Consulting Engineer's details. The styles-rails and panels shall be 37 mm thick and 25 mm thick respectively. Wood panels shall be of pattern and size as specified. The panel shall be joined continuous with 40 x 6 mm thick ply, inserted into grooves and glued together. The grains of solid Panel shall run along the longer dimension of the panel and Panel shall be framed into groove to the full depth of the groove leaving an air gap, and the faces shall be closely filled to the sides of groove. The type and number of fixtures shall be as mentioned in the Table-4.1 given below. The fixtures and fastening shall be fixed rigidly to the shutter If they get loosened within defect liability period, the contractor shall have to replace the shutters with better ones at his cost.

The rate is inclusive of providing and fixing. The measurement shall be in sq.



meter and dimensions measured out to out of the frame. The rate is inclusive one coat of primer and three coats of approved quality and shade of enamel paint.

#### **4.1.6 TEAK GLAZED SHUTTERS:**

These shall be similar to paneled shutter except that such parts as are directed shall be glazed with plain or ground sheet glass or plate glass or frosted glass as specified. Styles and rail in the glazed shutters shall be rebated 13 mm to receive glass. Such bars shall be mounted and rebated and mitered on side to receive the glass. Glass panels shall be fixed by means of teak beads painted with approved paint. The prices shall include supply and fixing of glazing and teak beads with screws, painting, polishing except where otherwise stated in the Bills of Quantities.

**TABLE - 4.1**

**SCHEDULE FOR HARDWARE FITTINGS FOR WOODEN SHUTTERS**

Sr. No.	Type of Shutters	S. S. Hinges		Tower Bolts Aluminum		Handles Aluminum		Wind Hook & Eye / Adjusters		Cleats		Aldrops Aluminum		Latches (For Toilet Doors)	
		No.	Size	No.	Size	No.	Size	No.	Size	No.	Size	No.	Size	No.	Size
1.	Glazed or Partly Glazed or Fully Paneled Double shutters size														
i)	1.20 m x 2.10 m x 40mm thick	6	10 cms.	3	25 cms	3	15 cms.	--	10 cms	--	15 cms	1	30 cms	--	--
ii)	(size exceeding 1.20 M x 2.10 M x 1.50 M x 2.45 M)	6	13 cms	2	45 cms	3	15 cms	-	15 cms	2	20 cms	1	30 cms	--	--
iii)	(Size exceeding 1.50 M x 2.50 M)	6	15 cms	2	60 cms	3	15 cms	--	20 cms	2	30 cms	1	45 cms	--	--
2.	Glazed or Partly Glazed or Fully Paneled Double shutter size														
i)	up to size 0.90 M x 2.0 M	3	13 cms	2	25 cms	2	15 cms	--	10 cms	1	15 cms	--	--	1	30 cms
ii)	Size exceeding 0.50 M x 2.0 M	3	15 cms	1	30 cms	2	15 cms	--	15 cms	1	20 cms	1	30 cms	--	--
3.	Doors with wire gauge panels														
i)	Double shutters all sizes	4	13 cms	3	25 cms	3	20 cms	--	15 cms	1	15 cms	1	30 cms	--	--
		2	Single action spring hinge												

			s												
ii)	Single shutter of all sizes	2	13 cms	2	25 cms	2	20 cms	--	15 cms	1	15 cms	1	30 cms	--	--
4.	Windows Glaze / partly glazed & fully glazed	4	10 cms	3	15 cms	3	15 cms	2	15 cm	2	15 cms	--	--	--	--
i)	Double shutter up to 11.50 mt. height														
ii)	-do- single shutter	2	10 cms	1	10 cms	1	15 cms	1	15 cms	1	15 cms	--	--	--	--
5.	Fan light & ventilator	2	7.5 cms	--	--	--	--	1	Spring hinges	--					
		2	Pivot Hinges												

**Notes:**

1. The top of tower bolt in closed position should be within a reach of 1.90 M.
2. Eye and hooks in places of hinged door stopper are to be used in case of window shutters when the operation cannot be done due to fixing of grills, wire mesh or expanded metal or wire netting on one side of opening.
3. For shutters exceeding 40mm thickness heavy type SS butt hinges of 125 mm x 90 mm x 40 mm shall be used.
4. Hardware of timber doors, windows etc. shall be as above, if not specified otherwise, and shall be of quality as approved by the Architect / Consulting Engineer.

#### **4.1.7 TEAKWOOD LOUVERED SHUTTERS:**

The specification shall be as per paneled shutter except that such part as are directed shall be louvered. In louvered shutter, the style shall have groove of 25 mm width and 15 mm depth, to receive teak wood louvers of 25 mm thickness. The louver shall be fixed at an angle as per drawing. The louver's width shall be 10 mm less than the slant groove width to finish with beading. The beading size shall be 15 mm x 15 mm and shall be fixed, as specified, with screw.

The work shall be measured in sq. mtrs inclusive of frames both ways. The rate includes providing and fixing, louvers, beading, fixtures and fastenings as required and specified in the Table - 4.1 or as directed.

#### **4.1.8 FIXING GLASS LOUVERS:**

Louvers shall be 6mm thick of wired glass or frosted glass with ground/polished edges as specified and of approved quality. The work shall be measured in sq. mtrs inclusive of frames and shall be measured outside of frames both ways according to drawing. The rate includes providing & fixing glass, beading, paints or polishing etc.

#### **4.1 STEEL WINDOWS:**

Steel windows shall conform to IS: 1038 and shall have brass oxidized fittings. They may be of composite sizes and assembled and fixed as per the manufacturer's specifications using special mastic and putty for steel windows. The size of section shall be such as to be adequate for the specific type shown on the drawing. They shall have necessary accessories such as handles, stays, lugs, etc. The members shall be assembled with electric flush butt-welded joints/welded smooth joints as directed. These items include all types of windows such as fixed partially fixed, partially hinged, side hung, bottom hung, top hung, center hung, etc. This item also includes windows of curved shapes and all other windows as specified and detailed by the Architects/consulting Engineers. The necessary accessories such as handles, stays, stoppers, etc. shall be brass oxidized and shall be included in this item. The rate also includes glazing panels with plain or ground glass with aluminum/teak wood beads of the required size and mastic putty of the same color, which shall be applied for full length and not at intervals. The contractor shall provide windows with threaded holes for fixing aluminum/wooden beading, with screws, required for fixing of thickness specified.

The windows shall have glazed fixed as shown in the drawing and the glass shall be float glass sheet glass of the best quality and approved by the Architect/Consulting Engineer. It shall be transparent or translucent as required by the Architect/ Consulting Engineers. It shall be free from flaws, specks, and bubbles.

Thickness of glass shall be as under (costs included in this item).

- (i) 24 Oz glazing for glass size not exceeding area 600 mm x 600 mm subject to any dimension not exceeding 1.0 meter.
- (ii) 26 Oz glazing for glass size not exceeding area 750 mm x 750 mm but any dimension not exceeding 1.20 meter.
- (iii) 32 Oz glazing for glass size not exceeding area 75 mm x 750 mm and 900 mm x 900 mm but any dimension not exceeding 1.20 meter.
- (iv) 6 mm thick plate glass for glass size more than 900 mm x 900 mm and any dimension not exceeding 1.00 meter.

**4.2.1.1** Typical approved samples of the glazing unit shall be kept in the office of the Architect till the satisfactory completion of work. The decision of the Architect whether a unit compares well with the approved sample shall be binding as final on the concerned parties.

The rate also includes a coat of primer (yellow zinc chromate) before erection and after erection, 3 coats of approved enamel paint of required shade to the windows. Fixed and open able window shall be paid separately. The measurement shall be square meter of overall size of the frame as per drawing.

#### **4.2.2 HARDWARE:**

Rates of doors and window include fixing of all hard wares of specified and approved quality and material.

#### **4.2.3 SCHEDULE OF HARDWARE (UNLESS OTHERWISE SPECIFIED):**

- (a) Steel windows (each shutter): 150 mm handle. - 1 No.
- 300 mm peg stay - 1 No.
- Project of friction hinges - 2 Nos.
- (b) Top or bottom hung ventilators:
  - 300 mm peg stay arm - 1 No.

Projection or friction hinges.	- 2 Nos.
(c) Steel doors:	
Brass mortise lock with a pair of chromium handles.	- 1 No.
300 mm tower bolt (per leaf)	- 1 No.
Friction Hinges (per leaf)	- 3 Nos.

**Measurement:**

Width and height shall be measured outside to outside of frame and measurement shall be in Smt.

**4.2.4 COLLAPSIBLE STEEL DOORS AND GATES:**

Approved manufacturers shall fabricate these, from mild steel sections. The gates shall be double or single collapsible gates depending upon the size of the opening. These shall consist of vertical double channels 20 x 10 x 2 mm at 100 mm centers braced with flat iron diagonals 20 x 5 mm and with top and bottom rails of Tee section of size 40 x 40 x 6 mm with 38 mm dia pulleys or ball bearings in every 4th double channel, unless otherwise specified. Where collapsible gate is not provided within the opening and is fixed along the outer surface, Tee section at the top may be replaced by flat 40 x 10 mm. the collapsible gate shall be provided with necessary bolts and nuts, locking arrangements, stoppers and handles. Any special fittings like springs, catches and locks shall be provided as described in the Bills of quantities.

Rates include for making zari in floors and walls, holes in masonry of R.C.C and restoring the same including applying one coat of rust remover, one coat of zinc chromate and three coats of approved make and shade of flat/enamel paint or aluminum paint.

**Measurement:**

The gate shall be measured in sq. mtrs. The breadth and height shall be measured correct to a cm. The height shall be measured as the length of double channels and breadth from outside to outside of the end fixed double channels in open position of the gate.

**4.2 ROLLING SHUTTERS:**

Rolling shutters shall consist of 75 mm wide 18-gauge M.S. laths machine rolled and straightened with an effective bridge depth of 16 mm. The laths shall

be interlocked through their entire length and jointed together at the end with end locks. These shall be mounted on specially designed pipe shaft. Each lath section shall be a continuous single strip piece without any joint. The spring shall be prepared from unbreakable high tensile spring steel wire or strip of adequate strength to balance the shutter in all positions. The spring assembly shall be supported on strong mild steel or malleable cast iron bracket shaped to fit the lintels. The shutter shall be complete with door suspension shafts, guides, locking arrangements, brackets, pulleys with ball bearings, pushing hooks, handles, top covers etc. Fixing shall be done accurately in a workman like manner such that the operation of the shutter is easy and smooth.

Rate includes applying one coat of rust remover, one coat of yellow zinc chromate primer and three coats of approved make and shade of flat/enamel paint etc.

Rolling shutters shall be measured in square meters of the clear opening to which they are fixed and in no case top drum with cover and channels shall be paid extra or shall be calculated in area.

#### **4.3 ALUMINIUM DOORS, WINDOWS, VENTILATORS ETC:**

These shall be obtained from approved and established manufacturers and shall be of aluminum alloy conforming to IS: 733 and sections shall generally conform to IS: 1948. These shall be fabricated as per the drawings.

##### **4.3.1 GENERAL:**

**(I)** The unit assemblies shall be as per drawing or as directed by the Architects.

The unit assemblies shall be anodized finished. Anodizing shall be minimum 20 to 25 microns thick, of matt non-directional and non-specular. Anodized surface shall be suitably protected during transportation, storage and erection.

Sub units shall be together by concealed screws, Jamb member shall be self-mullion Ing type obtaining use of separate mullions, thus increasing clear height of each unit.

**(II)** Joints shall either be mitered or coped. All joints shall be neat, hair line, and sealed with epoxy to make them water proof.

**(III)** Open able shutters shall have a single row continuous neoprene or PVC weather strip to prevent air infiltration. Weather strips shall not be interrupted by any fittings.

- (IV)** All windows shall be glazed from inside with PVC rubber or approved "Shalimar" putty. Glazing beads shall snap fit and shall be fitted without use of screws. No screws other than those on some of the hardware shall be visible.
- (V)** Glazing shall be approved and specially selected quality glass of thickness as specified in the Bills of Quantities.
- (VI)** The rate shall include supplying and fixing with fittings and fixtures including approved locking arrangements.
- (VII)** Before handing over, the aluminum work shall be washed with mild solution of non-alkali soap and water.

**4.4.2.1** The glazing units, doors, windows and ventilators shall not be built into the walls but shall be fixed in the prepared opening with lugs in masonry or with screws and jute expansion plugs in holes carefully drilled in RCC work. Mastic compound shall be provided all around the frame of the glazing unit at the junction of the frame and opening to make the junction watertight.

Composite glazing units shall be supplied loose with necessary coupling transoms or mullions with machine screws and mastic compound and shall be coupled with box mullions. The mullions shall be embedded in mastic to make the joint watertight.

Measurement shall be in Smt. of net area fixed at site.

**Item No. 33 : 20mm thick sand faced cement plaster on walls up to 10 meter above ground level consisting of 12mm thick backing coat of C.M. 1:3 (1-cement : 3-fine sand) and 8 mm thick finishing coat of C.M. 1:1 (1-cement : 1-sand) etc. complete.**

**Item No. 34 : Providing 15mm thick cement plaster in single coat on rough (Similar) side of single or half brick walls for interior plastering up to floor two level and finished even and smooth in (i) C.M. 1:3 (1-cement : 3-sand).**

**Item No. 35 : Providing 10mm thick cement plaster in single coat on brick/concrete walls for interior plastering up to floor two level and finished even and smooth in (i) C.M. 1:3 (1-cement : 3- sand)**

## **PLASTER WORK**

### **1. EXTENT AND INTENT**



The Contractor shall furnish all materials, labour, scaffolding, equipment, tools, plant and incidentals necessary and required for the completion of all plaster and wall finishes. The Contractor shall be responsible to take proper precautions to protect already installed work from damage.

## **2. GENERAL**

Plaster as here in specified shall be applied to all internal and external surfaces where called for Glazed tile dado, terrazzo dado, and other wall finishes are to be provided as and where indicated on drawings and schedules. Areas called for on drawings and typical shall be considered to apply to appropriate, adjoining areas whether shown on same drawings or not and whether indicated or not. All plaster work and other wall finishes shall be executed by skilled workmen in a workman like manner and shall be of the best workmanship and in strict accordance with the dimensions on drawing.

## **3. PLASTER WORK**

The primary requirements of the plaster work shall be to provide an absolutely water tight enclosure, dense, smooth and hard and devoid of cracks on the interior and exterior. The Contractor shall do all that is necessary to ensure this result. All plastering shall be finished to true plane, without imperfections and square with adjoining work and shall form proper foundations for finishing materials such as paint etc.

Masonry and concrete surfaces to which plaster is to be applied shall be clean, free from efflorescence, damp and sufficiently rough and keyed to ensure proper bond.

Wherever directed all joints between concrete frames and masonry in filling shall be expressed by a groove cut in the plaster. Said groove to exactly coincide with the joint beneath.

Where grooves are not called for the joints between concrete members and masonry in filling shall be covered by 245 gauges galvanized chicken-mesh strips 40mm wide or as shown, installed before plastering.

## **4. CHASING**

All chasing, installation of conduits, boxes etc. to be completed before any plastering or other wall finish is commenced on a surface. Chasing or cutting of plaster or other finish will not be permitted. Broken corners shall be cut back

not less than 150mm on both sides and patched with Plaster of Paris or rich cement paste as directed. All corners shall be rounded to a radius of 8 mm or as directed by the EIC.

## **5. SAMPLES**

Samples of each type of plaster and other wall finishes shall be prepared for approval of the EIC.

## **6. MATERIALS**

Cement As specified under concrete work

Water As specified under concrete work.

Sand Washed fine sand and / or stone aggregate as called for sand and stone aggregate to conform to the requirements given under "concrete work"

## **7. PROPORTIONS**

The materials used for plastering shall be proportioned by volume by means of gauge boxes.

## **8. PREPARATION OF SURFACE**

The joints in all walls, both existing and freshly built shall be raked into a depth of 15mm brushed clean with wire brushes dusted and thoroughly washed before starting plaster work. Concrete surfaces shall be roughened by hacking over the entire surface shall be roughened by hacking over the entire surface as approved by the EIC to ensure proper key for the plaster.

## **9. MORTAR MIXING**

Mortar shall be prepared as specified under "Brick Work" it shall be made in small quantities only as required and applied within 15 minutes of mixing

## **10. APPLIANCES**

Plaster application shall be commenced only after the preparatory work is approved by the EIC. Correct thickness of plaster shall be obtained by laying plaster screeds gauges at intervals of 1.50 meters.

Mortar shall be firmly applied, well pressed into the joints, rubbed and finished as approved by the EIC to give a smooth and even surface.

## **11. CURING**

Finished plaster shall be kept wet for 10 days after completion. In hot weather walls exposed to sun shall be screened with matting kept wet or any other approved means.

## **12. WATER PROOF CEMENT PLASTER:**

Specifications are same as stated above but the waterproof compound like OCNFLOW SNW2, JK WATER PROOF or any other approved quality shall be mixed with dry cement at the rate specified by the manufacturer.

### **1. NORMAL CEMENT PLASTER (IN ONE COAT)**

This plaster is to be laid in one coat of 12mm thick in Cement Mortar 1:4, 1 Cement: 4 fine sands, on the surface prepared for plaster and following all the norms as stated above in 1. PLASTER.

### **2. CEMENT PLASTER WITH NEERU + CEMENT FINISH**

This kind of Plaster is normally for interior side or as specified location by consultant to be applied as above 2. NORMAL CEMENT PLASTER and the surface shall be rubbed smooth after coating it with a thick coat of pure Portland cement slurry while the base coat is still fresh. If Neeru plus cement finish is specified floating with neat cement will not be required.

### **3. SAND FACE PLASTER (CEMENT PLASTER IN DOUBLE COAT)**

This plaster is to be laid in double coat in 20mm thick in cement mortar.

Rough and fine sand plaster in single coat on shall be 12mm thick backing coat made by mixing one part of cement to three parts of clean fine sand for coat the ingredients shall be workable mix is obtained. And 8mm thick finishing coat at of cement mortar made by mixing one part of cement & two parts of clean fine sand. The plastered surfaces will be completed by means of sponges to obtain an even and granular surface all over. The entire plasterwork shall be done to perfect plumb. The sides of windows, openings such as jambs, and reveal sun breakers, drop Paradis, fins, chhajjas and the like, around externally shall be finished as directed by the Consultant / Engineer- in-charge and shall be included in the rate of this item.

The plaster shall be thoroughly cured for 14 days as directed by Consultant / Engineer-in-charge. Any cracks which appear in the surface and all portions

which sound hollow, when tapped or are found to be soft or otherwise defective, shall be cutout in rectangular shape and redone as directed by the Consultant / Engineer- in- charge.

**Item No. 46 : Providing and laying Granite slab (18mm thick) slab flooring over 20mm (Average) thick base of cement mortar 1:6 (1-cement : 6-Coarse sand) or L.M. 1:1.5 laid over and jointed with grey cement slurry including rubbing and polishing complete (Basic Granite rate shall be 250/Sqft) (A) Granite slab 18mm thick**

**Item No. 47 : Providing and laying 18mm thick Granite slab in riser of steps Dedo and pillars laid 10mm thick Cement Mortar 1:3 (1-Cement :3 Coarse Sand) and jointed with Grey Cement Slurry including rubbing and polishing complete.**

**Item No. 50 : Providing and laying colored glazed tiles of the size 300 mm x 200 mm x 8 mm / 300 mm x 450 mm x 8 mm in skirting, risers of steps and Dedo on 10 mm. thick cement plaster 1:3 (1 cement : 3 coarse sand) & jointed with white cement slurry.**

**Item No. 55 : Providing & Laying 24" x 24" vitrified 8 mm thick (with skirting) tile flooring over 20 mm (average) base of cement mortar 1:6 (1 cement : 6 coarse sand) on new surface or fixing on existing flooring by adhesive material including dismantling of existing flooring and jointed with 4/5 mm grouting Bal Indura Grouting material including finished with flush pointing & cleaning the surface etc. Flooring**

**Item No. 62 : Providing and laying broken china mosaic flooring for terrace using 12 mm to 20 mm broken pieces of glazed tiles to be laid over cement mortar 1:3 to plain or slope and to be tempered to bring mortar crème out up to surface using white cement including rounding off junctions and extending them up to 15cm along the wall clearing with water and oxalic acid etc. as directed**

## **FLOOR FINISHING**

### **1. GENERAL**

The Contractor shall furnish all labour, materials, and operations including fixing

devices, equipment and incidentals necessary and required for the completion of all flooring work. The Contractor shall pave the areas indicated on the plans and Schedule of finishes with materials therein called for. All flooring shall be laid to the best practice known to the trade. The flooring shall be laid to the level except where slopes are called for on the drawings, in which case the slopes shall be uniform and arranged to drain into the indicated outlets. Particular care shall be exercised to ensure that all flooring and DADOS are perfectly matched for color and finish.

## **2. SAMPLES**

The Contractor shall furnish for approval by EIC samples of each type of floor and dodo finish.

## **3. DRESSING OF SLABS**

Every slab to be cut to the required size and shape and fine chisel dressed on the sides to the full depth. The sides shall be table rubbed with coarse sand or machine rubbed before paving. All angles and edges of the tiles shall be true, square and free from chipping and the surface shall be true and plane.

## **4. LAYING**

Lime Mortar 1:1.5 (1 Lime: 1.5 Coarse sand) shall be spread under the area of each slab to 20 mm depth. Washed clean slab shall be laid on top, pressed, tapped with wooden mallets and brought to level with adjoining slabs. It shall then be lifted and laid aside. The top surface of the mortar shall then be corrected by adding fresh mortar at hollows. The mortar is allowed to harden a bit and a coat of cement slurry shall be spread over at the rate of 1 bag of cement per 10m<sup>2</sup> of area, the slab shall then be with as fine a joint as possible. Subsequent slabs are laid in similar manner. After each slab is laid, surplus cement on the surface shall be cleaned off. The flooring shall be cured for a minimum period of seven days.

## **5. POLISHING AND FINISHING**

Slight unevenness at the meeting edges of slabs shall then be removed by fine chiseling in slant. The surface shall then be polished and fished in the same manner as specified for "Terrazzo-in-situ floor".

## **6. JOINTS**

The joints shall be uniform and as thin as possible and run in straight lines or to suit the required pattern.

Tiles that are fixed in the floor adjoining the wall shall enter not less than 13 mm under the plaster dado. The junction between wall plaster and tile work shall be finished neatly and without weavings. After the tiles have been laid surplus cement grout that may have come out of the joints shall be cleaned off.

### **7.13 BRICKS ON EDGE FLOORING:**

#### **7.13.1 BRICKS**

Specifications of brickwork shall apply. Broken bricks shall not be used except for closing the line. The bricks shall be laid on edge.

#### **7.13.2 MORTAR**

The mortar used shall be as specified. In case of dry brick flooring, fine sand shall be filled in joints.

#### **7.13.3 SUBGRADE:**

If the sub-grade is of lean cement concrete the flooring shall commence within 48 hours, of laying of sub-grade, failing which, the surface, of sub-grade shall be roughened with steel wire brushes without disturbing the concrete. Before laying the flooring, the sub-grade shall be wetted and smeared with a coat of cement slurry at about 2 kg. of cement spread over and are of one Smt. so as to get a good bond between sub-grade and flooring.

Where sub-grade is not provided, the earth shall be properly sloped, watered, rammed and consolidated. Before laying the flooring, it shall be moistened.

#### **7.13.4 SOAKING OF BRICKS:**

Bricks required for flooring shall be soaked properly before use. In case, the joints are to be filled with sand, the bricks need not be soaked.

#### **7.13.5 LAYING:**

The bricks shall be laid on edge, in plain, diagonal, herring bone bond or other pattern as specified or directed by Engineer-in-Charge.

Brick shall be laid on edge on 12 mm thick mortar bed of specified

proportion, and each brick shall be set by gentle tapping with hand trowel or wooden mallet, its inside faces shall be buttered with mortar, before the next brick is laid and pressed against it. On completion of a portion of flooring, the vertical joints shall be fully filled from the top with mortar. The surface during laying, shall be frequently checked with a straight edge at least 2 m. long, so as to obtain a true plane surface with the required slop. Finished work shall be cure for 10 days. In case of dry brick flooring, no curing shall be done.

#### **7.13.6 MEASUREMENT:**

Length and breadth shall be measured as laid and area shall be calculated in sq. meter correct to two places of decimal. Rate shall include cost of all material and labor including application of cement slurry on sub-grade and cleaning of sub-grade.

### **7. CURING, POLISHING AND FINISHING**

The day after the tiles is laid all joints shall be cleaned with wire brush to the depth of 5 mm and all dust and loose mortar removed. Joints shall then be grouted with gray or white cement, mixed with or without pigment to match the shade of the topping of the wearing layer of the tiles. Pigment shall conform to IS 459.

The floor shall then be Kept wet of minimum period of 7 days. The surface shall thereafter be ground evenly to the satisfaction of EIC with machine grinders in 3 phases with grade stones from coarse to fine grade. The surface shall receive wash of neat cement mixed with or without pigment and cured before very grinding operation.

**Item No. 45 : Fabrication for railings, gates etc. using MS square pipes of 12 gauge of Asian, TATA or equivalent make**

**Item No. 76 : Providing and fixing M.S. grills of required pattern with M.S. flats at required spacings and frame all-round, square or round bars with round headed bolts and nuts or by screws (A) Plain Grill.**

### **STEEL WINDOWS, RAILING & METAL WORK**

#### **1. EXTENT AND INTENT**

The Contractor shall furnish all materials, labour, operations, equipment, tools,

plant and incidentals necessary and required for the completion of all metal work in connection with railing and window and other items of metal work as called for in the drawings. The supplying of additional fastenings, accessory, features and other items not mentioned specifically herein but which are necessary to make a complete installation shall be part of this contract.

## **2. GENERAL**

All structural steel shall conform to M-19. All metal work shall be free from defects impairing strength, durability and appearance and shall be of the best commercial quality for purposes specified. Made with structural properties to withstand safely strains, tresses to which they shall be normally subjected.

## **3. SAMPLES**

Samples of all typical metal work, such as windows glazing, flashing railing etc., shall be fabricated, assembled and erected or submitted to the EIC as directed by him, for his approval.

## **4. APPROVED MANUFACTURERS**

All floors, windows, railings and other work shall be manufactured by an approved manufacturer / fabricator. The entire work shall be carried out by workmen skilled in this kind of work in a shop fully equipped to carry out all phases of fabrication in accordance with the best accept practices.

## **5. FITTINGS**

Hinges, locks, handles, stays and other fittings shall be provided as called for in the schedule of hardware / drawings.

## **6. FIXING**

The Contractor shall fix windows, etc., in prepared openings. Steel window frames, wherever possible, shall be fixed in place before erecting partitions. Where this is not possible, prepared openings shall be left for hold-fasts. Breaking of partitions or walls for fixed to column / wall faces they shall be fixed with raw bolts / expansions bolts of approved make in approved manner.

The Contractor shall be responsible for assembling composites, bedding and pointing with mastic inside and outside at the mullions and transoms, fixing lugs to the frames, placing the windows in their respective openings and bedding with mastic. The Contractor shall be responsible for all builder's work including



all cutting out and making good, forming fixing holes for inserting loose lugs, bolts and clips and for stacking of windows, adjacent to the opening for necessary hoisting. The Contractor shall be responsible for the windows being set straight, plumb and level and for their satisfactory operation after operation after the fixing is complete.

## **7. FABRICATION AND RAILING**

Mild steel and other types of fabrication & railing called for on the drawings shall be executed by craftsmen specially trained in the trade in a shop fully equipped to carry out all phases of fabrication in accordance with the best accept practices and as shown on the drawings. All work, as far as possible shall be shop fabricated and brought on site for erection. The railings shall be assembled square true to proper plan or curved to the radius shown on the drawings. Joining methods shall be flush type designed to produce an adequately strong for a particular application, and approved by the EIC.

Welding shall be executed from the non-exposed side, as far as possible and in each case the welds shall be ground smooth and finished with a texture matching the parent metal. All welds shall be finished smooth and square.

## **8. PAINTING**

### **Painting of Steel Work/Metal workMaterials**

- Red-oxide – zinc chrome primer shall conform to IS:2074.
- Synthetic enamel paint shall conform to IS: 2932.
- Aluminum paint shall conform to IS:2339.

All the materials shall be of the best quality from an approved manufacturer. Contractor shall obtain prior approval of the LOCAL BODY for the brand of manufacture and the colour/shade. All the materials shall be brought to the site in sealed containers.

### **Workmanship**

Painting work shall be carried out only on thoroughly dry surfaces. Painting shall be applied either by brushing or by spraying. Contractor shall procure the appropriate quality of paint for this purpose as recommended by the manufacturer. The workmanship shall generally conform to the requirement of IS:1477 (Part 2).

The type of paint, number of coats etc. shall be as specified in the respective items of work.

Primer and finish paint shall be compatible with each other to avoid cracking and wrinkling. Primer and finish paint shall be from the same manufacturer.

All the surfaces shall be thoroughly cleaned of oil, grease, dirt, rust and scale. The methods to be adopted using solvents, wire brushing, power tool cleaning etc., shall be as per IS:1477 (Part - I) and as indicated in the item of work.

It is essential to ensure that immediately after preparation of the surfaces, the first coat of red oxide-zinc chrome primer shall be applied by brushing and working it well to ensure a continuous film without holidays. After the first coat becomes hard dry, a second coat of primer shall be applied by brushing to obtain a film free from holidays.

After the second coat of primer is hard dry, the entire surface shall be wet rubbed cutting down to a smooth uniform surface. When the surface becomes dry, the undercoat of synthetic enamel paint of optimum thickness shall be applied by brushing with minimum of brush marks. The coat shall be allowed to hard-dry. The under coat shall then be wet rubbed cutting down to a smooth finish, taking adequate care to ensure that at no place the undercoat is completely removed. The surface shall then be allowed to dry.

The first finishing coat of paint shall be applied by brushing and allowed to hard-dry. The gloss from the entire surface shall then be gently removed and the surface dusted off. The second finishing coat shall then be applied by brushing.

At least 24 hours shall elapse between the application of successive coats. Each coat shall vary slightly in shade and this shall be got approved by the LOCAL BODY.

**Item No. 41 : Providing and fixing pre-cast Rubber Dye / steel Dye inter locking concrete block 60mm thick with grade of concrete M 300 pneumatic compressed / vibrated mechanically and as per approved design Confirming to IS 15658: 2006 including 35 mm Sand layer for levelling and filling the joint with sand in proper line and level as per guidelines of IRC: SP 63-2018 etc. Complete.**

**Item No. 42 : Providing and fixing pre-cast concrete kerb stone of Gray cement based concrete block 30cm length, 30cm height and 15cm thick**

**of M200 grade concrete as per approved design and including excavation for fixing in proper line and level, filling the joint with C:M 1:3 (1 cement : 3 fine sand) etc. complete.**

**1.0 Description:**

The work shall consist of constructing a floor consisting of sub base layers, rubber die glossy finish C.C. paver blocks of required shape, size colour & shade and precast C.C. kerb stones to proper line and level to the requirements of these specifications.

**2.0 Materials:**

**2.1 Excavation** for Precast Block and floor shall be carried out as per Item No.4.0.0 (a)Page No.21 of G.T.S. for Building Works.

**2.3 Paving Blocks.**

The paving Blocks shall be precast 65mm thick in M-25 C.C. of shape and size and colour as directed by Engineer in Charge. The paver blocks should be rubber die glossy finish machine cast in appropriate plant having facility for applying high pressure and controlled vibration. For normal paving work, the length of a paving block should ordinarily be not greater than twice the mean width; the thickness is a minimum 65mm; the maximum length generally not exceeding 280mm; the width generally in the range of 75 to 140mm with a maximum chamfer of 10mm (preferably chamfer should be in the range of 3- 5mm). The sides of the block should be perpendicular to the top and bottom faces except that the top edge may be chamfered. The blocks should have the following dimensional tolerances:

Plan dimensions  $\pm 2$ mm Thickness  $\pm 3$ mm.

The Cement used shall be any one of the following:

- (a) 43 grade ordinary Portland cement conforming to IS 269
- (b) 53 grade ordinary Portland cement conforming to IS 8112.

Coarse aggregates shall comply with the requirements of IS 383. As far as possible crushed /semi crushed aggregates shall be used. For ensuring adequate durability, the aggregate used for production of blocks shall be sound and free of soft or honeycombed particles. The nominal maximum size of coarse aggregate used in production of paver blocks shall be 12 mm.

Fine aggregates shall conform to the requirements of IS 383. Both River/quarry sand and stone dust meeting the requirements can be used.

**Pigments:** Synthetic or natural pigments may be used in concrete mix to obtain paver blocks with desired shades of colors. The pigment used should result in durable colors of paver blocks. It shall not contain matters detrimental to concrete. Pigments, either singly or in combination, conforming to the following I.S may preferably be used.

- (a) Black or Red or Brown pigment                      IS: 44
- (b) Green pigment    IS: 54
- (c) Blue pigment    IS: 55/56
- (d) White pigment    IS: 411
- (e) Yellow pigment     IS: 50

The pigment should be finer than the cement. The pigment shall not contain zinc compounds or organic dyes.

The rubber die glossy finish paver blocks shall be of M-25 grade having compressive strength at 28 days of 25N/mm<sup>2</sup> and necessary testing shall be carried out to maintain the required compressive strength.

To ensure durability, the average water absorption in a block should not exceed 5%. In situations, where parts of blocks are to be used e.g. around manholes, the block should be purpose cut at site.

#### **2.4 Bedding Sand /stone dust**

The Bedding sand/stone dust should be free of deleterious materials. The thickness of the bedding layer should be as shown in the drawing and should be of uniform thickness. The grading of the bedding sand should be as under:

<b>IS Sieve Size</b>	<b>Percent Passing</b>
9.52 mm	100
4.75 mm	95-100
2.36 mm	80-100
1.18 mm	50-95
600 microns	25-60

300 microns	10-30
150 microns	0-15
75 microns	0-10

## 2.5 Joint Filling Sand

The gaps in between two paving blocks (not more than 3mm) shall be filled relatively finer than the bedding sand. The joint filling sand should be as dry as possible. The gradation for the joint filling sand is as under.

IS Sieve Size	Percent Passing
2.36 mm	100
1.18 mm	90-100
600 microns	60-90
300 microns	30-60
150 microns	15-30
75 microns	0-10

## 3.0 Construction

### 3.1 General

The construction of block pavement involves preparation of sub-grade, sub base and base course layers, bedding sand and finally the laying of blocks.

### 3.2 Preparation of Sub grade

This is the foundation layer on which the block pavement is constructed. The water table should be at a minimum depth of 600mm below the sub-grade should be compacted in layers of 150- or 100-mm thickness as per IRC: 36-1970. The prepared sub grade should be graded and trimmed to a tolerance of +/- 20 mm of the design levels, and its surface evenness should have a tolerance of within 15 mm under a 3 m straight edge.

### 3.3 Base and Sub base Course

Base and Sub base courses are constructed in accordance with standard procedure contained in the relevant IRC specifications like IRC: 37-2001. The material shall be evenly laid in required thickness as specified in drawing and shall be watered, and consolidated to provide proper level and grade.

### **3.4 Placing and Screening of Bedding Sand**

The thickness of the sand bed after compaction should not be more than 50 mm. Bedding sand should not be used to fill up local depressions on the surface of a base or sub base. The depressions should be repaired in advance before placing sand. Sand to be used should have uniform moisture content of 6 to 8%.

The processed sand is spread with the help of screed boards to the required thickness.

The Screed boards are provided with nails at 2-3m apart which when dragged gives the desired thickness. The sand is subsequently compacted with plate vibrators weighing 0.6 tons or more. Level checks shall be carried out on a grid pattern to establish that the desired level is achieved. Local correction can be done either by removing or adding extra sand followed by leveling and compacting the layer.

### **3.5 Laying of Blocks**

Blocks should be laid commencing from the edge strip and proceed towards the inner side. The blocks can be placed to different bonds or patterns as directed by Engineer in Charge. With the help of gauges, the joint width specification (2 to 4mm) should be checked in the first few square meters, where it should be ensured that the block alignment is correct. To start with, full blocks should be used; only subsequently, cutting and in filling at edges be permitted. Under no Circumstances should the blocks be forced or hammered into the bedding at this stage of lying. For cutting paving blocks, hydraulic or mechanical block cutters, or power saws are used. Cut units less than 50mm minimum dimension should not be used. Where space does not permit use of a larger segment, use premixed concrete or sand – cement mortar instead. The blocks shall be laid in line and level and to required camber.

### **3.6 Compaction**

For compaction of the bedding sand and the blocks laid over it, vibratory plate compactors are used over the laid paving units; at least two passes of the vibratory plate compactor are needed. Such vibratory compaction should be continued till the top of each paving blocks is level with its adjacent blocks.

### **3.7 Joints filling**

The joints should be completely filled with dry sand. The operation of joint

filling comprises of spreading a thin layer of the joint filling sand on the block surface and working the sand into each joint by brooming. Following this, passes of heavy plate compactor are applied to facilitate fine sand to fill the joints. The sand should be broomed or spread over the surface with a small surcharge.

### **3.8 Opening for use**

Until all the joints are completely filled, no usage should be permitted over the blockpavement. The block pavement should be inspected frequently, to ensure that any

incompletely filled joints, exposed by usage and/or weather are promptly filled. Such frequent inspection should be continued till dust and detritus from the roadway tightens the surface of the joints.

### **3.9 Arrangement for traffic**

The Contractor shall at all times carry out work on the site in a manner creating least interference to the flow traffic and pedestrians, while consistent with the satisfactory execution of the work.

### **4.0 Measurements for payments:**

The work of footpath shall be measured as finished work in position in square meters and the rate shall include leveling and preparation of sub-grade, procuring, spreading and compacting of sub base and base material, supplying and fixing of precast paver blocks in required shape and pattern and filling the joints with sand and compacting using all tools, equipment's materials and labour. Payment for B.B.C.C & sand bedding shall be paid include under corresponding item of tender however filling the joints with sand shall not be paid separately but it is included in the payment of current item.

Rate shall be for a unit of one square meter.

**Item No. 37 : Finishing wall with base coats of wall primer of approved brands and above weather proof exterior emulsion paint on wall surface (Two coats) to give a required shape even shade after thoroughly brushing the surface to remove all dirt, and remains of loose powdered materials etc. complete**

**Item No. 38 : Applying Two coats of Birla or Asian Acrylic Lappy (putty) and two coats of primer of approved brand and manufacture on new wall surface to give an even shade including thoroughly**

**brushing the surface free from mortar dropping and other foreign matter and sand papered smooth.**

**Item No. 39 : Wall painting (two coats) with plastic emulsion paint of approved brand and manufacture on undecorated wall surface to give an even shade including thoroughly brushing the surface free from mortar dropping and other foreign matter and sand papered smooth**

**Item No. 40 : Painting two coats (including priming coat) on new steel and other metal surface with enamel paint, brushing, interior to give an even shade including cleaning the surface an even shade including cleaning the surface of all dirt, dust and other foreign matter.**

## **COLOR WORK**

### **1. EXTENT AND INTENT**

The Contractor shall supply all materials, labour, tools, ladders, scaffolding and other equipment necessary for the completion and protection of all painting / finishing work. Painting & finishing, as herein specified shall be applied to all surfaces requiring painting / finishing throughout the interior and exterior of the buildings as given in the schedule of finishes or elsewhere. The painting / finishing shall be carried out by a specialist sub- Contractor, approved by the EIC.

### **2. STORAGE**

Storage of materials to be used on the job shall be, only in a single place approved by the EIC. Such storage place shall not be located within any of the buildings included in the contract.

### **3. MATERIALS**

Materials used in the work shall be of manufacture approved by the EIC, Ready mixed paints, varnishes, enamels, lacquers, stains, paste fillers, distempers and other materials must be delivered to the job site in the original containers, with the seals unbroken and labels intact. Each container shall give the manufacturer's name, type of paint, color of paint and instructions of reducing. Thinning shall be done only in accordance with directions & manufacturer's specification. Remove rejected materials immediately from the premises.



#### **4. SHADES**

All shades, as provided in the shade schedule, shall be approved by the EIC. The Contractor shall as far as possible use pre-mixed manufacturer's shades and shall prepare sample of the shades selected and submit same for approval by the EIC. No work is to proceed until the EIC has given his approval, preferably in writing, of the shade samples.

#### **5. COMMENCEMENT OF WORK**

Painting / finishing shall not be started until the surfaces to be painted / finished are in a condition fit to receive painting / finishing and so certified by the EIC.

Painting / finishing work shall be taken in hand only after all other civil work is completed. Buildings where painting / finishing work is to commenced shall be thoroughly swept and cleaned up before commencement of painting / finishing.

#### **6. SCAFFOLDING**

Only double scaffolding having two sets of vertical supports shall be provided for all, painting / finishing work. The supports shall be tied together with horizontal pieces over which the scaffolding planks shall be fixed. All the vertical and horizontal members of the scaffolding shall be placed sufficiently away from the surfaces to be painted to ensure proper and unit erupted application.

#### **7. WORKMANSHIP**

The workmanship shall be of the very best; all materials evenly spread and smoothly flowed as without running sags, using good quality tools, brushes, etc., as required. Only skilled painters / applicators shall be employed. A properly qualified foreman shall be constantly on the job whilst the work is proceeding. All surfaces to be painted / finished shall be cleaned free of all loose dirt and dust before painting / finishing is started. All work where a coat of material has been applied must be inspected and approved before application of the succeeding specified coat. Each undercoat shall be distinct shade of the approved color.

Before painting / finishing, remove hardware, accessories, plates and similar items or provide portion to all such items. Upon completion of each space, replace all fixtures removed. Remove doors if necessary to paint bottom edge. Use only skilled mechanics for the removal and replacement of above items.

#### **8. CONCEALED SURFACES**

All interior and exterior trim, door frames, doors, shelving, cabinet work shall be thoroughly and carefully back painted as all surfaces and edges which will be concealed when installed. Such surfaces shall be clean, dry, sanded and properly prepared to receive the paint. Tops, bottom and edges of doors shall be finished same as the rest of the door.

**9. PROTECT AND CLEAN**

The agency shall protect not only his own work at all times, but shall also protect all adjacent work and materials by suitable covering during progress of his work. Upon completion of his work, he shall remove all paint and varnish spots from floors, glass and other surfaces. Any defaced surfaces shall be cleaned and the original finish restored. He shall remove from the premises all rubbish and accumulated material and shall leave the work in clean, orderly and acceptable conditions.

**10. PREPARATION OF SURFACES**

**PLASTER WORK:** Fill all holes, cracks and abrasions with plaster of paris / cement slurry as directed, properly prepared and applied and smoothed off to match adjoining surfaces. Do not use sand paper on plaster surfaces. Plaster shall be allowed to dry for at least 12 (twelve) weeks before the application of paint / finishes.

**STEEL AND IRON:** All surfaces shall be washed with mineral spirits to remove any dirt or grease before applying paint. Where rust or scale is present, it shall be wire brushed and sand papered clean. All cleaned surfaces shall be given one coat of approved phosphate before prime coat in accordance with the manufacturers, Instructions. Shop coats of paint that have become marred shall be cleaned off, wire brushed, and spot primed over the affected areas.

**11. APPLICATION**

The paint shall be continuously stirred in the container so that its consistency is kept uniform throughout. The painting / finishing shall be laid on evenly and smoothly by means of crossing and laying off, the latter in the direction of the grain of the wood. The crossing and laying off consists of covering the area with paint, brushing the surface hard for the first time and then brushing alternatively in opposite directions, two or three times and then finally brushing lightly in a direction at right angles to the same. In this process no brush marks shall be left after the laying off is finished. The full process of crossing and

laying off will constitute one coat.

Where so stipulated, the painting / finishing shall be carried out using spray machines suited for the nature and location of the work to be carried out. Only skilled and experienced workmen shall be employed for this class of work. Paints used shall be brought to the requisite consistency by adding a suitable thinner. Spraying shall be carried out only in dry conditions. No exterior painting / finishing shall be done in damp foggy or rainy weather. Surface to be painted shall be clean, dry, smooth and adequately protected from dampness. Each coat shall be applied in sufficient quantity to obtain complete coverage, shall be well brushed and evenly worked out over the entire surface and into all corners, angles and crevices allowed to thoroughly dry. Second coat shall be of suitable shade to match final color, and shall be approved by the EIC before final coat is started. Allow at least 48 hours drying time between coats for interior and 7 days for exterior work, and if in the judgment of the EIC more time is requested it shall be allowed. Finished surfaces shall be protected from dampness and dust until completely dry. Finished work shall be uniform of approved color, smooth and free from runs, sags, defective brushing and clogging. Make edges of paints adjoining materials of colors sharp and clean, without overlapping.

In order to achieve a superior finished surface, putty paste fillers shall be used on, all surfaces to be painted. To fill pores, dents, etc. The putty / paste fillers shall be approved quality and manufacture and shall be applied to the surface with a knife or other sharp-edged tools after the priming coat as well as after each undercoat. The surface, after filling with putty / paste tiller, shall be rubbed down with fine sand paper and dusted off before the application of the subsequent coat.

Paste wood filler when set shall be wiped across the grains of the wood and then with the grain to secure a clean surface. Surface to be stained shall be covered with uniform coat of stain wiped off if required.

**FINISH:** The painted surfaces shall be finished to require texture. Matt finish shall be achieved by use of sponge rollers or stippling brushes as called for.

## **12. TYPES OF PAINT FINISHES**

### **12.1 ENAMEL PAINTS:**

Non-Galvanized Steel Surfaces: Coat of red oxide primer after phosphate followed by the three or more coats of synthetic enamel paint. Paste filler to be

applied after every coat excepting final finishing coat and sanded.

## **12.2 WHITE WASHING**

White Washing with lime on decorated wall surfaces (two coats) to have given an even shade including thoroughly booming the surface to remove all dirt, dust, mortar drops and other foreign matter.

## **12.3 MATERIALS:**

The clear collie shall be made from glue and boiling water by Mixing 1 Kg. Mixture shall be suitably tinted where required for use under colored distemper if directed. Glue shall conform to I.S. 852-1969 (Specifications for animal glue). 1.2 Lime used shall be freshly burnt glass 'C' Lime (fat lime) and white in color conforming to I.S. 712-1973. Best quality of gum shall be used in the preparation of white wash. Ultramarine blue or Indigo: This shall conform to I.S. 55-1970 for points, and shall be used for preparation of white wash, Pigments: Mineral colors, not affected by lime shall be used in preparing color wash.

## **12.4 WORKMANSHIP:**

Preparation of white wash solution:

Surface already white or color. The fat lime shall be slaked at site and shall be mixed and stirred with about five liters of water for 1 Kg. Have unslaked lime to make a thin cream. This shall be allowed to stand for a period of 24 hours and then shall be screened through a clean coarse cloth, 4 Kg. of gum dissolved in hot water shall be added to each cubic meter of lime cream. Small quantity of ultramarine burnt \*Up to 3 gms. Per Kg. Of lime) shall also be added to the last two coats of white wash solution and the whole solution shall be stirred thoroughly before use.

## **12.5 PREPARATION OF SURFACE:**

The surface shall be thoroughly cleaned of all dust, dirt, mortar cropping and other foreign matter before white wash is to be applied.

The surface spoiled by smoke soot shall be scrapped with steel wire brushes or steel scrapers or shall be rubbed with over burnt surkhi or brickbats. The surface shall be then boomed to remove all dust, dirt and shall be washed with clean water.

Oil or grease spots shall be removed by suitable chemical and smooth surface shall be rubbed with wire brushes.

All unsound portion of the surface plaster shall be removed to full depth of plaster in rectangular patches and plastered again after raking the masonry joints properly. Such portion shall be wetted and allowed to dry. They shall then be given one coat of white wash.

All unnecessary nails shall be removed; the holes cracks patches etc. shall be made good with materials similar in composition to the surface to be prepared.

### **12.6 SCAFFOLDING:**

Wherever scaffolding is necessary it shall be erected in such a way that as far as possible on part of scaffolding shall rest against the surface to be white or color washed. A properly secured strong and well-tied suspended platform (Zoola) may be used for white washing. Where ladders are used, pieces of old gunny bags shall be tied at top and bottom to prevent scratches to the floors and walls. For white washing of ceilings proper stage scaffolding shall be erected where necessary.

### **APPLICATION OF WHITE WASH:**

On the surface so prepared the white wash shall be applied with "Moon" brush. The first stroke of the brush shall be from top-down wards, another from bottom upwards over the first stroke and similarly one stroke from the right another from the left, over the first stroke brush before it dries. This will form one coat. Each coat shall be allowed to dry before next coat is applied. Number of coats as specified in item shall be applied. It shall present smooth and uniform finish free from brush marks and it should not come off easily when rubbed with finger.

Splashing and dropping if any on the doors and windows, ventilators etc. shall be removed and the surface cleaned.

Priming and Alkali resistant treatments, scraping of surface washing etc. surface spoiled by smoke soot removed of oil and grist spots treatment for infection with efflorescence moulds moss, fungi algae and lichens and patch repairs to plaster wherever done shall not be paid extra.

### **12.7 WATER PROOF CEMENT PAINT**

Water proof cement paint shall be of approved brand (like Snowcem etc.) and manufacture and of required shade, enlisted by the Consultant / Engineer-in-charge.

**PREPARATION OF SURFACE:**

For new work, the surface shall be thoroughly cleaned of all mortar dropping, dirt, grease and other foreign matter by rushing and washing. The surface shall be wetted by a sprinkling of water or water with fine spray. The surface shall be sprayed several times with a few minutes' intervals between each spraying to allow moisture to soak into the surface.

**PREPARATION OF MIX:**

Waterproof cement paint shall be mixed in such quantities as can be used up within an hour of its mixing as otherwise the mixture will set and thicken, affecting flow and finish. Waterproof cement paint shall be mixed with water in two stages. The first stage shall comprise of two parts of water stirred thoroughly and allowed to stand for five minutes, care shall be taken to add the water proof cement paint gradually to the water and not vice- e-versa. The second stage shall comprise of adding further one part of water to the mix and stirring thoroughly to obtain a liquid of workable and in uniform consistency. In all cases the manufacturer's instructions shall be followed meticulously.

The lids of cement paint drums shall be kept tightly closed when not in use, as by exposure to atmosphere the cement paint rapidly becomes air set due to its hydroscopic qualities.

**APPLICATION:**

The solution shall be applied on the clean and wetted surface with hairbrushes or spraying machine. The solution shall be kept well stirred during the period of application. It shall be applied on the surface, which is under shadow of the building so that the direct heat of the sun on the surface is avoided. The method of application of waterproof cement paint shall be similarity to oil bound distemper. The completed surface shall be watered after the days work. After the first coat of paints has hardened, it shall be wetted again before the application of second coat, at least 24 hours should elapse between the two coats. The watering should be done at least for seven days till the paint gets required strength. For new work, the surface shall be treated with three or more coats of waterproof cement paint as found necessary to get a uniform shade.

## **Water Supply, Plumbing and Sanitary Fittings**

### **Item No. 48: Providing and fixing Gun metal check or non-return full way wheel valve. (E) 40mm Dia**

#### **1.0. Materials:**

1.1. The gun metal check or non-return full way wheel valve of specified dia. shall conform to I.S. 778-1964. The non return valve shall be of tested quality.

#### **2.0. Workmanship:**

2.1. The gun metal check or non-return valve shall be fully cleared of all foreign matter before fixing. The fixing of valve shall be done by means of bolts nuts and 3 mm. rubber insertions with flanges of spigot and socketed tail pieces, drilled to the same specification as in case of socket and spigot and with flanges in case of flanged pipes. The jointing shall be done leak proof.

#### **3.0. Mode of measurements & payment:**

3.1. The rate includes all labour, materials, tools and plant etc. required for satisfactory completion of this item.

3.2. The rate shall be for a unit of one number.

### **Item No. 52: Providing and fixing 600 mm. X 450 mm. Beveled edge mirror of superior glass mounted on 6 mm. Thick A.C, sheet or plywood sheet and fixed to wooden plugs with C.P. brass screws and washers**

#### **1.0. Materials:**

1.1. The 600 x 450 mm. size mirror shall be of superior glass with edge rounded off or beveled as specified. It shall be free from flaws specks, or bubbles and its thickness shall not be less than 6 mm. The glass for the mirror shall be uniformly silver plated at the back and shall be free from silvering defects. Silvering shall have a protective uniform covering of red-lead paint. The 6 mm. thick plywood shall conform to M-37.

1.2. The 6 mm. thick A. C. Sheets shall conform to M-24.

#### **2.0. Workmanship:**

2.1. The mirror of 500 mm. x 450 mm. size mounted on A. C. sheet or plywood 6

mm. thick with C. P. brass clips shall be fixed as directed, by fixing wooden plugs in wall and C. P. brass screws and washers. The work shall be carried out in best workman like manner.

**3.0. Mode of measurements & payment:**

**3.1.** The rate includes cost of all labour and materials, tools and plant etc. required for satisfactory completion of this item. The rate shall be for a unit of one number.

**Item No. 56: Providing and fixing C.P. brass waste for wash basin or sink (A) 32mm Dia**

**1.0. Materials:**

**1.1.** The C. P. brass waste trap and unions shall be of 32 mm. dia. and of best quality and make as approved by the Engineer-in-charge.

**2.0. Workmanship:**

**2.1.** C. P. brass waste trap and union shall be connected to 32 mm. dia. waste pipe which shall be suitably bent towards the wall and which shall discharge into drain through a floor trap. The C. P. brass waste trap shall be provided for wash basin or sink as the case may be.

**3.0. Mode of measurements & payment:**

**3.1.** The rate includes all labour and providing C.P. brass waste trap and union including waste coupling of 32 mm. dia. The rate excludes the cost of waste pipe of 32 mm. dia.

**3.2.** The rate shall be for a unit of one number.

**Item No. 57: Providing and fixing water closet squatting pan (European Type W.C. Pan) size 580 mm. (Earth work, Bed concrete foot rests and trap to be measured and paid for separately.) (A) Vitreous china (I) Long pattern white colour**

**1.0. Materials:**

Wash down water closet (European type W.C. Pan) shall conform to M-60. Cement mortar shall conform to M-11.

**2.0. Workmanship:**



Closet shall be fixed to the floor by means of 75 mm. long 6.5 mm. diameter counter sunk bolts and nuts embedded in the floor concrete using rubber or fiber washers so as not to allow any lateral displacement. The joint between the trap of W.C. and soil pipe shall be made with C.M. 1 : 1 (1 cement : 1 fine sand)

**3.0. Mode of measurements & payment:**

**3.1.** The rate shall include the cost of all labour for fixing pans and seat and cover, inlet, connections etc. complete including testing the same.

**3.2.** The payment of seat and cover shall be made separately.

**3.3.** The rate shall be for a unit of one number.

**Item No. 58: Providing and fixing urinal approved quality connecting the urinal with waste pipe, trap etc. complete (A) White earthen ware flat back or corner type size 430mm x 260mm x 350 mm**

**1.0. Materials:**

**1.1.** The white earthenware flat pack or corner type urinal of size 430 mm. 260 mm. x 350 mm. shall conform to M-64.

**2.0. Workmanship:**

**2.1.** The urinals shall be fixed in position by using wooden plugs and screws and shall be at a height 65 cms. from the floor level to the top of the lip or urinal, unless otherwise directed. The wooden plugs shall be 50 mm. x 50 mm. at base lapping to 38 mm. x 38 mm. at top and 50 mm. in length shall be fixed in wall in cement mortar 1 : 3 (1 cement : 3 coarse sand). The urinal shall be connected to 32 mm. dia. galvanized mild steel waste pipe which shall discharge in the channel or floor trap. The connection between the urinal and flush or waste pipe shall be made by means of putty or white lead mixed with chopped hemp.

**3.0. Mode of measurements & payment:**

**3.1.** The rate includes cost of all labour, materials, tools and plants etc. required for satisfactory completion of this item.

**3.2.** The rate shall be for a unit of one number.

**Item No. 59: Providing and fixing washbasin with single hole for pillar tap with C.I. or M.S. brackets painted white including shutting holes and making good the same but excluding fittings. (A) Vitreous China**

**1.0. Materials:**

**1.1.** The white glazed earthenware wash basin shall be 550 cm. x 400 mm of 1st quality and make as approved by the Engineer-in-charge. The wash basin shall conform to M-59.

**2.0. Workmanship:**

**2.1.** The wash basin shall be fixed on the wall as and where directed. The wash basin shall be supported on a pair of M. S. or C.I. brackets fixed in C.M. 1 : 3 (1 cement : 3 sand). The bracket shall conform to I. S.: 775-1962. The wall plaster on the rear shall be cut to rest the top edge of the wash basin. After fixing the basin, plaster shall be made good and surface finished matching with the existing one.

**2.2.** The bracket shall be painted white with ready-mixed paint.

**2.3.** The C.I. brass trap and union shall be connected to 32 mm. dia. waste pipe which shall be suitably bent towards the wall and which shall discharge into an open drain leading to a gully trap or direct into the gully-trap on the ground floor and shall be connected to a waste pipe through a floor trap on the upper floors. C. P. brass trap and union may not be provided where the surface drain or a floor trap is placed directly under the basin and the waste is discharged into vertically.

**2.4.** The height of the front edge of the wash basin from the floor level shall be 80 cms.

**2.5.** The necessary inlet, outlet connections and fittings such as pillar cocks. C. P. dress waste trap waste pipe, stop cock, chain wish rubber plug etc. shall be fixed.

**2.6.** The payment of fittings shall be made separately under separate item.

**3.0. Mode of measurements & payment:**

**3.1.** The rate includes cost of all labour, materials; tools and plant etc. required for satisfactory completion of this item as specified in workmanship.

**3.2.** The rate shall be for a unit of one number.

**Item No. 60: Providing and fixing screw down bib taps of following size:  
(A) Brass screw down bib tap polished bright (I) 15mm dia.**

**1.0. Materials:**

**1.1.** 15 mm. dia. brass screw down with bright polished finish shall conform to I.S. 781-1977. The bib cock shall be best Indian make and quality.

**2.0. Workmanship:**

**2.1.** The screw down bib cock 15 mm. dia. as specified above shall be fixed as directed. The threaded portion shall be smeared with white or red lead and around with a few turns of fine-spun yarn round the screwed end of the pipe. The bib cock shall be than screwed and fixed to water tight position.

**3.0. Mode of measurements & payment:**

**3.1.** The rate includes cost of all labour, materials, tools and plant etc. required for satisfactory completion of this item.

**3.2.** The rate shall be for a unit of one number.

**Item No. 65 TO 70: Providing laying and jointing in true line and level dia. U.P.V.C. Pipe (SCH- 40) for cold water including fittings make PRINCE / SUPREME / ASTRAL / FINOLEX or equivalent as approved by Engineer In Charge. Pipe shall be fixed on the wall with the help of clamp at every two-meter C/C or shall be concealed as directed including necessary fittings etc. including testing of pipe and joints and fixing the same with adhesive solvent, including cost of all materials. (1) 40mm (2) 25mm (3) 50mm (4) 32mm (5) 15mm (6) 110mm**

**1.0. Materials**

**1.1.** The U.P.V.C. pipe of specified diameter with 10 Kg/Sq. Cm, working pressure shall conform to I.S. 3076-1968. The specials and fittings required shall be of best quality.

**2.0. Workmanship**

- 2.1.** The P.V.C. pipes of specified diameter shall be fixed as directed. Due to thermal expansion of rigid 'P.V.C. pipes, due allowance shall be made particularly in over ground pipe lines for any change in length of pipe line which may occur during installation or when pipe line which may occur during installation or when pipe line is in service.
- 2.2.** Above ground installation of rigid P.V.C. pipe should be under taken after preparations are observed for their protection against direct sun rays and mechanical damage.
- 2.3.** The rigid P.V.C. pipe lines should not be kept exposed above ground when it passes through public places, railway lines, road side and foot paths.
- 2.4.** P.V.C. pipes shall be supported at the following intervals:  
-20 mm. dia 50 mm. -25 mm. dia 75.mm. -32 mm. dia. 100 mm.
- 2.5.** Closer support spacing shall be provided if recommended by the manufacture.
- 2.6.** The guide lines indicated by the manufacturer regarding handling, transportation, storing, laying and jointing pf pipes shall be kept in view during execution.
- 2.7.** P.V.C. pipes shall be fixed on wall with wooden plugs and suitable plastic clamps.
- 2.8. Jointing the pipes:**
- 2.8.1.** The pipes and sockets shall be accurately cut. The ends of the pipes and fittings should be absolutely free from dirt and dust. The outside surface of the pipes and the inside of the fittings shall then be roughened with emery paper, and then solvent cement joint. Since solvent cement is aggressive to P V.C. care must be taken to avoid applying excessive cement to the inside of pipe sockets as any surplus cement cannot be wiped of after jointing. Empty solvent cement tins, brushes, rags, or paper impregnated with cement should not be buried in the trenches. They should be gathered not left scattered about, as- they can prove to be a hazard to animals, which may chew them.
- 2.8.2.** If any manufacturer recommends its own methods of jointing the same shall be adopted after necessary approval from the Engineer-in-charge.
- 2.9. Laying pipes in Trenches:**

**2.9.1.** The pipes shall be laid over uniform relatively soft fine trained soil found to be free of presence of hard object such as large flints, rocky projections, large tree roots etc. The width of the trenches shall be minimum width required for working.

**2.9.2.** The pipes laid underground shall not be less than one meter from the ground level. The pipe shall be positioned in the trenches so as to avoid any induced stressed due to deflection. Any deviation required shall be obtained by using proper type of rubber ring joints.

### **3.0. Mode of measurements & payment**

**3.1.** The description of e, item shall, unless otherwise stated be held to include where necessary. conveyance, and delivery, handling, unloading, storing fabrication, hoisting, all labour for finishing to required shape and size, setting, fitting in position straight, cutting and waste return of packing etc.

**3.2.** The length shall be measured on running meter basis of finished work. The length shall be taken along the center line of the pipe and fittings. The pipes fixed to wall, ceiling. floors etc. shall be measured and paid under this item.

**3.3.** All the work shall be measured in decimal system as fixed in its place, subject totolerance given below unless otherwise stated.

(i) Dimension shall be measured to the nearest 0 01 meter.

(ii) Area shall be worked out tothe nearest 0.01 sq. meter.

**3.4.** All measurements of cutting shall unless otherwise stated by held to include the consequent waste

**3.5.** In case of fitting of unequal bore, the targets bore shall be measured for the test.

**3.6.** Testing of pipe lines fittings, and joints include for providing all plant appliances necessary for obtaining access to the work to be tested an carrying out the tests

**3.7.** The rate includes galvanized steel tubing with screwed socket joints. to gather with all fittings (such as bends, sockets springs, elbows, test, crosses, short pieces, clamps and plugs, unions etc.) and fixing complete with clamping wall hooks, wooden plug etc. and also curing, screwing and waste and for making forged (or handmade) bends on piping as required. Connector shall be inserted where required or directed. The rate also includes cutting through walls, floors

etc. and their making good and painting exposed threads with anti-corrosive paint as above and testing where tubes are to be fixed to wall ceiling and flooring, the rates shall not include painting of pipes, providing sleeves and sand filling under floor for which separate payment shall be made.

**3.8.** The rate shall be for a unit of one running meter.

**Item No. 71: Providing and fixing PVC SWR Nahni trap IS 14735 for drain - 100 mm diameter with Jali of the following nominal diameter of self-cleansing design with C.I screed down or hinged grating including the cost of cutting and making good the walls.**

**M-69: Nahni Trap:**

**69.1.** Nahni trap shall be of cast iron and shall be sound and free from porosity or other defects which affect serviceability the thickness of the base metal shall not be less than 6.5 mm. The surface shall be smooth and free from craze, ships and other flaws or any other kind of defects which affect serviceability. The size of nahni trap shall be as specified and shall be of self-cleaning design.

**69.2.** The Nahni trap shall be of quality approved by the Engineer-in-charge and shall generally conform to the relevant Indian Standards.

**69.3.** The Nahni trap provided shall be with deep seal, minimum 50 mm, except at places where trap with deep seal cannot be accommodated. The cover shall be cast iron. Performed cover shall be provided on the trap of appropriate size.

**Item No. 72: Providing and fixing Kitchen sink with C.I. or M.S. brackets, painted white including cutting holes in walls and making good the same but excluding fittings. (C) Vitreous China Sink. (i) 600mm x 450mm x 150mm size**

**1.0. Materials:**

**1.1.** White glazed vitreous china sink 600 mm. x 450 mm. x 150 mm. size shall conform to M-63.

**2.0. Workmanship:**

**2.1.** The kitchen sink shall be supported on a pair of M.S. or C.I. brackets fixed in cement mortar 1: 3 (1 cement: 3 coarse sand). The M.S. or C.I. brackets shall conform to I.S. 775-1972. The wall plaster on the rear shall be cut to rest over the top edge of the sink. After fixing the sink plaster shall be made

good and the surface finished matching with the existing one.

**2.2.** The C.P. brass trap and union shall be connected to 40 mm. dia. nominal bore galvanized mild steel waste pipe which shall be suitably bent towards the wall and which shall discharge into an open drain leading to a gully-trap or direct into the gully-trap on the ground floor and shall be connected to a waste pipe through a floor trap on the upper floors, C.P. brass trap and union may not be provided where surface drain or a floor trap is placed directly under the sink and the waste is discharged to it vertically.

**2.3.** The height to front edge of the wash basin from the floor level shall be 80 cms.

**3.0. Mode of measurements & payment:**

**3.1.** The rate includes cost of all labour, materials tools and plant and other equipment required for satisfactory completion of this item as described in workmanship.

**3.2.** The rate shall be for a unit of one number.

**Item No. 73: Providing and fixing brass screw down stop (A) 15 mm. Dia**

**1.0. Materials:**

**1.1.** The brass screw down stop cock of specified dia. shall conform to I.S. : 781-1977. The stop cock shall be tested quality.

**2.0. Workmanship:**

**2.1.** The stop cock shall be fixed in position by means of Jam nut and socket. The stop cock shall be fixed near the inlet of the water meter or as directed. The joints shall be done with white zinc and spun yarn. The joint shall be tested for leak proofing.

**3.0. Mode of measurements & payment:**

**3.1.** The rate includes cost of all labour, materials, tools and plant etc. required for satisfactory completion of this item.

**3.2.** The rate shall be for a unit of one number.

**Item No. 74: Providing and fixing Pillar Tap, capstan head, screw down high pressure with screws, shanks and back nuts (A) 15 mm. Dia**

**1.0. Materials:**

**1.11.** The capstan head pillar tap of specified dia. of C.P. over brass shall be of best quality and shall conform to I.S.: 1975-1961. The pillar taps shall be of tested quality.

**1.12. Workmanship:**

The capstan head pillar tap of specified dia. shall be fixed as directed with required washer of selected leather or rubber asbestos composition or of plastic as directed. The cock shall fix with pipe line with white zink end spun yarn to make joint water tight. The work shall be carried out in best workman like manner.

**1.13. Mode of measurements & payment:**

**1.14.** The rate includes cost of all labour, materials tolls and plant etc. required for satisfactory completion of this item.

**1.15.** The rate shall be for a unit of one number.

**Item No. 51: Constructing brick masonry chamber for underground C.I. Inspection chamber and bends with bricks having crushing strength not less than 35 Kg/cm<sup>2</sup> in cm. 1:5 C.I. Cover with frame (light duty) 455 mm. X 610 mm. Internal dimensions, total weight of cover with frame to be not less than 38 Kgs. weight of cover 23 Kg. and wt. of frame 15 Kg) R.C.C. top slab with 1:2:4 mix (1-cement: 2-coarse sand : 4-graded stone aggregate 20 mm. size) foundation concrete 1:5:10 inside plaster 15 mm. thick with cement mortar 1:3 finished smooth with a floating coat of neat cement on walls & abed concrete etc. complete (I) inside dimensions, 455 mm. 610 mm. And 450 mm. Deep for single pipe line.**

**1.0. Materials:** Water shall conform to M-1. Cement shall conform to M-3. Coarse sand shall conform to M-5. Brick shall conform to M-15. Stone aggregate shall conform to M-12. Brick bat shall conform to M-14 M.S. bar shall conform to M-18.



## **2.0. Workmanship**

- 2.1.** C.I. inspection chamber with provision of C.I. bends of specified size with bolts, nuts and felt washers for underground drain shall be enclosed in masonry chamber which shall be constructed as under:
- 2.2.** The excavation shall be done true to dimensions and level shown in one the plans or as directed.
- 2.3.** Bed concrete shall be 15. Cms, thick C.C. 1:5:10 (1 cement: 5 coarse sand: 10 graded brick bat aggregates. The projection of bed concrete beyond the masonry walls shall be 7.5 cms.
- 2.4.** Masonry walls and plaster work shall be carried out as per relevant specifications of item 24.40.
- 2.5.** The cover slab shall be constructed as per relevant specifications of 24.27 (I).

## **3.0. Mode of measurements and payment**

- 3.1.** The earth work in excavation, providing and laying C.I. inspection chamber and bends shall be measured and paid for separately.
- 3.2.** The rate shall be for a unit of One number

## **10.6 Expansions joint: 61**

- 10.6.1** Expansion joints to be provided shall be of 24-gauge G.I. sheet strips of 400 mm width at location shown on drawing or as approved by the Engineer. The G.I. Strip shall be bent to the shape indicated on drawing and embedded properly in concrete. The joint width shall be uniform throughout and special care shall be taken to ensure proper concreting at expansion joints. Expansion joints shall be continuous and where two or more G.I sheets meet, they shall be lapped to the extent of 75 mm and joints properly soldered. The expansion joints shall be filled with pre-moulded joint fillers and sealed with mastic compound. For the purpose of measurement, the laps provided shall be neglected.

Metal or tar felt flashings shall be fixed as directed by the Engineer. Metal flashings provided shall be welded to obtain continuity. Pre-moulded joint fillers shall be of Shalitex sealing compound.

- 10.6.2** Expansion joints in flooring, foundations and all structures shall be formed in

the positions and to the shapes shown in the relevant drawings. When joints are to be filled with joint filling materials as stipulated in the drawings the permanently exposed edges of joints shall be sealed with an approved sealing compound. Joint filling material shall consist of 25 mm thick impregnated fiber board of the approved make with expansion joint fillers and its equivalent approved quality sealing compound shall be used. Payment shall be made on SMT basis of the board as laid finally. The rate shall include the cost of preparing the surfaces, fixing and finishing with sealing compound.

## **10.7 WATER PROOFING (ROOF):**

### **10.7.1 WITH BITUMEN FELT:**

#### **(i) MATERIAL**

- (a) Bitumen primer of approved quality and make shall be used in work and shall conform to IS: 3384-1965.
- (b) Special roofing asphalt blown grade shall conform to IS:702 – 1955 and shall be of approved make.
- (c) A fibre base water proofing felt and Hessian base felt type 3, grade 1 shall conform to IS: 1322-1970. (d)

#### **(ii) PREPARATION OF SURFACES:**

The surfaces shall be dry, free from dust, dirt, oil and other foreign material.

- (a) Five-layer treatment consisting of the following:
  - A layer of cold bituminous primer at a rate of 400 gms per smt.
  - A layer of special roofing asphalt (Hot) at a rate of 1.2 Kg. per square meter.
  - A layer of bitumen felt Hessian base self-finished type 3, grade 1 of approved makes. Minimum lap at the ends and sides of felt shall be 100 mm and 75 mm respectively and joints shall be sealed properly with bitumen.
  - A layer of special roofing asphalt (Hot) at a rate of 1.2 Kg. per square meter.
  - A layer of pea size gravel of 6 mm down size at a rate of 0.0006 cms per square meter.
- (b) Seven-layer treatment consisting of the following:

The first four layers shall be same as the first four layers stated above in five layers treatment. The other layers shall be:

- Apply second layer of Hessian based self-finished tar felt, with minimum 100 mm and 75 mm lap at end and sides of strips.
- A layer of special roofing asphalt (Hot) at a rate of 1.2 Kg. per square meter.
- Apply final layer of pea gravel of 6 mm down size at a rate of 0.0006 Cmt./Smt.

The contractor shall give guarantee against any leakage, and rectify any defect in water proofing, as mentioned in Bills of Quantities.

**(iii) RATES TO INCLUDE:**

Rates for water proofing shall include following:

- (a) Preparatory work shall be as per IS: 3067.
- (b) Treatment of gutters and drain mouths.
- (c) Treatment of main roof, flat or sloping.
- (d) Treatment of flashings and projecting pipes.
- (e) Cost of fuel required for heating bitumen up to required temperature and transporting all materials at site of work.
- (f) All water proofing work to be carried out as per IS; 1346.
- (g) Making Zari in walls if required for flashing.

**(iv) MEASUREMENTS:**

- (v)** Only superficial area will be measured and paid and no extra claim for laps, gutters, drain mouth, flashings and projecting pipes etc. will be considered for payment.

**10.7.2 WITH FIBREGLASS TISSUE:**

**(i) MATERIAL:**

- (a) Bitumen primer and Bitumen (special roofing asphalt) shall be as specified in waterproofing roof with Bitumen felt item.
- (b) Fibre glass R.P. Tissue shall be of M/s Fibre Glass Pilkington Ltd. Or approved make with the following properties.

Weight 50 gm/smt

Thickness 0.5 mm

Tensile strength in longitudinal 3.2kg/cm<sup>2</sup> Direction

- (c) The tissue shall not fail in hot bitumen at 300 degree C temperature for one minute.
- (d) Pea size gravel/coarse sands.
- (e) The tissue shall not fail in hot bitumen at 300 degree C temperature for one minute.
- (f) Pea size gravel / coarse sands.

**(ii) PREPARATION OF SURFACE:**

The surface shall be dry, free from dust, dirt oil and other foreign material.

**(iii)** Specification of two layers of fiberglass Tissue shall consist of the following:

- (a) A layer of cold bituminous primer at a rate of 400 Gms. Per Smt.
- (b) Apply first coat of hot bitumen at the rate of 1.8 Kg./Smt.
- (c) Embed first layer of Fibre glass Tissue. The minimum over lapping joints at the ends and sides of the strip of tissue shall be 100 mm and 75 mm respectively. All the laps shall be firmly bonded with hot bitumen.
- (d) Apply second coat of hot bitumen at the rate of 1.8 Kg/Square meter.
- (e) Embed second layer of fiberglass Tissue with minimum over laps as stated in 1st layer.
- (f) Apply third coat of hot bitumen at the rate of 1.8 kg/smt.
- (g) A layer of pea size gravel of 6 mm thick or coarse sand shall be embedded at the rate of .006 m<sup>3</sup>/m<sup>2</sup> into the hot bitumen while it is being poured by applying minimum pressure.

**(iv) Specification of three layer of fiberglass tissue:**

Three layers of Fibre glass Tissue consisting of the following (a) to (f) shall be same as in 10.7.2(iii).

- (g) Embed third layer of Fiberglass Tissue.
- (h) Apply fourth coat of hot bitumen at the rate of 1.8 kg/smt.

- (i) A layer of pea size gravel or coarse sand shall be embedded at the rate of 0.006 m<sup>2</sup>/smt into the hot bitumen, while it is being pured by applying minimum pressure.

**(v) Specification for four layer of fiberglass tissue:**

Four layers of Fibre glass Tissue consisting of the following:

Layers (a) to (h) shall be are same as in 10.7.2 (iv)

- (i) Embedded fourth layer of fiberglass and Bitumen at the rate of 1.8 kg/smt.
- (j) Apply pea size gravel as per (i) of 7.2 (iv)

**(vi) FOLLOWING CARE SHALL BE TAKEN:**

- (a) The joints in Fibre glass Tissue between successive layers shall be staggered midway.
- (b) Required length of Fibre glass Tissue shall be cut and rolled before commencing the work.
- (c) In case of A.C Sheets/G.I sheets all nuts and bolts shall be properly tightened and wherever necessary the old sheet should be replaced. The sheet overlaps shall be first caulked with a suitable bituminous sealing compound.

**10.7.3 WITH CHINA MOSAIC:**

The surface to be water proofed shall be cleaned thoroughly and shall be free from oil and other foreign materials. Prepared surface shall receive the following treatment.

- (i)** The first four layers shall be same as stated above for five layers treatment in Para 10.7.1 (ii)
- (ii)** A layer of B.B.L.C (Brick Bat Lime Concrete) of specified thickness shall be laid over tar felt to the required slope as shown in drawing. Proportion of B.B.L.C shall be 2 parts of brickbat and one part of lime mortar (1:2) i.e., 1 part of lime and 2 parts of sand). After 48 hours of laying of B.B.L.C., a bedding of lime mortar (1:2), 18 to 25 mm thick shall be provided and on top of this layer, 10 mm thick neat cement grout shall be provided, immediately on application of cement grout, assorted pieces of colored glazed China previously soaked in water shall be set closely on the fresh surface and properly tamped to get the

required top surface. The surface after completion of work shall be cleaned with sawdust or with diluted acid, if directed by Engineer-in-Charge. The finished surface shall be cured for 10 days. If so, directed by the Engineer, a border color of white mosaic shall be provided, without any extra cost. Tar felt, brickbat koba and China mosaic shall be taken up the parapet walls to a height of 100 – 150 mm. Necessary vatas shall be provided towards drain as directed.

- (iii) Measurement shall be in square meters correct to two decimal places. Length and breadth of the actual laid area shall be measured and paid. No extra shall be paid for vatas and work carried over parapet.

#### **10.7.4 CEMENT BASED WATER-PROOFING FOR TERRACES:**

The work shall be executed by an experienced agency and shall be guaranteed for the period as mentioned in the Bills of Quantities. Waterproofing material used shall be of approved manufacturers and shall be used according to the manufacturers Specification.

- (i) Area shall be cleaned of all loose materials and shall be treated with neat cement slurry and mixed with water proofing compound to seal the cracks, pores, etc. appearing on the surface.
- (ii) After the slurry coat a layer of new well burnt brick bats shall be laid in cement mortar (1:3) admixed with water proofing compound. This shall be laid in a proper slope. The brickbat joints shall be filled up to half the depth. Coving shall be done at all joints of slab and brick walls, inverted beams etc. Minimum high to coving shall be 300 mm. Brick Bat layers shall be cured for 3 days.
- (iii) A coat of cement slurry admixed with water proofing compound shall be applied to the brick bat layer.
- (iv) A layer of cement mortar (1:3) with water proofing compound shall be applied on the second slurry coat and joints of brick bat layer shall be filled up completely to give a finished plain surface.
- (v) Finally, a top layer 20 mm thick of cement mortar (1:3) admixed with water proofing compound shall be laid and finished smooth with cement slurry, admixed with water proofing compound. The finished surface shall be marked with boarder and chequered marks 300 mm x 300 mm to give good appearance.

- (vi) The finished surface shall be cured for 10 days by ponding water over it. The drain openings shall be closed during curing period and shall be opened out as soon as the curing period is over.
- (vii) The average thickness of this treatment shall be 115 mm.
- (viii) The measurement shall be in square meters correct to two decimal places. Length and breadth of the actual laid area shall be measured and paid. Coving shall also be paid in Smt. basis.

#### **10.7.5 TAPECRETE WATER PROOFING TREATMENT:**

The surface shall be cleaned of loose materials, dust oil, grease etc. The surface shall be cleaned by grinding, water blasting, sand blasting, and acid washing, if required.

- (i) Mixing should be carried out with puddle type mixers operating at low rates of rotation. Rotations should not exceed 360 RPM to prevent aeration of mixes.
- (ii) All concrete surfaces shall be thoroughly pre-wetted for at least one hour prior to the application of Tape Crete coatings. When placing Tape Crete coating, all water shall be removed so that surface is only damp. In no case there shall be standing water or a shiny wet surface. Tape Crete polymer is mixed with neat cement in the ratio of 100 kg. of cement to 52 kg. of Tape Crete. The mix has to be applied by brush on prepared surface. Two or more coats are to be done. First coat should be allowed to dry for 5-6 hours.
- (iii) Tape Crete system is cured by air-drying. It must be protected from rain during the first 12 hours of curing. No foot traffic is allowed on any tape Crete work within 12 hours of application and no vehicular traffic is allowed within 48 hours.

#### **ITEM No. 1 to 9**

**Boring holes 3.5 M. deep in ordinary soil (forecast in site piles) and getting out the soil and disposal of the surplus excavated soil as directed within a lead of 50 M. for following diameter for piles (I) 200 mm. (ii) 250 mm. (iii) 300 mm (iv) 450 mm**

#### **1.0. Workmanship:**

- The ground shall be roughly leveled and after making the position of piles, the holes shall be bored with aspire angle to the 3.5 M. depth and specified diameter using boring guide.
- The bore holes shall be truly vertical and uniform bore throughout of specified diameter. After boring to the required depth, the bore shall be cleared off the loose soil and disposal of surplus excavated stuff as directed within a lead of 50 M.

**2.0. Mode of measurement and payments:**

2.1. The rate for boring holes shall include:

- (a) Roughly leveling the ground in positions where piles are to be provided.
- (b) Making the positions of piles by pegs and boring guide and also for shifting of boring guide.
- (c) Bailing out water, if any met with during boring.
- (d) Disposal of surplus excavated soil within a lead of 50 M. and
- (e) All tools, plants, equipment's and labor required for satisfactory completion of work.

2.2. The rate shall before a unit of one number.

**Extra for under reaming inside the bore holes for under reamed piles of following nominal diameter. (I) 200 mm. (ii) 250 mm. (iii) 300 mm (iv) 450 mm**

**1.0. Workmanship:** The relevant specifications of item No. 4.27 shall be followed except that after boring to the required depth, the bore shall be enlarged at the bottom by an under reamer 2 to 2 ½ times the diameter of the bore as directed. It shall be ensured that the bore for the pile shall be enlarged to the correct diameter.

**2.0. Mode of measurement and payment:**

2.1. The relevant specifications of item No. 4.27 shall be followed.

2.2. The rate shall be paid extra over and above the rate of item No. 4.27 under reaming the piles.

2.3. The rate shall be for a unit of one Number.



**Item No. 75 : Providing and laying compacted WBM 150mm thick of grade II by using machine crushed B.T. metal of size 45mm to 63mm, with using 13% screening 13.2 size and 7% stone dust as binding materials, including spreading watering and consolidation with all lead and lift.**

As per Road Specification booklet Item No. 4A, Page NO. 23.

## **APPLICABLE CODES**

### **CONCRETE**

#### **MATERIALS**

- IS.269      Specification for 33 grade ordinary Portland cement. IS.455 Specification for Portland slag cement.
- IS.1489      Specification for Portland-Pozzolana cement (Part 1&2). IS: 8112 Specification for 43 grade ordinary Portland cement.
- IS: 12269      Specification for 53 grade ordinary Portland cement. IS: 12330 Specification for sulphate resisting Portland cement.
- IS: 383      Specification for coarse and fine aggregates from natural sources for concrete.
- IS: 432      Specification for mild steel and medium (tensile steel bars and hard-drawn steel)wires for concrete reinforcement. (Part 1&2)
- IS: 1786      Specification for high strength deformed steel bars and wires for concretereinforcement.
- IS: 1566      Specification for hard-drawn steel wire fabric for concrete reinforcement.
- IS: 9103      Specification for admixtures for concrete.
- IS: 2645      Specification for integral cement water- proofing compounds
- IS: 4990      Specification for plywood for concrete shuttering work.

#### **MATERIAL TESTING**

- IS.4031      Methods of physical tests for hydraulic cement (Parts 1 to 15)
- IS: 4032      Method chemical analysis of hydraulic cement.
- IS: 650      Specification for standard sand for testing of cement.
- IS: 2430      Methods for sampling of aggregates for concrete.
- IS.2386      Methods of test for aggregates for concrete (Parts 1to 8)
- IS: 3025      Methods of sampling and test (physical and chemical) for water used in industry.
- IS: 6925      Methods of test for determination of water-soluble chlorides in concrete admixtures.

## **MATERIAL STORAGE**

IS: 4082 Recommendations on stacking and storing of construction materials at site.

## **CONCRETE MIX DESIGN**

IS: 10262 Recommended guidelines for concrete mix design.

SP: 23 (S&T) Handbook on Concrete Mixes

## **CONCRETE TESTING**

IS.1199 Method of sampling and analysis of concrete.

IS: 516 Method of test for strength of concrete.

IS: 9013 Method of making, curing and determining compressive Strength of accelerated cured concrete test specimens.

IS: 8142 Method of test for determining setting time of concrete by penetration resistance.

IS: 9284 Method of test for abrasion resistance of concrete.

IS: 2770 Methods of testing bond in reinforced concrete.

## **EQUIPMENT'S**

IS: 1791 Specification for batch type concrete mixers.

IS: 2438 Specification for roller pan mixer.

IS: 4925 Specification for concrete batching and mixing plant.

IS: 5892 Specification for concrete transit mixer and agitator.

IS: 7242 Specification for concrete spreaders.

IS: 2505 General Requirements for concrete vibrators: Immersion type.

IS: 2506 General Requirements for screed board concrete vibrators.

IS: 2514 Specification for concrete vibrating tables.

IS: 3366 Specification for pan vibrators.

IS: 4656 Specification for form vibrators for concrete.

IS: 11993 Code of practice for use of screed board concrete vibrators.

IS: 7251 Specification for concrete finishers.

IS: 2722 Specification for portable swing weighs batchers for concrete (single and double bucket type).

IS: 2750 Specification for steel scaffoldings.

### **CODES OF PRACTICE**

IS: 456 Code of practice for plain and reinforced concrete.

IS: 457 Code of practice for general construction of plain and reinforced concrete for dams and other massive structures.

IS: 3370 Code of practice for concrete structures for storage of liquids (Parts 1 to 4)

IS: 3935 Code of practice for composite construction.

IS: 2204 Code of practice for construction of reinforced concrete shell roof.

IS: 2210 Criteria for the design of reinforced concrete shell structures and folded plates.

IS: 2502 Code of practice for bending and fixing of bars for concrete reinforcement.

IS: 5525 Recommendation for detailing of reinforcement in reinforced concrete works.

IS: 2751 Code of practice for welding of mild steel plain and deformed bars used for reinforced concrete construction.

IS: 9417 Specification for welding cold worked bars for reinforced concrete construction.

IS: 3558 Code of practice for use of immersion vibrators for consolidating concrete.

IS: 3414 Code of practice for design and installation of joints in buildings.

IS: 4326 Code of practice for earthquake resistant design and construction of building.

IS: 4014 Code of practice for steel tubular scaffolding (Parts 1 & 2)

IS: 2571 Code of practice for laying inset cement concrete flooring.

IS: 7861 Code of practice for extreme weather concreting: Part 1

Recommended practice for hot weather concreting.

## **Construction Safety**

IS.3696 Safety code for scaffolds and ladders. (Parts 1)

IS: 7969 Safety code for handling and storage of building materials.

IS: 8989 Safety code for erection of concrete framed structures.

## **BUILDING DETAILS**

### **Applicable Codes and Specifications**

The following codes and standards are included in this section, as part of these specifications. However, respective IS codes for the works not mentioned here shall also be applicable for those particular items of work.

- IS:110 - Ready mixed paint, brushing, gray filler, for Enamels for use over primers
- IS:269 - Specification for 33 grade ordinary Portland cement
- IS:280 - Specification for mild steel wire for general Engineering purposes
- IS:287 - Recommendations for maximum permissible Moisture content of timber used for different purposes
- IS:304 - High Tensile Brass Ingots and Castings.
- IS:337 - Varnish, finishing interior
- IS:348 - French polish
- IS:383 - Specification for coarse & fine aggregates from natural sources for concrete
- IS:412 - Expanded metal steel sheets for general purposes
- IS:419 - Specification for putty for use on window frames
- IS:428 - Distemper, oil emulsion, color as required
- IS:459 - Specification for unreinforced corrugated and semi- Corrugated asbestos cement sheet
- IS:702 - Specification for industrial bitumen
- IS:710 - Specification for marine plywood
- IS:712 - Specification for building limes

- IS:730 - Specification for hook bolts for corrugated sheet Roofing
- IS:733 - Wrought aluminum and aluminum alloys, bars, Rods and sections for general engineering purpose
- IS:777 - Specification for glazed earthenware tiles
- IS:1003 - Specification for timber paneled and glazed shutters (Parts 1 & 2)
- IS:1038 - Specification for steel doors, windows and ventilators
- IS:1077 - Specification for common burnt clay building bricks
- IS:1081 - Code of practice for fixing and glazing of metal (steel & aluminum) doors, windows and ventilator
- IS:1124 - Method of test for determination of water absorption, apparent specific gravity and porosity of natural building stone
- IS:1237 - Specification for cement concrete flooring tiles
- IS:1322 - Bitumen felts for water proofing and damp proofin
- IS:1346 - Code of practice for water proofing of roofs with bitumen felts  
IS:1361 - Specification for steel windows for industrial buildings
- IS:1397 - Specification for craft paper
- IS:1443 - Code of practice for laying and finishing of cement concrete flooring tiles
- IS:1477 - Code of practice for painting of ferrous metals in buildings (Parts 1 & 2)
- IS:1542 - Specification for sand for plaster
- IS:1580 - Specification for bituminous compounds for water-proofing and caulking purposes
- IS:1597 - Code of practice for construction of stone masonry: Part 1 Rubble stonemasonry
- IS:1659 - Specification for block boards
- IS:1661 - Code of practice for application of cement and cement-lime plaster finishes
- IS:1834 - Specification for hot applied sealing compound for joint in concrete
- IS:1838 Part 1 - Specification for preformed fillers for expansion joint in concrete pavements and structures (non-extruding and resilient type)

Bitumen impregnated fiber

- IS:1948 - Specification for aluminum doors, windows and ventilators
- IS:1949 - Specification for aluminum windows for industrial buildings
- IS:2074 - Ready mixed paint, air drying, red oxide- zinc chrome, priming
- IS:2098 - Asbestos cement building boards
- IS:2114 - Code of practice for laying in-situ terrazzo floor finish
- IS:2116 - Specification for sand for masonry mortars
- IS:2185 - Specification for concrete masonry units  
(Parts 1,2 & 3)
- IS:2202 - Specification for wooden flush door shutters (Solid core type)  
(Parts 1 & 2)
- IS:2212 - Code of practice for brickwork
- IS:2250 - Code of practice for preparation and use of masonry mortars
- IS:2338 - Code of practice for finishing of wood & wood-based materials  
(Parts 1& 2)
- IS:2339 - Aluminum paint for general purposes, in dual container
- IS:2395 - Code of practice for painting concrete, masonry and plaster surfaces (Parts1 & 2)
- IS:2402 - Code of practice for external rendered finishes
- IS:2571 - Code of practice for laying in-situ cement concrete flooring
- IS:2572 - Code of practice for construction of hollow concrete block masonry
- IS:2645 - Specification of integral cement waterproofing compounds
- IS:2690 - Specification for burnt clay flat terracing tiles : Part 1 Machine made
- IS:2691 - Specification for burnt clay facing bricks
- IS:2750 - Specification for steel scaffoldings
- IS:2835 - Flat transparent sheet glass
- IS:2932 - Specification for enamel, synthetic, exterior type (a) undercoating, (b) finishing
- IS:3007 - Code of practice for laying of asbestos cement sheets - corrugated

and(Part 1 & 2) semi-corrugated sheets

- IS:3036 - Code of practice for laying lime concrete for a water-proofed roof finish
- IS:3067 - Code of practice of general design details and preparatory work for damp-proofing and water- proofing of buildings
- IS:3068 - Specification for broken brick (burnt clay) coarse aggregates for use in limeconcrete
- IS:3384 - Specification for bitumen primer for use in water-proofing and damp-proofing
- IS:3461 - Specification for PVC-asbestos floor tiles
- IS:3462 - Specification for unbaked flexible PVC flooring
- IS:3495 - Method of test for burnt clay building bricks: Part 1 to 4
- IS:3536 - Specification for ready mixed paint, brushing, wood primer, pink
- IS:3564 - Specification for door closures (hydraulically regulated)
- IS:3696 - Safety code of scaffolds and ladders (Parts 1 & 2)
- IS:4020 - Methods of test for wooden flush door: Type test
- IS:4021 - Specification for timber door, window and ventilator frames
- IS:4351 - Specification for steel door frames
- IS:4443 - Code of practice for use of resin type chemical resistant mortars
- IS:4457 - Specification for ceramic unglazed vitreous acid resisting tile
- IS:4631 - Code of practice for laying epoxy resin floor toppings
- IS:4832 - Specification for chemical resistant mortars (Part II)
- IS:4860 - Specification for acid resistant bricks
- IS:4948 - Specification for welded steel wire fabric for general use
- IS:5318 - Code of practice for laying of flexible PVC sheet and tile flooring
- IS:5410 - Cement paint, colour as required
- IS:5411 - Specification for plastic emulsion paint (Parts 1 & 2)
- IS:5437 - Wired and figured glass
- IS:5491 - Code of practice for laying of in-situ granolithic concrete floor topping
- IS:6041 - Code of practice construction of autoclaved cellular concrete block



masonry

- IS:6042 - Code of practice for construction of light weight concrete block masonry
- IS:6248 - Specification for metal rolling shutters and rolling grilles
- IS:7193 - Specification for glass fiber base coal tar pitch and bitumen felts
- IS:7452 - Specification for hot rolled steel sections for doors, windows and ventilators
- IS:8042 - Specification for white Portland cement
- IS:8543 - Methods of testing plastics
- IS:8869 - Specification for washers for corrugated sheet roofing
- IS:9197 - Specification for epoxy resin, hardeners and epoxy resin composites for floor topping
- IS:9862 - Specification for ready mixed paint, brushing, bituminous, black, lead-free, acid, alkali, water and chlorine resisting
- IS:12200 - Code of practice for provision of water stops at transverse contraction joints in masonry and concrete dams

# **BHAVNAGAR MUNICIPAL CORPORATION**



**--: BID DOCUMENTS FOR :-**

**PROPOSED DOG HOME SHELTER & ANIMAL VACCINATION CENTRE AT  
NARI ROAD, KUMBHARWADA, BHAVNAGAR, DIST. BHAVNAGAR**

**TECHNICAL SPECIFICATIONS FOR ELECTRICAL WORK**

**ARCHITECTS  
MANISH RUPARELIA PVT. LTD.  
901-902, Time Square,  
Ayodhya Circle, 150 Feet Ring Road,  
Rajkot 360 006**

**EXECUTIVE ENGINEER  
Building Department  
Bhavnagar Municipal Corporation  
Mangalsinhji Road,  
Bhavnagar – 364 001**

## **SPECIAL CONDITIONS OF CONTRACT FOR ELECTRICAL WORK**

### **EXTENT OF WORK**

**1.** The scope includes design, manufacture, inspection & testing at manufacture's works, delivery to site, unloading & storage at site, installation, testing at site, commissioning, final painting and handing over to client the complete electrical work to be carried out at the site.

**1.1.** The scope of work includes the following:

- 1.1.1. 11 kV VCB H.T. Panel/ DP STRUCTURE
- 1.1.2. 250/125/63 KVA Oil Type Distribution Transformer 11 kV / 0.433 kV
- 1.1.3. 125/250 kVA DG sets, UPS, Inverters etc.
- 1.1.4. H.V. XLPE cables and end termination
- 1.1.5. Main Power Control Centre, D.G. Control cum synch Panel
- 1.1.6. Utility system
- 1.1.7. Main Lighting Distribution Board (MLDB) & Main Power Distribution Board (MPDB).
- 1.1.8. L.V. capacitor bank with APFCR panel
- 1.1.9. L.V. XLPE cable and end termination
- 1.1.10. Earthing and lightning protection system
- 1.1.11. Internal Wiring with conduits, wires, junction boxes, switches, sockets, Lighting distribution boards.
- 1.1.12. Light fixtures for General Area and Parking area
- 1.1.13. Auxiliaries' items viz. Cable tray/ Cable Trench with necessary mounting / fixing supports, Route ON / OFF Push button sets
- 1.1.14. Conduiting wiring and necessary electrical work for Fire Alarm & Detection System, Computer network system, Telephone network, Security & Access Control System etc.
- 1.1.15. External Lighting and Cable laying, lighting poles/mast installation
- 1.1.16. Façade lights, area lighting, street lights, landscape lighting, pathway lighting, High masts, functional lightings etc.

- 1.1.17. Under water and water body lighting system
- 1.1.18. Civil work viz. Foundation, trenches, excavation, back filling, cutting and drilling holes through walls or floors, chiseling in wall if required or any civil work required to complete the job
- 1.1.19. Safety accessories, tools, tackles, spares, consumables
- 1.1.20. Extra low voltage system installations like Voice and Data, Cable TV systems
- 1.1.21. Security and surveillance systems like CCTV / Public address / Evacuation / Access control etc.

**2. SCOPE OF WORK:**

- 2.1.** The work to be carried out under this contract comprises of the Electrical Installation work for the proposed project called for in the documents. The work covered under this contract comprises of supply (wherever called for), installation, connection, testing and commissioning the Electrical installation commencing from point of electric power supply within the project site as per specifications, relevant Indian standards, Code of practice
- 2.2.** The contractor shall carry out and complete the said work under this contract in every respect in conformity with the current rules and regulations of the local Electricity Authority, the Indian Standards and with the directions of and to the satisfaction of the Consultant and owner. The Contractor shall furnish all labor and install all materials, appliances, equipment (except those items which will be supplied by the Owner to the contractor at site), necessary for complete provision and testing of the whole electrical installation as specified herein and shown on the drawings. This also includes any material, appliances, equipment not specifically mentioned herein or noted on the drawing as being furnished or installed but which are necessary and customary to make complete installation with all outlets for power, light, telephone conduits, all other conduits and other electrical systems shown in the schedule or described herein, properly connected and in working order.
- 2.3.** The work shall include all incidental jobs connected with electrical

installation such as excavation for trenches and back filing, cutting/drilling holes through walls/floors and grouting for fixing of fixtures, equipment etc. Chiseling in the wall or principal structure is not permitted. In general, the work to be performed under this contract shall comprise of the following:

- 2.4.** Substation comprISIng of:
  - 2.4.1. H.T. Switchgear & H.T Cable
  - 2.4.2. Transformer
  - 2.4.3. D.G. set
  - 2.4.4. Substation accessories
  - 2.4.5. Earthing
  - 2.4.6. Power Control Centre
  - 2.4.7. Main L.T panel
- 2.5.** Lighting distribution board (LDB)
  - 2.5.1. Earthing and lightning protection system installation
  - 2.5.2. Plate / Pipe electrode type earth station
- 2.6.** Earth continuity conductor
- 2.7.** Internal and external lighting with fixtures
- 2.8.** UPS / Stabilizer
- 2.9.** All qualities mentioned in the Bill of quantity are approximate and the contractor shall not be eligible for any claim due to any variation in / or omission of any item.
- 2.10.** Any extra item shall be calculated on the rate analysis basis approved by OWNER.
- 2.11.** It is the responsibility of the contractor to co-ordinate with Torrent Power Ltd. / Electrical Inspector and fulfil all the requirements of Torrent Power Ltd. at no extra cost and arrange for the power connection.

### **3. ABBREVIATIONS:**

The following, abbreviations have been used in the accompanying specifications, drawings and Bill of quantity:

- ISS : Indian Standard Specifications.
- HRC : High Rupturing Capacity.
- GI : Galvanized Iron.
- MS : Mild Steel.
- MV : Medium Voltage.
- LV : Low Voltage.
- PVC : Polyvinyl Chloride.
- AMP : Amperes.
- V : Volts.
- KV : Kilo Volts.
- HV : High Voltage
- KW : Kilo Watt
- KVA : Kilo Volt Ampere
- PF : Power Factor
- Hz : Frequency
- KWH : Kilo Watt Hour
- XLPE : Cross Linked Polyethylene
- ACB : Air Circuit Breaker
- LED : Light Emitting diode
- PLC : Programmable Logic Controller
- UPS : Uninterrupted Power Supply
- DP : Double Phase
- IEE : Institute of Electrical Engineers, London.
- MCB : Miniature Circuit Breaker.
- TPN : Triple pole and Neutral.

SP : Single Pole.  
MCCB : Molded case Circuit breaker. VCB : Vacuum circuit breaker.  
CT : Current transformer.  
DB : Distribution board.  
DG : Diesel generator.  
BOQ : Bill of quantity.  
SITC : Supply, installation, testing and commissioning.  
L.O.I : Letter of intent/Acceptance letter.

#### **4. REGULATIONS AND STANDARDS:**

**4.1.** The installation shall conform in all respects to Indian standard code of Practice for Electrical Wiring installation IS: 732-1963 and IS: 2214-1963 (Silver Nitrate Pure and analytical reagent). It shall also be in conformity with the current Indian Electricity, Rules, Indian Electricity Act, National Electrical Code and Regulations of the Local Electrical supply Authority in so far as these become applicable to the installation. Wherever this specification calls for a higher standard of material and/or workmanship than those required by any of the above regulations then this specification shall take precedence over the said regulations and standard. In general, the materials equipment and workmanship not covered by the above shall conform to the relevant Indian Standards.

**4.2.** The electrical installation work shall follow Codes, Indian standard specifications and rules (Within the best meaning of the same) under this contract.

**4.3.** The following list is given for general guidance only in addition to list given in each individual section, however all other latest editions of Codes, Indian standard specifications and Rules shall also be followed when it is required.

I.S: 8623 Low voltage switchgear & control gear assemblies.

I.S: 10118 Code of practice for selection, installation and maintenance of switchgear and control gear.

- I.S: 4237      General requirement for switch gear and control gear for voltage not exceeding 1000 Volt A.C. or 1200 volts D.C.
- I.S: 13947    Low voltage switchgear and control gear. I.S: 9224 Low voltage fuses.
- I.S: 8828      Circuit breakers for out protection for household and similar installations. I.S: 12640 Earth leakage circuit breaker
- I.S: 1248      Direct acting indicating analog electrical measuring instruments I.S: 2705 Current transformers.
- I.S: 4201      Application guide for voltage transformers.
- I.S: 6875      Control switches for voltage up to and indicating 1000V - A.C. 1200 V - D.C.
- I.S: 5578      Guide for marking of insulated conductors.
- I.S: 11353    Guide for uniform system of marking and identification of conductors and apparatus transmission.
- I.S: 8197      Terminal markings for electrical measuring instruments and their accessories.
- I.S: 694        Specifications for PVC insulated cables for working voltages up to and including 1100volts.
- I.S: 2551      Danger notice plates.
- I.S: 3043      Code of practice for earthing.
- I.S: 5216      Guide for safety procedures and practices in electrical work.
- I.S: 1646      Code of practice for fire safety of building: Electrical installation. Indian Electricity Act as amended up to date. Indian Electricity Rules as amended up to date. Rules and Regulations of Bombay Regional Council of Fire Insurance & Association of India for Electrical wiring.

**5. FEES, PERMITS AND TESTS:**

- 5.1.**        The Contractor shall pay for any and all fees and obtain permits



required for the installation work. On completion of the work the contractor shall obtain and deliver to the OWNER, certificates of final inspection and approval by the local electric supply authority and the electrical inspector.

**6. UTILITY SUPPLY:**

**6.1.** The location of receipt of incoming utilities supply (Hook up Points) like HT supply shall be verified with various concerned authorities. It is the responsibility of the contractor to co-ordinate with various utility agencies, the exact location of such Hook Up Point and mode of connection. Further the contractor shall co-ordinate with such utility agencies to provide necessary drawings, documents, get their approval, make the necessary arrangement for the payments and arrange the utilities supply at no extra cost.

**7. ACTUAL ROUTE OF CABLE:**

**7.1.** The location of the cables, panel boards etc. is only indicative, therefore, the actual route of cables and the location of panel boards may differ from the plans according to the details of the building construction and the conditions of executions of the installations.

**7.2.** The contractor shall supply and install at his expense all secondary materials and special fittings found necessary to overcome the interference and to supply the modifications on the route of cables and conduits that are found necessary during the work, to the complete satisfaction of the owner's representative.

**8. MATERIAL AND EQUIPMENT:**

**8.1.** All materials and equipment must be of the approved make and design and must comply with all applicable requirements. The equipment and materials must meet all applicable Indian Standards. The Contractor will be in charge of keeping all the materials in secure custody and will provide insurance against theft, fire, earthquake, etc. Within ten days of the contract's award, the owner must get a list of all the materials and

equipment, along with a sample of each. Any recommended replacement item needs to be submitted with all technical information, including the name of the manufacturer, the item's dimensions, information on the materials, and the date the contractor submitted the proposal. Any credit that might be owing to the owner must also be specified by the contractor. All changes and substitutions must be sought in writing, and the owner must provide authorization in writing, even if the substitution is approved. In this situation, the owner's decISIon is final.

**8.2.** All materials of the same kind of service shall be identical and made by the same manufacturers. Any deviation to this rule shall be approved by the Consultant. Top priority shall be given to the products that have a permanent agent providing spare parts and maintenance facilities in the same city where the project is situated.

**8.3.** The make of electrical equipment's, components, accessories, etc. has been mentioned in order of priorities. The tenderer has to quote for the first priority as mentioned above after ascertaining that the first preference materials are available. If at a later stage during executing the work, material of the first preference make are not available, the contractor has to get approval from the OWNER to use other make of material prior to procurement. Any rate difference for the first preference make and the one approved will be passed on to the owner.

**9. MANUFACTURERS:**

**9.1.** Where manufacturers have furnished specific instructions relating to the materials used in this job, covering points not specifically mentioned in these documents, these instructions shall be followed in all cases.

**9.2.** Where manufacturer's names and / or catalogue numbers are given, this is an indication of the quality, standards and performance required.

**9.3.** When interfacing occurs, equipment shall be mutually compatible in all respects.

**10. RATING:**

**10.1.** Rating of all items shall be appropriate for the conditions on the particular site on which the items will be used. All the equipment shall be fit for continuous work under the worst conditions of site and shall be rated for the following ambient condition.

**10.2.** Outdoor temperature 50 deg. cel.

**10.3.** Temperature under shed 45 deg. cel.

**10.4.** Salty, dusty and humid

**10.5.** Coastal area

**11. INSPECTION AND TESTING:**

**11.1.** Owners' representative reserves the right to request inspections and testing at manufacturer's works at all reasonable times during manufacture of items for this contract. Tests on site of completed works shall demonstrate, among other things:

**12.** That the equipment installed complies with specification in all particulars and is of the correct rating for the duty and site conditions.

**13.** That all items operate efficiently and quietly to meet the specified requirements.

**14.** That all circuits are correctly fused and protected and that protective devices are properly coordinated.

**15.** That all non-current carrying metal work is properly and safely grounded in accordance with the specifications.

**15.1.** The contractor shall provide all necessary instruments and labor for testing, shall make adequate records of test procedures and readings, shall repeat any tests requested by the OWNER and shall provide test certificates signed by a properly authorized person. Such test certificates shall cover all works.

**15.2.** If tests fail to demonstrate the satisfactory nature of the installation or any part thereof then no claims for the extra cost of

modifications, replacements or re testing will be considered. Owner's decISIon as to what constitutes a satisfactory test shall be final.

**15.3.** The above general requirements as to testing shall be read in conjunction with any particular requirements specified elsewhere.

**16. PRICE DETAILS:**

**16.1.** At any time and at the request of OWNER, the contract shall provide details or breakdown of costs and prices of any part or parts of the works.

**17. TEST CERTIFICATES:**

**17.1.** The contractor shall submit test certificates for all the electrical material/system installed. These shall be issued by a government recognized inspection office certifying that all equipment, materials, construction and functions are in agreement with the requirements of these specifications, ISI and when ISI is not applicable other approved certifying agencies.

**18. INSTRUCTION MANUAL:**

**18.1.** The contractor shall prepare and produce instruction, operation and maintenance manuals in English for the use, operation and maintenance of the supplied equipment and installations, and submit 3 sets to OWNER, at the time of handing over.

**19. SAMPLES AND CATALOGUES:**

**19.1.** Before ordering the material necessary for these installations, the contractor shall submit to OWNER for approval, a sample of every kind of material such as cables, conductors, conduits, switches, socket outlets, circuit breakers, lighting fixtures, boxes etc., along with the catalogues.

**19.2.** For big items such as switchboards, the submission of catalogues shall be enough. Prior to ordering any electrical equipment/ material/ system, the contractor shall submit to OWNER, the catalogues, along with the samples, at least from three different

manufacturers. After the selection of manufacturer by OWNER, the contractor shall arrange inspection and testing at the manufacturer's factory or assembly shop for final approval. No material shall be procured prior to the approval of the owner.

**20. VENDOR AND SHOP DRAWINGS:**

**20.1.** The contractor shall prepare and submit to OWNER, for his approval, two sets of vendor detailed drawings of all distribution boards, switch boards, outlet boxes, special pull boxes, and other likewise material, equipment to be fabricated by the contractor, or other vendor within 15 days of signing of the contract.

**20.2.** Before starting the work, the contractor shall submit to OWNER for his approval in the prescribed manner, the shop/execution drawings for the entire installation, specially the main connections and junctions, the route of conduits and cables, no. and size of wires drawn through the conduits, location of all the outlet points, and switch boards and distribution boards and any other information required by OWNER. OWNER reserves the right to alter or modify these drawings if they are found to be insufficient or not complying with the established technical standards or if they do not offer the most satisfactory performance or accessibility for maintenance.

**21. AS BUILT DRAWINGS:**

**21.1.** At the completion of work and before issuance of certificate of virtual indicating the complete wiring system "as installed". These drawings must provide (in plan, completion the contractor shall submit to OWNER, three sets of layout drawing drawn at appropriate scale folded elevation and section)

**21.2.** Location and details of distribution boards, main switches, switchgear and other particulars.

**21.3.** Location of all earthing stations, route and size of all earthing conductors, manholes etc.

**21.4.** Route and particulars of all cables.

**21.5.** Lighting layout plan for all the floors along with circuit distribution details.

**21.6.** External Area Lighting Plan.

**22. GUARANTEE:**

**22.1.** At the close of the work and before issuance of final certificate of virtual completion by OWNER, the contractor shall furnish written guarantee indemnifying OWNER against defective materials and workmanship for a period of one year after completion. The contractor shall hold himself fully responsible for reinstallation or replacement, free of cost to OWNER, the following:

**22.2.** Any defective work or material supplied by the contractor.

**22.3.** Any material or equipment supplied by OWNER which is damaged or destroyed as a result of defective workmanship by the contractor.

**22.4.** Any material or equipment damaged or destroyed as a result of defective workmanship by the contractor

## **GENERAL MATERIAL SPECIFICATIONS FOR ELECTRICAL EQUIPMENTS**

### **1. Printed instruction chart**

#### **1.1. Material specification**

**1.1.1.** Providing printed instruction charts both in English & Gujarati and duly framed with front glassed for shock treatment chart.

#### **1.2. Workmanship**

**1.2.1.** The printed instruction chart should be provided in panel room, substation space, feederpillar etc.

### **2. Rubber matting:**

#### **2.1. Material specification**

**2.1.1.** Rubber matting should be given for the main panels for the below mention voltage grade.

**2.1.2.** Voltage grade: 440 volts, minimum thickness 6 mm

**2.1.3.** Voltage grade: 11000 volts, minimum thickness 9 mm

**2.1.4.** It should be frp material sheet, provided for panel (make: sintex or equivalent)

#### **2.2. Workmanship**

**2.2.1.** The rubber matting should be provided at floor for every floor mounting HT/LT panels.

### **3. First aid kit (standard)**

#### **3.1. Material specification**

**3.1.1.** Minimum quantities for low-risk establishments and activities may be considered as a general guidance leaflet on first aid.

**3.1.2.** 20 individually wrapped sterile adhesive dressings (assorted sizes) appropriate for the activity (detectable dressings (colored blue) should be available (if catering is to be undertaken).

**3.1.3.** 2 sterile eye pads.

- 3.1.4. 4 individually wrapped triangular bandages (preferably sterile)
- 3.1.5. 6 safety pins (optional)
- 3.1.6. 6 medium sizes individually wrapped sterile unmedicated wound dressings (approx.12cm × 12cm)
- 3.1.7. 2 large sterile individually wrapped unmediated wound dressings (approx. 18cm × 18cm)
- 3.1.8. 1 pair of disposable gloves

### **3.2. Workmanship**

- 3.2.1. The first aid box should be provided in substation area, panel room, etc.
- 3.2.2. It should be place in location which is easy in access & vISIBILITY.

## **4. Rubber Hand Gloves**

### **4.1. Material Specification & Workmanship**

- 4.1.1. Applicable standards: Unless otherwise modified in this specification the rubber hand gloves shall comply with IS: 4770-1968 or its latest version
- 4.1.2. Voltage Rating: 3.3 kV
- 4.1.3. Test Potential: 1.5 kV
- 4.1.4. Max. leakage Current & test potential: 12mA
- 4.1.5. The leakage current at the normal working voltage of the gloves shall not exceed 300 micro-Amps
- 4.1.6. The minimum breakdown voltage of the gloves shall be 25 kV
- 4.1.7. The minimum and maximum dimension of the gloves shall be in accordance with IndianStandards.
- 4.1.8. The allowable value of Tensile Strength, Elongation at Break, Tensile Set and ageing properties shall be as stipulated in Indian standards
- 4.1.9. The Gloves shall be marked with Type of Gloves & its Size.

## **5. The LT Switch Gear & Panel**



## 5.1. Material specification

5.1.1. It shall be manufactured as per the relevant Indian and international standards.

5.1.2. All the components in the panel shall be of the panels shall be as per approved make.

The panels shall be manufactured with sheet steel prepared using CNC machines for accurate cutting, bending and drilling etc. The sheet metal shall be pre-treated before painting. The assembly of the panels shall be with new techniques for easy removal and refitting of the components. The panel shall have a high degree of reliability and safety of the operating personnel. The components of identical feeders should be fully compatible to each other. The panel manufactured shall be fully conforming to the following standards.

IS 1248 & 3107	:	direct acting electrical indicating instruments
IS 2959	:	ac contactors up to 1000v
IS 13947	:	ac circuit breakers
IS 2705	:	current transformers
IS 3156 & 4146	:	potential transformers
IS 4047	:	specification for air brake switches and combination fuse switch units for voltage not exceeding 1000v
IS 6875	:	control switches for voltages up to and including 1000v ac and 1200v dc.
IS 1822	:	motor duty switches
IS 12021	:	specification for control transformer
IS 8623	:	factory-built assembly of switchgear & control gear for voltage not exceeding 1000v
IS 13947 (part i)	:	degree of protection for enclosure
IS 3842	:	specification for electrical relays for ac system
IS 2208 & 9224	:	specification for hrc fuses
IS 5082	:	wrought al. And aluminum alloys, bars, rods, tube and sections for electrical purposes.

IS 4237	:	general requirement for switchgear & control gear for voltage not exceeding 1000v
IS 3231	:	electrical relays for power system protection 151
IS 375	:	marking and arrangement for switchgear bus bars, main connection and control Wiring
IS 5578	:	guide for marking of insulated conductors.
IS 3618	:	pre-treatment of MS sheets for phosphatizing

## **5.2. Miniature Circuit Breaker**

**5.2.1.** Miniature circuit breakers shall be quick make and break and break type non-welding self-wiping silver alloy contacts for 10 ka short circuit both on the manual and automatic operation, conform with British standard BS: 3871 (part-i) 1965 and IS: 8825 (1996) with facility for locking in off position.

**5.2.2.** The housing of MCBs shall be heat resistant and having high impact strength. The fault current of MCBs shall not be less than 10ka, at 230 volts. The MCBs shall be flush mounted and shall be provided with trip free manual operating mechanism with mechanical "on" and "off" indications. 'C' characteristic current limiting type, 10 ka and having quick break with trip free operating mechanism. Each pole of the breaker shall be provided with inverse time thermal over load and instantaneous over current tripping elements, with trip-free mechanism. In case of multi-pole breakers, the tripping must be on all the poles and operating handle shall be common. Pressure clamp terminals for stranded/solid conductor insertion are acceptable up to 4 sqmm aluminum or 2.5 sqmm copper and for higher ratings; the terminals shall be suitably shrouded. Wherever MCB isolators are specified they are without the tripping elements.

**5.2.3.** The MCB contact shall be silver nickel and silver graphite alloy and tip coated with silver. Proper arc chutes shall be provided to quench the arc immediately. MCB's shall be provided with magnetic fluid plunger relay for over current and short circuit protection.

## **5.3. Switch Fuse Unit**

**5.3.1.** This unit shall be approved make triple pole metal clad switch

fuse unit 415-volt, 200-amp, cat iii with link type h.r.c. fuses and natural link confirming to I.S.S. erected on angle iron frame, double break type suitable for load break duty (ac 23), quick make and break action. Separate neutral link shall be provided. The door of panel shall be duly interlocked with operating mechanism so as to prevent closing of the switch when the door is not properly secured. It shall be provided with at least 2 auxiliary contacts. All contacts shall be silver plated and all live parts shall be shrouded. The incoming and outgoing terminals of switches shall be adequately sized to receive 3.5 core x 120 sq mm XLPE aluminum cables. High rupturing capacity of not less than 35mva at 415 volts hrc fuse links shall be provided with visible indicators to show that they have operated. The switch fuse unit shall be manufactured in accordance with is: 4047-1967 as amended to date.

#### **5.4. Fuse**

**5.4.1.** Fuses shall be of high rupturing capacity (hrc) fuse links and shall be in accordance with is: 2000-1962 and having rupturing capacity of not less than 35 MVA at 415 volts. The backup fuse rating as per site requirements / equipment.

#### **5.5. Porcelain Fuse**

**5.5.1.** Features

**5.5.2.** It should be made from top quality porcelain.

**5.5.3.** Best quality Brass, Phosphorus Bronze components and ETP copper contacts should be heavily silver plated to improve the high conductivity.

**5.5.4.** WEATHER CONDITION: The material used in construction of the fuse unit shall be suitable for use under following weather condition:

Temp. Range : 0 to 50 C

Relative humidity : 2% to 100%

Altitude-up to : 1000 Meters

Use : Outdoor, in dist. Box or consumer's indoor in premises.

- 5.5.5.** The fuses shall be suitable for continuous operation at AC 415 V and frequency 50 Hz IS: 2086/1993 with latest amendment for fuses up to 100 Amp
- 5.5.5.1. The fuses base shall be provided with two fixing holes for fixing the fuse base by means of screwier bolts.
- 5.5.5.2. The fuse base shall have contacts for suitably engaging with the contacts of the fuse carrier rigidly under any condition. The contacts shall be made out of such a metal which will not lose its electricity due to heating of the contracts on full load with 20% overload current or heat generated and required pressure is maintained even after repeated engagements and disengagement. The contact for rating 63 A and above will also have extended strips for fixing cable lugs by means of bolt.
- 5.5.5.3. FUSE CARRIER: The fuse carried shall have contacts suitable for engaging with fuse base contacts. They shall be provided with suitable terminals for the connection of the fuse elements. The fuse carrier shall be so constructed that it is capable of being reversible for introduction into the fuse base. The contacts shall be made out of the metal which will not lose its elasticity on account of heating of the contacts on full load with 20% overload conditions or heating due to blowing of the fuse element due to short circuit and required pressure is maintained and even after repeated engagement and disengagement.
- 5.5.5.4. Every fuse carrier shall be clearly and indelibly embossed with the following information.
- 5.5.5.4.1. Rated Current
- 5.5.5.4.2. Rated voltage
- 5.5.5.4.3. Size of fuse wire
- 5.5.5.5. Manufacturer's name / Trade mark Workmanship
- 5.5.5.6. The carrier and fuse base when installed in the intended manner shall have all live parts so protected as to prevent inadvertent contact with such live parts.
- 5.5.5.7. The fuse carrier shall be provided with a handle or grip and shall be shaped in acceptable manner so that it will be easy to withdraw the carrier without use of any tools and without danger to any L.M. or

operator.

- 5.5.5.8. All metal parts shall be protected against corrosion by suitable methods.
- 5.5.5.9. Live parts of the fuse carrier shall be covered either by a shield for barrier of insulating materials or be counter sunk not less than 3 mm below surface of the base and covered with water proof insulating sealing compound which will not deteriorated or flow at temp lower than 100 C.
- 5.5.5.10. Live parts on the underside of the fuse base for surface mounting shall be either covered by a shield or barrier of insulating materials or be counter sunk not less than 3mm below the surface of the base and covered with water proof insulating sealing compound which will not deteriorate or flow at a temp. lower than 100 degree C or on full load current with 20% overload or blowing of fuse under short circuit condition or shall have clearance of not less than 6.0 mm for 16A and 32A and 9mm for 63A, 100A and 200A size from the mounting surface and reliably prevented from loosening.
- 5.5.5.11. Screws upon which the general assembly of the fuse base and carriers' terminals and contacts depend shall be prevented from loosening or backing out buy lock, washers, stacking or other reliable means.
- 5.5.5.12. If screws used in the assembly of a fuse are loosened or removed in order to install the fuse elements or to connect the fuse into a circuit, they should be thread into metal and shall be provided with washers

## **5.6. Moulded Case Circuit Breaker**

- 5.6.1. The MCCB shall be air break type and having quick break with trip free operating mechanism confirmed to IS: 8825 and iec-60947-1/2 standard.
- 5.6.2. It should have thermal magnetic trip unit, adjustable thermal protection from 0.8 -1 in for 400 amp. And short circuit protection from 5 -10 in for rating more than 4000amp.it should be of rated operational voltage of 690 v ac (50 hz) and insulation voltage of 750v ac. It should have electrical life of 4000 (2500) operations and

mechanical life of 10000 (8000) operations for rating 400 amp. (>400 amp.) All the MCCB above 400 shall be have breaking capacity of 50ka. And 25 ka for MCCB < 400 amp rating

**5.6.3.** Housing of the MCCB shall be of heat resistant and flame retardant insulating material. Operating handle of the MCCB shall be in front and clearly indicate on / off / trip positions. The electrical contact of the circuit breaker shall be of high conducting non deteriorating silver alloy contacts. The MCCB shall be provided with thermal / magnetic type bi-metal over load release and electro-magnetic short circuit protection device. All the releases shall operate on common trip bus bar so that in case of operation of any one of the releases in any of the three phases, it will cut off all the three phases and thereby single phasing of the system is avoided. The MCCB whenever called for in the appendix drawings shall provide an earth fault relay. The MCCB shall provide two sets of extra auxiliary contacts with connections for additional controls at future date. The electrical parameters of the MCCB shall be as per the descriptions given in the attached drawings.

**5.7. Contactor:**

**5.7.1.** Contactor shall be air break type, having 3 power contact and 4 nos. Of auxiliary contact conforming to is: 2959, contactor provided shall be ac4 duty type for capacitor and ac3 duty type for motor loads. It shall be suitable for minimum class ii intermittent duty. It shall be capable of making and breaking starting current of motors and require capacity of capacitor load of corresponding rating. Auxiliary contacts shall be rated for at least 6a and shall be capable of carrying the maximum estimated current, also shall be break before make type. No volt coil working voltage shall be 360 V to 440 V. It should be complete with over current relay with single phasing protection.

**5.8. Thyristorised / Solid State Fast Response Pfc / Solid-State SSR Switching (Apfc Relay):**

**5.8.1.** The automatic power factor controller should be of 12 step microprocessor base and having following features. It shall form thyristorised / solid state fast response pfc / solid- state ssr

switching.

- 5.8.2.** Automatic step section depending upon the system power factor and targeted power factor, relay should sense the capacity of each bank automatically and accordingly only required nos of capacitor should be switched on in any case
- 5.8.3.** This controller should take sensing current and voltage from incomer of l.t. sides.
- 5.8.4.** Required epoxy cast resin C.t.'s for sensing for incomer should be supplied by the contractor. Summation c.t. (if required) should be supplied by the contractor. Apfc controller shall have rs 485 communication port
- 5.8.5.** Automatic selection of c/k ratio (min. Capacitor step size / c.t. ratio)
- 5.8.6.** Indication of real time p.f. with lagging or leading
- 5.8.7.** Prevent leading p.f. during low load condition
- 5.8.8.** Audio (hooter) and visual alarm with reset push button for low p.f. below targeted.
- 5.8.9.** Max. AcquISition time: - 2 sec.
- 5.8.10.** Smallest group to sense: - 5 kvar
- 5.8.11.** Type of switching: - thyristorised / solid state relay.
- 5.8.12.** Microprocessor based displaying system p.f., kvar, average power factor since reset, kvar per stage, system 3 phase voltage, current, power factor, kw, kvar, stage on off indication shall be included
- 5.8.13.** PFC should sense 3 phase kvar correctly even in unbalanced load 3 phase 4 wire systems.
- 5.8.14.** PFC should be provided with adequate harmonic filter in case of higher harmonic level of 3/5/7/9/11<sup>th</sup> harmonic more than 5 % or total thd more than 7%.
- 5.8.15.** It shall be capable of selecting and connecting right value of capacitors. To effect complete correction within 2 seconds by var sensing relay.
- 5.8.16.** The apfc relay should have rs-485 communication port to

communicate with computer.

**5.8.17.** The 12 steps p.f. controller should operate capacitor in 12 steps depending upon system power factor.

**5.8.18.** The capacitor must be disconnected in the event of power supply failure and should be protected against high inrush current, when power supply restored or at the time of automatic and time delayed switching of capacitor.

## **5.9. Capacitors:**

**5.9.1.** Supplying, installation, testing and commissioning of double layer app / extra low losses mdxl type, rated  $450 \pm 10\%$  volt, 50 hz., three phase, delta connected, capacitor in required bank/bunch size and having following features.

**5.9.2.** Watt losses total  $< 0.5w / kvar$ ,

**5.9.3.** Degree of protection IP 31, with safety feature like pressure sensitive disconnect or (over pressure tear off fuse), with discharge resistor,

**5.9.4.** Complete with minimum two earthing terminal, name plate rating etc.

**5.9.5.** Confirming to IS-2834/1986 and latest relevant is.

**5.9.6.** It shall be capable of coping with over voltage condition.

**5.9.7.** Above-mentioned capacitor banks should be connected with the outgoing feeders of the apfc panel. Capacitor should be supplied as per above-mentioned table.

**5.9.8.** All the capacitor should be tested in tpsecl / recognized laboratory and two copies of the test reports / certificates of the capacitors shall be submitted to the client. Catalogues / technical details of the capacitor shall be furnished along with technical bid of the tender.

**5.9.9.** After commissioning of whole automation system, contractor shall have to analyze the harmonic level of the whole system i.e. Harmonic level of thd of whole system if found more than 5.0%, then necessary instruments / systems like harmonic filter, output filter etc. Shall be supplied and fitted to control harmonic level of thd of whole system to achieve less than 5.0%, without



any extra cost.

### **5.10. Main bus bar:**

**5.10.1.** Three phase and neutral bus bar shall be designed for minimum specified rated current. Bus bar shall be high quality, air insulated, high conductivity, high strength, tinned copper with non-hygroscopic colored sleeve. Bus bar copper shall be electrolytic grade. Minimum bus bar size used must be derived by considering current density of bus bar and shall be mounted with standard bus bar SMC (seat molded compound) / dmc support at sufficient interval to avoid sag and effectively **withstand** electromagnetic stress in the event of short circuit capacity of 50 ka rms symmetrical for 1 sec. And pick short circuit current of 105 ka. The bus bar shall be housed in separate compartment and shall be isolated with at least 3mm thick Bakelite sheet or higher-grade material. Bus bar and panel board design shall be as per Indian electricity rule and CPRI norms and standards. Bus bar shall be extendible type for future expansion. Necessary cut out arrangement shall be provided for the same. The size of neutral bus bar shall be same as that of phase bus bar for main panel and lighting panel. The bus bar shall be arranged such that minimum distance between them does not remain lower than below.

Between phase	:	25 mm
Between phase and neutral	:	25 mm
Between phase and earth	:	25 mm
Between neutral and earth	:	20 mm.

**5.10.2.** The bus bar and interconnections shall be insulated with heat shrinkable PVC sleeve with standard color identification codes. The bus bar shall be connected by chromium plated or tinned plated brass bolts and nuts and washers shall be used for tightening. All connection between bus bar and circuit breaker/ switch and terminals shall be thoroughly insulated aluminum strips of proper size to carry rated current.

### **5.11. Time Switch**

**5.11.1.** Approved make time switch with single pole air break contacts suitable for 230 v / 16a, complete with self-starting motor driven clock on & off automatic arrangement at any predetermined time during each 24 hours, with nickel cadmium rechargeable battery backup erected as directed

**5.11.2.** Technical specification

Operating voltage	240 v ac
Supply frequency	50-60 hz
Power consumption	Less than 4 w
Ambient temperature	-10 0c to 55 0c
Clock accuracy	+/- 1 sec./day at 20 0c
Switching contact	2 c/o contact
Manual over ride	Provided
Mounting	Din rail

**5.12. Contactors:**

**5.12.1.** 32/70 amp. 500 v 50 hz tp high rupturing capacity contactors for incoming 3 phase, 4 wire, 440 v, 50 hz electric supply having following technical data.

5.12.1.1. Main poles - 3

5.12.1.2. Current rating minimum 32/70 amp.

5.12.1.3. Duty - ac 3

5.12.1.4. Terminal capacity - suitable for connecting 4 x 50 sq mm aluminum conductor cable with or without cable end socket.

**5.13. Panel Feeder Meter:**

**5.13.1.** It shall be provided for generator feeder. It shall be dialing flush mounted digital power meter. It shall have metering capacity of all three-phase voltage, current, KW, KVA, KVAR, pf, frequency phase angle. It should show three phase parameters at a same time on display. Instrument shall have measured capacity of accuracy class-1.

**5.14. Indication Lamp**

**5.14.1.** Indication lamp shall be led type panel mounted, low power

consumption, long life, o/l and s/c protected with its holders etc. Suitable for specified voltage shall be used.

On indication : red

Off indication : green

Trip indication : amber

### **5.15. Current Transformers**

**5.15.1.** The current transformers shall have synthetic cast resin insulation and be of the single-phase type, with number of cores as per the specific requirements.

**5.15.2.** The primary & secondary connections shall be clearly labeled.

**5.15.3.** All current transformers shall have insulation level and short time rating as per main switchgear. All current transformers shall be dimensioned to carry continuously a current of 120% of the rated current. The ratios shall be as per the specific requirements.

### **5.16. Voltage/Potential Transformer (PT):**

**5.16.1.** The voltage transformers shall be insulated for full voltage rating.

**5.16.2.** The pt shall have synthetic resin insulation and be of single-phase type. Rated secondary voltage shall be 110 V/v<sub>3</sub> unless otherwise specified.

**5.16.3.** Pt shall be capable of withstanding thermal and mechanical stresses resulting from short circuit and momentary current rating of breaker/switches.

### **5.17. Control Switches / Selector Switches:**

**5.17.1.** Control and meter selection switches shall have integral name plate and for all other devices, the same shall be located below the respective devices. Instrument and devices mounted on the face of the panels shall also be identified on the rear with the same number.

**5.17.2.** All control switches shall be rotary, back connected type having cam operation contact mechanism. Phosphor bronze contacts shall be used on switches

- 5.17.3.** The handle of control switches used for circuit breaker operation shall turn clockwise for closing and anti-clockwise for tripping and shall be spring return to neutral from close/trip with lost motion device.
- 5.17.4.** Control switch for dg and incomer panels shall have one set of lost motion spare contacts.
- 5.17.5.** Ammeter selector switches shall be with off position and with make before break feature and shall have 3 positions to read the three phase currents. Voltmeter selector switches shall also be of 3 positions and off position, suitable to read phase to phase voltages.
- 5.17.6.** The control switches, operating handles, meters, relays etc. shall be mounted at the front of the switchgear panels. The instruments shall not be mounted less than one meter or more than two meters from the floor level. Ammeters and voltmeters are to be provided with selector switches. Operating handles shall not be mounted at a height more than 1.75 meters. Breaker control switches wherever provided shall be so designed that when released by the operator it shall automatically return to a neutral position. They shall be fitted in sequence with lock to avoid inadvertent operation and shall be arranged such that after passing the "closed" position the control switch cannot be moved into the "closed" position again without passing the "open" position. Each panel shall have indicating lamps healthy" and spring charged" for "on", "off", "trip", "trip circuit".

## **5.18. Auxiliary Supply**

- 5.18.1.** Auxiliary dc and ac supply shall be derived from the incoming source of the panel with suitable control arrangements for indication circuits, closing circuits, space heaters etc.
- 5.18.2.** Separate dc insulated wire buses shall be provided. Dc supply required for protection/ indication/ tripping shall be taken from the above wire bus bars through protective fuses.
- 5.18.3.** Suitable fuses and links shall be provided for individual circuits for protection and also for isolation from bus wire without disturbing the other circuits. Bus wires from panel to panel shall

be wired through necessary control terminals.

**5.18.4.** Panel heaters and thermostats shall be provided in all the panels.

**5.19. Wiring And Controls:**

**5.19.1.** Control supply of each individual feeder shall be taken from the auxiliary contact of the MCB, so by switching the MCB, control supply of the concern feeder will be controlled. The main object of doing this is to cut-off power as well as control supply from the feeder at the time of maintenance / repairing. The wiring inside the modules for power and control protection and instrumentation shall be done using 1.1 kV grade, PVC insulated FRP copper conductor cables confirming to IS 694 and IS 8130. Power wiring inside the starter module shall be rated for full current rating of contactor but not less than 4.0 sqmm size. For c.t. 2.5 sq.mm. Cu. Wire shall be used whereas other control wiring shall be done using 1.5 sq. Mm wire. Control wiring and indicating lamps shall have protective fuses (hrc type). the necessary ferrules shall be fitted to all wire terminals for ease of identification. Only one conductor shall be permitted to one termination.

**5.20. Cable Compartment:**

**5.20.1.** Cable compartment should have adequate space to accommodate required number XLPE insulated copper or aluminum conductor both in incoming & outgoing. There should be ample space for the termination of this cable.

**5.21. Construction:**

**5.21.1.** The panel shall comprise fully compartmentalized bottom entry, extensible type cubicle pattern, and front operated, suitable for floor / stand mounting as per site requirement. The panel board shall be divided into distinct vertical sections comprising of completely metal enclosed bus compartment running horizontally

**5.21.2.** The schematic diagrams are intended as a guide and manufacturer shall develop his own general arrangement and schematic drawing adding necessary auxiliary devices, accessories, components peculiar to supplied equipment's,

ferrules number, terminal number etc. Which are required for safe, convenient, efficient a proper operation of the 415 volts switchboard / m.c.c.

**5.22. Following shall be taken care.**

- 5.22.1.** Main bus bar should be electrolytic tin copper type with heat shrinkable PVC sleeves with colour code.
- 5.22.2.** All internal wiring and all connection shall be with copper wires and strips as required. Copper flexible wire shall be used below 100 amps.
- 5.22.3.** All component, frame etc. shall be earthed. A common internal earth bar with two separate earthing leads shall be provided.
- 5.22.4.** Powder coating to be done on all sheet metal works as required.
- 5.22.5.** Panel should have MS base frame for floor mounting unless otherwise specified.
- 5.22.6.** The board should be front operated and extendible type.
- 5.22.7.** Compression type brass glands and crimping lugs for incoming and outgoing ends.
- 5.22.8.** All ammeters to be provided with CTs and selector switch and control fuses.
- 5.22.9.** Panel components shall be specified.
- 5.22.10.** The design and location of damp panel to be approved by the engineer in charge before fabrication and installation
- 5.22.11.** All panels should be dust and vermin proof.
- 5.22.12.** All panels should be fabricated out of 14 gauges CRCA sheet. The door should be made from 14-gauge CRCA sheet.
- 5.22.13.** All meters should be digital type only unless and otherwise specified.
- 5.22.14.** Panel builder shall be CPRI approved.
- 5.22.15.** The board should meet with requirement of IS 2147/1962.
- 5.22.16.** All the switches used should be capable of withstanding the ac23 duty for motor operation. The switches should have quick break. The contacts should be silverplated double break type.

The switch should confirm to IEC 947-iii.

- 5.22.17.** If it is possible panel component as well as accessories should be one make.
- 5.22.18.** The board should with stand the system prospective fault current.
- 5.22.19.** The switches shall confirm to IS: 4047 the fuses shall conform to IS: 220 the fuses shall be of h.r.c. type.
- 5.22.20.** Engraved plastic labels shall be provided indicating the feeder details, capacity, cable size, and load in kW and danger signs.
- 5.22.21.** The entire panel board should be with adequate height width & depth as per relevant prevailing standard
- 5.22.22.** Include foundation bolts of suitable size as per requirement.
- 5.22.23.** All compartment doors must have hidden hinges, a "on" switch, and a mechanism that automatically locks the door handles to prevent the door from opening when the feeder handle is in the open position.
- 5.22.24.** Detailed drawing shall be got approved prior to manufacture.
- 5.22.25.** If required only front opened and operated panel for ldb and ahu panels will be accepted.
- 5.22.26.** If capacitors of apfcr panels are not mounted in the panel itself than separate closed / covered rack with sufficient ventilation shall be included.
- 5.22.27.** Engraved PVC labels shall be provided on incoming and outgoing feeders.
- 5.22.28.** SLD showing circuit inside the d. B. Shall be posted inside of door and covered with transparent laminated plastic sheet.
- 5.22.29.** The name plate with panel designation shall be fixed at the top of central panel. And name plate showing feeder details shall be provided on each feeder module as well as termination door.

### **5.23. General requirement of the panel**

- 5.23.1.** The tenderer must have CPRI approval for manufacturing panel for the tenderer, who has not CPRI approval, has to

make panel from CPRI approved panel manufacturer only.

- 5.23.2.** Each switch fuse unit must be complete with the operating handle interlock; suitable h.r.c. fuses etc. as per site requirement.
- 5.23.3.** The entire l.t. switch gear unit should conform to IS-13947.
- 5.23.4.** All the CTs shall have cast resin type only with class i accuracy and each ct should have short link.
- 5.23.5.** Indication lamp shall be led type panel mounted, low power consumption, min.100000 hours of life, o/l and s/c protected with its holders etc. Suitable for specified voltage shall be used.
- 5.23.6.** All the measuring instruments should be of accuracy class 1.0.
- 5.23.7.** Each door of the panel should be earthed separately by flexible link.
- 5.23.8.** The above cubicle pattern l.t. switch board comprising of incoming and outgoing described above must be complete with necessary floor stands, foundations bolts, copper inter connections between bus bars and incoming / outgoing / ats / variable frequency drive, inter wiring with PVC copper cables, labels marked for incoming /outgoing / ats / variable frequency drive, earthing terminal etc. And other required major / minor items.
- 5.23.9.** All internal wiring work should be permanently marked / labelled at terminations with numbers or letters corresponding to diagram.
- 5.23.10.** A copper earth with bus must also run throughout the panel.
- 5.23.11.** Ample space in each compartment shall be provided for easy maintenance and repairing.
- 5.23.12.** Extra fans should be provided for cooling the panel if required and as per directed by engineer-in-charge
- 5.23.13.** The complete board should be scraped, cleaned and painted coat at manufacturer's works as per relevant is an easy access to bus bar should be with powder coated paint after application of 7 tank process and primer using siemens grey



shade kept for testing, maintenance and checking. The board should be prepared and erected in accordance with the prevailing Indian electricity rules and regulations. The appearance of the panel board should be neat, clean and pleasant. The panel should be fabricated from suitable size angles and 14 swg CRCA sheet steel and angle / channel iron sections. Sufficient space should be available for cable jointing. All live parts must be covered with non- hygroscopic insulated sheet. The lifting lugs / hooks should also be provided for handling the board. The necessary sufficient louvers should be provided for heat dissipation and air cooling.

**5.23.14.** The space requirement for board must be specified. The board is to be installed on the r.c.c. platform having cable trench 1.0 meter. Size. Cable entry to panel board should be at bottom long. A floor stand and operating platform having minimum width of 1 meter. Should also be incorporated.

#### **5.24. Safety Shutter Devices:**

**5.24.1.** Shutters shall be provided at bus bar chamber cut out for closing the same when the drawable chassis of the modules are drawn out.

**5.24.2.** The bus bar shutters shall be automatically operated by the movement of the carriage.

#### **5.25. Insulators:**

**5.25.1.** Insulators of moulded or resin bonded material shall have a durable, non-hygroscopic surface finish having a high anti-tracking index. Insulators, barriers made out of hylam, synthetic resin bonded paper, treated wood will not to be accepted.

**5.25.2.** Insulators shall be mounted on the switchgear structure such that there is no likelihood of their being mechanically overstressed, during normal tightening of the mounting and bus bars, connections etc.

#### **5.26. Earthing:**

**5.26.1.** Copper earth bar of minimum 25mm x 3mm (or specified size) size shall be run through whole length of panel. The frame work

of panels shall be connected to this earth bar and it shall be provided to facilitate connection with main earth coming from earth pit on both sides of panels. The earth continuity conductor of each in/out feeder shall be connected to this earth bar. The armor shall be properly connected to earthing clamp, and clamp shall be ultimately bonded with earth bar.

**5.27. Danger board:**

- 5.27.1. 440-volt danger board as per IS: 2551-1982 in English and Gujarati shall be fixed on all sides of panel.
- 5.27.2. The board shall be glass enameled with red background and white letterings.
- 5.27.3. The danger notice plate shall be made out of 1.6mm thick mild steel sheet. Approximate size should be 200mm x 150 mm.
- 5.27.4. The letters, figures, the conventional skull and bones etc shall be positioned on the plate as per IS 2551-1982. The said figures & pictures shall be painted in single red color as per is5-1978

**5.28. Painting:**

- 5.28.1. The panel shall undergo chemical de-rusting and blasting and shall be effectively prophesied as per is-6005. The panel shall be thoroughly rinsed with clean water after phosphate followed by final rinse with dilute dichromate solution and even drying. The phosphate coating shall be scaled by the application of two coats of ready mixed staving type zinc chromate primer.
- 5.28.2. Two coats of finishing powder coated paint shall be applied. The final finished thickness of paint film on steel shall not be less than 100 microns and shall not be more than 150 microns. The color for the finishing paint shall be approved by the engineer. The finished appearance of panels shall present an aesthetically pleasing appearance free from dust and uneven surfaces.

**5.29. Brief description of the atomization:**

- 5.29.1. The atomization is meant to control the acbs, MCCBs, contactors and other switchgears fully automatically as directed in drawing or elsewhere. The main features to be take care are.

- 5.29.1.1. The bus coupler acb must be off when any generator is on load or outgoing from dg or incoming from dg to It main panel ACB is on
- 5.29.1.2. The apfcr and fixed capacitors feeders must be electromechanically interlocked in such a way that, any of the capacitor does not come in line when any dg is on load.
- 5.29.1.3. The transformer outgoing acb (incomer-1 of main LT panel) and outgoing acb of dg as well as incomer or main LT panel can never be "on" together.
- 5.29.1.4. All the switchgears should be mechanically interlocked in such a way that, all above conditions must be fulfilled even on manual mode of operation of dg / acbs.
- 5.29.1.5. If client needs to provide additional back-up protection of reverse current / reverse powers relay it must be included.

### **5.30. Tests and inspection:**

- 5.30.1. All site tests as per Indian standards and high voltage test of bus bars in presence of engineer-in-charge.

### **5.31. Drawings:**

- 5.32. Manufacturers shall submit for approval the single line, general arrangement drawing including material list, accessories, components peculiar to supplied equipments, ferrules numbers, terminal numbers, foundation drawings and control wiring drawings. Approval of schematic drawings, single line and control wiring drawings shall be obtained before starting the manufacturing of panel board. Manufacturer shall submit the 04 copies of final prints with laminations and 01 reproducible tracing of each and every drawing. Out of these 04 copies, 01 copy should be affixed in the panel as directed by engineer-in-charge.

### **5.33. Test certificates**

- 5.33.1. Type test certificates of all standard component parts, e.g.

Contactors, breakers, switches, fuses, relays, ct's, vt's and for the standard factory-built assembly shall be submitted by the supplier.

#### **5.34. instruction manuals**

- 5.34.1.** The supplier shall furnish specified number of copies of the instruction manual which would contain detailed instructions for all operational & maintenance requirement. The manual shall be furnished at the time of dispatch of the equipment and shall include the following aspects:
- 5.34.2.** Outline dimension drawings showing relevant cross-sectional views, earthing details and constructional features.
- 5.34.3.** Rated voltages, current, duty-cycle and all other technical information, which may be necessary for correct operation of the switchgear.
- 5.34.4.** Catalogue numbers of all components liable to be replaced during the life of the switchgear.
- 5.34.5.** Storage for prolonged duration.
- 5.34.6.** Unpacking.
- 5.34.7.** Handling at site.
- 5.34.8.** Erection.
- 5.34.9.** Pre commissioning tests.
- 5.34.10.** Operating procedures
- 5.34.11.** Maintenance procedures.
- 5.34.12.** Precautions to be taken during operation and maintenance work.

#### **5.35. Workmanship**

- 5.35.1.** The panel should be fabricated from CPRI approved panel manufacturer, each switch fuse unit must be complete with the operating handle interlock, suitable h.r.c. fuses etc. as per site requirement. All the l.t. switch gear unit should be should be of the same company.
- 5.35.2.** All the CTs shall have cast resin type only and each CT should

have short link. Indication lamp shall be led type panel mounted, low power consumption, min.100000 hours of life, o/l and s/c protected with its holders etc. Suitable for specified voltage shall be used.

- 5.35.3.** All the measuring instruments should be of accuracy class 1.0 each door of the panel should be earthed separately by flexible link. The above cubicle pattern I.t. switch board comprising of incoming and outgoing described above must be complete with necessary floor stands, foundations bolts, copper inter connections between bus bars and incoming / outgoing / ats / variable frequency drive, inter wiring with PVC copper cables, labels marked for incoming /outgoing / ats / variable frequency drive, earthing terminal etc. And other required major / minor items.
- 5.35.4.** All internal wiring work should be permanently marked / labelled at terminations with numbers or letters corresponding to diagram. A copper earth with bus must also run throughout the panel.
- 5.35.5.** Ample space in each compartment shall be provided for easy maintenance and repairing.
- 5.35.6.** The required size capacitor bank with thyristorised base apfc relay should be incorporate inside all PCC, lighting, HVACS panel, where ever required.
- 5.35.7.** Extra fans should be provided for cooling the panel if required and as per directed by consultant / engineer-in-charge

## **6. DOL starter**

### **6.1. Material specification**

- 6.1.1.** Applicable standards: IS: 13947 (part 4/sec1) 1993: low voltage switchgear and control gear: part 4 contractors and motor starters, sec 1 electromechanical contactors and motor starters [superseding is 2959 & is 8544 (all parts)] (amendment 1)
- 6.1.2.** Operation range should be -20% to + 15% of rated coil voltage
- 6.1.3.** Suitable for intermittent duty class 30
- 6.1.4.** Under-voltage protection below 40% of rated voltage.

**6.1.5.** Adequate space and terminal sizes for terminations of recommended cables of either copper or aluminum, easy to install and maintain.

**6.1.6.** Starter enclosure should be minimum ip-53.

## **6.2. Workmanship**

**6.2.1.** Direct on line should be made from 16 g CRCA sheet duly epoxy powder painted

**6.2.2.** Inside and outside with hinge door and locking arrangement consisting of suitable size of on-off isolated (AC-3/23 duty) main fuses, single phasing prevented. Indicating lamp for r-y-b phases overload relay, automatic water level controller, a meter, volt meter each with selected switch incoming wire duly socket crimped, main contactor start-stop push button to be erected on angle iron frame grouted on wall as directed.

## **7. Indoor & Outdoor Lighting Equipments**

### **7.1. General material specification**

**7.1.1.** This section relates to technical specification for indoor & outdoor lighting equipments of the project.

**7.1.2.** All fixtures shall be complete with accessories necessary for installation whether so detailed under fixture description or not.

**7.1.3.** Fixture housing, frame or canopy shall provide a suitable cover for the fixture outlet box or fixture opening.

**7.1.4.** Fixtures shall be installed at mounting heights as detailed on the drawings or instructed on site by the engineer in charge.

**7.1.5.** Fixtures and/or fixture outlet boxes shall be provided with hangers to adequately support the complete weight of the fixture. Design of hangers and method of fastening other than shown on the drawings or herein specified shall be submitted to the engineer in charge for approval.

**7.1.6.** Pendant fixtures within the same room or area shall be installed plumb and at a uniform height from the finished floor. Adjustment of height shall be made during installation as per engineer in charge instructions.

- 7.1.7.** Flush mounted and recessed fixtures shall be installed so as to completely eliminate light leakage within the fixture and between the fixture and adjacent finished surface.
- 7.1.8.** Fixture mounted on outlet boxes shall be tightly secured to a fixture stud in the outlet box. Extension pieces shall be installed where required to facilitate proper installation.
- 7.1.9.** Fixture shall be completely wired and constructed to comply with the regulations and standards for electric lighting fixtures, unless otherwise specified. Fixtures shall bear manufacturer's name and the factory inspection label unless otherwise approved.
- 7.1.10.** Wiring within the fixture and for connection to the branch circuit wiring shall not be less than 2.5 sqmm copper for 250 volt applications. Wire insulation shall suit the temperature conditions inside the fixture and wires bypassing the choke/ballast shall be heat protected with a heat resistant sleeve.
- 7.1.11.** Metal used in lighting fixtures shall be not less than 22 swg or heavier if so required to comply with the specification or standards. Sheet steel reflectors shall have a thickness of not less than 20 SWG. The metal parts of the fixtures shall be completely free from burrs and tool marks. Solder shall not be used as mechanical fastening device on any part of the fixture.
- 7.1.12.** Ferrous metal shall be bowdlerized and given a corrosion resistant phosphate treatment or other approved rust inhibiting prime coat to provide a rust-proof base before application of finish.
- 7.1.13.** Non-reflecting surfaces such as fixture frames and trim shall be finished in baked enamel paint.
- 7.1.14.** Light reflecting surface shall be finished in baked white enamel having a reflection factor of not less than 80%. All parts of reflector shall be completely covered by finish and free from irregularities. After finish has been applied and cured, it shall be capable of withstanding a 6 mm radius bend without showing sign of cracking, peeling or loosening from the base metal. Finish shall be capable of withstanding 72 hours exposure to an ultraviolet sun lamp placed 10 cm from the surface without discoloration, hardening or warping and retain the same reflection factor after exposure. Test results shall be furnished

for each lot of fixtures.

- 7.1.15.** Fixture with visible frames shall have concealed hinged and catches. Pendant fixtures and lamp holders shall be provided with ball type Algiers or similar approved means. Recessed fixtures shall be constructed so as to fit into an acoustic tile ceiling or plaster ceiling without distorting either the fixture or the ceiling plaster rings/flanges shall be provided for plaster ceiling. Fixtures with hinged diffuser doors shall be provided with spring clips or other retaining device prevent the diffuser from moving.
- 7.1.16.** Detailed catalogue cuts for all fixtures, or, if so, required by the engineer in charge sample fixtures shall be submitted for approval to the architect/consultant before orders for the fixtures are placed. Shop drawings for non-standard fixture types shall be submitted for approval to the architect/consultant.
- 7.1.17.** Recessed fixtures shall be constructed so that all components are replaceable without removing housing from the ceiling.

## **7.2. Lamps:**

- 7.2.1.** Lamps shall be supplied and installed in all lighting fixtures furnished under this contract. All lamps shall be rated for 250 volts.
- 7.2.2.** Lamps used for temporary lighting service shall not be used in the final lighting of fixtures units.
- 7.2.3.** Lamps shall be of wattage and type as shown on the drawings and schedule. Where not shown, the details shall be ascertained from the architect / engineer in charge before procurement.
- 7.2.4.** Lamps for permanent installation shall not be placed in the fixtures until so directed by the architect / engineer in charge, and this shall be accomplished directly before the building portions are ready for occupation.
- 7.2.5.** Lamp should be of the same make as of control gear/ballast.

## **7.3. Fluorescent fittings with hi - frequency ballast:**

- 7.3.1.** Only single and/or two lamp ballast shall be used in any one fixture. Ballast shall be completely enclosed inside sheet steel casing and shall have corrosion - resistant finish. Ballast shall



contain a thermosetting type compound not subject to softening or liquefying under any operating conditions or upon ballast failure. Compound shall not support combustion. All ballast shall be of high-power factor compensated to above 0.9pf. Ballast temperature and sound rating shall be specified by the manufacturer and guaranteed. Ballast shall be for operation at the voltages and frequencies indicated and under temperature conditions prevailing in the various locations of the premises. Tapped ballast is preferred.

- 7.3.2.** Ballast general/technical specification must be within the specified limit as mentioned in is 13021 part – I & II with latest amendments. The e.m.i & r.f.i values must be as per is 6842 with latest amendments, if any. The ballast should have over voltage protection circuit and transient/spike suppression circuit. Total harmonic distortion should be less than or equal to 33%, current crest factor (peak/rms current value) should be  $\leq 2$ .
- 7.3.3.** All fluorescent fixtures shall be provided with separate wiring channel with cover plate and an earth terminal. All screws shall be chromium brass screws. Lamp and starter holders shall be out of tough molded plastic with spring loaded rotor type contactors rendered shock and vibration proof. Condensers shall be low loss paper impregnated hermetically sealed complying with is 1969-196. Internal wiring shall be neatly clipped and where by passing the ballast, a suitable heat resistant barrier or sleeve shall be provided.
- 7.3.4.** Minimum working (burning) life of fluorescent lamp should be more than or equal to 15000 hours. (Necessary confirmation must be sought from the manufacturer). Lamp lumen output should be  $\geq 91$  lumen/watt. Depreciation of lumen output over life span of lamp should not exceed 10%.
- 7.3.5.** The combined power factor should be more than or equal to 0.92 at 230 volts.
- 7.3.6.** Surface mounted fixtures longer than two feet shall have one additional point of support besides the outlet box fixture stud when installed individually. Pendant individually mounted fixtures four feet long and smaller shall be provided with twin

stem/conduit hangers. Stems shall have ball aligners or similar devices and provided for a minimum of 25 mm vertical adjustment. Stem shall be of appropriate length to suspend fixtures at required mounting height.

**7.3.7.** Lamps shall have bi-pin bases and a minimum approximate rating.

## **7.4. Emergency lighting**

**7.4.1.** Code & standards:

7.4.1.1. National building code of India : SP: 7 2005

Specification for emergency lighting unit IS: 9583-1981

Code of practice for safety colors and safety signs IS:  
9457-1980

Fire protection safety sign IS: 12349-1988

Fire safety in hotels-code of practice IS: 13716

7.4.1.2. Code of practice for fire safety of building(general)

Exit requirement and personal hazards IS: 1644-1988

Code of practice for fire safety of building (electrical  
Installation) IS: 1646

Graphic symbols for fire protection plans IS: 12407-1988

**7.4.2.** Technical specifications:

7.4.2.1. Ac supply for charging of battery: 240V AC, 50/60 Hz.

7.4.2.2. Recharging period should be 10-12 hours and regulated battery charging with constant voltage tapering current characteristics and goes into trickle charge when the battery attains full charge

7.4.2.3. Emergency light switches on instantly on ac mains failure. Switches off automatically and reverts back to battery charging mode after supply resumption.

7.4.2.4. Automatic low battery cut-off.

7.4.2.5. Over voltage protection

7.4.2.6. Manual switch for switching of emergency light when not required.

- 7.4.2.7. Rugged metal body with powder coated finish.
- 7.4.2.8. ProvisIon of wall mounting of the light fixture should be provided.
- 7.4.2.9. It should be with ni-mh/ni-cd rechargeable battery of constant current charge type.
- 7.4.2.10. All emergency lighting should be tested in accordance with en60598-2-22.
- 7.4.2.11. Inbuilt push test switch should be provided.
- 7.4.2.12. Battery backup: 3 hours for emergency signages & 1 hour for the emergency light

## **7.5. Decorative post top lantern / flood light fixtures**

- 7.5.1. The light fixture construction shall be of die cast aluminum or otherwise as specified with a separate compartment for integral ballast equipment. The reflector shall be anodized polished aluminum. The glass reflector shall be heat-resistant.
- 7.5.2. Lamp holder shall be of porcelain and shall comprise of a terminal block of non- hygroscopic material. The luminaries shall have integral ballast housed in water tight and dust tight metal cases. Ballast shall be pre-wired to the lamp socket and terminal block, requiring only power supply leads to the ballast primary terminals.
- 7.5.3. The light fixtures shall be minimum IP66 unless until mentioned in the schedule.

## **7.6. Earthing**

- 7.6.1. All the light fixtures, indoor & outdoor, shall be properly earthed by means of copper conductor as mentioned elsewhere in this document.

## **7.7. Special notes**

- 7.7.1. The successful tenderer will have to supply the makes from above in consultation with the client/architect/consultant without any extra cost.
- 7.7.2. Tenderer should have to specify the list of makes considered in

the tender while quoting the rates in the tender, in covering letter of separate letter enclosure. However, the final decision for accepting make specified by tenderer would be of engineer in charge / architect.

**7.7.3.** As far as possible, the successful tenderer will have to place order directly to the manufacturer or its authorized dealer. The engineer in charge have right to check the challans of supplier.

**7.7.4.** Make of components required to be used by contractor to complete the installation, if not mentioned anywhere, shall be required to get it approved by engineer in charge before installation in writing.

**7.7.5.** Within a week of work order, the contractor shall submit the sample and/or catalogue of each item / component of above mentioned approved make for the approval of the engineer in charge / architect.

**7.7.6.** The contractor should have to prepare full fledge lighting demo of each kind of light fixtures as per instruction of engineer in charge / architect for approval at no extra cost.

## **7.8. Workmanship**

**7.8.1.** The fixture shall be installed as per manufacturer's instruction, with all necessary accessories. The job also includes connection of fixture with respective outlet point with heat resistant wires through heat resistance sleeve and PVC connector. Proper earthing shall be provided to the fixtures.

**7.8.2.** The contractor has to work in co-ordination with existing contract. The conduits are already laid in the slab by existing contractor. The contractor has to solve any dispute mutually and practically regarding existing work done by existing contractor.

## **8. Decorative Lighting poles**

**8.1.** GI Lighting pole should confirm to I.S. 2713-1980 with latest amendment

**8.2.** The pole shall be provided with 12mm diameter tapped hole with bolt nut welded for earthing at suitable height as directed by Engineer-in-

charge.

- 8.3.** The Pole shall be painted with one coat of red oxide and two coats of aluminum paint after erection prior to commissioning.
- 8.4.** Please refer section 24 of material specification for details of B class GI Pipe
- 8.5.** Decorative Pole, with Base Plate made out of G.I tubular pole, prime red and painted.
- 8.6.** The column shall also be provided with flush door at the bottom with proper strengthening to the cutout of the door opening.
- 8.7.** A junction / looping box with Heavy duty 3 phase connector shall be built into the pole.
- 8.8.** The Pole shall be painted two coats of polyurethane based Paint.
- 8.9.** MCB of required rating to be provided with pole.

**8.10. Workmanship**

- 8.10.1.** The lighting poles shall be fabricated from heavy duty cold-rolled MS pips and painted as specified. The pole shall have a base plate, a large access panel, and necessary fixture mounting bracket at top. The access panel shall provide easy access to a multi- way porcelain connector and fuse/MCB board, to be mounted inside the pole. The access shall be specially fabricated with adequate reinforcement and weather gasket to prevent ingress of moisture and vandal proof. Poles shall have large diameter entries for incoming and outgoing cable and two earth studs. The pole fabrication shall conform to the drawings and where such drawing is not available; the contractor shall make such drawing and have it approved before fabrication.
- 8.10.2.** The pole shall house a multi-way terminal block and MCB as shown on the drawings.
- 8.10.3.** Foundation bolts & nuts shall be provided with the pole

**9. Poles Foundation**

## **9.1. Material specification**

**9.1.1.** 1:2:4 cement concrete foundation (along with base plate and cable guard pipe and earthing wire etc. Which are included in other item) of 450mm x 450mm x 900 mm length for 4-meter poles, 600mm x 600mm x 1200mm for pole up to 8.5 mtrs height, 600mm x 600mm x 1500mm for pole up to 8.5 mtrs height, with necessary plastering and colour washing for pole. The item includes excavation and supply of cement, sand, kapachi, grit etc. By the contractor. The contractor should make necessary arrangement for water required for the works at his own cost. The site should be cleaned off excess material after the work is completed.

## **9.2. Workmanship**

**9.2.1.** The foundation with necessary plastering and colour washing shall be arranged for pole for good finishing of the foundation

## **10. Pole Box:**

### **10.1. Material specification**

**10.1.1.** Sintex or approved make SMC press moulded composite frp (plastic) loop-in, loop- out box approx. 207mm thick complete with Bakelite connector strip 4 way & hinged doors having locking arrangements with mounting clamp with nuts, bolts & washers suitable for erection on pole with cable clamp & earth bolt of following size of box. (a) 300mm x 200mm x 100mm

**10.1.2.** Press moulded composite FRP (plastic) loop- in, loop-out, dust & water proof, junction box, minimum 2 mm thick (Sintex or equivalent), with doors hinged on top side (open able from bottom to top) having locking arrangements, with above mentioned size.

**10.1.3.** Should be provided with 6-amp sp MCB 10ka.

### **10.2. Workmanship**

**10.2.1.** GI mounting clamp with nuts, bolts & washers suitable for erection on pole with cable clamps & earth bolt.

**10.2.2.** The box should have prov ISI on for 2 nos. (or 3 nos. If

required) cable entries suitable for size of the cable. The box should be so designed to prevent ingress of foreign material including rainwater.

**10.2.3.** The box should accommodate the following:

**10.2.4.** For the poles of 4 m height the junction box sintex or equivalent make SMC press moulded composite frp (plastic) to be fixed on streetlight pole with suitable g.i. clamp and bolts, nuts.

**10.2.5.** A danger notice caution sticker should be fixed on junction box.

**10.2.6.** Each box should be complete with earthing strip for cable (armoured) termination and earthing bolts for the same.

## **11. Ceiling Fan, Regulators and Clamps:**

### **11.1. Material specification**

**11.1.1.** Ceiling fan should follow the below mentioned standards

11.1.1.1. IS 374(part 0/sec 0):1979 : electric ceiling type fans and regulators(third Rev. ISI on)

11.1.1.2. IS 2997(part 0/sec 0):1964 : air circulator type electric fans and regulators

11.1.1.3. IS 302 (part 2/sec 80):2003 : safety of household and similar electrical Appliances

11.1.1.4. Part 2 particular requirements, sec 80 fans (superseding is 12155:1987)

**11.1.2.** Ceiling fans including their suspension shall conform to relevant ISS with secondary safety device incorporated against free fall of fans from their hooks.

**11.1.3.** Fan hooks made of M.S. rods of 15mm diameter shaped in 'u' form with their legs projecting horizontally on the top at least 19 cm on either side and tied over the top reinforcement of the roof shall be laid in the concrete slabs.

**11.1.4.** The body of the ceiling fan, exhaust fan and fan regulator shall be connected to the earthing system by proper earth leads.

### **11.2. Workmanship**

**11.2.1.** The all-ceiling fans shall be wired to ceiling roses or to special

connector boxes and suspended from hooks or shackles. There shall be no joints in the suspension rod.

- 11.2.2.** In case of "I" beams, the suspension arrangements fabricated out of M.S. plates shall be shaped suitably to catch the flanges and shall be held together by means of laying bolts, nuts, check nut and split pin.
- 11.2.3.** For concrete roofs, ceiling fans hooks shall be got buried in the concrete during construction.
- 11.2.4.** The suspension arrangement for the fans shall be so designed that the fans canopies shall completely hide suspension element.
- 11.2.5.** Unless otherwise specified all ceiling fans shall be hung 2.75m above the floor.
- 11.2.6.** In the case of measurement of extra down rod for ceiling fans including wiring, the same shall be measured in units of 10 cms & length less than 5 cm shall be ignored. The cost of wiring for extra down rod shall be paid as per supplying and drawing cable in existing conduits

## **12. Exhaust Fans**

### **12.1. Material specification**

- 12.1.1.** Exhaust fans shall conform to is 302(part 2/sec 80):2003: safety of household and similar electrical appliances: part 2 particular requirements, sec 80 fans (superseding is 12155:1987) and other relevant iss.
- 12.1.2.** It should be reversible fresh air cum exhaust fan

### **12.2. Workmanship**

- 12.2.1.** The exhaust fans shall be erected at the places indicated by the engineer-in-charge. For fixing exhaust fans a circular opening shall be provided in the wall to suit the size of the frame, which would be fixed by means of rag bolts, embedded in the walls, opening shall be neatly plastered to the original finish of the wall. The exhaust fan shall be wired as near to the opening as possible by means of flexible cord. Care being taken that the blades rotate in the proper direction.



**12.2.2.** The exhaust fan for installation in corrosive atmosphere shall be painted with special PVC paint or chlorinated rubber paint. Installation of exhaust fan in kitchen, dark room and such other special locations shall be carried out giving due consideration for the specific requirements.

**12.2.3.** The body of the ceiling fan, exhaust fan and fan regulator shall be connected to the earthing system by proper earth leads.

### **13. MS Fabricated Items.**

#### **13.1. Material specification**

**13.1.1.** Materials: all structural steel shall conform to I.S. 226-1975. The steel shall be free from the defects mentioned in I.S. 226-1975 and shall have a smooth finish. The material shall be free from loose mill scale, rust pits or other defects affecting the strength and durability. Rivet bars shall conform to I.S. 1148-1992.

**13.1.2.** When the steel is supplied by the contractor test certificates of the manufacturer shall be obtained according to I.S. 226-1975 and other relevant Indian standards

#### **13.2. Workmanship**

**13.2.1.** The steel section as specified or required shall be cut square and to correct length as per drawing and design. The cut ends exposed to view shall be finished smooth. No two pieces shall be welded or otherwise jointed to make of the required length of member, except as indicated in the drawings or as directed. All straightening and shaping to form shall be done by application of pressure and not by hammering. Any bending or cutting shall be carried out in such a manner as not to impair the strength of the metal. All operations shall be done in cold state unless otherwise directed / permitted.

**13.2.2.** Steel riveted or bolted in built up sections, framework.

**13.2.3.** The steel structure as shown in the drawings or as per directions of the engineer-in charge shall be laid out on a level platform to full scale and to full size or in parts. A steel tape shall be used for measurements to ensure maximum accuracy.

**13.2.4.** Wooden templates 12 mm to 19 mm thick or metal steel

templates shall be made to correspond to each connecting gusset plate and rivet holes shall be accurately marked on them and drilled. The templates shall be laid on the steel members and holes of the steel members shall also be marked for cutting. The base of steel columns and the position of anchor bolts shall be carefully set out.

- 13.2.5.** All stiffeners shall be formed by pressure and where practicable, the metal shall not be cut and welded in making these. In major works or where so specified, shop drawings giving complete details and information for the fabrication of the component parts of the structure, including location, type size, length and details of rivets, bolts, or weld shall be prepared in advance of the actual fabrication and as approved. The drawings shall indicate the shop and field rivets and bolts. The steel members shall be distinctly marked or stencilled with paint with the identification marks as given in the shop drawings.
- 13.2.6.** The bars shall be thickened at the ends, so as to provide for screwed threads and gradually tapered off to meet their normal sections.
- 13.2.7.** Great accuracy shall be observed in fabrication of various members so that this can be assembled without being unduly packed, strained, or forced into position and when built up, shall be true and free from twists, blinks, buckles or open joints. Before making holes in individual members for fabrication the steel work intended to be riveted or bolted together shall be as embedded or clamped properly and tightly so as to ensure close abutting or lapping of the surfaces of the different members. All stiffeners shall bear tightly both at top and bottom without being drawn or caulked. The abutting joints shall be cut or dressed true and straight and fitted close together.
- 13.2.8.** Web splice plates and fillers under stiffeners shall be cut to fit within 3 mm or flange angles, web plates of girders shall have no cover plates shall have their ends flush with the top of angles forming the flanges unless otherwise required. The web plates when spliced shall have clearance of not more than 6 mm.
- 13.2.9.** The erection, clearance for cleared ends of members connecting

steel to steel shall preferably be not greater than 1.5 mm. The erection clearance at the ends of beams without web cleats shall not be more than 3 mm at each end but where for a practical reason greater clearance is necessary, suitably designed neating shall be provided.

**13.2.10.** Pins and rollers shall be accurately turned to gauge. These shall be straight and smooth and free from flaws. The roller bearing shall be provided with adequate arrangements for holding the girders of truss resting on it. In columns caps and bases, the ends of shafts together with the attached gusset angles, channels etc. After riveting together shall be accurately mechanized so that the paths connected but against each other over the entire surfaces of contact connecting angles or channels shall be fabricated and placed in position with greater accuracy so that they are not unduly reduced in thickness by machining.

**13.2.11.** The ends of bearing stiffeners shall be mechanized or ground to fit tightly both at the top and bottom. All holes shall generally be drilled to the required size and at required position. Sub punching shall be permitted, provided it is done 3 mm or less in diameter and remerged thereafter to the required size. The holes for rivets and bolts shall be larger by 0.4 to 6 mm than the nominal diameter of rivets or black bolts depending upon the diameter of rivets.

**13.2.12.** Holes shall have their axis perpendicular to the surface bored through. The drilling or remerging shall be free from burrs, and the holes should be clean and accurate holes for countersunk bolts shall be made in such a manner that their heads fit flush with the surface after fixing.

**13.2.13.** The fabrication work shall be completed in workshop as far as it is practicable to do so. Site joints shall be done with rivets and fitted bolts or black bolts, as shown in the drawing or as directed. Generally, the following principles shall govern the use of rivets turned and fitted bolts and black bolts.

**13.2.14.** Rivets and turned and fitted bolts shall be used where the connection is such that slip under load has to be avoided.

**13.2.15.** Black bolts may be used very sparingly where a force is

carried through a connection without impact, vibration or reversal of stresses.

**13.2.16. Riveting:**

- 13.2.16.1. The parts assembled for riveting shall be in close contact with each other and the bearing stiffeners shall bear tightly both top and bottom without being drawn or caulked. Members to be riveted shall be properly pinned or bolted and rigidly held together while riveting. Drifting of holes shall not be permitted except to draw the parts together and the drifting tools so used shall have maximum diameter not exceeding the nominal diameter of rivets or bolts. Drifting done during assembling shall not distort the metal or enlarge the holes.
- 13.2.16.2. The shanks of rivets shall project beyond the plate surface sufficiently so as to fill the hole thoroughly and form the required head after riveting.
- 13.2.16.3. The riveting shall be done by hydraulic or pneumatic process. However, where such facilities are not available hand riveting may be permitted. The rivet shall be heated red hot, care being taken to control the temperature of heating so as not to burn the steel. Rivets of diameter less than 10 mm may be fitted cold. Rivets shall be of heat finish with heads full and of equal size. All loose burnt or badly formed rivets with concentric or deficient heads shall be cut out and replaced. The heads of rivets shall be central to shanks and shall grip the assembled members firmly. In cutting out rivets, care shall be taken so as not to injure the assembled members caulking or reoccupying shall not be permitted.
- 13.2.16.4. For testing rivets, a hammer weighing approximately 0.25 kg shall be used. Both heads of the rivets shall be tapped slack rivets will give a hollow sound and a jar.
- 13.2.16.5. All rivets' heads shall be painted with red lead paint within a week of their fixing.

### **13.2.17. Bolting**

- 13.2.17.1. All bolts and nuts shall be hexagonal and of equal size unless specified otherwise. The screwed heads shall conform to I.S. 1363-1960 and the threaded surface shall not be tapered. The bolts shall be of such length so as to project two clear threads beyond the nuts when fixed in position and these shall fit in the holes without any shakes. The nut shall be fit in the threaded ends of bolts properly.
- 13.2.17.2. Where turned and fitted bolts are required to be used in place of rivets there shall be provided with washers not less than 6 mm thick so that the nut when tightened shall not bear on the unthreaded body of the bolt. Tapered washers shall be provided for all heads and nuts bearing on levelled surfaces. The threaded portion of the bolt shall not be within the thickness of the parts bolted together. The faces of the bolt heads and nuts abutting against steel members shall be machine finished. Where there is a risk of the nut being removed or becoming loose due to vibrations or reversal of stresses, these shall be secured from slackening by the use of lock nuts, spring washers, cross cutting or hammering down of threads as directed.
- 13.2.17.3. Bolts, nuts and washers shall be thoroughly cleaned and dipped in double boiled linseed oil before use. The whole steel work shall be painted with a coat of priming, coat of red lead, as per relevant specification of painting there is a risk of the nut being removed or becoming loose due to vibrations or reversal of stresses, these shall be secured from slackening by the use of lock nuts, spring washers, cross cutting or hammering down of threads as directed.
- 13.2.17.4. Bolts, nuts and washers shall be thoroughly cleaned and dipped in double boiled linseed oil before use. The whole steel work shall be painted with a coat of priming, coat of red lead, as per relevant specification of painting

## **14. 1.1 kV Grade LT Cables**

### **14.1. Material specification**

#### **14.1.1. Applicable Standards**

- IS-694 : PVC insulated cables for working voltages up to and including 1100V.
- IS-1554 : (Part-I) PVC insulated (heavy duty) electric cables for working voltages up to and including 1100V.
- IS-1554 : (Part-II) PVC insulated (heavy duty) electric cables for working voltages from 3.3kV up to and including 11kV.
- IS-3961 : Recommended current ratings for cables
- IS-8130 : Conductors for insulated electric cables and flexible cords.
- IS-5831 : PVC insulation and sheath of electric cables
- IS-6380 : Specification of Elastomeric Insulation & Sheath of Electric Cables
- IS-7098 : (Part-I & II) Cross linked polyethylene insulated PVC sheathed cables for working voltages up to 33kV.
- IS-3975 : Mild steel wires, strips and tapes for armoring cables.
- IS-1753 : Aluminum conductors for insulated cables
- IS-1255 : Code of practice for installation and maintenance of power cables up to and including 33kV rating.
- IS-12943 : Brass glands for PVC cables IS-10418: Drums for electric cables
- IS-10810 : (Part 0 to 63) Method of test for cables
- IS-6474 : Polyethylene insulation and sheath of electric cables
- IS-5819 : Recommended short circuit ratings of high

voltage PVC cables IEC-60502 : Power cables with extruded insulation & their accessories for rated voltages 1kV to 30kV

IEC-540 & 540A: Test methods for insulation and sheaths of electric cables and cord IEC-60332 : Test on electric cables under fire conditions.

IEC-60754 : Test on gases evolved during combustion of electric cables.

IEC-10333: Cable joints and terminations

IEC Hand Book for Temperature Index Cable in fire regarding temperature Index Chapter-6.

Any other applicable standards

## **14.2. Testing:**

**14.2.1.** The contractor shall take full responsibility of testing pre-commissioning and commissioning of cabling system being installed by him. It shall be overall responsibility of the contractor to arrange and complete all activities in complete co-ordination with equipment commissioning agency keeping in view the overall commissioning programmed. The contractor shall submit a check list for testing and commissioning and the activities shall be carried out in accordance with the check list.

**14.2.2.** Testing and electric measurement of cable installations shall conform to IS: 1255.

**14.2.3.** Prior to installation, cables shall be tested for

14.2.3.1. Continuity of conductors

14.2.3.2. Insulation resistance between conductor and earth

14.2.3.3. Insulation resistance between the conductors

**14.2.4.** After installation each cable shall be tested for

14.2.4.1. Insulation resistance between conductors

14.2.4.2. Insulation resistance between the conductors and earth

14.2.4.3. Absence of cross phasing

14.2.4.4. Firmness of terminations

- 14.2.5.** The check and commissioning tests shall be carried out as part of the installation work and the contractor shall not be paid any extra amount for the same.
- 14.2.6.** The contractor shall have to bring all testing equipment/instruments in sufficient numbers. All instruments shall be calibrated to the satisfaction of the purchaser before actual testing and tests to be conducted by qualified experienced personnel.
- 14.2.7.** All documents/records regarding test data and all other measured values shall be submitted for approval and subsequent record and reference. All cables shall be energized only after certification from certification personnel that cable is ready for energizing. The results of all tests shall conform to the specification requirement as well as guaranteed data.
- 14.2.8. General:**
- 14.2.8.1. All medium voltage cables must be supplied, installed, tested, and commissioned in compliance with the relevant drawings, specifications, and relevant parallel between the LT side of the existing transformer, the LT incomer ACB switch board panel, the outgoing of the panel to the motor terminal, etc. as needed and as instructed by engineer-in-charge. The medium voltage cables must also meet Indian standards, specifications, and manufacturer's instructions. Excavation and refilling using Stones, road crossing using RCC pipe, sand etc. Will be in the scope of contractor and shall be done as per relevant is standard.
- 14.2.8.2. The cable shall confirm to relevant is which should be specified and shall bear ISI mark. The quantities mentioned above are approximate only. The cables should be supplied after taking actual measurement jointly. No straight joint in any cables shall be permitted. Any piece or cut length shall have to be taken back by contractor. The contractor should plan and purchase the cable to avoid wastage / cut length / excess length as the corporation will not accept the



same under any circumstances. The cable shall be genuine and of approved make only.

- 14.2.8.3. Root marker shall be provided for every 10-meter length of underground cable and cable identifier for every 20-meter length of cable not covered in underground.
- 14.2.8.4. RCC half round muff of standard make shall be provided for protection of underground cable.
- 14.2.8.5. All above item should be got approved from engineer-in-charge before execution.
- 14.2.8.6. The cables shall be delivered at site in original drums with the manufacturer's name, size and type clearly written on the drums.
- 14.2.8.7. All cables shall be adequately protected against any risk of mechanical damage to which they may be liable in normal conditions of handling during transportation, loading, unloading etc.
- 14.2.8.8. The cable shall be supplied in single length i.e. Without any intermediate joint or cut unless specifically approved by the client. The cable ends shall be suitably sealed against entry of moisture, dust, water etc. With cable compound as per standard practice.

**14.2.9. Conductor:**

- 14.2.9.1. Uncoated, annealed copper / aluminum, of high conductivity, up to 4 mm<sup>2</sup> size the conductor shall be solid and above 4 sq. Mm, the conductor shall be concentrically stranded as per IEC: 228.

**14.2.10. Insulation:**

- 14.2.10.1. Cross link polyethylene (XLPE) extruded insulation rated at 70oc.

**14.2.11. Core identification:**

Two cores : red and black

Three cores : red, yellow and blue

Four cores : red, yellow, blue and black

Single core : green, yellow for earthing.

Black shall always be used for neutral.

**14.2.12. Assembly:**

14.2.12.1. Two, three or four insulated conductors shall be laid up, filled with non- hygroscopic material and covered with an additional layer of thermoplastic material.

**14.2.13. Armour:**

14.2.13.1. Galvanized steel flat strip / round strips applied helically in single layers complete with covering the assembly of cores

14.2.13.2. For cable size up to 10 sq mm: armor of 1.4 mm dia G.I. round wire

14.2.13.3. For cable size above 10 sq mm: armor of 4 mm wide 0.8 mm thick G.I. strip

**14.2.14. Sheath:**

14.2.14.1. St -2 PVC along with polypropylene fillers to be provided. Inner sheath shall be extruded type and shall be compatible with the insulation provided for the cables. Outer sheath shall be of an extruded type layer of suitable PVC material compatible with the specified ambient temp. Of 50oc and operating temperature of cables. The sheath shall be resistant to water, ultra violet radiation, fungus, termite and rodent attacks. The colour of outer sheath shall be black. Sequential length marking along with size and other standard parameters shall be required at every 1.0 meter on the outer sheath.

**14.2.15. Testing:**

14.2.15.1. The finished cables shall be tested at manufacturer's works for all the routine tests for all the length and size of cables to be delivered at site and the certificate for the same shall be furnished to client. If required, the cables shall be tested in presence of the client's

representative.

14.2.15.2. Voltage test: each core of cable shall be tested at room temperature at 3 kVAC RMS for duration of 5 minutes.

**14.2.16. Conductor resistance test:**

14.2.16.1. The DC resistance of each conductor shall be measured at room temperature and the results shall be corrected to 20 degrees centigrade to check the compliance with the values specified in the IS 8130-1976.

14.2.16.2. Cable tests before and after laying cables at site:

14.2.16.2.1. Insulation resistance test between phases, phase to neutral and phase to earth.

14.2.16.2.2. Continuity test of all the phases, neutral and earth continuity conductor.

14.2.16.2.3. Earth resistance test of all the phases and neutral.

14.2.16.2.4. All the tests shall be carried out in accordance with the relevant is code of practice and Indian electricity rules. The vendor / contractor shall provide necessary instruments, equipments and labour for conducting the above tests and shall bear all the expenses in connection with such tests. All tests shall be carried out in the presence of client and the results shall be prescribed in forms and submitted.

**14.2.17. Cable marking:**

14.2.17.1. The outer sheath shall be legibly embossed at every meter with following legend: electric cable: 1100 v, size: \_\_c x\_\_mm<sup>2</sup> with manufacturers name, year of manufacturing and ISI symbol. The Surat Municipal Corporation shall be also is written with embossed writing on the cable.

**14.2.18. Sealing drumming and packing:**

14.2.18.1. After tests at manufacturer's works, both ends of the cables shall be sealed to prevent the ingress of moisture

during transportation and storage. Cable shall be supplied in length of 500 meters or as required in non-returnable drums of sufficiently sturdy construction. Cables of more than 250 meters shall also be supplied in non-returnable drums. The spindle hole shall be minimum 110 mm in diameter.

14.2.18.2. Each drum shall bear on the outside flange, legibly and indelibly in the English literature, a distinguishing number, the manufacturer's name and particulars of the cable i.e. Voltage grade, length, conductor size, cable type, insulation type, and gross weight. The direction for rolling shall be indicated by an arrow. The drum flanges shall also be marked with manufacturer's name and year of manufacturing etc.

### **14.3. Workmanship**

**14.3.1.** Cables shall be laid in the routes marked in the drawings. Where the route is not marked, the Contractor shall mark it out on the drawings and also on the site and obtain the approval of the CLIENT AND/OR ITS ARCHITECT before laying the cable. Procurement of cables shall be on the basis of actual site measurements and the quantities shown in the schedule of work shall be regarded as a guide only.

**14.3.2.** Cables shall be laid on walls, cable trays, inside shafts or trenches. Saddling or support for the cable shall not be more than 500 mm apart. Plastic identification tags shall be provided at every 30 m. Cables shall be bent to a radius not less than 12 (twelve) times the overall diameter of the cable or in accordance with the manufacturer's recommendations whichever is higher. In the case of cables buried directly in ground, the cable route shall be parallel or perpendicular to roadways, walls etc unless marked on drawing by architect / consultant. Cables shall be laid on an excavated, graded trench, over a sand or soft earth cushion to provide protection against abrasion. Cables shall be protected with Stone or cement tiles on all the three sides as shown on drawings. Width of excavated trenches shall be as per drawings. Back fill over buried cables shall be with a minimum

earth cover of 750 mm to 1000 mm. The cables shall be provided with cables markers at every 10 meters and at all loop points. All cables shall be full runs from panel to panel without any joints or splices. Cables shall be identified at end termination indicating the feeder number and the Panel/Distribution board from where it is being laid.

**14.3.3.** In case of cables entering the buildings

14.3.3.1. It would be done duly only through pipes. The pipes shall be laid in slant position, so that no rainwater may enter the building. After the cables are tested the pipes shall be sealed with M. seal & then tarpaulin shall be wrapped around the cable for making the entry watertight.

**14.3.4.** Testing:

LT cables shall be tested upon installation with a 500 V Meggar and the Following readings established:

14.3.4.1. Continuity on all phase Insulation Resistance, between conductors, all conductors and ground

14.3.4.2. All test readings shall be recorded and shall form part of the completion documentation.

**14.3.5.** Format for cable testing certificate:

14.3.5.1. Drum no. from which cable is taken:

14.3.5.2. Cable from \_to\_\_\_\_\_

14.3.5.3. Length of run of  
this cable

14.3.5.4. Insulation resistance test

- 14.3.5.4.1. Between core 2 to earth\_mega-ohm
- 14.3.5.4.2. Between core 3 to earth\_mega-ohm
- 14.3.5.4.3. Between core 1 to core 2\_\_\_\_\_mega-ohm
- 14.3.5.4.4. Between core 2 to core 3\_\_\_\_\_mega-ohm
- 14.3.5.4.5. Between core 1 to core 3\_\_\_\_\_mega-ohm
- 14.3.5.4.6. Duration used:
- 14.3.5.4.7. High voltage test: Voltage Duration
- 14.3.5.4.8. Between core and earth
- 14.3.5.4.9. Between individual cores

## **15. Cable Laying**

### **15.1. Route**

- 15.1.1.** Before the cable laying work is undertaken, the route layout of the cable shall be submitted to the Engineer -in-Charge and the work shall be undertaken only after approval of the route layout.
- 15.1.2.** Whenever cables of different voltages are laid following points shall be noted while laying along well demarcated or established roads, the LV / MV cables shall be laid further from the kerbed line than HV cables.
- 15.1.3.** Cables of different voltages and also power and control cables shall be kept in different trenches with adequate separation. Where available space is restricted such that this requirement cannot be met, LV / MV cables shall be laid above HV cables.
- 15.1.4.** Where cables cross one another, the cable of higher voltage shall be laid at a lower level than the cable of lower voltage.
- 15.1.5.** Proximity to communication cables.
  - 15.1.5.1. Power and communication cables shall be as far as possible cross each other at right angles. The horizontal and vertical clearance between them shall not be less than 60 cm.

### **15.2. Methods of Laying**

- 15.2.1.** The cables shall be laid direct in ground, pipe, closed or open

ducts, and cable trays or on surface of wall etc. The method(s) of laying required shall be specified in the tender / schedule of work.

**15.3. Laying direct in ground**

**15.3.1.** This method shall be adopted where specified in the schedule of works. Normally this method shall be adopted when the cable route is through open ground, along roads, lanes, etc. and where no frequent excavations are likely to be encountered and where re-excavation is easily possible without affecting other services.

**15.3.2. Trenching**

15.3.2.1. Width and depth of the trench shall be as shown in the drawing. When more than one tier of cables is unavoidable and vertical formation of laying is adopted, the depth of the trench shall be increased by 30 cm for each additional tier to be formed

15.3.2.2. The trenches shall be excavated in reasonably straight lines. Wherever there is a change in the direction, a suitable curvature shall be adopted complying with the minimum bending radius specified in Table 11. Where gradients and changes in depth are unavoidable, these shall be gradual. The bottom of the trench shall be level and free from stones, Stone bats etc.

**15.3.3. TABLE - 2**

System voltage	Minimum bending radius		
	Single Core	Multi-Core	
		Armored	Unarmored
11KV	20D	12D	15D
22KV	25D	15D	20D
33KV	30D	20D	25D

Note: Where "D" is the overall diameter of the cable

Excavation should be done by suitable means manual or mechanical. The excavated soil shall be stacked firmly by the side

of the trench such that it may not fall back into the trench.

15.3.3.1. Adequate precautions should be taken not to damage any existing cable(s), pipes or any other such installations in the route during excavation. Wherever Stones, tiles or protective covers or bare cables are encountered, further excavation shall not be carried out without the approval of the Engineer-in-Charge.

15.3.3.2. Existing property, if any, exposed during trenching shall be temporarily supported adequately as directed by the Engineer-in-Charge. The trenching in such cases shall be done in short lengths, necessary pipes laid for passing cables there in, if required. If there is any danger of a trench collapsing or endangering adjacent structures, the sides should be well shored up with sheeting as the excavation proceeds. Where necessary, these may even be left in place when backfilling the trench.

15.3.3.3. Excavation through lawns shall be done in consultation with the department concerned.

#### **15.3.4. Laying of Cable in Trench**

15.3.4.1. Sand cushioning: The excavated trench shall be provided with a layer of clean, dry sand cushion of not less than 8 cm in depth, before laying the cables therein. However, sand cushioning may not be provided for MV cables, where there is no possibility of any mechanical damage to the cables due to heavy or shock loading on the soil above if so, specified in the tender document and as per approval of the Engineer-in-Charge. Sand cushioning shall however be invariably provided in the case of HV cables.

15.3.4.2. The cable drum shall be properly mounted on jacks, or on a cable wheel at a suitable location, making sure that the spindle, jack etc. are strong enough to carry the weight of the drum without failure and that the spindle is horizontal in the bearings so as to prevent the drum creeping to one side while rotating.



- 15.3.4.3. The cable shall be pulled over in rollers in the trench steadily and uniformly without jerks and strain. The entire cable length shall be far as possible laid off in one stretch. PVC / XLPE cables less than 120 sq.mm size may be removed by "Flaking" i.e., by making one long loop in the reserve direction. For short runs and sizes up to 50 sq.mm of MV cables, any other suitable method of direct handling and lying can be adopted without strain or excess bending of the cables.
- 15.3.4.4. After the cable has been so uncoiled, it shall be lifted slightly over the rollers beginning from one end by helpers standing about 10 m apart and drawn straight. The cable shall then be lifted off the rollers and laid in a reasonably straight line.
- 15.3.4.5. Testing before covering. The cables shall be tested in presence of the Engineer -in-Charge for continuity of cores and insulation resistance and the cable length shall be measured, before closing the trench.
- 15.3.4.6. Sand covering: Cables laid in trenches in a single tier formation shall have a covering of dry sand of not less than 17 cm above the base cushion of sand before the protective covers laid. In the case of vertical multi -tier formation, after the first cable has been laid, a sand cushion of 30 cm shall be provided over the base cushion before the second tier is laid. If additional tiers are formed, each of the subsequent tiers also shall have a sand cushion of 30 cm as stated above. Cables in the top most tiers shall have final sand covering not less than 17 cm before the protective cover is laid. Sand covering as stated above need not be provided for MV cables where a decision is taken by the Engineer-in-Charge as per sub clause (iii-a) above, but theater tier spacing should be maintained with soft soil instead of sand between tiers and for covering. Sand cushioning shall however be invariably provided in the case of HV cables.
- 15.3.4.7. Extra loop cable

- 15.3.4.7.1. At the time of original installation, approximately 3 m of surplus cable shall be left on each terminal end of the cable and on each side of the underground joints. The surplus cable shall be left in the form of a loop. Where there are long runs of cables such loose cable may be left at suitable intervals as specified by the Engineer-in-Charge.
- 15.3.4.7.2. Where it may not be practically possible to provide separation between cables when forming loops of a number of cables as in the case of cable emanating from a substation, measurement shall be made only to the extent of actual volume of excavation, sand filling etc. and paid for accordingly.
- 15.3.4.8. Mechanical protection over the covering: Mechanical protection to cables shall be laid over the covering to provide warning to future excavators of the present of the cable and also to protect the cable against accidental mechanical damage by pick-axe blows etc. as follows:
- 15.3.4.8.1. Unless otherwise specified, the cables shall be protected by second class Stone of nominal size 22 cm x 11.4 cm x 7 cm or locally available size, placed on top of the sand (or, soil as the case may be). The Stones shall be placed breadth wise for the full length of the cable. Where more than one cable is to be lay d in the same trench, this protective covering shall cove all the cables and projects at least 5 cm over the sides of the end cables.
- 15.3.4.8.2. Where Stones are not easily available, or are comparatively costly, there is no objection to use locally available material such as tiles or slates or stone / cement concrete slabs. Where such an alternative is acceptable, the same shall

be clearly specified in the tender specifications.

#### 15.3.4.9. Backfilling

15.3.4.9.1. The trenches shall be then backfilled with excavated earth, free from stones or other shall edge debris and shall be rammed and watered, if necessary, in successive layers not exceeding 30 cm depth.

15.3.4.9.2. Unless otherwise specified, a crown of earth not less than 50 mm and not exceeding 100 mm in the center and tapering towards the sides of the trench shall be left to allow for subsidence. The crown of the earth, however, should not exceed 10 cms so as not to be a hazard to vehicular traffic.

15.3.4.9.3. The temporary restatements of roadways should be inspected at regular intervals, particularly during wet weather and settlements should be made good by further filling as may be required.

15.3.4.9.4. After the subsidence has ceased, trenches cut through roadways or other paved areas shall be restored to the same density and materials as the surrounding area and repaved in accordance with the relevant building Specifications to the satisfaction of the Engineer-in-Charge.

15.3.4.9.5. Where lawns have been cut out of necessity, or kerb stones displaced, the same shall be repaired and made good, except for asphaltting, to the satisfaction of the Engineer -in-Charge and all the surplus earth or rock shall be removed to places as specified.

#### 15.3.4.10. Laying of single core cables

15.3.4.10.1. Three single core cables forming one three phase circuit shall normally be held enclose

trefoil formation and shall be bound together at intervals of approximately 1m. The relative position of the three cables shall be changed at each joint at the time of original installation, complete transposition being affected in every three consecutive cable lengths.

#### 15.3.4.11. Route markers

- 15.3.4.11.1. Location: Route markers shall be provided along with the runs of cable allocations approved by the Engineer -in-Charge and generally at intervals not exceeding 100m. Markers shall also be provided to identify change in the direction of the cable route and locations of underground joints.
- 15.3.4.11.2. Plate type marker: Route markers shall be made out of 23 cms. X 12 cms G.I. /aluminum plate welded / bolted on 35 mm x 35 mm x 6 mm angel iron, 60 cms long. Such plate markers shall be mounted parallel to and at about 0.5 m away from the edge of the trench.
- 15.3.4.11.3. CC marker: Alternatively, cement concrete 1:2:4 (1 cement: 2 coarse sands: 4 graded stone aggregate of 20 mm in size) shall be laid flat and centered over the cable. The concrete markers, unless otherwise instructed by the Engineer -in-Charge, shall project over the surrounding surface so as to make the cable route easily identifiable.
- 15.3.4.11.4. Inscription: The words IITG-MV / HV CABLE as the case may be shall be inscribed on the marker.

### **15.4. Laying in Pipes / Closed Ducts**

- 15.4.1. In locations such as road crossing, entry in to buildings, paved areas etc., and cable shall be laid in pipes or closed ducts. Stone ware pipes, GI, CI or spun reinforced concrete pipes shall be

used for cables as specified in the schedule of works.

- 15.4.2.** Where cables pass through foundation walls or other underground structures, the necessary ducts or openings will be provided in advance for the same. However, should it become necessary to cut holes in existing foundations or structures, the electrical contractor shall determine their location and obtain approval of the Engineer in Charge before cutting is done.
- 15.4.3.** At road crossing and other places where cables enter pipe sleeves adequate bed of sand shall be given so that the cables do not slack and get damaged by pipe ends.
- 15.4.4.** At road crossings, the top surface of pipes shall be at a minimum depth of 1 m from the pavement level. When pipes are laid cutting existing road, care shall be taken so that the soil filled up after laying the pipes is rammed well in layers with watering as required to ensure proper compaction. A crown of earth not exceeding 10 cm should be left at the top. After the subsidence has ceased, the top of the filled-up trenches in road ways or other paved areas shall be restored to the same density and material as the surrounding area in accordance with the direction of the Engineer -in-Charge (Civil) up to his satisfaction.
- 15.4.5.** All G.I. pipes shall be laid as per layout drawings and site requirements. Before fabrication of various profiles of pipe by hydraulically operated bending machine (which is to be arranged by the Contractor), all the burrs from the pipes shall be removed. G.I. pipes with bends shall be buried in soil / concrete in such a way that the bends shall be totally concealed. For G.I. pipes buried in soil, bitumen coating shall be applied on the buried lengths. Installation of G.I. pipes shall be undertaken well before paving is completed and necessary coordination with paving agency shall be the responsibility of Electrical Contractor. The open ends of pipes shall be suitably plugged with G.I. plugs after they are laid in final position. G.I. plugs shall be supplied by the Contractor at no extra cost.

### **15.5. Lying in Open Ducts.**

- 15.5.1.** Open ducts with suitable removable covers (RCC slabs or checkered plates) are generally provided in substations, switch

rooms, plant rooms, and workshops etc. for taking the cables. The cable ducts should be of suitable dimensions for the number of cables involved.

- 15.5.2.** For lying of cables with different voltage ratings in the same duct shall be avoided. Where it is inescapable to take HV & MV cables same trench, they shall be laid with a barrier between them or alternatively, one of the two (HV / MV) cables may be taken through pipe(s). Splices or joints of any type shall not be permitted inside the ducts.
- 15.5.3.** The cables shall be laid directly in the duct such that unnecessary crossing of cables is avoided.
- 15.5.4.** Where specified, cables may be fixed with clamps on the walls of the duct or taken in hooks / brackets / cable trays through in ducts.
- 15.5.5.** Where specified, ducts may be filled with dry sand after the cables
- 15.5.6.** Are laid and covered as above, or finished with cement plaster, especially in high voltage applications.

## **15.6. Laying on Surface**

**15.6.1.** The method may be adopted in places like switch rooms, workshops, tunnels, rising (distribution) mains in buildings etc. This may be necessitated in the works of additions and / or alternations to the existing installation, where other methods of laying may not be feasible. Cables may be laid in surface by any of the following methods as specified:

- 15.6.1.1. Directly clamped by saddles or clamps
- 15.6.1.2. Supported on cradle
- 15.6.1.3. Laid on troughs / trays duly clamped.

## **15.7. Laying on Cable Tray**

**15.7.1.** This method may be adopted in places like indoor substations, air - conditioning plant rooms; generator rooms etc. or where long horizontal runs of cables are required within the building and where it is not convenient to carry the cable in open ducts. This method is preferred where heavy sized cables or a number of

cables are required to be laid. The cable trays may be either of perforated sheets Type or ladder type as specified.

## **16. LT Cable Terminations:**

### **16.1. Material Specification**

#### **16.1.1. Cable termination:**

16.1.1.1. Cable terminations shall be made with aluminum crimped type solder less lugs for all aluminum cables and stud type terminals. For copper cables copper crimped solder less, lugs shall be used. Crimping shall be done with the help of hydraulically operated crimping tool. For joints where cable is with aluminum conductor and bus bars are aluminum, bimetallic lugs shall be used with compound. Cupel type of washers, crimping tool shall be used for crimping any size of cable.

#### **16.1.2. Cable glands:**

16.1.2.1. Cable glands shall be of brass single compression type. Generally single compression type cable glands shall be used for indoor protected locations and double compression type shall be used for outdoor locations. Glands should be of nickel-plated brass, with PVC shrouds over it. Before applying PVC shrouds, all bare metal shall be wrapped with pressure sensitive adhesive tape.

#### **16.1.3. Ferrules:**

16.1.3.1. Ferrules shall be of self-sticking type and shall be employed to designate the various cores of the control cable by the terminal numbers to which the cores are connected, for ease in identification and maintenance.

#### **16.1.4. Cable joints:**

16.1.4.1. Kit type joint shall be done and filled with insulating compound. The joint should be for this 1.1 kV grade insulation, cable termination for conductors up to 4 Sq.mm. may be insertion type and all higher sizes shall have compression type lugs. Cable termination shall

have necessary brass glands. The end termination shall be insulated with a minimum of six half-lapped layers of PVC tape. Cable armouring shall be earthed at both ends. Cable joints shall be done as per regular practice and check shall be carried out for loose connections and leakages. Insulation cutting shall be done properly taking care that no area of the conductor remains exposed. Crimping shall be done with the help of hydraulic tool. Proper insulation tape shall be applied at the cable and lug joint.

**16.1.5. Saddles and clips:**

16.1.5.1. Saddles and clips shall be PVC covered or of g.i. fixing screws shall be round head brass, where screws are used. Nuts shall be or brass, square pressed type.

**16.1.6. Jointing sleeves:**

16.1.6.1. Jointing sleeves shall be of brass with standard termination. Solder type cable connectors / cable sleeves shall be used to join the cable / conductors. The solder used shall comply with BS 219 type no corrosive flux only shall be used.

**16.2. Workmanship**

**16.2.1.** Suitable Size of crimped type solder less lugs should be used for all copper/aluminum cables and stud type terminals. Crimping shall be done with the help of hydraulically operated crimping tool. Crimping tool shall be used for crimping any size of cable.

**16.2.2.** Suitable Size of Cable gland should be used where cable is entering in DB or Panel. For indoor type single compression type cable glands shall be used and for outdoor type double compression type shall be used. Before applying a PVC shrouds, all bare metal shall be wrapped with pressure sensitive adhesive tape.

**16.2.3.** Proper Size of Cable Jointing Kit shall be used to joint two cables and shall be filled with insulating compound. The end termination shall be insulated with a minimum of six half-lapped layers of PVC tape. Cable armorng shall be earthed at both



ends. Cable joints shall be done as per regular practice and check shall be carried out for loose connections and leakages.

## **17. DWC Pipe for Cable Protection Excavation and Covering the Cable:**

### **17.1. Material Specification**

**17.1.1.** Double walled corrugated pipes (dwc) of polyethylene (conforming to is 14930 ii) with necessary connecting accessory of same material at required date for laying of cable below ground / road surface for enclosing the cable and back filling the same to make ground as per original.

**17.1.2.** Diameter of pipe 90mm.

**17.1.3.** Excavation and covering the cable:

**17.1.4.** The dwc duct shall be prominently marked with indelible ink, with the following information at interval of every meter to enable identification of the pipe. The size of the ink markings shall be distinct, clear and easily visible.

**17.1.5.** Ink marking would have followed written:

17.1.5.1. Manufacturer's name (can be in abbreviated form)

17.1.5.2. Name of the duct with size

17.1.5.3. Lot no. of the product

17.1.5.4. Date of manufacture

17.1.5.5. Product length

17.1.5.6. Surat municipal corporation

### **17.2. Workmanship**

**17.2.1.** This item includes excavation / breaking of roads, refilling/restating land / road and covering of cable with RCC half rounds/sand etc. The covering of cable should be with RCC half round muff with cushioning of sand both on top and below of the cable. The RCC half rounds shall be of good quality. Necessary cable covering material should be supplied by the contractor. Where there is more than one cable are to be laid, minimum spacing of 225 mm should be kept, and both cables should be covered with RCC half rounds individually.

**17.2.2.** The item includes excavation of cable trench having depth of 50 to 90 MM (As instructed by engineer in charge) and refilling the same after cable laying and covering. All labour and material required for excavation, covering of cable and refilling shall be supplied by the contractor and the rate should include all such labour, material etc. Any damage to any of the services during excavation, covering, refilling shall be to the contractor's account. The work shall be carried out to the satisfaction of Engineer- in-charge. Refilling work of the trench should be carried out after final supervision of the representative of the corporation. After completion of covering work and testing, trench should be refilled and ground should be levelled including watering etc. If road of pavers-block is broken, the same shall be restated as original

## **18. RCC Hume Pipe**

**18.1.** The Concrete Pipes shall be conforming to IS: 458-2003 (Fourth Revision) with Amendment 1 with regards to Design /Dimensions / Tolerances / Workmanship & Finish / Materials used for making the Pipes.

**18.2.** The Pipes shall be manufactured by spinning process. The ends of the concrete pipes shall be suitable for flush joints or collar joints or suitable for Socket & Spigot, roll on joints or confined gasket joints as per the requirements

## **19. Cable Tray**

### **19.1. Material Specification**

**19.1.1.** Ladder type cable tray. The cable tray shall be fabricated out of 2 mm thick slotted/ perforated ms sheets as channel sections, single or double bended. The channel sections shall be supplied in convenient lengths and assembled at site to the desired lengths. These may be galvanized or painted as specified.

**19.1.2.** The jointing between the sections shall be made with coupler plates of the same material and thickness as the channel section. Two coupler plates, each of minimum 200mm length, shall be bolted on each of the two sides of the channel section with 8mm

dia round headed bolts, nuts and washers. In order to maintain proper earth continuity bond, the paint on the contact surfaces between the coupler and cable tray shall be scraped and removed before the installation.

- 19.1.3.** The permissible uniformly distributed load for various type of cables trays and for different supported span shall be as per is.
- 19.1.4.** The width of the cables tray shall be chosen so as to accommodate all the cables in one tier, plus 30 to 50% additional width for future expansion. This additional width shall be minimum 100mm. The overall width of one cable tray shall be limited to 1000mm.
- 19.1.5.** Factory fabricated bends, reducers, tee / cross junction etc. shall be provided as per good engineering practice. The radius of bends, junctions etc. Shall be less than the minimum permissible radius of bending of the largest size of cable to be carried by the cable tray.
- 19.1.6.** The cable tray shall be suspended from the ceiling slab with the help of 10 mm dia MS round or 25 mm x 5 mm flats at specified spacing. Flat type suspenders may be used for channels up to 450 mm width bolted to cable trays. Round suspenders shall be threaded and bolted to the cable trays or to independent support angle 50 mm x 50 mm x 5mm at the bottom and as specified these shall be grouted to the ceiling slab at the other end through an effective means, as approved by the engineer in charge, to take the weight of the cable tray with the cables.
- 19.1.7.** The entire tray (except in the case of galvanized type) and the suspenders shall be painted with two coats of red oxide primer paint after removing the dirt and rust, and finished with two coats of spray paint of approved make synthetic enamel paint.
- 19.1.8.** The cable tray shall be bonded to the earth terminal of the switch bonds at ends.
- 19.1.9.** The cable tray shall be measured on unit length basis, along the center line of the cable tray, including bends, reducers, tees, cross joints, etc.
- 19.1.10.** The ladder type of cable tray shall be fabricated of double

bended channel section longitudinal members with single bended channel section rungs of cross members welded to the base of the longitudinal members at a center to center spacing of 250 cm as per is.

## **19.2. Workmanship**

- 19.2.1.** The free vertical distance between parallel perforated trays/racks/ladder shall be at least 250mm and the perforated trays shall be 50mm away from the walls.
- 19.2.2.** The trays shall be fixed to the brackets with proper nuts and bolts system.
- 19.2.3.** The perforated trays shall be free from sharp edges and burns etc. so that joint between two trays shall be without any clearance and matched in proper shape.
- 19.2.4.** At the bends the curvature in all axes of perforated trays/racks shall be 20R or maximum size of cable.
- 19.2.5.** The supporting brackets/fixing bolts size shall be so calculated that the design load as specified under sub clause of clause 2.17 does not exceed.
- 19.2.6.** The perforated trays shall be installed in such a way that as far as possible the cables can be laid directly in place rather than be pulled through.
- 19.2.7.** The cables shall be fixed in the perforated trays by means of plastic ties or plastic-coated wires etc.
- 19.2.8.** The perforated cable trays along with their supporting arrangements shall be properly earthed by the supplier with nut and bolts from the earthing risers provided by purchaser, generally in the vicinity of the tray routing. The earthing shall be as per latest i.e., rules and IS/IEC recommendation, the size of earth connection shall be such that its conductance should be more than the conductance of the 14 sq.mm. Copper conductor cross section.

## **20. Main Line Wiring, Internal Wiring and Point Wiring**

## 20.1. Material Specification

### 20.1.1. Standards

Code of practice for electrical wiring installation system voltage not exceeding 650	:	IS: 732
Code of practice for fire safety of buildings general) electrical installation	:	IS: 1646
Rigid steel conduits for electrical wiring	:	IS:1653
Fittings for rigid steel conduits for electrical	:	IS: 2667
Flexible steel conduit for electrical wiring	:	IS: 3480
Accessories for rigid steel conduits for	:	IS:3837
PVC insulated cables (wires)	:	IS:694
Rigid non-metallic conduits for electrical Wiring	:	IS:2509
Flexible (playable) non-metallic conduits for:	:	IS: 6946
Three pin plugs and sockets	:	IS: 1293
Conductors for insulated electrical cables	:	IS: 8180
Specification for conduit for electrical Installation	:	IS: 9537-- 1980
Accessories for non-metallic conduits for electrical wiring	:	IS: 3419
Switches	:	IS: 3854
Plugs	:	IS: 6538
Shunt capacitors for power systems	:	IS: 2834- 1954
Hrc cartridge fuses and links up to 660 volts:	:	IS: 2208
General and safety requirement for lighting fittings	:	IS: 1913-1969
Code of practice for lighting public thorough fares	:	IS: 2944- 1981
3 pin plug sockets	:	IS:1293
Specification of conduits for electrical	:	

installation : IS -8130

Guide for electrical layout in residential  
building Indian electricity act and rules : IS-4648

**20.1.2. Rigid and flexible conduits:**

20.1.2.1. All conduits shall be rigid PVC pipe having minimum wall thickness of medium gauge 1.5 to 1.8 approved by FIA. & ISI and shall confirm to IS 9537.

20.1.2.1.1. Up to 38 mm. Diameter - minimum 1.8 mm. Wall thickness.

20.1.2.1.2. Above 40 mm. Diameter - minimum 2.2 mm. Wall thickness.

20.1.2.1.3. 20, 25, and 32 mm diameter – minimum 1.5 mm wall thickness

20.1.2.2. Flexible conduits shall be formed from a continuous length of spirally wound interlocked steel strip with a fused zinc coating on both sides. The conduit shall be terminated in brass adapters.

20.1.2.3. Accessories:

20.1.2.3.1. PVC conduit fittings such as bends, elbows, reducers, chase nipples, split couplings, plugs etc. Shall be specifically designed and manufactured for their particular application. All conduit fittings shall conform to IS: 2667-1964 and IS: 3857-1966. All fitting associated with galvanized conduit shall also be galvanized.

**20.1.3. Casing and Capping**

20.1.3.1. Casing and capping shall be of good quality PVC, free from defects like deformations, unevenness, blisters, cavities, etc.

20.1.3.2. The casing shall be of square or rectangular body with top of the side walls suitable for tightly fitting slide-in type capping with double grooving. All surfaces shall have smooth finish inside and outside.

**20.1.4. Wires:**

20.1.4.1. All wires shall be single core multi-strand/ flexible copper frls type PVC insulated as per IS: 694 and shall be 660 v\1100 v grade.

20.1.4.2. All wires shall be colour coded as follows: Phase  
Colour of Wire

R	red
Y	yellow
B	blue
N	black
Earth	green
(insulated) Control (if any)	grey

20.1.4.3. All off wires shall be same as phase wire

**20.1.5. Switches & Sockets:**

20.1.5.1. Switches shall be moulded plate type flush piano type with silver-coated contacts. Sockets shall be 3 pins with switch and plate type cover. Combination of multiple switch units and sockets should be used to minimize the switch boxes. All screws shall be brass chromium plated and shall be counter sunk type with half round head or flat headed. For heavy duty, metal clad sockets M.C.B/ isolator mounted in a galvanized steel box shall be provided.

**20.2. Workmanship**

**20.2.1. Point wiring**

20.2.1.1. The size of conduit shall be selected in accordance with the number of wires permitted under table given below. The minimum size of the conduit shall be 25 mm. diameters unless otherwise indicated or approved. Size of wires shall not be less than 1.5 Sq.mm. copper or 2.5 Sq.mm. aluminum

Nominal Dia of wires (mm)	Nominal Cross sec. Area (mm <sup>2</sup> )	20 mm		25 mm		32 mm		38 mm	
			B	S	B	S	B	S	B
1/2.40	1.50			8	6	1 5	9	- -	--
1/1.80	2.50			6	4	1 0	8	- -	--
1/2.24	4.00			4	3	8	6	- -	--
1/2.80	6.00			4	3	6	6	- -	--
1/3.55	10.00		- -	3	2	5	4	6	5

**Note:**

**S:** Runs of conduits which have distance not exceeding 4.25 m. between draw boxes & which do not deflect from the straight by an angle more than 15 degree.

**B:** Runs of conduits which deflect from the straight by more than 15°

20.2.1.2. Conduits shall be kept at a minimum distance of 100 mm. from the pipes of other non-electrical services. And maintain minimum 300 mm distance between telephone, TV & Computer piping (if possible)

20.2.1.3. Separate conduits/raceways shall be used for:

20.2.1.3.1. Normal lights and 5 A 3 pin sockets on lighting circuit.

20.2.1.3.2. Separate conduit shall be laid from D.B. to switch board or point.

20.2.1.3.3. Power outlets - 15 A 3 pin 20 A/30 A, 2 pin scraping earth metal clad sockets.



- 20.2.1.3.4. Emergency lighting.
- 20.2.1.3.5. Telephones.
- 20.2.1.3.6. Fire alarm system.
- 20.2.1.3.7. Public address system & Music system.
- 20.2.1.3.8. For all other voltages higher or lower than 230V.
- 20.2.1.3.9. T.V. Antenna.
- 20.2.1.3.10. Water level guard.
- 20.2.1.3.11. Computer Wiring
- 20.2.1.3.12. Call bell wiring layout of conduits shall be generally as indicated on drawings and the layout shall be supplemented and complemented by contractor on site with the approval of the Engineer.
- 20.2.1.3.13. Wiring for short extensions to outlets in hung ceiling or to vibrating equipments, motors etc., shall be installed in flexible conduits. Otherwise, rigid conduits shall be used. No flexible extension shall exceed 1.25 m.
- 20.2.1.3.14. Conduits run on surfaces shall be supported on GI 12 mm. thick pressure saddles which in turn are properly screwed to the wall or ceiling. Saddles shall be at intervals of not more than 500 mm. Fixing screws shall be with round or cheese head and of rust-proof materials. Exposed conduits shall be neatly run parallel or at right angles to the walls of the building. Unseemly conduit bends and offsets shall be avoided by using fabricated mild steel junction/pull through boxes for better appearances. No cross-over of conduits shall be allowed unless it is necessary and entire conduit installation shall be clean and neat in appearance.
- 20.2.1.3.15. Conduits embedded into the walls shall be fixed

by means of staples at not more than 500 mm. intervals. Chases in the walls shall be neatly made and refilled after laying the conduit and brought to the finish of the wall but final finish will be done by the building contractor.

20.2.1.3.16. Conduits buried in concrete structure shall be put in position and securely fastened to the reinforcement and got approved by the Engineer, before the concrete is poured. Proper care shall be taken to ensure that the conduits are neither dislocated nor choked at the time of pouring the concrete. Suitable fish wires shall be drawn in all conduits before they are embedded.

20.2.1.3.17. Where conduit passes through expansion joints in the building, adequate expansion fittings shall be used to take care of any relative movement.

20.2.1.3.18. Inspection boxes shall be provided for periodical inspection to facilitate withdrawal and removal of wires. Such inspection boxes shall be flush with the wall or ceiling in the case of concealed conduits. Inspection boxes shall be spaced at not more than 12 meters apart or two 90° solid bends or equal. All junction and switch boxes shall be covered by 6 mm. clear per plate truly cut and fixed with cadmium plated brass screws. These junction boxes shall form part of point wiring or conduit wiring as the case may be including the cost of removing the Perspex cover for painting and re-fixing. No separate charges shall be allowed except where specially mentioned.

20.2.1.3.19. Conduits shall be free from sharp edges and burrs and the threading free from grease or oil. The entire system of conduits must be

completely installed and rendered electrically continuous before the conductors are pulled in. Conduits should terminate in junction boxes of not less than 32 mm. deep.

20.2.1.3.20. An insulated earth wire of copper rated capacity shall be run in each conduit. The earth continuity conductor shall be as follows.

20.2.1.3.21. Load balancing: Balancing of circuit in three-phase installation shall be planned before the commencement of wiring and shall be strictly adhered to.

**20.2.2.** Minimum size of earth conductor not forming part of same cable as associate circuit conductor

**20.2.3.** Nominal cross section area of Nominal cross section area of

Largest associated copper circuit Conductor in Sq. MM	Earth continuity conductor in Sq. MM
6.0	2.5
10.0	6.0
16.0	6.0
25.0	16.0
35.0	16.0
50.0	16.0

**20.2.4.** Lighting & Power Wiring:

20.2.4.1. All final branch circuits for lighting and appliances shall be flexible copper wire of appropriate size run inside conduits. The conduit shall be properly connected or jointed into sockets, bends, and junction boxes.

20.2.4.2. Branch circuit conductor sizes shall be as shown in the schedule of quantities and or drawings.

20.2.4.3. All circuits shall preferably be kept in a separate conduit up to the Distribution Board. No other wiring shall be bunched in the same conduit except those belonging to the same phase. Each lighting branch circuit shall not

have more than ten outlets or 800 watts whichever is lower. Each conduit shall not hold more than three branch circuits, of the same phase.

- 20.2.4.4. Flexible cords for connection to appliances, fans and pendants shall be 650/1100 V grade (three or four cores i.e. with insulated neutral wire of same size) with tinned stranded copper wires, insulated, twisted and sheathed with strengthening cord. Colour of sheath shall be subject to the Engineer's approval.
- 20.2.4.5. Looping system of wiring shall be used. Wires shall not be jointed. Where joints are unavoidable, they shall be made through approved mechanical connectors. No such joints shall be made unless the length of the sub-circuit, sub-main or main is more than the length of the standard coil.
- 20.2.4.6. Control switches shall be connected in the phase conductors only and shall be 'ON' when knob is down. Switches shall be fixed in 3 mm. thick painted or galvanized steel boxes with cover plates as specified. Cadmium plated brass screws shall be used.
- 20.2.4.7. Power wiring shall be distinctly separate from lighting wiring. Conduits not less than 25 mm. and wires not less than 2.5 sq.mm. Copper shall be used.
- 20.2.4.8. Every conductor shall be provided with identification ferrules at both ends matching the drawings.

#### **20.2.5. Testing**

- 20.2.5.1. The entire installation shall be tested for:
- 20.2.5.2. Insulation resistance.
- 20.2.5.3. Earth continuity.
- 20.2.5.4. Polarity of single pole switches

## **21. MCB, ELCB & LT Distribution Boards**

### **21.1. Material Specification**

#### **21.1.1. Distribution board**

- 21.1.1.1. Distribution board using TPN/ DP/ SP MCB/MCCB isolator, earthing terminal, connector strip for phase neutral and earth for each circuit, CRCA sheet steel housing and complete.
- 21.1.1.2. Common banking of neutral & earth conductor is not allowed. It shall be suitable to operate on 415/220-volt, 50 Hz. A. C. Supply and withstand short circuit current of 10ka.
- 21.1.1.3. Construction
- 21.1.1.4. Distribution boards shall be fabricated from 2mm. Gauge CRCA sheet or shall be factory readymade as specified in the material list. It shall be of double door type with hinged (lockable if required) door suitable for recessed mounting in wall and dead front operated. Distribution boards shall be powder coated with 7-tank process application. The distribution boards shall be provided with phase barriers, wiring channels to accommodate wires and individual per phase neutral links.
- 21.1.1.5. There shall be separate or individual earth link as per requirement. Proper arrangement shall be made for mounting of MCB's and other accessories. Distribution boards shall meet with the requirements of IS 2675 and marking arrangement of bus bars shall be in accordance with IS standards.
- 21.1.1.6. It should be totally enclosed and made dust, vermin and weatherproof such that, it meets to the ip-51 and ip-54 protection for indoor and outdoor application respectively.
- 21.1.1.7. A detachable cover plate of 2mm. CRCA sheet shall be on front of board such that, all live parts of the electrical accessories mounted on board shall be accessible only on removal of said cover plate. The cover plate shall be fixed to the board with adequate size zinc passivity metal screws. Above the detachable cover plate, one additional hinged door of 2 mm thick

CRCA sheet should be provided with necessary locking arrangement and suitable gasket capable of withstanding corrosive and humid atmosphere.

- 21.1.1.8. Inter connection of wiring shall be done with 660/1100 v. Grade, PVC insulated, flexible copper conductor of one size higher current carrying capacity than that of switch rating.
- 21.1.1.9. Bus bars shall be suitable for the incoming switch rating and sized for a temperature rise of 35°C over the ambient. Each board shall have two separate earthing terminals.
- 21.1.1.10. Circuit diagram indicating the load distribution shall be pasted on the inside of the DB as instructed. One earthing terminal for single phase and two terminals for 3 phases DB shall be provided with an earth strip connecting the studs and the outgoing ecu earth bar.
- 21.1.1.11. The top and the bottom faces of the DB shall be provided for conduit cable entry provision shall be made. The circuit connection from MCB's shall be brought to elemex type connector provided on top / bottom of the db. The connector shall be suitable to receive phase, neutral and earth wire / cable coming from each individual circuit. The connectors shall have identification tag. The faces if asked shall be kept detachable. All outgoing feeders shall terminate on a terminal strip which in turn is interconnected to the MCB / fuse base by means of insulated single conductor copper wires as follows

Up to 15 Amp	2.5 sqmm
25 Amp	4.0 sqmm
32 Amp	6.0 sqmm
40 Amp	10 sqmm
63 Amp	16 sqmm

- 21.1.1.12. Each DB shall have indicated lamp, preferably neon

type denoting power availability in the board. Indicating lamps shall be complete with fuse.

**21.1.2. MCCB / Miniature Circuit Breakers (MCB):**

21.1.2.1. Miniature circuit breakers shall be quick make and break and break type non-welding self-wiping silver alloy contacts for 10 ka short circuit both on the manual and automatic operation, conforms with British standard BS: 3871 (part-i) 1965 and is :8825 (1996) with facility for locking in off position.

21.1.2.2. The housing of MCBs shall be heat resistant and having operating mechanism with mechanical "on" and "off" indications, 'C' high impact strength. The fault current of MCBs shall not be less than 10ka, at 230 volts. The MCBs shall be flush mounted and shall be provided with trip free manual characteristic current limiting type, 10 ka and having quick break with trip free operating mechanism. Each pole of the breaker shall be provided with inverse time thermal over load and instantaneous over current tripping elements, with trip-free mechanism. In case of multi-pole breakers, the tripping must be on all the poles and operating handle shall be common. Pressure clamp terminals for stranded/solid conductor insertion are acceptable up to 4 sqmm aluminum or 2.5 sqmm copper and for higher ratings; the terminals shall be suitably shrouded. Wherever MCB isolators are specified they are without the tripping elements.

21.1.2.3. The MCB contact shall be silver nickel and silver graphite alloy and tip coated with silver. Proper arc chutes shall be provided to quench the arc immediately. MCB's shall be provided with magnetic fluid plunger relay for over current and short circuit protection

**21.1.3. RCCB / ELCB**

21.1.3.1. The RCCB should suffice all the requirements of is as per code is - 12640 - 1988. The RCA should be current

operated and not on-line voltage.

21.1.3.2. The RCCB should ensure mainly the following functions:

- 21.1.3.2.1. Measurement of the fault current value.
- 21.1.3.2.2. Comparison of the fault current with a reference value.
- 21.1.3.2.3. The RCCB should have a torrid transformer which has the main conductors of primary (p - n) which check the sum of the current close to zero
- 21.1.3.2.4. All metal parts should be inherently resistant to corrosion and treated to make them corrosion resistant
- 21.1.3.2.5. It should be truly current operated
- 21.1.3.2.6. It should operate on core balance torrid transformer
- 21.1.3.2.7. Its accuracy should be  $\pm 5\%$ .
- 21.1.3.2.8. It should operate even in case of neutral failure.
- 21.1.3.2.9. It should trip at a present leakage current within 100 MA
- 21.1.3.2.10. Its enclosure should be as per IP 30.
- 21.1.3.2.11. Its mechanical operation life should be more than 20,000 operations.
- 21.1.3.2.12. It should provide full protection as envisaged by IE rules-61-a, 71-EE, 73-EE, and 1985 and also rule 50 of ie rule 1956.
- 21.1.3.2.13. It should conform to all national and international standards like IS: 8828-1993, IS: 12640-1988, BS 4293 - 1983, CEE 27 (international commission rules for the approved of electrical equipment)

## **21.2. Workmanship**



**21.2.1.** The D.B. shall be properly grouted in the wall in concealed manner taking care that the powder coating is not scratched and contact and ferrules depicting the circuit no's shall be provided. D.B.s mounted in dents are not formed on the D.B. The MCBs and ELCBs in the distribution boards shall be fixed as per the circuit details provided. All the wires terminating in the MCBs and the ELCBs shall be lugged for proper concealed manner shall have a groove around it so as to save the finish of the plaster and colour during future opening of the door. The distribution boards shall have circuit chart tagged on the door for future maintenance. Danger notice plates shall be fitted to the distribution boards with screws and not stuck so as to assure its presence for a longer duration.

## **22. Earthing System**

### **22.1. Material Specification**

**22.1.1.** The earthing system complete in all respect with all equipments, fittings and accessories for efficient and trouble-free operation. The material to be supplied by the contractor and work to be carried out by the contractor shall be in general, but not limited to, conforming to the specification laid down for each item.

#### **22.1.2. Codes & standards**

22.1.2.1. The design, material, assembling, inspection and testing shall comply with all currently applicable statutes, regulations and safety codes in the locality where the system will be installed. The equipment shall also confirm to the latest applicable standards and codes of practice as mentioned below

Sr.	Item	Relevant IS
1	Code of practice for earthing	IS 3043
2	Insulation co-ordination application guide	IS 3716

3	Code of practice for protection of buildings and allied structures against lightning	IS 2309
4	Indian electricity rules, 1956	
5	Indian electricity act, 1910	
6	National electrical code	

**22.1.3. Materials required**

22.1.3.1. All required hardware such as bolts, nuts, washers (round and spring type), anchor fasteners, screws, etc. Of sizes and type as required shall be conforming to relevant is. All hardware shall be hot-dip galvanized or zinc passivated /cadmium plated as per requirement of work either mechanical fabrication or electrical jointing

**22.1.4.** All other items required for installation shall be as approved by engineer-in-charge.

**22.2. Workmanship**

**22.2.1.** Following activities shall be carried out for the earthing station

**22.2.2.** Excavation in hard Murrum.

**22.2.3.** Laying Watering pipe.

**22.2.4.** Stone masonry with cast iron frame and hinged covers.

**22.2.5.** Charcoal and Salt fill.

**22.2.6.** Earth station should be 1 meter away from building.

**22.2.7.** Keep minimum 3-meter distance between two earth pits.

**22.2.8.** The pit should be minimum 4 meter deep.

**22.2.9.** The earth resistance should not exceed 1 ohm.

**22.2.10.** All earth pits of same category shall be interlinked with strip.

**22.2.11.** Separate earthing for the Audio-Video device to be provided as required

**22.2.12. INSTALLATION OF SYSTEM**

22.2.12.1. The plate / pipe electrode, as far as practicable, shall

be buried below permanent moisture level but in no case less than 3 M below finished ground level

- 22.2.12.2. The plate/pipe electrode shall be kept clear of the building foundation and in no case, it shall be nearer by less than 2 M from outer face of the respective building wall / column
- 22.2.12.3. The plate electrode shall be installed vertically and shall be surrounded with 150 mm. thick layers of Charcoal dust and Salt mixture
- 22.2.12.4. 20 mm. dia. G.I. pipe for watering, shall run from top edge of the plate / pipe electrode to the mid level of block masonry chamber
- 22.2.12.5. Top of the pipe shall be provided with G.I. funnel and screen for watering the earth / ground through the pipe
- 22.2.12.6. The funnel with screen over the G.I. pipe for watering to the earth shall be housed in a block masonry chamber as shown in the drawing
- 22.2.12.7. The masonry chamber shall be provided with a Cast Iron hinged cover resting over the Cast Iron frame which shall be embedded in the block masonry
- 22.2.12.8. Construction of the earthing station shall in general be as shown in the drawing and shall conform to the requirement on earth electrodes mentioned in the latest edition of Indian Standard IS: 3043, Code of Practice for Earthing Installation
- 22.2.12.9. The earth conductors (Strips / Wires, Hot dip G.I. / copper) inside the building shall properly be clamped / supported on the wall with Galvanized Iron clamps and Hot Dip GI screws / bolts. The conductors outside the building shall be laid at least 600 mm. below the finished ground level.
- 22.2.12.10. The earth conductors shall either terminate on earthing socket provided on the equipment or shall be fastened to the foundation bolt and / or on frames of the equipment. The earthing connection to equipment

body shall be done after removing paint and other oily substances from the body and then properly be finished

22.2.12.11. Over lapping of earth conductors during straight through in joints, where required, shall be of minimum 75mm. long and bitumen coated

22.2.12.12. The earth conductors shall be in one length between the earthing grid and the equipment to be earthed

22.2.12.13. Minimum distance of 2 meter shall be maintained between other electric conductor, earthing conductor and the conductor laid for the lightning protection system. Earthing and lightning protection system conductors shall be bonded to each other to prevent side flashover in case of non-availability of adequate clearance

22.2.12.14. The earthing metal conductors, risers, earthing cables, etc. passing through walls shall be covered with galvanized iron sleeves for the passage through wall. Water stop sleeves shall also be provided wherever the earthing conductor enters the building from outside

**22.2.13. INSPECTION AND TESTING**

22.2.13.1. The following earth resistance values shall be measured with an approved earth megger and recorded.

22.2.13.2. Each earthing station

22.2.13.3. Earthing system as a whole

22.2.13.4. Earth continuity conductors

**22.2.14.** Earth conductor resistance for each earthed equipment shall be measured which shall not exceed 1 ohm in each case. In case of more earth resistance, the Contractor shall have to carry out necessary modification in the system without any cost implication to the Client

**22.2.15.** Measurements of earth resistance shall be carried out before earth connections are made between the earth and the object to be earthed

22.2.15.1. All tests shall be carried out in presence of the

consultant / client and report should be submitted in two sets

**22.2.16.** Size of GI Earth-strip for earthing shall be generally under:

22.2.16.1. HT Switch-yard/Earthing station: 50 x 6 mm GI strip

22.2.16.2. Switch-boards up to 800 Amps: 40 x 6 mm GI strip

22.2.16.3. Other switch-boards and motors including 50HP and above: 32 x 6 mm GI strip

22.2.16.4. Motors less than 50HP up to and including 20HP: 32 x 3 mm GI strip

22.2.16.5. Motors less than 20HP: 25 x 3 mm GI strip

22.2.16.6. P.S.D.B.'s L.S.D.B.'s 10 SWG GI Wir

22.2.16.7. Transformer Neutral: Copper strip Size as per transformer rating ma

22.2.16.8. Metering C.T.'s / P.T.'s, L.A.'s & TVM Box: (double earthing): 25mmx5 mm copper

22.2.16.9. Lighting Conductor System: 32 x 6 mm GI strip

## **23. Portable Fire Extinguishers**

### **23.1. Portable Dry Chemical Powder Type Extinguisher**

**23.1.1.** Portable fire extinguishers of the dry chemical powder variety must be used in the home. The following categories of fire extinguishing equipment listed in the "Schedule of Requirements" must be available as a ready method of putting out fires in the substation and pump quickly and effectively.

**23.1.2.** Portable dry chemical powder type fire extinguishers shall be house area. Following types of fire extinguishing equipment as per the "Schedule of Requirements" shall be provided as ready means for dealing effectively and immediately with fire in the substation and pump

23.1.2.1. Hand portable dry chemical powder type extinguisher of 2.5 kgs complete with initial charge and hanging brackets.

23.1.2.2. Hand portable type fire extinguishers shall fulfill the

requirements of Indian Standard Specification IS: 2171 in respect of material, shape and construction etc. Each fire extinguisher shall be subjected to the performance as laid down in the above Indian Standards Specification.

**23.1.3.** The portable fire extinguishers as stated above shall be located at suitable places. All the fire extinguishers shall be subjected to anti corrosive treatment and shall be painted and marked as per requirement of relevant standards.

## **24. B class GI pipe**

### **24.1. Materials.**

**24.1.1.** Galvanized iron pipes shall be of the medium type and of required diameter and shall comply with I.S. 1239-1990. The specified diameter of the pipes shall refer to the inside diameter of the bore. Clamps, screw and all galvanized iron fittings shall be of the standard "R" or equivalent make.

### **24.2. Workmanship.**

**24.2.1.** Cutting, laying & jointing.

24.2.1.1. When the tubes are to be cut or rethreaded, the ends shall be carefully filed out so that no obstruction to bore is offered. The ends of the tubes shall then be threaded confirming to the requirements of I.S. 554-1955 with pipe dies and tape carefully in such a manner as will not result in slackness of joints when two pieces are screwed together.

24.2.1.2. The taps and dies shall be used only for straightening screw threads which have become bent or damaged and shall not be used for turning of the threads so as to make them slack as the latter procedure may not result in a water tight joint. The screw threads for the tube and fitting shall be protected from edge until they are fitted.

24.2.1.3. In jointing the tubes, the inside of the socket screwed end of the tubes shall be oiled and smeared with white

or red lead and wrapped around with a few turns of fine-spun yarn around the screwed end of the tube. The end shall then be tightly screwed in the socket, tees etc. with a pipe wrench. Care shall be taken that all pipes and fittings are properly jointed so as to make the joints completely water tight and pipes are kept at all times free from dust and dirt during fixing. Burr from the joints shall be removed after screwing. After laying the open ends of the pipes shall be temporarily plugged to prevent access of water, soil or any other foreign matter.

- 24.2.1.4. The threads exposed after 3 jointing shall be painted or in the case of underground piping thickly coated with approved anti-corrosive paint to prevent corrosion.

**24.2.2. Laying in trenches.**

- 24.2.2.1. The width and depth of trenches for different diameters of tube shall be as for 15 to 80 mm dia tube width of trenches shall be 30 cm and depth of trenches 60 cm.
- 24.2.2.2. At joints the trench width shall be widened where necessary. The work of excavation and refilling shall be done true to line and gradient in accordance with general specifications of earth work in trenches.
- 24.2.2.3. The pipes shall be painted with two coats of anti-corrosive bitumastic paint of approved quality. The pipe shall be laid on a layer of 75 mm sand filled up to 150 mm above the pipe if so specified. The remaining portion of trench shall be then filled with excavated earth. The surplus earth shall be disposed of as directed.
- 24.2.2.4. When the excavation is done in rock the bottom shall cut deep enough to permit the pipe to be laid and cushion of sand 75 mm. In case of bigger diameter of tube where pressure is very high, thrust block of cement concrete 1:2:4 (1 cement: 2 coarse sands: 4

graded stone aggregate of 20 mm nominal size) shall be constructed on all bends to transmit the hydraulic thrust without impairing the ground and spreading it over a sufficient area if so specified.

**24.2.3. Fixing of tube fittings to wall ceiling and floors.**

24.2.3.1. In case of fixing of tubes and fittings to the wall's or ceilings, these shall run on the surface of the wall or ceiling (not in chase) unless otherwise specified. The fixing shall be done about 15 mm clear off the wall. When it is found necessary to conceal the pipes and when specified so, chasing may be adopted or pipe fixed in ducts or recesses etc., provided that there is sufficient space to work on the pipe with usual tools. The pipe shall not ordinarily be buried in walls or solid floors, where unavoidable pipes may be buried for short distances provided that adequate protection is given against damage and where so required joints are not buried. Where required M.S. tube sleeves shall be fixed at a place a pipe is passing through a wall or floor for expansion and contraction and other movements. In case the pipe is embedded in walls or floors, it should be painted with anti-corrosive bitumastic paint of approved quality. The pipe should not come in contact with lime mortar or lime concrete as the pipe is affected by lime. Under the floors the pipe shall be laid in layer of sand filling.

24.2.3.2. All pipes and fittings shall be fixed truly vertical and horizontal unless unavoidable. The pipes shall be fixed to walls with standard pattern clamps of required size and shape, one end of which shall be properly plugged or cemented into walls with cement mortar 1:3 (1 cement: 3 coarse sand) and the other tightened round the pipes to hold it securely. These clamps shall be spaced at regular intervals in straight lengths at 2.0-meter c/c interval in horizontal run and 2.5-meter intervals in vertical run. For pipe of 15 mm dia up to 25 mm dia the holes in the walls and floors shall be



made by drilling with chisel or jumper and not by dismantling the Stone or concrete. However, for bigger diameter pipes the holes shall be carefully made of the smallest required size. After fixing the pipe holes shall be made good with cement mortar 1:3 (1 cement: 3 coarse sand) and properly finished to match the adjacent surface.

**24.2.4. Testing of joints.**

24.2.4.1. After laying and jointing, the pipe and fittings shall be inspected under working conditions of pressure and flow. Any joint found leaking will be re done and all leaking pipes removed and replaced without extra cost.

24.2.4.2. The pipes and fitting after they are laid shall be tested to hydraulic pressure of 6 kg / Sq cm the pipe shall be slowly and carefully charged with water allowing all air to escape and avoiding all stock and water hammer. The draw off takes and stock shall then be closed and specified hydraulic pressure shall be applied gradually. The pressure gauge must be accurate. The pipes and fittings shall be tested in sections as the work of laying proceeds, keeping the joints exposed for inspection during the testing.

**24.2.5.** The width and depth of the trenches for different diameters of tube shall be as under.

**24.2.6.** For 15 to 80 mm dia tube width of trenches shall be 30 cm and depth 60 cm.

**24.2.7.** At joints, the trench width shall be widened where necessary. The work of excavation and refilling shall be done true to line and gradient in accordance with general specifications of earth work in trenches.

**24.2.8.** The pipe shall be painted with two coats of anti-corrosive bitumastic paint of approved quality. The pipe shall be laid on a layer of 75 mm sand filled up to 150 mm above the pipe if so specified. The remaining portion of trench shall be then filled with excavated earth. The surplus earth shall be disposed off as directed.

**24.2.9.** When the excavation is done in rock the bottom shall cut deep enough to permit the pipe to be laid and cushion of sand 75 mm. In case of bigger diameter of tube where pressure is very high, thrust block of cement concrete 1:2:4 (1 cement: 2 coarse sands: 4 graded stone aggregate of 20 mm nominal size) shall be constructed on all bends to transmit the hydraulic thrust without impairing the ground and spreading it over a sufficient area if so specified.

### **24.3. Mode of measurement and payments.**

- 24.3.1.1. The description of item, shall unless otherwise stated, be held to include where necessary, conveyances and delivery, handling, unloading, storing, fabrication, hoisting, all labour for finishing to required shape and size, setting, fitting in position, straight, cutting and waste, return of packing etc.
- 24.3.1.2. The length shall be measured on running meter basis of finished work. The length shall be taken along the center line of the pipe and fittings. The pipes fixed to walls, ceiling, floors etc. shall be measured and paid under this item.
- 24.3.1.3. All the work shall be measured in decimal system as fixed in its place, subject to tolerance given unless otherwise stated.
- 24.3.1.4. Dimension shall be measured to the nearest 0.01 meter.
- 24.3.1.5. Area shall be worked out to the nearest of 0.01 Sq. meter.
- 24.3.1.6. In case of fittings with unequal bore, the largest bore shall be measured for the test.
- 24.3.1.7. Testing of pipe lines, fittings and joints including providing all plant and appliances necessary for obtaining access to the work to be tested and carrying out the test.
- 24.3.1.8. The rate includes galvanized steel tubing with screwed socket joints, together with all fittings (such as bends, sockets, springs, elbows, tees, crosses, short pieces,

clamps and plug union etc.) and fixing complete with clamping wall hooks, wooden plugs etc. and also cutting, screwing and waste for making forged (or handmade) bends or piping as required. The rate also includes cutting through walls, floors etc., and their making good and painting exposed threads with anti-corrosive paint as above and testing. Where tubes are to be fixed to wall, ceiling and flooring, the rates shall not include painting of pipes, providing sleeves and sand filling under floor for which separate payment shall be made.

**24.3.2.** For purpose of calculating cubic content, cross section shall normally be taken at suitable intervals i.e. manhole or wall chamber intervals, except in an abnormal cases like sudden change in strata or undulating ground etc. where they may be taken at closer intervals as approved by the Engineer-in-charge whose decision shall be final, conclusive and binding.

**24.3.3.** Authorized width.

24.3.3.1. Up to one meter depth, the width of the trenches for the purpose of measurements of excavation shall be arrived at by adding 40 cm to the external diameter of the tube (not the socket) where a pipe is laid on concrete bed / cushioning layer, the authorized width shall be external diameter of tube plus 40 cm or the width of concrete bed cushioning layer whichever is more.

24.3.3.2. For depth exceeding one meter an allowance of 5 cm per meter of depth for each side of the trench shall be added to the authorized width (i.e. external diameter of pipe plus 40 cm) this allowance shall be applied to entire depth of trench. The authorized width in such cases shall therefore be equal to the depth of trench, plus external diameter of tube plus 40 cm.

24.3.3.3. Where more than one tube is laid, the diameter shall be reckoned at the horizontal distance from outside to outside of the outermost pipes.

- 24.3.3.4. Where sheeting etc. has been provided the authorized width of the trenches at bottom shall be increased to accommodate for sheeting etc. so the clear width available between faces of sheeting is as per provisions of (a), (b) & (c) above.
- 24.3.3.5. If the sides of the trench are not vertical, the toes of the side slope shall at end at the top of the pipe and vertical sided trench of authorized width as per (a), (b), (c) and (d) above shall be excavated from these down to the bed of trenches.
- 24.3.3.6. Where the tubes are laid in trenches, the work of excavation and refilling shall be paid of separately. The rate also does not include painting of pipes and sand filling all-round the tubes for which separate, payment shall be made. The length shall be measured in running meter basis.

**24.3.4.** The rate shall be for a unit of one running meter.

## **25. Open Well Mono Block Pump Set**

### **25.1. Applicable Indian Standards**

- |               |   |  |
|---------------|---|--|
| IS: 1520-1980 | : | Horizontal pumps for clear, cold, fresh, water.                                      |
| IS: 1520-1977 | : | Technical requirements for roto-dynamic special purpose pumps.                       |
| IS: 6595-1993 | : | Horizontal centrifugal pumps for clear, cold, fresh water for agricultural purposes. |
| IS: 8034-1989 | : | Submersible pump sets for clear, cold, fresh water.                                  |
| IS: 8418-1977 | : | Horizontal centrifugal self-priming pumps.   |
| IS: 8472-1977 | : | Regenerative self-priming pumps for clear, cold, fresh water.                        |
| IS: 9079-1989 | : | Mono set pumps for clear, cold, fresh water for agricultural purposes.               |
| IS: 9137-1978 | : | Code for acceptance tests for centrifugal mixed flow and axial pumps.                |

- IS: 9301-1984 : Deep well hand pumps.
- IS: 9542-1980 : Horizontal centrifugal mono set pumps for clear, cold, fresh water.
- IS: 9694-1980  
(Pt I,II,III&IV) : Code of practice for the selection, installation, operation and maintenance of horizontal centrifugal pumps for agricultural applications: Part I selection
- IS: 9694-1980 : Part II Installation.
- IS: 9694-1980 : Part III Installation.
- IS: 9694-1980 : Part IV Maintenance.
- IS: 10572-1983 : Methods of sampling pumps.
- IS: 10804-1986 : Recommended pumping system for agricultural purposes.
- IS: 10805-1986 : Foot-valve, reflux valve or non-return valve and bore valve to be used in suction lines of agricultural pumps.
- IS: 10981-1983 : Code of acceptance test for centrifugal mixed flow and axial pumps.
- IS: 11004-1985  
Pt I & II) : Code of practice for installation and maintenance of deep well hand pumps: Part I- Installation.
- IS: 11004-1985 : Part II-Maintenance.
- IS: 11346-1985 : Testing set up for agricultural pumps.
- IS: 11501-1986 : Engine mono set pumps for clear, cold, fresh, water for agricultural pumps.
- IS: 12225-1987 : Jet centrifugal pump combination.

## **25.2. Standard Construction**

**25.2.1.** Pumps Portion: Graded Cast Iron pump with high class powder coated.

**25.2.2.** Motor should be designed, assembled and tested as per IS

specifications, fully moisture proof & should run at low voltage successfully.

- 25.2.3.** Winding & Insulation: Stator windings consist of synthetic enameled copper wire coils with slot insulations which provide rigidity to winding at all working temperatures. The vacuum impregnation gives stator a high insulation resistance to moisture that gives complete protection to the winding under all working conditions, including humid tropical climates.
- 25.2.4.** Impeller: High tensile Bronze or Forged Impeller (Brass) should be Lead free & food graded.
- 25.2.5.** Bearings & Shafts: Anti friction double Z Ball Bearings should be fitted along with lithium-based grease in the motor at both the ends for long life. Shaft should be machined and grinded with latest technology to extremely fine limits to ensure proper fitting for bearings.
- 25.2.6.** Rotor: Pressure die cast aluminum cage rotor with radial fins which should be dynamically balanced along with a stainless-steel shaft.
- 25.2.7.** Seal: High Alumina and graphite mechanical seal.

## **26. Water Level Controller**

### **26.1. Standard Specification**

- 26.1.1.** Water Level Controller should be completely Automatic System without any 'Pumpset Protection Circuitry' feature:
- 26.1.2.** The system automatically controls pumping of water from Underground Sump / Well / Bore well to Overhead Tank.
- 26.1.3.** The system can be upgraded into "Multi-tank control system" to maintain water level in several overhead tanks.
- 26.1.4.** The system comes with Industrial Grade Electronic Components, Reliable Power Supply and Power Contactor in Powder coated Metallic Enclosure.
- 26.1.5.** The system is adoptable for any kind of starters of both Single phase and Three phase Motors.
- 26.1.6.** This system is based on AC Sensing Technology; hence the sensors are non-corrosive and maintenance free.

- 26.1.7.** This system is suitable for Residential Applications and simple Industrial requirements.
- 26.1.8.** The system has three positions Power Control Toggle Switch with "Auto" mode, "Off" mode and "Manual" mode.
- 26.1.9.** In "Manual" mode the Pump set can be controlled directly and level controller gets completely shut down and bypassed.
- 26.1.10.** Should follow IS 15840:2009 which defines Determination of volume of water & water level in lakes & ISO/TR 11330:1997 reservoirs.

**Signature of Contractor**

**Signature of Executive Engineer  
Building Department  
Bhavnagar Municipal Corporation**

# BHAVNAGAR MUNICIPAL CORPORATION



**Bid Documents For**  
**PROPOSED DOG HOME SHELTER & ANIMAL VACCINATION CENTRE**  
**AT NARI ROAD, KUMBHARWADA, BHAVNAGAR, DIST. BHAVNAGAR**

## **QUALIFYING CRITERIA OF APPLICANT**

<p><b>ARCHITECTS:</b></p> <p><b>MANISH RUPARELIA PVT. LTD.</b> 901-902, Time Square, Ayodhya Circle, 150 Feet Ring Road, Rajkot 360 006</p>	<p><b>EXECUTIVE ENGINEER:</b></p> <p><b>Building Department</b> <b>Bhavnagar Municipal Corporation</b> Mangalsinhji Road, Bhavnagar – 364 001</p>
---	---



## **BHAVNAGAR MUNICIPAL CORPORATION**

### **DIST: BHAVNAGAR**

## **QUALIFYING CRITERIA OF APPLICANT**

1. The demand draft of tender fees amounts as mentioned in the tender notice.
2. Agency will have to produce FDR as mentioned in the tender notice.
3. The Contractors / Companies having registration of Gujarat State PWD / CPWD / **R & B Category "A" Class & Above and Special in Building Construction** for the Tender Amount.
4. Experience of having successfully completed similar works during Last 7 years ending last day of month previous to the one in which applications are invited should be either of the following:
  - I. Three similar completed works costing not less than the amount equal to 40% of the estimated cost.

OR
  - II. Two similar completed works costing not less than the amount equal to 50% of the estimated cost.

OR
  - III. One similar completed works costing not less than the amount equal to 80% of the estimated cost

Note: Similar work shall mean Construction of Building Work as mentioned in tender documents in any of government organizations only.
5. Agency must produce CA certified Turn over certificate of the amount equal to or more than tender amount for last three years.
6. Defect Liability period will be Three years from the date of completion of the work.
7. Agency must produce Income tax return along with audit report for last 3 years
8. Agency must produce PAN Card No, G.S.T certificate
9. Agency must produce Bank solvency certificate for the Current Calendar Year (20% of Tender amount.)
10. Agency must produce all related documents in case of Partnership firm, Proprietary firm or private limited company.

11. Agency must produce Affidavit on Rs. 300 stamp paper mentioning not black listed in any work earlier or left work unfinished till date.
12. Agency must produce any other documents as mentioned in the tender notice.

**NOTE: No Exemption is Allowed for E.M.D Submission.**

**(Signature of contractor)**

**Executive Engineer  
Building Department  
Bhavnagar Municipal Corporation**

**BHAVANAGAR MUNICIPAL CORPORATION  
DIST. BHAVNAGAR**

**NAME OF WORK :-  
PROPOSED DOG HOME SHELTER & ANIMAL VACCINATION CENTRE AT NARI ROAD, KUMBHARWADA, BHAVNAGAR,  
DIST. BHAVNAGAR**

**Material test schedule**

Sr. No.	Materials to be tested	Name of laboratory test	Frequency of testing	Remarks
1	2	3	4	5
1	Water	Potability Salinity Chemical analysis	1 test per each source of supply per every working season.	Or as required while execution or change of source.
2	Sand	Fineness modules Specific gravity Water absorption Clay & Fine silt content Gradation test Pentography exclusion	1 test per each source of supply per every working season.	Or as required while execution or change of quarry.
3	Crushed Stone aggregate	Specific gravity Soundness Water Absorption Impact Value Gradation Test Crushing Test Abrasion Value Flakiness	1 Test / 150 Cu.m	Or as required while execution or change of quarry.

Sr. No.	Materials to be tested	Name of laboratory test	Frequency of testing	Remarks
4	H.B. Stone aggregate	Specific gravity	Upto 100 Cum. one Test	Or as required while execution or change of quarry.
		Impact Value		
		Flakiness		
		Abration Value		
		Crushing Test		
		Water Absorption		
5	Cement	Consistency	Upto 50 M.T. = 1 Sample	As per receipt of cement, one sample of 15 Kg. from 20 bags in consignment of 50 M.T. shall be taken for testing. Minimum one sample for each consignment less than 50 M.T. of cement received.
		Initial & Final setting time	50 to 100 M.T. = 2 Sample	
		Compressive strength	100 to 200 M.T. = 3 Sample	
		Fineness	200 to 300 M.T. = 4 Sample	
		Soundness	300 to 500 M.T. = 5 Sample	
		Specific gravity	500 to 800 M.T. = 6 Sample	
		Chemical analysis	800 to 1300 M.T. = 7 Sample	
6	Steel	Elongation	One test per 20 M.T. for each categories & every lots supplied.	Or as required while execution
		Tensile Strength		
		Bend and rebend test		
		Yield Strength		
		Dimension Test		
7	C.C. Cubes (Ordinary & Controlled C.C.)	Compressive Strength for 7 & 28 days	1 to 5 Cum. = 1 Test	Or as required while execution
			6 to 15 Cum = 2 Test	
			16 to 30 Cum = 3 Test	
			31 to 50 Cum = 4 Test	
			51 & above 4 + 1 test each 50 Cum.	
8	White Stone Bela	Compressive strength	1 Sample every 5000 Nos or change of quarry	Or as required while execution
		Water absorption		
		Salt Efforence.		
		Dimension & Tollerance.		
9	Coursed Rubble Stone	Compressive strength	1 Sample every 5000 Nos or change of quarry	Or as required while execution
		Water absorption		
		Salt Efforence.		
		Dimension & Tollerance.		

Sr. No.	Materials to be tested	Name of laboratory test	Frequency of testing	Remarks
10	Brick	Compressive strength	1 Sample every 5000 Nos or change of quarry	Or as required while execution
		Water absorption		
		Salt Efflorescence.		
		Dimension & Tolerance.		
11	Teak wood	Anatomy Test	1 Test per lot	Or as required while execution
		Density Test		
		Moisture content Test		
12	Tiels	Dimension Test	1 Test per manufacturer.	Or as required while execution
		Transverse Strength		
		Water Absorption		
		Abrasion Test		
13	Filling in excavation soil	Compaction Test	Every 200 Sq.Mt. Area	Or as required while execution or change of quarry.
		Specific gravity		
		Water absorption		
		Clay & Fine silt content		
14	Murrum	Compaction Test	Every 200 Sq.Mt. Area	Or as required while execution or change of quarry.
		Specific gravity		
		Water absorption		
		Clay & Fine silt content		

**Note :**

- 1 Testing of materials should be as per statement attached with the specification. The materials shall be tested in GERI Bill for testing shall be paid by the Deptt. and 1% (One percent) of amount put to tender from the running account bills of the work (As per G.R.(R&B) Deptt.No. TNC 1085/4/C Dt. 10-5-85.
- 2 Samples to be sent by contractor to GERI.

**Signature of Contractor**

**EXECUTIVE ENGINEER  
BUILDING DEPARTMENT  
BHAVNAGAR MUNICIPAL CORPORATION**

**MUNICIPAL CORPORATION  
BHAVNAGAR**

**VENDOR LIST**

**(A) LIST OF APPROVED VENDORS FOR CIVIL WORKS**

<b>Sr. No.</b>	<b>ITEMS</b>	<b>Approved Brands / Quality</b>
1	CEMENT OPC 53 Grade & SULPHATE RESISTANT CEMENT,S.R.C.	Ambuja, Hathi, Ultra Tech, Sanghi, Siddhi, Hi-bond
2	BRICKS	MBM, Arjun, PBM, 555, Kisan, ABM, TRD, Paresh, Dhara, B.R.C., Kiran, BMB, Kirit, Sonal
3	Steel TMT, CRS	TISCO, SAIL, VIZAG, Kamdhenu, NATIONAL, Electrotherm, JSW, Welspun steel, Pollad Steel, DIAMOUND TMT, M. G. Steel, Friends Steel, Crown next TMT, Briskon TMT
4	VITRIFIED TILES	Asian, Kajaria, Jonson, Varmora, Simpolo, OASIS
5	CERAMIC TILES	Asian, Kajaria, Johnson, Varmora, Simpolo, OASIS
6	GLAZED TILES	Asian, Kajaria, Johnson, Varmora, Simpolo
7	ACRYLIC PAINT	ICI, Asian, Nerolac, Burger
8	OIL BOUND DISTEMPER	ICI, Asian, Nerolac, Burger
9	EXTERIOR WEATHER PROOF EMULSION PAINT	ICI, Asian, Nerolac, Burger
10	Oil Paint	ICI, Asian, Nerolac, Burger
11	SANITARY WARE	Cera, Hindware, Parryware
12	CAST IRON PIPES AND FITTINGS.	NECO, Swayarhoo, Bengal, Oriental Castings, Electro steel Castings
13	P.V.C. PIPES AND FITTING (UPVC/CPVC)	Finolex, Supreme, Jain, Kisan, Astral, Dutron, Prince
14	CHROMIUM PLATED WATER SUPPLY FITTINGS	Jaquar, Ess Ess, Plumber ,ESSCO, Crown, Metro, Prince
15	GALVANIZED PIPE	Tata, Essco, Jaquar, Ess Ess, Plumber
16	GALVANIZED FITTINGS	'R' Brand, 'RV' Brand, Kranti
17	C.I. MANHOLE COVER	Manish, Sil, NECO
18	PLUMBING FIXTURES	Jaguar, Plumber, Essco
19	PVC WATER TANK (100% VIRGIN PVC)	Sintex, Aqua
20	ALUMINIUM SHEETS AND ACCESSORIES	Nalco, Jindal, Hindalco, Banko

Sr. No.	ITEMS	Approved Brands / Quality
21	ALUMINIUM EXTRUDED DOOR/ WINDOW SECTION	Jindal, Hindalco, Banko, Ajin India, Aldowin, Alumilite
22	ALUMINIUM HARDWARE	Rajdoot, Belu, Diamond, Glider, Ajin India, Aldowin, Alumilite
23	WATER PROOFING MATERIALS	Zycosil, Dr. Fixit, Kerakoll, Pidilite, Roff
24	DOOR CLOSER	Efficient Gadget, Everite, Hardwin, Aldowin, Ozone
25	DOOR FITTINGS	Godrej, Efficient Gadgets (E.G.) Dunex, Doorset, Suzu, Coral
26	HINGES	Suzu, Yama, E.P.P.W.
27	SCREW AND BOLTS	Nettle Folds, GKW, Stud
28	BOLTS & FASTENERS	Hilti, Fisher
29	LIFT	Top, Express, Omega, OTIS, Schander, TRIO, Aegis Elevator, Mitsubishi, Aditya, Siemens slider
30	ROOFING MATERIAL – Galvalume sheets	TATA, Essar, Jindal
31	Slag Cement	SANGHI CEMENT Sanghipuram
32	CPVC PIPES FOR AUTOMATIC SPRINKLER FIRE EXTINGUISHING SYSTEM	ASTRAL POLY TECHNIK LIMITED પાર્કિંગ એરિયા, બેઈઝમેન્ટ એરિયા જેવા વિસ્તારો સિવાય માત્ર કન્સીલ્ડ પાઈપીંગ માટે આ કંપનીના CPVC pipe નો ઉપયોગ fire sprinkler piping માટે કરવાની મંજૂરી આપવામાં આવે છે.
33	AAC Blocks	NXTBLOC
34	Jointing Mortar	NXTFIX Block
35	Ready Mix Plaster	NXTPLAST
36	Block joining Masonry Mortar	Unifix
37	Tile adhesive	Unifix
38	RCC bench	Sardar Pre cast
39	Rubber mould garden curbin	Sardar Pre cast



Sr. No.	ITEMS	Approved Brands / Quality
40	Rubber mould Paver block	Sardar Pre cast
41	Fencing Pole	Sardar Pre cast
42	RCC Masonry block	Sardar Pre cast
43	Pre cast wall	Sardar Pre cast

**(B) LIST OF APPROVED VENDORS FOR MECHANICAL & ELECTRICAL WORKS**

Sr. No.	Description	Name of Manufacturer
1	HSCF Pump	Crompton Greaves Ltd
		Kirloskar Brothers Limited (KBL)
		JASCO
		Mather & Platt Pumps Ltd.
		Jyoti Ltd.
2	Electric Motor	Lubi Industries LLP
		Bharat Bijlee Ltd.
		Jyoti Ltd.
		JSL Industries Ltd.
		Jeumont Electrical India Pvt. Ltd.
3	Electrical Panel	LHP
		Crompton Greaves Ltd
		Bhagyashree Power Control
		Dynamic Control System
		Elembica Services
		JSL Industries Ltd.
4	Kinetic Air Valve	Nutral Power Tech
		Kirloskar Brothers Limited (KBL)
		FOURESS Engineering (India) Limited.
		Durga Valves Pvt.Ltd
		Orbinox
	શ્રી કિલોસ્કાર બ્રાધર્સ લિમિટેડ	
5	Expansion Bellows	Precise Engineers
6	Dewatering (Drain) Pump(Submersible/ Horizontal)	KSB Pumps
		Kirloskar Brothers Limited (KBL)
		JASCO
		Crompton Greaves Ltd
		La Gajjar Machinery Pvt Ltd.
		Pullen Pumps Industries Pvt. Ltd.
		MBH
7	Sluice Valves and Sluice Gate	Kirloskar Brothers Limited (KBL)
		DURGA Valves Pvt.Ltd
		L & T Valves
		Jupiter
		SACHDEVA

Sr. No.	Description	Name of Manufacturer
8	UPVC Pipe	Supreme Industries Ltd., Mumbai
		Dutron Polymers Ltd
		Parixit Industries Ltd., A'bad
		Jain Irrigation Systems Ltd., Jalgaon
9	HDPE Pipe	Parixit Industries Ltd., A'bad
		Jain Irrigation Systems Ltd., Jalgaon
		Dutron Polymers Ltd
		Jindal
		Essar Steel
10	C.I. Pipe	Electro Steel, Kejriwal, Oriental Castings, BIC, Jindal, Lanco Industries Ltd., Chennai, Kesins
13	EOT Crane	Grip Engineering Pvt. Ltd., JAPS Project, Brady & Morris Engineering Co. Ltd., Techno Industries
14	Cable & Wires	KEI Industries Ltd.
		Polycab Wires Pvt. Ltd.
		Aerolex Cables Pvt. Ltd.
		Allwin Industries
		Finolex Cables
		L&T Cables
		ULTRA CAB (India) Limited
15	Transformer	Atlanta Electricals Pvt. Ltd.
		Powerlite Electricals
		Voltamp Transformers Ltd.
		SKP Transformers
		Arya Electronics
16	Components for MCC :	
	Switch	L&T, Siemens
	HRC Fuse	L&T, Siemens
	Timer	L&T, Siemens
	Relay	L&T, Siemens
	Push Button Stations	L&T, Siemens
	Indicating Lamp	L&T, Siemens
	Cable Jointing Kit	CCI, M. Seal
	MCB/DB's	MDS, Siemens, Indokupp
17	Capacitors	L&T, Crompton, Khatau Note: Capacitors shall be oil fill type
18	KWH Meter	Simco, Jaipur, GEC
19	Light Fittings: (Indoor & Outdoor Luminaries)	Philips, Crompton, Bajaj, NESSA Illumination
20	Exhaust Fans	Crompton, Bajaj,
21	Ceiling Fans	Crompton, Bajaj, Havells
22	Air Blowers	Everest Ltd.
		Swan Pneumatics (P) Ltd
23	Alum Dosing Pumps	Asia LMI
		VK Pumps
		Swelore
24	Pressure Gauges	General Instruments
		Bells Control
		H. Guru Marketing
25	Level Gauge / Indicator	R K Dutt

Sr. No.	Description	Name of Manufacturer
		Levecon
		S. B. Electromec
26	Clarifier Equipment	Enviro Control Associates
		Voltas Ltd
		Hindustan Dorr-Oliver
		Geomiller/Triveni
27	Chlorination System	Industrial Device (I) Pvt. Ltd
		Metito
		Chloroequip
		Pennwalt
28	Gear Box	Greaves
		Radicon
		Elecon
		Shanti
29	Level Switches	Level-Tech
		Revathi Electronics
		Levelc
30	Refrigerator	LG, Samsung, Kelvinator
31	PVC Pipes for Fluid	Finolex, Jain Irrigation
32	PVC Conduits for Electricals	Precision, Shakti
33	Butterfly Valve	KIRLOSKAR Brothers Limited(KBL), DURGA valves Pvt Ltd, L & T valves, R&D MULTIPLE, Jupiter, श्री कृष्णा एन्जिनीयर्स IVC, IVI, Audco, R & D multiple, Jupiter, Cair, Orbit Engineers
34	Check Valve (Dual Plate check Valve)	KIRLOSKAR Brothers Limited(KBL), DURGA valves Pvt Ltd, Orbinox, R&D MULTIPLE, Orbit Engineers
35	Metallic Expansion Bellow	Beloflex(B.D. Engineers), Stanfab Engineering Pvt. Ltd., D. Wren Engineering Pvt. Ltd., Sur Industries,
36	Centrifugal / Centrifugal Non Clog Pumps	Beacon Weir, KSB, Mather & Platt (Wilo), Worthington, WPIL, Xylem pumps , Grundfos Pumps Pvt. Ltd., MBH, JASCO
37	Submersible non Clog Pumps / Submersible Centrifugal Pumps	Kirlosker, KSB, ABS, ITT- Flyght, Xylem pumps, Grundfos Pumps Pvt. Ltd. , MBH, JASCO, AQUA, Jyoti, PULLEN PUMPS, Alpha, Het Pump
38	Screw Pump	Roto, Netzsch, Tushaco, Seepex
39	Metering / Dosing Pumps	Swellore, V.K. Pumps, Shapotools
40	Non Return Valves ( Single / multi door) / Dual Plate Check Valves	Kirlosker, IVC, IVI, R & D multiple, Durga, Jupiter, Cair, Orbit Engineers
41	Knife Gate valves	Jash, Fouess, Vass (Dezurick), Vag, Orbinox, Orbit Engineers
42	Sluice gates / open Chanel Gates	Jash Engineering, IVC, R & D Multiple, Jupiter
43	Mechanical Fine Screens – Step (Mat) Type / Drum Type	Jash, Huber, Johnson, Savi, Italy, Apollo Screens

<b>Sr. No.</b>	<b>Description</b>	<b>Name of Manufacturer</b>
44	Mechanical Course bar Screen	Jash, Huber, Johnson, HDO, Triveni, Savi, Italy
45	Manual Bar Screen	Jash, Japs, HDO, Triveni, Auric
46	Grit mechanism	EIMCO – KCP, Hindustan Dorr – Oliver, Jash-Shivpad, Triveni, Voltas
47	Diffused Aeration System	EDI, OTT, Rehau
48	Air Blower	Kay, Swam, Everest, Usha Compressors, Gardner Denver
49	Agitator / mixer	Remi, Schurtek, Fibre & Fibre, Milton Roy
50	Gear Boxes	Greaves, Elecon, CPEC, PEPL, Bonfiglioli
51	Centrifuge	Humboldt, Alpha Laval, Hiller
52	HDPE Pipes	Astral, Dutron, Duraline, Narmada, RIL (PIL), Penwalt, Anjney, Jain Irrigation, Sangir
53	Air Compressor	Ingersoll – Rand, Khosla, Kirlosker, CPE, Alpha
54	Bearing For All Equipments	SKF, FAG, Tata
55	Fasteners	Precision, Durakhanawala, Echjay, Tata, Sundaram
56	Mechanical Seals	Eagle Seals (Sealol), Durametallic, Burgman
57	Electric Actuator	Auma, Rotork, Emerson, Pentair
58	(1) CATEGORY III Indoor LED fittings, LED Panel light, LED down light, outdoor LED light (street light, LED flood light, LED Post top lantern, LED bollard ) (2) Solar LED Light	NESSA ILLUMINATION TECHNOLOGIES PVT.LTD., Litsun, Nextray
59	STREET LIGHT POLES	AMBICA POLES (for octagonal poles, swage poles, street light poles, high mast poles, decorative poles, conical poles, JETCOTECH Engineering LLP
60	Resilient Seated Slice Valve	Cair
61	Air Valve	Cair, Orbit Engineers
62	Flow Control valve	Cair
63	Altitude Control valve	Cair, Orbit Engineers
64	Pressure reducing valve	Orbit Engineers
65	Pressure relief valve	Orbit Engineers
66	Ball valve	Orbit Engineers
67	Mast pole	JETCOTECH Engineering LLP
68	Earthing material	JETCOTECH Engineering LLP
69	Hot dip galvanizing	JETCOTECH Engineering LLP
70	LED Highbay	Litsun

**(C) LIST OF APPROVED VENDOR FOR INSTRUMENTATION SYSTEM**

<b>SR NO</b>	<b>DESCRIPTION</b>	<b>Name Of Manufacturer</b>
1	Electromagnetic Flow Meter	E+H, Siemens, Abb, Fuji, Yokogawa, Krohne-Marshall, AAROHI Embedded System Pvt Ltd., Emerson, SBEM
2	Pressure Gauges	Wika, H.Guru, General Instruments Consortium Manometer (India) P. Ltd. , Baumer, Waaree
3	Pressure Switch	Danfoss , Indfoss , Switzer
4	Process Analyzers (pH, DO, Free / Residual Chlorine , BOD / COD)	E+H , Emerson , Hach , Chemitech , Polymetron, Wtw (Forbes Marshall),Yokogawa
5	Ultrasonic transmitter level / diff. level / flow	E+H, Siemens – Milltronics, Krohne, Vega
6	Hydraulic level transmitter	E+H,Siemens, ABB, Forbes- Marshall, Emerson, SBEM
7	Displacer/Float Switches	Levcon, Nivo, Toshbro, Pune Techtrol , SBEM
8	PP Float / Buoyancy switch	Pepprl + Fuchs, Baumer, Waaree, E+H , Pune Techtrol , SBEM
9	Float & Board Type Level Gauge	Levcon, Nivo, Toshbro, Pune Techtrol, SBEM
10	Electromagnetic Flow Meter	E+H, Siemens, ABB, Fuji, Yokogawa, Krohne-Marshall
11	Field Transmitter (P, DP,F, L , T)	ABB, Fuji, Yokogawa, Honeywell, Emerson
12	Pressure Gauges	Wika, H.Guru, General Instruments Consortium Manometer (India) P. Ltd., Baumer, Waaree
13	Panel Mounted Process Indicator & Flow Integrator	Masibus, Nishko, Nivam, Selectron, Radix, Yokogawa, ABB
14	Pressure Switch	Danfoss, Indfoss, Switzer
15	Programmable Logic Controllers	Rockwell (Allen Bradeley), Siemens, Schneider, Fuji, ABB, GE Fanuc
16	Control Panel Enclosure	Rittal, Enklotek, Bartakke, BCH, Eldon
17	Alarm Annunciator	Aplab Ltd., Minilec , IIC
18	Solenoid valves	Asco, Rotex, Schrader
19	Tube Fitting	Excel Hydropneumatic, Multimetel, Placka

20	Instrument Valves , Manifolds	Aptek, Anmol (Superlok), Excel Hydropneumatic, General
21	Fitting	Instrument Consortium , Multimetal, Technomatic, Placka
22	Pneum , Brass Fitting	Swagelok, Multimetal Industries, SMC, Festo
23	Control Panel Accessories / Components	
a.	Miniature Relay	Wago, Omron,Phoenix, Rockwell
b.	Indication Pilot Lamps (LED Type)	Teknic, Schneider, Siemens
c.	Push Button / Selector Switch (with NO/NC Elements)	Teknic, Schneider, Siemens
d.	DC Power Supplies (DIN Rail mounted)	Phoenix, Omron, Schneider, Rockwell
e.	Terminals	Elmex, Phoenix, Wago, Connectwell
f.	Panel Wires	Finolex , Havell's , R R Kabel
g.	Panel Illumination	Philips , Crompton , GE
24	Instrument Cables (Power , Signal , Control)	Associated Cables, Associated Flexible and Wires P.Ltd., Brooks Cables, Thermo Cables, Udey Pyro
25	Cable Glands	Ex- protecta, Braco, Sudhir, Comet, Connectwell
26	Junction Box	Ex- protecta, CEAG, Sudhir, Baliga, FCG
27	Cable Tray	M.M.Engineering, Globe, Jacinth, Equi. Reputed, JETCOTECH Engineering LLP
28	Computer System	HP-Compaq, Dell, IBM, Sony, Samsung
29	UPS	Hirel-Hitachi, Emerson, APC
30	<ol style="list-style-type: none"> <li>1. PLC (Programmable Logic Controller )</li> <li>2. SCADA (Supervisory Control and Data acquisition )</li> <li>3. VFD (Variable Frequency Drive Up to 500 KW )</li> <li>4. ACB ( Air Circuit Breaker up to</li> </ol>	MITSUBISHI ELECTRIC INDIA PRIVATE LIMITED, Emerald House, EL-3, J Block, M.I.D.C., Bhosari, Pune 411026

	6000A) 5. MCCB ( Moulded Case Circuit Breaker up to – 1600 A) 6. MCB (Miniature Circuit Breaker up to – 63 A) 7. ELCB (Earth Leakage Moulded Case Circuit Breaker up to 1600 A) 8. Contractor up to – 800 A & OLR (Over load Relay) up to 630 A 9. Multi Functional Meters 10. MPCB (Motor Protection Circuit Breaker up to 32 A )	
--	--	--

**(D) LIST OF APPROVED VENDORS FOR MATERIALS RELATED TO WATER SUPPLY AND SEWERAGE NETWORK**

SR. NO.	ITEMS	NAME OF AGENCIES
1	A C Pressure pipe MAZZA process	Lotus, Kirti
2	A C Pressure pipe MEGHNANI process	Lotus, Kirti, Hindustan
3	Sluice Valve	Durga, kartar, Kirloskar, Jupiter, SACHDEVA ( C.I. & D.I.), શ્રી કિર્તિ ઇન્ડસ્ટ્રીઝ, Cair, Orbit Engineers
4	DI Pipe	Electrotherm (I) Ltd.,Ahmedabad, Lanco Industries Ltd.,Chennai, Electrsteel, Jindal Saw Ltd.,Ahmedabad, Kesins, Welspun
5	R.C.C. PIPE ( COLLAR JOINT & SOCKET SPIGOT JOINT) CLASS NP3 & NP4, & R.C.C. COLLARS	VIPUL SPUN PIPES (SIHOR & LATHIDAD,BOTAD), KATARIYA & CO. (DHASSA), OMKARESHVAR PIPES ( NAVAGAAM), OMKAR PIPES ( LATHIDAD, BOTAD), MARUTI PIPES ( BAGODARA ,AHMEDABAD), KALATHIYA PIPES(BAGODARA ,AHMEDABAD), R. S. PIPES (BODELI), UMA HUME PIPES (KALOL, GANDHINAGAR), SIDHDHIVINAYAK ( KARDEJ ,BHAVNAGAR)
6	R.C.C. MACHINEOLE FRAME & COVER, INLET FRAME COVER 10T.(600*450 MM.) , 20T.,35T., & 50T.	SONI CEMENT PRODUCT , VIPUL SPUN PIPES, KATARIYA & CO., OMKARESHVAR PIPES, OMKAR PIPES, MARUTI PIPES, KALATHIYA PIPES , R. S. PIPES, UMA HUME PIPES, SIDHDHIVINAYAK , S.K. Corporation, Laxmi Price Industries, S.J.Corporation, Sardar pre cast

7	Stone ware PipeManufacturer having BIS Certificate for ISI marking	Krishna Pipe, j.K. Pipe, Taya ceramic, Burn & co., perfect Potteries, Navroji Vakil, Kashmira
8	D.I. & C.I. FITTINGS	RG BRAND, ESSEM Engineering Industries, Bikaners Engineers works
9	CID Joints	ESSEM Engineering Industries
10	Valves & Graded Castings	ESSEM Engineering Industries
11	Pipe Fittings	ESSEM Engineering Industries, Bikaners Engineers works
12	CI/DI/MS graded castings	Bikaners Engineers works
13	Scraper machine hole	Sardar Pre cast

Note: The vendor list changes from time to time. The vendor list of that time has to be followed during the work. Any material not as per the prescribed specification and included in the vendor list shall be rejected and action taken to remove such material from the vendor list.





## Bhavnagar Municipal Corporation



- એજન્સી દ્વારા કામ શરૂ કરતા પહેલા સ્થળ સ્થિતિ મુજબના ફોટા ગ્રાફ રજૂ કરવાના રહેશે અને ત્યારબાદ જ કામગીરી શરૂ કરવાની રહેશે. વખતો વખત ટેન્ડર માં સમાવેશ થતી આઈટમો ની કામગીરી ના ફોટા ગ્રાફ રજૂ કરવાના રહેશે.
- આ તમામ ભાવમાં જી.એસ.ટી.નો સમાવેશ કરવામાં આવેલ નથી. સરકારશ્રીના નિયમાનુસાર અલગથી જી.એસ.ટી ચુકવવામાં આવશે. વધુમાં એજન્સીને સરકારશ્રીના નિયમનુસાર જી.એસ.ટી.નું ચુકવણું કરવાનું રહેશે.
- સ્થળે VFRPBL JLH , F. G 5; FZ Yતી હોય તો VF DF8[ JLH 5|B\$XG VUJL TDFD jI J:YF Sllg8FS8Z[: JBR[ SZJFGL ZCXP TDPH SM. VS: DFT S[HFGCFGL YFI TMT[ VUJL TDFD HJFANEZL Sllg8FS8ZGL ZCXP
- હાલના વેન્ડર લીસ્ટ અને ભવિષ્યમાં જે તે સમયે જ્યારે ભાવનગર મહાનગરપાલિકા અને સક્ષમ સત્તા વેન્ડરમાં ફેરફાર કરશે તે
- અદ્યતન વેન્ડર લીસ્ટ માન્ય ગણીને કોન્ટ્રાક્ટરશ્રીએ સાઈટ પર માન્ય મટીરીયલ વપરાશમાં લેવાનું રહેશે તે બાબતે વધારાના ભાવ
- તફાવત ખર્ચ ચુકવવામાં નહિ આવે.
- SFD X- SZTF 5J[ SFDGL IJUTMNXFJT] AMO" SFD 56" YTF ; |ML Sllg8FS8Z[: JBR[ , UFOL ZFBJFG] ZCXP[VgI YF SM. 56 ; DI[ AMO" , FU[ , DF, D GCL 50X[tI FZ[-15I F 5 \_\_\_qV GL 5G<8L , FU] 50XP
- ટેન્ડર/એજન્સીએ ટેન્ડર ડોક્યુમેન્ટ સાથે ESIC કોડ/રજીસ્ટ્રેશન ફરજિયાત રજૂ કરવાનું રહેશે, ESIC કોડ/રજીસ્ટ્રેશન સિવાયનું ટેન્ડર માન્ય ગણાશે નહીં.
- કોન્ટ્રાક્ટરશ્રીએ બાંધકામ માં OPC ૫૩ ગ્રેડ સિમેન્ટ વાપરવાની રહેશે.
- ❖ p5ZMST TDFD XZTM VDM V[ JFR L4J'RFJL4; DHL4JRFZLG[ 8gOZDF EEFJM EZ[ , K[ H[ DG[ q VDG[ SA[ , DHIZ K[ VG[ T[ DJHA VDM SFD SZJF AWF. V[ KLVp

Sllg8FS8ZGL ; CL P

Sllg8FS8ZG[ GFD P

Sllg8FS8ZGM I; SSM

TFZLB

# **BHAVNAGAR MUNICIPAL CORPORATION**



**-: BID DOCUMENTS FOR :-**

**PROPOSED DOG HOME SHELTER AT NARI ROAD, KUMBHARWADA,  
BHAVNAGAR, DIST. BHAVNAGAR**

## **TECHNICAL SPECIFICATIONS**

### **SELF SUPPORTED TRUSS LESS ROOF**

**ARCHITECTS**  
**MANISH RUPARELIA PVT. LTD.**  
901-902, Time Square,  
Ayodhya Circle, 150 Feet Ring Road,  
Rajkot 360 006

**EXECUTIVE ENGINEER**  
Building Department  
Bhavnagar Municipal Corporation  
Mangalsinhji Road,  
Bhavnagar – 364 001

**General Description :**

Providing Fabricating and Laying of colour coated Galvalume (Self Supported Roofing System) material for self-Supported roofing system. Material shall be of following Specification BMT 1.10mm to 1.6mm APT 1.15mm (tolerance +/-0.02mm) including supplying Loading transporting unloading and staking at site fabricating and laying with all contractor's tools machineries materials and fixtures labours including all lead and lift and laps/wastage if any etc. complete. The colour of sheet will be decided by engineer-in-charge. the rate is also inclusive of designing of roofing of roofing system, proof checking and providing Execution drawing. fabrication and installation of self-supported roofing technology similar to Proflex or other Standard Roof System should also have necessary provision for fixing of solar System panels on roof as required by BMC and necessary fittings for hanging of electrical items (viz, Lights, Fans, etc.) A) Length greater than 25.0m and up to 33m or as per site requirement.

Note: The roofing system should be self-supported roofing system i.e., without trusses purlin or any ancillary supports shall be designed by contractor through the consultant and got duly proof checked from IIT. any other GOVT agencies. Design and drawing will be approved by DFCCIL For design of roofing system relevant load parameters of is code of practice to be adopted. The cost of designing and proof checking of design and drawing will not be paid separately and these charges are deemed to be inclusive of preparation of necessary auto cad drawing required for execution of roofing system. the details of arch may be changed as per the design with approval of DFCCIL. The roofing system should be 100% leak proof resistant to corrosion and maintenance free. work will be done under proper supervision of approved manufacturer whose supervisor must remain at site during the execution of work. The rate is inclusive of cost of supervisor also. The rate is inclusive of cutting sheet or for polycarbonate sheets for roof lighting fixing turbo ventilators as made available through item no. 1 of this schedule (Note 2 below) as per direction of DFCCIL. No deduction for opening in sheet up to 3 Sqm. Payment will be made for normal Proflex roof sheeting payment shall be made by measuring length and width at bottom corrugation of built up Proflex roof sheeting.

Standard Roof Systems : Proflex, Alcox, Steel Craft, etc.

**Material Specification :**

Material:	Aluminum - Zinc Alloy sheets - (Galvalume base - An Alloy of 55% Aluminum, 43.4% Zinc & 1.6% Silicon)
Grade:	ASTM A792 Grade D (Yield Strength: 300-350 MPA)
Thickness:	0.7-1.6 mm BMT (Base Metal Thickness)
Colour Coating:	RMP, PVDF, SDP, SMP & HDP coatings
Coating Grade:	AZ150

# STANDARD SPECIFICATIONS FOR TRUSSLESS ROOFING

## GENERAL MATERIAL SPECIFICATION

### 1.0) SCOPE:

This Specification covers 55% aluminum-zinc alloy coated steel sheet in coils and cut length. This product is intended for applications requiring corrosion resistance or heat resistance or both.

### 2.0) MATERIAL:

Imported/ India Galvalume sheets with following contents:

55% Aluminum 43.4% Zinc 1.6% Silicon	Alloy Coated High Tensile steel
--	---------------------------------

### 3.0) REFERENCE CODE:

ASTM A792/A792M-9a

### 4.0) CLASSIFICATION:

The material is available several designations based on the type of base metal used like,

- Commercial steel (CS)
- Forming Steel (FS)
- Drawing steel (DS)
- High temperature steel (HTS)
- Structural steel (SS)

Structural steel is available in two grades namely 340 and 550

The product is available in several coating masses with coating designations as given below

Coating Designation	Minimum Requirements	
	Triple spot test	Single spot test
	Total both sides, g/m <sup>2</sup>	Total both sides, g/m <sup>2</sup>
AZM 100	100	85
AZM 110	110	95
AZM 120	120	105
AZM 150	150	130
AZM 165	165	150
AZM 180	180	155

AZM 210	210	180
---------	-----	-----

All coating weight tests have to be performed in accordance with the requirements stated in specification ASTM A924/A924M

**5.0) CHEMICAL COMPOSITION:**

The heat analysis of the base metal shall confirm to the requirements as shown below:

Composition, %—Heat Analysis Element, Maximum, Unless Otherwise Shown														
Designation	C	Mn	P	S	Al	Cu	Ni	Cr	Mo	V	Cb	Ti <sup>B</sup>	N	B
CS Type A <sup>C,D,E</sup>	0.10	0.60	0.030	0.035	...	0.25	0.20	0.15	0.06	0.008	0.008	0.025	...	...
CS Type B <sup>C,F</sup>	0.02 to 0.15	0.60	0.030	0.035	...	0.25	0.20	0.15	0.06	0.008	0.008	0.025	...	...
CS Type C <sup>C,D,E</sup>	0.08	0.60	0.10	0.035	...	0.25	0.20	0.15	0.06	0.008	0.008	0.025	...	...
FS <sup>C,G</sup>	0.02 to 0.10	0.50	0.020	0.030	...	0.25	0.20	0.15	0.06	0.008	0.008	0.025	...	...
DS <sup>D,E</sup>	0.06	0.50	0.020	0.025	0.01, min	0.25	0.20	0.15	0.06	0.008	0.008	0.025	...	...
HTS <sup>C</sup>	0.02 to 0.15	0.60	0.040, min	0.035	...	0.25	0.20	0.15	0.06	0.008	0.008	0.025	...	...

Composition, %—Heat Analysis Element, maximum, Unless Otherwise Shown												
Designation	C	Mn	P	S	Cu	Ni	Cr	Mo	V	Cb	Ti <sup>A</sup>	N <sup>B</sup>
Structural Steel:												
Grade 33 [230]	0.20	1.35	0.04	0.040	0.25	0.20	0.15	0.06	0.008	0.008	0.025	...
Grade 37 [255]	0.20	1.35	0.10	0.040	0.25	0.20	0.15	0.06	0.008	0.008	0.025	...
Grade 40 [275]	0.25	1.35	0.10	0.040	0.25	0.20	0.15	0.06	0.008	0.008	0.025	...
Grade 50 Class 1, Class 2, and Class 4 [340 Class 1, Class 2, and Class 4]	0.25	1.35	0.20	0.040	0.25	0.20	0.15	0.06	0.008	0.008	0.025	...
Grade 60 [410]	0.25	1.35	0.20	0.040	0.25	0.20	0.15	0.06	0.008	0.008	0.025	...
Grade 70 [480]	0.25	1.35	0.20	0.040	0.25	0.20	0.15	0.06	0.008	0.008	0.025	...
Grade 80 [550] Class 1	0.20	1.35	0.04	0.040	0.25	0.20	0.15	0.06	0.008	0.015	0.025	...
Grade 80 [550] Class 2 <sup>C</sup>	0.02	1.35	0.05	0.020	0.25	0.20	0.15	0.06	0.10	0.10	0.15	...
Grade 80 [550] Class 3	0.20	1.35	0.04	0.040	0.25	0.20	0.15	0.06	0.008	0.015	0.025	...

**6.0) COATING COMPOSITION:**

The 55% aluminum zinc alloy coating composition, by weight, is normally 55% aluminum, 1.6% silicon and the balance zinc.

**7.0) MECHANICAL PROPERTIES:**

The structural steel sheet shall confirm to the mechanical property requirements as given below for different grades.

Grade	Yield Strength, min, MPa	Tensile Strength, min, MPa	Elongation in 50 mm, min, %
230	230	310	20
255	255	360	18
275	275	380	16
340 Class 1	340	450	12
340 Class 2	340	...	12
340 Class 4	340	410	12
410	410	480	10 <sup>B</sup>
480	480	550	9 <sup>B</sup>
550 Class 1 <sup>C</sup>	550 <sup>D</sup>	570	...
550 Class 2 <sup>C,E</sup>	550 <sup>D</sup>	570	...
550 Class 3	550 <sup>D</sup>	570 <sup>F</sup>	3

All tests for mechanical properties shall be conducted in accordance with ASTM standard A924/924M

### 8.0) BENDING PROPERTIES:

Structural sheets are commonly bent by cold bending. The suggested minimum inside radii for 90-degree cold bending for structural steels.

Coating bend test:

For structural steel, the coating bend test inside diameter shall have a relation to the thickness of the specimen as shown below,

**TABLE 6 Coating Bend Test Requirements—Structural Steel**

Grade	Ratio of the Inside Bend Diameter to Thickness of the Specimen (Any Direction)
33 [230]	1½
37 [255]	2
40 [275]	2½
50 Class 1, Class 2, and Class 4	A
60	A
70	A
[340 Class 1, Class 2, and Class 4]	
80 Class 1, Class 2, and Class 3	A
[550 Class 1, Class 2, and Class 3]	

<sup>A</sup> Grades not subject to bend test requirements.

## **9.0) DIMENSIONS & PERMIABLE VARIATIONS:**

All the dimensions and permeable variations shall comply with the requirements of specification ASTM A924/A924M.

### **B: REQUIREMENTS FOR THIS TENDER**

- 1.0) It is the sole responsibility of the contractor to design the entire building with arch shaped self-supported roofs as per relevant IS/International codes and he will be considered as the single window responsible person for arch shaped self-supported roofing system.
- 2.0) The design of roofing system includes the design of all accessories like fasteners, nuts, bolts, clamps, hangers etc. all complete.
- 3.0) Contractor also has to prepare the drawings in AutoCAD of the entire structure including truss less roofing system and submit them along with design calculation to BMC for approval. It will take 15 days to get it approved since BMC has to get it vetted by our consultant.
- 4.0) The steel sheet shall be 3'-0" (914MM) width (tolerance +/- 2 mm) which shall be curved and molded at site using mechanical press and dies to the desired curves and shape to form 2'-0" (610 MM) wide interlocking panels (indicative drawing attached). These panels shall be erected in position and their seams shall be interlocked and pressed to close the seam forming a water tight joint.
- 5.0) Minor colour chipping/ scratching should be rectified by applying Epoxy lacquer.
- 6.0) The supply for the installation of fasteners at the end will be there in the scope of work of contractor.
- 7.0) The installation should be done by mechanized methods. The contractor has to mobilize required No. of Hydra for transportation of sheets and cranes for the erection of seamed sheets.
- 8.0) Adequate precautions shall be taken by the contractor during the installation process for the safety of their workers. Safety belts, helmets and other safety equipment's for the execution of job must be used, wherever required. Works in height panel installation process shall not be carried out in case of wind velocity at site location is above 22 K.M. per hour.
- 9.0) The contractor shall make provisions for the hangers and clamps etc. for providing light fixtures in the roof, wherever required.

- **TENSILE STRENGTH:**

Grade 350

- **COATING:**

Coating Mass of AZ-150 of the shade to be decided by BMC- (150 gm/m<sup>2</sup>- both sides)

**ORGANIC PAINT COATING SYSTEM:**

Regular modified polyester with internal lubricant, suitable for roll forming.	20 microns of top coat over. 5 microns of primer. 7 microns of black coat over 5-micron primer.
--	---

- **THICKNESS:**

- i) Basic material the thickness (BMT)= 1.00 MM
- ii) Total Coated thickness (TCT) = 1.09 MM  
with a tolerance of -0/0.02 mm.

- **TESTING OF MATERIAL:**

The sheets shall be tested at the cost of the contractor before use to check the following:

- i) Thickness
- ii) Tensile Strength
- iii) Contents of Aluminum, Zinc and Silicon.
- iv) Water tightness

All the test mentioned in ASTM codes like the tests given below has to be done by the contractor and the same shall be vetted by any of the BMC approved third party agency which shall be submitted to BMC's approval prior to the installation of the roofing system.

PROPERTY	TEST METHOD	REGULAR MODIFIED PLASTER
TOP COAT THICKNESS (MICRONS)	ECCA T1-1995	25
GLOSS AT 60 DEGREE	ECCA T2-1995	30-90 %
PENCIL HARDNESS TEST	ECCA T4-1995	H-2H
IMPACT TEST (IN JOULES)	ECCA T5-1995	10 J
SALT SPRAY TEST	ECCA T8-1996	750 HRS



ADHESION TEST (CROSS - HATCH)	NCCA II - 5	100%
ERICHSEN CUPPING TEST	ECCA T6	7 MM
HUMIDITY TEST	NCCA III - 6	1000 HRS
T-BEND TEST (T=SUBSTRATE THICKNESS)	ECCA T-7	2T (NO TAPE LOSS)
SOLVENT RUB TEST (MEK (methyl ethyl ketone) - DOUBLE RUB)	ECCA T-11	> 50 RUBS
CHEMICAL RESI. (5% NAOH, 5% H2SO4)	ECCA T 18-1995	NO BLISTERING, DISCOULERATION & SOFTENING OF PAINT FILM
MAX OPERATING TEMP.	-----	120 DEGREE C

- **STANDARDS:**

The agency shall be ISO certified and shall follow International Standards for Galvalume sheet roofing.

- **FIXTURES:**

The fixtures like fasteners, turbo ventilators and translucent sheets shall be designed to suit the requirements of BMC.

- **SYNCHRONISATION:**

The contractor will be considered as the single responsible person for the roofing system in all respects including warranty and it is his sole responsibility to remain in touch with the agency doing fixing of Galvalume sheet for proper liaisoning.

- **WARRANTY & MAINTANANCE:**

The contractor has to submit the following guarantee/warranty certificate to BMC before starting the work and he alone will be considered responsible for this during the entire warrantee period.

- i) Onsite warranty for one year after completion of work, which shall include free replacement and repair of each and every part within 72 hours of reporting by the concerned authority
- ii) Annual maintenance contract for a period of 1 years after completion

which shall include:

- a. Checking and fixing of the fasteners to ensure that these are in order.
- b. To check the seaming in between the sheets.
- c. To repair the cracks wherever required.
- d. Coats of epoxy wherever required.

Besides above the entire sheeting work shall be checked every quarter and a certificate shall be issued by the sheeting contractor that the Galvalume sheets installed by them are in order.

Also, sheets shall be cleaned with jet of water and detergent (if required), every six months to remove dirt / dust over them up to Defect liability period.

## Drawings :

### Recommended Design for RCC Gutter

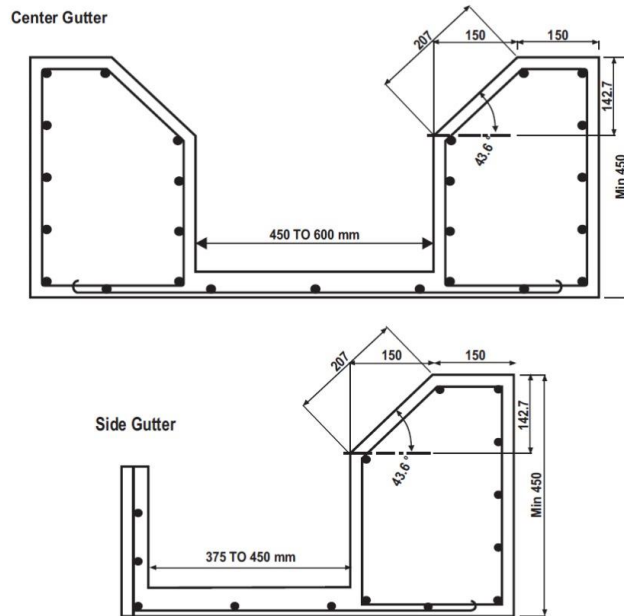

The slope co-efficient shall vary as per the radius of the panel.

## Recommended Design For MS Gutter

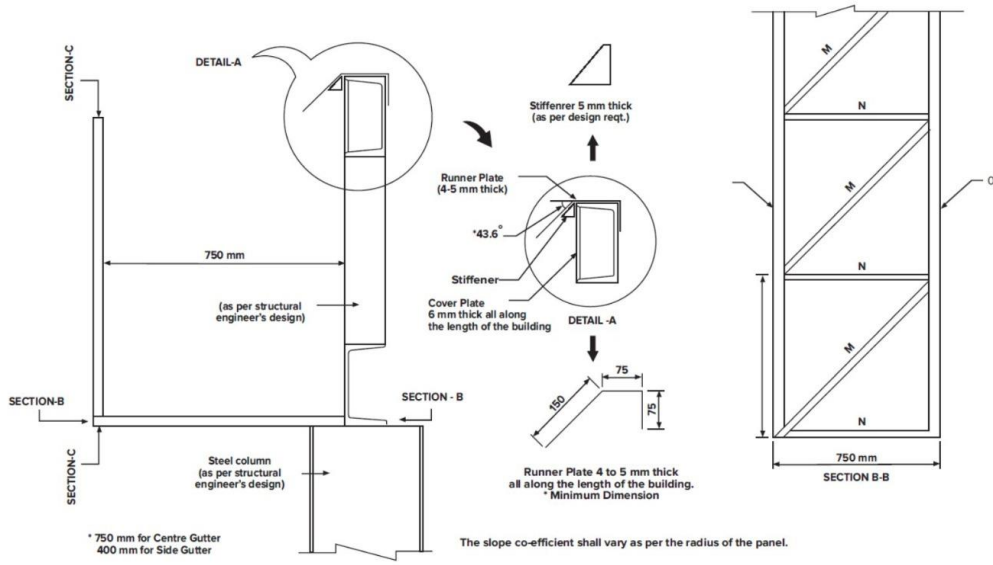

## Panel Profile Section

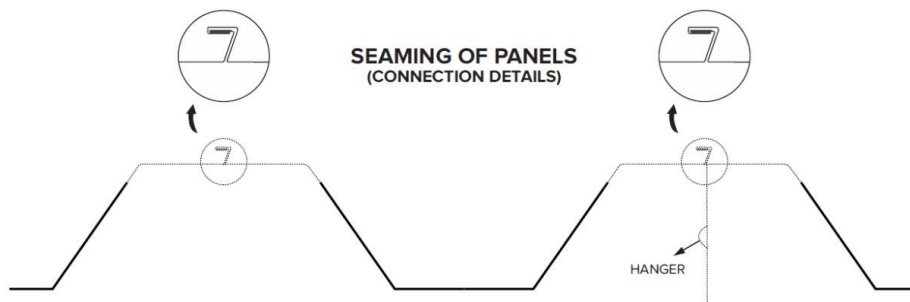
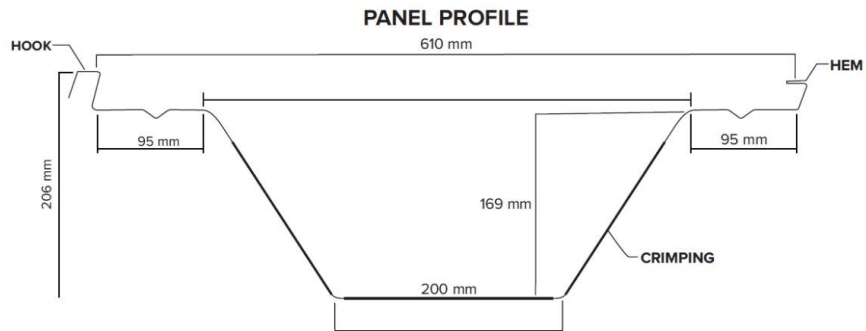

રસ્તા, પુલો તથા મકાનોના બાંધકામની વિગતો તથા  
સ્પેશીફિકેશન અંગેના કામના સ્થળ પર બોર્ડ મુકવા બાબત.

ગુજરાત સરકાર  
જાહેર બાંધકામ વિભાગ  
પરિપત્ર ક્રમાંક બીડીજી/૩૨૭૭/(૧૬૫૭)સ  
સચિવાલય, ગાંધીનગર.  
તા. ૨૬/૪/૧૯૭૮

**પરિપત્ર:-**

જાહેર બાંધકામ વિભાગ મારફત થતાં રસ્તા, પુલો તથા મકાનોના બાંધકામની વિગતો તથા સ્પેશીફિકેશનની માહિતી જાહેર જનતાને જે તે કામના સ્થળ ઉપર આ માટે મળી શકે તેથી જાહેર જનતા તે અંગે યોગ્ય સુચનો કરી શકે. તે માટે કામ સાઈટ ઉપર સરળ ભાષામાં બોર્ડ મુકવા અંગેની બાબત સરકારશ્રીની વિચારણામાં હતી. સરકારે આ અંગે યોગ્ય વિચારણા કરી ઠરાવેલ છે કે આ વિભાગ તરફથી કરવામાં આવતાં રસ્તા, પેલો તથા મકાનોના કામો માટેની નીચે જણાવ્યા મુજબની વિગતો દર્શાવતા બોર્ડ કામના સ્થળ ઉપર જાહેર જનતાની જાણ માટે મુકવા :-

**જાહેર વિજ્ઞપ્તિ**

આ ..... રસ્તાનું / પુલનું મકાનનું કામ ગુજરાત રાજ્યના જાહેર  
બાંધકામ વિભાગ હેઠળના ..... વિભાગ હેઠળ .....  
..... પેટાવિભાગ હસ્તક ચાલે છે.

આ કામના સામાન્ય સ્પેશીફિકેશન નીચે પ્રમાણે છે.

૧. રસ્તા અંગેના સ્પેશીફિકેશન :-

ઓવરસાઈઝ મેટલનું ..... સે.મી. દર્શાવેલ જાડો થર .....

૨. મેટલ ..... સે.મી. દર્શાવેલ જાડો થર.

૩. પેટીનું નામ ..... સે.મી.નું ભરવામાં આવે છે.

(૨) પુલનું કામ :-

૧. પુલના ..... ગાળા દરેક ..... મીટર લંબાઈનો

૨. પીયર કેપનું કોફીટ ૧:૨:૪ ના પ્રમાણમાં.

૩. સ્લેબનું કોફીટ ૧:૨:૪ હાઈગ્રેડ કે વીલીટી કન્ટ્રોલ ૧૫૦ કે ૨૦૦ એમએમ.

૪. પુલના પાયાનો કોફીટ ૧:૩:૬ ના પ્રમાણમાં થાંભલા અને એબટમેન્ટનું કોફીટન ૧:૩:૬ ના પ્રમાણમાં.

(૩) મકાનો :-

૧. પાયાનું ક્રીકીટ પત્થરનું ૧:૩:૬ નું

૨. ઈટોનું ચણતર અને ૧ અને ૬નું પ્રમાણ

૩. ભોંયતળીયુ ૧:૨:૩ નું ચુનાનું ક્રીકીટ કે ૧:૪:૭ સીમેન્ટનો ક્રીકીટ ઉપર ૧ ઈંચ ..... સાઈઝની મોઝેક ટાઈલ્સ.

૪. બારી બારણા સાગી લાકડાના.

૫. આર.સી.સી.કામ ૧:૨:૪ કે ૧૫૦ એમ.કે. ૨૦૦૦ એમ.નું .....

આ કામની વિગતે સ્પેશીફિકેશન નાયબ ઈજનેરશ્રી ..... પેટા વિભાગની કચેરીએ ઓફીસના સમય દરમ્યાન કોઈપણ સમયે જોઈ શકાશે.

તો માહિતી માટે તે અધિકારીનો સંપર્ક સાંધવો.

આ કામની માહિકી જાહેર જનતાની છે અને કામમાં જોઈ ક્ષતિ કે અનિયમિતતા જણાય તો તે બાબતમાં જાહેર બાંધકામ વિભાગના અધિક્ષક ઈજનેરશ્રી ..... જેની કચેરી ..... સ્થળે છે તેમનું ધ્યાન કરવા વિનંતી છે.

કાર્યપાલક ઈજનેર  
માર્ગ અને મકાન વિભાગ

રસ્તા, પુલો તથા મકાનોના બાંધકામની વિગતો તથા  
સ્પેશીફિકેશન અંગેના કામના સ્થળ પર બોર્ડ મુકવા બાબત.

ગુજરાત સરકાર  
માર્ગ અને મકાન વિભાગ  
ઠરાવ ક્રમાંક ટી.એન.સી/૧૦૯૨/૨૧/સ  
સચિવાલય, ગાંધીનગર.  
તા. ૧૮/૧૧/૧૯૯૧

સંદર્ભ: સરકારશ્રીની સરખા ક્રમાંકની તા. ૨૦/૧૨/૯૦ નો ઠરાવ.

આમુખ: રસ્તા, પુલો તથા મકાનોના બાંધકામની વિગતો તથા સ્પેશીફિકેશન અંગેના કામના સ્થળ પર બોર્ડ મુકવા અંગેની બાબત  
સરકારશ્રીની વિચારણા હેઠળ હતી.

**ઠ રા વ :-**

પુખ્ત વિચારણાને અંતે આથી ઠરાવવામાં આવે છે કે, રસ્તા, પુલો મકાનો વર્કઓર્ડર મળ્યા પછી તુર્તજ કામના સ્થળે  
કરવાના કામના સ્પેશીફિકેશન અંગેનું બોર્ડ કોન્ટ્રાક્ટરે પોતાના ખર્ચે મુકવાના રહેશે.

ઉપરોક્ત શરત ટેન્ડરના ભાગ તરીકે ગણવાની રહેશે અને ટેન્ડરમાં તેનો સમાવેશ કરવાનો રહેશે.

આ હુકમોનો અમલ હુકમો રવાના થયાના તારીખથી કરવાનો રહેશે.

આ હુકમો આ વિભાગના સરખા ક્રમાંકની ફાઈલ પર નાણાં સલાહકારશ્રીની તા. ૧૧/૯/૯૧ ના મળેલ સંમતિથી બહાર  
પાડવામાં આવેલ છે. આ હુકમો માર્ગ અને મકાન વિભાગના બધા જ કામોને લાયુ પડશે.

ગુજરાતના રાજ્યપાલશ્રીના હુકમથી અને તેમના નામે,

(એ. જે. દોશી)  
નાયબ સચિવ  
માર્ગ અને મકાન વિભાગ

રસ્તા પુલો તથા મકાનો બાંધકામની વિગતો તથા સ્પેશીફિકેશન અંગેના કામના સ્થળ પર બોર્ડ મુકવા બાબત.

ગુજરાત સરકાર  
માર્ગ અને મકાન વિભાગ  
ઠરાવ ક્રમાંક ટીએનસી/૧૦૮૦/૨૪/સ  
સચિવાલય, ગાંધીનગર.  
તા. ૨૭/૧૧/૧૯૯૦

સંદર્ભ: જા.બાં.વિ.ના પરિપત્ર ક્રમાંક બીકે/૩૨૭૭/(૧૬૫)ન, તા. ૨૬/૪/૭૮

**ઠ રા વ :-**

રસ્તા, પુલો તથા મકાનોના બાંધકામની વિગતો તથા સ્પેશીફિકેશન અંગેના કામના સ્થળ ઉપર બોર્ડ મુકવા અંગેની સંદર્ભમાં દર્શાવેલ પરિપત્રથી જરૂરી સુચનાઓ આપવામાં આવેલ છે. આવા કામની વિગત દર્શાવતા બોર્ડ મુકવા અંગેનો ખર્ચ વિભાગ તરફથી કરવામાં આવતો હતો. કામ પુર્ણ થયા બાદ આવા બોર્ડ બીન જરૂરી પડી રહેતા હતા. આવો ખર્ચ નિવારવાની બાબત સરકારશ્રીની વિચારણામાં હતી. પુર્નવિચારણા અંગે આથી ઠરાવવામાં આવે છે કે જ્યારે રસ્તા / પુલ / મકાનનું કામ હાથ ધરવાનું નક્કી કરવામાં આવે ત્યારે આવું બોર્ડ કામ રાખનાર ઠેકેદારે તેમના ખર્ચે મુકવાનું રહેશે. કામ ચાલુ કરવાનો હુકમ આપવામાં આવે તે પહેલા આ બાબતની જરૂરી સંમતિ સંબંધીત ઈજારદાર પાસેથી લેખિતમાં મેળવી લેવી. તેમજ કોન્ટ્રાક્ટ ધ્વારા આવું બોર્ડ મુકવામાં આવે તે અંગે પુરતી કાળજી રાખવી.

આ હુકમો આ વિભાગની સરખા ક્રમાંકની ફાઈલ ઉપર નાણાંકીય સલાહકારશ્રીની તા. ૧૫/૨/૯૧ ની નોંધથી મળેલ સંમતિથી બહાર પાડવામાં આવેલ છે.

ગુજરાતના રાજ્યપાલશ્રીના હુકમથી અને તેમના નામે,

(પ્ર. ર. ચોકસી)  
ખાસ ફરજ પરના અધિકારી  
માર્ગ અને મકાન વિભાગ



ક્રમાંક : ૫૨૪-૬૧૦૪-૨૨૨ રેઈટ-ડીટીપી-૩૯૭૧-ન,

ગુજરાત સરકાર  
માર્ગે અને મકાન વિભાગ,  
બ્લોક નં. ૧૪/૨, સરદારભવન,  
સચિવાલય, ગાંધીનગર  
તા. ૨૯-૦૭-૨૦૦૪

પ્રતિ,  
અધિક્ષક ઈજનેરશ્રી ( સર્વે ),  
રાજ્ય વિભાગ,

વિષય :- ટેન્ડરમાં સ્ટાર રેઈટ તથા ડી.ટી.પી. મંજૂરીના માસ અને વર્ષે દર્શાવવા બાબત.

સંદર્ભ :- ઠરાવ ક્રમાંક ટીએનસી - ૧૦૮૯/૪-સી, તા. ૩૧-૦૮-૧૯૯૧.

જે ટેન્ડરમાં સીમેન્ટ / સ્ટીલ ઈજારદારે ખરીદવાનો હોય અને તેઓને આ માલસામાનના ભાવો તથા ટેન્ડરમાં દર્શાવેલ સ્ટાર રેઈટના ભાવોનો તફાવત સરભર કરી આપવાનો હોય તેવા ટેન્ડરમાં આ માલસામાનના સ્ટાર રેઈટની જોગવાઈ નીચે મુજબ કરવાની ટેન્ડરના કલોઝ પલ A માં જોગવાઈ છે.

૧. જે માસ તથા વર્ષમાં ડી.ટી.પી. મંજૂર થયા હોય તે માસ અને વર્ષે કોરા ટેન્ડર ઈસ્યુ કરતી વખતે તેમાં દર્શાવવાના રહેશે.
૨. સીમેન્ટ માટેના ભાવો જે માસમાં ડી.ટી.પી. માં મંજૂર થયું હોય તે માસના અધિકત વિક્રેતા પાસેથી મેળવી કોરા ટેન્ડર ઈસ્યુ કરતી વખતે તેમાં દર્શાવવાના રહેશે.
૩. સ્ટીલ તથા એચ.વાય.એસ.ડી.બાર માટે સેઈલ કંપની માંથી જે માસમાં ડી.ટી.પી. મંજૂર થયું હોય તે માસનો ભાવ મેળવી કોરા ટેન્ડર ઈસ્યુ કરતી વખતે તેમાં દર્શાવવાનો રહેશે.
- ૨/- એવું જણાય છે કે આ જોગવાઈનો યુક્ત પછે અમલ થતો નથી અને સ્ટાર રેઈટમાં વિવિધ વિભાગો ધ્વારા એક સુત્રતા જળવાતી નથી.
- ૩/- આથી સર્વેને આજ્ઞાનુસાર સુચના આપવામાં આવે છે કે કોરા ટેન્ડર પેપર્સ ઈસ્યુ કરતી વખતે આ જોગવાઈ મુજબના ભાવો અને ડી.ટી.પી. મંજૂર થયાનું માસ, વર્ષે અવશ્ય દર્શાવવા ટેન્ડરો મંજૂર કરવા દરખાસ્ત કરવામાં આવે ત્યારે આ દરખાસ્તમાં, દર્શાવેલ સ્ટાર રેઈટ અંગેના આધાર / પુરાવા રજૂ કરવા અને આ જોગવાઈ મુજબ જ ટેન્ડર પેપર્સમાં ભાવો દર્શાવેલ છે તે મતલબનું કા.ઈ.શ્રી.નું પ્રમાણપત્ર પણ રજૂ કરવું. વધુમાં આ સ્ટાર રેઈટ અને અંદાજી ભાવોના, ભાવ તફાવતને કારણે ટેન્ડરની અંદાજી રકમ સંબંધે ઈચા / નીચાની પરિસ્થિતિ પણ ટેન્ડર મંજૂરીની દરખાસ્તમાં અવશ્ય કરવી.
- ૪/- આ સુચનાઓનો યુક્તપછે અમલ કરવા વિનંતી છે અને આ અંગેની યુક્તની ગંભીર નોંધ લેવામાં આવશે તેની નોંધ લેવા વિનંતી છે.

( ચં.મ.ભટ્ટ )  
ઉપસચિવ (મકાનો)  
માર્ગે અને મકાન વિભાગ.

નકલ રવાના :  
સર્વે કાર્યપાલક ઈજનેરશ્રી,  
રાજ્ય વિભાગ,



**રાજ્ય સરકારના બાંધકામ માટે વપરાતા ગૌણ  
ખનીજની રોયલ્ટી ભરવા બાબત.**

ગુજરાત સરકાર  
ઉદ્યોગ અને ખાણ વિભાગ.  
ઠરાવ ક્રમાંક : એમએમઆર/૧૧૨૦૦૦/૨૦૧૩/છ  
સચિવાલય, ગાંધીનગર  
તારીખ :- ૧-૯-૨૦૦૪

**વંચાણે લીધા :-**

- (૧) ઉદ્યોગ ખાણ અને ઉર્જા વિભાગનો ઠરાવ ક્રમાંક : એમસીઆર- ૨૧૬૮-૭૩૮૦-છ તા. ૧૨/૧૨/૧૯૬૯
- (૨) ઉદ્યોગ ખાણ અને ઉર્જા વિભાગનો ઠરાવ ક્રમાંક : એમસીઆર- ૨૧૬૮-૮-૬૬૮૫-છ તા. ૧/૧/૧૯૮૭
- (૩) ઉદ્યોગ ખાણ અને ઉર્જા વિભાગનો ઠરાવ ક્રમાંક : એમસીઆર- ૨૧૮૮-(૮)૬૫-છ તા. ૨૫/૧/૧૯૯૧
- (૪) ઉદ્યોગ અને ખાણ વિભાગનો ઠરાવ ક્રમાંક : એમસીઆર-૧૦૯૭-૨૮૫૬-છ, તા. ૬/૧૧/૧૯૯૭
- (૫) માન. મુખ્યમંત્રીશ્રીના અધ્યક્ષપણા હેઠળ યોજાયેલ એમ્પ્રાવર્ડ કમીટીની તા. ૧૮/૬/૨૦૦૪ ની બેઠકની કાર્યવાહી નોંધ.

**ઠરાવ :-**

ઉદ્યોગ, ખાણ અને ઉર્જા વિભાગના સંદર્ભ - (૩) હેઠળના ઠરાવથી એવી જોગવાઈ કરવામાં આવેલ કે રાજ્ય સરકારના , પંચાયતોના અને સરદાર સરોવર નમોદા નિગમના બાંધવામાં આવતાં રસ્તાઓના કે સિંચાઈ વગેરેના કામો માટે જ્યારે સાદી માટી ( ઓર્ડીનરી ક્લે-અર્થ ) અને ( સોફ્ટ ) મુરમ વાપરવામાં આવે ત્યારે ગુજરાત ગૌણ ખનિજ નિયમ , ૧૯૬૬ મુજબ રોયલ્ટી લેવાના નિયમો લાગુ પડશે નહીં. એટલે કે આ કામો માટે કોન્ટ્રાક્ટરો પાસે સાદી માટી ( ઓર્ડીનરી ક્લે- અર્થ ) અને ( સોફ્ટ ) મુરમ માટે રોયલ્ટી લેવાથી થશે નહીં તથા સંદર્ભ- ( ૪ ) હેઠળના વિભાગના તા. ૬/૧૧/૯૭ ના ઠરાવથી ગુજરાત વિદ્યુતબોર્ડ દ્વારા હાથ ધરવામાં આવતાં કામો માટે પણ ઉપર મુજબ રોયલ્ટી મુક્તિનો લાભ આપવામાં આવેલ.

ઉપરોક્ત જોગવાઈના કારણે રાજ્યમાં ગેરકાયદેસર રીતે આ ખનીજોનો વપરાશ થતો હોવાનું જણાયેલ છે. જેના પરિણામે રાજ્ય સરકારે રોયલ્ટીની આવક ગુમાવવી પડે છે માટે ઉપરોક્ત હુકમોની જોગવાઈની સમીક્ષા કરી તે દૂર કરવાની બાબત સરકારશ્રીની વિચારણા હેઠળ હતી. તા. ૧૮/૬/૨૦૦૪ ના રોજ માન. મુખ્યમંત્રીશ્રીના અધ્યક્ષપણા હેઠળ

યોજાયેલ એમ્પ્રાવર્ડ કમીટીની બેઠકમાં નક્કી થયા મુજબ સંદર્ભ-૩ તથા સંદર્ભ-૪ હેઠળના વિભાગના તા. ૨૫/૧/૯૧ તથા તા. ૬/૧૧/૯૭ ના ઠરાવો આથી રદ કરવામાં આવે છે.

ગુજરાતના રાજ્યપાલશ્રીના હુકમથી અને તેમના નામે.

( આર. બી. વ્યાસ )  
નાય. બ સચિવ  
ઉદ્યોગ અને ખાણ વિભાગ

ગુજરાત સરકાર  
માર્ગ અને મકાન વિભાગ  
પરિપત્ર ક્રમાંક : ટીએનસી-૧૦-૨૦૦૨-(૧૪)-સ,  
સચિવાલય, ગાંધીનગર  
તારીખ :- ૨૭-૪-૨૦૦૫

વિષય :- રાજ્ય સરકારના બાંધકામ માટે વપરાતા ગૌણ ખનિજની રોયલ્ટી ભરવા બાબત.  
સંદર્ભ :- ઉદ્યોગ અને ખાણ વિભાગનો ઠરાવ ક્રમાંક : એમએમઆર-૧૧૨૦૦૦-૨૦૧૩-૧૭, તા.૧-૯-૨૦૦૪

**પરિપત્ર :-**

ઉદ્યોગ, ખાણ અને ઉજ્જૉ વિભાગના તા.૨૫-૧-૯૧ ના ઠરાવ ક્રમાંક : એમસીઆર-૨૧૮૮-(૮) -૬૫-૧૭ અન્વયે રાજ્ય સરકારના, પંચાયતના અને સરદાર સરોવર નમૅદા નિગમના બાંધવામાં આવતાં રસ્તાઓના કે સિંચાઈ વગેરેના કામો માટે જ્યારે સાદી માટી ( ઓડીનરી કલે-અર્થ ) અને (સોફ્ટ) મુરમ વાપરવામાં આવે ત્યારે ગુજરાત ગૌણ ખનિજ નિયમ-૧૯૬૬ મુજબ રોયલ્ટી લેવાનો નિયમ લાગુ પડશે નહીં. એટલે કે આ કામો માટે કોન્ટ્રાક્ટરો પાસે સાદી માટી ( ઓડીનરી કલે -અર્થ ) અને (સોફ્ટ)મુરમ માટે રોયલ્ટી લેવાની થશે નહીં તેવી જોગવાઈ કરવામાં આવેલ. હવે ઉપર સંદર્ભમાં દર્શાવેલ ઉદ્યોગ અને ખાણ વિભાગના તા.૧-૯-૨૦૦૪ ના ઠરાવથી તા. ૨૫-૧-૯૧ ના ઠરાવ રદ કરવામાં આવેલ છે.

આથી હવે બી-૧ ટેન્ડર ફોર્મ માં ખંડ - ૩૬ અને બી-૨ ટેન્ડર ફોર્મમાં ખંડ-૩૫ માં નીચે મુજબ સુધારો કરવામાં આવે છે.

રાજ્ય સરકારના બાંધકામ માટે વપરાતા ગૌણ ખનિજની રોયલ્ટી બાબત.

(૧) તા.૧-૩-૯૧ ના ઠરાવ મુજબ ..... મુરમ સિવાયના

અન્ય સુધીના શબ્દો રદ કરી ફક્ત નીચે મુજબ જોગવાઈ અમલમાં રહેશે.

ગૌણ ખનિજ બાબતમાં રા.ગૌ.ખ.નિ.૧૯૬૬ અને તેના અનુસંધાનમાં વખતોવખત બહાર પાડવામાં આવેલ ઠરાવો લાગુ પડશે, અને તે મુજબ લીઝ કે પરમીટ લેવાનું અને રોયલ્ટી ભરવાની રહેશે.( ઉદ્યોગ અને ખાણ વિભાગ ઠરાવ ક્રમાંક એમએમઆર-૧૧-૨૦૦૦-૨૦૧૩-૧૭ તા.૧-૯-૦૪ )

( અશોક પંડ્યા )  
ઉપસચિવશ્રી,  
માર્ગ અને મકાન વિભાગ

પ્રતિ,

સર્વે અધિક્ષક ઈજનેરશ્રી,

( મા.મ.વર્તુળો/ પંચાયત (મા.મ.)વર્તુળો/ એક્સપ્રેસ વે વર્તુળ / રાજ્ય માર્ગ યોજના વર્તુળ /  
રાષ્ટ્રીય ધોરી માર્ગ વર્તુળો / પાટનગર યોજના વર્તુળ સહિત )

સર્વે કાર્યપાલક ઈજનેરશ્રીઓ ( ઉપરોક્ત વર્તુળો હેઠળના તમામ વિભાગો સહિત )

નકલ રવાના :-

- ઉદ્યોગ અને ખાણ વિભાગ, સચિવાલય, ગાંધીનગર
- નમૅદા , જળસંપત્તિ , પાણી પુરવઠા અને કલ્પસર વિભાગ,સચિવાલય, ગાંધીનગર
- નિયામકશ્રી, ઈજનેરી સંશોધન સંસ્થા, વડોદરા
- નિયામકશ્રી, એન્જીનીયરીંગ સ્ટાફ કોલેજ, ગાંધીનગર
- મેનેજીંગ ડીરેક્ટરશ્રી, ગુજરાત રાજ્ય બાંધકામ નિગમ લી. ગાંધીનગર
- મેનેજીંગ ડીરેક્ટરશ્રી, ગુજરાત રાજ્ય માર્ગ વિકાસ નિગમ લી, ગાંધીનગર
- સર્વે તાંત્રિક અધિકારીશ્રીઓ ( ના.કા.ઈ.સહિત ) મા.મ.વિ.વિભાગ,સચિવાલય,
- સર્વે પ્રોજેક્ટ શાખાઓ, મા.મ.વિ.સચિવાલય,
- સીલેક્ટ કાઈલ.

મશીન ક્રશ્ડ સ્ટોન એગ્રીગેટના ફલેકીનેશ  
અને ઈલોન્ગેશન ઈન્ડેક્સના સંયુક્ત ધોરણો  
અપનાવવા બાબત.

ગુજરાત સરકાર  
માર્ગ અને મકાન વિભાગ  
પરિપત્ર ક્રમાંક - એસઓઆર. - ૧૦૨૦૦૬ / ૧૦૪ / સ. ૧  
સચિવાલય, ગાંધીનગર.  
તા. ૨૧/૧/૨૦૦૭

**પ્રસ્તાવના :-**

'મશીન ક્રશ્ડ સ્ટોન એગ્રીગેટ' એ બાંધકામમાં વપરાતું મુખ્ય મટીરીયલ્સ છે. આ 'મટીરીયલ્સ' માટેના ગુણવત્તાના વિવિધ ધોરણો પૈકીનો એક 'ફલેકીનેશ અને ઈલોન્ગેશન ઈન્ડેક્સ (સંયુક્ત)' છે જે મીનીસ્ટ્રી ઓફ રોડ ટ્રાન્સપોર્ટ એન્ડ હાઈવેઝ (MORT & H) દ્વારા પ્રકાશીત સ્પેશીફિકેશન ફોર રોડ એન્ડ બ્રીજ વર્કની ચોથી આવૃત્તિમાં દર્શાવ્યા અનુસાર ૩૦ % થી વધુ ન હોવો જોઈએ. જ્યારે અગાઉ મીનીસ્ટ્રી ઓફ સરકેઈસ ટ્રાન્સપોર્ટની બીજી આવૃત્તિમાં ફક્ત ફલેકીનેશ ઈન્ડેક્સનું ધોરણ વધુમાં વધુ ૩૫ % સુધીનું હતું. આમ સંશોધનો / અનુભવ તેમજ અર્થતંત્ર મશીનરીની ઉપલબ્ધીનો વ્યાપ / સરળતા તેમજ આર્થિક પાસાઓને ધ્યાને લઈને ગુણવત્તાનાં ધોરણોમાં પણ નવા સુધારા / વધારા કરવામાં આવે છે. અગાઉના ફલેકીનેશ ઈન્ડેક્સના ધોરણોમાં હવે ઈલોન્ગેશન ઈન્ડેક્સ પણ જોડી સંયુક્ત ધોરણ દાખલ કરવામાં આવેલ છે. પરંતુ હાલ ગુજરાત રાજ્યમાં આવેલ ક્રશર યુનિટો પૈકીના મોટા ભાગના યુનિટો પરંપરાગત પધ્ધતિથી કાર્યરત છે. તેમાંથી નવા સંયુક્ત ધોરણો પરિપુર્ણ કરે તેવો ઉત્પાદિત માલ મળી શકતો નથી. જે એક વ્યવહારીક મુશ્કેલી છે. પરંપરાગત પધ્ધતિનાં ક્રશરમાં આ પ્રકારની મુશ્કેલીઓ આવે છે. તે બાબતનો ઉલ્લેખ ટેકનીકલ જર્નલમાં પ્રસિધ્ધ થતા ટેકનીકલ પેપર્સમાં પણ થયેલ છે. આથી સંયુક્ત ધોરણો મેળવવા હાલના ક્રશર યુનિટોમાં સારા એવા પ્રમાણમાં સુધારા વધારા કરવા આવશ્યક બને તેમ છે. જેમાં વધારાનું નાણાંકીય રોકાણ પણ કરવું પડે તેમજ સમય પણ વ્યતિત થાય આથી ફલેકીનેશ તેમજ ઈલોન્ગેશન ઈન્ડેક્સના સંયુક્ત ધોરણોનો અમલ કરવા (ઈજારદારોને) પૂરતો સમય આપવો પણ જરૂરી છે. તે ધ્યાને લઈ નીચે મુજબની સૂચનાઓ આપવામાં આવે છે.

મીનીસ્ટ્રી ઓફ રોડ ટ્રાન્સપોર્ટ એન્ડ હાઈવેઝ દ્વારા સ્પેશીફિકેશન ફોર રોડ એન્ડ બ્રીજ વર્કની સને ૨૦૦૧ ની ચોથી આવૃત્તિ અનુસાર મશીન ક્રશ્ડ સ્ટોન એગ્રીગેટ માટે ફલેકીનેશ તેમજ ઈલોન્ગેશન સંયુક્ત ઈન્ડેક્સની મહત્તમ ૩૦ % ની મર્યાદાનું ધોરણ અપનાવવાનું નક્કી કરવામાં આવેલ છે.

માર્ગ અને મકાન વિભાગ હસ્તક ચાલતા કામોમાં પ્રવર્તમાન સ્પેશીફિકેશન પ્રમાણે ફલેકીનેશ અને ઈલોન્ગેશનના સંયુક્ત ઈન્ડેક્સની મહત્તમ મર્યાદા ૩૦ % રાખવામાં આવે છે.

ગુજરાત રાજ્યમાં મોટા ભાગના ક્રશીંગ યુનિટો ખાનગી માલિકીના છે અને તેમાં જરૂરી યાંત્રિક ફેરફારો કરવામાં આવે તો સંયુક્ત ઈન્ડેક્સના ધારાધોરણો જળવાઈ રહે તેવાં માલ મળી શકે.



ગુજરાત રાજ્યમાં ચાલતા ખાનગી ક્રશીંગ મશીનોમાં જરૂરી યાંત્રિક સુધારા વધારા તા.૩૦/૯/૦૭ સુધીમાં કરવામાં આવે તો જ તા.૧/૧૦/૦૭ પછીથી માર્ગ અને મકાન વિભાગના રસ્તાઓમાં વપરાતા એગ્રીગેટની ગુણવત્તા ધારાધોરણ મુજબની મળી રહે. આથી નીચે મુજબની સુચનાઓ આપવામાં આવે છે.

- (અ) માર્ગ અને મકાન વિભાગમાં ચાલતા કામોના ઈજારદારોએ જે તે ક્રશીંગ યુનિટોમાં જરૂરી યાંત્રિક સુધારા વધારા થઈ ગયેલ છે અને ધારા ધોરણ મુજબની ગુણવત્તાનાં એગ્રીગેટ મળી રહે છે તેવું પ્રમાણપત્ર અધિક્ષક ઈજનેરશ્રી (યાંત્રિક) અમદાવાદ મા.મ. વર્તુળ, અમદાવાદનું હોય તેની પાસેથી જ માલસમાન ખરીદ કરવાનો રહેશે. આ પ્રમાણિત થયેલ ક્રશીંગ યુનિટ સિવાયના કોઈપણ ક્રશર પાસેથી માલસમાન સપ્લાય ન થાય તેની કાળજી લેવાની રહેશે. અધિક્ષક ઈજનેરશ્રી (યાંત્રિક) દ્વારા સર્ટીફાઈડ ન થયેલ ક્રશીંગ યુનિટ પાસેથી આવેલ ધારાધોરણ વગરનો માલસમાન આઉટરાઈટ રીજેક્ટ કરવામાં આવશે.
- (બ) માર્ગ અને મકાન વિભાગના એસ.ઓ.આર. માં તથા અંદાજોમાં એગ્રીગેટના ભાવમાં જરૂરી સુધારા વધારા કરીને તા.૧/૧૦/૦૭ થી અમલમાં લાવવાના રહેશે.
- (ક) દરેક વિભાગીય કચેરીઓએ તેઓના તાબામાં જે જે ઈજારદારોની નોંધણી થયેલ છે તેઓને સદરહુ સુચનાઓ અમલ કરવા માટે લેખિત જાણ કરવાની રહેશે તથા ખાનગી ક્રશીંગ યુનિટોને પણ આની લેખિત જાણ કરવાની રહેશે. સદરહુ સુચનાના અમલ માટે ખાનગી ક્રશર યુનિટો તેમજ ઈજારદારો સાથે દરેક વિભાગીય કચેરીએ એક સંયુક્ત બેઠક કરીને સમજ આપવાની રહેશે જેથી તા.૧/૧૦/૦૭ પછી માર્ગ અને મકાન વિભાગ હસ્તક ચાલતા કોઈપણ કામોમાં ધારા ધોરણ મુજબની ગુણવત્તા સિવાયનો માલસમાન વાપરવામાં ન આવે તેની તકેદારી રાખવાની રહેશે.

ઉપરોક્ત સુચનાઓનો અમલ યુસ્તપણે કરવાનો રહેશે.

(એસ.એ.ભટ્ટ)  
ઉપસચિવ મુ.મ.  
માર્ગ અને મકાન વિભાગ.

મશીન ક્રશ્ડ સ્ટોન એગ્રીગેટના ફલેક્રીનેશ  
અને ઈલોન્ગેશન ઈન્ડેક્સના સંયુક્ત ધોરણો  
અપનાવવા બાબત.

ગુજરાત સરકાર  
માર્ગ અને મકાન વિભાગ  
પરિપત્ર ક્રમાંક - આરજીએન - ૧૦૨૦૦૬ - ૧૦૪ - સ.૧,  
સચિવાલય, ગાંધીનગર.  
તા. ૧૭/૧૦/૨૦૦૭

સંદર્ભ :- સરખા ક્રમાંકના પરિપત્ર તા.૨૫/૧/૨૦૦૭.

**પ્રસ્તાવના :-**

ગુજરાત સરકારશ્રીના માર્ગ અને મકાન વિભાગ દ્વારા સંદર્ભીત પરિપત્ર ક્રમાંક : એસ.ઓ.આર. ૧૦૨૦૦૬ / ૧૦૪ / સ.૧, તા.૨૫/૧/૨૦૦૭ થી બાંધકામમાં વપરાતા મશીન ક્રશ્ડ સ્ટોન એગ્રીગેટ માટે ફલેક્રીનેશ તેમજ ઈલોન્ગેશન સંયુક્ત ઈન્ડેક્સની મહત્તમ ૩૦% મર્યાદાનું ધોરણ અપનાવવાનું નક્કી થયેલ હતું. જે માટે ગુજરાત રાજ્યમાં ચાલતા ખાનગી ક્રશીંગ યુનીટોમાં જરૂરી તાંત્રિક સુધારા વધારા તા.૩૦/૯/૨૦૦૭ સુધીમાં કરવા અને તા.૧/૧/૨૦૦૭ પછી થી માર્ગ અને મકાન વિભાગના રસ્તાઓના કામ વપરાતા એગ્રીગેટ ધારા ધોરણ મુજબની ગુણવત્તા વાળો વાપરવામાં આવે તેમ જણાવેલ હતું.

ક્રશર યુનીટોમાં જરૂરી સુધારા વધારા સુચવેલ સમયગાળામાં થઈ શકેલ ન હોવાથી વારંવાર સમય મર્યાદા વધારવા માટેની રજુઆતો થયેલ હતી.

ઉપરોક્ત બાબતે સરકારશ્રી દ્વારા પુખ્ત વિચારણાને અંતે ક્રશીંગ યુનીટોમાં જરૂરી સુધારા વધારા કરવા માટેની અંતિમ તા.૩૦/૯/૨૦૦૭ ને બદલે તા.૩૧/૧૨/૦૮ કરવામાં આવેલ છે.

ઉપરોક્ત સુચનાઓનો અમલ ચુસ્તપણે કરવાનો રહેશે.

(એસ.એ. ભટ્ટ)  
ઉપસચિવશ્રી (મુ.મ.)  
માર્ગ અને મકાન વિભાગ.

નકલ રવાના :-

- સચિવશ્રી (મા.મ) ના . અંગત સચિવશ્રી, મા.મ. વિભાગ, સચિવાલય, ગાંધીનગર.
- સર્વે મુખ્ય ઈજનેરશ્રીઓ અને અ.સ. શ્રીઓ, મા.મ. વિભાગ, સચિવાલય, ગાંધીનગર.
- સર્વે અધિક્ષક ઈજનેરશ્રીઓ
- સર્વે તાંત્રિક અધિકારીશ્રી, મા.મ. વિભાગ, સચિવાલય, ગાંધીનગર.
- ફાઈલ ક્રમાંક :- એસ.ઓ.આર. / ૧૦૨૦૦૬ / (૧૦૪) / સ.૧ માં રાખવા સારૂ.
- સિલેક્ટ ફાઈલ.

Instruction on implementation of  
the building and other Construction  
workers Act 1996  
and building and other Construction  
workers Welfare Cess Act, 1996.

Government of Gujarat  
Labour & Employment Department  
G.R. No. CWA-2004-841-M3  
Sachivalaya, Gandhinagar,  
Dated : 30 January 2006.

Read : Labour & Employment Department, Gandhinagar GR.No.CWA-2004-1831-M(3) Dated : 9-12-2005.

**RESOLUTION**

Building and other construction workers are one of the largest and most vulnerable segments of the unorganized labour. Their work is characterized by by inherent risk to life and limb of the work and also by the casual nature, temporary relationship between employer and employee, uncertain working hours, lack of basic amenities and inadequate welfare facilities.

Government of India has decided to constitute. Welfare boards for such workers in every state and accordingly, the Building and other Construction Workers ( Regulation of Employment & conditions of Service ) Act, 1996 was enacted by parliament and brought into force from 19<sup>th</sup> August, 1996. implementation of the Act. Including cess collection has already commenced in Karnataka, tamil nadu and dilhi. Under the side Act. Government of Gujarat has constituted a board under section 18. The stat Government has been powers to make rules for carrying out the provisions of this Act.

Accordingly, Government of Gujarat made Gujarat Building and other Construction Workers (Regulation of Employment and condition of Service) Rules, 2003 and published these Rules vide Notification No.GHR-2003-111-CWA-2000-1869-M(3), dated 18<sup>th</sup> August, 2003. Government of Gujarat has also constituted the Gujarat Building and other Construction workers Welfare Board vide Notification No. GHR/2004/163/CWA/2004/3743-M(3), dated 18<sup>th</sup> December, 2004. Secretary ( Labour ) has been appointed as Chairman.

Government of India has also enacted the Building and other construction workers welfare cess Act. ( hereinafter called as cess Act ) and brought it in force from 19<sup>th</sup> August, 1996. the cess Act provided for the levy and collection of cess on the cost of construction incurred by the employers, for increasing the resources of the welfare board. Section 3 of the Cess Act provides that cess shall be levied and collected at a rate not less than 1 % of the cost of construction incurred by an employer. Rule 5 of the Building and other construction worker welfare cess Rules, 1998 reads as fallows :-

- (1) The proceeds of the cess collected under Rule 4 shall be transferred by such Government office, public sector Undertaking, local authority. Or cess collector, to the Board along with the from of Challan prescribed (and in the head of account of the Board) under the accounting provedures of the state, by whatever name they are known.



(2) Such Government office or public sector undertaking may deduct from the cess collected or claim from the Board, as the case may be, actual collection expenses not exceeding one per cent of the total amount collected.

(3) The amount collected shall be transferred to the board within thirty days of its collection.

Moreover, under Rule 6, every employer, within thirty days of commencement of his work of payment of cess, as the case may be, has to furnish information in form 1 to the assessing Officer. Under Rule 12, the Assessing Officer, in cases where the employer has pay the cess or has paid less cess, can impose it penalty upto the amount of cess payable.

By Government of Gujarat Notification No. GHR/2005/04/CWA/2004/841/M3, dated 3<sup>rd</sup> January, 2005, all heads of the department of the Government of Gujarat, all Executive heads of public sector undertaking and all Executive head of local Authorities ( except Gram panchayat and Nagar Panchayat) are declared as cess Collectors and Assessing Officers.

The Building and other Construction workers Welfare board has passed the necessary resolution to collect the cess with effect from 18<sup>th</sup> December, 2004.

According, the cess is payable by Government offices, public sector undertaking, local Authority or cess collector to the board in challan proscribed, in the following head / sub head :

Major Head :- 0230 – Labour and Employment

Minor Head :- 106-Fees under Contract Labour ( Regulation and abolition) Rules

Sub Head :- (04)-Income from cess levied under Gujarat Building & other Construction worker's Welfare cess Act, 1996.

Approval of the Finance Department, Government of Gujarat has been taken for meeting the expenditure to be included for the various welfare activities by the Gujarat Building & other construction workers welfare board and the opening of the accounting Head / Sub –Head in file No 2004-1831-M3 on 1<sup>st</sup> December, 2005 ( Copy of Resolution dated 9/12/2005 is enclosed)

All Government, public sector undertaking and local authorities are instruction to pay the above cess as per the Act. All Department Public sector Undertaking and local authorities are also advised to incorporate the 1 % cess in their estimates for all new works.

By order and in the name of Government of Gujarat.

**(Vinod Babbar)**  
**Principal Secretary Government**  
**Labour & Employment Department**

:: પરિપત્ર ::

“Demand Draft for E.M.D. & Tender fee shall be submitted in electronic format only through online (by Scanning) while uploading the bid. This submission shall mean that EMD & tender fee are received electronically. However for the purpose of realization of D.D. bidder shall send the D.D. in original through R.P.A.D. so as to reach to Executive Engineer, R&B Division, Porbandar within 7 days from the last date of uploading. Penaltrative action for not submitting D.D. in original to E.E. by bidder shall be initiated. D.D. for exemption Certificate is not necessary. However Exemption Certificate shall have to be submitted electronically through online.

Any documents in supporting of tender bid shall be submitted in electronic format only through online (by scanning etc.) & hard copy will not be accepted separately.”

“ટેન્ડર માટે બાનાની રકમ (ઈ.એમ.ડી.) તથા ટેન્ડર ફીના ડીમાન્ડ ડ્રાફ્ટ ઓન લાઈન સ્કેન કરી ઈલેક્ટ્રોનિક ફોરમેટમાં ટેન્ડર અપલોડ કરવાના રહેશે. આ પ્રકારે રજૂ થયેલ વિગતે બાનાની રકમ અને ટેન્ડર મળ.લ ગણવાની રહેશે અને તદઅનુસાર ટેન્ડર ખોલવામાં આવશે તે અનુસાર ઈલેક્ટ્રોનિક ફોરમેટમાં રજીસ્ટ્રેશન, બેંક સોલવંશી, બાનાની રકમ અને ટેન્ડર ફી મળેલ હોય તેની જ ઓફર ખોલવામાં આવશે. ખરેખર ચુકવણા માટે ટેન્ડર ભરનારે ડીમાન્ડ ડ્રાફ્ટ અસલમાં રજીસ્ટર્ડ પોસ્ટ એ.ડી. થી કાર્યપાલક ઈજનેરશ્રી, માર્ગ અને મકાન વિભાગ, પોરબંદર ને અપલોડીંગની છેલ્લી તારીખ થી દિવસ-૭ માં મળે તે અનુસાર રજૂ કરવાનો રહેશે. અસલમાં ડીમાન્ડ ડ્રાફ્ટ નહી મોકલનાર સામે શિક્ષાત્મક પગલા શરૂ કરવામાં આવશે. બાના મુક્તિ માટે ડીમાન્ડ ડ્રાફ્ટ જરૂરી બનશે નહિ, પરંતુ બાના મુક્તિ પ્રમાણપત્ર ઈલેક્ટ્રોનિકલી ઓન લાઈન રજૂ કરવાનું રહેશે.”

ટેન્ડર બીડનાં માટે જરૂરી આધાર માટેના કોઈપણ ડોક્યુમેન્ટ ઓન લાઈન ઈલેક્ટ્રોનિક ફોરમેટમાં સ્કેન કરી મોકલવાના રહેશે અને હાડ કોપી અલાયદી રીતે સ્વીકારવામાં આવશે નહિ.

ગુજરાત રાજ્યપાલશ્રીના હુકમથી અને તેમના નામે.

સહી/-  
ઉપસચિવ  
માર્ગ અને મકાન વિભાગ



ઇ-ટેન્ડરીંગમાં ટેન્ડર ફી અને અન્ય  
ડોક્યુમેન્ટસ રજૂ કરવા અંગે.

ગુજરાત સરકાર  
માર્ગ અને મકાન વિભાગ,  
પરિપત્ર ક્રમાંક :- પરચ - ૧૦૨૦૦૮-૫-સ (પાર્ટફાઇલ)  
સચિવાલય, ગાંધીનગર,  
તા. ૨૭-૧૧-૨૦૦૮

વંચાણે લીધા :- તા. ૧૮/૧/૦૮ નો પરિપત્ર ક્રમાંક : પરચ - ૧૦૨૦૦૮-૫-સ

પરિપત્ર :-

માર્ગ અને મકાન વિભાગમાં હાલમાં ટેન્ડરો ઇ-ટેન્ડર પધ્ધતિથી સ્વીકારવામાં આવે છે. તે અન્વયે સમાન ક્રમાંકના તા. ૧૮/૧/૦૮ના પરિપત્રમાં ટેન્ડર ફી અને બાનાની રકમ જે તે કાર્યપાલક ઇજનેરને ખરેખર ચુકવવા માટે દિન-૭માં અસલમાં રજીસ્ટર્ડ પોસ્ટ એ.ડી.થી મોકલવાની તેમજ અસલમાં ડીમાન્ડ ડ્રાફ્ટ નહિ મોકલનાર સામે શિક્ષાત્મક પગલા લેવાની જોગવાઈ હતી.

ઉપરોક્ત પરિપત્રમાં નીચે મુજબ અંશતઃ સુધારો કરી આ શરતનો સમાવેશ ટેન્ડર નોટીસ / ટેન્ડરના મુસદ્દામાં Through R.P.A.D. so as to reach to E.E. Division - Within 7 days from the last date of uploading ને બદલે to S.E. at the time of tender opening or send the same through R.P.A.D. so as to reach to E.E. Division - Within 7 days from the last date of opening." સુધારો કરવામાં આવે છે. તેમજ ખરેખર ટેન્ડર ફી તેમજ બાનાની રકમ નિયત સમયમાં ઇજારદાર ન ભરે તો ઇજારદારની નોંધણી એક વર્ષ માટે એબેન્સમાં રાખવાની કાર્યવાહી કરી ઇ-ટેન્ડરીંગ નો કોડ એક વર્ષ માટે રદ કરાશે.

ગુજરાત રાજ્યપાલશ્રીના હુકમથી અને તેમના નામે.

(આર. કે. ચૌહાણ)  
ખાસ ફરજ પરના અધિકારી  
માર્ગ અને મકાન વિભાગ

ટેન્ડરમાં ભરેલ અસામાન્ય ઉંચા ભાવોના સંદર્ભે કામ પર પડતા ખર્ચ પર નિયંત્રણ રાખવા તથા કામની નાણાકીય પ્રગતિ ભૌતિક પ્રગતિ સાથે સુમેળમાં રહે તે માટે જરૂરી જોગવાઈ કરવા બાબત

ગુજરાત સરકાર  
માર્ગ અને મકાન વિભાગ,  
પરિપત્ર ક્રમાંક :- પરચ - ૧૦૨૦૦૮-(૬૧)-સ  
તા. ૨૭-૧૧-૨૦૦૮

પરિપત્ર :-

ટેન્ડરમાં અસામાન્ય ઉંચા કે નીચા ભાવો ઇજારદારશ્રીઓ દ્વારા ઘણી વાર ભરાતા હોવાનું સરકારશ્રીના ધ્યાન પર આવેલ છે. આવા કિસ્સાઓમાં કામની નાણાકીય પ્રગતિ અને ભૌતિક પ્રગતિનો સુમેળ ન રહેવાની સંભાવના રહેલી છે. આથી કામની ભૌતિક પ્રગતિ પ્રમાણે નાણાકીય પ્રગતિ રહે કે જેથી સરકારશ્રી પર સમય પહેલા અયોગ્ય નાણાકીય બોજ ન પડે તે માટે નીચે મુજબની જોગવાઈ ટેન્ડરમાં કરવાનો નિર્ણય કરવામાં આવેલ છે. આ જોગવાઈ તમામ કામોના આ પરિપત્રની તારીખ પછી મંજૂર થતાં ડી.ટી.પી. માં અચૂક પણ કરવાની રહેશે.

જોગવાઈ :-

જે કોઈ આઈટમનો ભરેલ ભાવ. તે આઈટમના ટેન્ડરમાં મુકેલ અંદાજી ભાવ કરતા ટેન્ડરમાં મુકેલ અંદાજી રકમથી સમગ્ર ટેન્ડર જેટલા ટકા ઉંચુ કે નીચુ મંજૂર થયુ હોય તે ટકાવારીથી ૧૦% થી વધુ ઉંચો રહેતો હોય તેવી આઈટમનું ચકવણું રનીગ બિલ વદતે જે તે આઈટમના અંદાજી ભાવ + / - મંજૂર ટેન્ડરની ટકાવારી + તે આઈટમના અંદાજી ભાવની ૫% ની મર્યાદામાં કરવામાં આવશે. આ રીતે વીથહેલ્ડ રાખેલ રકમ કામ સંતોષકારક રીતે પુર્ણ થયે ફાઈનલ બિલ મંજૂર કરતી વતખે વ્યાજભારણ વગર છુટી કરવામાં આવશે.

ઉદાહરણ :-

ઉક્ત જોગવાઈની સ્પષ્ટ સમજણ માટે આ સાથે આપેલ ઉદાહરણ ધ્યાને લેવું

૧	ટેન્ડરમાં મુકેલ અંદાજી રકમ	:	રૂ. ૧૦૦/-
૨	મંજૂર થયેલ ટેન્ડરની રકમ	:	રૂ. ૧૧૦/-
૩	ટેન્ડરમાં મુકેલ અંદાજી રકમ સામે ખરેખર મંજૂર થયેલ ટેન્ડરની ટકાવારી	:	૧૦%
૪	ટેન્ડરની એક આઈટમનો ટેન્ડરમાં મુકેલ અંદાજી ભાવ	:	રૂ. ૧૦/-
૫	તે આઈટમનો ભરેલ ભાવ	:	રૂ. ૧૪/-
૬	તે આઈટમમાં ભરેલ ઉંચા ભાવની ટકાવારી	:	૪૦%
૭	તે આઈટમ માટે રનીગ બિલ વખતે ચુકવવાપાત્ર ભાવ	:	રૂ. ૧૦/- કો. ૩ પ્રમાણ ૧૦% ઉંચા અંદાજી ભાવના ૫% રૂ. ૧૧.૫૦
૮	ફાઈનલ બિલ વખતે વ્યાજ ભારણ વગર ચુકવવાપાત્ર થતો વીથહેલ્ડ રાખેલ ભાવ.	:	રૂ. ૧૪.૦૦-૧૧.૫૦ રૂ. ૨.૫૦

જો સદર આઈટમના ભાવ રૂ. ૧૨.૦૦ કે તેથી નીચો ભરેલ હોત તો રનીગ બિલમાં ભાવ કપાત આ જોગવાઈ મુજબ કરવાની રહેત નહીં.

(આર. કે. ચૌહાણ)  
ખાસ ફરજ પરના અધિકારી  
માર્ગ અને મકાન વિભાગ

બાંધકામના મટીરીયલ્સ તેમજ કોમ્પોનેન્ટ્સ સેમ્પલની ગુણવત્તા માટે પરીક્ષણ પૈકીના ૮૦% પરીક્ષણ સ્થળ પર તથા ૧૦% પરીક્ષણ સરકાર માન્ય લેબોરેટરી / ગેરી ધ્વારા તથા ૧૦% ગેરી લેબોરેટરીમાં કરાવવા બાબત

ગુજરાત સરકાર  
માર્ગ અને મકાન વિભાગ  
પરિપત્ર ક્રમાંક : ૫૨૪/૧૦૨૦૦૭/૨૮/સ  
સચિવાલય, ગાંધીનગર  
તારીખ : ૩૧/૧૨/૨૦૦૮

### પરિપત્ર

બાંધકામના મટીરીયલ્સ તેમજ કોમ્પોનેન્ટ્સના સેમ્પલની ગુણવત્તા માટેના પરીક્ષણ હાલ ગેરી કે સરકાર માન્ય સંસ્થા (લેબોરેટરી) મારફતે કરવામાં આવે છે. કામોની પ્રગતિની સમીક્ષા દરમ્યાન ક્ષેત્રીય અધિકારીઓ તરફથી જાણવા મળેલ છે કે ઉક્ત હયાત પ્રક્રિયામાં ટેસ્ટીંગના પરિણામો વિલંબથી મળે છે, જેમાં સમય પણ ખૂબ વ્યતિત થાય છે. ઇજારદાર એસોસિએશન તરફથી આવી રજૂઆતો મળે છે, આથી આ મુશ્કેલી ધ્યાને લેતા ઇજારદારશ્રી ધ્વારા જે તે કામ માટે સ્થાપવામાં આવતી લેબોરેટરીમાં સ્થળ પર જ પરીક્ષણ કરવામાં આવે તો વિલંબ નિવારી શકાય તે બાબત વિચારણા હેઠળ હતી, પુખ્ત વિચારણાના અંતે નીચે મુજબની નીતિ હાલના તબક્કે અનુસરવા નક્કી કરવામાં આવ્યું છે.

નીચે જણાવેલ પરીક્ષણોમાં પ્રવર્તમાન પધ્ધતિમાં ફેરફાર કરી ફીક્વન્શી અનુસાર જરૂરી પરીક્ષણો પૈકી ૧૦% સરકાર માન્ય લેબોરેટરી / ગેરી તથા ૧૦% ગેરી લેબોરેટરી અને ૮૦% ફીલ્ડ લેબોરેટરી ધ્વારા કરાવવાના રહેશે. પરંતુ ગેરીમાં નીચેના દરેક પૈકી ઓછામાં ઓછું ૧(એક) પરીક્ષણ ગેરી લેબોરેટરીમાં કરવાનું રહેશે તથા ઓછામાં ઓછું એક પરીક્ષણ ગેરી / સરકાર માન્ય લેબોરેટરીમાં કરાવવાનો રહેશે. જેમાં નીચે દર્શાવેલ પરીક્ષણો સ્થળ પર કરવાના રહે છે.

એ	એગ્રીગેટ	(૧) ગ્રેડેશન (૨) ફલેક્રીનેશ અને ઈલોગેશન વેલ્યુ (૩) ઇમ્પેક્ટ વેલ્યુ (૪) વોટર એબસોર્પશન
બી	માટી	(૧) ફિલ્ડ એફડીડી અને એફએમસી (૨) સીવ એનાલીસીસ
સી	રેતી	(૧) ગ્રેડેશન
ડી	ઇટો	(૧) ડાયમેનશન અને ટોલરન્સ ટેસ્ટ (૨) વોટર એબસોર્પશન
ઇ	કોક્રીટ	(૧) નોન ડીસ્ટ્રીક્ટીવ ટેસ્ટ (એલ્ટ્રા સોનીક ટેસ્ટીંગ પધ્ધતિથી) (૨) સ્લમ્પ ટેસ્ટ (૩) કોમ્પ્રેસીવ સ્ટ્રેન્થ
એફ	બીટયુમીનસ મીક્સ	(૧) ડામરની ટકાવારી
જી	ડ્રાય મીક્ષ મટીરીયલ	(૧) ગ્રેડેશન



શરતો :-

- (૧) ઇજારદારે કામની ગુણવત્તા માટે ધારા ધોરણ પ્રમાણેની અને ઉપર જણાવેલ પરિક્ષણો માટે પ્રમાણિત થયેલ જરૂરી તમામ સાધનો સહિતની ફિલ્ડ ટેસ્ટીંગ લેબોરેટરી સ્વ ખર્ચે કામના સ્થળે યોગ્ય જગ્યા ઉપર સ્થાપવાની રહેશે. રસ્તાના કામ માટે લાગુ પડતા પ્લાન્ટના સ્થળને કામનું સ્થળ ગણી શકાય. પરંતુ કામનું સ્થળ લેબોરેટરીથી દૂર હોય તો ઇજારદારશ્રી ધ્વારા મોબાઇલ લેબોરેટરીની જરૂરી વ્યવસ્થા રાખવાની રહેશે.
- (૨) કાર્યપાલક ઇજનેરશ્રી જ્યારે સ્થળ પર તેઓનું ચેકીંગ કરવા જાય ત્યારે ટેસ્ટીંગ તેઓએ તેમની રૂબરૂમાં પણ કરાવવાનું રહેશે.
- (૩) ધારા ધોરણ પ્રમાણેના પરીક્ષણોની સંખ્યા પૈકી ૮૦% પરીક્ષણ ફિલ્ડ લેબોરેટરીમાં ઇજારદારના અધિકૃત ક્વોલીફાઇડ ઇજનેર કે જેઓને સંબંધિત કાર્યપાલક ઇજનેરશ્રીએ આઇ-કાર્ડ આપેલ હોય તેમનાં ધ્વારા ખાતાના ના.કા.ઇ./મ.ઇ./અ.મ.ઇ.ની હાજરીમાં જ કરવાના રહેશે અને પરિણામોમાં સંયુક્ત સહીઓ કરવાની રહેશે જ્યારે ૧૦% પરિક્ષણ ગેરી/સરકાર માન્ય લેબોરેટરી (ઓછામાં ઓછું એક પરીક્ષણ) અને ૧૦% ગેરી લેબોરેટરી (ઓછામાં ઓછું એક પરીક્ષણ) મારફતે કરાવવાના રહેશે.
- (૪) કુલ પરિક્ષણોના ૮૦% પરિક્ષણ એક જ સ્થળે એકજ સમયે એકજ તબક્કામાં નહીં કરતાં કામની પ્રગતિ મુજબ જે તબક્કાએ જે તે કામગીરીને અનુરૂપ જે મટીરીયલ્સ વાપરવાનું થતુ હોય તુદાનુસાર શરૂઆતના તબક્કામાં રાખવું વચ્ચેના તબક્કામાં તેમજ આખરી તબક્કામાં કરાવવાનું રહેશે. આમ છતાં આ બાબતે સ્થાનિક કક્ષાએથી ના.કા.ઇ.શ્રીએ જરૂરીયાત મુજબ તબક્કાવાર પરીક્ષણો તકકી કરવાના રહેશે.
- (૫) ગુણવત્તા નિયમન ધારા-ધોરણ પ્રમાણેના બધા જ રજીસ્ટર નિયમિત રીતે નિભાવવાના રહેશે અને તે જે તે સ્થળે લેબોરેટરીમાં ઉપલબ્ધ રહે તેમ રાખવાના રહેશે.
- (૬) જો કોઈ કારણોસર ટેસ્ટીંગના સાધન અપ્રાપ્ય હોય અથવા વસાવવામાં સમય જાય તેમ હોય કે વ્યવહારુ ન હોય (જેમ કે ઇલેક્ટ્રોમેટ્રિક બેરીંગ) તો આવા પરીક્ષણો ગેરી/સરકાર માન્ય સંસ્થાઓમાં કરાવી શકાશે. અને આ બાબતનો નિર્ણય સંબંધિત કા.ઇ.શ્રી / ના.કા.ઇ.શ્રીએ કરવાનો રહેશે. ગેરીમાં ન થઈ શકે તેવા ટેસ્ટ સરકાર માન્ય લેબોરેટરીમાં કરાવી શકાય.
- (૭) વિભાગના ક્ષેત્રિય તાંત્રિક સ્ટાફે ના.કા.ઇ./મ.ઇ./અ.મ.ઇ.એ તેમજ ઇજારદારના તાંત્રિક સ્ટાફ ધ્વારા ગેરીમાં પરીક્ષણ જાતે કરવાનો સંતોષકારક અનુભવ મેળવી આ બાબતનું ગેરીનું પ્રમાણપત્ર પણ મેળવવાનું રહેશે. જે તે જિલ્લા/પ્રાદેશિક સ્તરે ગેરીની લેબોરેટરીમાં કોર્પ કન્ડક્ટ કરવા માટે જરૂરી ફી જે તે વિભાગના કા.ઇ.શ્રીએ ચુકવવાની રહેશે અને આ કાર્યવાહી સમયબદ્ધ પૂર્ણ થાય તે માટે સંબંધિત અ.ઇ.શ્રીએ આ કામગીરીની વખતોવખત સમીક્ષા કરવાની રહેશે.
- (૮) આ પરિપત્રથી ઉપર જણાવેલા પરીક્ષણો પૈકી ૮૦% પરીક્ષણો ક્ષેત્રિય લેબોરેટરીમાં કરવાનો સમય તા.૧/૧/૨૦૧૦ થી કરવાનો રહેશે.
- (૯) ગેરીમાં ટેસ્ટીંગ કરાવતાં સમયે ગેરીનો ટેસ્ટીંગ ચાર્જ ત્વરીત ભરવાનો રહેશે. જેથી પરીક્ષણના પરીણામો સમયસર મેળવી શકાય.

સહી/-

(આર. કે. ચૌહાણ)

ખાસ ફરજ પરના અધિકારી (વિ.યો.)

માર્ગ અને મકાન વિભાગ

ટેન્ડર ફોર્મ બી-૨ ના કોન્ટ્રાક્ટરોની  
માર્ગદર્શન માટે સામાન્ય નિયમો  
અને સૂચનોના સૂચન નં.૧૮ માં  
સ્પષ્ટતા કરવા બાબત

ગુજરાત સરકાર  
માર્ગ અને મકાન વિભાગ  
ક્રમાંક:- ટીએનસી-૧૦-૨૦૧૩-(૦૨)-સી  
સચિવાલય, ગાંધીનગર  
તા. ૧૦-૦૫-૨૦૧૩

સંદર્ભ:- મા.મ.વિભાગના ઠરાવ ક્ર. ટીએનસી-૧૦૯૦-(આઈબી-૨૨)-(૧૦)-સી તા.૨૪-૦૫-૧૯૯૦

આમુખ:-

ઉપરોક્ત વિષય અન્વયે ના સંદર્ભિત ઠરાવ માં સૂચન નં.૧૮ માં "આ કામ માટે  
ટેન્ડરો રજીસ્ટર ટપાલ દ્વારા રવાના કરવામાં આવે ત્યારબાદ ટેન્ડર પર સ્વિકારવાની  
સૂચિત તારીખથી ૯૦/૧૨૦ દિવસ સુધી ઓફર ખુલ્લી રહેશે." તેમ દર્શાવેલ છે.

હવે ઉદ્યોગ અને ખાણ વિભાગના ઠરાવ નં. એસપીઓ-૧૦૨૦૦૫-૧૪૦૭-સીએચ  
તા.૨૨-૧૧-૨૦૦૬ ના સંદર્ભે કામોના ટેન્ડર Online માંગવામાં આવે છે અને ઉપરના  
સૂચન નં. ૧૮ માં "ટેન્ડર પર સ્વિકારવાની સૂચિત તારીખથી ૯૦/૧૨૦ દિવસ સુધી  
ઓફર ખુલ્લી રહેશે" તેવી જોગવાઈ ના કારણે ટેન્ડર ની વેલીડીટીમાં વિસંગતતા ઉભી  
થવા બાબતની ગુજરાત કોન્ટ્રાક્ટર એસોસીએશન ની વિવિધ સ્તરે રજુઆતો મળેલ છે.  
આ રજુઆતો પર પુખ્ત વિચારણાને અંતે આ બાબતે નીચે મુજબની સ્પષ્ટતા કરવામાં  
આવે છે.

સ્પષ્ટતા

" Online Tender System માં સીગલ કવર સીસ્ટમ વાળા ટેન્ડરોમા ટેન્ડર વેલીડીટી નો  
સમય ટેન્ડર ઓનલાઈન ખોલ્યા તારીખથી જ્યારે ટુ કવર બીડ સીસ્ટમમાં ટેન્ડર  
વેલીડીટીનો સમય ટેકનીકલ બીડ ખોલ્યા તારીખથી ગણવાનો રહેશે."

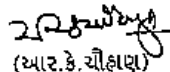
  
(આર.કે.ચૌહાણ)  
ખાસ ફરજ પરના અધિકારી(વિ.વો.)  
માર્ગ અને મકાન વિભાગ

ટેન્ડરમાં ભરેલ અસામાન્ય ઊંચા ભાવોના સંદર્ભે કાઠ પર પડતા પ્રાર્થ પર નિયંત્રણ રાખવા તથા કામને નાણાકીય પ્રગતિ સારી સુમેળમાં રહે તે માટે જરૂર જોગવાઈ કરવા બાબત

ગુજરાત સરકાર  
માર્ગ અને મકાન વિભાગ  
પરિપત્ર ક્રમાંક:- પરચ-૧૦૨૦૦૮-(૬૧)-સી  
તા. ૦૩-૦૫-૨૦૧૩

વંચાણે લીધા:- પરિપત્ર ક્રમાંક:- પરચ-૧૦૨૦૦૮-(૬૧)-સી તા. ૨૭-૧૧-૨૦૦૮

સામાન્ય:-

ટેન્ડર માં ઈજારદારશ્રીઓ દ્વારા ભરાતા Imbalances ભાવો વાળા ટેન્ડરના કિસ્સાઓમાં ઈજારદારશ્રીઓ દ્વારા ઊંચા ભાવની આઈટમોની કામગીરી થયા બાદ નીચા ભાવની આઈટમોની કામગીરી ન કરવામાં આવે તેવી પરિસ્થિતિ પર નિયંત્રણ રાખવા માટે તા. ૨૭-૧૧-૨૦૦૮ નો પરિપત્ર જરૂરી જોગવાઈ સાથે બહાર પાડવામાં આવેલ. આ પરિપત્ર અંગે વિવિધ સ્તરોએ થયેલ રજૂઆતોને ધ્યાને લેતાં અને તેના પર પુખ્ત વિચારણાના અંતે આ પરિપત્રના બીજા ફકરાની છેલ્લી લીટી "આ રીતે વીથહેલ રાખેલ રકમ કામ સંતોષકારક રીતે પૂર્ણ થયે કાર્યનલ બીલ મંજૂર કરતી વખતે વ્યાજભારણ વગર છૂટી કરવામાં આવશે" તેની જગ્યાએ નીચે મુજબનો સુધારો કરવામાં આવે છે.

સુધારો:-

"આ રીતે વીથહેલ રાખેલ રકમ અસાધારણ નીચા ભાવ ભરેલ હોય તેવી આઈટમની નાણાકીય પ્રગતિનાં પ્રમાણસર રનીંગ બીલમાંથી છૂટી કરવાની રહેશે. જે કિસ્સામાં અસાધારણ નીચા ભાવ ભરેલ કોઈપણ આઈટમ ન હોય તેવા કિસ્સામાં અસાધારણ ભાવો ભરેલ આઈટમની સામે વીથહેલ રાખેલ રકમ બાકી રહેતી કામગીરી થાય તેના પ્રમાણસર રનીંગ બીલમાંથી છૂટી કરવાની રહેશે."

વધુમાં વંચાણે લીધેલ પરિપત્ર ના ઉદ્દેશ્યમાં દર્શાવેલ ક્રમાંક-૮ રદ કરવામાં આવે છે.

ઉપરોક્ત સુધારાનો અમલ આ પરિપત્રની તારીખ પછી મંજૂર થતા ડી.ટી.પી. માં અચૂકપણે કરવાનો રહેશે.

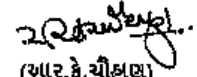

(આર.કે.ચૌહાણ)

ખાસ ફરજ પરના અધિકારી(વિ.ઓ.)  
માર્ગ અને મકાન વિભાગ

પ્રતિ,

સર્વે અધિક્ષક ઈજનેરશ્રીઓ, મા.મ. વિભાગ (પાટનગર મોજના વર્તુળ, નેશનલ હાઈવે વર્તુળ, સહિત).

સર્વે અધિક્ષક ઈજનેરશ્રીઓ (પંચાયત) મા.મ. વિભાગ.

સર્વે કાર્યપાલક ઈજનેરશ્રીઓ, મા.મ. વિભાગ.

સર્વે કાર્યપાલક ઈજનેરશ્રીઓ, (પંચાયત), મા.મ. વિભાગ.

નકલ રવાના:-

૧. અગ્ર સચિવશ્રીના અંગત મદદનીશશ્રી, મા.મ. વિભાગ, સચિવાલય, ગાંધીનગર

૨. સર્વે મુખ્ય ઈજનેર અને અ.શ્રીઓ, મા.મ. વિભાગ.

૩. સર્વે તાંત્રિક ઉપ સચિવશ્રીઓ, મા.મ. વિભાગ.

૪. ના.કા.ઈ.શ્રીઓ, મા. મ. વિભાગ.

૫. નાણાં શાખા, મા.મ. વિભાગ.

૬. ના.સે.અ, સી શાખા, મા.મ. વિભાગ., સિલેક્ટ હાઈલ.

૭. શાખા સિલેક્ટ હાઈલ -૨૦૧૩

Modification in Defect Liability  
Clause 17 A of Tenders for  
Building works

Government of Gujarat  
Roads & Buildings Department  
Circular No. PRCH-102013-207/2759/N  
Sachivalaya, Gandhinagar  
Date :- 27-05-2013

Ref :- Circular No. PRCH-102008-(2076) – N Dt. 3-12-2009

R&B Department had issued a circular as referred above where in following provision has been made for building works.

**The Defects Liability period shall be as under for original building works:**

Three years of elapse of three monsoon periods following date of possession of building taken over by user agency OR Four years of elapse of four monsoon periods following the certified date of completion, Whichever is earlier.

After due considerations on the representations received at various levels from the Gujarat Contractor Associations the above clause is now modified as under

**The defects Liability period shall be as under for original building works:**

" One year or elapse of one monsoon period from the certified date of completion whichever is greater "

The other conditions in the above said circular will remain as it is.

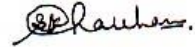

(R.K. Chauhan)

Officer on Special Duty(S.P.)

Road & Buildings Department

To,

All , Superintending Engineers, State,Ahmedabad city,Capital,Project and Panchayat Circles, R & B Department,

All,Executive Engineers under above circles.

Copy To:

1. PA to Principal Secretary(R&B), Sachivalaya, Gandhinagar.
2. All Chief Engineers & Additional Secretaries (R&B), Sachivalaya, Gandhinagar.
3. Select File.



પરફોર્મન્સ બોન્ડ તથા જામીન અનામત પેટે બેંક  
ગેરેન્ટી મેળવવા બાબત

ગુજરાત સરકાર

માર્ગ અને મકાન વિભાગ

પરિપત્ર ક્રમાંક: ટી.એન.સી-૧૦-૨૦૧૩-૩૨(ભાગ-૧)-સ

સચિવાલય, ગાંધીનગર

તા.૧૯-૧૧-૨૦૧૩

વંચાણે લીધો પરિપત્ર ક્રમાંક:- ટી.એન.સી-૧૦૯૧/આઈ.બી/૧૦/૧૧/સ તા.૩૧-૩-૧૯૯૯

આમુખ:-

વંચાણે લીધેલ પરિપત્ર મુજબ હાલમાં ૧૫ લાખ કે તેથી વધુ રકમની કામો માં ઈજારદારશ્રી પાસેથી પરફોર્મન્સ બોન્ડ લેવાની જોગવાઈ છે. પરંતુ હવે મોટા ભાગના કામો ૧૫ લાખ થી વધુ રકમના હોય છે અને ચાલુ મરામતના કામો પણ હવે ૧૫ લાખ થી વધુ રકમના હોય છે. આ બાબતે કોન્ટ્રાક્ટસ ઍસોસીએશન તરફથી પણ પરફોર્મન્સ બોન્ડ માટે કામની રકમ ની મર્યાદા વધારવા માટેની રજુઆત કરવામાં આવેલ છે. આથી વહીવટી સરળતા અને અનુકૂળતા જાળવાય તે હેતુસર પરફોર્મન્સ બોન્ડ માટે કામની રકમમાં ફેરફાર કરવાનું સરકારશ્રીની વિચારણા હેઠળ હતું

પરિપત્ર:-

પુખ્ત વિચારણાને અંતે નક્કી થયેલ છે કે હવે ૩.૧૫ લાખ કે તેથી વધુ રકમને બદલે ૩.૩૦ લાખ કે તેથી વધુ રકમ ના સરકારી કામોમાં ઈજારદારશ્રી પાસેથી પરફોર્મન્સ બોન્ડ લેવાના રહેશે.

આ પરિપત્ર વિભાગની સરખા ક્રમાંકની કાંઈલ પરની નોંધ પર નાણાંવિભાગની તા.૨૨-૯-૧૩ ના રોજથી પ્રતોલ સંમતીથી બહાર પાડવામાં આવે છે.

ગુજરાત ના રાજ્યપાલશ્રીના હુકમથી અને તેમના નામે.



(આર.કે.ચૌહાણ)

ખાસ ફરજ પરના અધિકારી(રિ.ચો.)

માર્ગ અને મકાન વિભાગ



બાંધકામના કોન્ટ્રાક્ટર પાસેથી સી.યુ.રી.ટી ડીપોઝીટ  
સ્વિકારવાની પ્રથામાં અંશતઃ ફેરફાર કરવા બાબત

ગુજરાત સરકાર  
માર્ગ અને મકાન વિભાગ  
ઠરાવ ક્રમાંક: ટીએનસી-૧૦-૨૦૧૩-૩-(બાગ-૨)-સી  
સચિવાલય, ગાંધીનગર  
તા.૨૦-૧૧-૨૦૧૩

વંચાણે લીધો ઠરાવ ક્રમાંક:- ટીએનસી-૧૦૮૮/આઈબી/૧૮/(૧૩)/સ તા.૩૧-૮-૧૯૪

**આમુખ:-**

કોન્ટ્રાક્ટરોને આપવામાં આવતા કામો માં સીક્યુરીટી ડીપોઝીટ અંગેની હાલની પદ્ધતિ પ્રમાણે એગ્રીમેન્ટ સમયે ૫% પરફોર્મન્સ બોન્ડ બેંક ગેરંટી સ્વરૂપે, ૨.૫% સીક્યુરીટી ડીપોઝીટ નર્મદ બોન્ડ અથવા એન.એસ.એસ. સ્વરૂપે લેવામાં આવે છે તેમજ ૨.૫% રકમ ઈજારદારશ્રીના રનોંગ બીલમાંથી કપાત સ્વરૂપે વસુલ કરવામાં આવે છે. કોન્ટ્રાક્ટર્સ એસોસિએશન દ્વારા નાણાકીય તરલતા હેઠળ તે માટે ૨.૫% લેખે કાપવામાં આવતી સીક્યુરીટી ડીપોઝીટની રકમ બેંક ગેરંટી સામે છુટી કરવાની રજુઆત કરવામાં આવેલ હતી. જે બાબત વિચારણા હેઠળ હતી.

**ઠરાવ:-**

પુખ્ત વિચારણાને અંતે સરકારી કામોના કોન્ટ્રાક્ટ માટે સીક્યુરીટી ડીપોઝીટ સ્વિકારવાની હાલની પ્રથામાં નીચે મુજબ નો ફેરફાર કરવામાં આવે છે.

૧. હાલમાં પ્રથમ તબક્કે લેવામાં આવતી ૨.૫% સીક્યુરીટીની રકમ જે નર્મદા બોન્ડ/ એન.એસ.એસ. સ્વરૂપે લેવાની જોગવાઈ છે, તે કવે નર્મદા બોન્ડ/ એન.એસ.એસ. તેમજ શીક્વલ બેંકની એફ.ડી.આર. સ્વરૂપે પણ લઈ શકાયો.
૨. રનોંગ બીલમાંથી કપાત થતી ૨.૫% સીક્યુરીટી ડીપોઝીટની રકમ ઈજારદારશ્રી દ્વારા શીક્વલ બેંકની બેંક ગેરંટી રજુ કર્યોથી નીચે જણાવ્યા મુજબ રીલીઝ કરવાની રહેશે.

ક્રમ	નાણાકીય પ્રગતિ	રનોંગ બીલમાંથી ૨.૫% લેખે સીક્યુરીટી ડીપોઝીટ પેટે કાપવામાં આવેલ રકમ માંથી છુટી કરવા પાત્ર રકમ	બેંક ગેરંટીની રકમ
૧	ટેન્ડરની રકમના ૨૫%	રનોંગ બીલમાંથી કાપવામાં આવેલ રકમ અથવા કામની અંદાજિત કિંમતના ૦.૬૨૫%. બેમાંથી જે ઓછી રકમ હોય તે.	રીલીઝ કરવામાં આવેલ રકમ જે લી
૨	ટેન્ડરની રકમના ૫૦%	રનોંગ બીલમાંથી કાપવામાં આવેલ રકમ અથવા કામની અંદાજિત કિંમતના ૧.૨૫%, બેમાંથી જે ઓછી રકમ હોય તે.	રીલીઝ કરવામાં આવેલ રકમ જે લી
૩	ટેન્ડરની રકમના ૭૫%	રનોંગ બીલમાંથી કાપવામાં આવેલ રકમ અથવા કામની અંદાજિત કિંમતના ૧.૮૭૫%, બેમાંથી જે ઓછી રકમ હોય તે.	રીલીઝ કરવામાં આવેલ રકમ જે લી

ઉપરોક્ત બેંક ગેરંટીની મુદત કામ પુર્ણ થવાની ખરેખર તારીખથી છ(છા)માસ વધુ સમયની લેવાની રહેશે તથા ઈજારદારશ્રી પાસેથી બાંહેધરીપત્ર મેળવવાનો રહેશે કે, જે કામ પુર્ણ કરવાની સમયમર્યાદામાં વધારો થશે તો વધારેલ સમયમર્યાદાની તારીખથી ૬ માસ વધુ સમયમર્યાદા વાળી બેંક ગેરંટી નેઓશ્રી દ્વારા પુરી પાડવામાં આવશે.

કામ પુર્ણ થાય ત્યાં સુધી ઈજારદારશ્રી પાસેથી લેવાની થતી ૧૦% સીક્યુરીટી ડીપોઝીટનું પ્રમાણ કોઈપણ સ્વરૂપે જળવાઈ રહે તેની અચૂક કાળજી રાખવાની રહેશે.

આ ઠરાવ વિભાગનો સરખા ક્રમાંકની ફાઇલ પરની નોંધ પર નાણાવિભાગની તા.૬-૧૦-૧૩ ના રોજથી મળેલ સંમતીથી બહાર પાડવામાં આવે છે.

ગુજરાત ના રાજ્યપાલશ્રીના હુકમથી અને તેમના નામે.

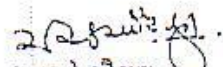
  
(આર.કે.ચૌહાણ)  
પાસ ફરજ પરના અધિકારી(વિ.વો.)  
માર્ગ અને મકાન વિભાગ





સ્પષ્ટતા કરતા જણાવવાનું કે, ટેન્ડર કલોઝ નં. પલ્એની મુળ જોગવાઈ જે પ્રથમ ત્રણ પંક્તિમાં જણાવેલ છે તેમાં સ્પષ્ટ જણાવેલ છે કે, ".....SHALL BE ADJUSTED FOR INCREASE OR DECREASE IN THE RATES OF THESE MATERIALS AS UNDER" આમ આ કલોઝની આ જોગવાઈ હેઠળ જ આગળની કાર્યવાહી તે પ્રમાણે કરવાની થાય છે.

આમ, ઉપરોક્ત બાબતે સર્વે કાર્યપાલક ઈજનેરશ્રી તેમજ એકાઉન્ટન્ટશ્રીઓનું ધ્યાન દોરવું જરૂરી છે અને આવા વસુલાતપાત્ર કિસ્સામાં વસુલાત કરવામાં આવે તે બાબતે ધ્યાન આપવા તાકીદ કરવામાં આવે છે. જો આમ કરવામાં ચુક થશે તો સંબંધિત નાયબ કાર્યપાલક ઈજનેરશ્રી, કાર્યપાલક ઈજનેરશ્રી, વિભાગીય સિસાબનીશ / અધિકારીની સીધી જવાબદારી રહેશે.

સદર બાબતે સર્વે અધિક્ષક ઈજનેરશ્રીઓને સુચના આપવામાં આવે છે કે, તેઓના હસ્તકના વિભાગોમાંથી આ પ્રકારના કામો જુદા તારવી તેમાં વસુલાત કરવામાં આવી છે કે નહીં તે બાબતે યોગ્ય ચકાસણી કરી લેવી અને જો વસુલાત કરવામાં ના આવી હોય તો તે અંગે ત્વરિત જરૂરી વસુલાત કરવા જરૂરી સુચના સંબંધિત કાર્યપાલક ઈજનેરશ્રીને આપવી.

  
(અન.જી. પરમાર)  
ખાસ ફરજ પરના અધિકારી (વિ.યો.)  
માર્ગ અને મકાન વિભાગ

S.E. RAJKOT  
R & B Circle No. II

INWARD 306  
DATE: 3/3

મકાનો તથા પુલોના આર.સી.સી. કામોમાં લોખંડના સળીયાના માપો લખવા તથા ચૂકવણામાં લેપ લેન્થ ની લંબાઈ ગણતરીમાં નહીં લવા બાબત

ગુજરાત સરકાર  
માર્ગ અને મકાન વિભાગ  
સચિવાલય, ગાંધીનગર  
પરિપત્ર ક્રમાંક:- PDW-10-2017-01-C  
તા.૧૫-૦૨-૨૦૧૭

પરિપત્ર:-

મકાન, રસ્તા અને પુલોના કામોમાં આર.સી.સી. આઇટમોમાં સમાવિષ્ટ સ્ટીલ રેઇનફોર્સમેન્ટના માપો લખવા અને ચૂકવણા દરમ્યાન લેપની લંબાઈ ગણતરીમાં લેવામાં આવે છે. રેઇનફોર્સમેન્ટમાં લેપની વધુ સંખ્યાને પ્રોત્સાહન ન આપતા સળંગ રેઇનફોર્સમેન્ટ (સળીયા) જ મહદઅંશે વપરાય એ તાંત્રિક રીતે વધુ યોગ્ય છે.

MORT&H સ્પેશીફિકેશનના પ્રવર્તમાન ધારાધોરણ મુજબ રેઇનફોર્સ (સળીયા)ના ચૂકવણામાં લેપની લંબાઈના માપો ગણતરીમાં લેવામાં આવતા નથી. (Section 1608)

MORT&H સ્પેશીફિકેશનના પ્રવર્તમાન ધારાધોરણ મુજબ માર્ગ અને મકાન વિભાગ હેઠળ મકાન, રસ્તા અને પુલના રેઇનફોર્સ (સળીયા)ના સ્પેશીફિકેશનમાં Mode of Measurement & Payment માં હવે પછી નીચે મુજબના ફેરફાર કરવા આથી સુચના આપવામાં આવે છે.

<u>EXISTING ITEM</u>	<u>PROPOSED AMENDMENT</u> (As per MORT&H Specification Item No.1608)
<p><u>મકાનના સ્પેશીફિકેશન</u></p> <p>5.4.10 Providing an Mild Steel reinforcement for R.C.C. work including bending binding and placing in position etc. complete up to floor two level.</p> <p>5.4.11 High yield deform bars steel reinforcement for R.C.C. work including bending, binding and placing in position complete up to floor two level.</p> <p>3.2 Reinforcement shall be measured in length including overlaps, separately for different diameters as actually used in the work. Where welding or coupling is resorted to in place lap joints, such</p>	<p><u>મકાનના સ્પેશીફિકેશન</u></p> <p>5.4.10 Providing an Mild Steel reinforcement for R.C.C. work including bending binding and placing in position etc. complete up to floor two level.</p> <p>5.4.11 High yield deform bars steel reinforcement for R.C.C. work including bending, binding and placing in position complete up to floor two level.</p> <p>3.2 Reinforcement shall be measured in length including hooks, if any, separately for differnent diameters as actually used in work, excluding overlaps. From the length so</p>

Ext. DTP ની  
Incomparable  
BY  
E

2

<p>joints shall be measured for payment as equivalent length of overlap as per design requirement. From the length so measured, the weight of reinforcement shall be calculated in tones on the same basis of as per M-18 even though steel is supplied to the contractor by the department on actual weight. Length shall include hooks at the ends Wastage and annealed steel wire for binding shall not be measured and the cost of these items shall be deemed to be included in the rate for reinforcement.</p>	<p><i>measured, the weight of reinforcement shall be calculated in tonnes on the basis of IS: 1732. Wastage, overlaps, couplings, welded joints, spacer bars, chairs, stays, hangers and annealed steel wire or other methods for binding and placing shall not be measured and cost of these items shall be deemed to be included in the rates for reinforcement.</i></p>
<p><b><u>EXISTING ITEM</u></b></p>	<p><b><u>PROPOSED AMENDMENT</u></b> (As per MORT&amp;H Speciafication Item No.1608)</p>
<p><u>रस्ताला स्पेशलीकेशन</u> <b>Item No. 39</b> : Providing steel reinforcement. a) Providing and placing in position mild steel bar reinforcement including cutting, bending, hooking and tying complete as per details. b) High yield strength deformed bars reinforcement. (10) Reinforcement shall be measured in length seperealy for different diameters as actually used in the work, from the length so measured the weight of reinforcement shall be calculated in tones on the same basis of IS : 1732 even though steel is supplied to the contractor by the Department on actual wieghment. Length shall ilcude hooks at ends. Wastage and annealed steel wire for binding shall not be measured and cost of thes items shall be deemed to be</p>	<p><u>रस्ताला स्पेशलीकेशन</u> <b>Item No. 39</b> : Providing steel reinforcement. a) Providing and placing in position mild steel bar reinforcement including cutting, bending, hooking and tying complete as per details. b) High yield strength deformed bars reinforcement. (10) Reinforcement shall be measured in length including hooks, if any, separately for differencnt diameters as actually used in work, excluding overlaps. From the length so measured, the weight of reinforcement shall be calculated in tonnes on the basis of IS: 1732. Wastage, overlaps, couplings, welded joints, spacer bars, chairs, stays, hangers and annealed steel wire or</p>



3

included in the rates for reinforcement.	<i>other methods for binding and placing shall not be measured and cost of these items shall be deemed to be included in the rates for reinforcement.</i>
<p><u>પુલના સ્પેશીફિકેશન</u> <b>Item: 21</b> –Providing (A) Mild Steel Reinforcement (B) High Yield Strength Deformed bars, reinforcements. (10) Reinforcement shall be measured in length including overlaps, separately for different diameter, as actually used in the work, where welding or coupling is restored to, in place of lap-joints, such joints shall be measured for payment as the equivalent length of over lap as per design requirement. From the length so measured the weight of reinforcement shall be calculated in tones on the same basis of IS 1732 even though steel is supplied to the contractor by the Department on actual weight. Length shall include hooks at ends. Wastage and annealed steel wire for binding shall not be measured and cost of these items shall be deemed to be included in the rates for reinforcement.</p>	<p><u>પુલના સ્પેશીફિકેશન</u> <b>Item: 21</b> –Providing (A) Mild Steel Reinforcement (B) High Yield Strength Deformed bars, reinforcements. (10) Reinforcement shall be measured in length including hooks, if any, separately for different diameters as actually used in work, excluding overlaps. From the length so measured, the weight of reinforcement shall be calculated in tonnes on the basis of IS: 1732. Wastage, overlaps, couplings, welded joints, spacer bars, chairs, stays, hangers and annealed steel wire or other methods for binding and placing shall not be measured and cost of these items shall be deemed to be included in the rates for reinforcement.</p>

*aydun*  
(એન. જી. પરમાર)  
ખાસ ફરજ પરના અધિકારી (વિ.યો.)  
માર્ગ અને મકાન વિભાગ

વિભાગીય સહાયક  
અધિકારી  
સામાજિક કાર્ય વિભાગ

માર્ગ અને મકાન વિભાગના કામોમાં ડીફેક્ટ  
લાયેબીલીટી પીરીયડમાં ફેરફાર કરવા બાબત

ગુજરાત સરકાર  
માર્ગ અને મકાન વિભાગ  
ઠરાવ ક્રમાંક: ટીએનસી/૧૦/૨૦૧૬/કલોઝ-૧૭ એ/સુધારો/(૧)/સ  
સરદાર ભવન, બ્લોક નં.૧૪  
સચિવાલય, ગાંધીનગર  
તા.૧૨/૦૫/૨૦૧૬

સંદર્ભ:- માર્ગ અને મકાન વિભાગના કામો માટે નિયત કરેલ ટેન્ડર ફોર્મ બી-૧ અને બી-૨ ના કલોઝ-૧૭ એ માંની  
જોગવાઈ

આમુખ:-

ગુજરાત સરકાર માર્ગ અને મકાન વિભાગ દ્વારા હાથ ધરવામાં આવતા કામો માટે નિયત કરેલ ટેન્ડર ફોર્મ  
બી-૧ અને બી-૨ નો ઉપયોગ કરવામાં આવે છે. આ કામોમાં ડીફેક્ટ લાયેબીલીટી પીરીયડ માટે નિયત કરેલ ટેન્ડર  
ફોર્મ બી-૧ અને બી-૨ ના કલોઝ-૧૭ એ મુજબની કાર્યવાહી કરવામાં આવે છે. આ ડીફેક્ટ લાયેબીલીટી પીરીયડની  
જોગવાઈઓમાં ફેરફાર કરવાની બાબત સરકારશ્રીની સક્રિય વિચારણા હેઠળ હતી.

ઠરાવ:-

ઉપરોક્ત બાબતે પુખ્ત વિચારણાના અંતે માર્ગ અને મકાન વિભાગના કામો માટે નિયત કરેલ ટેન્ડર ફોર્મ  
બી-૧ અને બી-૨ માંના ડીફેક્ટ લાયેબીલીટી પીરીયડ અંગેના કલોઝ-૧૭ એ માંની જોગવાઈઓમાં નીચે મુજબનો  
ફેરફાર કરવામાં આવે છે.

Clause	Existing Provision	Modified Provision
17 A (b)	For all works costing more than Rs.50,000/- and up to Rs.1 crore (amount put to tender), period shall be <b>6 months</b> from the certified date of completion or one monsoon, whichever is later.	For all works costing more than Rs.50,000/- and up to Rs.1 crore (amount put to tender), period shall be <b>12 months</b> from the certified date of completion or one monsoon, whichever is later.
17 A (c)	For major projects costing more than <b>Rs. 1 crore</b> , period shall be <b>12 months</b> from the certified date of completion which should include one monsoon	For major projects costing more than <b>Rs. 1 crore, (amount put to tender)</b> , period shall be <b>36 months (thirty six)</b> from the certified date of completion or three monsoons, whichever is later.

ઉપરોક્ત ઠરાવ સરખા ક્રમાંકની ફાઇલ પરની નોંધમાં માનનીય મંત્રીશ્રી (મા.મ.)ની તા.૧૦/૦૫/૨૦૧૬ના  
રોજ મંજૂરી મેળવી બહાર પાડવામાં આવેલ છે. આ ઠરાવના ઇચ્છુ તારીખથી ઉપરોક્ત સુધારેલ જોગવાઈઓનો  
ચુસ્તપણે અમલ કરવાનો રહેશે.

ગુજરાતના રાજ્યપાલશ્રીના હુકમથી અને તેમના નામે,

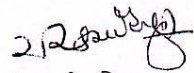
  
(આર.કે.ચૌહાણ )  
ખાસ ફરજ પરના અધિકારી (વિ.ચો.)  
માર્ગ અને મકાન વિભાગ  
ગાંધીનગર



**INVITATION OF TENDER ON PERCENTAGE  
RATE (B-1) TENDER CONTRACT FORM**

Government of Gujarat  
Road & Buildings Department  
No.TNC-1088-D-347-(7)-C  
Schivalaya, Gandhinagar  
Date:- 11/07/2017

**Reference:-**

1. R & B Department Resolution No.CON-1269-PAC-(52)-C, Dated 05/06/1985
2. R & B Department Resolution No.TNC-1088-D-347-(7)-C dated 22/04/1988
3. R & B Department Resolution No. TNC-1088-D-347-(7)-C dated 05/08/1988
4. R & B Department Resolution No. TNC-1088-D-347-(7)-C dated 15/12/2003

**RESOLUTION**

1. The question of raising monetary limit for B-1 tender form from Rs.50.00 lakhs (Rupees Fifty Lakhs only) was under consideration of Government. Government is pleased to order that the monetary limit of Rs.50.00 lakhs (Rupees Fifty Lakhs only) for B-1 tender form (fixed under aforesaid G.R. dated 15/12/2003) is hereby enhanced to Rs.12.00 Crore (Rupees Twelve Crore only) for Road works, and Rs.10.00 Crore (Rupees Ten Crore only) for Bridge and Building works. This enhanced monetary limit shall be applicable to the tenders to be invited hereafter with the strict application of a condition that tenders for the works amount put to tender upto Rs.12.00 Crore (Rupees Twelve Crore only) for Road works, and Rs.10.00 Crore (Rupees Ten Crore only) for Bridge and Building works should invariably be invited on B-1 tender form only.
2. Other safeguards and instructions in the G.Rs. mentioned in reference should be strictly followed.
3. These orders are issued with the concurrence of Finance Department dated 27/06/2017 on this Department's file No. TNC-102013-731236-04-C

By order and in the name of the Governor of Gujarat,

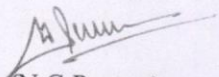
  
(N.G.Parmar)  
Officer on Special Duty (S.P)  
R&B Department  
Gandhinagar



ટેન્ડરમાં જથ્થાવધારા તથા  
જથ્થાવધારાના ભાવના માપદંડમાં  
સુધારણા કરવા બાબત

ગુજરાત સરકાર  
માર્ગ અને મકાન વિભાગ  
બ્લોક નં.૧૪/૨, સરદાર ભવન,  
સચિવાલય, ગાંધીનગર  
ઠરાવ ક્રમાંક: TNC-10-2017-01-C  
તા.૧૧/૦૭/૨૦૧૭

ઠરાવ

ટેન્ડરમાં જથ્થાવધારા તથા જથ્થાવધારાના ભાવના માપદંડ બાબતે બી-૧ અને બી-૨ ટેન્ડરના કલોઝ-૧૪.૨ માં જણાવ્યા મુજબ જથ્થાવધારા માટે ૩૦ ટકા સુધીનો જથ્થો ટેન્ડરના ભાવથી અને ૩૦ ટકાથી વધુ જથ્થામાં વધારો હોય તો જે તે વર્ષમાં કામગીરી કરેલ હોય તે વર્ષના એસ.ઓ.આર.થી કરવાની જોગવાઈ છે.

સદરહુ જોગવાઈમાં સુધારણા કરવા બાબતે સરકારશ્રીમાં ઘણા લાંબા સમયથી વિચારણા હેઠળ હતું. જે અન્વયે નીચે મુજબનો સુધારો કરવામાં આવે છે.

EXISTING CLAUSE	AMENDMENT
<b>Form B-1 Clause- 14.2</b> <b>Form B-2 Clause- 14.2</b> Except that when the quantity of any item exceeds the quantity as in the tender by more than 30% the contractor will be paid for the quantity in excess of 30% at the rate entered in the SOR of the year during which the excess in quantity is first executed and for the material consumed in excess quantity the rate for the material to be charged would be basic rate taken into account for fixing the rate for the SOR above instead of the rate stipulated in Schedule-A.	<b>Form B-1 Clause- 14.2</b> <b>Form B-2 Clause- 14.2</b> Except that when the quantity of any item exceeds the quantity as in the tender by more than <b>10%</b> the contractor will be paid for the quantity in excess of <b>10%</b> at the rate entered in the SOR of the year during which the excess in quantity is first executed or tender rate whichever is less.

ઉપરોક્ત તમામ સુચનાનો અમલ ચુસ્તપણે તાત્કાલિક અસરથી કરવાનો રહેશે.

ગુજરાત રાજ્યના રાજ્યપાલશ્રીના હુકમથી અને તેમના નામે,

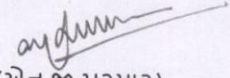
  
(એન.કે.પરમાર)

ખાસ ફરજ પરના અધિકારી (વિ.યો.)  
માર્ગ અને મકાન વિભાગ  
ગાંધીનગર

**STANDARDS FOR CEMENT  
CONSUMPTION FOR DIFFERENT  
ITEMS OF WORK**

**Government of Gujarat**  
Roads & Building Department,  
Circular No. PRC/10/2017/Cement Consumption/16/C  
14, Sardar Bhavan, 2nd Floor,  
Sachivalaya, Gandhinagar  
Date:- 11/05/2017

**Read:-** Government of Gujarat, Road & Building Department, Sachivalaya, Gandhinagar Circular No. SOR/1085/7/H(1) dated 08/12/1986.

**CIRCULAR**

The uniform rate of cement consumption for various item was prepared and circulated vide No. SOR/1085/7/H(1) dated 08/12/1986.

At the outset, current practice of estimating cement consumption in concrete item of various Building, Bridge and Road project is based on above circular. However, it is generally observed that the cement consumption derived by actual mix design is lower than the standard cement consumption. Some of provision of the said circular become obsolete due to subsequent revisions in the relevant IS code and IRC code. The maximum cement consumption as per IS : 456-2000 and IRC : 112-2011 is 450 Kg./m<sup>3</sup>. Also cement industry and aggregate crushing industry have involved better quality of cement and aggregate over the years which have far reaching impact on mix design of the present day concrete.

Mix design report of GERI reflecting entire Gujarat region have been considered in averaging the cement consumption in various grade of design mix concrete. To minimize the difference between standard cement consumption of cement and actual consumption derived by mix design by GERI and the cement consumption as per provision of IS and IRC code falling cement consumption is proposed for estimation purpose.

Looking the above facts, the cement consumption mentioned in circular vide No. SOR/1085/7/H(1) dated 08/12/1986 is required to modify as per below:

EXISTING ITEM			AMENDMENT		
Item	Unit	Quantity of cement to be used per unit quantity of work in Kg	Item	Unit	Quantity of cement to be used per unit quantity of work in Kg.
<b>Building, Road &amp; Bridge Items</b>					
Providing & casting in situ ordinary cement concrete M75 for PCC work	Cu.m.	160	Providing & casting in situ ordinary cement concrete M7.5 for PCC work	Cu.m.	160
Providing & casting in situ ordinary cement concrete M100 for PCC work	Cu.m.	220	Providing & casting in situ ordinary cement concrete M10 for PCC work	Cu.m.	220
Providing & casting in situ ordinary cement concrete M150 for PCC work	Cu.m.	320	Providing & casting in situ ordinary cement concrete M15 for PCC work	Cu.m.	290
Providing and casting situ control cement concrete M200 for RCC work	Cu.m.	400	Providing and casting situ control cement concrete M20 for RCC work	Cu.m.	360
Providing and casting situ control cement concrete M250 for RCC work	Cu.m.	450	Providing and casting situ control cement concrete M25 for RCC work	Cu.m.	380
Providing and casting situ control cement concrete M350 for RCC work	Cu.m.	500	Providing and casting situ control cement concrete M35 for RCC work	Cu.m.	425
Providing and casting situ control cement concrete M400 for RCC work	Cu.m.	525	Providing and casting situ control cement concrete M40 for RCC work	Cu.m.	440
Providing and casting situ control cement concrete M450 for RCC work	Cu.m.	540	Providing and casting situ control cement concrete M45 for RCC work	Cu.m.	450
<b>New Item</b>					
-	-	-	Providing and casting situ control cement concrete M30 for RCC work	Cu.m.	410

The cement consumption of other than above concrete item and other details mentioned in circular vide No. SOR/1085/7/H(1) dated 08/12/1986 will be remain same.

  
(N.G. Parmar)  
Officer on Special Duty (S.P.)  
R&B Department  
Gandhinagar

To,

- 1) The Personal Secretary, Office of the Secretary, Road & Building Department, Sachivalaya, Gandhinagar
- 2) The Personal Secretary, Office of the Secretary, Narmada, Water Resources, Water Supply and Kalpsar Department, Sachivalaya, Gandhinagar
- 3) The Personal Secretary, Office of the Principal Secretary, Health & Family Welfare Department, Sachivalaya, Gandhinagar
- 4) The Personal Secretary, Office of the Additional Chief Secretary, Urban Development and Urban Housing Department, Sachivalaya, Gandhinagar
- 5) The Personal Secretary, Office of the Principal Secretary, Panchayat, Rural Housing and Rural Development Department, Sachivalaya, Gandhinagar
- 6) Accountant General, Rajkot/Ahmedabad
- 7) All the Chief Engineers, Road & Building Department, Sachivalaya, Gandhinagar
- 8) All the Chief Engineers, Narmada, Water Resources, Water Supply and Kalpsar Department, Sachivalaya, Gandhinagar
- 9) The Managing Director, Gujarat State Road Development Corporation, Nirman Bhavan, Gandhinagar
- 10) The Chief Engineer & Director, Staff Training College, Gandhinagar
- 11) The Director, Gujarat Engineering Research Institute (GERI), Vadodara
- 12) The Under Secretary, Gujarat Vigilance Commission, Vigilance Bhavan, Gandhinagar
- 13) All the Superintending Engineers, Road & Building Department (State, Panchayat, National Highway, Capital Project Circle, Electric Circle)
- 14) All the Executive Engineers, (as above circles)
- 15) All Technical Officers, Road & Building Department, Sachivalaya, Gandhinagar
- 16) All Technical Branches, Road & Building Department, Sachivalaya, Gandhinagar
- 17) President, Gujarat Contractors Association, Gajana Hall, Law Garden, Law College Road, Ahmedabad
- 18) Branch Select file-2017.

રસ્તા, પુલો અને મકાનોની ગુણવત્તા  
ચકાસણી માટેના નિયતપત્રકોનો ઉપયોગ  
ઇન્સ્પેક્શન નોંધ માટે કરવા બાબત

ગુજરાત સરકાર  
માર્ગ અને મકાન વિભાગ  
બ્લોક નં.૧૪/૨, સરદાર ભવન,  
સચિવાલય, ગાંધીનગર  
ક્રમાંક: PRC-10-2017-31-C  
તા.૨૬/૦૫/૨૦૧૭

### પરિપત્ર

માર્ગ અને મકાન વિભાગના રસ્તા, પુલ અને મકાનના કામો ઇજારદારશ્રી મારફત કરાવવામાં આવે છે. આ કામોની ગુણવત્તા ચકાસણી કરવાનું કામ ગુણવત્તા નિયમન (મા.મ.) વિભાગ દ્વારા કરવામાં આવે છે. કામોની ચકાસણી માટે ગુણવત્તા નિયમન (મા.મ.) વિભાગ હેઠળ ગુજરાત રાજ્યમાં કુલ-૬ (છ) કાર્યપાલક ઇજનેરશ્રીઓની નિમણુંક કરવામાં આવેલ છે. કામોની ગુણવત્તા ચકાસણી કરી તેનો સ્થળસ્થિતિ મુજબનો ઇન્સ્પેક્શન રીપોર્ટ કાર્યપાલક ઇજનેરશ્રી દ્વારા તૈયાર કરી જે તે સંબંધિત કાર્યપાલક ઇજનેરશ્રીને પૂર્તતા અર્થે સાદર કરવામાં આવે છે અને એની જાણ જે તે વિભાગના સંબંધિત અધિક્ષક ઇજનેરશ્રી અને મુખ્ય ઇજનેરશ્રીને કરવામાં આવે છે. ગુણવત્તા નિયમનના કાર્યપાલક ઇજનેરશ્રીઓ દ્વારા રજુ કરવામાં આવતા ઇન્સ્પેક્શન રીપોર્ટની વિગતોમાં એકસરખા ફોર્મેટ વિભાગ દ્વારા નિયત કરેલ ન હોવાથી એકસૂત્રતા રહેતી નથી.

મુખ્ય ઇજનેરશ્રીઓની કમિટીમાં નક્કી થયા મુજબ ઇન્સ્પેક્શન રીપોર્ટમાં એકસૂત્રતા રહે અને પી.એમ.જી.એસ.વાય.માં “ગ્રેડ સિસ્ટમ” વાળો રીપોર્ટ સાદર કરવામાં આવે છે એ પદ્ધતિએ ઇન્સ્પેક્શન રીપોર્ટનું ફોર્મેટ બનાવવા જણાવવામાં આવેલ હતું. માર્ગ અને મકાન વિભાગના રસ્તા, પુલ અને મકાન માટેના ગુણવત્તા ચકાસણી કરવા માટેના ઇન્સ્પેક્શન રીપોર્ટના ફોર્મેટ ગ્રેડ સિસ્ટમવાળા આ સાથે તૈયાર કરવામાં આવેલ છે. હવે પછી ગુણવત્તા વિભાગના મુખ્ય ઇજનેરશ્રી, અધિક્ષક ઇજનેરશ્રી, કાર્યપાલક ઇજનેરશ્રી, સંબંધિત અધિક્ષક ઇજનેરશ્રી તથા જે કોઈ પણ અધિકારીશ્રી ગુણવત્તા ચકાસણીની કામગીરી કરે તેમણે આ ફોર્મેટનો ઇન્સ્પેક્શન રીપોર્ટ માટે ઉપયોગ કરવાનો રહેશે.

કામની ચકાસણી કર્યા બાદ કામનો એકંદરે ગ્રેડ “S (Satisfactory), SRI (Satisfactory but require improvement) કે U (Unsatisfactory)” આપવાનો રહેશે.

(૧) જો ગુણવત્તા ચકાસણીમાં કામનો એકંદરે ગ્રેડ “S” મળશે તો એ કામ Satisfactory કક્ષાનું હોય કોઈ પૂર્તતા કરવાની રહેતી નથી.



(ર) જો ગુણવત્તા ચકાસણીમાં કામની એકંદરે ગ્રેડ "SRI" (Satisfactory but require improvement) મળશે તો જે તે આઉટમમાં "SRI U" ગ્રેડ મળેલ છે એ આઉટમની સુધારણા ટેન્ડરમાં જણાવેલ સ્પેશીકીકેશન મુજબ કરી એનો "ATR" (Action Taken Report) સંબંધિત કાર્યપાલક ઇજનેરશ્રીએ તૈયાર કરી જે તે ગુણવત્તા નિયમન વિભાગના કાર્યપાલક ઇજનેરશ્રીની કરીથી સ્થળ મુલાકાત કરાવશે અને ગુણવત્તા નિયમન વિભાગના કાર્યપાલક ઇજનેરશ્રી પૂર્તતા સાથે સહમત હોય તો અહેવાલ અધિક્ષક ઇજનેરશ્રી, ગુણવત્તા નિયમન વિભાગને સાદર કરશે. અધિક્ષક ઇજનેરશ્રી, ગુણવત્તા નિયમન વિભાગ પૂર્તતા અહેવાલ યોગ્ય હશે તો રીગ્રેડ એટલે "SRI U" માંથી "S" માટે ભલામણ કરશે. ત્યારબાદ સદરહુ પૂર્તતા અહેવાલ સંબંધિત અધિક્ષક ઇજનેરશ્રી મારફત સંબંધિત મુખ્ય ઇજનેરશ્રીને સાદર કરવાનો રહેશે. સંબંધિત મુખ્ય ઇજનેરશ્રીએ સદરહુ "ATR" મુખ્ય ઇજનેરશ્રી ગુણવત્તા નિયમન વિભાગને પૂર્તતા ગ્રાહ્ય રાખી "S" ગ્રેડીંગ આપવા માટે ભલામણસહ સાદર કરવાનો રહેશે. ગુણવત્તા નિયમન વિભાગમાંથી પૂર્તતા ગ્રાહ્ય રાખી "S" ગ્રેડીંગનું પ્રમાણપત્ર મુખ્ય બાદ જ આ આઉટમનું બાકીનું ચૂકવણ કરવાનું રહેશે.

(૩) ગુણવત્તા ચકાસણીમાં કામની એકંદરે ગ્રેડ "U" (unsatisfactory) મળશે તો જે તે આઉટમમાં "SRI U" મળેલ છે એ આઉટમમાં સુધારણા અથવા Reconstruction (આઉટમ કરીદો કરવી) ટેન્ડરમાં જણાવેલ સ્પેશીકીકેશન મુજબ કરી એનો "ATR" સંબંધિત કાર્યપાલક ઇજનેરશ્રીએ તૈયાર કરી જે તે ગુણવત્તા નિયમન વિભાગના કાર્યપાલક ઇજનેરશ્રીની કરીથી સ્થળ મુલાકાત કરાવશે અને ગુણવત્તા નિયમન વિભાગના કાર્યપાલક ઇજનેરશ્રી પૂર્તતા સાથે સહમત હોય તો અહેવાલ અધિક્ષક ઇજનેરશ્રી, ગુણવત્તા નિયમન વિભાગને સાદર કરશે. અધિક્ષક ઇજનેરશ્રી, ગુણવત્તા નિયમન વિભાગ પૂર્તતા અહેવાલ યોગ્ય હશે તો રીગ્રેડ એટલે "SRI U" માંથી "S" માટે ભલામણ કરશે. ત્યારબાદ સદરહુ પૂર્તતા અહેવાલ સંબંધિત અધિક્ષક ઇજનેરશ્રી મારફત સંબંધિત મુખ્ય ઇજનેરશ્રીને સાદર કરવાનો રહેશે. સંબંધિત મુખ્ય ઇજનેરશ્રીએ સદરહુ "ATR" મુખ્ય ઇજનેરશ્રી ગુણવત્તા નિયમન વિભાગને પૂર્તતા ગ્રાહ્ય રાખી "S" ગ્રેડીંગ આપવા માટે ભલામણસહ સાદર કરવાનો રહેશે. ગુણવત્તા નિયમન વિભાગમાંથી પૂર્તતા ગ્રાહ્ય રાખી "S" ગ્રેડીંગનું પ્રમાણપત્ર મુખ્ય બાદ જ સમગ્ર કામનું બાકીનું ચૂકવણ કરવાનું રહેશે.

કોન્ટ્રોલન સુચનાની આમલ ધુન્નપણે તત્કાલિક અસરથી કરવાનો રહેશે.

વિ.કે.કે.-

(૧) રસ્તા, પુલ અને મકાનના કામોની ગુણવત્તા

ચકાસણી માટેના નિયત પત્રકો

(૨) એ.ટી.આર.નું નિયત પત્રક

(એન.જી.પરમાર)

બા.સ. કરજ પરના અધિકારી (વિ.યો.)

માર્ગ અને મકાન વિભાગ

ગાંધીનગર

## SPECIFICATIONS OF MATERIALS CONTENTS

General Technical Specification-General-I		M-51. Marble slab	
Standard Technical Specifications		M-52. Granite stone slab	
M-1. Water		M-53. P.V.C. Flooring	
M-2. Lime		M-54. Facing tiles	
M-3. Cement		M-55. White glazed tiles	
M-4. White Cement		M-56. Galvanised iron pipes and fittings.	
M-5. Coloured Cement		M-57. Bid cocks and stop cock	
M-6. Sand		M-58. Gun metal wheel valve	
M-7. Stone dust		M-59. White glazed porcelain wash Basin	
M-8. Stone Grit		M-60. European type water closet	
M-9. Cinder		M-61. Orissa type water closet	
M-10. Lime mortar		M-62. Indian Type water closet	
M-11. Cement mortar		M-63. Glazed earthenware sink	
M-12. Stone coarse for Nominal Mix Concrete		M-64. Glazed earthenware lipped type flat back urinal/ Corner type urinal	
M-13. Black trap or equivalent Hard stone Coarse aggregate for design Mix Concrete		M-65. Low level enamel flushing tank	
M-14. Brick bats aggregates		M-66. Cast iron flushing cistern	
M-15. Bricks		M-67. Flush cock	
M-16. Stone		M-68. Cast iron pipes and fittings	
M-17. Laterite Stone		M-69. Nahni trap	
M-18. Mild Steel Bards		M-70. Gully trap	
M-19. High yield strength steel deformed bars		M-71. Glazed stone ware pipe and fittings.	
M-20. High tensile steel wires		M-72. Wall peg rail	
M-21. Mild steel binding wires		M-73. G.I. Water spout	
M-23. Galvanised iron sheets		M-74. Asbestos cement pipe (A.C. Pipe)	
M-24. G.I. Valleys gutters ridges		M-75. Croydon ball valve	
M-25. Manglore pattern roof tiles		M-76. Bitumen felt for water proofing and damp proofing	
M-26. Shuttering		M-77. Selected Earth	
M-27. Expansion joints. Premoulded filler		M-78. Barbed Wire.	
M-28. Expansion joints copper strips & hold fasts		DETAILED SPECIFICATIONS	
M-29. Teak Wood		Section-4 Excavation	
M-29-A. Non Teak wood		Section-5 Plain R.C.C Work	
M-30. Wooden flush door shutters (Solid Core)		Section-6 Masonry work	
M-31. Aluminum doors windows. hold fasts		Section-7 Rubble Masonry work	
M-32. Rolling shutter		Section-9. Centering and form work	
M-33. Collapsible steel gate		Section-10. Wood work Doors Windows	
M-34. Welded steel wire fabric		Section-11. Steel shutters, Windows, Ventilators	
M-35. Welded steel wire fabric		Section-12. Lab. for fixing fixtures & fastenings	
M-36. Expanded metal sheets		Section-13. Glazing	
M-37. plywood		Section-14. Paving & Floor Finishes	
M-38. Glass		Section-15. Roof Covering	
M-39. Acrylic sheets		Section-16. Ceiling & Lining	
M-40. Particle board		Section-17. Plastering and painting	
M-41. Expanded polystyrene or frames		Section-18. White washing and Distempering	
M-42. Resin bonded fiber glass		Section-19. Painting and polishing	
M-43. Fixtures and fastenings		Section-20. Demolition and Dismantling	
M-44. Paints		Section-21.Repairs to Buildings	
M-45. French Polish		Section-22. Miscellaneous buildings	
M-46. Marble chips for marble mosaic terrazzo		Section-23. Water supply, plumbing and sanitary fittings	
M-47. Flooring tiles		Section-24. Drainage & Sewerage	
M-48.Rough kotah stone		Annexure I Equivalent plain area for uneven surfaces for painting	
M-50. Dholpur stones		Annexure II Schedule of Fixtures & Fastenings for doors, windows, ventilators, Wardrobes and cupboards.	

## GENERAL TECHNICAL SPECIFICATIONS FOR BUILDING WORK

### **GENERAL**

1. In the specifications, "as directed"/"Approved" shall be taken to mean, "as directed"/"approved" by the Engineer-in-charge.
2. Wherever a reference to any Indian Standard appears in the specifications, it shall be taken to mean as a reference to the latest edition of the same in force on the date of agreement.
3. In "Mode of Measurement" in the specifications wherever a dispute arises in the absence of specific mention of a particular point or aspect, the provisions on these particular points, or aspects in the relevant Indian Standards shall be referred to.
4. All measurements and computations, unless otherwise specified, shall be carried out nearest to the following limits:
  - (i) Length, width and depth (height)-----0.01 Meter.
  - (ii) Areas -----0.01 Sq. Mt.
  - (iii) Cubic Contents -----0.01 Cu.Mt.in recording dimensions of work the squence of length,width ad height (depth) or thickness shall be followed.
5. The distance, which constitutes lead, shall be determined along the shortest practical route and not necessarily the route actually taken. The decision of the Engineer-in-charge in this regard shall be taken as final.
6. Where no lead is specified, it shall mean "all leads"
7. Lift shall be measured from plinth level.
8. Upto "floor two level" means actual height of floor (Maxi. 4 M.) upto 3 Mt. above plinth level.
9. Definite particulars covered in the items of work, through not mentioned or elucidated in it, specifications shall be deemed to be included there in.
10. Reference to specifications of materials as made in the detailed specification of the items of work is in the form of a designation containing the number of the specification of the material and prefix 'M' e.g. 'M-5'.
11. Approval to the samples of various materials given by the Engineer-in-charge shall not absolve the contractor from the responsibility of replacing defective material brought on site or materials used in the work found defective at a later date . The contractor shall have no claim to any payment or compensation whatsoever on account of any such materials beings rejected by the Engineer in charge.
12. The contract rate of the item of work shall be for the work completed in all respects.
13. No collection of materials shall be made before it is got approved from the Engineer-in-charge.
14. Collection of approved materials shall be done at site of work in a systematic manner. Materials shall be done at site of work in a systematic manner. Materials shall be stored in such a manner as to prevent damage, deterioration or intrusion of foreign matter and to-ensure the preservation of their quality and fitness for the work.
15. Materials, if and when rejected by the Engineer-in-charge, shall be immediately removed from the site of work.
16. NO materials shall be stored prior to, during and after execution of a structure in such a way as to cause or lead to damage or overloading of the various components of the structure.



17. All works shall be carried out in a workmanlike manners as per the best techniques for the particular item.
18. All tools, templates, machinery and equipment for correct execution of the work as well as for checking lines, levels, alignment of the works during execution shall be kept in sufficient numbers and in good working condition on the site of the work.
19. The mode, procedure and manner of execution shall be such that it does not cause damage or over loading of the various components of the structure during execution or after completion of the structure.
20. Special modes of construction not adopted in general Engineering practice, if proposed to be adopted by the Contractor, shall be considered only if the contractor provides satisfactory evidence that such special mode of construction is safe, sound and helps in speedy construction and completion of work to the required strength and quality. Acceptance of the same by the Engineer-in-Charge shall not, however, absolve the contractor of the responsibility of any adverse effects and consequences of adopting the same in the course of execution of completion of the work.
21. All installations pertaining to water supply and fixtures thereof as well as drainage lines and sanitary fittings shall be deemed to be completed only after giving satisfactory tests by the Contractor.
22. The contractor shall be responsible for observing the rules and regulations imposed under "Minor Minerals Act", and such other laws and rules prescribed by Government from time to time.
23. All necessary safety measures and precaution (including those laid down in the various relevant Indian Standards) shall be taken to ensure the safety of men, materials and machinery on the works as also of the work itself.
24. The testing charges of all materials shall be borne by the Contractor unless recovery at one percent towards testing charges is separately made.
25. Approval to any of the executed items for the work does not in any way relieve the contractor of his responsibility for the correctness, soundness and strength of the structure as per the drawings and specification.

### **SPECIFICATIONS OF MATERIALS**

#### **M-1. Water:**

- 1.1. Water shall not be salty or brackish and shall be clean, reasonably clear and free objectionable quantities of silt and traces of oil and injurious alkalis, salts, organic matter and other deleterious material which will either weaken the mortar or concrete or cause efflorescence or attack the steel in R.C.C Container for transport, storage and handling of water shall be clean. Water shall conform to the standards specified in I.S.456-1978.
- 1.2. If required by the Engineer-in-charge it shall be tested by comparison with distilled water. Comparison shall be made by means of standard cement tests for soundness, time of setting and mortar strength as specified in I.S.269-1976. Any indication of unsoundness, change in time of setting by 30 minutes or more or decrease of more than 10 per cent in strength of mortar prepared with water sample when compared with the results obtained with mortar prepared with distilled water shall be sufficient cause for rejection of water under test.
- 1.3. Water for curing mortar, concrete or masonry should not be too acidic or too alkaline. It shall be free of elements which significantly affect the hydration reaction or otherwise interfere with the hardening of concrete during curing or those which produce objectionable stains or other unsightly deposits on concrete or mortar surfaces.

- 1.4. Hard and bitter water shall not be used for curing.
- 1.5. Portable water will be generally found suitable for curing mortar or concrete.

**M-2. Lime:**

- 2.1. Lime shall be hydraulic lime as per I.S. 712-1973. Necessary test shall be carried out as per I.S. 6932 (Parts I to X), 1973.
- 2.2. The following field tests for limes are to be carried out:
  - (1) A very rough idea can be formed about the type of lime by its visual examination i.e. fat lime bears pure white colour, lime in form of porous lumps of dirty white colour indicates quick lime, and solid lumps are the unburnt lime stone.
  - (2) Acid tests for determining the carbonate content in lime, Excessive amount of impurities and rough determination of class of lime.
- 2.3. Storage shall comply with I.S. 712-1973. The slaked lime, if stored, shall be kept in a weather proof and damp-proof shed with impervious floor and sides to protect it against rain, moisture, weather and extraneous materials mixing with it. All lime that has been damaged in any way shall be rejected and all rejected materials shall be removed from site of work.
- 2.4. Field testing shall be done according to I.S. 1624-1974 to show the acceptability of materials.

**M-3. Cement :**

- 3.1 Cement shall be ordinary Portland slag cement as per I.S. 269-1976 or Portland slag cement as per I.S. 455-1976.

**M-4. White Cement :**

- 4.1 The white cement shall conform to I.S. 80412-E 1978.

**M-5. Coloured Cement:**

- 5.1 Coloured cement shall be with white or gray Portland cement as specified in the item of the work.
- 5.2 The pigments used for coloured cement shall be of approved quality and shall not exceed 10% of cement used in the Mix. The mixture of pigment shall be properly grounded to have a uniform colour and shade. The pigments shall have such properties to provide for durability under exposure to sunlight and weather.
- 5.3 The pigment shall have the property such that it is neither by the cement nor detrimental to it.

**M-6. Sand:**

- 6.1. Sand shall be natural sand, clean, well graded, hard strong durable and gritty particle free from injurious amounts of dust clay, kankar nodules, soft or flaky particles shale, alkali, salts organic matter, loam, mica or another deleterious substance and shall be got approved from the Engineer-in-charge. The sand shall not contain more than 8 percent of silt as determined by field test. If necessary the sand shall be washed to make it clean.

- 6.2. Coarse Sand : The fineness modulus of coarse sand shall not be less than 2.5 and shall not exceed 3.0.

The sieve analysis of coarse shall be as under:

<b>I.S.Sieve</b>	<b>Percentage by weight</b>	<b>I.S.Sieve</b>	<b>Percentage by weight</b>
Designation	Passing Sieve	Designation	Passing Sieve
4.75 mm.	100	600 Micron	30-100
2.36 mm.	90 to 100	300 Micron	5-70
1.18 mm.	70-100	150 Micron	0-50

**6.3 Fine Sand:**The fineness modulus shall not exceed 1.0. The sieve analysis of fine sand shall be as under:

I.S.Sieve	Percentage by weight	I.S.Sieve	Percentage by weight
Designation	Passing Sieve	Designation	Passing Sieve
4.75 mm.	100	600 Micron	40-85
2.36 mm.	100	300 Micron	5-50
1.18 mm.	70-100	150 Micron	0-10

**M-7. Stone Dust :**

**7.1.** This shall be obtained from crushing hard black trap or equivalent. It shall not contain more than 8% of silt as determined by field test with measuring cylinder. The method of determining silt contents by field test is given as under :

**7.2.** A sample of stone dust to be tested shall be placed without drying in 200 mm. measuring cylinder. The quantity of the sample shall be such that it fills the cylinder upto 100 mm. mark. The clean water shall be added upto 150 mm. mark. The mixture shall be stiffed vigorously and the content allowed to settle for 3 hours.

**7.3.** The height of silt visible as settled layer above the stone dust shall be expressed as percentage of the height of the stone dust below. The stone dust containing more than 8% silt shall be washed so as lowering the silt content within the allowable limit.

**7.4.** The fineness modulus of stone dust shall not be less than 1.80.

**M-8. Stone Grit:**

**8.1.** Grit shall consist of crushed or broken stone and be hard strong, dense, durable, clean, of proper gradation and free from skin or coating likely to prevent adhesion of mortar Grit shall generally be cubical in shape and as far as possible flaky elongated pieces shall be avoided. It shall generally comply with the provisions of I.S. 383-1970. Unless special stone of particular quarries is mentioned, grit shall be obtained from the best black trap or equivalent hard stone as approved by the Engineer-in-charge. The grit shall have no deleterious reaction with cement.

**8.2. The grit shall conform to the following gradation as per sieve analysis:**

I.S.Sieve	Percentage by weight	I.S.Sieve	Percentage by weight
Designation	through Sieve	Designation	through Sieve
12.50 mm.	100%	4.75 mm.	0-20%
10.00 mm.	85-100%	2.36 mm.	0-25%

**8.3.** The crushing strength of grit will be such as to allow the concrete in which it is used to be built up to the specified strength of concrete.

**8.4.** The necessary tests for grit shall be carried out as per the requirements of I.S.2386(Parts I to VII) 1963, as per instructions of the Engineer-in-charge. The necessity of test will be decided by the Engineer-in-charge. The necessity of test will be decided by the Engineer-in-charge.

**M-9. Cinder :**

**9.1** Cinder is well burnt furnace residue, which has been fused or sintered into lumps of varying sizes.

**9.2** Cinder aggregates shall be well burnt furnace residue obtained from furnace using coal fuel only. It shall be sound clean free from clay, dirt ash or other deleterious matter.

**9.3 The average grading for cinder aggregates shall be as mentioned below :**

I.S.Sieve	Percentage	I.S.Sieve	Percentage
-----------	------------	-----------	------------

<b>Designation</b>	<b>passing</b>	<b>Designation</b>	<b>passing</b>
20 mm.	100	4.75 mm.	70
10 mm.	86	2.36 mm.	52

**M-10. Lime Mortar :**

**10.1.** Lime shall conform to specification M-2 Water shall conform to specification M-1.

**Sand:** Sand Shall conform to specification M-6.

**10.2. Proportion of Mix :** 10.2.1. Mortar shall consist of such proportions of slaked lime and sand as may be specified in the item. The slaked lime and sand be measured by volume.

**10.3. Preparation of Mortar :**

**10.3.1.** Lime mortar shall be prepared by wet process as per I.S. 1625-1971. Power driven mill shall be used for preparation of lime mortar. The slaked lime shall be placed in the mill in an even layer and ground for the 180 revolutions with a sufficient water. Water shall be added as required during grinding (care being taken not to add more water) that will bring the mixed material to a consistency of stiff paste. Thoroughly wetted sand shall then be added evenly and the mixture ground for another 180 revolutions.

**10.4. Storage :** 10.4.1 Mortar shall always be kept damp, protected from sun and rain till used up, covering it by tarpaulin or open sheds.

**10.5. Use :** 10.5.1 All mortar shall be used as soon as possible after grinding it should be used on the day on which it is prepared. But in no case mortar made earlier than 36 hours shall be permitted for use.

**M-11. Cement Mortar:**

**11.1** Water shall conform to specification M-1. Cement : Cement shall conform to specification M- 3.

**Sand:** Sand shall conform to M-6

**11.2 Preparation of Mix :** 11.2.1 Cement and shall be mixed to specified proportion, sand being measured by measuring boxes. The proportion of cement will be by volume on the basis of 50 kg / Bag of cement being equal to 0.0342 Cu.m. The mortar may be hand mixed or machine mixed as directed.

**11.3 Preparation of mortar :** 11.3.1 In hand mixed mortar cement and sand in the specified proportions shall be thoroughly mixed dry on a clean impervious platform by turning over at least 3 times or more till a homogenous mixture of uniform colour is obtained., Mixing platform shall be so arranged that no delirious extraneous material shall get mixed with mortar or mortar shall be gradually added and thoroughly mixed to form a stiff plastic mass of uniform colour so that each particle of sand shall be completely covered with a film of wet cement. The water cement ratio shall be adopted as directed.

**11.3.2** The mortar so prepared shall be used within 30 minutes of adding water Only such quantity of mortar shall be prepared as can be used within 30 minutes.

**M-12 Stone Coarse Aggregate For nominal Mix Concrete :**

**12.1** Coarse aggregate shall be machine crushed stone of black trap or equivalent and be hard, strong m dense, durable clean and free from skin and coating likely to prevent proper adhesion for mortar.

**12.2** The aggregate shall generally be cubical in shape. Unless special stones of particular quarries are mentioned aggregates shall be machine crushed from the best black trap or equivalent hard stone as approved. Aggregate shall have no deleterious reaction with cement. The size of the coarse aggregate for plain cement concrete and ordinary reinforced cement concrete shall generally be as per the table given below. However in case of reinforced cement concrete the

maximum limit may be restricted to 6 mm. less than the minimum lateral clear distance between bars or 6 mm. less than the cover, Whichever is smaller.

**TABLE**

I.s.sieve	percentage passing for single sized aggregates of nominal size			I.S.Sieve Designation sized	Percentage passing for single aggregates of Nominal size		
80 mm.	--	--	--	12.5 mm.	--	--	--
63 mm.	100	--	--	10 mm.	0.5	0.02	0.30
40 mm.	85-100	100	--	4.75 mm	--	0.5	0.5
20 mm.	0-20	85-100	100 mm.	2.35	--	--	--
16 mm.	--	--	85-100				

**NOTE:** This percentage may be carried some what by Engineer-in-charge when considered necessary for obtaining better density and strength of concrete.

**12.3.** The grading test shall be taken in the beginning and at the change of source of materials. The necessary test indicated in I.S. 383-1970 and I.S. 456-1978 shall have to be carried out to ensure the acceptability. The aggregates shall be stores separately and handled in such a manner as to prevent the intermixing of different aggregates. If the aggregates. are covered with dust, they shall be washed with water to make them clean.

**M-13. Black Trap or Equivalent Hard Stone Coarse :**

**13.1** Aggregate For Design Mix Concrete :Coarse aggregate shall be of machine crushed stone of black trap or equivalent hard stone and be hard strong dense, durable clean and free skin and coating likely to prevent proper adhesion of mortar.

**13.2** The aggregates shall generally be cubical in shape. Unless special stones of particular quarries are mentioned, aggregates shall be machine crushed from the best, black trap or equivalent hard stones as approved. Aggregate shall have no deleterious reaction with cement.

**13.3** The necessary tests indicated in I.S. 383-1970 and I.S. 456-1978 shall have to be carried out to ensure the acceptability of the material.

**13.4** If aggregate is covered with dust it shall be washed with water to make it clean.

**M-14. Brick Bats Aggregate :**

**14.1** Brick bat aggregate shall be broken from well burnt or slightly over burnt and dies brick. It shall be homogeneous in texture roughly cubical shape, clean and free from dirt of any other foreign material. The brick bats shall be of 40 mm. to 50 mm. size unless otherwise specified in the item. The unburnt or over burnt brick bats shall not be allowed.

**14.2** The brick bats shall be measured by volume by suitable boxes or as directed.

**M-15 Bricks :**

**15.1** The bricks shall be hand or machine molded and made from suitable soils and kiln-burnt. They shall be free from crack and nodules of free lime. They shall have smooth rectangular faces with sharp corers and shall be of uniform colour.

The bricks shall be molded with a frog of 100 mm. X 40 mm. and 10 mm. to 20 mm. deep on one of its flat sides. The bricks shall not break when thrown on the ground from a height of 600 mm.

**15.2** The size of modular bricks shall be 190 mm. X 90 mm. X 90 mm.

**15.3** The size of the conventional bricks shall be as under : (9"x4 $\frac{3}{8}$ " x 2 $\frac{3}{4}$ ") 225 x 110 x 75 mm.

**15.4** Only bricks of one standard size shall be used on one work. The following tolerances shall be permitted in the conventional size adopted in a particular work.

Length : 1.8 (3.0 mm.) Width : 1/6 " (1.51 mm.) Height : 1/6" 1.50 mm.)

**15.5** The crushing strength of the bricks shall not be less than 35 Kg./Sq.Cm. The average water absorption shall not be more than 20 percent by weight. Necessary tests for crushing strength and water absorption etc. shall be carried out as per I.S. 3493 (Part-I to IV) 1976.

**M-16 Stone :**

**16.1** The stone shall be of the specified variety such as Granite/Trap Stone. Quartzite or any other type of good hard stones. The stones shall be obtained only from the approved quarry and shall be hard, sound, durable and free from defects like cavities, cracks, sand holes, flaws, injurious veins, patches of loose or soft materials etc. and weathered portions and other structural defects or imperfections tending to affect their soundness and strength. The stone with round surface shall not be used. The percentage of water absorption shall not be more than 5% of dry weight, When tested in accordance with I.S. 1134-1974. The minimum crushing strength of the stone shall be 200 kg./Sq. Cm. unless otherwise specified.

**16.2** The samples of the stone to be used shall be got approved before the work is started.

**16.3** The Khanki facing stone shall be dressed by chisel as specified in the item for khanki facing in required shape and size. The face of stone shall be so dressed that the bushing on the exposed face shall not project by more than 40 mm. from the general wall surface and on face to be plastered it shall not project by more than 19 mm. nor shall it have depressions more than 10 mm. from the average wall surface.

**M-17. Laterite Stone :**

**17.1** Laterite stone shall be obtained from the approved quarry. It shall be compacted in texture, sound, durable and free from soft patches. It shall have a minimum crushing strength of 100 K.G/S.q. Cm. in its dry condition. It shall not absorb water more than 20% of its own weight, When immersed for 24 hours in water. After quarrying the stone shall be allowed to weather for some time before using in work.

**17.2** The stone shall be dressed into regular rectangular blocks so that all faces are free from waviness and unevenness, edges true and square.

**17.3** Those types of stone in which white clay occur, should not be used.

**17.4** special corner stones shall be provided where so directed.

**M-18. Mild Steel Bars :**

**18.1** Mild steel bars reinforcement for R.C.C work shall conform to I.S. 432(Part-II) 1966 and shall be tested quality. It shall also comply with relevant part of I.S. 456-1978.

**18.2** All the reinforcement shall be clean and free from dirt, paint, grease, mill scale or loose or thick rust at the time of placing.

**18.3** For the purpose of payment, the bar shall be measured correct upto 100 mm. length and weight payable worked out at the rate specified below :

1. 6mm. x 0.22 Kg./Rmt	8. 20mm. 2.47 Kg./Rmt
2. 8mm. x 0.39 Kg./Rmt.	9. 22mm. 2.98 Kg./Rmt
3. 10mm x 0.62 Kg./Rmt	10. 25mm. 3.85 Kg./Rmt

- |    |                     |     |                    |
|----|---------------------|-----|--------------------|
| 4. | 12mm x 0.89 Kg./Rmt | 11. | 28mm. 4.83 Kg./Rmt |
| 5. | 14mm x 1.21 Kg./Rmt | 12. | 32mm. 6.31 Kg./Rmt |
| 6. | 16mm x 1.58 Kg./Rmt | 13. | 36mm. 7.99 Kg./Rmt |
| 7. | 18mm x 3.00 Kg./Rmt | 14. | 40mm 9.86 Kg./Rmt. |

**M-19. High yield Strength Steel Deformed Bars :**

- 19.1** High yield strength steel deformed bars are either cold twisted or hot rolled, shall conform to I.S. 1739-1966 and I.S.1139-1966 respectively.
- 19.2** Other provision and requirements shall conform to specification NO. M-18 for Mild steel bars.

**M-20. High Tensile Steel Wire:**

- 20.1** The high tensile wires for the use in prestressed concrete work shall conform to I.S. 2090-1962.
- 20.2** The tensile strength of the high tensile steel bars shall be as specified in the item. In absence of the given strength, the minimum strength shall be taken as per Para 6.1 of I.S. 1785-1962. Testing shall be done as per I.S. requirements.
- 20.3** The high tensile steel shall be free from loose mill scale, rust oil, grease, or any other harmful matter, Cleaning of steel bars may be carried out by immersion in solvent solution, wire brushing or passing through a pressure box containing carborundum.
- 20.4** The high tensile wire shall be obtained from manufactures in coil having diameter not less than 350 times the diameter of wire itself so that wire springs back straight back straight on being uncoiled.

**M-21. Mild Steel Binding Wire :**

- 21.1.** The mild steel wire shall be of 1.63 mm or 1.22 mm. (16 or 18 gauge) diameter and shall conform to I.S. 280-1972.
- 21.2.** The use of black wire be permitted for binding reinforcement bars. It shall be free from rust, Oil paint, grease, looser mile scale or any other undesirable coating which may prevent adhesion of cement mortar.

**M-22. Structural Steel :**

- 22.1.** All structural steel shall conform to I.S. 226-1965. The steel shall be free from the defects mentioned in I.S. 226-1975 and shall have a smooth finish. The material shall have a smooth finish. The material shall be free from loose mile scale, rust pits or other defects affecting the strength and durability. Rivet bars shall conform to I.S. 1148-1973.
- 22.2.** When the steel is supplied by the Contractor test certificates of the manufactures shall be obtained according to I.S. 226-1975 and other relevant Indian Standards.

**M-23. Galvanized Iron Sheets :**

- 23.1** The galvanised iron sheets shall be plain or corrugated sheets of specified in item. The G.I. sheets shall conform it I.S. 217-1977. The sheets shall be undamaged in carriage and handling either by rubbing off of zinc coating or otherwise they shall have clean and bright surface and shall be free from dents,holes,rust or white powdery deposit.
- 23.2** The length and width of G.I. sheet shall be as directed as per site condition.

**M-23 (A) G.I Valleys gutter ridges :**

- 23.A.1.**The G.I.ridges and hips shall be of plain galvanised sheets class-3 of the thickness as specified in item. These shall be 600 mm. in width and properly bent up to shape without damage to the sheets in process of bending.
- 23.A.2.**Valleys gutters and flashings shall also be galvanised sheet of thickness as specified in item. Valleys shall be 900 mm. Wide overall and flashing shall be 380 mm. wide overall. They shall be bent to the required shape without damage to the sheet in the process of bending.



**M-24. Asbestos Cement Sheets :**

**24.1.** Asbestos cement sheets plain, corrugated or semi corrugated shall conform to I.S. 459-1970. The thickness of the shall be as specified in the item. the sheet shall be free from all defects such as cracks, holes deformities, chipped edges or otherwise damaged.

**24.2. Ridges & Hips :**

**24.2.1** Ridges and hips shall be same thickness at that of A.C.sheets. The types of ridges suitable for the type of sheets and locations.

**24.2.2** Other accessories to be used in roof such as flashing pieces, caves filler pieces valley gutters, north light and ventilator curves, barge boards etc. shall be standard manufacture and shall be suitable for the type of sheets and location.

**M-25. Manglore Pattern Roof Tiles :**

**25.1** The manglore pattern tiles shall conform to I.S. 654-1972 for Class AA or Class "A" type as specified in item. Samples of the tiles to be provided shall be got approved from the Engineer-in-charge. Necessary tests shall be carried out as directed.

**M-26. Shuttering :**

**26.1.** The shuttering shall be either of widen planking of 30 mm. minimum thickness with or without steel lining roof steel plates stiffened by steel angles. The shuttering shall be supported on battens and beams and props of vertical ballies properly cross braced together so as to make the centering rigid. In places of bully props, brick pillar of adequate section built in mud mortar may be used.

**26.2.** The form work shall be sufficiently strong and shall have camber, so that it assumes correct shape after deposition of the concrete and shall be able to resist forces caused by vibration of live load of men working over it and other incidental loads associated with it. The shuttering shall have smooth and even surface and its joints shall not permit leakage of cement grout.

**26.3.** If at any stag of work during or after placing concrete in the structure, the form work sags or bulges out beyond the required shape of the structure, the concrete shall be removed and work redone with fresh concrete and adequately rigid form work. The complete from work shall be got inspected by and got approved from the engineer-in-charge, before the reinforcement bars are placed in position.

**26.4.** The props shall consist of bullies having 100 mm. minimum diameter measured at mix length and 80 mm, at thin end and shall be placed as per design requirement. These shall rest squarely on wooden sole plates 40 mm. thick and minimum bearing area if 0-10 sq. m. laid on sufficiently hard base.

**26.5.** Double wedges shall further be provided between the sole plate and the wooden props so as to facilitate tightening and easing of shuttering without jerking the concrete.

**26.6.** The timber used in shuttering shall not be so dry as to absorb water from concrete and swell or bulge nor so green or wet as to shrink after erection. The timber shall be properly sawn and planed on the sides and surface coming in contact with concrete. Wooden from work with metal sheet lining or steel plates stiffened by steel angles shall be permitted.

**26.7.** As far as practicable, clamps shall be used to hold the forms together and use of nails and spikes avoided.

**26.8.** The surface of timber shuttering that would come in contact with concrete shall be well wetted and coated with soap solutions before the concreting is done. Alternatively coat of raw linseed oil or oil of approved manufacturer may be applied in place of soap solution. In case of steel shuttering either soap



solution or raw linseed oil shall be applied after thoroughly cleaning the surface. Under no circumstances black or burnt oil shall be permitted.

- 26.9. The shuttering for beams and slabs shall have camber of 4 mm. per meter (1 to 250) or as directed by the Engineer-in-charge so as to offset the subsequent deflection. For cantilevers, The camber at free end shall be 1/50 of the projected length or as directed by the Engineer-in-charge.

**M-27. Expansion joints-Premoulded filter :**

- 27.1 The item provides for expansion joints in R.C.C frame structures for internal joints, as well as exposed joints, with the use of premoulded bituminous joint filler.

27.2 Premoulded bituminous joint filler, i.e. performed strip of expansion joint filler shall not get deformed or broken by twisting, bending or other handling when exposed to atmospheric condition. Pieces of joint filler that have been damaged shall be rejected.

27.3 Thickness of the pre-molded joint filler shall otherwise specified.

27.4 Premoulded bituminous joint filler shall conform to I.S. 1838-1961.

**M-28 Expansion joints-Copper strips & hold fasts :**

- 28.1 The item provide for expansion joints in R.C.C frame structure for internal joints as well as for exposed joints with the use of necessary copper strip and hold fasts.

28.2 Copper sheet shall be of 1.25 mm. thick and of 1.25 mm. width when the 'U' shape in middle. Copper strips shall have hold fast of 3 mm. diameter copper rod fixed to the plate soldered on strip at intervals of about 30 cm. or as shown in the drawing or as directed. The width of each flange (horizontal side) of the copper plate to be embedded in the concrete work shall be 25 mm. Depth of 'U' to be provide in the expansion joint, in the copper plate shall be of 25 mm.

**M-29. Teak wood :**

- 29.1 The teak wood shall be of good quality as required for the item to be executed. When the kind of wood is not specifically mentioned, good Indian teak wood as approved shall be used.

29.2 Teak wood shall generally be free from large, loose, dead or cluster knots, flaws, shakes, warps, twists bends or any other defects. It shall generally be uniform in substance and of straight fibres as far as possible. It shall be free from rot, decay, harmful fungi and other defects of harmful nature which will affect the strength durability of its usefulness for the purpose for which it is required. The colour shall be uniform as far as possible. Any effort like painting, using any adhesive or resins materials made to hide the defects shall render the pieces liable to rejection by the Engineer-in-charge.

29.3 All scantlings, planks etc. shall be sawn in straight lines and planes in the direction of grains and of uniform thickness.

29.4 The tolerances in the dimensions shall be allowed at the rate of 1.5 m.m. per face to be planed.

29.5 **First class teak wood : 29.5.1.** First class teak wood shall have no individual hard and sound knots, more than 6 sq. cm. size and the aggregate area of such knots shall not be more than 1% of area of piece. The timber shall be closed grained.

29.6 **Second Class Teak Wood : 29.6.1.** No individual hard and sound knots shall be more than 15 Sq. cms. in size and aggregate area of such knots shall not-exceed 2% of the area of piece.

**M-29. (A) Non-teak wood :**

The non teak-wood shall be chemically treated, seasoned as per IS Specifications and of good quality. The type of wood shall be got approved

before collecting the same on site. Fabrication of wooden members shall be started only after approval.

For this purpose wood of Bio, Kalali, Siras, Behda, Jamun, Sisoo will be used for door frames where as only Kalali, Siras, Halda, Kalam etc. will be permitted for shutters after proper seasoning and chemical treatment.

The non-teak wood shall be free from large, loose, dead or cluster knots, flows, shakes warps bends or any other defect. It shall be uniform in substance and of straight fibers as far as possible. It shall be free from decay harmful fungi and other defects of nature which effect the strength, durability or its usefulness for the purpose for which it is required. The colour of wood shall be uniform as far as possible. The scantlings planks etc. shall be sawn in straight lines and planes in the direction of grain and uniform thickness.

The department will use the Agency to produce certificate from forest Department in event of Disputes and the decision of the Department shall be final and binding to the contractor.

The tolerance in the dimension shall be allowed as 1.5 mm. per face to be planed.

**M-30. Wooden flush door shutters (solid core) :**

**30.1** The solid core type flush door shutters shall be decorative or non-decorative type as specified in the drawing. The size and thickness of the shutter shall be as specified in drawings or as directed. The timber species for core shall be used as per I.S. 2202- (Part-I) 1980. The timber shall be free from decay and insect attack. Knots and knot holes less than half the width of cross-section of the members in which they occur may be permitted. Pitch pockets, Pitch streaks and harmless pin holes shall be permissible except in the exposed edges of the core members. The commercial plywood, cross-bands shall conform to I.S. 303-1275.

**30.2** The face panel of the shutters shall be formed by gluing by the hot press process on both faces of the core with either plywood or cross-bands and face veneers. The hopping rebating opening of glazing, Venetian etc. shall be provided if specified in the drawing.

**30.3** All edges of the door shutters shall be square. The shutters shall be free twist or warp in its plane. Both faces of the shutters shall be sand papered to smooth even texture.

**30.4** The shutters shall be tested for

(1) **End immersion test :** The test shall be carried out as per I.S. 2202 (part-I) 1980. There shall be no delamination at the end of the test.

(2) **Knife test :** The face panel when tested in accordance with I.S. 1659-1979 shall pass the test.

(3) **Glue adhesion Test :** The flush door shall be tested for glue adhesive test in accordance with I.S. 2202 (Part-I) 1980. The shutters shall be considered to have passed the test if no delamination occurs in the glue lines in the plywood and if no single declamination more than 80 mm. in length and more than 3 mm. in depth has occurred in the assembly glue lines between the plywood face and the style and rail. Delamination at the corner shall be measured continuously around the corner. Delamination at the knots, knots holes and other permissible wood defects shall not be considered in assessing the sample.

**30.5** The tolerance in size of solid core type flush door shall be as under :  
In Normal thickness +/- 1.2 mm. In Normal height +/- 3 mm.

**30.6** The thick of the shutters shall be uniform throughout with a permissible variation of not more than 0.8 mm. when measured at any two points.

**M-31. Aluminum doors, Windows, Ventilators.**

**31.1** Aluminum alloy used in the manufacture of extruded window sections shall conform to I.S. designation HEA-WP of I.S. :733-1975 and also to I.S. Designation WVG-WP of I.S. 1285-1975. The Section shall be as specified in the drawing and design. The fabrication shall be done as directed.

**31.2** The hinges shall be cast or extruded aluminum hinges of same type as in windows but of large size.

**31.3** The hinges shall normal be of 50 mm. projecting type. Non-projecting type of hinges may also be used if directed. The handles of door shall be of specified in the drawing and design. A suitable lock for the operatable either from outside or inside shall be provided. in double shutter door the first closing shutter have concealed aluminum alloy bolt at top and bottom The fabrication shall be done as directed.

**M-32. Rolling Shutters :**

**32.1** The rolling shutter shall conform to I.S. 6248-1979. Rolling shutters shall be supplied of specified type with accessories. The size of the rolling shutters shall be specified in the drawings. The shutters shall be constructed with interlocking lath sections formed from cold rolled steel strips not less than 0.9 mm. thick and 80 mm. wide for shutters upto 3.5 mm., width not less than 1.25 mm. thick and 80 mm. wide for shutters 3.5 mm in width and above unless otherwise specified.

**32.2** Guide channels shall be of mild steel deep channel section and of rolled pressed or built up (fabricated) jointures construction. The thickness of sheet used shall not be less than 3.15 mm.

**32.3** Hood covers shall be made of M.S. Sheets not less that 0.92 mm. thickness For shutters having width 3.5 Meter and above the thickness of M.S. Sheet for the hood cover shall be not less than 1.25 mm.

**32.4** The spring shall be of best quality and shall be manufactured from tested high tensile spring steel wire or strip of adequate strength to balance the shutters in all position. The spring pipe shaft etc. shall be supported on strong M.S. or malleable C.I. brackets. The brackets shall be fixed on or under the lintel as specified with raw plugs and screws bolts etc.

**32.5** The rolling shutters shall be of self rolling type up to 8 Sq.m. clear area without ball bearing and p to 12 Sq.m. clear area with ball bearing. If the rolling shutters are larger, then gear operated type shutters shall be used.

**32.6** The locking arrangement shall be provided at the bottom of shutter at both ends. The shutters shall be opened from outside.

**32.7** The shutters shall be completed with door suspension shafts, locking arrangements pulling hooks, handles and other accessories.

**M-33. Collapsible Steel Gate :**

**33.1** The collapsible steel gate shall be in one or two leaves and size as per approved drawings or as specified. The gate, shall be fabricated from best-quality mild steel channels, flats etc. Either steel pulleys or ball bearing shall be provided in every double channel. Unless otherwise specified the particulars of collapsible gate shall be as under :

(a) Pickets : These shall be of 20 mm. M.S., channels of heavy sections unless otherwise shown on drawings. The distance center to center of pickets shall be 12 cms. with an opening of 10 Cms.

(b) Pivoted M.S. flats shall be 20 mm x 6 mm.

(c) Top and bottom guides shall be from tee or flat iron of approved size.

(d) The fittings like stoppers, fixing hold fasts, locking cleats, brass handles and cast iron rollers shall be of approved design and size.

**M-34. Welded Steel Wire Fabric :**

**34.1.** Welded steel wire fabric for general purpose shall be manufactures from cold drawn steel wire “as drawn” or galvanised steel conforming to I.S. 226-1975 with longitudinal and transverse wire securw4ely connected at every intersection by a process of electrical resistance welding and conforming to I.S. 4948-1974. It shall be fabricated and finished in workmanlike manner and shall be free from injurious defects and shall be rust proof. The type of mesh shall be oblong or square as directed. The mesh sizes and size of wire for square as well as oblong welded steel wire fabric shall be as directed. The steel wire fabric in panels shall be in one whole piece in each panel as far as stock size permit.

**M-35. Expanded Metal Sheets :**

**35.1.** The expanded metal sheets shall be free from flaws, joints, broken strands, laminations and other harmful surface Expanded metal steel sheet shall conform to I.S. 412-1975, Except that blank sheets need not be with guaranteed mechanical properties. The size of the diamond mesh of expended metal and dimensions of strands (width and thickness) shall be as specified. The tolerance in nominal weight of expended metal sheets shall be of +/- 10 percent.

**35.2.** Expanded metal in panels shall be in one whole piece panel each as far as stock size permit. The expanded metal sheets shall be coated with suitable protective coating to prevent corrosion.

**M-36. Mild Steel Wire (Wire ) :**

**36.1** Mild steel wire may be galvanised, as indicated All finished steel wire shall be well cleanly drawn to the dimensions and size of wire as specified in item. The wire shall be sound, free from splits, surface flaws, rough jagged and imperfect edges and other harmful surface defects and shall conform to I.S. 280-1978.

**M-37. Plywood :**

**37.1** The plywood for general purpose shall conform I.S. 303-1975. Plywood is made by cementing together thin boards or sheets of wood into panels. There are always an odd number of layers 3,5,7,9 ply etc. The plies are placed so that grain of each layer is right angle to the grain in the adjacent layer.

**37.2** The Chief advantages of plywood over a signal board of the same thickness is the more uniform strength of the plywood, along the length and width of the plywood and grater resistance to cracking and splitting with change in moisture content.

**37.3** Usually synthetic resins are used for gluing, pherolic resins are usually cured in a hot press which compresses and simultaneously heats the plies between hot plates which maintain a temperature of 90 degrees C. to 140 degrees C. and a pressure of 11 to 14 kg/sq.cm. on the wood. The time of heating may be anything from 2 to 69 minutes depending upon thickness.

**37.4** When water glue are used , the wood absorbs so much water that the finished plywood must be dried carefully. When synthetic resins are used as adhesive finished by plywood must be exposed to an atmosphere of controlled humidity until the proper amount of moisture has been absorbed.

**37.5** According to I.S. 303-1975 the plywood for general purpose shall be of three grades **BWR**, **WWR** and **CWR**, depending upon the adhesives used for bonding and veneers, and it will be further classified into six types namely AA,AB,AC,BB,BC and CC based on the quality of the two faces, each face being of three kinds namely, A,B and C, After pressing, the finished plywood

should be reconditioned to a moisture content not less than 8 percent and not more than 16 percent.

**37.6 Thickness of plywood Boards :**

**TABLE**

Board	Thickness	Board	Thickness	Board	Thickness	Board	Thickness
3 ply	3 mm.	5 ply	5 mm.	7 ply.	9 mm.	9 ply.	16 mm.
	4 mm.		6 mm.		13 mm.		19 mm.
	5 mm.		8 mm.		16 mm.	11 ply.	19 mm.
	6 mm.		9 mm.	9 ply.	13 mm.		22 mm.
							25 mm.

**M-38. Glass :**

**38.1** All glass shall be of the best quality free from specks, bubbles, smokes, veins, air holes blisters and other defects. The kind of glass to be used shall be mentioned in the item or specification or in the special provisions or as shown in detailed drawings. Thickness of glass panes shall be uniform. The specifications or different kinds of glass shall be as under.

**38.2 Sheet Glass :**

**38.2.1** In absence of any specified thickness or weight in the item or detailed specifications of the item of work, sheet glass shall be weighing 7.5 Kg/Sq.m. for panes upto 600 mm x 600 mm.

**38.2.2** For panes larger than 600 mm. x 600 mm. and upto 800 m. x 800 mm. the glass weighing not less than 8.75 Kg/Sq.m. shall be used. For bigger panes upto 900 mm. x 900 mm. glass weighing not less than 11.25 Kg/Sq.m. shall be used.

**38.2.3** Sheet glass shall be patent flattened glass of best quality and for glazing and framing purposes shall conform to I.S. : 1761-1960. Sheet glass of the specified colours shall be used, if so shown on detailed drawings or so specified. For important buildings and for panes with any dimension over 900 mm. plate glass of specified thickness shall be used.

**38.3. Plate Glass. 38.3.1.** When plate glass is specified it shall be 'Polished patent plate glass' of best quality. It shall have both the surface ground flat and parallel and polished to obtain clear undisturbed vision and reflection. The plate glass shall be of the thickness mentioned in the item or as shown in the detailed drawing or as specified. In absence of any specified thickness the thickness of plate glass to be supplied shall be 6mm and a tolerance of 0.20mm shall be admissible.

**38.4 Obscured Glass : 38.4.1.** This type of glass transmits light so that vision is Partially or almost completely obscured. Glass shall be plain rolled, figured, ribbed or fluted or frosted glass as may be specified as required. The thickness and type of glass shall be as per details on drawings or as specified or as directed.

**38.5. Wired Glass : 38.5.1** Glass shall be with wire netting embedded in a sheet of plate glass electrically welded 13 mm. Georgian square mesh may be used. Thickness of glass shall not be less than 6 mm. Wired glass shall be of type and thickness as specified.

**M-39. Acrylic Sheets :**

**39.1.** Acrylic sheet be of thickness as specified in the item and of an specified shape and size as the case may be. Panels may be flat or curved . It should be light in weight. It shall be colourless or coloured or opaque as specified in the item. Colourless sheet shall be as transparent as the finest optical glass. Its light transmission rate shall be about 95%. Transparency shall not be affected for the sheets of larger thickness. It shall be extremely resistant to sunlight,

weather and low temperatures. It shall not show any significant yellowing or change in physical properties or loss of light transmission over a longer period of use. The sheet shall be impact resistant also. Sheets should be available in complete range of standard transparent, translucent and opaque colours. Sheets shall be of such quality that they can be cut bent and jointed as desired. Solution for the joints shall be used as per the requirement of manufacturer.

**M-40. Particle board :**

**40.1.** The particle boards used for face panels shall be of best quality free from any defects. The particle boards shall be made with phenolmaldehyde adhesive. The particle boards shall conform to I.S. 3087-1965. "Specification for wood particle board for general purpose". The size and the thickness shall be as indicated.

**M-41. Expanded polystyrene of framed stopper slabs :**

**41.1** The expanded polystyrene ceiling boards and tiles shall be approved make and shall be of size, thickness, finish and colour as indicated. It shall be of high density and suitable for use as insulating material. The insulating material shall be like slab of Thermocol etc.

**M-42. Resin bonded fiber glass :**

**42.1** The resin bonded fiber glass tiles, or rolls shall be of approved make and shall be of sizes, thickness and finish as indicated.

**42.2.** For test of Minerrak wool thermal insulation Blanket I.S. : 3144?1965 shall be followed.

**42.3.** Insulation wool blanket shall be with following coverings on one or both sides as indicated.

(1) Bituminised hessian Kraft paper suitable for use in position where moisture has to be excluded.

(2) Hessian cloth or Kraft paper for keeping out dust.

(3) G.I. wire netting, suitable for surface to be plastered over.

**M-43. Fixtures and fastenings :**

**43.1. General**

**43.1.1** The fixtures and fastenings, that is, butt, hinges, tee and strap hinges sliding door bolts, tower bolts, door latch, bath room latch, handles, door stoppers, casement window fasteners, casement stays and ventilators catch shall be made of the metal as specified in the item or its specifications.

**43.1.2** They shall be of iron, brass, aluminum, chromium plated iron chromium plated brass, copper oxidised iron, copper oxidised brass or anodized aluminum as specified.

**43.1.3** The fixtures shall be heavy, Medium or light type. The fixtures and fastenings shall be smooth finished and shall be such as will ensure ease of operation.

**43.1.4** The samples of fixtures and fastenings shall be got approved as regards quality and shape before providing them in position.

**43.1.5** Brass and anodised aluminum fixtures and fastenings shall be bright finished.

**43.2. Holdfasts :**

**43.2.1.** Holdfasts shall be made from mild steel flat 30 cm. length and one of the holdfasts shall be bent at right angle and two nos. of 6 mm. diameter holes shall be made in it for fixing it to the frame with screws. At the other end. The holdfast shall be forked and bent at right angles in opposite directions.

**43.3. Butt hinges :**

**43.3.1.** Railway standard heavy type butt hinges shall be used when so specified.

**43.3.2.** The strap hinges shall be manufactured from M. S. Sheet.

**43.4 Siding door bold (Aldrops):** 43 The Aldrops as specified in the item shall be used and shall be got approved.



- 43.5 Tower bolts (Barrel Type):**43.5.1 : Tower bolts as specified in the item shall be used as shall be used and shall be got approved.
- 43.6 Door Latch:**43.7.1 The size of door latch shall be taken as the length of latch.
- 43.7 Bathroom Latch :**43.5.1 Bathroom latch shall be similar to tower bolt.
- 43.8 Handle :** The size of the handles shall be determined by the inside grip length of the handles. Handles shall have a base plate of length 50 mm more than size of the handle.
- 43.9 Door Stopper:** 43.9.1 door stoppers shall be either floor door stopper type or door catch type floor stopper shall be of overall size as specified as shall have rubber cushion.
- 43.10 Door Catch :**43.10.1 Door catch shall be fixed as height of about 900 mm from the floor level so that one part of the catch is fitted on the inside of the shutter and the other part is fixed in the wall with necessary wooden plug arrangements for appropriate fixate. The catch shall be fixed 20 mimesed the face of the door for easy operation of catch.
- 43.11 Wooden Door stop with highs :**
- 43.11.1**wooden door stop of size 100mm X 60 mm X 40 mm shall be fixed on the door frame with a high of 75 mm size at high of 900 mm from the floor level the wooden door stop shall be provided with 3 coats of approve oil paint.
- 43.12 Case meant window fastener :** Casement window fastener for single leaf window shutter shall be left or right handled as directed.
- 43.13 Casement stays (straight peg stay) :**
- 43.13.1**The stays shall be made from a channel section having three holes at appropriate position so that the window can be opened either fully or partially as directed as directed. size of the stay shall be 250 mm to 300 mm as directed.
- 43.14 Ventilator catch :**
- 43.14.1**The pattern and shape of the catch shall be as approved .
- 43.15 Pivot :**
- 43.15.1**The base and socket plate shall be made form minimum 3 mm thick plate and projected pivot shall not be less than 12 mm length and shall be firmly riveted to the base plate in case of brass pivot.
- M-44. Paints :**
- 44.1 (A) Oil Paints :**
- 44.1.1.** Oil Paints shall be of the specified colour and shade, and as approved. The ready mixed paints shall only be used. However, if ready mixed paint or specific shade or tint is not available, white ready mixed paint with approved stainer will be allowed. In such a case, the contractor shall ensure that the shade of the paint so allowed shall be uniform.
- 44.1.2.** All the paints shall meet following general requirements :
- (i) Paint shall not show excessive setting in a freshly opened full can and shall easily be redispersed with a paddle to a smooth homogeneous state. The paint shall show no curing, livering, caking or colour separation and shall be free from lumps and skins.
  - (ii) The paint as received shall brush easily, possess good levelling properties and show no running or sagging tendencies.
  - (iii) The paint shall not skin within 48 hours in a three quarters filled closed container.
  - (iv) The paint shall dry to a smooth uniform finish free from roughness, grit, unevenness and other imperfections.
- 44.1.3.** Ready mixed paint shall be used exactly as received from the manufactures and generally according to their instructions and without any admixtures whatsoever.

**44.2. (B) Enamel Paints :**

**44.2.1.** The enamel paint shall satisfy in general requirements as mentioned in specification of oil paints. Enamel paint shall conform to I.S. 2933-1975.

**M-45 French polish :**

**45.1.** The french polish of requirement and shape shall be prepared with the below mentioned ingredients and other necessary materials:

(I) Denatured sprit of approved quality (ii) Chandras (iii) Shellac (iv) Pigment.

**45.2.** The French polish so prepared shall conform to I.S. : 348-1968.

**M-46 Marble chips for marble mosaic terrazzo :**

**46.1.** The marble chips shall be of approved quality and shades. It shall be hard, sound, dense and homogenous in texture with crystalline and coarse grains. It shall be uniform in colour and free from stains, cracks decay and weathering.

**46.2.** The size of various colours of marble chips ranging form the smallest up to 20mm shall be used where the thickness of top wearing layer is 6mm size. the marble chips of approved quality and colours only as per grading as decided by the Engineer-in-charge shall be used for marble mosaic tiles or works.

**46.3.** The marble chips shall be machine crushed. They shall be free from foreign matter, dust etc. Except as above, the chips shall conform to I.S. : 2114-1962.

**M-47. Flooring Tiles :**

**47.1. (A) Plain Cement tiles :**

**47.1.1.** The plain cement tiles shall be general purpose type. These are the tiles in the manufacturer of which no pigments are used Cement used in the manufacturer of tiles shall be as per Indian Standards.

**47.1.2.** The tiles shall be manufactured from a mixture of cement and natural aggregates by pressure process. During manufacture, the tiles shall be subjected to a pressure of not less than 140 Kg/Sq. Cm. The proportion of cement to aggregate in the backing of the tiles shall be not less than 1:3 by weight. The wearing face through the tiles are of plain cement, shall be provided with stone chips of 1 to 2 mm. Size. The proportions of cement to the marble chips aggregate in the wearing layer of the tiles shall be three parts of cement to one part chips by weight. The minimum thickness Of wearing layer shall be 3 mm. The colour and texture of wearing layer shall be uniform through out its face and thickness. On removal from mould, the tiles shall be kept in moist conditions continuously at least for seven days and subsequently, if necessary, for such long period as would ensure their conformity to requirements of I.S. : 1237-1980 regarding strength resistance to wear and water absorption.

**47.1.3.** The wearing face of the tiles shall be plain, free from projections, depressions and cracks and shall be reasonably parallel to the back face of the tile. All angles shall be right and all edges shall be sharp and true.

**47.1.4.** The size of tiles shall generally be square shape 24.85 Cm. x 24.85 Cm. or 25 Cm. x25 Cm. The thickness of tiles shall be 20 mm.

**47.1.5.** Tolerance of length and breadth shall be plus or minus one millimeter, Tolerance or thickness shall be plus 5 mm.

**47.1.6.** The tiles shall satisfy the tests as regards transverse strength, resistance to wear and water absorption as per I.S.:1237-1980.

**47.2. (B) Plain Coloured Tiles :**

**47.2.1.** These tiles shall have the same specification as per plain cement tiles as per (A) above except that they shall have a plain wearing surface where in pigments are used. They shall conform to I.S. 1237-1980.

**47.2.2.** The pigment used for coloring cement shall not exceed 10 percent by weight of cement used in the mix. The pigments, synthetic or otherwise, used for



coloring tiles shall have permanent colour and shall not contain materials detrimental to concrete.

**47.2.3.** The colour of the tiles shall be specified in the item or as directed.

**47.3. (C) Marble mosaic tiles :**

**47.3.1.** These tiles have the same specifications as per plain cement tiles except the requirements as stated below:

**47.3.2.** The marble mosaic tiles shall conform to I.S. 1237-1980. The wearing face of the tiles shall be mechanical ground and filled. The wearing face of tiles shall be free from projections, depressions and cracks and shall be reasonably parallel to the back face of the tiles. All angles shall be right angles and all edges shall be sharp and true.

**47.3.3.** Chips used in the tiles be from smallest up to 20 mm. size. The minimum thickness of wearing layer of tiles shall of 6 mm. For pattern of chips to be used on the wearing face, a few samples with or without their full size photographs as directed shall be presented to the Engineer-in-charge for approval.

**47.3.4.** Any particular samples, If found suitable shall be approved by the Engineer-in-charge, or he may ask for a few more samples to be prepared indicating roughly the particular sized chips to be more or less in the samples presented. The samples have to be made by the contractor till a suitable sample is finally approved for use in the work.

The Contractor shall ensure that the tiles supplied for the work shall be in conformity with the approved sample only, in terms of its dimensions, thickness of backing layer and wearing surface, materials, ingredients, colour shade, chips, distribution etc. required.

**47.3.5.** The tiles shall be prepared from cement conforming to Indian Standards or coloured Portland cement generally depending upon the colour of tiles to be used or as directed.

**47.4. (D) Chequered Tiles:**

**47.4.1.** Chequered tiles shall be plain cement tiles or marble mosaic tiles. The former shall have the same specification as per (A) above and the latter as per marble mosaic tiles as per (C) except as mentioned below :

**47.4.2.** The tiles shall be of nominal size of 250 mm. x 250 mm. or as specified. The center to center distance of chequer shall not be less than 25 mm. and not more than 50 mm. The overall thickness of the tile shall be 22 mm.

**47.4.3.** The grooves in the chequers shall be uniform and straight. The depth of the grooves shall not be less than 3 mm. The chequered shall be plain, coloured or mosaic as specified. The thickness of the upper layer measured from the top of the chequers shall not be less than 6 mm. The tiles shall be given the first grinding with machine before delivery to site.

**47.4.4.** Tiles shall conform to relevant I.S. 1237-1980.

**47.5 (E) Chequered Tiles for Stair cases :**

**47.5.1.** The requirements of these tiles shall be the same as chequered as per (D) above except in following respects;

- (1) The length of a tile including nose shall be 330 mm.
- (2) The minimum thickness shall be 28 mm.
- (3) The nosing shall have also the same wearing layer as at the top.
- (4) The nosing edge shall be rounded.
- (5) The front portion of the tile for a minimum length of 75 mm. from and including the nosing shall have grooves running parallel to nosing and at center not exceeding 25 mm. Beyond that the tiles shall have normal chequer pattern.

**M-48. Rough Kotah Stone :**

- 48.1. The kotah stones shall be hard, even, sound, and regular in shape and generally uniform in colour. The colour of the stone shall generally be green. Brown colour stones shall not be allowed for use. They shall be without any soft veins, cracks or flows.
- 48.2. The size of the stones to be used for flooring shall be of size 600 mm x 600 mm and/or size 600 mm x 450 mm, as directed. However smaller sizes will be allowed to be used to the extent of maintaining required pattern. Thickness shall be as specified.
- 48.3. Tolerance of minus 30 mm. on account of chisel dressing of edges shall be permitted for length as well as breadth. Tolerance in thickness shall be +/- 3 mm.
- 48.4. The edges of stones shall be truly chiselled and table rubbed with coarse sand before paving. All angles and edges of the stone shall be true, Square and free from chipping and the surface shall be true and plain.
- 48.5. When machine cut edges are specified, the exposed edges and the edges at joints shall be machine cut. The thickness of the exposed machine cut edges shall be uniform.

**M-49. Polished Kotah Stones**

- 49.1. Polished kotah stone shall have same specifications as per rough kotah stone except as mentioned below:
- 49.2. The stones shall have machine polished smooth surface. When brought on site, the stones shall be single polished or double polished depending upon its use. The stones for paving shall generally be single polished. The stones to be used for dedo, skirting, platforms, sink, veneering, sills, steps, etc. Where machine polishing after the stones are fixed in situ is not possible, shall be double polished.

**M-50. Dholpur Stone Slab :**

- 50.1. Dholpur stone slab shall be of best quality as approved by the Engineer-in-charge. The stone slab shall be even, sound and durable, regular in shape and of uniform colour.
- 50.2. The size of the stone shall be specified in the item or detailed drawings or as approved by the Engineer-in-charge. The thickness of the stone shall be as specified in the item of work with the permissible tolerance of plus or minus 2 mm. The provisions in respect of polishing as for polished Kotah stone shall apply to polished Dholpur stone also. All angles and edges of the face of the stone slab shall be fine chiseled or polished as specified in the item of work and all the four edges shall be machine cut. All angle and edges of the stone slab shall be true and plane.
- 50.3. The sample of stone shall be got approved from the Engineer-in-charge for shade and tint for a particular work. It shall be ensured that stones to be used in a particular work shall not differ much in shade or tint from the approved sample.

**M-51. Marble Slab :**

- 51.1. Marble slab shall be white or of other colour and of best quality as approved by the Engineer-in-charge
- 51.2. Slabs shall be hard, uniform and homogeneous in texture. They shall have even crystalline grain and free from defects and cracks. The surface shall be machine polished to an even and perfectly plane surface and edges machine cut true and square. The rear face shall be rough to provide key for the mortar.
- 51.3. Marble slabs with natural veins, if selected shall have to be laid as per the pattern given by the Engineer-in-charge. Size of the slab shall be minimum

450mm x 450mm. and preferable 300 mm x 600 mm. However, smaller sizes will be allowed to be used to the extent of maintaining required pattern.

**51.4.** The slab shall not be thinner than the specified thickness at its thinnest part. A few specimen of finished slab to be used shall be deposited by the Contractor in the office for reference.

**51.5.** Except as above, the marble slabs shall conform to I.S. 1130-1969.

**M-52 Granite Stone Slab :**

**52.1** Granite shall be of approved colour and quality. The stone shall be hard, even, sound regular in shape and generally uniform in colour. It shall be without any soft veins, cracks of flows.

**52.2** The thickness of the stone shall be as specified in items.

**52.3** All exposed face shall be double polished to tender truly smooth and the even reflecting surface. The exposed edges and corners shall be rounded off as directed. The exposed edges shall be machine cut and shall have uniform thickness.

**M-53 P.V.C. Flooring :**

**53.1** P.V.C sheets for P.V.C. floor covering shall be homogenous flexible type, conforming to I.S. 3452-1966. The P.V.C covering shall neither develop any toxic effect while put to use nor shall give off any disagreeable order.

**53.2** Thickness of flexible type covering tiles shall be as specified in the description of the item.

**53.3** The flexible type shall be backed with Hussein or other woven fabric. The following tolerances shall be applicable on the nominal dimension of the sheet rolls or tiles :

(a) Thickness +/- 0.15 mm

(b) Length or Width :

1. 300 mm. square tiles +/- 0.20 mm. 39.00 mm.square tiles +/-0.30 mm.
2. 600 mm. square tiles +/- 0.40 mm. 4 Sheets ad rolls +/-0.10 percent

**53.4 Adhesive :**

**53.4.1** The adhesive for PVC flooring shall be of the type and make recommended by the manufactures of PVC sheets/tiles.

**M-54. Facing tiles :**

**54.1.** The facing tiles (burnt clay facing bricks) shall be free from cracks, flaws and nodules of free lime. They shall be thoroughly burnt and shall have plane rectangular faces with parallel sides and sharp straight right edged faces. The texture of the finished surface that will be exposed when in place, Shall conform to an approved sample consisting not less than four stretcher bricks each representing the texture desired. The facing tiles shall have a pleasing appearance, sufficient resistance to penetration by rain and greater durability than common bricks. The tiles shall conform to I.S. 2691-1972.

**54.2.** The standard size of facing brick tiles shall be 19 x 9 x 4 cms. The facing brick tiles shall be provided with frog which shall conform to I.S. 1077-1976.

**54.3.** The permissible tolerance in dimensions specified above shall be as follows :

**Size Tolerance for**

	<b>1<sup>st</sup> class Brick</b>	<b>2<sup>nd</sup> class Brick</b>
19 cm.	+/- 6 mm.	+/- 10 mm.
9 cm.	+/- 3 mm.	+/- 7 mm.
4 cm.	+/-1.5 mm	+/- 3 mm.

**54.4** The tolerance for distortion or war page of face or edges of individual brick from a plane surface and from a straight line respectively shall be as follows :  
Facing dimensions Permissible tolerance  
Max. below 19 cms. Max. 2.5 mm.

-do- above 19 cm. Max 3.0 mm.

**54.5** The average compressive strength obtained as sample of five tiles when tested in accordance with the procedure laid as per I.S. 1077-1976 shall be not less than 175 Kg./Sq. Cm. The average compressive strength of any individual bricks shall be not less than 160 Kg/Sq.Cm.

**54.6** The average water absorption for five bricks tiles shall not exceed 12 percent of average weight of brick before testing.

The absorption for each individual bricks shall not exceed 25 percent.

**54.7** The brick tiles when tested in accordance with I.S. 1077-1976, the rate of efflorescence shall not be more than 'Slightly effloresced.

**M-55. White glazed tiles :**

**55.1** The tiles shall be of best quality as approved by the Engineer-in-charge. They shall be flat and true to shape. They shall free from cracks , crazing, spots chipped edges and corners. The glazing shall be of uniform shade.

**55.2** The tiles shall be nominal size of 150 mm x 150 mm. unless otherwise specified. The maximum variation from the stated sizes, other than the thickness of tile, shall be plus or minus 1.5 mm. The thickness of tile shall be 6 mm. Except as above the tiles shall conform to I.S. 777-1970.

**M-56. Galvanised iron pipes and fittings :** **56.1.** Galvanised iron pipe shall be of the medium type and of required diameter and shall comply with I.S. 1239-1979. The specified diameter of the pipes shall refer to the inside diameter of the bore, Clamps, screw and all galvanised iron fittings shall be of the standard 'R' or equivalent make.

**M-57. Bib cock and stop cock :**

**57.1** A bib cock is a draw off tap with a horizontal inlet and free outlet. A stop cock is a valve with a suitable means of connection for insertion in a pipe line for controlling or stopping the flow.

**57.2** They shall be of screw down type and of brass chromium plated and of diameter as specified in the description of the item. They shall conform to I.S. 781-1977 and they shall be of best Indian make. They shall be polished bright.

**57.3** The minimum finished weight of bib cock and stop cock shall be as given below :

Diameter	Bib cock	Stop cock	Diameter	Bibcock	Stop cock
8 mm.	0.25 Kg.	0.25 Kg.	15 mm.	0.40 Kg.	0.40 Kg.
10 mm.	0.30 Kg.	0.35 Kg.	20 mm.	0.75 Kg.	0.75 Kg.

**M-58. Gun metal wheel valve :**

**58.1.** The gun metal wheel valve be of approved quality. These shall be gun metal fitted with wheel and shall be of gate valve opening full way and of the size as specified. These shall conform to I.S. 778-1971.

**M-59. White glazed porcelain wash basin :**

**59.1.** Wash basin shall be of white porcelain first quality best Indian make and it shall conform it I.S. 2556 (Part-IV) 1972 and I.S. 771-1979.

The size of the wash basin shall be as specified in the item, Wash basin shall be of one piece construction with continued over-flow arrangements. All internal angles shall be designed so as to facilitate cleaning. Wash basin shall have single tap hole or two holes as specified. Each basin shall have a circular waste hole which is either rebated or beveled internally with 65 mm. diameter at top and 10 mm. depth to suit the waste fitting. The necessary stud slot to receive the bracket on the under side of the basin shall be provided. Basin shall have an internal soap holder recess which shall fully drain into the bowl.

**59.2.** White glazed pedestal of the quality and colour as that of the basin shall be provided where specified in the item. it shall be completely recessed at the

back for reception of supply and wash pipe. It shall be capable of supporting the basin rigidly and adequately and shall be so designed as to make the height from floor to top of basin 750mm. to 800 mm. as directed.

**M-60. European type water closet/with low level flushing :**

**60.1.** The European type water closet shall be white glazed porcelain first quality and shall be of wash down type conforming to I.S. 2556-1973 and I.S. 771-1979.

**60.2.** 'S' trap shall be provided as required with water seal not less than 50 mm. The solid plastic seat and cover shall be of the best Indian make conforming to I.S. 2548-1980. They shall be made of moulded syntactic materials which shall be tough and hard with high resistance to solvents and shall be free from blisters and other surface defects and shall have chromium plated brass hinges and rubber buffer of suitable size.

**M-61. Orissa type water closet :**

**61.1.** The specification of Orissa type white glazed water closet of first quality shall conform to I.S. 2556 (Part-III) 1981 and relevant specification of Indian type water closet except that pan will be with the integral squatting pan of size 580 mm x 440 mm. with raised footrest.

**M-62. Indian type water closet :**

**62.1.** The Indian type white glazed water closet of first quality shall be of size as specified in the item and conforming to I.S. 771-1979 and I.S. 2556 (Part-II) 1981. Each pan shall have integral flushing ring of suitable type with adequate number of holes alroung as directed to have satisfactory flushing. It shall also have inlet at back or front connecting flush pipe as directed. The inside of the bottom of the pan shall have sufficient slope from the front towards the outlet and surface shall be uniform and smooth.

Pan shall be provided with 100 mm. diameter 'P' or 'S' trap with approximately 50 mm. water seal and 50 mm. diameter vent horn.

**M-62. (A) Foot Rests :**

**62-A-1** A pair of white glazed earthen ware rectangular foot rests of minimum size 250 mm. x 130 mm 20 mm. shall be provided with water closet.

**M-63. Glazed Earthen Ware Sink :**

**63.1.** The glazed earthen-ware sink shall be specified size colour and quality. The sink shall conform to I.S. 771 Part-II-1979 the brackets for sinks shall conform to I.S. 775-1970.

**63.2.** The pipes shall conform to I.S. 1239-Part-I 1973 and I.S. 404-1962 for steel and lead pipes respectively 32 mm. brass waste coupling of standard pattern with brass chain and rubber plug shall be provided with sink.

**M-64. Glazed earthen ware Lipped type flat back urinal/corner type urinal :**

**64.1** The lipped type urinal shall be flat back or corner type as specified in the item and shall conform to I.S. 771-1979. It shall be of best Indian make and size as specified and approved by the Engineer-in-charge. The flat back or corer type urinal must be 1<sup>st</sup> quality free from any defects, cracks, etc.

**M-65. Low level enamel flushing tank :**

**65.1.** The low level flushing tank shall be of 15 liters capacity. It shall conform to I.S. 774-1971. The flushing vaster shall be of best quality and free from any defects. The flushing tank shall have outlet 32 mm. diameter The outlet shall be connected with W.C. Pan by lean pipe or P.V.C. pipe as specified. The flushing tank shall be provided with inlet and outlet for fixing G.I. inlet pies and over-flow pipes. The flushing castern shall be provided with chromium plated handle for flushing. The flushing tank shall be provided with brackets

of cast iron so that it can be fixed on wall at specified height. The brackets shall Conform to I.S. 775-1970.

**M-66. Cast iron flushing cistern :**

**66.1.** The cast iron flushing cistern shall be of 15 liters capacity. It shall conform to I.S. 774-1971. The flushing cistern shall be of best quality free from any defects. The flushing cistern shall have outlet of 32 mm. diameter. The outlets shall be connected to lead pipe of 32 mm. diameter. The lead pipe shall conform to I.S. 404 (Part-I) 1962. For fixing G.I. inlet pipes and overflow pipe 20 mm. diameter. inlet and outlet shall be provided. The flushing cistern shall be provided with galvanised iron chain and pull of sufficient length and shall be got approved from the Engineer-in-charge. The cast iron flushing cistern shall be painted with one coat of anticorrosive paint and two coats of paints. The flushing cistern shall be fixed on two C.I. brackets. The C.I. brackets shall conform to I.S. 775-1970.

**M-67. Flush cock :**

**67.1.** Half turn flash cock (Heavy Weight) shall be of gun metal chromium plated of diameter as specified in the description of the item. The flush cock shall conform to relevant Indian Standard.

**M-68. Cast iron pipes and fittings :**

**68.1.** All soil waster, vent and antisiphonage pipes and fittings shall conform to I.S. 1729-1964. The pipe shall have spigot and socket ends with head on spigot end. The pipes and fittings shall be true to shape, smooth, cylindrical, their inner and outlet surfaces being as nearly as practicable concentric. They shall be sound and nicely cast and shall be free from cracks, laps, pinholes or other imperfection and shall be neatly dressed and carefully fettled.

**68.2.** The end of pipes and fittings shall be of reasonable square to their axis.

**68.3.** The sand cast iron pipes shall be of the diameter as specified in the description and shall be in lengths of 1.5 M, 1.8 M. and 2 M. including socket ends of the pipe unless shorter lengths are either specified or required at junctions etc. The pipes and fittings shall be supplied without ears unless specified or directed otherwise.

**68.4. Tolerances.**

**68.4.1.** The Standard weights and thickness of pipes shall be as shown in the following table : A tolerance up to minus 10 percent may however be against these standard weights.

Sr. no.	Nominal	Thickness	Overall Weight of pipe excluding ears		
			1.5 m. long	1.8m. long	2.m. long
1.	75 mm.	50 mm.	12.83 Kg.	16.52 Kg.	18.37 Kg.
2.	100 mm.	5.0 mm.	18.14 Kg.	21.67 Kg.	24.15 Kg.

**68.4.2.** A tolerance upto minus 15 percent in thickness and 20 mm. in length will be allowed. For fittings tolerance in lengths shall be plus 15 mm. and minus 10 mm.

**68.4.3.** The thickness of fittings and their socket and spigot dimensions shall conform to the thickness and dimensions specified for the corresponding sizes of straight pipes. The tolerances in weights and thickness shall be the same as for straight pipes.

**M-69. Nahni Trap :**

**69.1.** Nahni trap shall be of cast iron and shall be sound and free from porosity or other defects which affect serviceability The thickness of the base metal shall not be less than 6.5 mm. The surface shall be smooth and free from craze,



- ships and other flaws or any other kind of defects which affect serviceability. The size of nahni trap shall be as specified and shall be of self cleaning design.
- 69.2.** The Nahni trap shall be of quality approved by the Engineer-in-charge and shall generally conform to the relevant Indian Standards.
- 69.3.** The Nahni trap provided shall be with deep seal, minimum 50 mm, except at places where trap with deep seal can not be accommodated. The cover shall be cast iron. Performed cover shall be provided on the trap of appropriate size.
- M-70. Gully Trap :**
- 70.1** Gully Trap shall conform to I.S. 651-1980. It shall be sound, free defects such as fire cracks. The glaze of the traps shall be free from crazing. They shall give a sharp clear note when struck with light hammer. There shall be no broken blisters.
- 70.2** The size of the gully trap shall be as specified in the item.
- 70.3** Each gully trap shall have one C.I. gratings of square size corresponding to the dimensions of inlet of gully trap, It will also have a water tight. C.I. cover with frame inside dimensions 300 mm. x 300 mm., the cover with frame inside dimension, 300 mm. 300 mm., the cover weighing not less than 4.53 Kg. and the frame not less than 2.72 Kg. The grating cover and frame shall be of sound and good casting and shall have truly square machined seating faces.
- M-71. Glaze Stone Ware Pipe And Fitting :**
- 71.1.** The pipes and fittings shall be of best quality as approved by the Engineer-in-charge. The pipe shall be of best quality manufactured from stone-ware of fire clay, salt glazed thoroughly burnt through the whole thickness, of a close even texture, shall be smooth and perfectly glazed. The pipe shall be capable to withstand pressure of 1.5 mm. lead without showing sign of leakage. The thickness of the wall shall not be less than 1/12<sup>th</sup> of the internal dia. The depth of socket shall not be less than 38 mm. The socket shall be sufficiently large to allow a joint of 1 mm. around the pipe.
- 71.2.** The pipes shall generally conform to relevant I.S. 651-1980.
- M-72. Wall Peg Rail :**
- 72.1.** The aluminum wall peg rail shall have three aluminum pegs of approved quality and size. It shall be fixed on teakwood plant of size 450 mm. x 75 mm. x 20 mm. The teakwood shall be french polished or oil painted as specified.
- M-73. G.I. Water Spot :**
- 73.1.** The G.I. pipes of 40 mm. dia shall be of medium quality and specials shall be of 'R' brand or equivalent brand of best approved quality.
- 73.2.** The pipe shall have length as required for the thickness of wall in which it is fixed. and at the outside end tee and bend cut at half the length shall be provided and at other end coupling shall be provided to have better fixing. The water spout shall be provided as per detailed drawings or as directed.
- M-74. Asbestos Cement Pipe (A.C. Pipe):**
- 74.1.** The asbestos cement pipe of diameter as specified in the description of the item shall conform to I.S. 1626-1980. Specials like bends, shoes cowls, etc. shall conform to relevant Indian Standards. The interior of pipe shall have a smooth finish, regular surface and regular, internal diameter. The tolerance in all dimensions shall be as per I.S. 1626-Part-I 1980.
- M-75. Crydon Ball valve :**
- 75.1.** Ball valve of screwed type including polyethylene float and necessary lever etc. shall be of the size as mentioned in the description of item and shall conform to I.S. 1703-1977.
- M-76. Bitumen Felt For Water Proofing And Damp Proofing :**

**76.1** Bitumen felt shall be on the fiber bases and shall be type 2, self finished grade-2 and shall conform to I.S. 1322-1970.

**M-77 Selected Earth :**

**77.1.** The selected earth shall be hat obtained from excavated material or shall have to brought from outside as indicated in the item. If item does not indicate anything, The selected earth shall have to be brought from outside.

**77.2.** The selected earth shall be good yellow soil and shall be got approved from the Engineer-in-charge. In no case black cotton soil or similar expansive and suitable soil shall be used. It shall be clean and free from all rubbish and perishable materials, stones or brick bats. The clods shall be broken to a size of 50. mm or less, Contractor shall make his own arrangement at his own cost for land for borrowing selected earth. The stacking of material shall be done as directed by the Engineer-in-charge in such a way as not to interfere with any constructional activities and in proper stacks.

**77.3.** When excavated material is to be used, only selected stuff got approved form the Engineer-In-Charge shall be used. It shall be stacked separately and shall comply with all the requirements of selected earth mentioned above :

**M-78. Barbed Wire :**

**78.1.** The barbed wire shall be of galvanised steel and it shall generally conform to I.S. 278-1978. The barbed wire shall be if type-I whose nominal diameter for line wire shall be 2.5 mm. and point wire 2.24 mm. The nominal distance between two bars shall be 75 mm. Unless otherwise specified in the item. The barbed wire shall be formed by twisting together two line wires, One containing the barbs. The size of the line and point wires and barb spacings shall be as specified above. The permissible deviation form the nominal diameter of the line wore and point wire shall not exceed +/- 0.08 mm.

**78.2.** The barbs shall carry four points shall be formed by twisting two point wires each two turns, lightly round one line wire, making altogether four complete turns. The barbs shall be so finished that the four points are set and locked at right angles to each other. The barbs shall have a length of not less than 13 mm. and not more than 13 mm. and not more 18 MM. The points shall be sharp and cut at an angle not greater than 35 degree of the axis of the wire forming the barbs.

**78.3.** The lind and point wire shall be circular section free from scale and other defects and shall be uniformly galvanised. The line wire shall be in continuous length and shall not contain any weld other than those in the rod before it is drawn. The distance between two successive splices shall not be less than 15 meters.

**78.4.** The lengths per 100 Kg. of barbed wire I.S. type I shall be as under  
Nominal 1000 meter Minimum 834 Meter Maximum 1066 Meter.

#### **SECTION-4**

#### **DETAILED SPECIFICATIONS-EXCAVATION**

**4.0.0** *(a) Excavation for foundation upto 1.5 M depth including sorting out and stacking useful materials disposing of the excavated stuff upto 50 meter lead in loose or soft soil.*

**1.0. General :**

**1.1.** Any soil which generally yields to the application of ackaxes and shoves, phawaras rakes or any such ordinary excavating implement or organic soil, gravel silt, sand turfloam, clay, peat etc., fall under this category.

**2.0. Clearing the site :**



- 2.1. The site on which the structure is to be built shall be cleared and all obstructions, loose stone, materials and rubbish of all kind, bush, wood and trees shall be removed as directed. The materials so obtained shall be property of the Government and be conveyed and stacked as directed. within 50 M. lead. The roots of the trees coming in the sides shall be cut and coated with a hot asphalt.
- 2.2. The rate of site clearance is deemed to be included in the rate of earth work for which no extra will be paid.
- 3.0 **Setting Out :** After clearing the site, the center lines will be given by the Engineer-in-charge. The contractor shall assume full responsibility for alignment, elevation and dimension of each and all parts of the work. Contractor shall supply laborers, materials, etc. required for setting out the reference marks and bench marks and shall maintain them as long as required for setting out referenace marks and bench marks and shall maintain them as long as required and directed.
- 4.0 **Excavation :** The excavation in foundation shall be carried out in true line and level and shall have the width and depth as shown in the drawings or as directed. The contractor shall do the necessary shoring and shutting or providing necessary slopes to a safe angle, at his own-cost. The payment for such precautionary measures shall be paid separately if not specified. The bottom of the excavated area shall be 1 evened both longitudinally and transversely. as directed by removing and watering as required. No earth filling will be allowed for bringing it to level, if mistake or any other reason excavation is made. deeper or wider that shown on the plan or directed. The extra depth or width shall be made up with concrete of same proportion as specified for the foundation concrete at the cost of the contractor. The excavation up to 1.5 m. depth shall be measured under this item.
- 5.0 **Disposal of the excavated stud :**
- 5.1 The excavated stuff of the selected type shall be used in filling the trenches and plinth or leveling the ground in layer including ramming and watering etc.
- 5.2 The balance of the excavated quantity shall be removed by the contractor from the site of work to a place as directed with lead upped 50 M. and all lift.
- 6.0. **Mode of measurement and payment :**
- 6.1 The measurement of excavation in trenches for foundation shall be made according to the sections of trenches shown on the drawing or as per sections given by the Engineer-in-charge. No payment shall be made for surplus excavation made in excess of above requirements or due to slopping and sloping back as found necessary on account of conditions of soil , and requirements of safety.
- 6.2 The rate shall be for a unit of one cubic meter.
- 4.0.0. **(B) Excavation for foundation upto 1.5 M. depth including sorting out and stacking of useful materials and disposing of the excavated stuff upto 50 meter lead in dense or hard soil.**
- 1.0. **Dense or Hard Soil :** Any soil which generally require close application of picks or jumpers or scarifiers to loosen it stiff clay, gravel and rubble stone etc. fall under this category.
- 2.0. **Workmanship :** The relevant specification of item No. 4.0.0. (A) shall be followed except that the excavation work shall be carried out in dense or hard soil.
- 3.0. **Mode of measurement and payment :**
- 3.1. The relevant specification of item No. 4.0.0 (A) shall be followed.
- 3.2. The rate shall be for a unit of one cubic meter.

**4.0.0 (C) : Excavation for foundation upto 1.5. M depth including sorting out and stacking of useful materials and disposing of the excavated stuff upto 50 meter In lead-hard murrum.**

**1.0. Hard murrum :** The hard murrum shall be clean of good binding quality and of approved quality obtained from approved quarries, of disintegrated rocks which contain silicones material and nature mixture of clay of calcareous origin. The size of hard murrum shall not be more than 20 mm.

**2.0. Workmanship:** The relevant specification of item No. 4.0.0. (A) shall be followed except that the excavation work shall be carried in hard murrum.

**3.0. Mode of measurement and payment :**

**3.1.** The relevant specification of item No. 4.0.0. (A) shall be followed.

**3.2.** The rate shall be for a unit of one cubic meter.

**4.0.0. (D) : Excavation for foundation up to 1.50 M.depth including sorting out and stacking of useful materials and disposing of the excavated stuff upto 50 meter lead-soft rock not requiring blasting.**

**1.0. Workmanship :**

**1.1.** The relevant specification of item 4.0.0. (A) shall be followed except that the excavation shall be carried out for foundation upon 1.5. m. lift in soft-rock not requiring blasting.

**1.2.** The excavation in soft or disintegrated rock shall be carried out by crow bars pickaxes or pneumatic drills or any other suitable means.

**1.3.** If contractor desires to resort to blasting, he can do so with permission of the Engineer-in-charge but nothing extra shall be paid to him.

**1.4.** The materials available from rock excavation shall be properly stacked within 50 m. lead and 1.5. m. lift and shall be property stacked within 50 m. lead and 1.5.m. lift and shall be the property of department.

**1.5.** The classification of state of the foundation soil shall be done by the Engineer-in-charge and shall be acceptable to the contractor.

**1.6.** However this shall include the type of rock and boulder which may quarried or split with crow bars. Laterite and conglomerate also come under this category.

**2.0. mode of measurement and payment :**

**2.1** The relevant specification of item NO. 4.0.0. (A) shall be followed.

**2.2** The rate shall be for a unit of one cubic meter.

**4.0.0. (E) : Excavation for foundation upto 1.5 M. depth including sorting out and stacking of useful materials and disposing of the excavated stuff upto 50 meter lead in hard rocks.**

**1.0. Workmanship :**

**1.1.** The relevant specification of item No. 4.0.0.(A) shall be followed except that the excavation for foundation work shall be carried out in hard rock.

**1.2.** Excavation shall be done by blasting to the dimensions shown in the drawings or as directed. The blasting shall be carried out only with written permission of the Engineer-in-charge. All the laws, regulations etc. pertaining to the precautions, acquisition, transport, storage, landing and use of explosives shall be rigidly followed. The Magazine for the storage for the explosive shall be built to the design and specifications of explosive authority and located at the approved site. No unauthorized persons shall be admitted into the magazine and when not in use it shall be kept securely locked. No matches or inflammable materials shall be allowed in the Magazine. The Magazine shall have an effective lightning conductor. The rules of explosive 1940 revised for time to time shall be followed strictly for obtaining, handling, undertaking blasting work.

**1.3.** The contractor shall be responsible for damage to property, workman, public due to any accident due to use of explosives and blasting operations.

**1.4. Precautions :**

**1.4.1.** The blasting operation shall remain in charge of competent and experienced supervisor and workman who are thoroughly acquainted with the details of handling explosives and blasting operations. The blasting shall be carried out during fixed hours of the day, preferably during the mid-day-lunch hours or at the close of the work as ordered in writing by the Engineer-in-charge. The hours of blasting shall be notified in advance to the people in the vicinity. All the charges shall be prepared by the man in charge only.

**1.4.2.** Red danger flags shall be displayed prominently in all directions during the blasting operations.

**1.4.3.** People except this who actually light the fuse shall be prohibited from entering into this area. The flag shall be stationed as 200 m. from the firing site in all directions and all persons including workmen shall be excluded from the flagged area at least 10 minutes before the firing warning whistle being sounded for this purpose.

**1.4.4.** During excavation in rock by blasting, the lowest 15 cm. of the stratas shall be blasted with light charges so as not to shatter or weaken the underlying rock on which the foundation will be actually laid. If excavation in rock is done to larger width and lengths than those shown on the drawings or as directed, no payment shall be made for such over break. If excavation is done to depth greater than shown on the drawings or directed, excess depth shall be made up with foundation grade concrete as directed at the contractor's cost.

**1.4.5.** The charged hole shall be drilled to the required depth and in suitable places when blasting is done with powder, the fuse cut to the required length shall be inserted in the holes and the powder dropped in. The powder shall be gently tamped with copper rod with rounded ends. The explosive powder shall then be covered with trapping materials which shall be tamped lightly but firmly. When blasting is done with dynamite and other high explosive dynamite cartridges shall be prepared by inserting the square cut ends of fuse into the detonator, and finished with dippers at the open ends. The detonator should be gently pushed into the primer leaving one third of the copper exposed outside. The primer shall be housed into the explosive. Bore holes shall be of such size that the cartridges can be easily passed down. The primer shall be cleared of all debris and explosive inserted. The space for about 20 cms. above the charge shall then be gently filled with dry clay pressed home and rest of the tamping is firmed with any convenient materials gently packed with a wooden cover.

**1.4.6.** At a time, not more than 20 such charges shall be prepared and fired. The man in charge shall blow a whistle in a recognised manner for cautioning the people. All the people shall then be required to move to safe distances. The charges shall be lighted by the man in charge only. The man-in-charge shall count the number of explosions. He shall satisfy himself that the charges have been exploded before allowing the workman to go to the work site.

**1.4.7.** The contractor shall be fully responsible to strictly follow the prevailing rules and procedures regarding blasting procedures.

**1.5. Misfire :**

**1.5.1.** In case of a misfire the following procedure shall be observed :

**1.5.2.** Sufficient time shall be allowed to account for the delayed blast. The man in charge shall inspect all the charges and determine the missed charge.

- 1.5.3** If it is the blasting powder charge, it shall be completely flooded with water. A new hole shall be drilled at about 45 cm. from the old and fired. This should blast the old charge. Should it not blast the old charge. Should it not blast the old charge, the procedure shall be repeated till the old charge is blasted.
- 1.5.4.** In case of charge of gelatin, dynamite etc. the man in charge shall gently remove the tamping and the primer with detonator. A fresh detonator and primer shall then be used to blast the charge. Alternatively the hole may then be drilled 15 cm. away and parallel to it. This hole shall then be charged fired when the misfired hole should explode at the same time. The man in charge shall report to the office at once all cases of misfire, the cause of the same and what steps were taken in connection therewith.
- 1.5.5.** If a misfire has been found to be due to defective detonator or dynamite, the whole quantity in the box from which defective article was taken must be sent to the authority as directed for inspection to ascertain whether all the remaining materials in the box are also defective or not.
- 1.6. Accidents :**
- 1.6.1.** The contractor shall be solely responsible for any accident during the entire procedure of handling explosive and blasting and shall pay necessary compensation to persons affected or damage to lands or property etc., due to the blasting without extra claims on the department.
- 1.7. Account :**
- 1.7.1.** A careful and day-to day account of explosives shall be maintained by the contractor in an approved manner and shall be open to inspection of the Engineer-in-charge at all times. Surprise visit may also be paid by the Engineer-in-charge to the storage and in case of any unaccountable shortage or unsatisfactory accounting, the contractor shall be liable to be penalised by forfeiture of part or whole of his Security Deposit or by cancellation of tender in which case he shall not be entitled for any compensation.
- 1.8. Disposal of Excavated materials :**
- 1.8.1.** No materials excavated from foundation trenches of whatever kind they may be, are to be placed even temporarily nearer than 1.5m. of distance prescribed by the Engineer from the outer edges of excavation. All materials excavated shall remain the property of Government. Rate for excavation includes sorting out of useful materials and stacking them separately as directed within the specified lead. Materials suitable and useful for back filling or other use shall be stacked in convenient places but not in such a way as to obstruct free movement of men, animals and vehicles or encroach upon the area required for constructional purpose. The site shall be left clean of all debris on completion.
- 1.8.2.** Disposal of excavated materials is subject to the following :  
Unsuitable materials obtained from clearing site and excavation shall be disposed off within a lead of 50 meters as directed. Useful materials obtained from clearing site and excavation shall be stacked within a lead of 50 M. beyond the building area as directed. Materials suitable for back filling shall be stacked at convenient places within a lead of 50 M. from the structure for reuse. Useful stones from rock excavation shall be stacked neatly within a lead of 50 M. and will be allowed to be used by the contractor on payment at rates laid down in the contract or if not so laid down, at schedule of rates of the Division or at a mutually agreed rates if there are no such rates in the Schedule of rates.
- 1.8.3.** If surplus materials are required to be conveyed beyond 50 M. conveyance will be paid for under a separate item.

**2.0. Mode of measurement and payment :**

- 2.1.** The work shall be measured for the work limited to the dimensions shown on drawings or directed, Excavation to dimensions in excess of the above will not be measured or paid for and if so ordered by the Engineer the contractor shall have to fill up the excess depth with cement concrete specified for foundation without extra payment.
- 2.2.** Driving of sounding bards, drill holes to explore the nature of substratum upto a total length of meter distributed in 2 or 3 places in each foundation if necessary, will be considered incidental work and will not be paid for separately.
- 2.3.** Removal of slips and blows in the foundation trenches will not be measured or paid for.
- 2.4.** If it is necessary in the opinion of the Engineer-in-charge to carry foundation below the levels shown on the plants the excavation for the first 1.5 M. of additional depth will be included in the quantity for the particular classification and will be paid for as extra work at rate to be decided under the general conditions of contract unless the contractor unless the contractor is willing to accept payment as tendered rates.
- 2.5.** The rate shall be for a unit of one cubic meter.

**4.001 (A) : Excavation for foundation for depth from 1.50 M. to 3.0 M. including sorting out and stacking of useful materials and dosposing of the excavated stuff upto 50 M. in lead-loose or soft soil.**

**1.0. Workmanship :**

- 1.1.** The relevant specifications of item No. 4.0.0.(A) shall be followed except that the excavation work shall be carried out in loose or soft soil with lift 1.5 M. to 3.0.M.

**2.0. Mode of measurement and payment :**

- 2.1.** The relevant specification of item No. 4.0.0. A() shall be followed.
- 2.2.** The excavation work of lift 1.5 M. to 3.0.M. shall be measured under this item.
- 2.3.** The rate shall be for a unit of one cubic meter.

**4.001. (B) Excavation for foundation for depth from 1.5.M. to 3.0. M. including sorting out and stacking of useful materials and disposing of excavated stuff upto 50M.lead in Dense or Hard soil.**

- 1.0. Workmanship :** The relevant specification of item No. 4.0.0. (B) shall be followed except that the excavation work shall be carried out with 1.5 M. to 3.0. M. lift in dense or hard soil.

**2.0. Mode of measurement and payment :**

- 2.1.** The relevant specification of item No. 4.0.0. A() shall be followed.
- 2.2.** The excavation work of lift 1.5 M. to 3.0.M. shall be measured under this item.
- 2.3.** The rate shall be for a unit of one cubic meter.

**4.001 (C) Excavation for foundation for depth from 1.5.M. to 3.0. M. including sorting out and stacking of useful materials and disposing of excavated stuff upto 50M.lead in Hard murrum.**

- 1.0. Workmanship :** The relevant specification of item No. 4.0.0. (C) shall be followed except that the excavation work shall be carried out with 1.5 M. to 3.0. M. lift in hard murrum.

**2.0. Mode of measurement and payment :**

- 2.1.** The relevant specification of item No. 4.0.0. A() shall be followed.
- 2.2.** The excavation work of lift 1.5 M. to 3.0.M. shall be measured under this item.

- 2.3. The rate shall be for a unit of one cubic meter.
- 4.001 *(D) Excavation for foundation for depth from 1.5 M. to 3.0. M. including sorting out and stacking of useful materials and disposing of excavated stuff upto 50M.lead in soft rock not requiring blasting.*
- 1.0. **Workmanship :** The relevant specification of item No. 4.0.0. (B) shall be followed except that the excavation work shall be carried out with 1.5 M. to 3.0. M. lift in soft rock not requiring blasting.
- 2.0. **Mode of measurement and payment :**
- 2.1. The relevant specification of item No. 4.0.0. A() shall be followed.
- 2.2. The excavation work of lift 1.5 M. to 3.0.M. shall be measured under this item.
- 2.3. The rate shall be for a unit of one cubic meter.
- 4.001. *(E) Excavation for foundation for depth from 1.5 M. to 3.0. M. including sorting out and stacking of useful materials and disposing of excavated stuff upto 50M.lead in Hard rock.*
- 1.0. **Workmanship :1.1.** The relevant specification of item No. 4.0.0. (B) shall be followed except that the excavation work shall be carried out with 1.5 M. to 3.0. M. lift in hard rock.
- 2.0. **Mode of measurement and payment :**
- 2.1. The relevant specification of item No. 4.0.0. A() shall be followed.
- 2.2. The excavation work of lift 1.5 M. to 3.0.M. shall be measured under this item.
- 2.3. The rate shall be for a unit of one cubic meter.
- 4.002. *(A) Excavation for foundation for depth from 1.5 M. to 3.0. M. including sorting out and stacking of useful materials and disposing of excavated stuff upto 50M.lead in loose of soft soil.*
- 1.0. **Workmanship :** The relevant specification of item No. 4.0.0. (B) shall be followed except that the excavation work shall be carried out with 1.5 M. to 3.0. M. lift in loose of soft soil.
- 2.0. **Mode of measurement and payment :**
- 2.1. The relevant specification of item No. 4.0.0. (A) shall be followed.
- 2.2. The excavation work of lift 1.5 M. to 3.0.M. shall be measured under this item.
- 2.3. The rate shall be for a unit of one cubic meter.
- 4.002. *(B) Excavation for foundation for depth from 3.0 M. to 5.0. M. including sorting out and stacking of useful materials and disposing of excavated stuff upto 50 M. lead in Dense or Hard soil.*
- 1.0. **Workmanship :** The relevant specification of item No. 4.0.0. (B) shall be followed except that the excavation work shall be carried out with 3.0. M. to 5.0. M. lift in loose of soft soil.
- 2.0. **Mode of measurement and payment :**
- 2.1. The relevant specification of item No. 4.0.0. (A) shall be followed.
- 2.2. The excavation work of lift 3.0. M. to 5.0..M. shall be measured under this item.
- 2.3. The rate shall be for a unit of one cubic meter.
- 4.002. *(C) Excavation for foundation for depth from 3.0 M. to 5.0. M. including sorting out and stacking of useful materials and disposing of excavated stuff upto 50M.lead in Hard murrum.*
- 1.0. **Workmanship :** The relevant specification of item No. 4.0.0. (C) shall be followed except that the excavation work shall be carried out with 3.0. M. to 5.0. M. lift in loose of soft soil.
- 2.0. **Mode of measurement and payment :**



- 2.1. The relevant specification of item No. 4.0.0. (A) shall be followed.
- 2.2. The excavation work of lift 3.0. M. to 5.0..M. shall be measured under this item.
- 2.3. The rate shall be for a unit of one cubic meter.
- 4.002. ***(D) Excavation for foundation for depth from 3.0.M. to 5.0. M. including sorting out and stacking of useful materials and disposing of excavated stuff upto 50M.lead in soft rock not requiring blasting.***
  - 1.0. **Workmanship :** The relevant specification of item No. 4.0.0. (D) shall be followed except that the excavation work shall be carried out with 3.0. M. to 5.0. M. lead in soft rock not requiring blasting.
  - 2.0. **Mode of measurement and payment :**
    - 2.1. The relevant specification of item No. 4.0.0. (A) shall be followed.
    - 2.2. The excavation work of lift 3.0. M. to 5.0..M. shall be measured under this item.
    - 2.3. The rate shall be for a unit of one cubic meter.
- 4.002. ***(E) Excavation for foundation for depth from 3.0.M. to 5.0. M. including sorting out and stacking of useful materials and disposing of excavated stuff upto 50M.lead in soft rock not requiring blasting.***
  - 1.0. **Workmanship :** The relevant specification of item No. 4.0.0. (E) shall be followed except that the excavation work shall be carried out with 3.0. M. to 5.0. M. lead in soft rock not requiring blasting.
  - 2.0. **Mode of measurement and payment :**
    - 2.1. The relevant specification of item No. 4.0.0. (A) shall be followed.
    - 2.2. The excavation work of lift 3.0. M. to 5.0..M. shall be measured under this item.
    - 2.3. The rate shall be for a unit of one cubic meter.
- 4.003. ***(A) Extra for additional depth more than 5.0.M. for excavation for foundation including sorting out and stacking of useful materials disposing of the excavated stuff upto 50 M. lead in loose or soft soil.***
  - 1.0. **Workmanship :**
    - 1.1. The relevant specifications of item NO. 4.0.0.(A) shall be followed except that the excavation work shall be carried out from more than 5.0.M lift in loose or soft soil.
  - 2.0. **Mode of measurement and payment :**
    - 2.1. The relevant specifications of item No. 4.0.0. (A) shall be followed.
    - 2.2. The rate shall be paid extra over and above the rate of No. 4.002. (E) for carrying out excavation work for additional depth from 5.0 M. and above.
    - 2.3. The rate shall be for a unit of one cubic meter per meter.
- 4.003. ***(B) Extra for additional depth more than 5.0.M. for excavation for foundation including sorting out and stacking of useful materials disposing of the excavated stuff upto 50 M. lead in Dense or hard soil.***
  - 1.0. **Workmanship :**
    - 1.1. The relevant specifications of item NO. 4.0.0.(A) shall be followed except that the excavation work shall be carried out from more than 5.0.M lift in Dense or hard soil.
  - 2.0. **Mode of measurement and payment :**
    - 2.1. The relevant specifications of item No. 4.0.0. (A) shall be followed.
    - 2.2. The rate shall be paid extra over and above the rate of No. 4.002. (A) for carrying out excavation work for additional depth from 5.0 M. and above.
    - 2.3. The rate shall be for a unit of one cubic meter per meter.

**4.003. (C) Extra for additional depth more than 5.0.M. for excavation for foundation including sorting out and stacking of useful materials disposing of the excavated stuff upto 50 M. lead in Hard murrum.**

**1.0. Workmanship :**

**1.1.** The relevant specifications of item NO. 4.0.0.(C) shall be followed except that the excavation work shall be carried out from more than 5.0.M lift in Hard murrum.

**2.0. Mode of measurement and payment :**

**2.1.** The relevant specifications of item No. 4.0.0. (A) shall be followed.

**2.2.** The rate shall be paid extra over and above the rate of No. 4.002. (C) for carrying out excavation work for additional depth from 5.0 M. and above.

**2.3.** The rate shall be for a unit of one cubic meter per meter.

**4.003. (D) Extra for additional depth more than 5.0.M. for excavation for foundation including sorting out and stacking of useful materials disposing of the excavated stuff 5.0. M. lead in soft rock not requiring blasting..**

**1.0. Workmanship :**

**1.1.** The relevant specifications of item NO. 4.0.0.(D) shall be followed except that the excavation work shall be carried out from more than 5.0.M lift in soft rock not requiring blasting.

**2.0. Mode of measurement and payment :**

**2.1.** The relevant specifications of item No. 4.0.0. (A) shall be followed.

**2.2.** The rate shall be paid extra over and above the rate of No. 4.002. (D) for carrying out excavation work for additional depth from 5.0 M. and above.

**2.3.** The rate shall be for a unit of one cubic meter per meter.

**4.003. (E) Extra for additional depth more than 5.0.M. for excavation for foundation including sorting out and stacking of useful materials disposing of the excavated stuff upto 50 M. lead in Hard rock.**

**1.0. Workmanship :**

**1.1.** The relevant specifications of item NO. 4.0.0.(E) shall be followed except that the excavation work shall be carried out from more than 5.0.M lift in Hard rock.

**2.0. Mode of measurement and payment :**

**2.1.** The relevant specifications of item No. 4.0.0. (A) shall be followed.

**2.2.** The rate shall be paid extra over and above the rate of No. 4.002. (C) for carrying out excavation work for additional depth from 5.0 M. and above.

**2.3.** The rate shall be for a unit of one cubic meter per meter.

**4.12.** Filling available from excavated earth (excluding rock) in trenches, plinth sides of foundations etc. in layers not exceeding 20 CM in depth, consolidating each deposited layer by ramming and watering.

**1.0. Workmanship :**

**1.1.** The earth to be used for filling shall be free from salts, organic or other foreign matter, All clods of earth shall be broken.

**1.2.** As soon as the work in foundation has been completed and measured, the site of foundation shall be cleared of all debris, brick bats, mortar dropping etc; and filled with earth in layers not exceeding 20 Cms. Each layer shall be adequately watered rammed and consolidated before the succeeding layer is laid. The earth shall be rammed with iron rammers where feasible and with the butt ends of crow-bars, where rammer cannot be used.

**1.3.** The plinth shall be similarly filled with earth in layers not exceeding 20 Cms adequately watered and consolidated by ramming with iron or wooden rammers. When nfilling reaches finished level, the surface shall be flooded



with water for at least 24 hours and allowed to dry and then rammed and consolidated.

- 1.4. The finished level of filling shall be kept to shape intended to be given to floor.
- 1.5. In case of large heavy duty flooring like factory flooring, the consolidation may be done by power rollers, where so specified. The extent of consolidation required shall also be as specified.
- 1.6. The excavated stuff of the selected type shall be allowed to be used in filling the trenches and plinth. Under no circumstances black cotton soil be used for filling the plinth.

**2.0. Mode of measurement and payment :**

2.1. The payment shall be made for filling in plinth and trenches, No deduction shall be made for shrinkage or voids if consolidated as instructed above.

2.2. The rate shall be for a unit of one cubic meter.

4.24. *Filling in plinth with sand under floors including watering, ramming consolidated and dressing etc. complete.*

**1.0. Materials:**

1.1. **Sand shall conform to M. 6.**

**2.0. Workmanship:**

2.1. The relevant specifications of item No. : 4.12 shall be followed except that sand shall be filled in under floors, including watering, ramming, consolidation and dressing etc. complete.

**3.0. Mode of measurement and payment :**

3.1. The relevant specifications of item NO. 4.12 shall be followed.

3.2. The rate includes cost of collecting carting sand with all lead and labour for filling the same in plinth under floors.

3.3. The rate shall be for a unit of one cubic meter.

4.004.: *Filling in foundation and plinth with murrum or selected soil in layers of 20 cm. thickness including watering, ramming and consolidating etc. Complete.*

**1.0. Materials:**

1.1. Murrum shall be clean, of good binding quality, and of approved quality obtained from approved pots/quarries of disintegrated rocks which contain silicones materials and natural mixture of clay of calcareous origin. The size of murrum shall not be more than 20 mm.

**2.0. Workmanship:**

2.1. The relevant specifications of item No. 4.12 shall be followed except that the murrum or selected soil shall be filled in foundation and plinth in 20 cms. layers including consolidating , ramming, watering, dressing etc. complete.

**3.0. Mode of measurement and payment :**

3.1. The relevant specifications of item No. 4.12 shall be followed.

3.2. The rate includes cost of collecting and carting murrum/or selected earth of approved quality with all lead and labour required for filling in trenches and plinth.

3.3. The rate shall be for a unit of one cubic meter.

4.005 *Filling foundation and plinth with brick-bats/chhara in layers of 20 cms thickness including watering ramming and consolidating etc. complete.*

1.0 **Materials:** “Bricks bats shall conform to M-14.

2.0 **Workmanship:** The relevant specifications of item No. 4.12 shall be followed except that brick-bats of burnt bricks shall be filled in foundation and plinth in 20 cms layers including watering, ramming, consolidating etc. complete.

**3.0 Mode of measurement and payment:**

3.1 The relevant specifications of item No. 4.12 shall be followed.

3.2 The rate includes cost of collecting and carting brick/chhara with all lead and labour required for filling in trenches and plinth.

3.3 The rate shall be for a unit of one cubic meter.

4.27. *Boring holes 3.5 M. deep in ordinary soil (for cast in site piles) and getting out the soil and disposal of the surplus excavated soil as directed within a lead of 50 M. for following diameter for piles (I) 200 mm. (ii) 250 mm. (iii) 300 mm.*

**1.0. Workmanship :**

1.1. The ground shall be roughly leveled and after making the position of piles, the holes shall be bored with aspire angle to the 3.5 M. depth and specified diameter using boring guide.

1.2. The bore holes shall be truly vertical and uniform bore throughout of specified diameter. After boring to the required depth, the bore shall be cleared off the loose soil and disposal of surplus excavated stuff as directed within a lead of 50 M.

**2.0. Mode of measurement and payments :**

2.1. The rate for boring holes shall include :-

- (a) Roughly leveling the ground in positions where piles are to be provided.
- (b) Making the positions of piles by pegs and boring guide and also for shifting of boring guide.
- (c) Bailing out water, if any met with during boring.
- (d) Disposal of surplus excavated soil within a lead of 50 M. and
- (e) All tools, plants, equipment's and labor required for satisfactory completion of work.

2.2. The rate shall be for a unit of one number.

4.28. *Extra for under reaming inside the bore holes for under reamed piles of following nominal diameter. (I) 200 mm. (ii) 250 mm. (iii) 300 mm.*

1.0. **Workmanship :** The relevant specifications of item No. 4.27 shall be followed except that after boring to the required depth, the bore shall be enlarged at the bottom by an under reamer 2 to 2 ½ times the diameter of the bore as directed. It shall be ensured that the bore for the pile shall be enlarged to the correct diameter.

**2.0. Mode of measurement and payment :**

2.1. The relevant specifications of item No. 4.27 shall be followed.

2.2. The rate shall be paid extra over and above the rate of item No. 4.27 under reaming the piles.

2.3. The rate shall be for a unit of one Number.

## SECTION-5

### **DETAILED SPECIFICATIONS- PLAIN & RCC WORKS**

5.1.6. *Providing and laying in foundation and plinth/under floors concrete with hard broken aggregate 40 mm. nominal size and 40% mortar comprising of 1 Lime putty : 2 fine sand and curing complete excluding cost of form work.*

**1.0. Materials:**

1.1. Water shall conform to M-1. Sand shall conform to M-6. Lime shall conform to M-12.

**2.0. Workmanship:**

**2.1. General :**

2.1.1. Before starting the concrete the bed of the foundations trenches shall be cleared of all loose materials and watered and rammed as directed .

**2.2. Proportion of Mix :**

- 2.2.1. The proportion of lime, sand and aggregate shall be specified in the item of the work and shall be measured by volume.
- 2.2.2. The lime mortar shall consist of proportion of 1 Lime putty : 2 sand volume. The lime mortar shall be prepared by wet. process power driven mill shall be used for preparation of lime mortar. The slaked lime shall be placed in the Mill in even layers and ground for 180 revolutions with sufficient water, The water shall be added as required during grinding (and care shall be taken not to add more water) so that it will bring the mixed materials to a consistency of stiff paste, thoroughly wetted sand shall then be added evenly and the mixture ground for another 180 revolutions.
- 2.2.3. Lime mortar shall be kept damp, protected from sun and rain till used-up covering it by tarpaulin or open sheds.
- 2.2.4. All the lime mortar shall be used as soon as possible after grinding. It should be used on the day of which it is prepared but in no case mortar made earlier than 36 hours shall be permitted for use.
- 2.3. **Mixing :**
- 2.3.1. The concrete shall be mixed in mechanical mixer. Mixing shall be continued until there is uniform distribution of the material and the mass is uniform in colour and consistency but in no case mixing shall be done for less than 2 to 3 minutes.
- 2.4. **Laying & Compacting :**
- 2.4.1. The concrete shall always be used while quite fresh. It shall be laid (not thrown) in layers not exceeding 150 mm. in thickness and shall be well and quickly rammed with wooden or iron rammers, till the required compaction is achieved. The concrete laid shall not be of too fluid consistency. After it has been mixed no more water shall be added, but the surface during rough before the upper layer is laid. The concrete shall be kept continuously wet for period of 7 days from the date of placing or until it is built over whichever is more.
- 2.5. **Mode of measurement and payment :**
- 2.5.1. The concrete work shall be measured in length, breadth and depth as specified on drawing or as directed, correct upto nearest centimeter and cubical content shall be worked out nearest upto two places or decimals.
- 2.5.2. The rate shall be for a unit of one cubic meter.
- 5.1.8. *Providing and laying in foundation and plinth/under floors lime concrete with graded bricks aggregate 40 mm. nominal size and 40% mortar comprising of 1 Lime Putty : 9 fine sand and curing complete excluding cost of form work.*
- 1.0. **Materials :**
- 1.1. Water shall conform to M-1. Lime mortar shall conform to M-10. Brick bats aggregates 40 mm. nominal size shall conform to M-14.
- 2.0. **Workmanship:**
- 2.1. The relevant specifications of item No. 5.1.6. shall be followed except that brick aggregate shall be used instead of graded of graded stone aggregate.
- 3.0. **Mode of measurement and payment :**
- 3.1. The concrete work shall be measured in length, breath and depth as specified in drawing or as directed, correct upto nearest centimeter and cubical content shall be worked out upto two places of decimals.
- 3.2. The rate shall be for a unit of one cubic meter.
- 5.3.2. (A) *Providing and laying cement concrete 1:3:6 (1 cement : 3 coarse sand : 6 graded stone aggregates 40 mm. nominal size) and curing complete excluding the cost of form work in foundations and plinth.*
- 1.0. **Materials :**

- 1.1. Water shall conform to M-1. Sand shall conform M-6. Cement shall conform to M-3. Stone aggregate 40 mm. nominal size shall conform to M-12.
- 2.0. **Workmanship :**
- 2.1. **General :**
- 2.1.1. Before starting concrete bed of foundation trenches shall be cleared of all loose materials, leveled, watered, and rammed as directed.
- 2.2. **Proportion of Mix :**
- 2.2.1. The proportion of cement, sand and coarse aggregate shall be one part of cement, 3 parts of sand, 6 parts of stone aggregates and shall so measured by volume.
- 2.3. **Mixing :**
- 2.3.1. The concrete shall be mixed in a mechanical mixer at the site of work. Hand mixing may however be allowed for smaller quantity of work if approved by the Engineer-in-charge. When hand mixing is permitted by the Engineer-in-charge incase of break-down of machinery's and in the interest of the work. it shall be carried out on a water tight platform and care shall be taken to ensure that mixing is continued until the mass is uniform in colour and consistency. However in such cases 10% more cement than otherwise required shall have to be used without any extra cost. The mixing in mechanical mixer shall be done for a period 1 to 2 minutes. The quantity of water shall be sufficient to produce a dense concrete of required workability for the purpose.
- 2.4. **Transporting & Placing the concrete :**
- 2.4.1. The concrete shall be handled from the place of mixing to the final position in not more than 15 minutes by the method as directed and shall be placed into its final position, compacted and finished within 30 minutes of mixing with water i.e. before the setting commences.
- 2.4.2. The concrete shall be laid in layers of 15 cms. to 20 cms.
- 2.5. **Compacting :**
- 2.5.1. The concrete shall be rammed with heavy iron rammers and rapidly to get the required compaction and to allow all the interstices to be filled with mortar.
- 2.6. **Curing :**
- 2.6.1. After the final set, the concrete shall be kept continuously wet, if required by pounding for a period of not less than 7 days from the date of placement.
- 2.7. **Mode of measurement and payment :**
- 2.7.1. The concrete shall be measured for its length breadth and depth, limiting dimensions to those specified on plan or as directed.
- 2.7.2. The rate shall be for a unit of one cubic meter.
- 5.3.3. ***(A) Providing and laying cement concrete 1:4:8 (1 cement:4 coarse sand : 8 graded stone aggregate 40 mm. nominal size) and curing compete excluding cost of form work in foundations and plinth.***
- 1.0. **Materials :**
- 1.1. Water shall conform to M-1. Cement shall conform to M-3. Sand shall conform to M-6. Stone aggregate 40 mm. nominal size shall conform to M-12.
- 2.0. **Workmanship :**
- 2.1. Relevant specifications of item No. 15.3.2. shall be followed except that cement concrete shall be mixed in the proportion of 1:4:8 instead of 1:3:6 by volume.
- 3.0. **Mode of measurement and payment :**
- 3.1. The concrete shall be measured for its length, breadth and depth, limiting dimensions to those specified on plans or directed.
- 3.2. The rate shall be for a unit of one cubic meter.

**5.3.14 (A) Providing and laying cement concrete 1:3:6 (1 cement : 3 coarse sand : 6 crushed stone aggregate 20 mm. nominal size) and curing complete including cost of form work in wallcaps/coping.**

**1.0. Materials & Workmanship :**

**1.1.** The relevant specification of item No. 5.3.2. (A) shall be followed except that the work shall be carried out for coping and wall caps, except the stone aggregate 20 mm. nominal size shall be used for the concrete work of wall caps/coping.

**2.0. Mode of measurement and payment :**

**2.1.** The relevant specifications of item No. 5.3.2.(A) shall be followed except that the rate includes cost of necessary form work.

**2.1.** The rate shall be for a unit of one cubic meter per meter.

**5.3.3. (B) Providing and laying brick bats cement 1:4:8(1 cement :4 coarse sand :8 graded brick bats) and curing complete excluding the cost of from work in foundation and plinth.**

**1.1 Materials :**

**1.1** Water shall conform to M-1. Cement shall conform to M-3. Sand shall conform to M-6. Brick bat shall conform to M-14.

**2.0 Workmanship :**

**2.1** The specification of this item shall be followed as per item No. 5.3.3. except that the proportion of brick bat cement concrete shall be 1:4:8 i.e. 1 part of cement, 4 parts of coarse sand and 8 parts of graded brick bat by volume, using graded brick bat as coarse aggregate instead of stone aggregate.

**3.0 Mode of measurement and payments :**

**3.1.1** The concrete work shall be measured in length, breadth and depth as specified on drawing limiting dimensions to those specified on drawings or as directed.

**3.2** The rate shall be for a unit of one cubic meter.

**5.3.4 (a) : Providing and laying cement concrete 1:5:10 (1 cement : 5 coarse sand : 10 graded stone aggregate 40 mm. nominal size) and curing complete, excluding the cost of form work, for foundation and plinth.**

**1.0 Materials :**

**1.1** Water shall conform to M-1, Cement shall conform to M-3. Sand shall conform to M-6. Stone aggregate 40 mm. nominal size shall conform to M-12.

**2.0 Workmanship :**

**2.1** The relevant specification of item No 5.3.2.(A) shall be followed for the work except that the work is to be carried out in cement concrete 1:5:10.

**3.0 Mode of measurement and payment :**

**3.1** The concrete shall be measured for its length, breadth and depth. limiting dimensions to those specified on plans or as directed.

**3.2** The rate shall be for a unit of one cubic meter.

**5.3.8 (A) : Providing and laying cement concrete 1:5:10 (1 cement : 5 coarse sand : 10 graded bricks bats 10 mm. nominal size) and curing complete excluding, cost of form work in foundation and plinth.**

**1.0 Materials :**

**1.1** Water shall conform to M-1, sand shall conform to M-6. Cement shall conform to M-3. Brick bats shall conform to M-14.

**2.0 Workmanship :**

**2.1** The relevant specification of item No. 5.3.4 shall be followed except that brick bats aggregate shall be used instead of stone aggregate.

**3.0 Mode of measurement and payment :**

**3.1** The relevant specification of item No 5.3.4 shall be followed

**3.2** The rate shall be for a unit of one cubic meter.

**5.3.2 (B) : Providing and laying brick bat cement concrete : 1:3:6 (1 cement : 3 coarse sand : 6 graded brick bats) and curing complete excluding cost of form work in foundation and plinth.**

**1.0** The specification of item No. 5.3.2 (A) shall be followed except brick bats shall be used as coarse aggregate instead of graded stone aggregates.

**2.0** Mode of measurement & payment

**2.1** The relevant specification of item No.5.3.2 (A) shall be followed for made of measurement and payment except that it excludes the cost of form work.

**2.2** The rate shall be for a unit of one cubic meter.

**5.4.18 Providing throating or plaster drip and moulding to R.C.C. Chhajjas.**

**1.0** **Materials :** Water shall conform to M-1. Cement shall conform to M-3. Sand shall conform to M-6. Cement mortar shall conform to M-11.

**2.0** **Workmanship :**

**2.1** The work shall be carried out as directed. The proportion of mix for finishing touching shall be in CM. 1:2 by volume. Curing shall be done for not less than 7 days. The work shall be carried out in best workman like manner. The throating or plaster drip and moulding shall be one centimeter in thickness.

**5.7.5 Extra for providing and mixing water proofing or plaster drip and moulding shall be one centimeter in thickness.**

**2.0** **Workmanship :**

**2.1** The proportions of materials for the cement concrete shall be mentioned with the specification of that item. The quantity of water proofing materials to be added and the method of addition shall be as specified by manufacturers.

**2.2** **Mixing:**

**2.2.1** The mixing of the water proofing materials with cement, water or concrete shall be done according to the specifications of the manufacturer.

**3.0** **Mode of measurement and payment :**

**3.1** The payment is extra over and above the rate of concrete for mixing water proofing proper.

**3.2** The rate shall be for a unit of one liter of Kg. per quintal of cement in which water proofing material is added.

**5.7.1 Providing and laying damp proof course 25 mm thick cement concrete 1:2:4(1 cement : 2 coarse sand : 4 stone aggregate 10 mm nominal size) and curing complete.**

**1.0** The specifications of item No. 5.3.13 (A) of ordinary concrete with or without reinforcement shall be followed except that the size of the stone aggregate shall be 10 mm nominal size and the concrete work shall be carried out in 25 mm thick damp proof course.

**2.0** **Mode of measurement and payment :**

**2.1** The rate includes cost of all materials and labour required to complete the item.

**2.2** The rate shall be for a unit of one sq. meter.

**5.3.13 Providing and laying cement concrete 1:2:4 (1 cement : 2 coarse sand : 4 graded stone aggregate 20 mm nominal size) and curing complete excluding cost of form work in (A) foundation and plinth, (B) Independent piers, columns and pillars up to floor two level.**

**1.0** **Materials:** Water shall conform to M-1. Cement shall conform to M-3. Sand shall conform to M-6, Grit shall conform to M-8 Graded stone aggregate 20 mm nominal size shall conform to M-12.

**2.0** **General:**

**2.1** The concrete mix is not required to be designed by preliminary tests. The proportion of the concrete mix shall be 1:2:4 (1 cement : 2 coarse sand : 4

graded stone aggregate 10 mm nominal size) by volume. Concrete work shall have exposed concrete surface or as specified in the item.

- 2.2 The designation ordinary M-100, M-150, M-200, M-250 specified as per I.S. Correspond approximately to 1:3:6, 1:2:4, 1 1/2 :3 and 1:1:2 nominal mix of ordinary concrete by volume respectively.
- 2.3 The ingredients required for ordinary concrete containing one beg of cement of 50 Kg. by weight (0.0342 Cu. M) for different proportions of mix shall be as under:

Grade of concrete	Total quantity of dry aggregate by volume per 50 Kgs, of cement to be taken as the sum of individual volume of fine and coarse aggregates, maximum	Proportion of fine aggregate to coarse aggregate	Quantity of water per 50 Kgs. of cement maximum.
1	2	3	4
M-100 (1:3:6)	300 Liters	Generally 1:2 for fine aggregate by volume but subject to and upper limit of 1:1/2 and lower limit 1:3	34 Liters
M-150 (1:2:4)	220 "		32 "
M-200 (1:1 1/2 :3)	160 "		30 "
M-250 (1:1:2)	100 "		27 "

- 2.4 The water cement ratios shall not more than those specified in the above table. The cement content of the mix specified in the Table shall be increased if the quantity of water in a mix has to be increased to overcome the difficulties of placement and compaction so that the water cement ratio specified in the Table is not exceeded.
- 2.5 Work ability of the concrete shall be controlled by maintaining a water cement ratio that is bound to give a concrete mix which is just sufficiently wet to be placed and compacted without difficulty with the means available.
- 2.6 the maximum size of coarse aggregate shall be as large as possible within the limits specified but in no case greater than surround all reinforcement thoroughly and to fill the corners of the form.
- 2.7 For reinforced concrete work, coarse aggregates having a nominal size of 20mm are generally considered satisfactory.
- 2.8 For heavily reinforced concrete members as in the case of ribs of main beams the nominal maximum size of coarse aggregate should usually be restricted to 5 mm less than the minimum clear distance between the main bars, or 5 mm less than the minimum cover to the reinforcement whichever is smaller.
- 2.9 Where the reinforcement is widely spaced as in solid slabs, limitations of size of the aggregate may not be important and the nominal maximum size may sometimes be as greater than the minimum cover.
- 2.10 Admixture may used in concrete only with approval of Engineer-in-charge based upon the evidence that with the passage of time, neither the compressive strength of concrete is reduced nor are other requisite qualities of concrete and steel impaired by the use of such admixtures.
- 3.0 **Workmanship:**
- 3.1 **Proportioning:** Proportioning shall be done by volume, except cement which shall be measured in terms of bags of 50 Kg. weight. The volume of one such



bag being taken as 0.0342 Cu. Meter. Boxes of suitable sizes shall be used for measuring sand aggregate. The size of the boxes (internal) shall be 35 cms x 25 cms. and 40 cms deep. While measuring the aggregate and sand, the box shall be filled without shaking ramming or hammering. The proportioning of sand shall be on the basis of its dry volume and in case of damp sand, allowances for bulkage shall be made.

### **3.2 Mixing:**

**3.2.1** For all work, concrete shall be mixed in a mechanical mixer which along with other accessories shall be kept in first class working condition and so maintained throughout the construction. Measured quantity of aggregate, sand, cement required for each batch shall be poured into the drum of the mechanical mixer while it is continuously running. After about half a minute of dry mixing, measured quantity of water required for each batch of concrete mix shall be added gradually and mixing continued for another one and half a minute. Mixing shall be continued till materials are uniformly distributed and uniform color of the entire mass is obtained and each individual particle of the coarse aggregate shows complete coating of mortar containing its proportionate amount of cement. In no case shall the mixing be done for less than 2 minutes after all ingredients have been put into the mixer.

**3.2.2** When hand mixing is permitted by the Engineer-in-charge for small jobs or for certain other reasons, it shall be done on the smooth watertight platform large enough to allow efficient turning over the ingredients of concrete before and after adding water. Mixing platform shall be so arranged that no foreign material gets mixed with concrete nor does the mixing water flow out. Cement in required number of bags shall be placed in a uniform layer on top of the measured quantity of fine and coarse aggregate, which shall also be spread in a layer of uniform thickness on the mixing platform. Dry coarse and fine aggregate and cement shall then be mixed thoroughly by turning over to get a mixture to uniform color. Specified quantity of water shall then be added gradually through a rose-can and the mass turned over till a mix of required consistency is obtained. In hand mixing quantity of cement shall be increased by 10 percent above that specified.

**3.2.3** Mixers which have been out of use for more than 30 minutes shall be thoroughly cleaned before putting in a new batch. Unless otherwise agreed to by the Engineer-in-charge the first batch of concrete from the mixture shall contain only two thirds of normal quantity of coarse aggregate. Mixing plant shall be thoroughly cleaned before changing from one type of cement to another.

### **3.3 Consistency :**

**3.3.1** The degree of consistency which shall depend upon the nature of the work and methods of vibration of concrete, shall be determined by regular slump tests in accordance with I.S. 1199-1959. The slump of 10mm to 25mm. shall be adopted when vibrators are used and 80mm when vibrators are not used.

### **3.4 Inspection:**

**3.4.1** Contractor shall give the Engineer-in-charge due notice before placing any concrete in the forms to permit him to inspect and accept the false work and forms as to their strength, alignment, and general fitness but such inspection shall not relieve the contractor of his responsibility for the safety of men, machinery, materials and for results obtained. Immediately before concreting, all forms shall be thoroughly cleaned.

**3.4.2** Centering design and its erection shall be got approved from the Engineer-in-charge. One carpenter with helper shall invariably be kept present throughout



the period of concreting. Movement of labour and other persons shall be totally prohibited for reinforcement laid in position. For access to different parts, suitable mobile platforms shall be provided so that steel reinforcement in position is not disturbed. For ensuring proper cover, mortar blocks of suitable size shall be provided so that steel reinforcement in position is not disturbed. For ensuring proper cover, mortar blocks of suitable size shall be cast and tied to the reinforcement. Timber kapachi or metal pieces shall not be used for this purpose.

**3.5 Transporting and laying:**

**3.5.1** The method of transporting and placing concrete shall be as approved. Concrete shall be so transported and placed that no contamination, segregation or loss of its constituent material takes place.

All form work shall be cleaned and made free from standing water, dust, snow or ice immediately before placing of concrete.

No concrete shall be placed in any part of the structure until the approval of the Engineer-in-charge has been obtained.

**3.5.2** Concreting shall proceed continuously over the area between construction joints. Fresh concrete shall not be placed against concrete which has been in position for more than 30 minutes unless a proper construction joint is formed. Concrete shall be compacted in its final position within 30 minutes of its discharge from the mixer. Except where otherwise agreed to by the Engineer-in-charge concrete shall be deposited in horizontal layers to a compacted depth of not more than 0.45 meter when internal vibrators are used and not exceeding 0.30 meter in all other cases.

**3.5.3** Unless otherwise agreed to by the Engineer-in-charge, concrete shall not be dropped into place from a height exceeding 2 meters. When trunking or chutes are used they shall be kept close and used in such a way as to avoid segregation. When concreting has to be resumed on a surface which has hardened, it shall be roughened, swept clean, thoroughly wetted and covered with a 13 mm thick layer of mortar composed of cement and sand in the same ratio as in the concrete mix itself. This 13 mm layer of mortar shall be freshly mixed and placed immediately before placing of new concrete. Where concrete has not fully hardened, all laitance shall be removed by scrubbing the wet surface with wire or bristle brushes, care being taken to avoid dislodgment of any particles of coarse aggregate. The surface shall then be thoroughly wetted, all free water removed and then coated with neat cement grout. The first layer of concrete to be placed on this surface shall not exceed 150 mm in thickness and shall be well rammed against old work particular attention being given to corners and close spots.

**3.5.4** All concrete shall be compacted to produce a dense homogeneous mass with the assistance of vibrators, unless, otherwise permitted by the Engineer-in-charge for exceptional cases, such as concreting under water, where vibrators cannot be used. Sufficient vibrators in serviceable condition shall be kept at site so that spare equipment is always available in the event of breakdowns.

Concrete shall be judged to be compacted when the mortar fills the spaces between the coarse aggregate and begins to cream up to form an even surface. Compaction shall be completed before the initial setting starts i.e. within 30 minutes of addition of water to dry mixture. During compaction, it shall be observed that needle vibrators are not applied on reinforcement which is likely to destroy the bond between concrete and reinforcement.

**3.6 Curing:** Immediately after compaction, concrete shall be protected from weather including rain, running water, shocks, vibration, traffic, rapid

temperature changes, frost and drying out process. It shall be covered with wet sacking, hassain or other similar absorbant material approved, soon after the initial set and shall be kept continuously wet for a period of not less than 14 days from the date of placement. Masonary work over foundation concrete may be started after 48 hours of its laying but curing of concrete shall be continued for a minimum period of 14 days.

**3.7 Sampling and Testing of concrete:**

**3.7.1** Samples from fresh concrete shall be taken as per I.S. 1199-1959 and cubes shall be made, cured and tested at 7 days or 28 days as per requirements in accordance with I.S. 516-1959. A random sampling procedure shall be adopted to ensure that each concrete batch shall have a reasonable chance of being tested i.e. the sampling should be spread over the entire period of concreting and cover all mixing units. The minimum frequency of sampling of concrete of each grade shall be in accordance with following:

Quantity of concrete in the work	No. of samples	Quantity of concrete in the works	No. of samples
1-5 Cmt.	1	16-30 Cmt.	3
6-15 “	2	31-50 “	4

51 and above 4+ one additional for each additional 50 M. or part thereof.

**NOTE :** At least one sample shall be taken from each shift. Ten test specimens shall be made from each sample, five for testing at 7 days and the remaining five at 28 days. The samples of concrete shall be taken on each day of the concreting as per above frequency. The number of specimens may be suitably increased as deemed necessary by the Engineer-in-charge when procedure of tests given above reveals a poor quality of concrete and in other special cases.

**3.7.2** The average strength of the group of cubes cast for each day shall not be less than the specified cube strength of 150 Kg/Cm<sup>2</sup> at 28 days. 20% of the cubes cast for each day may have value less than the specified strength provided the lowest value is not less than 85% of the specified strength. If the concrete made in accordance with the proportions given for a particular grade, does not yield the specified strength; such concrete shall be classified as belonging to the appropriate lower grade. Concrete made in accordance with the proportions given for a particular grade shall not, however, be placed in a higher grade on the ground that the test strength are higher than the minimum specified.

**3.8 Stripping:**

**3.8.1** The Engineer-in-charge shall be informed in advance by the contractor of his intention to strike the form work. While fixing the time for removal of form work, due consideration shall be given to local conditions, character for the structure, the weather and other condition that influence the setting of concrete and of the materials used in the mix. In normal circumstances (generally where temperatures are above 20<sup>0</sup> C) and where ordinary concrete is used, forms may be struck after expiry of periods specified in item No 9.1(A) for respective item of form work.

**3.8.2** All form work shall be removed without causing any shock or vibration as would damage the concrete. Before the soffit and struts are removed, the concrete surface shall be exposed, where necessary in order to ascertain that the concrete has sufficiently hardened. Centering shall be gradually and uniformly lowered in such manner as to permit the concrete to take stresses

due to its own weight uniformly and gradually. Where internal metal ties are permitted, the or their removable parts shall be extracted without causing any damage to the concrete and remaining holes filled with mortar. No permanently embedded metal part shall have less than 25 mm cover to the finished concrete surface. Where it is intended to re-use the form work, it shall be cleaned and made good to the satisfaction of the Engineer-in-charge. After removal of form work and shuttering, the Executive Engineer shall inspect the work and satisfy by random checks that concrete produced is of good quality.

- 3.8.3** Immediately after the removal of forms, all exposed bolts etc., passing through the cement concrete member and used for shuttering or any other purpose shall be cut inside the cement concrete member to a depth of at least 25 mm below the surface of the concrete and the resulting holes be filled by cement mortar. All fine caused by form joints, all cavities produced by the removal of form ties and all other holes and depressions honeycomb spots, broken edges or corners and other defects shall be thoroughly cleaned, saturated with water and carefully pointed and rendered true with mortar of cement and fine aggregate mixed in the proportions used in the grade of concrete that is being finished and of as dry consistency as is possible to use. Considerable pressure shall be applied in filling and pointing to ensure thorough filling in all voids. Surfaces which are pointed shall be kept moist for a period of 24 hours.

If rock pockets/honeycombs in the opinion of the Engineer-in-charge are of such an extent or character as to effect the strength of the structure materially or to endanger the life of the steel reinforcement, he may declare the concrete defective and require the removal and replacement of the portion of the structure affected.

**4.0 Mode of measurement and payment:**

- 4.1** The consolidated cubical contents of concrete work as specified in item shall be measured. The concrete laid in excess of section shown on drawings or as directed shall not be measured. No deduction shall be made for –

- (a) Ends of dissimilar materials such as joints, beams, posts, girders, rafters, purline trusses, corbels and steps etc. up to 500 Sq. Cm. in section.  
(b) Opening up to 0.1 Sq. M.

- 4.2** The rate includes cost of all materials, labour, tools and plant required for mixing, placing in position, vibrating and compacting, finishing, as directed, curing and all other incidental expenses for producing concrete of specified strength. The rate excludes the cost of form work.

- 4.3** The rate shall be for a unit of one cubic meter.

- 5.4.1** Providing and laying cement concrete 1:2:4 (1 cement : 2 coarse sand : 4 graded stone aggregate 20 mm nominal size) and curing complete excluding cost of form work and reinforcement for reinforced concrete work in :

- 1.1** Foundation footing, base of columns and mass (B) Slabs, landings, shelves, balconies, internal beams girders and cantilever up to floor two level (C) Columns, pillars, posts and struts up to floor two level (D) Staircase up to floor two level (E) Vertical and horizontal fins up to floor two level.

**1.0 Materials & Workmanship**

- 1.1** The relevant specification of item No. 5.3.13 shall be followed except that the work shall be carried out for reinforced concrete work for work as specified in item 1.2. In addition, the following stipulations shall be followed for :

- 1.2** The bars shall be kept in position by the following methods:

- (i) In case of beam and slab construction, sufficient number of precast cover blocks in cement mortar 1:2 (1 cement : 2 coarse sand) about 4 cms x 4 cms

section and of thickness equal to the specified cover shall be placed between the bars and shuttering as to secure and maintain the requisite cover of concrete over the reinforcement.

In case of cantilevered or doubly reinforced beams of slabs, the main reinforcing bars shall be held in position by introducing chain spacers or supports bars at 1.0 to 1.2 meters centers.

- (ii) In case of columns walls, the vertical bars shall be kept in position by means of timber templates with slots accurately cut in them. The templates shall be removed after concreting has been done below it. The bars may also be suitably tied by means of annealed steel wires to the shuttering to maintain their position during concreting.

- 1.2** All bars projecting from pillars, columns beams, slabs etc., to which other bars and concrete are to be attached or bonded to later on, shall be protected with a coat of thin neat cement grout, if the bars are not likely to be incorporated with succeeding mass of concrete within the following 10 days. This coat of thin neat cement shall be removed before concreting.

**2.0 Mode of measurement and payment:**

- 2.1** Relevant specifications of item No. 5.3.13 shall be followed.

- 2.2** The volume occupied by reinforcement shall not be deducted from R.C.C. work.

- 2.3** The rate shall be for a unit of one cubic meter.

- 5.4.4** *Providing and laying cement concrete 1:2:4 (1 cement : 2 coarse sand : 4 graded stone aggregate 20 mm nominal size) for reinforced concrete chhajjas not exceeding 10 cms. thickness up to floor level including finishing the exposed surface with cement mortar 1:3 (1 cement : 3 fine sand) to give a smooth and even surface centering and form work and curing complete excluding cost of reinforcement.*

**1.0 Materials & Workmanship:**

- 1.3** The cement mortar shall conform to M-11

- 1.2** The relevant specifications of item No. 5.3.13 and 5.4.1 shall be followed except that the work shall be carried out for reinforced concrete chhajjas not exceeding 10 cms in thickness.

- 1.3** The specifications for form work and centering shall be as per item No. 91

- 1.4** The finishing work in cement mortar 1:3 (1 cement : 3 fine sand) shall be carried out as per specifications of item No. 17.59(I). Before the plastering is done, the surface of the concrete shall be raked for proper bond.

**2.0 Mode of measurement and payment:**

- 2.1** The relevant specifications of item No. 5.3.13 and 5.4.1 shall be followed except that the work of chhajjas up to 10 cms shall be carried out including centering form work and finishing the surface with cement mortar 1:3 (1 cement : 3 fine sand)

- 2.2** The rate shall be for a unit of one cubic meter.

- 5.4.10** *Providing Mild Steel reinforcement of R.C.C. work including bending binding and placing in position etc. complete up to floor two level.*

**2.0 Materials :**

- 2.1** Mild steel bars shall conform to M-18. Mild steel binding wires shall conform to M-21.

**3.0 Workmanship:**

- 3.1** The work shall consist of furnishing and placing reinforcement to the shape and dimensions shown as on the drawings or as directed.

- 3.2** Steel shall be clean and free from rust and loose mill scale at the time of fixing in position and subsequent concreting.

- 3.3** Reinforcing steel shall conform accurately to the dimensions given in the bar bending schedules shown on relevant drawings. Bars shall be bent cold to specified shape and dimensions or as directed using a proper bar bender, operated by hand or power to attain proper radius of bends. Bars shall not be bent or straightened in a manner that will injure the material. Bars bent during transport or handling shall be straightened before being used on the work. They shall not be heated to facilitate bending. Unless otherwise specified, a 'U' type hook at the end of each bar shall invariably be provided to main reinforcement. The radius of the bend shall not be less than twice the diameter of the round bar and the length of straight part of the bar beyond the end of the curve shall be at least four times the diameter of the round bar. In case of bars which are not round and in case of deformed bars, the diameter shall be taken as the diameter of circle having an equivalent effective area. The hooks shall be suitably encased to prevent any splitting of the concrete.
- 3.4** All the reinforcement bars shall be accurately placed in exact position shown on the drawing and shall be securely held in position during, metal hangers, supporting wires or other approved devices at sufficiently close intervals,. Bars shall not be allowed to sag between supports nor displaced during concreting or any other operations of the work. All devices used for positioning shall be of non-corrodible material. Wooden and metal supports shall no extend to the surface of concrete, except where shown on drawings. Placing of broken stone or brick and wooden blocks shall not be allowed. Pieces of broken stone or brick and wooden blocks shall not be used. Layers of bars shall be separated by spacer bars, precast mortar blocks or other approved devices. reinforcement after being placed in position shall be maintained in a clean condition until completely embedded in concrete. Special care shall be exercised to prevent any displacement of reinforcement in concrete already placed. To prevent reinforcement from corrosion, concrete cover shall be provided as indicated on drawings. All the bars producing from concrete and to which other bars are to be spliced and which are likely to be exposed for a period exceeding 10 days shall be protected by a thick coast of neat cement grout.
- 3.5** Bars crossing each other where required shall be secured by binding wires (annealed) of size not less than 1 mm in such manner that they do not slip over each other at the time of fixing and concreting.
- 3.6** As far as possible, bars of full length shall be used. In case this is not possible, overlapping of bars shall be done directed. When practicable, overlapping bars shall not touch each other, but be kept apart by 25 mm or 1.25 mm times the maximum size of the coarse aggregate whichever is greater by concrete between them. Where not feasible, overlapping bars shall be bound with annealed wires not less than 1 mm thick twisted tight. The overlaps shall be staggered for different bears and located at points along the span where neither shear nor bending movement is maximum.
- 3.7** Whenever indicated on the drawings or desired by the Engineer-in-charge, bars shall be joined by couplings which shall have a cross-section sufficient to transpit the full stresses of bars. The ends of the bars that are joined by coupling shall be upset for sufficient length so that the effective cross section at the base of threads is not less than normal cross-section of the bar. Threads shall be standard threads. Steel for coupling shall conform to I.S. 226
- 3.8** When permitted or specified on the drawings, joints of reinforcement bars shall be butt-welded so as to transmit their full stresses. Welded joints shall preferably be located at points when steel will not be subject to more than 75

percent of the maximum permissible stresses and welds so staggered that at any one section not more than 20 percent of the rods are welded. Only electric arc welding using a process which excludes air from the molten metal and conforms to any or all other special provisions for the work shall be accepted. Suitable means shall be provided for holding bars securely in position during welding. It shall be ensured that no voids are left in welding and when welding is done in two or three stages, previous surface shall be cleaned properly. Ends of the bars shall be cleaned of all loose scale, rust, grease, paint and other foreign matter before welding. Only competent welders shall be employed on the work. The M.S. electrodes used for welding shall conform to I.S. 814. Welded pieces of reinforcement shall be tested. Specimen shall be taken from the actual site and their number and frequency of test shall be as directed.

**3.0 Mode of measurement and payment :**

**3.1** For the purpose of calculation consumption, wastage shall not be permitted beyond 5 percent. Excess consumption over 5% will be charged at penal rate

**3.2** Reinforcement shall be measured in length including overlaps, separately for different diameters as actually used in the works. Where welding or coupling is resorted to in place of lap joints such joints shall be measured for a pimento as equivalent length of overlap as per design requirement. From the length so measured, the weight of reinforcement shall be calculated in tones on the same basis of as per M-18 even though steel is supplied to the contractor by the department on actual weight. Length shall include hooks at the ends. Wastage and annealed steel wire for binding shall not be measured and the cost of these items shall be deemed to be included in the rate for reinforcement.

**3.3** The rate for reinforcement includes cost of steel binding wires its carting from Department a store to work site, cutting, bending and fixing in position as shown on the drawings and as directed. It shall also include all devices for keeping reinforcement in approved position cost of joining as per approved method and all wastage and spacer bars.

**3.4** The rate shall be for a unit One Kg.

**5.4.11 High yield deform bars steel reinforcement for R.C.C. work including bending binding and placing in position complete up to floor two level.**

**1.0 Materials :**

**1.1.** Cold twisted steel bars (high yield strength steel deformed bars) shall be conform to M-19 Mild steel binding wires shall conform to M-21

**2.0 Workmanship :**

**2.1.** The specifications of item No 5.4.10 shall be followed except that the cold twisted steel bars shall be used with or without hooks and the ends. Deformed bars without hooks shall however comply with relevant anchorage requirements.

**3.0. Mode of measurement and payment :**

**3.1** The relevant specifications of item No. 5.4.10 shall be followed

**3.2** The rate shall be for a unit of One Kg.

**5.4.13 Extra for additional life of concrete for all R.C.C. work above floor two level excluding coast of reinforcement**

**1.0 Materials & Workmanship :** The relevant specification of item No 5.4.1 shall be followed for the work except that the R.C.C work shall be done for ground floor i.e. above plinth level to first floor level.

**2.0 Mode of measurement and payment:**

**2.1** The relevant specification of item no 5.4.1 shall be followed except that the rate shall be for extra lift above plinth to floor two level, over and above the rate of concrete at floor two level.



2.2 The rate shall be for unit of one cubic meter.

**5.4.13 (A) Extra for additional lift of reinforcement steel for all R.C.C. work above floor two level.**

**1.0 Materials & Workmanship:**

1.1 The relevant specifications of item No. 5.4.10 or 5.4.11 as may be applicable, shall be followed except that the work shall be carried out above floor two level for each floor.

**2.0 Mode of measurement and payment:**

2.1 The relevant specifications of item No. 5.4.10 or 5.4.11 as may be applicable shall be followed except that the work shall be carried above floor two level.

2.2 The rate shall be for unit of one Kg. per floor.

**5.6.2 Providing up to floor two level precast cement concrete jali or grill 1:2:4 (1 cement : 2 coarse sand : 4 graded stone aggregate 6 mm nominal size) reinforced with 1:6 mm dia mild steel wire including roughening, cleaning, fixing and finishing in cement mortar 1:3 and curing complete.**

**(A) 50 mm thick (B) 40 mm thick (C) 25 mm thick (D) 75 mm thick (E) 100 mm thick.**

**1.0 Materials :**

1.1 Water shall conform to M-1 (2) Cement shall conform to M-3 (3) Sand shall conform to M-6 (4) Mortar shall conform to M-11 (5) Aggregate shall conform to M-12 (6) Mild steel wire shall conform to M-21 (7) Shuttering shall conform to M-26.

**2.0 Workmanship:**

In shall be of cement concrete 1:2:4 (1 cement : 2 coarse sand : 4 graded stone aggregate 6 mm nominal size) reinforced with 1.6 mm dia mild steel wire unless other wise specified.

The thickness of jali shall be as specified in the item.

The jali shall be set in position true to line and level before the jambs sills and soffits of the opening are plastered. It shall then be properly cemented with cement mortar 1:3: (1 cement : 3 sand) and rechecked for levels. Finally the jambs, sills and soffits shall be plastered gripping the jali uniformly on all sides.

**3.0 Mode of measurement and payment:**

3.1 The item shall be measured in square meter.

3.2 The rate shall be for a unit of one square meter.

**5.8.1 Providing and laying controlled concrete M-150 and curing complete excluding the cost of form work and reinforcement for reinforced concrete work in :**

**(A) Foundations, footings, base of columns, and mass concrete. (B) Walls from top of foundations/level up to floor two level. (C) Slabs, landing shelves, Balconies, lintels, beams, girders, and cantilever, up to floor two level (D) Columns, pillars, posts, and struts, up to floor two level (E) Staircase up to floor two level (F) Vertical and horizontal fins up to floor two level.**

**1.0 Materials :**

1.1 Water shall conform to M-1. Cement shall conform to M-3. Sand shall conform to M-6. Grit shall conform to M-8. Coarse aggregate shall conform M-12 B.

**2.0 General:**

2.1 The relevant specifications of item no. 5.4.1 of ordinary concrete shall be followed except that the concrete mix shall be designed from preliminary tests, the proportioning of cement and aggregates shall be done by weight and necessary precautions shall be taken in the production to ensure that the

required work cube strength is attained and maintained. The controlled concrete shall be in grades of M-100, M-150, M-200, M-250, M-300, M-350, M-400, with prefix controlled added to it. The letter 'M' refers to mix and numbers specify 28 days works cube compressive strength of 150 mm cubes of the mix expressed in Kg. / Cmt.

- 2.2 The porportion of cement, sand and coarse aggregates shall be determined by weight. the weight batch machine shall be used for maintaining proper control over the porportion of aggregates as per mix design.

The strength requirements of different grades of concrete shall be as under:

Grade of Concrete	Compressive strength of 15 cms 28 days conducted in accordance Preliminary test Work test	cubes in Kg./Cmt. at with I.S. 516-1959
	Min	Min.
M-150	200	150
M-200	260	200
M-250	320	250
M-300	380	300
M-350	440	350
M-400	500	400

In all cases, the 28 days compressive strength specified in above table above be the criteria for acceptance or rejection of the concrete.

Where the strength of a concrete mix as indicated by tests, lies in between the strength of any two grades specified in the above table such concrete shall be classified in for all purposes as concrete belonging to the lower of the two grades between which its strength lies.

**Workmanship:**

- 3.0 The proportions for ingredients chosen shall be such that concrete has adequate workability for conditions prevailing on the work in question and can be properly compacted with means available except where it can be shown to the satisfaction of the Engineer-in-charge, that the supply of properly graded aggregate of uniform quality can be maintained till the completion of work. Grading of aggregate shall be controlled by obtaining the coarse aggregates, in different sizes and being in them in the right proportions as required. Aggregate of different sizes shall be stocked in separate stock piles. The required quantity of material shall be stock piled several hours, preferably a day before use. The grading of coarse and fine aggregate shall be checked as frequently as possible, the frequency for a given job being determined by the Engineer-in-charge to ensure that the suppliers are maintaining the uniform grading as approved for samples used in the preliminary tests.
- 3.2 In proportioning concrete, the quantity of both cement and aggregate shall be determined by weight. Where the weight of cement is determined by accepting the maker's weight per bag a reasonable number of bags shall be weighted separately to check the net weight. Water shall either be measured by volume in calibrated tanks or weighed. All measuring equipments shall be maintained in clean and serviceable condition. Their accuracy shall be periodically checked.
- 3.3 In is most important to keep the specified water cement ratio constant and at its correct value. To this end, moisture content in both fine and coarse aggregates shall be determined by the Engineer-in-charge, according to the weather conditions. The amount of mixing water shall then be adjusted to compensate for variations in the moisture content. For the determination of moisture



content in the aggregates, I.S. 2389(Part III) shall be referred to. Suitable adjustments shall also be made in the weights of aggregates due to variation in their moisture content. Minimum quantity of cement to be used in concrete shall not be less than 220 Kgs./M<sup>3</sup> in plain concrete and not less than 250 Kg/M<sup>3</sup> in reinforced concrete.

**4.0 Mode of measurement and payment:**

4.1 The relevant specifications item No. 5.4.1 shall be followed except that the controller concrete R.C.C. work for work as specified in item shall be measured under this item. The rate excludes cost of form work.

4.2 The rate shall be for a unit of one cubic meter.

**5.8.2 Providing and laying controlled cement concrete M-200 and curing complete, excluding the cost of form work and reinforcement for reinforced concrete work in:**

*(A) foundations, footings, base of columns and mass concrete. (B) Walls from top of foundation up to floor two level (D) Columns pillars posts and struts up to floor two level (E) Stair cases up to floor two level (K) Vertical and horizontal fins up to floor two level.*

**1.0 Materials & Workmanship:**

The relevant specifications of item No. 5.8.1 shall be followed except that the grading of concrete shall be controlled concrete M-200 grades for the work as specified in item.

**2.0 Mode of measurement and payment:**

2.1 The relevant specifications of item No. 5.8.1 shall be followed.

2.2 The rate shall be for one cubic meter.

**5.8.3 Providing and laying controlled cement concrete M-250 and curing complete excluding the cost of reinforcement for reinforced concrete work in:**

*(A) Foundations, footings, bases of columns and the like and mass concrete (B) Walls from top of foundation level up to floor two level (C) Slabs, landings shelves, balconies, beams, girders and cantilever up to floor two level (D) Columns, pillars, struts up to two level.(E) Stair cases upto floor two level (F) Vertical and horizontal fins upto floor two level.*

**1.0 Materials & Workmanship :**

1.1. The relevant specifications of item No. 5.8.1 shall be followed except that the grading of concrete shall be controlled concrete M-250 grades for the works as specified in the item.

**2.0 Mode of measurement and payment:**

2.1 The relevant specifications of item No. 5.8.1 shall be followed.

2.2 The rate shall be for a unit of one cubic meter.

**5.001 Providing and laying ordinary cement concrete 1:2:4 (1 cement : 2 coarse sand : 4 graded stone aggregates 20 mm nominal size) and finishing smooth with curing etc., complete including the cost of form work but excluding the cost of reinforcement of R.C.C. work in :**

*(I) Slabs up to 8 cms thickness (II) Slab having more than 8 cms and up to 10 cms thickness (III) Slab having more than 10 cms and up to 13 cms thickness (IV) Slab having more than 13 cms and up to 15 cms thickness.*

**1.0 Materials & Workmanship :**

1.1 The relevant specifications of item No 5.4.1 shall be followed for concrete work and relevant specifications of item No. 9.1 shall be followed for form work and centering work. The concrete surface shall be smooth finished in cement mortar 1:3 (1 cement : 3 fine sand) as per item No. 17.59 (1) The thickness of the slab shall be as specified in the item.

**2.0 Mode of measurement and payment:**

**2.1** The relevant specifications of item 5.4.1 shall be followed except that the item includes cost for providing form work and centering work as directed.

**2.2** The rate shall be for a unit of one cubic meter.

**5.002** *Providing and laying controlled cement concrete M-150 and finishing smooth with curing etc. complete including the cost of form work but excluding the cost of reinforcement for R.C.C. work in:*

*(I) Slabs up to 8 cms thickness (II) Slabs more than 8 cms and up to 10 cms (III) Slabs more than 10 cms and up to 13 cms (IV) Slabs more than 13 cms and up to 15 cms.*

**1.0 Materials & Workmanship:**

**1.1** The relevant specifications of item No. 5.8.1 shall be followed for concrete work and item no 9.1 shall be followed for form work and centering. The concrete surface shall be smooth finished with cement mortar 1:3 (1 cement : 3 fine sand) as per item No. 17.59 (1) The thickness shall be as specified in the item

**2.1** The relevant specification for item No. 5.8.1 shall be followed except that the item shall include the cost and form work and centering.

**2.2** The rate shall be for a unit of one cubic meter.

**5.003** *Providing and laying ordinary cement concrete 1:2:4 (1 cement : 2 coarse sand : 4 graded stone aggregates 20 mm nominal size exposed work with curing etc. complete including the cost of form work but excluding the cost of reinforcement for R.C.C. work in (I) Slab up to 8 cms thickness (II) Slabs having more than 8 cms and up to 10 cms thickness (III) Slabs having more than 10 cms and up to 13 cms thickness (IV) Slabs having more than 13 cms and up to 15 cms thickness.*

**1.0 Materials & Workmanship :**

**1.1** The relevant specifications of item No. 5.4.1 shall be followed for concrete work and that of form work and centering work shall be followed as per item No. 9.1 and 9.7. The thickness of the slab shall be as specified in the item.

**2.0 Mode of measurements and payment:**

**2.1** The relevant specifications of item No. 5.4.1 shall be followed except that form work and centering work shall be included in the item.

**2.2** The rate shall be for a unit of one cubic meter.

**5.004** *Providing and laying controlled cement M-150 exposed work with curing etc. complete including the cost of form work but excluding the cost of reinforcement for R.C.C. work in:*

*(I) Slabs up to 8 cms thickness (II) Slabs having more than 8 cms and up to 10 cms thickness (III) slabs having more than 10 cms and up to 13 cms thickness (IV) Slabs having more than 13 cms thickness.*

**1.0 Materials & Workmanship :**

**1.1** The relevant specifications of item No 5.4.1 shall be followed for controlled concrete and the relevant specifications of item No 9.1 and 9.7 shall be followed for exposed concrete form work and centering work. The thickness of the slab shall be as specified in the item.

**2.0 Mode of measurements and payment:**

**2.1** The relevant specifications of item No. 5.8.1 shall be followed except that the form work and centering work shall be included in the item.

**2.2** The rate shall be for a unit of one cubic meter.

**5.005** *Providing and laying ordinary cement concrete 1:2:4 (1 cement : 2 coarse sand : 4 graded stone aggregate 20 mm nominal size) for R.C.C. lintel*

*including finishing smooth with curring etc. complete including the cost of form work but excluding the cost of reinforcement.*

**1.0 Materials & Workmanship :**

**1.1** The relevant specifications of item No. 5.4.1 shall be followed for concrete work relevant specifications of item No. 17.59 (I) for finishing work and relevant specifications of item No. 9.1 shall be followed for form work and centering work. The concrete work shall be followed for the form work and centering work for exposed concrete work.

**2.0 Mode of measurement and payment:**

**2.1** The relevant specifications of item No. 5.8.1 shall be followed except that the item includes the cost of form work and centering work for exposed concrete work.

**2.2** The rate shall be for a unit of one cubic meter.

**5.006** *Providing and laying ordinary cement concrete 1:2:4 (1 cement : 2 coarse sand : 4 graded stone aggregate 20 mm nominal size) and finishing smooth with curing etc. complete including the cost of form work but excluding reinforcement for R.C.C. work in :*

**(A) Beams :** (I) Having cross sectional area 0.05 to 0.08 Sq. meter (II) Having cross sectional area more than 0.08 Sq. mt. up to 0.12 Sq. mt. (III) Having cross sectional area more than 0.12 Sq. mt. up to 0.18 Sq. mt.

**(B) Columns :** (I) Having cross sectional area 0.05 to 0.08 Sq. mt. (II) Having cross sectional area more than 0.08 Sq. mt. and up to 0.12 Sq. mt. (III) Having cross sectional area more than 0.12 Sq. mt. and up to 0.18 Sq. mt.

**1.0 Materials & Workmanship:**

**1.1** The relevant specification of item No. 5.4.1 shall be followed for concrete work and item no. 9.1 shall be followed for form work and centering work. The finishing shall be done in cement mortar 1:3 (1 cement : 3 fine sand) as per item No. 17.59 (I) The cross sectional area of beam shall be specified in item.

**2.0 Mode of measurements and payment:**

**2.1** The relevant specifications of item No. 5.4.1 shall be followed but the form work and centering work shall be included in the item.

**2.2** The rate shall be for a unit of one cubic meter.

**5.007** *Providing and laying controlled cement concrete M-150 exposed work with curing etc. Complete including the cost of form work but excluding the cost of reinforcement for R.C.C. work in:*

**(A) Beams :** (I) Having cross sectional area 0.05 to 0.08 Sq. mt. (II) Having cross sectional area more than 0.08 Sq. mt. up to 0.12 Sq. mt. (III) Having cross sectional area more than 0.12 Sq. mt. and up to 0.18 Sq. mt.

**(B) Columns:** (I) Having cross sectional area of 0.05 Sq. mt. to 0.08 Sq. mt. (II) Having cross sectional area more than 0.08 Sq. mt. and up to 0.12 Sq. mt. (III) Having cross sectional are amore than 0.12 Sq. mt. and up to 0.18 Sq. mt.

**1.0 Materials & Workmanship:**

**1.1** The relevant specifications of item No. 5.8.1 shall be followed for controlled concrete work for work as specified in item for M-200 and relevant specifications of item 9.1 and 9.7 shall be followed for the form work and centering work for exposed cement work.

**2.0 Mode of measurements and payment:**

**2.1** The relevant specifications of item No. 5.8.1 shall be followed excepted that the form work and centering work shall be included in the item.

**2.2** The rate shall be for a unit of one cubic meter.

**5.008** *Providing and laying controlled cement concrete M-200 exposed work with curing etc. complete including the cost of form work but excluding the cost of reinforcement for R.C.C. work in :*

(A) *Beams : (I) Having cross sectional area 0.05 Sq. mt. (II) Having cross sectional area 0.08 Sq. mt. up to 0.12 Sq. mt. (III) Having cross sectional area 0.12 Sq. mt. up to 0.18 Sq. mt.*

(B) *Columns : (I) Having cross sectional area 0.05 Sq. mt. (II) Having cross sectional area more than 0.08 Sq. mt. and up to 0.12 Sq. mt. (III) Having cross sectional area more than 0.12 Sq. mt. and up to 0.18 Sq. mt.*

**1.0 Materials & Workmanship:**

**1.1** The relevant specifications of item No. 5.8.1 shall be followed for controlled concrete work as specified in item for M-200 and relevant specifications of item 9.7 and 9.1 shall be followed for the form work and centering work for exposed cement work.

**2.0 Mode of measurements and payment:**

**2.1** The relevant specifications of item No. 5.8.1 shall be followed except that item includes the cost of form work and centering work for exposed work.

**2.2** The rate shall be for a unit of one cubic meter.

**5.009** *Providing and laying controlled cement concrete M-250 exposed work with curing etc. complete including the cost of form work but excluding the cost of reinforcement for R.C.C. work in -*

(A) *Beams : (I) Having cross sectional area 0.05 to 0.08 Sq. mt. (II) Having cross sectional area more than 0.08 Sq. mt. and up to 0.12 Sq. mt. (III) Having cross sectional area more than 0.12 Sq. mt. and up to 0.18 Sq. mt.*

(B) *Columns: (I) Having cross sectional area 0.05 to 0.08 Sq. mt. (II) Having cross sectional area more than 0.08 Sq. mt. and up to 0.12 Sq. mt. (III) Having cross sectional area more than 0.12 Sq. mt. and up to 0.18 Sq. mt.*

**1.0 Materials & Workmanship:**

**1.1** The relevant specifications of item No. 5.8.1 shall be followed for controlled concrete work for the work as specified in the item for M-250 and the relevant R.C.C. lintels shall be carried out.

**2.0 Mode of measurement and payment:**

**2.1** The relevant specifications of item no. 5.4.1 shall be followed except that the cost of form work finishing and centering shall be included in the item.

**2.2** The rate shall be for a unit of one cubic meter.

## SECTION – 6

### DETAILED SPECIFICATIONS – MASONRY WORK

**6.12** (A) *Brick work using common burnt clay building bricks having crushing strength not less than 35 kg/Sq. cm. in foundations and plinth in cement mortar 1:5 (1 cement : 5 fine sand) modular bricks.*

**1.0 Materials:** Water shall conform to M-1 Cement shall conform to M-3 Sand shall conform to M-6. Brick shall conform to M-15 Cement mortar shall conform to M-11.

**2.0 Workmanship:**

**2.1 Proportion:**

**2.1.1** The proportion of the cement mortar shall be 1:5 (1 cement : 5 fine sand) by volume.

**2.2 Wetting of bricks:**

**2.2.1** The bricks required for masonry shall be thoroughly wetted with clean water for about two hours before use or as directed. The cessation of bubbles, when the bricks are wetted with water is an indication of through wetting of bricks.

**2.3 Laying:**

**2.3.1** Bricks shall be laid in English bond unless directed otherwise. Half or cut bricks shall not be used except when necessary to complete to bond; closer in such case shall be cut to required size and used near the ends of walls.

**2.3.2** A layer of mortar shall be spread on full width for suitable length of the lower course. Each brick shall first be properly bedded and set home by gently tapping with handle of trowel or wooden mallet. Its side face shall be flushed with mortar before the next brick is laid and pressed against it. On completion of course, the vertical joints shall be fully filled from the top with mortar.

**2.3.3** The walls shall be taken up truly in plumb. All courses shall be laid truly horizontal and all vertical joint shall be truly vertical. Vertical joints in alternate course shall generally be directly one over the other. The thickness of brick course shall be kept uniform.

**2.3.4** The brick shall be laid with frog upwards. A set of tools comprising of wooden straight edges, mason's spirit level, square half meter rub, and pins, string and plumb shall be kept on the site of work for frequent checking during the progress of work.

**2.3.5** Both the faces of walls of thickness greater than 23 cms shall be kept in proper place. All the connected brick work shall be kept not more than one meter over the rest of the work. Where this is not possible, the work shall be raked back according to bond (and not left toothed) at an angle not steeper than 45 degrees.

**2.3.6** All fixtures, pipes, outlets of water, hold fasts of doors and windows etc. which are required to be built in wall shall be embedded in cement mortar.

**2.4 Joints:**

**2.4.1** Bricks shall be so laid that all joints are quite flush with mortar. Thickness of joints shall not exceed 12 mm. The face joints shall be raked out as directed by taking tools daily during the progress of work, when the mortar is still green so as to provide key for plaster or pointing to be done.

**2.4.2** The face of brick shall be cleaned the very day on which the brick work is laid and all mortar dropping removed.

**2.5 Curing**

**2.5.1** Green work shall be protected from rain suitably. Masonry work shall be kept moist on all the faces for a period seven days. The top of masonry work shall be kept well wetted at the close of the day

**2.6 Preparation of foundation bed:**

**2.6.1** If the foundation is to be laid directly on the excavated bed, the bed shall be leveled, cleared of all loose materials, cleaned and wetted before starting masonry. If masonry is to be laid on concrete footing, the top of concrete shall be cleaned and moistened. The contractor shall obtain the engineer's approval for the foundation bed, before foundation masonry is started. When pucca flooring is to be provided flush with the top to plinth, the inside plinth offset shall be kept lower than the outside plinth top by the thickness of the flooring.

**3.0 Mode of measurements and payment:**

**3.1** The measurements of this item shall be taken for the brick masonry fully completed in foundation up to plinth. The limiting dimensions not exceeding those shown on the plans or as directed shall be final. Battered, tapered and curved portions shall be measured net.

- 3.2** No deduction shall be made from the quantity of brick work nor any extra payment made for embedding in masonry or making holes in respect of following items:
- (1) Ends of joints, beams, posts, girders, rafters, purlins, trusses, corbel steps etc. where cross sectional area does not exceed 500 Sq. cm.
  - (2) Opening not exceeding 1000 Sq. cm.
  - (3) Wall plates and bed plates, bearing of slabs, chhajjas and the like whose thickness does not exceed 10 Cms. and the bearing does not extend to the full thickness of wall.
  - (4) Drainage holes, and recesses for cement concrete blocks to embed hold fasts for doors, windows etc.
  - (5) Iron fixtures, pipes up to 300 mm dia hold fasts and doors and windows built into masonry and pipes etc. for concealed wiring.
  - (6) Forming chases of section not exceeding 350 Sq. Cm. in masonry.
- 3.3** Apertures for fire places shall not be deducted nor shall extra labour required to make splaying of jambs, throating and making Arches over the aperture be paid for separately.
- 3.4** The rate shall be for a unit of one cubic meter.
- 6.12 (B) Brick work using common burnt clay building bricks having crushing strength not less than 35 Kg/Sq. Cm. in foundations and plinth in cement mortar 1:5 (1 cement : 5 fine sand) conventional bricks,**
- 1. Materials:** Cement mortar of proportion 1:5 shall conform to M-11. Conventional bricks shall conform to M-15
  - 2. Workmanship:** The relevant specifications of item No. 6.12(A) shall be followed except that the masonry work shall be carried out by using conventional bricks.
- 3.0 Mode of measurements and payment:**
- 3.1** The relevant specifications of item No 6.12 shall be followed.
- 3.2** The rate shall be for a unit of one cubic meter.
- 6.13 (A) Brick work using common burnt clay building bricks having crushing strength not less than 35 Kg/Sq. Cm. in foundation and plinth in cement mortar 1:6 (1 cement : 6 fine sand) with modular bricks.**
- 1.0 Materials:** Water shall conform to M-1. Cement mortar shall conform to M-11. Bricks shall conform to M-15.
  - 2.0 Workmanship:**
  - 2.1.** The relevant specifications of item No. 6.12(A) shall be followed except that the bricks to be used shall be conventional bricks and proportion of cement mortar shall in C.M. 1 : 6
  - 3.0 Mode of measurements and payment:**
  - 3.1** The relevant specifications of item No. 6.12(A) shall be followed.
  - 3.2** The rate shall be for a unit of one cubic meter
- 6.0.01 (A) Brick work using common burnt clay building bricks having crushing strength not less than 35 Kg/Sq. Cm. in foundation and plinth in cement mortar 1:8(1 cement : 8 fine sand) with Modular bricks.**
- 1.0 Materials:** Water shall conform to M-1, Cement mortar shall conform to M-11. Bricks shall conform to M-15.
  - 2.0 Workmanship:**
  - 2.2** The relevant specifications of item No. 6.12(A) shall be followed except that the proportion of mortar shall be C.M. 1:8
  - 3.0 Mode of measurements and payment:**
  - 3.1** The relevant specifications of item No. 6.12(A) shall be followed.
  - 3.2** The rate shall be for a unit of one cubic meter.



**6.0.01 (B) Brick work using common burnt clay building bricks having crushing strength not less than 35 Kg/Sq. Cm. in foundation and plinth in cement mortar 1:8 (1 cement : 8 fine sand) with conventional bricks.**

**1.0 Materials:** Water shall conform to M-1. Brick shall conform to M-15. Cement mortar shall conform to M-11.

**2.0 Workmanship:**

**2.1** The relevant specifications of item No. 6.12 (A) shall be followed except that the proportion of cement mortar shall be 1: 8 and bricks used shall be conventional bricks.

**3.0 Mode of measurements and payment:**

**3.1** The relevant specifications of item No. 6.12 (A) shall be followed.

**3.2** The rate shall be for a unit of one cubic meter.

**6.0.02 (A) Brick work using common burnt clay building bricks having crushing strength not less than 35 Kg/Sq. Cm. in foundation and plinth in lime mortar 1:1.5(1 lime putty : 1.5 fine sand) modular bricks.**

**1.0 Materials:** Lime mortar of proportion (1:1.5) shall conform to M-10. Bricks shall conform to M-15.

**2.0 Workmanship:** The relevant specifications of item No. 6.12 (A) shall be followed except the masonry work shall be carried out in lime mortar 1:1.5 (1 lime putty :1.5 fine sand) in foundation and plinth.

**3.0 Mode of measurements and payment:**

**3.1** The relevant specifications of item No. 6.12(A) shall be followed.

**3.2** The rate shall be for a unit of one cubic meter.

**6.0.02 (B) Brick work using common burnt clay building bricks having crushing strength not less than 35 Kg/Sq. Cm. in foundation and plinth in lime mortar 1:1.5(1 lime putty : 1.5 fine sand) conventional bricks.**

**1.0 Materials & Workmanship:** The relevant specifications of item No. 6.12(A) and 6.0.02(A) shall be followed except that the masonry work shall be carried out in lime mortar 1:1.5 (1 lime putty : 1.5 fine sand) in foundation and plinth.

**2.0 Mode of measurements and payment:**

**2.1** The relevant specifications of item No. 6.12 (A) shall be followed.

**6.0.03 (A) Brick using common burnt clay building bricks having crushing strength not less than 35 Kg/Sq. Cm. in foundation and plinth in lime mortar 1:2 (1 lime putty : 2 fine sand) modular bricks.**

**1.0 Materials & Workmanship:** The relevant specifications of item No. 6.12(A) and 6.00(A) shall be followed except that the masonry work shall be carried out in lime mortar 1:2 (1 lime putty : 2 fine sand) in foundation and plinth.

**2.0 Mode of measurements and payment:**

**2.1** The relevant specifications of item No. 6.12 (A) shall be followed.

**2.2** The rate shall be for a unit of one cubic meter.

**6.0.03 (B) Brick work using common burnt clay building bricks having crushing strength not less than 35 Kg/Sq. Cm. in foundation and plinth in lime mortar 1:2 ( 1 lime putty :2 fine sand) conventional bricks.**

**1.0 Materials & Workmanship:** The relevant specifications of item No. 6.12 (A) and 6.0.03(A) shall be followed except that the masonry work shall be carried out in lime mortar 1:2(1 lime : 2 fine sand) using conventional brick in foundation and plinth.

**2.0 Mode of measurements and payment:**

**2.1** The relevant specifications of item No. 6.12 (A) shall be followed.

**2.2** The rate shall be for a unit of one cubic meter

**6.19 (A) Brick work using common burnt clay building bricks having crushing strength not less than 35 Kg/Sq. Cm. for super structure above plinth level**

*up to floor two level in cement mortar 1:5 (1 cement : 5 fine sand) modular bricks.*

**1.0 Materials:** Bricks shall conform to M-15. Cement mortar shall conform M-11.

**2.0 Workmanship:**

**2.1** The relevant specifications of item No. 6.12(A) shall be followed except that the masonry work shall be carried out above plinth level to floor two level i.e. for ground floor.

**2.2** The frames of doors, windows, cupboards, etc. shall be housed into the brick work at the correct location and level as directed. The heavy steel doors, window frames etc. shall be built in with brick work but for ordinary steel doors and windows required opening for frames, hold fasts etc. shall be left in the wall and frames embedded later on in order to avoid damage to the frames.

**2.3** Necessary scaffolding shall be provided. The supports of the scaffolding shall be sound and strong tied together with horizontal pieces over which the scaffolding planks shall be fixed. Simple scaffolding shall be allowed normally. In this case scaffolding hole shall rest in hold header horizontal coarse only. Minimum number of holes shall be left in brick work for supporting horizontal scaffolding holes.

The contractor is responsible for providing and maintaining sufficiently strong scaffolding so as to withstand all loads likely to come upon it.

**2.4** For the face of brick work where plastering is to be done joints shall be racked out to a depth not less than thickness of joints. The face of brick work shall be cleaned and mortar dropping removed on very same day that brick work is laid.

**3.0 Mode of measurement:**

**3.1** The masonry work of G. F. i.e. above plinth level to floor two level shall be measured and paid under this item.

**3.2** Brick work in parapet shall be included in the corresponding masonry item of store immediately below the floor above which the parapet is built.

**3.3** No deduction shall be made from quantity of brick work. No extra payment shall be made for embedding in masonry or making holes in respect of following items:

1. Ends of joints, beams, posts, girders, rafters, purlins trusses corbel, steps etc. where cross sectional does not exceed 500 Sq. Cm.
2. Opening not exceeding 1000 Sq. Cm.
3. Wall plate, sand bed plates, bearing of slab, chhajjas and like whose thickness does not exceed 10 Cms. and the bearing does not extend the full thickness of wall.
4. Drainage holes and recesses for cement concrete blocks to embed hold fasts for doors, windows etc.
5. Iron fixtures, pipes up to 300 mm dia hold fasts of doors, and windows built into masonry and pipes etc. for concealed wiring.
6. Forming charges of section not exceeding 350 Sq. Cm. in masonry.
7. Apertures for fire places, shall not be deducted nor shall extra labour required to make spaying of jambs, throating and making trenches over the aperture be paid for separately.

**3.4** The rate shall be for a unit of one cubic meter

**6.19 (B) Brick work using common burnt clay building bricks having crushing strength not less than 35 Kg/Sq. Cm. for super structure above plinth up to floor two level in cement mortar 1:5 (1 cement : 5 fine sand) conventional bricks.**



- 1.0 Materials & Workmanship:** The relevant specifications of item No 6.19 (A) shall be followed except that brick masonry work shall be carried out with conventional bricks.
- 2.0 Mode of measurements and payment:**
- 2.1** The relevant specifications of item No. 6.19(A) shall be followed.
- 2.2** The rate shall be for a unit of one cubic meter.
- 6.20 Extra for brick in super structure above floor two level.**
- 1.0 Materials & Workmanship:** The relevant specifications of item masonry work to be carried out shall be followed except that this work is for additional lift of one floor above floor two level.
- 2.0 Mode of measurements and payment:**
- 2.1** The relevant specifications of item no. 6.19 (A) masonry work shall be followed.
- 2.2** The extra payment shall be made for additional life above floor two level to each additional floor over and above the rate of masonry work.
- 2.3** The rate shall be for a unit of one cubic meter.
- 6.30.I. (A) Half brick masonry in common burnt clay building bricks having crushing strength note less than 35 Kg/Sq. Cm. in cement mortar 1:4 (1 cement : 4 coarse sand) in super structure above plinth level up to floor two level with modular bricks.**
- 1.0 Materials:** Brick shall conform to M-15. Water shall conform to M-1. Cement shall conform to M-3. Sand shall conform to M-6. Cement mortar shall conform to M-11.
- 2.0 Workmanship:**
- 2.1** Relevant specifications of bricks, wetting and laying of bricks, joints, curing etc. shall conform to item No 6.19 (A) except the brick work of half bricks shall be carried out.
- 2.2** Cement mortar used in masonry work shall be in proportion of 1 part of cement and 4 part of sand by volume.
- 2.3** All bricks shall be laid strecher wise, breaking joints with those in the upper and lower courses. The wall shall be taken truly plumb. All courses shall be laid truly horizontal and all vertical joints shall be truly vertical. The bricks shall be laid with frogs upwards. A set of masons tools shall be maintained on work as required for frequent checking.
- 3.0 Mode of measurement and payment:**
- 3.1** The half brick masonry work in foundation and plinth shall be measured under this item, the limiting dimensions shall not exceed those shown in the plan or as directed. Any work done extra over the specified dimensions shall be ignored.
- 3.2** The relevant specifications of item No. 6.12 shall be followed. The length shall be measured nearest to one Cm.
- 3.3** The rate shall be for a unit of Sq. Mt.
- 6.30.I. (B) Half brick masonry in common burnt clay building bricks having crushing strength not less than 35 Kg/Sq. Cm. in cement mortar 1:4 (1 cement : 4 coarse sand) or super structure above plinth level up to floor two level with conventional bricks.**
- 1.0 Materials & Workmanship:**
- 1.1** The relevant specifications of item No. 6.30(A) shall be followed for bricks, wetting of bricks, joints, curing , except that the bricks to be used shall be conventional bricks instead of modular bricks.
- 2.0 Mode of measurements and payment :**

- 2.1. The limiting dimensions shall not exceed those shown in the plan or as directed. Any work done extra over specified dimensions shall be ignored.
- 6.30.II *(A) Half brick masonry in common burnt clay building bricks having crushing strength not less than 35 Kg/Sq. Cm. in cement mortar 1:5 (1 cement : 5 coarse sand) in foundation and plinth modular bricks.*
- 1.0 **Materials & Workmanship:** The relevant specifications of item No 6.30. I (A) shall be followed except the half brick masonry work shall be carried out in cement mortar 1:5 (1 cement : 5 coarse sand) with modular bricks in foundation and plinth.
- 2.0 **Mode of measurement and payment:**
- 2.1 The relevant specifications of item No. 6.30(I) A shall be followed.
- 2.2 The rate shall be for a unit of one Sq. Mt.
- 6.30 *II (B) Half brick masonry in common clay building bricks having crushing strength not less than 35 Kg/Sq. Cm. in cement mortar 1:5(1 cement : 5 coarse sand) in foundation and plinth using conventional brick.*
- 1.0 **Materials & Workmanship:** The relevant specifications of item No. 6.30(I) A shall be followed except that the half bricks work shall be carried out in cement mortar 1:5 (1 cement : 5 coarse sand) in foundation and plinth using conventional bricks.
- 2.0 **Mode of measurements and payment:**
- 2.1 The relevant specifications of item No. 6.30(I) A shall be followed.
- 2.2 The rate shall be for a unit of one Sq. Mt.
- 6.30 *III (A) Half brick masonry in common burnt clay building bricks having crushing strength not less than 35 Kg/Sq. Cm. in lime mortar 1:1.5 (1 lime putty : 1.5 coarse sand) in foundation and plinth with modular bricks.*
- 1.0 **Materials:** Modular bricks shall conform to M-15. Water shall conform to M-1. Lime mortar of proportion L. M. 1:1.5 (1 cement : 1.5 coarse sand shall be conform to M-10.
- 2.0 **Workmanship:** The relevant specifications of item No. 6.30(I) A shall be followed except that half brick masonry work shall be carried out in lime mortar 1:1.5(1 lime putty : 1.5 coarse sand) in foundation and plinth using conventional bricks.
- 3.0 **Mode of measurements and payment:**
- 3.1 The relevant specifications of item No. 6.30(I) A shall be followed.
- 3.2 The rate shall be for a unit of one Sq. Mt.
- 6.30 *III (B) Half brick masonry in common burnt clay building bricks having crushing strength not less than 35 Kg/Sq. Cm. in lime mortar 1:1.5 (1 lime putty : 1.5 coarse sand) in foundation and plinth using conventional bricks.*
- 1.0 **Materials:** Conventional bricks shall conform to M-15. Water shall conform to M-1. Lime mortar of proportion L. M. 1:1.5(1 Lime Putty : 1.5 coarse sand) shall be conform to M-10.
- 2.0 **Workmanship:** The relevant specifications of item no. 6.30 (I) A shall be followed except that half brick masonry work shall be carried out in lime mortar 1:1.5 (1 Lime Putty : 1.5 coarse sand) in foundation and plinth using conventional bricks.
- 3.0 **Mode of measurements and payment:**
- 3.1 The relevant specifications of item No. 6.30(I) A shall be followed.
- 3.2 The rate shall be for a unit of one Sq. Mt.
- 6.30 *IV (A) Half brick masonry in common burnt clay building bricks having crushing strength not less than 35 Kg/Sq. Mt. cement mortar 1:5(1 cement : 5 coarse sand) with hoop iron 25 mm x 1.6 mm. or equivalent reinforcement*

*at every third coarse embedded in cement mortar in foundation and plinth with modular bricks.*

**1.0 Materials:** Bricks shall conform to M-15. Water shall conform to M-1. Cement shall conform to M-3. Sand shall conform to M-6. Cement mortar shall conform to M-11. M.S. reinforcement shall conform to M-18.

**2.0 Workmanship:**

**2.1** Relevant specification of bricks; wetting and laying of bricks, joints, curing, scaffolding etc. shall conform to item no. 6.30(I) A except the following

**2.2** Cement mortar used in masonry work shall be proportion to 1 part of cement and 5 parts of sand by volume and shall conform to M-11 and this work is for half brick thickness for partitions walls.

**2.3** The hoop iron 25 mm x 1.6 mm or equivalent reinforcement shall be provided at every third course. The ends of reinforcement shall be fully embedded in main walls on both sides as directed. Reinforcement shall be placed on the top of the bottom-most course. Laps shall be of 15 cms of mild steel bars of hoop iron.

**2.4** The joints in the course where inforcement is placed shall admit of mortar cover to the reinforcement.

**3.0 Mode of measurements and payment:**

**3.1** The rate shall be for half brick masonry work including providing specified reinforcement, the limiting dimensions not exceeding those in the plan or as directed. The length shall be measured nearest to one Cm.

**3.2** Any work done extra over specified dimensions shall be ignored.

**3.3** The rate shall be for a unit of one Sq. mt.

**6.30. IV (B) Half brick masonry in common burnt clay building bricks having crushing strength not less than 35 Kg/Sq. cm. in cement mortar 1:5 (1 cement : 5 coarse sand ) with hoop iron 25 mm X 16 mm or equivalent reinforcement at every third course embedded in cement mortar in foundation and plinth with conventional bricks.**

**1.0 Material & workmanship:**

**1.1** The relevant specification of item No 6.31(A) shall be followed except that the work is to be carried out with conventional brick instead of modular bricks.

**2.0 Mode of measurements and payment:**

**2.1** The rate shall be for brick work including providing specified reinforcement the limiting dimensions not exceeding those shown in the plan or as directed the length shall be measured nearest to one Cm.

**2.2** The work done extra over specified dimensions shall be ignored.

**2.3** The rate shall be for a unit of one Sq. meter.

**6.33. (A) Extra for half brick masonry in superstructure above floor two level in Modular bricks**

**1.0 Materials & Workmanship:**

**1.1** The relevant specifications of item No. 6.30 (A) & 6.30 (B) shall be followed except that this work is for additional lift of each floor above floor two level using Modular bricks.

**2.0 Mode of measurement and payment:**

**2.1** The payment shall be made for the half brick masonry work carried out above floor two level for each additional lift over and above the payment of work up to floor two level.

**2.2** The rate shall be for a unit of one Sq. Mt. per floor.

**6.33 (B) Extra for half brick masonry work in super structure above floor two level. Conventional bricks.**

- 1.0 Materials & Workmanship:** The relevant specifications of item No. 6.30 (A) & 6.30 (B) shall be followed except that this work is for additional lift of each floor above floor two level using conventional bricks.
- 2.0 Mode of measurement & payment:**
- 2.1** The relevant specification of item No. 6.33 (A) shall be followed.
- 2.2** The rate shall be for a unit of one Sq. Mt. per floor.
- 6.55 (I) Half bricks thick honey comb brick work with burnt clay building bricks having crushing strength not less than 35 Kg/Sq. Cm. in C. M. 1:4 (1 cement : 4 coarse sand)**
- 1.0 Material:** Bricks shall conform to M-15 cement of proportion shall conform to M-11.
- 2.0 Workmanship:** The relevant specifications of item No. 6.32 (A) shall be followed except that the masonry work shall be carried out honey comb in thickness of half bricks in cement mortar 1:4 (1 cement : 4 coarse sand) and where directed with all lifts
- 3.0 Mode of measurements and payment:**
- 3.1** The honey comb work shall be measured in Sq. Mt. The full area of honey comb work shall be measured without deduction for openings.
- 3.2** The rate shall be for a unit of one square meter of wall surface.

## SECTION – 7

### DETAILED SPECIFICATIONS – RUBBLE MASONRY WORKS

- 7.6 (I) Un-coursed rubble masonry with hard stone approved quality in foundations and plinth in cement mortar 1:6 (1 cement : 6 coarse sand including leveling etc complete.**
- 1.0 Materials:** The cement mortar shall conform to M-11. Stones shall conform to M-16.
- 2.0 Workmanship:**
- 2.1 Dressing of stones:** Stone used for un coursed rubble masonry work shall be hammer dressed on the sides, and beds in such a way as to close up to close up with the adjacent stone in the masonry work as strongly as possible. The face stones shall be dressed in such a manner as to give a specified pattern such as Diagonal facing etc. The face of the stones shall be so dress that bushing on the exposed face shall not project by more than 40 mm from the general wall surface and on the face to be plastered. it shall not project by more than 19 mm nor shall have depressions more than 10 mm from the average wall surface.
- 2.2 Laying:** All the stone shall be sufficiently wetted before laying to prevent absorption of water from mortar. The wall shall be built true to plumb (or true to required batter when so specified) All connected walls in a structures shall normally be raised up uniformly and regularly. However if for any specific reason, on part of masonry is required to be left behind, the wall shall be racked back at arranged not steeper than 45<sup>0</sup>, vertical Toothed joints in masonry shall not be allowed. The work shall be carried out regularly and masonry of any day will not be raised by more than 1 meter in height.
- 2.3** The stone shall be laid in an un coursed fashion or random facing etc. However the masonry is required to be brought to level at various stages viz, plinth level, window still level, roof level and any other level specifically shown in the drawings. This may be done by first by adjusting the laying or stones to one level and then by providing leveling coarse of cement concrete

1:6:12 (1 cement : 6 sand : 12 graded stone aggregate 20 mm nominal size) or as other wise specified.

- 2.4** Proper bonding shall be achieved by closely filling in adjacent stones as well as by using bond stones or through stones as described here in below. Face stones shall extend back sufficiently and bond well with the masonry. The stone shall be carefully set so as to break joints and avoid formation of vertical joints. The depth of stone from the face of wall inwards shall not be less than weight or breadth at the face. The hearing or interior filling of the wall shall consist of rubble stone which may be of any shape. Neither the face stone nor the hearing stone shall be so small to pass through circular ring of 15 mm internal diameter in any direction nor shall any of them shall have minimum thickness 100 mm.
- 2.5** All stone shall be carefully laid, hammered down by a wooden mallet into position and solidly embedded in mortar, chips and spawls of stones may be used wherever necessary to avoid thick mortar beds or joints at the same time ensuring that No. hollow space is left anywhere in the masonry. The chips used shall not be more than 20% by volume of masonry. The hearing shall be laid nearly level with face stones except that at about one meter intervals vertical bond stone or plums projecting about 150 to 200 mm shall be firmly embedded to form vertical bonding in masonry.
- 2.6** **Bond stones:** Bond stones or through stones running right across the thickness of the wall shall be provided in walls up to 600 mm thick. In thicker walls two stones overlapping each other by at least 150 mm shall be provided across the thickness of the wall to form bond stones. There shall be at least one bond stone for every 0.5 Sq. M. of wall surface. The bond stone shall be marked by a distinguishing letter during construction for subsequent verification and shall be laid staggered in subsequent layers.
- 2.7** **Quoins:** The quoins or corners stone shall be selected stone nearly dressed with hammer and/or chisel to form the required corner angle and laid header and stretcher alternatively. The be d and top of surface of quoins shall be chiselled dressed to give horizontal joints. The quoins shall have a uniform chisel draft of at least 25 mm width at four edges of each exposed face, all the edges of the same face being in one plane. No. quoins stone shall be smaller than 0.025 mm Cum. in volume.
- 2.8** **Jamb Stones:** The jamb stone shall be made with stone specified for quoins except that the stone provided on the jambs shall have their length equal to thickness of wall up to 600 mm and line of headers shall be provided for walls thicker than 600 mm as specified for bond.
- 2.9** **Joints:** All the joints shall be completely filled with mortar and their width shall not exceed 25 mm. When plastering or pointing is not required to be done the joints shall be struck flush and finished simultaneously while laying the stone. Otherwise the joints shall be raked to a minimum depth of 20 mm by a tracking tool, during progress of laying while the mortar is still green.
- 2.10** **Scaffolding:** Single or double scaffolding shall be used. The scaffolding shall be strong and sound. The holes left in masonry for supporting scaffolding shall be filled and made good before plastering.
- 2.11** **Curing:** Green work shall be projected from rains by suitably converting the same. Masonry shall be kept constantly moist on all the faces for a period of at least 7 days. The top of masonry shall be flooded at the close of the day.
- 3.0** **Mode of measurements & payment:**
- 3.1** All work shall be measured on the basis of finished dimensions and measured net except where otherwise specified. Only specified dimensions shall be

allowed. Anything extra shall be ignored. The masonry work in foundation and plinth shall be measured under this item. No. deduction shall be made nor extra payment made for the following.

- (a) ends of joints, beams, posts, girders, rafter, purlins, trusses, corbels etc. each up to 500 Sq. Cm. in section.
- (b) Opening each up to 0.1 Sq. M.
- (c) Wall plates and bed plates bearings of chhajjas and like up to 10 cm depth (bearing of floor and roof slabs shall be deducted from masonry)
- (d) Drain holes and recesses for cement concrete blocks to embed hole fasts for door windows.
- (e) Building in the masonry iron fixtures pipes up to 300 mm dia hold fasts of doors and windows.
- (f) Forming cheeses in masonry up to section of 350 Sq. Cm.

**3.2** The rate shall be for a unit of one cubic meter.

**7.6** *(II) Uncoarsed rubble masonry with hard stone of approved quality in foundations and plinth in cement mortar 1:5 ( 1 cement : 5 coarse sand) including leveling up etc. complete.*

**1.0** **Materials & Workmanship:** The relevant specifications of item No. 7.6 (I) shall be followed except that the proportion of cement mortar shall be in C. M. 1 : 5(1 cement : 5 coarse sand)

**2.0** **Mode of measurements and payment:**

**2.1** The relevant specifications of item No. 7.6(I) shall be followed.

**2.2** The rate shall be for a unit of one cubic meter.

**7.6** *(III) Uncoarsed rubble masonry with hard stone of approved quality in foundation and plinth in lime mortar 1:1.5 (1 lime putty : 1.5 coarse sand) including leveling etc complete.*

**1.0** **Materials:** Lime mortar shall conform to M-10. The rubble shall conform to M-16

**2.0** **Workmanship:** The relevant specifications of item No. 7.6(I) shall be followed.

**3.0** **Mode of measurements and payment:**

**3.1** The relevant specifications of item No. 7.6(I) shall be followed.

**3.2** The rate shall be for a unit of one cubic meter

**7.17** *(A) Coarsed rubble masonry with hard stone of approved quality in foundation and plinth in cement mortar 1:6(1 cement ; 6 coarse sand) etc complete.*

**1.0** **Materials:** 1 Cement mortar shall conform to M-11. The stone shall conform to M-16.

**2.0** **Workmanship:**

**2.1** **Dressing Stone:** The face stone shall be hammer dressed so as to give approximately rectangular blocks. They shall be squared on bed and side joints. The bed joints shall be rough chisel dressed for a depth of atleast 50 mm back from the faces and the side joints shall be so dressed to a depth of at least 40 mm back from the face, such that No. portion of the dressed surface is more than 10 mm from a straight edge held against the surface. The bushing on the face shall not project by more than 40 mm on an exposed face and 10 mm on a face to be plastered. The hammer dressed stone shall also have a rough tooling for a minimum width of 25 mm along the four edges of the face of the stone.

**2.2** **Laying:**

**2.2.1** All stones shall be wetted before laying. The wall shall be built up truly plump (or to required batter where so specified)



All connected masonry in a structure shall normally be raised up uniformly and regularly. However if for any specific reasons one part of wall is required to be left behind, such wall shall be raked back at an angle not steeper than 45<sup>0</sup>. Vertical toothed joints in masonry shall not be allowed. The work shall be carried up regularly and masonry on any day shall not be raised by more than 1 meter in height.

**2.2.2** All the courses shall be laid truly horizontal. The height of course shall not be less than 150 mm nor more than 300 mm. Face stone shall be laid in alternate header and strecher fashion.

They shall be so arranged as to break joints by at least 75 mm. Stones shall be laid with grains horizontal so that the load is transmitted along the direction of their maximum crushing strength. The depth of stone shall not be less than the height or breadth. The breadth of a face stone shall also be not less than 150 mm. Each face stone shall be of the same height in any given course. The course shall be built in perpendicular to the pressure which the masonry will bear. In case of battered walls (such as retaining walls) the beds of the stone and the plane of courses shall be laid with their bed perpendicular to the battered face.

**2.2.3** The hearting or the interior filling of the wall shall consist of flat bedded stone carefully laid on their proper beds in mortar, chips and spews of stone being used where necessary to avoid excessive use of mortar, care being taken to see that No. hollow space is left any where in the masonry. Chips shall not be used below the hearting stone to bring these up to the chips shall be limited to 15% of the total volume of the masonry for masonry.

**2.3 Bond Stones:** The relevant specifications of item No. 7.6(I) para 2.6 shall be followed except that the hard stone shall be provided for at least 1.8 m length of every course.

**2.4 Quoins:** The quoins, which shall be of the same height as the course to which it belongs shall be formed from elected rough, chisel dressed to a depth of at least 100 mm. These stones shall have a minimum uniform chisel drafts of 25 mm width also be not less than 300 mm in length 25% of them being not less 500 mm in length.

**2.5 Joints:** All the bed joints shall be horizontal and all sides joints shall be vertical. Face joints shall not be more than 10 mm thick. All joints shall be properly and completely filled with mortar. On cases where No. plastering or pointing is required to be done he joint shall be struck flush and finished simultaneously while laying stones. In other cases the joint shall be raked to a minimum depth of 20 mm by raking tools during the progress of work while the mortar is still green.

**2.6 Curing:** The relevant specifications of item No. 7.6(I) para 2.9 shall be followed.

**3.0 Mode of measurements and payment:**

**3.1** The relevant specifications of item No. 7.6(I) shall be followed.

**3.2** The rate shall be for a unit of one cubic meter.

**7.17 (B) Coarsed rubble masonry with stone of approved quality in foundation s and plinth in cement mortar 1:5(1 cement : 5 coarse sand) etc complete.**

**1.0 Materials & Workmanship:** The relevant specifications of item No. 7.17(A) shall be followed except that the proportion of cement mortar shall be C. M. 1 : 5(1 cement : 5 coarse sand)

**2.0 Mode of measurements & payments:**

**2.1** The relevant specifications of item No. 7.17(A) shall be followed.

**2.2** The rate shall be for a unit of one cubic meter.

**7.17** *(C) Coarsed rubble masonry with stone of approved quality in foundation and plinth in C. M. 1:4(1 cement : 4 coarse sand) etc complete.*

**1.0** **Materials & Workmanship:** The relevant specifications of item No. 7.17(A) shall be followed except that proportion of mortar shall be C. M. 1:4 (1 cement : 4 coarse sand)

**2.0** **Mode of measurement and payment:**

**2.1** The relevant specifications of item No. 7.17(A) shall be followed.

**2.2** The rate shall be for a unit of one cubic meter.

**7.17** *(D) Coarse rubble masonry with stone of approved quality in foundations and plinth in C.M. 1:3(1 cement : 3 coarse sand) etc complete.*

**1.0** **Materials & Workmanship:** The relevant specifications of item No. 7.17(A) shall be followed except that the proportion of mortar shall be C. M. 1:3 (1 cement : 3 coarse sand)

**2.0** **Mode of measurements & payment:**

**2.1** The relevant specifications of item No. 7.17 (A) shall be followed.

**2.2** The rate shall be for a unit of one cubic meter

**7.19** *(A) Coarsed rubble masonry with stone of approved quality for super structure above plinth level up to floor two level in C. M. 1 : 6(1 cement : 6 coarse sand) etc complete*

**1.0** **Materials & Workmanship:**

**1.1** The relevant specification of item No. 7.17(A) shall be followed except that the coarsed rubble masonry work shall be carried out for super structure above plinth level up to floor two level.

**1.2** Single or double scaffolding may be used. The scaffolding shall be strong and sound. In case single scaffolding is used the holes shall be carefully made good as directed.

**2.0** **Mode of measurements and payments:**

**2.1** The relevant specifications of item No. 7.17(A) shall be followed.

**2.2** The rate shall be for a unit of one cubic meter.

**7.75** *Precast concrete block masonry (including quoin block, jamb block, closer etc with solid concrete blocks of approved size made of cement concrete 1:3:6 mix ( 1 cement : 3 coarse sand : 6 graded stone aggregate of 20 mm and down gauge ) in foundation and plinth in cement mortar 1:6.*

**1.0** **Materials:** (a) Aggregate shall conform to M-12 (b) Sand shall conform to M-6. Cement shall conform to M-3.

**1.1** The solid cement concrete block shall be pre case with concrete of 1:3:6 mix(1 cement : 3 coarse sand : 6 graded stone aggregate)

**1.2** A block shall be deemed to be solid if the solid material is not less than 75% of the total volume of the block calculated from over all dimensions.

**1.3** The concrete mix used for blocks shall not be richer than 1 part by volume of cement to 6 parts by volume of combined from over all dimensions.

**1.4** The actual size of the blocks shall be one of the following.

Size A 39 x 30 x 10 cms. Size B 39 x 20 x 19 cms. Size C 39 x 10 x 19 cms.

The size other than those specified above may be used with the approval of engineer in charge.

**1.5** The blocks may be either machine made or hand made. The concrete mix the mixing of concrete the manufacture of blocks curing and drying shall be in accordance with para 6 to 10 under I. S. 2185-1967.

**1.6** Faces of blocks shall be flat and rectangular. Surface finish shall be rendered smooth or plastered with cement mortar 1:3 (1 cement : 3 coarse sand)

**1.7** The average compressive strength of eight blocks when determined in the manner described in I.S. 2185-1967 shall not be less than 50 kg/sq cm of gross



area. The strength of lowest individual block shall not be less than 75 percent of average compressive strength of eight blocks.

**1.8** Concrete blocks shall be stored and stacked properly in such a way as to avoid any contact with moisture at site. They shall be stock plied on planks or other supports free from contact with ground and covered to protect against wetting. Cement under mortar of proportion 1:6 shall conform to M-11

**2.0 Workmanship:**

**2.1** The blocks need not be wetted before or during laying in the walls. In case climatic conditions so required the top and the sides of block may only be slightly moistured so as to prevent absorption of water from the mortar and ensure the development of required bond with mortar.

**2.2** Operations of laying precast cement concrete block masonry shall be carried out in accordance with instruction detailed in I.S. 6042-1962. The mortar shall not be spread so much ahead of the actual laying of the units that it tends to stiffen and loose its plasticity thereby resulting in poor bond. For most of the work the joints, both horizontal and vertical shall be 10 mm. thick except in the case of extended joint construction. The mortar joints shall be struck off flush with wall surface and when the mortar has started stiffening it shall be compressed with rounded or u shaped. The mortar shall be pressed against the units with a jointing tool after the mortar has stiffened in effect intimate contact between the mortar and the masonry unit and obtained a weather tight joint.

**2.3 Quoins & Closers:** Special quoins blocks (with a return face equal to half the length of normal face) shall be cast for all building blocks and slabs for external work. Proper half length closer shall be cast and not cut from full size blocks. The returned ends of blocks for door and windows reveals and quoins shall be finished with a fair face in the mould.

**2.4** Only double scaffolding shall be used. The scaffolding shall be strong and sound. No holes in the masonry for supporting shall be allowed.

**2.5 Curing:** The curing of concrete block masonry shall be carried out for 7 days.

**3.0 Mode of measurements and payment:**

**3.1** The relevant specifications of item No. 7.6(I) shall be followed.

**3.2** The work of concrete block masonry in foundation and plinth shall be measured under this item.

**3.3** The rate shall be for a unit o for cubic meter.

**7.82** *(A) Precast concrete block masonry in partition walls 10 cms thick with solid block of approved size (including quoins, blocks, jamb blocks, closures etc) made of C.C. 1:3:6 ( 1 cement 3 coarse sand : 6 graded stone aggregates 20 mm and down gauge) in C. M. 1:4*

**1.0 Materials:** The relevant specifications of item No. 7.75 shall be followed except that the precast concrete blocks shall be size suitable for 10 cms size partition wall i.e. size 'C' and the proportions of cement mortar shall be in cement mortar 1 : 4 (1 cement : 4 coarse sand)

**2.0 Workmanship:** The relevant specification of item No. 7.75 shall be followed except that the work shall be for precast concrete block partition walls of 10 cms thickness.

**3.0 Mode of measurements and payment:**

**3.1** The relevant specifications of item No. 7.75 shall be followed.

**3.2** the rate shall be for a unit of one sq meter.

**7.0.0** *White stone bela masonry block in coarse in super structure with stone of approved quality in lime mortar 1:1.5 (1 lime putty : 1.5 fine sand including raking out joints etc complete*

- 1.0 Materials:** The stone or bela shall be white hard sand stone bela or block. The stone shall be sound hard rough and durable. it shall be free from skin. Thickness of bela or block shall not be less than 15 cms or as directed. The mortar used shall consist one part of lime putty and 1.5 parts of fine sand lime mortar shall conform to M-10.
- 2.0 Workmanship:**
- 2.1 Dressing of stone:** Stone shall be chiselled dressed on all the sides so that all six sides shall be in a rectangular shape and all the stones shall be so dressed that the busing of the exposed face shall not project nor be depressed from the general wall surfaces. The size of bela or block shall be as per thickness of the wall to be constructed or as directed.
- 2.2 Laying:** All the stone shall be sufficiently wetted before laying to prevent absorption of water from mortar. All connected walls in a structure shall normally be raised up uniformly and regularly. The vertical joint shall not be allowed and also it shall not be more than 12 mm in thickness.
- 2.3** Proper bonding shall be made by laying bela or block side by side each other with lime mortar on bed as well as in between two bela or block vertically.
- 2.4 Bond stones:** Bond stones or through stones running right across the thickness of the wall shall be provided in walls up to 450 mm thick. In thicker walls two bellas or blocks over laying each other by at least 150 mm each other shall be provided across the thickness of the wall to form bond stone, such bond stone shall be at least one for every 10 sq mt area of the wall surface.
- 2.5 Joints:** All the joints shall be completely filled up with mortar and their thickness shall not exceed by 12 mm. When plastering or pointing is not required to be done, the joints shall be struck flush and finished, simultaneously while laying the stone. Otherwise the joints shall be raked to a minimum depth of 20 mm during process of laying while mortar is still green.
- 2.6 Scaffolding:** Single or double scaffolding shall be used. It shall be strong and sound. The holes left in masonry for supporting shall be made good before plastering.
- 2.7 Curing:** Green work shall be cured for a period of 7 days continuously.
- 3.0 Mode of measurements and payment:**
- 3.1** The work shall be measured on the basis of finish dimensions. No. deduction shall be made nor extra payment shall be made for the following:  
(a) Ends of joints, beams, posts, girders, rafters, purlins, trusses, corbels etc. each up to 500 sq. cms. in section (b) Opening each up to 0.10 sq. m.(c) Small plates and bed plates, bearing of chhajjas and like up to 10 cms depth (bearing or floor and roof slabs shall be deducted from masonry) (d) Drain holes and recesses for cement block to embedded hold fasts for doors and windows etc.
- 3.2** The rate shall be for a unit of one cubic meter
- 7.0.0.2 White stone bela masonry work in partition wall up to 15 cms thickness in C. M. 1 : 4 (1 cement : 4 coarse sand)**
- 1.0 Materials and Workmanship:** The relevant specifications of item No. 7.0.01 as above shall be followed except that the proportion of mortar shall be C. M. 1:4(1 cement : 4 coarse sand)
- 2.0 Mode of measurements & payment:**
- 2.1** The relevant specifications of item No. 7.6(I) shall be followed.
- 2.2** The rate shall be for a unit of one Sq. Mt.
- 7.0.0.3 White stone bela masonry block in course in super structure with stone of approved quality in C.M. 1 : 5 (1 cement : 5 coarse sand)including raking to joints etc. complete.**

- 1.0 **Materials & Workmanship:** The relevant specifications of item No. 7.0.01 as above shall be followed except that the proportion of cement mortar shall be in C.M. 1 : 5 (1 cement : 5 coarse sand)
- 2.0 **Mode of measurements & payment:**
  - 2.1 The relevant specifications of item No. 7.6(I) shall be followed
  - 2.2 The rate shall be for a unit of one cubic meter
- 7.0.0.4 ***White stone bela masonry block in coarse in super structure with stone of approved quality in C.M. 1:6 ( 1 cement : 6 coarse sand) including raking the joints etc complete***
  - 1.0 **Materials & Workmanship:** The relevant specifications of item No. 7.0.0.1 shall be followed except that the proportion of cement mortar shall be 1:6( 1 cement : 6 coarse sand)
  - 2.0 **Mode of measurements & payment:**
    - 2.1 The relevant specifications of item No. 7.6 (I) shall be followed
    - 2.2 The rate shall be for a unit of one cubic meter.

## SECTION – 9

### DETAILED SPECIFICATIONS – CENTERING & FORM WORK

- 9.1 ***(A) Providing form work of ordinary timber planking so as to give a rough finish including centering shuttering, strutting and propping etc. height of propping and centering below supporting floor to ceiling not exceeding 4 m. and removal of the same for in site reinforced concrete and plain concrete work in foundations, footing, bases of columns, and mass concrete.***
  - 1.0 **Materials:**
    - 1.1 The shuttering to be provided shall be of ordinary timber planks and shall conform to M-26.
    - 1.2 The dimensions of scantlings and battens shall conform to the design. The strength of the wood shall not be less than that assumed in the design.
  - 2.0 **Workmanship:**
    - 2.1 The form work shall conform to the shape lines and dimension as shown on the plans and be so constructed as to remain sufficiently rigid during the placing and compacting of the concrete. Adequate arrangements shall be made by the contractor to safe guard against any settlement of the form work during the course of concreting and after concreting. The form work of shuttering, centering, scaffolding bracing etc shall be as per design.
    - 2.2 **Cleaning & Treatment of forms:**
      - 2.2.1 All rubbish, particularly chippings shaving and saw dust shall be removed from the interior of the form before the concrete is placed and the form work in contact with concrete shall be cleaned and thoroughly wetted or treated. The surface shall be then coated with soap solution applied before concreting is done. Soap solution for the purpose shall be prepared by dissolving yellow soap in water to get consistency of paint. Alternatively a coat of raw linseed oil or form oil of approved manufacture may be applied in case steel shuttering is used. Soap solution or raw linseed oil shall be applied after thoroughly cleaning the surface. Care shall be taken that the coating does not get on construction joint surface and reinforcement bars.
    - 2.3 **Stripping time:**
      - 2.3.1 In normal circumstances and where ordinary cement is used forms may be struck after expiry of following periods:
        - (a) Sides of walls columns and vertical faces of beam .....24 to 48 hours.
        - (b) Beams soffits (Props left under) .....7 days.

- (c) Removal of props slabs
  - (i) Slabs spanning up to 4.5 m..... 7 days
  - (ii) Spanning over 4.5 mm..... 14 days
- (d) Removal of props to beams and arches
  - (i) Spanning up to 6 m..... 14 days
  - (ii) Spanning over 6 m..... 21 days

**2.4 Procedure when removing the form work:**

**2.4.1** All form work shall be removed without such shock or vibration as would damage the reinforced concrete surface. Before the soffits form work and struts are removed, the soffits and the concrete surface shall be exposed where necessary in order to ascertain that the concrete has sufficiently hardened.

**2.5 Centering:**

**2.5.1** The centering to be provided shall be got approved. It shall be sufficiently strong to ensure absolute safety of the form work and concrete work before, during and after pouring concrete. Watch should be kept to see that behavior of centering and form work is satisfactory during concreting. Erection should also be such that it would allow removal of forms in proper sequence without damaging either the concrete or the forms to be removed.

**2.5.2** The props of centering shall be provided on firm foundation or base of sufficient strength to carry the loads without any settlement.

**2.5.3** The centering and form work shall be inspected and approved by the Engineer-in-charge before concreting. But this will not relieve the contractor of his responsibility for strength, adequacy and safety of form work and centering. If there is a failure of form work or centering, contractor shall be responsible for the damages to the work, injury to life and damage to property.

**2.6 Scaffolding:**

**2.6.1** All scaffolding, hoisting arrangements and ladders etc required for the facilitating of concreting shall be provided and removed on completion work by contractor at his own expense. The scaffolding, hoisting arrangements and ladders etc. shall be strong enough to with stand all live, dead and impact loads expected to act and shall be subject to the approval of the Engineer-in-charge. However, contractor shall be solely responsible for the safety of the scaffolding, hoisting arrangement, ladders, work and workman etc.

**2.6.2** The scaffolding hoisting arrangements and ladders shall allow easy approach to the work spot and afford easy inspection.

**2.6.3** The rate is applicable to all conditions of working and height up to 4 mts. The rate shall include the cost of materials and labour for various operations involved such as:

- (a) Splayed edges, notching, allowance for overlaps and passing at angles, battens centering, shuttering propping, bolting, nailing, wedging, easing, striking and removal.
- (b) Filleting to form stop chamfered edges or splayed external angles not exceeding 20 mm width to beams, columns and the like.
- (c) Temporary openings in the forms for pouring concrete, if required, removing rubbish etc.
- (d) Dressing with oil to prevent adhesion of concrete with shuttering, and
- (e) Raking or circular cutting.

**2.7 Re-use:**

**2.7.1** Before re use all forms shall be inspected by Engineer-in-charge and their suitability ascertained. The forms shall be scarred, cleaned, and joints gone over, repaired where required. Inside surface shall be retreated to prevent adhesion of concrete.

**3.0 Mode of measurements & payment:**

**3.1** Form work shall be measured as the area in square meters of shuttering in contract with concrete except in the case of inclined member and portion of curved profile and upper side in which case only area of underside shall be measured for payment.

**3.2** Form work to secondary beams shall be measured up to the sides of main beams but no deduction shall be made from the form work of the main beam at the inter section point. No. deduction shall be made from the form work of a column at inter section of beams.

**3.3** The rate is for the completed item.

**3.4** The rate shall be for a unit of one Sq. meter

**9.1** *(A) (I) Extra for providing form work of ordinary timber planking so as to give a rough finish including centering, shuttering, strutting and propping etc. height of propping and centering below supporting floor to ceiling in between 4 m to 5 m and removal of the same for in situ reinforced or plain concrete work in foundation, footings, bases of columns etc. and mass concrete.*

**1.0 Materials & Workmanship :**

**1.1** The relevant specifications of item No. 9.1 (A) shall be followed except that the height of propping and centering below supporting floor to ceiling exceeding 4 m but not exceeding 5 m.

**2.0 Mode of measurements & payment:**

**2.1** The payment shall be made extra over and above the payment made up to 4 mt. height. The relevant specifications of 9.1 (A) shall be followed. The rate shall be for a unit of one Sq. meter.

**9.1** *(B) (I) Providing form work of ordinary timber planking so as to give a rough finish including centering shuttering, strutting, and propping etc. height of propping and centering below supporting floor to ceiling not exceeding 4 m and removal of the same for in site reinforced and plain concrete work in flat surface such as soffits of slabs, landing and the like floors etc. up to 200 mm in thickness.*

**1.0 Materials and Workmanship:**

**1.1** The relevant specifications of item No. 9.1 (A) shall be followed except that the work is to be carried out for flat surface such as soffits of slabs, landings and the like for floors etc. up to 200 mm in thickness.

**2.0 Mode of measurements and payments:**

**2.1** The relevant specifications of item No. 9.1 (A) shall be followed.

**2.2** The rate shall be for a unit of one Sq. meter.

**9.1** *(B) (II) Providing form work of ordinary timber planking so as to give a rough finish including centering, shuttering, strutting and propping etc. height or propping and centering below supporting floor to ceiling No. exceeding 4 m and removal of the same for in situ reinforced and plain concrete work in flat surfaces such as soffits of slabs, landings and the like floors etc. above 200 mm in thickness.*

**1.0 Materials and Workmanship:**

**1.1** Relevant specifications of item No. 9.1(A) shall be followed except that the work is for floors etc. above 200 mm in thickness.

**2.0 Mode of measurements and payment:**

**2.1** The relevant specifications of item No. 9.1 (A) shall be followed.

**2.2** The rate shall be for a unit of one sq. meter

**9.1** *(C) Providing form work of ordinary timber planking so to give a rough finish including centering, shuttering, strutting and propping etc. height of*

*propping and centering below supporting floor to ceiling not exceeding 4 m and removal of the same for in situ reinforced concrete and plain concrete work in vertical surface such as wall (any thickness) partitions.*

**1.0 Materials & Workmanship:** The relevant specifications of item No. 9.1 (A) shall be followed except that the form work shall be carried out for vertical surface such as walls of any thickness, partitions etc.

**2.0 Mode of measurements and payment:**

**2.1** The relevant specifications of item No. 9.1 (A) shall be followed.

**2.2** The rate shall be for a unit of one Sq. meter.

**9.1 (G) (I) Providing form work of ordinary timber planking so as to give a rough finish including centering, shuttering, strutting and propping etc. height or propping and centering below supporting floor to ceiling not exceeding 4 m and removal of the same for in situ reinforced and plain concrete work in columns, pillars posts, and struts, square rectangular, polygonal in plan.**

**1.0 Materials and Workmanship:**

**1.1** The relevant specifications of item No. 9.1 (A) shall be followed except that the work is for columns, pillars, posts and struts square, rectangular, polygonal in plan.

**2.0 Mode of measurements and payment:**

**2.1** The relevant specification of item No. 9.1 (A) shall be followed.

**2.2** The rate shall be for a unit of one square meter.

**9.1 (H) (1) Providing form work of ordinary timber planking so as to give a rough finish including centering, shuttering, strutting and propping etc. height of propping and centering below supporting floor to ceiling not exceeding 4 m and removal of the same for in situ reinforced and plain concrete work in side and soffits of beams, beam haunchings, cantilevers, girders, bressumers and lintels not exceeding 1 m in depth.**

**1.0 Mode of measurements and payment:**

**2.1** The relevant specifications of item No. 9.1 (A) shall be followed.

**2.2** The rate shall be for a unit of one Sq. meter.

**9.1 (H) (2) Providing form work of ordinary timber planking so as to give a rough finish including centering, shuttering, strutting and propping etc. Height of propping and centering below supporting floor to ceiling not exceeding 4 m and removal of the same for in situ reinforced and plain concrete work insides and soffits of beam, haunchings cantilevers, girders, bressumers and lintels exceeding 1 M in depth.**

**1.0 Materials & Workmanship:**

**1.1** The relevant specifications of item No. 9.1 (A) shall be followed except that the work is for side and soffits of beams, beams haunchings, cantilevers, girders, bressumers, and lintels exceeding 1 M. in depth.

**2.0 Mode of measurements and payment:**

**2.1** The relevant specification of item No. 9.1 (A) shall be followed, except that the work is for side and soffits of beam, beam hauchings, cantilevers, girders, bressumers, and lintels, exceeding 1 m in depth.

**2.2** The rate shall be for a unit of one Sq. meter.

**9.1 (I) (i) Providing form work of ordinary timber planking so as to give a rough finish including centering, shuttering, strutting and propping etc., height of propping and centering below supporting floor to ceiling not exceeding 4 m and removal of the same for in situ reinforced and plain concrete work in edges of slabs and breaks in floor and walls:**

**1.0 Materials & Workmanship;**



1.1 The relevant specifications of item No. 9.1 (A) shall be followed except that the work is for edges of slabs and breaks in floors and walls.

**2.0 Mode of measurements and payment:**

2.1 The length and breadth shall be measured nearest to one Cm.

2.2 The rate shall be for a unit of one Sq. meter.

9.1 *(J) Providing form work of ordinary timber planking so as to give a rough finish including centering, shuttering, strutting, and propping etc., height of propping and centering below supporting floor to ceiling not exceeding 4 m and removal of the same for in situ reinforced and plain concrete work in edges of slabs and breaks in floor and walls:*

**1.0 Materials & Workmanship:**

1.1 The relevant specification of item No. 9.1 (A) shall be followed except that the work is for edges of slabs and breaks in floors and walls.

**2.0 Mode of measurements & payments:**

2.1 The length and breadth shall be measured nearest to one Cm.

2.2 The rate shall be for a unit of one Sq. meter.

9.1 *(K) Providing form work of ordinary timber planking so as to give a rough finish including centering shuttering, strutting, and propping etc., height of propping and centering below supporting floor to ceiling not exceeding 4 m removal of the same for in situ reinforced and plain concrete in small surfaces such as cantilevers ends, brackets, and ends of the steps, caps and bases to pilasters and columns and the like.*

**1.0 Materials and Workmanship:**

1.1 The relevant specifications of item No. 9.1(A) shall be followed except that the work is for small surface such as cantilever ends, brackets and ends of steps, caps, and bases to pilasters and columns and the like.

**2.0 Mode of measurements & payment:**

2.1 The relevant specifications of item No. 9.1 (A) shall be followed

2.2 The rate shall be unit of one Sq. meter.

9.1 *(L) Providing form work of ordinary timber planking so as to give a rough finish including centering, shuttering, strutting, and propping etc., height of propping and centering below supporting floor to ceiling not exceeding 4 m and removal of the same for in situ reinforced and plain concrete in chulla hoods, weather sheds, chhajas carbels etc. including edges.*

**1.0 Materials & Workmanship:**

1.1 The relevant specifications of item No. 9.1(A) shall be followed except that the work is for chullah hoops, weather sheds, chhajas, carbels etc including edges of the same.

**2.0 Mode of measurements & payment:**

2.1 The relevant specifications of item No. 9.1 (A) shall be followed.

2.2 The rate shall be for a unit of one Sq. meter.

9.1 *(M) Providing form work of ordinary timber planking so as to give a rough finish including centering, shuttering, strutting, propping etc. height of propping and centering below supporting floor to ceiling not exceeding 4 m and removal of the same for in situ reinforced and plain concrete work in stair case with slopping or stepped soffits including risers and stringers excluding landing.*

**1.0 Materials & Workmanship:**

1.1 The relevant specification of item No. 9.1 (A) shall be followed except that the work is for stair cases, with slopping or stepped soffits including risers and stringers excluding landing.

**2.0 Mode of measurement & payments:**

- 2.1 The relevant specifications of item No. 9.1 (A) shall be followed.
- 2.2 The rate shall be for a unit of one Sq. meter.
- 9.1 *(Q) Providing form work of ordinary timber planking so as to give a rough finish including centering, shuttering, strutting, and propping etc. height of propping and centering below supporting floor to ceiling not exceeding 4 m and removal of the same for in situ reinforced and plain concrete work in vertical fins and vertical sun breakers.*
- 1.0 Materials & Workmanship:**
- 1.1 The relevant specifications of item No. 9.1 (A) shall be followed except the work is for vertical fins and vertical sun breakers.
- 2.0 Mode of measurements and payment:**
- 2.1 The relevant specifications of item No. 9.1 (A) shall be followed.
- 2.2 The rate shall be for a unit of one sq meter
- 9.2 *Extra for providing form of work with sheathing of steel sheets so as to give a fair finish in –*
- (A) Foundation, footings, base of columns etc. and the like.*
- (B) Flat surfaces such as soffits of slab, landing and the like*
- (i) Floor etc. up to 200 mm in thickness*
- (ii) Floor etc. above 200 mm in thickness*
- (C) Vertical surfaces such as walls (Any thickness), partitions.*
- (D) Columns, pillars, posts and struts.*
- (1) Square, rectangular, breassumers, and lintels not exceeding 1 mm depth.*
- (2) Sides and offits of beams, beam haunchings, cantilevers, girders, breassumers and lintels exceeding 1 mm in depth.*
- (E) Edges of slabs and breaks in floors and walls.*
- (F) Small surface such as cantilever ends, brackets, and ends of steps, caps and bases to pillars and columns including edges.*
- (G) Chollar woods whether sheds, chhajas, corrodes etc. and the like*
- (H) Stair cases with sloping or steeped soffits, including risers, skirting, excluding landing.*
- (I) Vertical fins and vertical sun breakers.*
- 1.0 Materials & Workmanship:**
- 1.1 The relevant specifications of item No. 9.1(A) to (Q) shall be followed except that the extra rate shall be paid for using sheathing of steel sheets, and plates of steel or plywood instead of ordinary timber plank, to obtain a desired smooth exposed finish of surface. The surface shall be presentable without further treatment.
- 2.0 Mode of measurements and payment:**
- 2.1 The measurement of form work shall be taken for the form work done with steel sheathing, extra over and above the rate of form work of the respective item of form work done. The relevant specification of respective item No. 1 A to Q shall be followed.
- 2.2 The rate shall be for a unit of one Sq. meter.

## SECTION – 10 DETAILED SPECIFICATION – WOOD WORK

- 10.1 *(A) Providing wood work in frames of doors, windows clear story windows and other similar work, wrought, framed and fixed in position, India Teak wood.*
- 1.0 Materials:** Wood in frames shall conform to M-29
- 2.0 Workmanship:**



- 2.1 The item covers the requirement of frames for doors, windows, clerestory windows their supply and fixing.
- 2.2 **Frames:**
- 2.2.1 All members of the frames shall be exactly at right angles. The right angle shall be checked from inside surface of the respective members.
- 2.2.2 All member of frames shall straight without any warp or bow and shall have smooth surface well planed on the three sides exposed at right angles to each other. The surface touching the wall may not be planed unless it is required in order to straighten up the member or to obtain the overall size within the tolerances specified.
- 2.2.3 Frame shall have dovetail joints. When clerestory windows are included, it shall be provided by having full length one piece post for door or windows and clerestory window extending the frame on top at the head to the required extent. Horns shall not be provided in the head of the frame. When No. still are provided the vertical posts of the frame in the ground floor shall be embedded in the sill masonry for 10 cm in upper floors, their vertical posts shall be fixed in the floor or masonry by forming notches 10 mm deep. Slight adjustment spacing as necessary shall be done to have the hold fasts in the joints of masonry course. The frame shall be created in position and held plumb with strong support from both sides and built in masonry as it is being built. The transom shall be through tenoned in to the mortices of the jamb post to the full width of the jamb post and the thickness of the tenon shall be not less than 15 mm.
- 2.3 **Tolerance:** Unless specially mentioned otherwise tolerance of  $\pm 1.5\text{mm}$  shall be allowed for each wrought face.
- 2.4 The tenons shall be closely fitting into the mortices and suitably pinned with wood dowels not less that 10mm. dia meter. The depth of rebates for housing the shutter shall be as shown in the detailed drawing or as directed.
- 2.5 The contact surface of tenon and mortice shall be treated before putting together with an adhesive of approved make.
- 2.6 Minimum number of three hold fasts shall be fixed on each side of door and windows frames, one at the center point and the other two at 30 cm from the top and the bottom of the frames. In case of windows and ventilators frames whose height is less 1 M two hold fasts on each side shall be fixed at quarter points of the frames. The size of each hold fast shall be 300 x 25 x 6 mm and of mild steel with split end. The hold fast shall be fixed with screws to frames.
- 2.7 Mild steel hold fasts shall be protected with a coating of coal asphalt tar. The surface of frame abutting the masnory or concrete faces shall be properly treated by applying a coat of approved coating.
- 3.0 **Mode of measurements & payments:**
- 3.1 The linear dimensions shall be measured correct up to 1 cm. The quantity shall be worked out correct to 2 places of decimals of a Cu. m.
- 3.2 The rate shall be for a unit of 10 cu dia.
- 10.4 ***(A) Providing wood work in trusses, purlins, rafters, posts, post plates, wall plates, and like wrought, framed, hoisted and fixed in position, Indian teak wood.***
- 1.0 **Materials:** The teak wood shall conform to M-29.
- 2.0 **Workmanship:**
- 2.1 The relevant specifications of item No. 10.1 (A) shall be followed except that the wood work shall be carried out in trusses, purlins, rafters, posts, post plastes, wall plastes and like wrought framed.

- 2.2 The work shall be carried out as per detailed drawings supplied by the Departmental and as directed.
- 2.3 the length of each members shall be in one piece or as directed.
- 3.0 **Mode of measurements and payments:** The length, breadth and depth shall be measured nearest to 1 cm of unfinished member.  
The rate shall be for a unit of 10 cubic decimeter.
- 10.5 *(A) Providing wood work in frames of false ceiling, partition etc. swan and put up in position Indian teak wood.*
- 1.0 **Materials:** The teak wood shall conform to M-29.
- 2.0 **Workmanship:** The relevant specifications of item No. 10.1(A) shall be followed except that the wood work shall be for false ceiling, partitions, etc. swan and put up in position.
- 3.0 **Mode of measurements and payment:**
- 3.1 The relevant specifications of item No. 10.1(A) shall be followed.
- 3.2 The rate shall be for a unit of ten cubic decimeter.
- 10.12 *(A) (I) Providing and fixing 35mm thick fully panelled shutters for doors, windows, and clerestory windows including anodised aluminium butt hinges with necessary screws, Indian teak wood.*
- 1.0 **Materials:**
- (1) Wood for shutter shall conform to M-29 (2) Anodised aluminium butt hinges shall conform to M-43.
- 2.0 **Workmanship:** The item covers the requirement of preparation of shutters for doors, windows, clerestory windows, their supply and fixing.
- 2.2 **Shutters:**
- 2.2.1 Panelled shutters shall be constructed in the form of timber frame work of styles and rails with panel, inserted of type as specified in the detailed drawings. Panel shall be fixed by providing grooves in the style and rails. The styles and rails shall be joined to each other by mortise and tenon joints at right angles.
- 2.2.2 All members of the shutters shall be straight without any warp or how and shall have smooth, well planed faces at right angles to angles to each other.
- 2.2.3 The size of styles and rails shall be as per drawing or as directed. Styles and rails of shutters shall be made of one piece only.
- 2.3.1 **Timber paneling:**
- 2.3.1 Thickness of the panel shall be as specified in the item as shown in the drawing or as directed. If the panel is made from more than one piece, the pieces shall be finished as shown in the detailed drawings and shall be joined with continuous groove with specified size. The end pieces of the panel and the top and bottom of the panel shall be provided with continuous tongue to frame into groove of the frame shutter. An air space of 1.5 mm shall be left in the groove of frame shutter while fixing the panels in it.
- 2.3.2 The faces of the panel as well as various pieces of the panel shall be closely fitted to the size of the grooves.
- 2.3.3 Finishing of the corners of raised panel edges shall be done as shown in drawings or as directed.
- 2.4 **Fixtures & Fastenings:**
- 2.4.1 The rate shall include anodised aluminium butt hinges including fixing with iron screws. The size and number of hinges shall b as per table given in annexure-1.
- 3.0 **Mode of measurements and payment:**
- 3.1 The rate for shutter includes cost of providing block and clear for keeping the shutter in open position as directed.

- 3.2 The dimension of the shutter shall be measured clear size of the shutter in close position between the grooves of the frame.
- 3.3 The rate shall be for a unit of one sq. meter.
- 10.12 (A) (II) Providing and fixing 35 mm thick fully glazed shutters for doors, windows and clerestory windows including anodised aluminium butt hinges with necessary streces, Indian Teak Wood.**
- 1.0 Materials:** Teak wood shall conform to M-29. Glass shall conform to M-38. Anodised aluminium butt hinges shall conform to M-43.
- 2.0 Workmanship:**
- 2.1 The relevant specifications of item No. 10.12(A) I shall be followed except that the 35 mm thick shutters fully glazed for doors, windows and clerelstory windows including aluminium butt hinges with necessary screws.
- 2.2 Glazing:**
- 2.2.1 The glass panels shall be embodied in putty and secured to the rebate by wooden beds or mouldings shape and size as approved with counter sunk screws of suitable size.
- 2.2.2 The glass panel shall be properly cut to fit the rebates of the frames and sashes fully with a light minus margin of about 1.5 mm on all sides. Before glazing the frame shall be primed and prepared for painting so that wood may not draw oil out of putty.  
The rebate shall be putted to an extent to provide bedding all round the glass.
- 2.2.3 The glass shall then be bedded in putty and fitted to frames with wooden beads or mouldings as directed and secured with counter sunk screw. The screw shall be spaced not more than 10 mm form each corner and not more than 200 mm apart.
- 2.2.4 The size of the rebate in the frame and size and shape of beads or moulding shall be as per detailed drawings or as directed. The beds or mouldings shall have mitered corners.
- 3.0 Mode of measurement and payment:**
- 3.1 The relevant specifications of item No. 10.12(A)(I) I shall be followed.
- 3.2 The rate shall be for a unit of one sq. meter.
- 10.12 (A) (III) Providing and fixing 35 mm thick partly panelled and partly glazed shutters, or doors, windows including anodized aluminium butt hinges with necessary screws, Indian teak wood.**
- 1.0 Materials:** Teak wood shall conform to M-29. Glass shall conform to M-38. Anodised aluminium butt hinges shall conform to M-43.
- 2.0 Workmanship:** The relevant specifications of item No. 10.12(A) (I) and 10.12(A)(II) shall be followed except that the 35 mm thick shutters shall be partly panelled and partly glazed for door windows, clerestory windows etc., as per drawings.
- 3.0 Mode of measurement and payment:**
- 3.1 The relevant specifications of item No. 10.12(A)(I) shall be followed.
- 3.2 The rate shall be for a unit one sq. meter.
- 10.13 (A)(I): Providing and fixing 35 mm thick fully panelled, shutters for doors, windows and clerestory windows including black enamelled M.S. butt hinges with necessary screws. Indian Teak Wood**
- 1.0 Materials & Workmanship:**
- 1.1 Relevant specifications of item No. 10.12(A) shall be followed except that the hinges shall be of black enamelled M.S. butt type hinges. The hinges, bolts, and other items of iron-mongery with moving parts shall be properly oiled by the contractor before handing over the building.
- 2.0 Mode of measurement & payment:**

- 2.1 The relevant specifications of item No. 10.12(A) I shall be followed.
- 2.2 The rate shall be for a unit of one sq. meter.
- 10.13 *(A)(II) Providing and fixing 35 mm thick fully glazed shutters for doors window and clerestory windows including black enamelled M.S. butt hinges, with necessary screws. Indian teak wood.*
- 1.0 **Materials & Workmanship:** The relevant specifications of item No. 10.12(A) I shall be followed except that the hinges shall be of black enamelled M.S. butt hinges, bolts and other items of iron mongery with moving parts shall be properly oiled by the contractor before handing over the building.
- 2.0 **Mode of measurements & payment:**
- 2.1 The relevant specifications of item No. 10.12(A)(I) shall be followed.
- 2.2 The rate shall be for a unit of one sq. meter.
- 10.13 *(A)(III) Providing and fixing 35 mm thick partly panelled and partly glazed shutters for doors windows and clerestory windows including black enamelled M.S. butt hinges with necessary screws, India teak wood.*
- 1.0 **Materials of Workmanship:** The relevant specifications of item No. 10.12(A) (II) shall be followed except that the hinges shall be black enamelled M.S. butt type hinges. The hinges, bolts and other items of iron mongery with moving parts shall be properly oiled by the contractor before handing over the building.
- 2.0 **Mode of measurements and payment:**
- 2.1 The relevant specifications of item No. 10.12(A)(I) shall be followed.
- 2.2 The rate shall be for a unit of one sq. meter.
- 10.15 *(A)(I) Providing and fixing 25 mm thick fully panelled, shutters for cup boards etc. including anodised aluminium butt hinges with necessary screws Indian teak wood.*
- 1.0 **Materials:** First class Indian teak wood for shutters shall conform to M-29. Glass shall conform to M-38. Anodised aluminium butt hinges shall conform to M-43.
- 2.0 **Workmanship:**
- 2.1 The relevant specifications of item No. 10.12(A)(I) shall apply except that the thickness of shutter shall be 25 mm for cup boards.
- 3.0 **Mode of measurements and payments:**
- 3.1 The relevant specifications of item No. 10.12(A)(I) shall be followed.
- 3.2 The rate shall be for a unit of one sq meter
- 10.15 *(A)(II) Providing and fixing 25 mm thick fully panelled shutters for cup boards etc. including anodised aluminium butt hinges with necessary screws Indian teak wood.*
- 1.0 **Materials & Workmanship:** The relevant specifications of item No. 10.12(A)(II) shall apply except that the thickness of shutters shall be 25 mm thick and fully glazed for cup boards.
- 2.0 **Mode of measurement & payments:**
- 2.1 The relevant specifications of item No. 10.12(A)(I) shall be followed.
- 2.2 The rate shall be for a unit of one sq. meter.
- 10.15 *(A) (III) Providing and fixing 25 mm thick party panelled and partly glazed shutters for cup boards etc. including anodised aluminum butt hinges with necessary screws, Indian teak wood.*
- 1.0 **Materials and Workmanship:** The relevant specifications of item No. 10.12(A)(I) and 10.12(A)(II) shall be followed except that the thickness of shutters shall be 25 mm thick and partly panelled and partly glazed shutters as per drawing for cup-boards
- 2.0 **Mode of measurements and payment:**

- 2.1 The relevant specifications of item No. 10.12(A)(I) shall be followed.
- 2.2 The rates shall be for a unit of one sq. meter.
- 10.16 (A) (I) *Providing and fixing 25 mm thick fully panelled shutters for cup boards etc. including black enamelled M.S. butt hinges with necessary screws. Indian Teak wood.*
- 1.0 **Materials & Workmanship:**
- 1.1 The relevant specifications of item No. 10.12 (A)(I) shall apply except that the wood for shutters shall be Indian teak wood and black enamelled M.S. butt hinges are to be used instead of anodised aluminium butt hinges and thickness of shutter shall be 25 mm.
- 2.0 **Mode of measurements & payment:**
- 2.1 The relevant specifications of item No. 10.12(A)(I) shall be followed.
- 2.2 The rate shall be for a unit of one sq. meter
- 10.16 (A) (II) *Providing and fixing 25 mm thick fully glazed shutters for a cup boards etc. including black enamelled M.S. butt hinges with necessary screws. Indian Teak wood.*
- 1.0 **Materials & Workmanship:** The relevant specifications of item No. 10.15 (A)(II) shall be followed except that the fully glazed shutters of 25 mm thickness shall be of Indian teak wood and fixed in position with black enamelled butt hinges for cup boards.
- 2.0 **Mode of measurements & payments:**
- 2.1 The relevant specifications of item No. 10.12 (A)(I) shall be followed.
- 2.2 The rate shall be for a unit of one sq. meter
- 10.16 (A) (III) *Providing and fixing 25 mm thick partly panelled and partly glazed shutters for cup boards including black enamelled M.S. butt hinges with necessary screws. Indian teak wood.*
- 1.0 **Materials & Workmanship:** The relevant specifications of item No. 10.15 (A)(I) and 10.15 (A)(II) shall be followed except that the shutters shall be partly panelled and partly glazed of 25 mm. thickness of Indian teak wood fixed with black enamelled butt hinges for cup boards.
- 2.0 **Mode of measurements & payment:**
- 2.1 The relevant specifications of item No. 10.12 (A)(I) shall be followed.
- 2.2 The rate shall be for a unit of one sq. meter.
- 10.23 *Providing and fixing 35 mm thick panelled glazed or panelled and glazed shutters for doors, windows and clerestory windows including anodised aluminium butt hinges with necessary screws. Indian teak wood shutters with (A) Plywood (B) Particle boards (C) Hard board (D) Asbestos sheet panels.*
- 1.0 **Materials:** Indian teak wood for shutters shall conform to M-29. Glass shall conform to M-38.
- (A) Plywood shall conform to M-37
- (B) Particle board shall conform to M-40. Anodised aluminium butt hinges shall conform to M-43.
- (C) Hard board shall of best quality and shall be as approved by Engineer-in-charge.
- (D) A. C. sheet shall conform to M-24.
- 2.0 **Workmanship:**
- 2.1 The relevant specifications of I tem No. 10.12(A)(I) shall apply to this item except that the work is shuttered with (A) plywood(B) particle board(C)hard board panels (D) A. C. sheets panels as specified in item.
- 2.2 The shutters shall be prepared by fitting styles and rails (top, bottom, lock and frieze) as for panelled leaves with simple chamfer on edges only. The styles

and rails shall be grooved with just sufficient width for received panels and plain panels of specified type panes shall be fitted into the grooves.

**3.0 Mode of measurement and payment:**

**3.1** The relevant specifications of item No. 10.12(A)(I) shall be followed.

**3.2** The rate shall be for a unit of one sq. meter.

**10.24** *Providing and fixing 35 mm thick panelled glazed or panelled and glazed shutters for doors, windows and clerestory windows including black enamelled M.T. butt hinges with necessary screws. Indian teak wood shutters with (A) plywood (B) Particle board (C) Hard board (D) Asbestos sheet panels.*

**1.0 Materials & Workmanship:**

**1.1** The relevant specifications of item No. 10.23 shall be followed except that the hinges shall be of black enamelled M. S. butt hinges instead of anodised aluminium butt hinges and shutter with (A) Plywood (B) Particle board (C) Hard board (D) Asbestos sheet panels as specified in item.

**2.0 Mode of measurement and payment:**

**2.1** The relevant specifications of item No. 10.12 (A) (I) shall be followed.

**2.2** The rate shall be for a unit of one sq. meter.

**10.30** *Providing and fixing flush door shutters, solid core construction with frame of 1<sup>st</sup> class shard wood with cross band and face veneer or plywood face panels including anodised aluminium butt hinges with necessary screws (A) Non-decorative type and block board core (2) 35 mm thick*

**1.0 Materials:** Flush door shall conform to M-30. Plywood shall conform to M-37. Anodised aluminium butt hinges shall conform to M-43.

**2.0 Workmanship:**

**2.1** The relevant specifications of item No. 10.23 shall be followed except that the shutters be non decorative type and block board core with face venner or plywood, with 35 mm thickness.

**2.2** Ready made shutters shall be correct size and shall fit into the door or other openings without excessive scraping of edges,. Adding of battens etc. to make up to the size shall not be allowed.

**3.0 Mode of measurements and payment:**

**3.1** The relevant specifications of item No. 10.12 (A) (I) shall be followed.

**3.2** The rate shall be for unit of one sq. meter.

**10.37** *Extra for using bright finished M. S. Piano hinges of anodised aluminium butt hinges in flush door shutters (A) Nickel Plated Piano hinges.*

**1.0 Materials & Workmanship:**

**1.1** The relevant specifications of item No. 10.30 shall be followed except that the nickel plated piano hinges shall be provided fixed. It shall conform to the latest Indian standards and shall be got approved by the Engineer-in-charge.

**2.0 Mode of measurements and payment:**

**2.1** The extra payment shall be made on sq. m. basis of door over and above the item No. 10.30 for providing bright finish M. S. piano hinges instead of anodised aluminium butt hinges.

**2.2** The rate shall be for unit of one sq. meter.

**10.39** *Extra for providing vision panel not exceeding 0.1 sq. m. in all types of flush doors (A) Rectangular or square.*

**1.0 Materials & Workmanship:**

**1.1** The relevant specifications of item No. 10.30 shall be followed except that the vision panel not exceeding 0.1 sq. m. shall be provided.



- 1.2 The glass panels shall conform to M-38 and this item is for extra work of providing vision panel rectangular of square not exceeding 0.1 sq. m. in all types of flush doors.
- 2.0 Mode of measurements & payment:**
- 2.1 The payment shall be made over and above of item No. 10.30 for this extra work on shutters in which vision panels are provided.
- 2.2 The rate shall be for a unit of one sq. meter of door area.
- 10.51 Providing and fixing 30 mm thick wire gauze shutters using galvanized M.S. Wire of I.S. gauge designation 85-G with wire of 0.56 mm. dia for doors, windows, and clerestory windows including anodized aluminium butt hinges with necessary screws: Indian teak wood.**
- 1.0 Materials:** Wire gauze jali shall conform to M-36. The teak wood shall conform to M-29. Anodised aluminium butt hinges shall conform to M-43.
- 2.0 Workmanship:**
- 2.1 Specifications for item No. 10.12(A)(I) shall be adopted for shutter, and fixtures and fastenings except that 30 mm thick wire gauze shutter shall be provided.
- 2.2 Wire gauze shuttering:**
- 2.2.1 The finished sizes of the wooden components like styles, rails, mountings shall be as per the panelled doors. Each leaf shall have 2 panels of wire gauze as per drawings or as directed.
- 2.2.2 The styles, rails etc. shall be rebated 12 mm along the side where they received the gauze. The galvanized iron webbing of 0.56 mm dia mesh shall be used unless other wise specified. The webbing shall be at 90<sup>0</sup> to 12 mm along both sides of the rebate and fixed securely to the styles and rails and mounting by 12 mm galvanized iron staples at about 7.5 cms intervals staggered spacing. Teak wood fillets of the size 10 mm x 10 mm shall be securely and neatly fixed with small screw spaced about 7.5 cm centers around the rebate for each panel of webbing. After the fillets are pressed well into the angle to hold the gauze in two faces, the exposed edge of fillets shall be neatly rounded. The gauze shall be tightly stretched during fixing. The space between fillet and the rebate where the webbing is bent shall be neatly finished with putty so that cut end of webbing may not be visible. Each shutter shall be fitted with a pair of anodised aluminium butt hinges with necessary iron screws.
- 3.0 Mode of measurements and payment:**
- 3.1 The relevant specifications of item No. 10.12 shall be followed.
- 3.2 The rate shall be for a unit of one sq. meter
- 10.53 Providing and fixing 30 mm thick wire gauze shutters using galvanized M. S. wire of wire gauze designation 85 G with wire of 0.56 mm dia for doors windows and clerestory windows including bright finished or and black enamelled M. S. butt hinges with necessary screws. Mango wood or equivalent quality.**
- 1.0 Materials & Workmanship:** The relevant specifications of item No. 10.51 shall be followed except that the hinges to be used shall be bright finished or and black enamelled M. S. butt hinges with screws and the wood shall be Mango wood or equivalent quality of non teak wood.
- 2.0 Mode of measurements and payments:**
- 2.1 The relevant specifications of item No. 10.12 shall be followed.
- 2.2 The rate shall be for unit of one sq. meter.
- 10.54 Extra for providing and fixing galvanized M. S. wire gauze of I. S. gauge designation 140 G. to doors, windows and clerestory windows with wire of**

*diameter 0.71 mm instead of I. S. gauge designation 85-G with wire of dia 0.56 mm.*

**1.0 Materials & Workmanship:**

**1.1** The relevant specifications for item No. 10.51 & 10.53 shall be followed for this item except that the diameter of wire shall be 0.71 mm of I. S. gauge designation 140-G instead of 0.56 mm diameter I.S. gauge designation 85 G.

**2.0 Mode of measurements & payments:**

**2.1** The payment shall be extra over and above the payment for galvanized M.S. Wire gauge.

**2.2** The rate I. S. gauge designation 85 G. shall of one sq mt of doors and windows shutters.

**10.74** *Providing and fixing 12 mm thick and 100 mm wide pelmet of flat pressed 3 layer veneered particle board solid core with 25mm diameter aluminium curtain rod and brackets including fixing with 25 mm x 3 mm M. S. flat 10 cms long and plugs etc. complete.*

**1.0 Material:**

**(1)** 3 layers veneered particle board solid core shall conform to M-40 (2) 25 mm diameter aluminium curtain rod and 25 mm x 3 mm x 10 cms long M. S. flat and plugs shall of best approved quality as directed.

**2.0 Workmanship:**

**2.1** The work shall be done as per drawing and description given in the item of work the wooden planks shall be planed smooth and even on the exposed surface.

**2.2** The pelmet shall be fixed to level by means of 10 cms long x 25 mm x 3 mm M. S. flat brackets lent in the form of angle and wooden plug fixed in the wall using wooden screws. For pelmet up to 1.5 mtr long two such brackets shall be used and additional bracket provided for longer pelmet at the rate of one per meter length extra. The curtain rods shall be fixed by suitable brackets at the ends to the pelmet as directed.

**3.0 Mode of measurements & payment:**

**3.1** Pelmets shall be measured in running meters along the sides and face.

**3.2** The rate shall be for a unit of one running meter.

**10.84** *Providing and fixing 40 mm panelled glazed or panelled and glazed partitions fixed to frames with iron screws etc. complete with Indian teak wood (Frames to be paid separately)*

**1.0 Materials:** Indian teak wood shall conform to M-29. Glass shall conform to M-38. Iron screws shall of best approved quality Plywood asbestos shall conform to relevant specifications of material.

**2.0 Workmanship:** The work shall be done as per detailed drawing or as directed. The wooden frames shall be of sizes as indicated in the drawing and description of item. They shall be planed and finished smooth and even. The vertical styles and rails shall be framed by tenon and mortise joints. The panels which may be planks, asbestos, ply woods, glass or any other materials specified shall be fixed in the grooves made in the styles and rails or by means of rebate and beading, fixed by suitable screws. When glazing is used as panels, the glass shall be fixed by using putty in addition to beading. The putty shall be used before applying beading material.

**3.0 Mode of measurements & payment:**

**3.1** Partitions shall be measured in square meter of the net area of the filler materials provided.



- 10.85** *Providing and fixing decorative ply wood 4 mm thick in partitions including fixing to frame with screws etc. complete with 50 mm x 12 mm teak wood beading. (Frames to be paid separately)*
- 1.0** **Materials:** 4 mm thick decorative plywood shall be of best approved quality. Teak wood beading and screws shall be best approved quality as directed.
- 2.0** **Workmanship:** The relevant specifications shall be the same as per that of item no 10.84 except that partitions shall be with 4 mm thick decorative ply wood and with teak wood beading.
- 3.0** **Mode of measurement and payment:**
- 3.1** The specifications shall be same as that of item no 10.84.
- 3.2** The rate shall be for unit of one square meter.
- 10.86** *Providing and fixing plain asbestos cement sheet 6 mm thick in partition including fixing to frames with screws etc. complete with 50 mm x 12 mm deodar wood beading (Frames to be paid separately)*
- 1.0** **Materials:** Plain A. C. sheets shall conform to M-24. Deodar wood beading shall conform to M-29 A.
- 2.0** **Workmanship:** The relevant specifications of item no 10.84 shall be followed same except that plain asbestos cement sheet 6 mm thick shall be used in partition and Deodar wood beading of size 50 mm x 12 mm size shall be used.
- 3.0** **Mode of measurement and payment:**
- 3.1** The relevant specifications of item no 10.84 shall be followed except that the rate excludes cost of frame work.
- 3.2** The rate shall be for unit of one sq meter.
- 10.88** *Providing and fixing in partition 4 mm thick medium hard board of approved quality including fixing to frames with screws etc. complete with 50 x 12 mm. Teak wood beading (Frames to be paid separately).*
- 1.0** **Materials:** The hard board shall be 4 mm thick and of best quality and make as approved. Teak wood beading shall conform to M-29.
- 2.0** **Workmanship:** The relevant specifications of item no 18.84 shall be followed except that the hard board of 4 mm thickness shall be used in portion and teak wood beading 50 x 12 mm size shall be used.
- 3.0** **Mode of measurement and payment:**
- 3.1** The relevant specifications of item no 10.84 shall be followed, except that the rate excludes cost of frame work.
- 3.2** The rate shall be for a unit of one square meter.
- 10.96** *25 mm. thick wooden shelves supported on 40 x 40 x 6 mm. T or L iron brackets fixed at suitable distance not exceeding 75 cms apart with mango wood or equivalent quality.*
- 1.0** **Materials:** The mango wood shall conform to M-29 A. Structural steel shall conform to M-22.
- 2.0** **Workmanship:** The mango wood or equivalent quality non teak wood shelves shall be repaired form 25 mm thick planks. The planks shall be planed smooth. The planks shall be used in single piece up to 30 cms width. The shelves shall be fitted in position by fixing 40 x 40 x 6 mm. T or L iron brackets. The spacing of brackets shall not be more than 75 cms. The 40 x 40 x 6 mm. T or L iron brackets shall be fixed firmly in position by embedding the same in concrete. The shelves shall be fixed as directed. The season teak wood buttons of 35 x 12 mm shall be fixed on open side as directed.
- 3.0** **Mode of measurements and payment:**
- 3.1** The shelves shall be measured in Sq. meter. The length and breadth of shelves shall be measured net.
- 3.2** The rate is inclusive of button provided.

- 3.3 The rate shall be a unit of one Sq. meter.
- 10.97 *40 mm thick wood shelves supported on 40 x 40 x 6 mm T or L iron brackets fixed at suitable distance but no exceeding 75 cms apart with mango wood or equivalent quality.*
- 1.0 **Materials & Workmanship:** The relevant specifications of item no 10.96 shall be followed except that the thickness of shelves shall be 40 mm. Thick teak wood battons shall be provided of 50 x 12 mm on all open sides.
- 2.0 **Mode of measurements and payment:**
- 2.1 The relevant specifications of item no 10.96 shall be followed.
- 2.2 The rate shall be for unit of one Sq. meter.
- 10.99 *Providing and fixing M. S. round or square bars with M. S. flats at required spacing in wooden frames of windows and clerestory windows.*
- 1.0 **Materials:** M. S. bars flats shall conform to M-18 and M-22 respectively.
- 2.0 **Workmanship:**
- 2.1 The M. S. bars shall be fabricated as shown in the drawing or as directed. It shall conform to I. S. 226-1975 and I. S. 961 and I. S. 1977-1975. The M. S. bars of shall be fixed at the required spacing in mild steel flats, after drilling holes in the later. The diameter and spacing of these bars shall be as mentioned in the drawing or as directed. The bars shall be passed through drill holes drilled into the mild steel flats, fixed in the recess in the frames. The flats shall be fixed with iron screws.
- 3.0 **Mode of measurements and payment:**
- 3.1 The rate shall be for the M. S. round or square bars with M. S. provided and fixed in position as per the specifications for the completed item.
- 3.2 The rate shall be for a unit of one Kg.
- 10.100 (A) *Providing and fixing M. S. Grills of required pattern to wooden frames of windows frames of windows etc. with M. S. Flats at required spacing and frame around, square or round bars with round headed bolts and nuts or by screws : Plain Grill.*
- 1.0 **Materials :** The structural steel shall conform to M-22.
- 2.0 **Workmanship:**
- 2.1 The M. S. Grill shall be prepared as per the drawings or as directed for fixing to wooden frames of windows etc.
- 2.2 The grill shall be fabricated to the designs and patterns shown in the drawings and the weight shall be as directed and the joints shall be riveted or welded as shown in the plan or as directed. The grill so formed shall be fixed into the frames of the windows etc., before they are erected in position. The outside strip frame of the grill shall be housed to its full thickness into the recess cut into the frame of the windows etc. The grill shall be fixed to the frame with number of bolts and nuts of screws viz. bolt nut/screw per 30 cm. Of the length of outer strip subject to a minimum of 2 nos. on each side of the frame or as indicated in the drawings or as directed.
- 2.3 The bolts and nuts or screws shall be counter sunk and shall be fixed with the top of their heads flush with the face of frame strips.
- 3.0 **Mode of measurement and payment:**
- 3.1 No payment shall be made for weight of screws, bolts, nuts etc. Only weight of grill shall be paid.
- 3.2 The rate shall be for unit of one Kg.
- 10.100 (B) *Providing and fixing M. S. grill of required pattern to wooden frames of windows etc. with M. S. plates, at required spacing and frame around, square or round bars with round headed bolts and nuts or by screws and with ornamental grill.*

**1.0 Materials and Workmanship:**

**1.1** The relevant specification of item no 10.100 (A) shall be followed except that the work is for ornamental grill.

**2.0 Mode of measurement and payment:**

**2.1** The relevant specifications of item no 10.100 (A) shall be followed.

**2.2** The rate shall be for unit of one Kg.

**10.102. Providing and fixing hard drawn steel wire fabric 75 x 25 mm mesh of weight not less than 7.75 Kg. Per Sq. M. to window frames etc. including 60 x 20 mm beading of teak wood.**

**1.0 Materials:** Hard drawn wire fabric of 75 x 25 mm mesh shall conform to M-34. Teak wood beading shall conform to M-29.

**2.0 Workmanship:** The steel wire fabric 75 x 25 mm mesh of weight not less than 7.75 Kg. Per Sq. M. to window frames etc. shall be fabricated as per detail drawing. The wire fabric shall be fixed to windows frame by teak wood beading of 60 x 20 mm size by means of screws.

**3.0 Mode of measurement and payment:**

**3.1** The wire mesh (Hard drawn) shall be measured net clear opening of frame of windows in which mesh is fitted. Nothing shall be paid extra for fixing mesh in groove below teak wood beadings.

**3.2** The rate shall be for unit of one Sq. meter

**10.103 Providing and fixing fly roof galvanized M. S. wire gauge of I. S. gauge designation 85 G with wire of dia 0.56 mm. to windows and clerestory windows including 60 x 20 mm beading of Indian teak wood.**

**1.0 Materials:** The fly proof galvanized M. S. wire gauge shall conform to M-36. Teak wood beading shall conform to M-29.

**2.0 Workmanship:** The relevant specifications of item no 10.102 shall be followed except that the fly proof galvanized M. S. wire gauge of I. S. gauge designation o 85-G with wire of 0.56 mm shall be provided.

**3.0 Mode of measurement and payment:**

**3.1** The relevant specifications of item no 10.102 shall be followed.

**3.2** The rate shall be for unit of one Sq. Meter.

**10.120 Providing and fixing first class Indian teak wood 75 x 60 mm moulded hand rails in straight lengths completed.**

**1.0 Materials:** First class Indian teak wood shall conform to M-29.

**2.0 Workmanship:** The teak wood hand rail shall of size 75 x 60 mm. The hand rail shall be prepared from first class Indian teak wood. The hand rail shall be moulded as per detail drawings.

The hand rail shall be fixed in straight length as per detail drawings with screws. The relevant specifications of item no 10.4 shall be followed except that the teak wood work shall be for a railing of specified size.

**3.0 Mode of measurement and payment:**

**3.1** The hand rail shall be measured in running meter.

**3.2** The rate shall be for unit of one running meter.

**10.00 (I) Providing and fixing glazed louvered Glass windows and ventilators with teak wood frame 10 x 75 mm. size including 3 coats of oil painting to wood work etc. complete.**

**1.0 Materials:** Indian teak wood shall conform to M-29. Glass shall conform to M-38.

**2.0 Workmanship:** The relevant specifications of item no 10.1 (A) shall be followed for frame work except that the framework of 10x 7 cms. Size of required size ventilators shall be provided with glazed glass louvers. The glass louvers shall be provided as directed. In the groove of 1.25 cms. Depth made

in frames, the thickness of glass shall be 5 mm and glass shall be glass of best quality. The ventilation blades shall slope down towards the outside at an angle of 45°.

**3.0 Mode of measurements and payment:**

**3.1** The area of opening within the frame in which louvers are fixed shall be measured in sq. meters

**3.2** The rate includes painting 3 coats to wood work with ready mix paint.

**3.3** The rate shall be for a unit of one square meter.

**10.00 (II) Providing and fixing with wooden louvers plant 12 mm thick windows and ventilators with teak wood frame 10 x 7 cms. Size including 3 coats of oil painting to wood work etc. complete.**

**1.0 Materials and Workmanship:** The relevant specifications of item o 10.00 (I) shall be followed except that the teak wood planks 1 mm thick louvers shall be provided

**2.0 Mode of measurement and payment:**

**2.1** The relevant specifications of item no 10.00(I) shall be followed.

**2.2** The rate shall be for unit of one square meter.

**SECTION – 11**

**DETAILED SPECIFICATION – STEEL SHUTTERS, WINDOWS, VENTILATORS**

**11.2 (A) Steel work riveted, in built up sections, framed work including cutting, hoisting fixing in position and applying a priming coat of red lead paint. In beam and joints, channels, angles, tees, flats with connection plates or Angle cleats as in main & cross beams. Hop and jack rafters, purlins connected to common rafters and the like.**

**1.0 Materials:** The structural steel work shall conform to M-22. Red lead paint primer shall conform to I. S. : 102-1962.

**2.0 Workmanship:**

**2.1** The steel sections as specified or required shall be cut, square and to correct lengths, as per drawings and design. The cut ends exposed to view shall be finished smooth. No. two pieces shall be welded or other wise jointed to make up the required length of member, except as indicated in the drawings or as directed. All straightening and shaping to form shall be done by application of pressure and not by hammering. Any bending or cutting shall be carried out in such a manner as not to impair the strength of the metal. All operations shall be done in cold state unless otherwise directed/permitted.

**2.2** Steel riveted or bolted in built up sections, frame work.

**2.2.1** The steel structure as shown in the drawings or as per direction of the Engineer-in-charge shall be laid out one level platform to full scale and to full size or in parts. A steel tape shall be used for measurements to ensure maximum accuracy.

**2.2.2** Wooden templates 12 mm to 19 mm thick or metal sheet template shall be made to correspond to each connecting gussets plate and rivet holes shall be accurately marked on them and drilled. The template shall be laid on the steel members, and holes of the steel members shall also be marked for cutting. The base of steel columns and the position of Anchor bolts shall be carefully set out.

**2.2.3** All stiffeners shall be formed by pressure and where practicable, the metal shall not be cut and welded in making these. In major works or where so specified shop drawings giving complete details and information for the

fabrication of the component parts of the structure, including location type size, length and details of rivets, bolts, or weld shall be prepared in advance of the actual fabrication and as approved. The drawings shall indicate the shop and field rivets and bolts. The steel member shall be distinctly marked or stenciled with paint with the identification mark as given in the shop drawings. The bars shall be thickened at the ends, so as to provide for screwed threads and gradually tapered off to meet their normal section.

Great accuracy shall be observed in fabrication of various member, so that these can be assembled without being unduly packed, strained or forced into position and when built up, shall be true and free from twist, bniks, buckles, or open joints. Before making holes individual members for fabrication, the steel work intended to be riveted or bolted together shall be assembled or clamped properly and tightly so as to ensure close abutting or lapping of the different members. All stiffeners shall bear tightly both at top and bottom without being drawn or caulked. The abutting joints shall be cut or dressed true and straight and fitted close together.

Web splice plates and filters under stiffeners shall be cut to fit within 3 mm or flange angles, web plates of girders shall have not cover plates, shall have their ends flush with the top of angles forming the flanges unless otherwise required. The web plates when spiced shall have clearance of more than 6 mm. The erection, clearance for cleared ends of members connecting steel to steel shall preferably be not greater than 1.5 mm. The erection clearance at the ends of beams without web cleats shall to be more that 3 mm at each end but where for a practical reason greater clearance is necessary, suitably designed seating shall be provided.

Pins and rollers shall be accurately turned to gauge. These shall be straight and smooth and free from flaws. The roller bearing shall be provided with adequate arrangement for holding the girders or truss resting on it. In columns caps and bases, the ends of shafts together with the attached gussets angles, channels etc., after riveting together shall be accurately mechanized so that the parts connected butt against each other over the entire surfaces of contract connecting angles or channels shall be fabricated and placed in position with greater accuracy so that they are not unduly reduced in thickness by machining.

The ends of bearing stiffeners shall be machanised or ground to fit tightly both at the top and bottom. All holes shall generally be drilled to the required size and at the required size and at required position. Sub punching shall be permitted, provided it is done 3 mm or less in diameter and remade thereafter to the required size. The holes for rivets and bolts shall be larger by 0.4 to 6 mm than the nominal diameter of rivets or black bolts depending up on the diameter of rivets.

Holes shall have their axis perpendicular to the surface bored through. The drilling or reamering shall be free from butts, and the holes should be clean and accurate. Holes for counter shunk bolts shall be made in such a manner that their heads fit flush with the surface after fixing.

The fabrication work shall be completed in workshop as far as it is practicable to do so. Site joints shall be done with rivets and fitted bolts or black bolts, as shown in the drawings or as directed. Generally the following principles shall govern the use of rivets turned and fitted bolts, and black bolts.

- (i) Rivets and turned and fitted bolts shall be used where the connection is such that slip under load has to be avoided.

- (ii) Black bolts may be used very sparingly where a force is carried through a connection without impact, vibration or reversal of stresses.

**2.2.4 Riveting:** The parts assembled for riveting shall be in close contact with each other and the bearing stiffeners shall bear tightly both at top and bottom without being drawn or caulked. Members to be riveted shall be properly pinned or bolted and rigidly held together while riveting. Drifting of holes shall not be permitted except to draw the parts together and the drifting tools so used shall have maximum diameter not exceeding the nominal diameter of rivets or bolts. Drifting done during assembling shall not distort the metal or enlarge the holes.

The shanks of rivets shall project beyond the plate surface sufficiently so as to fill the hole thoroughly and from the required head after riveting.

The riveting shall be done by hydraulic or pneumatic process. However where such facilities are not available, hand riveting may be permitted. The rivet shall be heated red-hot, care being taken to control the temperature of heating so as not to burn the steel. Riveting of diameter less than 10 mm may be fitted cold. Rivets shall be of heat finish with heads full and of equal size. All loose, burnt or badly formed rivets with concentric or deficient heads shall be cut out and replaced. The heads of rivets shall be central to shanks and shall grip the assembled members firmly. In cutting out rivets, care shall be taken so as not to injure the assembled, members, caulking or recouping shall not be permitted.

For testing rivets, hammer weighing approximately 0.25 kg. shall be used of the rivets shall be tapped, slack rivets will give a hollow sound and a jar.

All rivet heads shall be painted with red lead paint within a week of their fixing.

**2.2.5 Bolting** all bolt heads and nuts shall be hexagonal and of equal size unless specified otherwise. The screwed heads shall conform to I.S. : 1363:1960 and the threaded surface shall not be tapered.

The bolts shall be of such length so as to project two clear threads the nuts, when fixed in position and these shall fit in the holes without any shakes. The nut shall be fit in the threaded ends of bolts properly. Where turned and fitted bolts are required to be used in place of rivets they shall be provided with washers not less than 6 mm thick so that the nut when tightened shall not bear on the unthreaded body of the bolt. Tapered washers shall be provided for all heads and nuts bearing on leveled surfaces. The threaded portion of the bolts shall not be within the thickness of the parts bolted together. The faces of the bolt and nuts abutting against steel members shall be machine finished. Where there is a risk of the nut being removed or becoming loose due to vibrations or reversal of stresses, these shall be secured from slackening by the use of locknuts, spring washers, cross cutting or hammering down of threads as directed.

Bolts, nuts and washers shall be thoroughly cleaned and dipped in double boiled linseed oil before use. The whole steelwork shall be painted with a coat of priming coat of red lead, as per relevant specifications of painting.

### **3.0 Mode of measurement and payment:**

**3.1** The steelwork shall be measured in general as under.

- (a) All work shall be measured on the basis of finished dimensions as fixed at site and measured net unless specified otherwise.
- (b) The weight of steel sections, steel strips in finished work shall be calculated from standard weight on the same basis on which steel is supplied to the



contractor by department or those given in relevant I. S. if steel is arranged by the contractor.

- (c) The weight of steel plates and strips shall be taken from relevant I. S. based on 7.85 kg/sq. meter for every millimeter sheet thickness if steel is supplied by the contractor, otherwise the weight shall be calculated on the basis on which steel is supplied to the contractor by department.
- (d) Unless otherwise specified weight of clearest, brackets, packing pieces, bolts, nuts, washers, distance pieces, separators, diaphragm gusset (taking over all square dimensions) fish plates etc. shall be added to the weight of respective items.
- (e) In riveted work allowance to be made of weight of rivet heads. No deductions shall be made for rivet or bolt holes excluding holes for anchor or holding down bolts.
- (f) For forged steel and steel casting weight shall be calculated on the basis of 850 kg/cum.
- (g) Unless otherwise specified an additional of 2.5 percent of the weight of structure shall be made for shop and site rivet heads in riveted steel structure.
- (h) Unless otherwise specified no allowance shall be made for the weld metal in case of welded steel structure.
- (i) Dimensions other than cross sections and thickness of plates shall be measured to nearest 0.001 m
- (j) Mill tolerance shall be ignored when weight is determined by calculation.

**3.2** The rate includes cost of all material, labour, erection, hoisting, scaffolding protective measure, required for proper completion of the item of work. This shall also included conveyance and delivery handling, loading, unloading and storing etc. required for completing the item described above including necessary wastage involved.

**3.3** The rate shall be for a unit of one quintal.

**11.2** *(D) Steel work riveted in built up section, framed work including cutting, hoisting, fixing in position and applying a priming coat of red lead paint in trusses, and trussed purlins, up to 25 mm span and 15 mm overall height.*

**1.0** **Materials Workmanship:** The relevant specifications of item no 11.2 (A) shall be followed except that the work shall be for trusses and trussed purlins up to 25 mm span and 15 mm overall height.

**2.0** **Mode of measurement and payment:**

**2.1** The relevant specifications of item no 11.2 (A) shall be followed.

**2.2** The rate shall be for unit of one quintal.

**11.4** *(A) Steel work welded in built up sections frame work including cutting, hoisting, fixing in position and applying priming coat of red lead paint. In beams and joints, channels, angles, tees, flats, with connecting plates or angle cleats as in plain and cross beams. Hip and jack rafters, purlins, connected to common rafters and the like.*

**1.0** **Materials and Workmanship:**

**1.1** The relevant specifications of item no 11.2 (A) shall be followed except that the steel work shall be done by welding.

**1.2** Welding shall generally be done by electric process. Gas welding shall be resorted to using oxyacetylene flame with specific approval. Gas welding shall not be permitted for structural steel work.

**1.3** The work shall be done as shown in the shop drawings which should clearly indicate various details of the joints to be welded, shop and site welds as well as type of electrodes to be used. Symbol for welding on plans and shop drawing shall be according to I. S. 813-1961. As far as possible every effort

shall be made to limit the welding that must be done after improper welding that is likely to be done due to heights and difficult position on scaffoldings etc.

The welding work shall conform to I. S. 816-1969.

**1.4 Preparation of surfaces:** Surface, which is to be welded together, shall be free from loose mill scale, rust, paint, grease or other foreign matter. A coating of boiled linseed oil shall be permitted.

**1.5 Assembly for welding:** Before welding is commenced, the plates shall first be brought together and firmly clamped or spot welded at specified distance. The temporary connection has to be strong enough to hold the plates accurately in place without displacement.

**1.6 Precautions:** All operations connected with welding and cutting equipment shall conform to safety requirement given in I. S. 818-1968

The following points shall be borne in mind during the process of welding:

(a) Welds shall be made in flat position wherever practicable.

(b) Arc length, voltage and amperage shall be suited to the thickness of material, type of groove and other circumstances of the work.

(c) The segments of welding shall be such that where possible, the members who offer the greatest resistance to compression are welded first.

**1.7** The defective welds, which shall be considered harmful to the strength, shall cut out and rewelded.

**1.8** Finished welds and adjacent parts shall be protected with clean boiled linseed oil and after all slag has been removed welds and adjacent parts shall be painted after the same are approved.

**1.9** All the members shall be thoroughly cleaned of rust, scales, dust etc, and given a priming coat of red lead paint before fixing them in position.

Testing of welding to be added in the specification I. N. 12.2.2.12 (i) to (viii)

**3.0 Mode of measurements and payment:**

**2.1** The relevant specifications of item No. 11.2 (1) shall be followed

**2.2** The rate shall be for unit of one quintal.

**11.4 (D) Steel work welded in built up sections framed work including cutting, hoisting, fixing in position and applying a priming coat of red paint in trusses and trussed purlines up to 25 m span and 15 mm overall height.**

**1.0 Materials and Workmanship:** The relevant specifications of item no 11.4(A) shall be followed except that the work shall be for trusses and trussed purlins up to 25 m span and 15 m overall height.

**2.0 Mode of measurements and payment:**

**2.1** The relevant specifications of item no 11.4 (A) shall be followed.

**2.2** The rate shall be for unit of one quintal.

**11.6 Providing and fixing in position collapsible shutters with vertical channels 20 x 10 x 2 mm braced with flat iron diagonal 20 x 6 mm size with top and bottom rails T iron 40 x 40 x 6 mm with 38 mm dia steel pulleys complete with bolts, units, locking arrangements, stoppers, handles, including a priming coat of red lead paint.**

**1.0 Materials:** The collapsible steel gate shall conform to M-33.

**2.0 Workmanship:** T-rails shall be fixed to the floor and to the lintel at top by means of anchor bolts, embedded in cement concrete on floor and lintel. The anchor bolts shall be placed approximately at 45 mm centers alternatively in the two flanges of the T iron. In the bottom runner (T-iron) shall be embedded in the floor and proper groove shall be formed along the runner for the purpose. The collapsible gate shall be fixed at the sites by fixing the end



double channels in the T-Iron rail and also by hold fasts bolted to the end double channel and fixed in the masonry of the side walls or the otherwise.

In case where the collapsible gate is not required to the lintel beams or slop above, a tee iron suitably designed may be fixed at the top embedded in masonry and provided with necessary clamps and roller arrangement at the top.

All the adjoining work damaged while fixing of gate shall be made good to match the existing work without any extra payment.

All the members of the collapsible gate including T-Iron shall be thoroughly cleaned of rust, scales, dust etc. and given a priming coat of red lead before fixing them in position.

**3.0 Mode of measurements and payment:**

**3.1** The collapsible gate shall be measured in sq. meter. The height of the gate shall be measured as the length of double channels and breadth from outside to outside of the end fixed double channels in open position of the gate. The rate includes providing handles, locking arrangements, stoppers etc.

**3.2** The rate shall be for unit of one sq. meter.

**11.7** *Providing and fixing 1 mm thick M. S. sheet sliding shutters both frame and diagonal braces of 40 x 40 x 6 mm. Angel iron 3.15 mm M. S. gusset plates at junctions and corners. 25 mm dia putty 40 x 40 x 6 mm. Angle and T-iron guide rail at top and bottom respectively with handles, stoppers and locking arrangements etc. including applying priming coat of red lead paint.*

**1.0 Materials:** M. S. sliding shutters shall be fabricated of M. S. component as given in the description of item. M. S. sheet 1 mm thick shall be fixed to the frame with rivets or welds as approved. The shutters shall be provided with top and bottom guide rails of angle or T-iron as specified and 25 mm dia steel pulleys at the top. The frame shall be riveted and/or welded and wherever riveting shall be done 3.15 mm gusset plates shall be provided at the junctions.

**2.0 Workmanship:**

**2.1** The shutters shall be single or double leaf shutters as specified. The guide rails shall be sufficiently long and continued along the wall on both ends so that the sliding shutters can rest against walls, living full opening when so required.

**2.2** The guide rails shall be fixed to the floor by means of anchor bolts embedded in the cement concrete floor. The steel section at the top shall be suitably supported from the walls. Two channel sections shall be suitably fixed vertically below the extreme clamps in the wall and floor to avoid the shutters from going out of the supports at the top and bottom. A suitable clamping arrangement will be provided at either end of the opening to avoid the shutters from rolling back into opening.

**2.3** All the adjoining work damaged while fixing shall be made good to match the existing work.

**2.4** All members of the sliding shutter including T-iron shall be thoroughly cleaned of rust, scales, dust etc. and given a priming coat of red lead before fixing them in position.

**3.0 Mode of measurements and payment:**

**3.1** The sliding doors shall be measured in sq. meter. The height of the shutters shall be measured from outside to cut of the guide rail and width outside to outside of shutters including vertical channels in side. The rate includes providing handles, stoppers and locking arrangements etc. complete.

**3.2** The rate shall be for unit of one sq. meter.

**SECTION – 12**  
**DETAILED SPECIFICATIONS – LABOUR FOR FIXING FIXTURES**  
**FASTENING**

**12.4 *Fixing metallic tower bolts of size with necessary screws etc complete(lower bolts and screws to be paid under separate items)***

**1.0 Workmanship:**

**1.1** This item provide for labour fixing metallic tower bolts of any size with screws, nuts etc.

**1.2** The tower bolts shall be fixed in proper position as shown in the drawings or as directed. There shall be fixed truly vertical or horizontal as the case may be.

**1.3** The screws shall be driven home with screwdriver. In not case the screws shall be hammered in.

**1.4** All recesses and seats shall be cut to the exact size for counter sinking etc. where so required

**1.5** Care/shall be taken to see that no gaps are left between the fitting and the surface meant to receive the fittings.

**1.6** The fitting shall be properly clamed and left in original finish after fixing.

**2.0 Mode of measurement and payment:**

(1) Cutting of holes, recesses and seats involved in process of fixing.

(2) Cost of filling and crushing materials where so required for seating of new fittings.

(3) Cost of nails etc for temporary positioning of fitting.

(4) Cost of cleaning materials like old washed dhoti, stain remove etc.

(5) Cost of making good the over cut recesses or holes, if any

(6) Cost of making hole of required size on the wooden frame for housing the bolt for locking.

**2.2** The rate including cost of labour involved in all operations required for proper completion of the items, including carriage, handling, fixing etc. complete.

**2.3** The rate shall be for unit of one number.

**12.5 *Fixing metallic flush bolts of sizes with necessary screws etc. complete (flush bolts and screws shall be paid under separate item)***

**1.0 Workmanship:**

**1.1** The relevant specifications shall be followed as per item no 12.4 except for fixing metallic flush bolts instead of tower bolts.

**2.0 Mode of measurements and payment:**

**2.1** The relevant specification of item no 12.4 shall be followed.

**2.2** The rate shall be for unit of one number.

**12.8 *Fixing metallic or plastic door handles of sizes with necessary screws etc. complete (door handles and screws to be paid under separate items)***

**1.0 Workmanship:**

**1.1** The relevant specifications of item no 12.4 shall be followed except fixing.

**2.0 Mode of measurements and payment:**

**2.1** The relevant specifications of item no 12.4 shall be followed.

**2.2** The rate shall be for unit of one number.

**12.10 *Fixing metallic gate and shutters hooks and eyes of sizes (hooks and eyes to be paid under separate item)***

**1.0 Workmanship:**

**1.1** The relevant specifications shall be followed as per item no 12.4 except that the fixing of eye and hooks instead of tower bolts.

**2.0 Mode of measurements and payment:**

**2.1** The relevant specifications of item no 12.4 shall be followed.

- 2.2 The rate shall be for unit of one number (hook and eye)
- 12.11 *Fixing metallic door latches of sizes with necessary screws (door latches and screws to be paid under separate items)***
- 1.0 Workmanship:**
- 1.1 The relevant specifications of item no 12.4 shall be followed except that fixing metallic door latches instead of tower bolts.
- 2.0 Mode of measurements and payment:**
- 2.1 The relevant specifications of item no 12.4 shall be followed.
- 2.2 The rate shall be for unit of one number.
- 12.12 *Fixing metallic mortise night latches with necessary screws including making necessary screws holes in wooden door shutters etc. complete (mortise night latches and screws to be paid under separate items)***
- 1.0 Workmanship:**
- 1.1 The relevant specifications of item no 12.4 above shall be followed except that the fixing of mortise night latches instead of tower bolts.
- 2.0 Mode of measurements and payment:**
- 2.1 The relevant specifications of item no 12 shall be followed.
- 2.2 The rate shall be for a unit of one number.
- 12.18 *Fixing metallic ball catchers 100 mm dia (Ball catchers to be paid under separate item)***
- 1.0 Workmanship:**
- 1.1 The relevant specifications of item no 12.4 shall be followed same except fixing of ball catcher's 100 mm dia.
- 2.0 Mode of measurements and payment:**
- 2.1 The relevant specifications of item no 12.4 shall be followed.
- 2.2 The rate shall be for unit of one number.
- 12.20 *Fixing metallic casement window fasteners with necessary screws etc. complete (Casement window fasteners and screws to be paid under separate item)***
- 1.0 Workmanship:**
- The relevant specifications of item no. 12.4 shall be followed except fixing metallic casement windows fasteners.
- 2.0 Materials & workmanship:**
- 2.1 The relevant specifications of item 12.4 shall be followed.
- 2.2 The rate shall be for a unit of one number.
- 12.21 *Fixing metallic casement stays of sizes with necessary screws etc. complete.(casement stays and screws to be paid under separate items.)***
- 1.0 workmanship:**
- 1.1 The relevant specifications of item no 12.4 shall be followed except fixing of metallic casement stays.
- 1.1 Mode of measurement & payment:**
- 2.1 The relevant specifications of item no 12.4 shall be followed.
- 2.2 The rate shall be for a unit of one number.
- 1.2 *Fixing metallic cup-board or ward robe locks of sizes with necessary screws etc. complete(locks and screws to be paid separately)***
- 1.3 Workmanship:**
- The relevant specifications of item no 12.4 shall be followed except that fixing metallic cup-board or ward robe locks of size with necessary screws etc. complete.
- 1.4 Mode of measurement & payment:**
- 2.1 The relevant specifications of item no 12.4 shall be followed.
- 2.2 The rate shall be unit of one number.

**12.25** *Fixing metallic or plastic cup-board or ward robe knobs of size with necessary screws/bolts etc. complete (knobs and screws/bolts to be paid separately)*

**1.5 Workmanship:**

The relevant specifications of item no 12.4 shall be followed except that fixing of metallic or plastic cup-board or ward robe knobs of sizes with necessary screws/bolts etc. complete.

**1.6 Mode of measurements & payments:**

1.7 The relevant specifications of item no 12.4 shall be followed.

1.8 The rate shall be unit of one number.

**1.9** *The fixing metallic floor doorstoppers of sizes with rubber cushion, screws etc. to suit shutter thickness complete. (floor, door stopper with rubber cushion and screws to be paid under separate items.)*

**1.10 Workmanship:**

1.11 The relevant specifications of item no 12.4 shall be followed except that fixing of metallic floor door stoppers.

**1.12 Mode of measurements & payments:**

1.13 The relevant specifications of item no 12.4 shall be followed.

1.14 The rate shall be unit of one number.

**1.15** *Fixing metallic door handles or knobs for metallic locks with necessary screws etc.(doors, handles/knobs and screws to be paid separately).*

**1.16 Workmanship:**

1.17 The relevant specifications of item no 12.4 shall be followed except that fixing of metallic door handles or knobs for mortice with necessary screws etc. complete.

**2.0 Mode of measurements & payment:**

**2.1** The relevant specifications of item no 12.4 shall be followed.

**2.2** The rate shall be for a unit of one number.

**SECTION – 13  
DETAILED SPECIFICATIONS FOR GLAZING**

**13.1** *Providing and fixing sheet glass, selected quality (type-C) bedded putty and fixed with wooden beading including cost of wooden beading of rist class teak wood and necessary cutting of glass 5 mm thick.*

**1.0 Materials:** The glass shall conform to M-18. The wood beading shall conform to M-29. Putty shall conform to I. S. 419-1967.

**2.0 Workmanship:**

**2.1** Size of glass for glazing shall allow a clearness of 2.5 mm between the edges of glass and the wood or metal surrounds. The clearness may be increased, provided the depth of the rebate of groove is sufficient to provide not less than 1.5 cm. Cover to the glass. The detailed process or glazing shall be as specified in I. S. 3548-1966

**2.2** All stains from the surface of glass shall be removed and cleaned with thinner or spirit without any extra payment.

**2.3 Wooden beading:**

**2.3.1** The size of the wood beads for glass panes shall be 1.5 cms x 3 cms unless otherwise specified. Bead shall be secured to wooden frames with either panels pains or screws and to metal frames in the way provided for in the frame.

**2.3.2** Sufficient putty compound shall be applied to the rebate so that when the glass has been pressed into the rebate, a bed of compound not less than 1.5 mm thick will remain between the glass and the rebate. There should also be surplus of compound squeezed out above the rebate, which should be stripped at an angle not undercut to prevent water accumulating. Beads should be bedded with compound against the glass and wood beads should also be bedded against the rebate.

Care should be taken to see that no voids are left between the glass and the bead.

**3.0 Mode of measurements and payment:**

**3.1** All measurements of cutting shall, unless otherwise stated, be held to include the consequent waste.

**3.2** Each pane of glass shall be measured to the nearest 0.5 cms both in width and height/length.

**3.3** Irregular shaped or circular panes shall be measured as the smallest rectangular area from which the irregular or circular pane can be cut.

**3.4** The rate includes cost of materials labour, required for complete of the item including hoisting, carriage, temporary erections like scaffolding etc.

**3.5** The rate also includes:

(i) The wastages and breakage involved in the process

(ii) Straight cutting on glass and glazing putty, teak wood beading glass, pins, etc. complete

**3.6** The rate shall be for a unit of sq. meter.

**13.1** *(II) Providing and fixing sheet glass selected quality (Type – C) bedded in putty and fixed with wooden beading including cost of wooden beading of first class teak wood and necessary cutting of glass 6 mm thick.*

**1.0 Materials & Workmanship:**

**1.1** The relevant specifications of item no 11.3 shall be followed except that the sheet glass of selected quality of 6 mm thick.

**2.0 Mode of measurement and payment:**

**2.1** The relevant specifications of item no 13.1(I) shall be followed.

**2.2** The rate shall be for a unit of one sq. meter

**13.3** *(C) Providing and fixing rough cast wired glass 6 mm thick bedded in putty and fixed with wooden beading including the cost of wooden beadings of Indian teak wood and necessary cutting of glass wired figured glass.*

**1.0 Materials:** Wired figured glass should conform to M-38. Wooden beading shall conform to M-29. Putty shall conform to I. S. 419-1967.

**2.0 Workmanship:** The relevant specifications of item no 13.1(I) shall be followed except that the wired figured glass of 6 mm thick shall be used.

**3.0 Mode of measurement and payment:**

**3.1** The relevant specifications of item no 13.1(I) shall be followed.

**3.2** The rate shall be for a unit of one sq. meter.

**13.5** *(3) Providing and fixing sheet glass ordinary quality bedded in the putty and fixed with wooden beading including the cost of wooden beading of first class teak wood and necessary cutting of glass 3 mm thick.*

**1.0 Materials:** Glass shall conform to M-38. Wooden beading shall conform to M-29. Putty shall conform to I. S. 419-1967.

**2.0 Workmanship:**

**2.1** The specifications of this item shall be followed as per item no 13.1 (I) except that the sheet glass of ordinary quality shall be used and thickness of sheet glass shall be 3 mm thick.

**3.0 Mode of measurement and payment:**

- 3.1 The relevant specifications of item no 13.1(I) shall be followed.
- 3.2 The rate shall be for a unit of one sq. meter.
- 13.5 *(4) Providing and fixing sheet glass ordinary quality bedded in the putty and fixed with wooden beading including the cost of wooden beading of first class teak wood and necessary cutting of glass 4 mm thick.*
- 1.0 **Materials and Workmanship:** The relevant specifications of item no 13.5(3) shall be followed, except that the thickness of ordinary sheet glass shall be 4 mm.
- 2.0 **Mode of measurement and payment:**
- 2.1 The relevant specifications of item no 13.1(I) shall be followed.
- 2.2 The rate shall be for a unit of one sq. meter.
- 13.7 *Extra for using ground glass (Frosted or obscured on one side) instead of plain glass.*
- 1.0 **Materials:** Glass shall conform to M-38. Wooden shall conform to M-29. Putty shall conform to I. S. 419-1967.
- 2.0 **Workmanship:** The specifications of this item shall be followed as per item no 13.1 except that ground glass (Frosted or obscured on one side) shall be used.
- 2.0 **Mode of measurement and payment:**
- 2.1 The payment shall be made on sq. mt. Basis extra over and above the payment for plain glass for using ground glass (Frosted or obscured)
- 2.2 The relevant specifications of item no 13.5(III) shall be followed.
- 2.3 The rate shall be for a unit of one sq. meter.
- 13.11 *(A) Difference in cost of material and labour involved in method of glazing if changed in item no 13.1 to front end back puttied and sprigged or fixed with glazing pins:*
- 1.0 **Materials and Workmanship:**
- 1.1 The relevant specifications of item no 13.1 shall be followed except that the glazing is to be done by front and back putting and springged or fixed with glazing pins.
- 2.0 **Mode of measurements and payment:**
- 2.1 The relevant specifications of item no 13.1(I) and 13.1(II) shall be followed.
- 2.2 The extra rate for extra cost involved shall be paid over and above item no 13.1 (I) and 13.1(II)
- 2.3 The rate shall be for a unit of one sq. meter.
- 13.12 *Grinding, polishing and round of edges glass or glazing sheets:*
- 1.0 **Materials:** The glass shall conform to M-38
- 2.0 **Workmanship:** The edges of glass or glazing sheets shall be grind polished and rounded of such that it renders uniform look throughout the length and shall be neatly finished. The work halls be carried out in best workman's like manner.
- 3.0 **Mode of measurement and payment;**
- 3.1 The edges of glass round, polished and rounded off shall be measured in meter.
- 3.2 The rate shall be for a unit of one running meter.

#### **SECTION – 14**

#### **DETAILED SPECIFICATIONS OF ITEMS – PAVING FLOOR FINISHING AS PER “SCHEDULE OF RATES”**

- 14.2 *(A) 40 mm thick marble chips flooring rubbed and polished (i.e. Terrazzo) to granolithic finishing with under layerly 30 mm thick cement concrete*

*(1:2:4) (1 cement:2 coarse sand: 4 graded stone aggregate 10 mm and down gauge) and top layer, 10 mm thick with white, black and black marble chips of required sizes from 1 mm to 4 mm nominal size laid in cement marble power mix 3:1 (3 cement : 1 marble powder by weight in proportion 4:7 cement marble powder mix:7 marble chips by volume) Dark shade pigment with ordinary cement (in top layer only)*

**1.0 Materials:** Water shall conform to M-1. Cement shall conform to M-3. Sand shall conform to M-6. Stone grit shall conform to M-8

The pigment incorporated in terrazzo shall be of permanent color and shall conform to requirement mentioned in Appendix A in I. S. : 2114:1962. Marble chips shall conform to M-46. The marble powder shall pass through I. S. Sieve terrazzo-30.

**2.0 Workmanship:**

**2.1** Terrazzo finish shall be laid over a layer of base concrete in case of ground floor. When the terrazzo floor is laid over R. C. C. slabs a crushing layer consisting of 75 mm thick lime concrete shall be provided below the terrazzo floor. The terrazzo flooring shall consist of an under layer of cement concrete and layer of terrazzo which shall be laid monolithically.

**2.2 Under layer:**

**2.2.1** The under layer shall be of cement concrete mix 1:2:4. The maximum size of aggregate used shall not exceed 10 mm. Specification for cement concrete shall be followed as per item no5.4.1

**2.3 Terrazzo topping:**

**2.3.1** The topping shall have mix of ordinary cement and marble powder in proportion(3:1) (3 cement : 1 marble powder :7 marble powder by weight) and marble aggregate shall be mixed in proportion 4:7(4 cement:7 marble by chips by volume). The thickness of concrete and crushing layer shall not be less than 10 cms and 7.5 cms respectively. The minimum thickness of under layer and topping shall be 40 mm.

**2.4 Panels:**

**2.4.1** The floor, both while laying the under layer and topping shall be divided into panels not exceeding 2 sq. m. in area so as to reduce the risk of cracking due to differential shrinkage or expansion of terrazzo and sub floor. The joints are so located that the layer dimensions of any panel do not exceed 2 M. the panels shall preferably be separated by means of dividing strips. However where the butt joints are provided, the bays shall be laid alternatively allowing for an interval of atleast 24 hours between the laying of adjacent bays.

**2.5 Mixing Materials;**

**2.5.1** With a view to avoid variation in color, mixing, shall be done in trough or tub and the complete quantities of cement and pigment required for one unit shall be mixed at the beginning of the work. Color cement and pigment mix shall be dry mixed with marble powder. The mix thus obtained shall be mixed with aggregate. Care shall be taken not to get the materials into a head as this would result in coarser aggregates moving on the sides and cement to the center. To the dry mix thus prepared, water shall be added in small quantities while materials are being worked to get a mix of proper consistency. The mixture shall be plastic but not so wet to flow. The mix shall be used within half an hour of mix of addition of water during preparation laying.

**2.6 Laying**

**2.6.1** The base shall be divided into panels with the help of dividing strips including the strips required for decorative design up to the finished surface level of the floor. Screed strips shall be used where the dividing strips are not used. The



base shall be cleaned of all dust, dirt, laintance and any loose materials. It shall be then wetted with water mopped and smeared with cement slurry at 2.75 kg/sq. mt Under layer shall be then spread and leveled with a screeding board. The top surface shall be left rough to provide a good bound to the terrazzo.

- 2.6.2** The terrazzo topping shall be laid while the under layer is still plastic but has hardened enough to prevent cement from rising to the surface. This is normally achieved between 18 to 24 hours after laying of under layer. A cement slurry preferably of the same color as the topping shall be brushed on the surface immediately before laying the topping. The terrazzo mix shall be laid to a uniform thickness on the screed bed and be complete thoroughly by tapping or rolling and traveled smooth. Excessive trowling or rolling in early stages shall be avoided as it results in working up cement to the surface which will reduce a surface liable to cracking and will require more grinding to expose marble chip. The terrazzo surface shall be lamped trowelled and brought one to required level by a straight edge and steel floats in such a manner that the maximum amount of marble chips come up and are spread uniform over the surface and no part of the surface is left without chips.

**2.7 Curing:**

- 2.7.1** The surface shall be left dry for air curing for a period of 12 to 24 hours. Thereafter, water shall be allowed to sand overnight in pools for a period of a minimum of four days. The floor shall be prevented from being subjected to extreme temperature.

**2.8 Grinding and finishing:**

- 2.8.1** Grinding and finishing shall be done either by hand or by machine. In case of manual grinding, the process of grinding shall begin after two days, while in case of machine grinding, the process shall be started after seven days after completion of laying.

- 2.8.2** First grinding shall be done by carborundum stones of 60 grit size. The surface shall then be washed clean and grouted with a grout of cement or/and coloring matter in the same mix and proportion as the topping in order to fill any pin holes that appear. It shall be allowed to dry for 24 hours and wet cured for four days in the same manner as mentioned in para 2.7 above.

- 2.8.3** The second grinding shall be done with carborundum stone of 80 grit size. The surface shall then prepared as after first grinding. The third grinding shall be done with carborundum stone of 120 to 150 grit size. The surface shall be washed again and allowed to dry for 12 hours and wet cured four days as before. The fourth grinding shall be done with carborundum stone of 320 to 400 grit size. The surface shall again be washed clean rubbed hard with felt and slightly moistened Oxalic acid powder @ 5 gms. Per sq. meter of floor surface. After the finishing work is over, the surface shall be washed with dilute oxalic acid solution and dried for floor polishing machine fitted with felt or hession bobs shall then be run over it until floor shines. In case wax polished surface is required, was polished shall be applied on the surface with the help of soft linen over a clean and dry surface. The polishing machine fitted with bobs shall be run over it, clean saw dust shall be spread over the floor surface and polishing machine again operated which will remove excess wax and leave glossy surface. Floor shall not be left slippery.

**3.0 Mode of measurement and payment:**

- 3.1** Terrazzo flooring shall be measured as laid in sq. meters. Length and breadth shall be measured for visible area of work done. Nod deduction shall be made for, nor extra for any opening in floor or area up to 0.10 sq. mt. The rate shall



cover laying the floor at different levels in the same room or court yard and nothing extra shall be paid on the account.

3.2 The rate includes the cost of all materials and labour involved in all operations described above. The rate shall also not include dividing strip.

3.3 The rate shall be for a unit of one sq. mt.

14.2 *(B) 40 mm thick marble chips, flooring rubbed and polished (i.e. Terrazzo) to granolithic finish with under layer 30 mm thick cement concrete 1:2:4(1 cement : 2 coarse sand : 4 graded stone aggregate 10 mm and down gauge) and top layer 10 mm thick with white, black or white and black marble chips of required sizes form 1 mm to 4 mm nominal size laid in cement marble powder mix 3:1(3 cement : 1 marble powder mix by weight in proportion 4:7(4 cement : marble powder : 7 marble chips by volume ): light shade pigment with white cement (in top layer only)*

1.0 **Materials and Workmanship:**

1.1 The relevant specifications of item no 14.2(A) shall be followed, except light shade pigment with white cement shall be used in top layer.

2.0 **Mode of measurements and payment:**

2.1 The relevant specifications of item no 14.2 (A) shall be followed.

2.2 The rate shall be for a unit of one sq. meter.

14.2 *(C) 40 mm thick marble chips, flooring rubbed and polished (i.e. Terrazzo) to granolithic finish with under layer 30 mm thick cement concrete 1:2:4(1 cement : 2 coarse sand : 4 graded stone aggregate 10 mm and down gauge) and top layer 10 mm thick with white black or white and black marble chips of required sizes form 1 mm to 4 mm nominal size laid in cement marble powder mix 3:1(3 cement : 1 marble powder mix by weight) in proportion 4:7(4 cement : marble powder:7 marble chips by volume). Medium shade pigment with approx, 50% white cement and 50% ordinary cement (in top layer only).*

1.0 **Materials and Workmanship:**

1.1 The relevant specifications of item no 14.2(2) shall be followed, except that medium shade pigment with approximately 50% white cement 50% ordinary cement in top layer only shall be used.

2.0 **Mode of measurements and payment:**

2.1 The relevant specifications of item no 14.2(A) shall be followed.

2.2 The rate shall be for a unit of one sq. meter.

14.2 *(D) 40 mm thick marble chips, flooring rubbed and polished (i.e. Terrazzo) to granolithic finish with under layer 30 mm thick cement concrete 1:2:4(1 cement : 2 coarse sand : 4 graded stone aggregate 10 mm and down gauge) and top layer 10 mm thick with white black or white and black marble chips of required sizes form 1 mm to 4 mm nominal size laid in cement marble powder mix 3:1(3 cement : 1 marble powder mix by weight) in proportion 4:7(4 cement : marble powder:7 marble chips by volume).White cement without any pigment (in top layer only)*

1.0 **Materials and Workmanship:**

1.1 The relevant specifications of item no 14.2(2) shall be followed, except that the white cement without any pigment in top layer shall be used.

2.0 **Mode of measurements and payment:**

2.1 The relevant specifications of item no 14.2(A) shall be followed.

2.2 The rate shall be for a unit of one sq. meter.

14.2 *(E) 40 mm thick marble chips, flooring rubbed and polished (i.e. Terrazzo) to granolithic finish with under layer 30 mm thick cement concrete 1:2:4(1 cement : 2 coarse sand : 4 graded stone aggregate 10 mm and down gauge)*

*and top layer 10 mm thick with white black or white and black marble chips of required sizes form 1 mm to 4 mm nominal size laid in cement marble powder mix 3:1(3 cement : 1 marble powder mix by weight) in proportion 4:7(4 cement : marble powder:7 marble chips by volume).Light shade pigment with ordinary cement (in top layer only).*

**1.0 Materials and Workmanship:**

**1.1** The relevant specifications of item no 14.2(2) shall be followed, except that the light shade pigment with ordinary cement (in top layer only) shall be used

**2.0 Mode of measurements and payment:**

**2.1** The relevant specifications of item no 14.2(A) shall be followed.

**2.2** The rate shall be for a unit of one sq. meter.

**14.4 (A) Marble chips skirting (terrazzo) of dedor rubbed and polished to granolithic finish top layer 6 mm thick with white and black or white and black or white and black marble chips of sizes from smallest to 4mm. Nominal size laid in cement marble powder mix 3:1 (3 cement : 1 marble powder by weight) in proportion of 4:7 (4 cement : 7 marble chips by volume) 20 mm. Thick with under layer 14 mm. Thick in cement plaster 1:3 (1 cement : 3 coarse sand) : Dark shade pigment with ordinary cement (in top layer only).**

**1.0 Materials :**

**1.1** The relevant specifications of item No. 14.2(A) shall be followed.

**2.0 Workmanship :**

**2.1 Under layer :** The under layer for terrazzo on vertical surfaces like skirting and dedo shall be of stiff cement mortar 1:3 (1 cement, 3 coarse sand) finished rough so as to give a good bond to the topping.

**2.2** Terrazzo topping shall not be less than 6 mm. Thick and the combined thickness of under layer and topping shall be not less than 20 mm. The other details shall be followed same as per specifications of item no. C 24 except that the light shade pigment with white cement in top layers shall be used.

**3.0 Mode of measurement & payment :**

**3.1** The skirting and dedo shall be measured in square metres correct to two places of decimal. The height shall be measured from the finished level of floor.

**3.2** The rate shall be for a unit of one sq. metre.

**14.4 (B) Marble chips skirting (terrazzo) of dedo dubbed and polished to granolithic finish top layer 6 mm. Thick with white, black or white and black marble chips of sizes from smallest to 4 mm. Nominal size laid in cement marble powder mix 3:1 (3 cement: 1 marble power by weight) in proportion of 4:7 (4 cement marble powder mix: 7 marble chips by volume) 20 mm. Thick with under layer 14 mm. Thick in cement plaster 1:3 (1 cement: 3 coarse sand): medium shade pigment with approximate 50% white cement and 50% ordinary cement (In top layer only).**

**1.0 Materials & Workmanship:**

**1.1** The relevant specifications of item No. 14.4 (A) shall be followed except that the light shade pigment with white cement in top layers only shall be used.

**2.0 Mode of measurement & payment :**

**2.1** The relevant specifications of item No. 14.4 (A) shall be followed.

**2.2** The rate shall be for a unit of one square metre.

**14.4. (C) Marble chips skirting (terrazzo) of dedo rubbed and polished to granolithic finish top layer 6 mm. thick with white, black or white and black marble chips of sizes from smallest to 4 mm, nominal size laid in cement marble powder mix 3:1 (3 cement : 1 marble powder by weight) in proportion of 4:7 (4 cement marble powder mix : 7 marble chips by volume)**

*20 mm. thick with under layer 14 mm. thick in cement plaster 1:3 (1 cement : 3 coarse sand) : medium shade pigment with approximate 50% in cement plaster 1:3 (1 cement : 3 coarse sand : medium shade pigment with approximate 50 % white cement and 50% ordinary cement (in top layer only).*

**1.0 Materials & Workmanship :** The relevant specifications of item No. 14.4 (A) shall be followed except that the medium shade pigment with approximate 50% white cement and 50% ordinary cement in top layers only shall be used.

**2.0 Mode of measurements & payment :**

**2.1** The relevant specifications of item No. 14.4 (A) shall be followed.

**2.2** The rate should be for a unit of one Sq. metre.

**14.4. (D) Marble chips skirting (terrazzo) of dedo rubbed and polished to granolithic finish top layer 6 mm. thick with white, black or whiter and black marble chips of sizes from smallest to 4 mm. nominal size laid in cement marble powder mix 3:1 (3 cement: 1 marble powder by weight) in proportion of 4:7 (4 cement marble powder mix: 7 marble chips by volume) 20 mm. thick with under layer 14 mm. thick in cement plaster 1:3 (1 cement: 3 coarse sand): medium shade pigment with approximate 50% in cement plaster 1:3 (1 cement : 3 coarse sand) : white cement without any pigment (In top layer only).**

**1.0 Materials & Workmanship :** The relevant specifications of item No. 14.4 (A) shall be followed except that the white cement without any pigment in top layers shall be used.

**2.0 Mode of measurements & payment :**

**2.1** The relevant specifications of item No. 14.4 (A) shall be followed.

**2.2** The rate should be for a unit of one Sq. metre.

**14.4. (E) Marble chips skirting (terrazzo) of dedo rubbed and polished to granolithic finish top layer 6 mm. thick with white, black or white and black marble chips of sizes from smallest to 4 mm, nominal size laid in cement marble powder mix 3:1 (3 cement: 1 marble powder by weight) in proportion of 4:7 (4 cement marble powder mix: 7 marble chips by volume) 20 mm. thick with under layer 14 mm. thick in cement plaster 1:3 (1 cement: 3 coarse sand) light shade pigment with ordinary cement (in top layer only).**

**1.0 Materials & Workmanship :**

**1.1** The relevant specifications of item No. 14.4 (A) shall be followed except that the light shade pigment with ordinary cement in top layers only shall be used.

**2.0 Mode of measurements & payment :**

**2.1** The relevant specifications of item No. 14.4 (A) shall be followed and except that the light shade pigment with ordinary cement in top layers only shall be used.

**2.2** The rate should be for a unit of one Sq. metre.

**14.16. Providing and laying cushioning layer on R.C.C. slab consisting of 75 mm. thick lime concrete using brick aggregate of 20 mm. nominal size 50% mortar comprising of 1 lime : 2 fine sand.**

**1.0 Materials :**

**1.1** Water shall conform to M-1 Lime mortar of proportion 1:2 shall conform to M-10. Brick aggregate 20 mm. nominal size shall conform to M-14.

**2.0 Workmanship :**

**2.1** The relevant specifications of item No. 4, 18 shall be followed except that the proportion of mix shall be 50% mortar comprising of 1 lime : 2 coarse sand and the size of brick aggregate shall be 20 mm. nominal size. The lime

concrete work shall be carried out in 7.5 cms. Average thickness as a cushioning layer on R.C.C. slab.

**3.0 Mode of measurement & payment :**

**3.1** The line concrete work shall be measured for visible area of work done.

**3.2** The rate shall be for a unit of one sq. metre.

**14.19** *Precast terrazzo (Mosaic) tiles 20 mm. thick with white, black or white and black marble chips of sizes upto 6 mm. laid in floors, treads of steps and landings on a bed of 25 mm. average thickness of lime mortar 1:1.5 (1 lime putty : 1.5 Fine sand) or C.M. 1:6 jointed with neat cement slurry mixed with pigment to match the shade of the tiles including rubbing and polishing complete with precast tiles of : Light shades, using white cement.*

**1.0 Materials :**

**1.1** Water shall conform to M-1. Cement shall conform to M-3. Lime Mortar shall conform to M-10. Cement mortar shall conform to M-11. The precast terrazzo tiles of 20 mm, thick shall be of light shade using white cement and conform to M-47.

**2.0 Workmanship :**

**2.1** The work shall be carried out as per I.S. 1443-1972.

**2.2 Bedding :**

**2.2.1** Before spreading the mortar, the sub-base of the floor shall be cleaned of all dirt, scum and loose materials and then well wetted without forming any pools of water on the surface.

**2.2.2** In case of R.C.C. floors, the top shall be left a little rough, all points of level for the finished surface shall marked out. The lime mortar of proportion 1:1.5 (lime putty : 1.5 line sand) or cement mortar of proportion C.M. 1:6 as directed shall be then evenly and smoothly spread over the base. Bedding layer of mortar of mortar shall be not less then 10 mm. and average thickness of bedding shall be 25 mm.

**2.3 Laying :**

**2.3.1** Before laying the terrazzo (Marble/Mosaic) tiles the tiles shall be thoroughly wetted with water. Neat cement group of required consistency at 4.4 kg. Cement/sq.mt. shall be spread on the mortar bed. The tiles shall be laid on the neat cement float and shall evenly and firmly bedded to the required level and slope. There shall be no hollows left. The joints shall be of uniform thickness and in straight line as per the pattern.

**2.3.2** The surface of flooring shall be checked frequently with a straight edge at-least two metres so as a obtain a true surface with required slope.

**2.3.3** The tiles, which are fixed in the floor adjoining the wall, shall go about 10 mm. under plaster. Skirting or dedo shall be left unfinished for about 50 mm. above finished floor level and unfinished strip them left earlier shall be finished.

**2.3.4** In places where full tiles can not be fixed, the tiles shall be cut to the size and smoothed at edges to give straight and true joins.

**2.3.5** After the tiles have been laid, the surplus cement slurry and the joints shall be cleaned washed fairly deep before cement hardens.

**2.3.6** The day after tiles have been laid, the joints shall be cleaned of grey cement grout with a wire brush to a depth of about 5 mm. and then grouted with white cement with or without pigment to match the shade of the topping of tiles. The same cement slurry shall then be spread over the whole surface in a thin coat to protect the surface from abrasive damage and to fill pin holes that may exist on the surface.

**2.4 Curing :**

**2.4.1** The flooring shall be kept wet with damp sand or water for seven days. It shall be kept undisturbed atleast for 14 days. The grinding shall normally be commenced after 14 days.

**2.5 Polishing :**

After the tiles are properly cured, first grinding shall be done with carborundum stone of 48 to 60 grade grit fitted in machine. Water shall be properly used during grinding. When the chips show up and the floor has been uniformly rubbed, it shall be cleaned with water, baring all pin holes. It shall be covered with a thin coat of white cement mixed with or without pigments to match the colour of the topping of the tiles. Pin holes if any shall thus be filled. This grout shall be kept moist for a week. Thereafter second grinding shall be started with carborundum of 120 grit. Grouting and curing shall follow again. Final grinding shall be done when other works are finished. The machine shall be fitted with carborundum of grit 220 to 350 using water in abundance. The floor shall then be washed clean with water oxalic acid powder shall the be dusted at 33 grams per sq.mt. on the surface and the surface rubbed with machine fitted with hessain bobs.or rubbed hard with pad of woolen rags.the floor shall than be washed clean and dried with a soft cloth or linen. The finished floor shall not sound hollow when tapped with a mallet.

**2.5.2** If any tile is disturbed or damage it shall be refitted or replace properly jointed and polished.

**2.5.3** Testing of the tiles shall be carried out by the contractor at his own his cost as per I.S. requirement for required tests.

**3.0 Mode of measurement & payment :**

**3.1** Terrazzo tiles flooring shall be measured in sq. metres for visible area of work done.

**3.2** No deductions shall be made not extra paid for any opening in the floor area upto 0.1 sq. mt. Nothing extra shall be paid for use of cut tiles or for laying the floors at different levels in the same room or court yarn. Mosaic tiles laid in floor borders and bands etc. shall be measured in the same item and nothing extra shall be payable on account of these or similar bonds formed of half or multiples of half size standard tiles/or other uncut tiles.

**3.3** The trades of stairs and steps paved with tiles without nosing shall also be measured under this item.

**3.4** Extra rate shall however be paid for such area where width of treads does not exceed 30 cms.

**3.5** The rate shall include the cost of all materials, labour involved in all the operations as described above.

**3.6** The rate shall be for a unit of a one sq. metre.

**14.19 (B) *Precast Terrazzo (Marble/Mosaic) tiles 20 mm. thick with white black or white and black marble chips of size upto 6 mm. laid in floors, treads of steps and landing on a bed of 25 mm. average thickness of lime mortar 1:1.5 (1 lime putty : 1.5 fine sand) or C.M. 1:6 jointed with neat cement slurry mixed with pigment to match the shade of the tiles, including rubbing and polishing complete with precast tiles of medium shades using approximately 50% white cement and 50% ordinary cement.***

**1.0 Materials & workmanship :**

**1.1** The relevant specifications of item No. 14.19 (A) shall be followed except that the precast terrazzo (marble mosaic) tiles shall be medium shades approximately 50% white cement and 50% ordinary cement.

**2.0 Mode of measurements & payment :**

**2.1** The rate shall be for a unit of one sq. metre.

**14.19 (C) Precast terrazzo marble mosaic tiles 20 mm. thick with white black or white and black marble stone chips of size upto 6 mm. laid in floors, treads of steps and landing on a bed of 25 mm. average thickness of lime mortar 1:1.5 (1 Lime putty: 1.5 fine sand) or C.m. 1.6 jointed with neat cement slurry mixed with pigment to match the shade of tiles including rubbing and polishing complete with precast tiles of dark shade using ordinary cement.**

**1.0 Materials & Workmanship:**

**1.1** The relevant specifications of item No. 14.19(A) shall be followed except that the precast tile shall be of Dark shade using ordinary Portland cement.

**2.0 Mode of measurements & payment :**

**2.1** The mode of measurements and payment shall be same as item No. 14.19 (A).

**2.2** The rate shall be for a unit for sq. metre.

**14.21 (A) Precast terrazzo (Marble/Mosaic) tiles 20 mm. thick with marble chips of size upto 6 mm. in skirting and riser of steps not exceeding 30 cms. In height on 10 mm. thick cement plaster 1:8 (1 cement : 8 coarse sand )jointed with neat cement slurry including rubbing and polishing complete with tiles of light shades using white cement.**

**1.0 Materials :** Water shall conform to M-1. Cement Mortar shall conform to M-11. The precast terrazzo (Marble/Mosaic) tiles of light shade using white cement tiles 20 mm. thick shall conform to M-47.

**2.0 Workmanship :** The work shall be carried out for skirting as dedo. Before fixing precast terrazzo (Mosaic marble) tiles of shade and size as specified, the surface shall be prepared by heavy scarping, making joints etc. to the required line, level and plumb. The surface shall be thoroughly wetted before commencing the laying work. Thereafter about 10 mm. thick backing of cement mortar in specified proportion shall be applied on the surface in true like and level generally as per specifications of plaster item.

**2.2 Fixing :** The back of each tile to be fixed shall be smeared with cement paste of matching colour and the mosaic tiles shall then be gently tapped against the surface, with a wooden mallet. The skirting shall be done only after the flooring is completed. Any pipes coming out of the wall through the dedo or skirting shall only beat at the intersections of the horizontal and vertical joints. The tiles shall not have staggered joints. The joints shall be true to entire line both ways and vertical joints shall be in line with joints of flooring. Tiles shall be fixed as close as possible to the adjoining tiles and any difference in the thickness of the mosaic tiles shall be evened out in the cement paste so that all the tiles faces are set in conformly with one another. The skirting shall project uniformly and not more than 6 mm. thickness beyond the finished surface above. Top of skirting of dedo shall be truly horizontal. The rises of steps, skirting or dedo shall rest on top of treads of flooring wherever required. The tiles shall be cut (sawn) and thin edges smoothed before use.

**2.3 Curing :** Curing shall be done for 7 days continuously.

**2.4 Finishing :** Skirting and dedo shall be hand polished to have an even smooth and shining surface. In case of skirting only 10 mm. x 10 mm. groove shall be provided at the junction of cement plaster and cement tiles.

**3.0 Mode of measurement & payment :**

**3.1** The terrazzo tiles with light shade using white cement base shall be paid under this item. The length shall be measured along finished surface of the riser, skirting or dedo, correct to a centimeter height measured from finished or treads or floor to the top (under side or treads in case of steps).

**3.2** The rate shall include all materials and labour required for all the operations involved and described above.



- 3.3 The rate shall be for a unit of one sq. metre.
- 14.21 (B) *Precast terrazzo tiles 20 mm. thick with marble chips of size upto 6 mm. in skirting and risers of steps not exceeding 30 cms. in height on 10 mm. thick cement plaster 1:3 (1 cement : 3 coarse sand) jointing with neat cement slurry including rubbing and polishing complete with tiles of medium shades using approximately 50% white cement and 50% ordinary cement.*
- 1.0 Materials & Workmanship :**
- 1.1 The relevant specifications of item no. 14.21 (A) shall be followed except that the work is for using tiles of medium shades using approximately 50% white cement and 50% ordinary cement.
- 2.0 Mode of measurement & payment :**
- 2.1 The mode of measurements and payment shall be followed same as item no. 14.21 (A).
- 2.2 The rate shall be for a unit of one sq. metre.
- 14.21 (C) *Precast terrazzo tiles 20 mm. thick with marble chips of size upto 6 mm. in skirting and risers of steps not exceeding 30 cms. In height on 10 mm. thick cement plaster in C.M. 1:3 (1 cement : 3 sand) jointing with neat cement slurry including rubbing and polishing complete, with tiles of Dark shade using ordinary cement.*
- 1.0 Materials & workmanship :**
- 1.1 The relevant specifications of item No. 14.21 (A) shall be followed except that the tiles of dark shade using Portland cement shall be used.
- 2.0 Mode of measurement & payment :**
- 2.1 The mode of measurements and payment shall be followed as per item No. 14.21 (A).
- 2.2 The rate shall be for a unit of one sq. metre.
- 14.25 (A) *Checkered terrazzo tiles 2 mm. thick with marble chips of size upto 6 mm. in floor on 25 mm. thick bed of like mortar 1:1.5 (1 land putty: 1.5 coarse sand) or C. M. 1:5 joint with neat cement slurry mixed with pigment to match the shade of the tiles including rubbing & polishing etc. complete, light shade using white cement.*
- 1.0 Materials :** Water shall conform to M-1 white cement shall conform to M-4. Lime mortar of proportion of 1:1.5 shall conform to M-10 cement mortar shall conform to M-11. Checkered tiles shall conform to M-47 D.
- 2.0 Workmanship:**
- 2.1 The relevant specification of item 14.21 (A) shall be followed except that checkered tiles of light shade using white cement shall be used.
- 3.0 Mode of measurement & payment :**
- 3.1 The relevant specification of item no. 14.21 (A) shall be followed.
- 3.2 The rate shall be for a unit of one sq. metre.
- 14.25 (B) *Checkered terrazzo tiles 25 mm. thick with marble chip of size upto 6 mm. in floors on 25 mm. thick bed. of like mortar 1:5 (1 Lime putty : 1.5 coarse sand) C.M. 1:6 jointed with neat cement slurry mixed with pigment to match the shade of the tiles including rubbing & polishing etc. complete. Medium shade using approximately met 50% white cement and 50% ordinary cement.*
- 1.0 Materials & Workmanship :**
- 1.1 The relevant specification of item no. 14.25(A) shall be followed except that the checkered tiles of medium shade using approximate 50 % white cement and 50 % ordinary cement shall be used.
- 2.0 Mode of measurement & payment :**

- 2.1 The relevant specifications of item no. 14.25 (A) shall be followed.
- 2.2 The rate shall be for unit of one sq. metre.
- 14.25 (C) Checkered terrazzo tiles 25 mm. thick marble chip or size upto 6 mm. floors on 25 mm. thick bed of like mortar 1:1.5 (1 lime putty : 1.5 coarse sand) or C.M. 1.6 joint with neat cement slurry mixed pigment to match the shade of the tiles including rubbing & polishing complete. "Dark shade using ordinary cement".**
- 1.0 Materials & Workmanship :**
- 1.1 The relevant specifications of item no. 14.25 (A) shall be followed except that checkered tiles or dark shade using ordinary cement shall be used.
- 2.0 Mode measurement & payment :**
- 2.1 The relevant specifications of item no. 14.25 (A) shall be followed.
- 2.2 The rate shall be for a unit of one sq. metre.
- 14.26 (A) Checkered terrazzo tiles 28 mm. thick with marble chips of size upto 6 mm. in trades of stairs and staircases in 12 mm. thick bed of lime mortar 1:1.5 (1 Lime putty : 1.5 coarse sand) or C.M. 1.6 joint with neat cement slurry mixed with pigment to match the shade of tiles including rubbing & polishing complete, light shade using white cement.**
- 1.0 Materials & Workmanship :**
- 1.1 The relevant specifications of item no. 14.25 (A) shall be followed except that the checkered tiles 28 mm. thick of light shade using white cement shall be used in staircases etc.
- 2.0 Mode measurement & payment :**
- 2.1 The relevant specification of item no. 14.25 (A) shall be followed.
- 2.2 The rate shall be for a unit of one sq. metre.
- 14.27 (B) Checkered terrazzo tiles 28 mm. thick with marble chips of size upto 6 mm. in stairs & staircases in 12 mm. thick bed of lime mortar 1:1.5 (1 Lime putty : 1.5 coarse sand) or 1:6 joint with neat cement slurry mixed pigment to match the shade of tiles including rubbing & polishing complete, medium shade using approximately 50 % white cement & 50 % ordinary cement.**
- 1.0 Materials & Workmanship :**
- 1.1 The relevant specifications of item no. 14.25 (A) shall be followed except that the checkered tiles 28 mm. thick of medium shade using approximately 50% white & 50% ordinary cement shall be used. In stair, staircases etc.
- 2.1 The relevant specifications of item No. 14.25(A) shall be followed.
- 2.2 The rate shall be for a unit of One. Sq. meter.
- 14.27 (C) Checkered terrazzo tiles 28 mm thick with marble chip of size of upto 6 mm in treads of stairs and staircases in 12 mm thick bed of like mortar 1:1.5 (1 Lime putty : 1.5 coarse sand) or C.M. 1:6 Jointed with neat cement slurry mixed with pigment to match the shade of tiles including rubbing and polishing complete : Dark shade using ordinary cement.**
- 1.1 Materials & workmanship :**
- 1.1 The relevant specifications of item No 14.25 (A) shall be followed except that that the cheered tiles 28 mm thick of dark shade using ordinary cement shall be used in trends of stair , staircases etc.
- 2.0 Mode of Measurement & Payment**
- 2.1 The relevant specification of item No. 14.25(A) shall be followed.
- 2.2 The rate shall be for a unit of one sq. metre.
- 14.29 White glazed tiles 6 mm thick in flooring treads of steps and landing laid on a bed of 12 mm thick cement mortar 1:3 (1 cement : 3 coarse sand) finished with flush pointing in white cement.**



**1.0 Materials :** Water shall conform to m -1 cement mortar shall conform to M-11 white glazed tiles shall conform to M-55.

**2.0 Workmanship:**

**2.1 Bedding**

2.1.1 The sub-grade shall be cleaned, wetted and mopped. The bedding shall then be laid evenly over the surface tamped and corrected to desired level and allowed to garden enough to offer a rigid cushion to tiles and to enable the mason to place wooden planks across and squat on it.

2.1.2 The white glazed tiles shall be laid on cement mortar bedding of 12 mm thick in C.M. 1 :3 . The mortar shall have sufficient plasticity for laying and there shall be no hard lumps that would interfere with the evenness of bedding the base shall be cleared with well wetted. The mortar shall then be spread in thickness not less than 10 mm at any place and average 12 mm thickness. The proportion of the cement mortar shall be as specified in the item.

**2.2 Fixing tiles :**

2.2.1 The tiles before laying shall be soaked in water for atleast two hours Neat Gracie cement grout at 3.3 Kg/Cement /Sq. mt. Of honey like consistency shall be separated over the mortar bedding as directed. The edges of the tiles be smeared with neat cement slurry. The tiles shall be well pressed and gently tapped with a wooden mallet till they are properly bedded and in level with the adjoining tiles. There shall be no hollows in bed or joints. The joints between the tiles shall be as thin as possible in straight line or as per pattern.

2.2.2 The tiles shall not have staggered joints. The joints shall be true to centre line both ways. The Nehni trap coming in the flooring shall be so positioned that its grating shall replace only one tile as far as possible. Where full size tiles cannot be fixed, they shall be cut (swan0 to be required size and the edges rubbed smooth to ensure straight and true joints. The joints shall be filled with grey cement grout with wire brush or trowel to a depth of 5 mm. and loose material removed. White cement shall be used for pointing the joints., After fixing the tile finally in an even the flooring shall be kept wet and allowed to nature undisturbed for 7 days.

**2.3 Cleaning :**

2.3.1 The surplus cement grout that may have come out of the joints shall be cleared off before it sets. Once the floor has set, it shall be carefully washed, cleared by dilute acid and dried. Proper precaution and measures shall be taken to ensure that the tiles are not damaged in any way till the completion of the construction.

**3.0 Mode of measurement & payment**

3.1 The work done shall be measured in sq. mt. For visible area of work done, The length and width of the flooring shall be measured not between the faces of skirting or dedos or plastered face of wall as the case may be. The paving under dedo or skirting shall not be measured. No deduction shall be made not extra paid for any opening in the floor of area upto 0.1 sq. mt. Nothing extra shall be paid for laying the floors at different levels in the same rooms.

3.2 The rate shall be for a unit of one sq. metre.

**14.32. White glazed tiles 5 mm. thick in skirting, risers of steps and dedo on 10 mm. thick cement plaster 1:3 (1 cement : 3 coarse sand) and jointed with white cement slurry.**

**1.0 Materials :**

Water shall conform to M-1. Cement mortar shall conform to M-11. White glazed tiles shall conform to M-55.

**2.0 Workmanship :**

**2.1 Preparation of surface :** In case of brick masonry wall, the joints shall be raked out to a depth of atleast 15 mm. while the masonry is being laid. In case of concrete wall, the surface shall be chiselled and roughened with wire brushes. The surface shall be cleaned and wetted thoroughly before commencing the laying work.

**2.2 Laying :**

**2.2.1** The wall surface shall be covered 10 mm. thick plaster of cement mortar 1:3 mix and allowed to harden. The plaster shall be roughened with wire brushes both way. The back of tiles shall be floated with gray cement slurry and edges with white cement slurry set in bedding mortar. The tiles shall be gently tapped in position one after the other keeping the joints as this as possible. Top f skirting or dado shall be truly horizontal and the joints vertical or as per required pattern.

**2.2.2** Risers of steps, skirting and dado shall rest on top of treads or flooring. Where full size tiles cannot be fixed, they shall be cut to the required size and the edges be smoothed. surface shall be washed clean.

**2.2.3** The joints shall be cleaned and flush pointed with white cement. The surface shall be kept wet for seven days. After curing the surface shall be washed clean.

**3.0 Mode of measurement & payment :**

**3.1** The rate shall include the cost of all materials and labour required for various operations described above. Risers of steps, skirting and dado shall be measured in square meters. Length and height shall be measured along the finished face of the skirting or dado including curves, where special such as covers, internal and external angles, etc. used. The length and height shall be measured correct to the centimeter except in cast of riser and skirting where height shall be measured correct to 3 mm.

**3.2** The rate shall be for a unit of one sq. meter.

**14.34 *Providing and fixing 50 mm. internal or external angles of white glazed tiles***

**1.0 Materials :**

Water shall conform to M-1. Cement shall conform to M-11. Glazed tiles shall conform to M-55.

**2.0 Workmanship :**

**2.1** The relevant specifications of item no. 14.32 shall be followed except that the internal or external angles of angles tiles shall be of thickness not less than the tiles with which they are used. The fixing shall be done as per directions.

**3.0 Mode of measurement & payment :**

**3.1** Rate shall be including the cost of materials and labour involved in all the operations described above. Internal or external angles of glazed tiles shall be measured in running meters correct up to a centimeter, length being measured on the exposed face on the special at its center line. No extra payment shall be made for corner places at angles junctions of cover beads and cornice for using cut length of special.

**3.2** The rate shall be for a unit of one running meter.

**14.36 *(A) Providing and laying marble stone slab flooring over 20 mm. (Average) base of cement mortar 1:6 (1 cement: 6 coarse sand) or L.M. 1:1.5 laid and jointed with gray cement slurry including rubbing and polishing complete: Marble slab 25 mm. thick.***

**1.0 Materials :**

Water shall conform to M-1. Lime mortar shall conform to M-10. Cement mortar shall conform to M-11. Marble stone slab 25 mm. thick shall conform to M-51.

## **2.0 Materials :**

**2.1 Dressing of slab :** Every stone shall be cut to required size and fine chisel dressed to give a smooth and even surface on all sides to the full depth. A straight edge laid along the sides of the stone shall be fully in contact with it. Chisel dressing shall also be done on top surface to remove any waviness. The sides and top surface to marble slabs shall be machine rubbed or table rubbed with bourse sand before using. All angles and edges of slabs shall be true square and free from chippings.

**2.2** The thickness of stone shall be 25 mm. The allowable tolerance shall be 2 mm. allowable. The tolerance shall be 15 mm. in length and breadth.

**2.3 Bedding :** Bedding of marble slabs shall be lime mortar 1:1.5 (1 Lime putty : 1.5 coarse sand) or cement mortar 1:6 (1 cement : 6 coarse sand) of average thickness 20 mm. thick as given in description of item. Minimum thickness at any place shall not be less than 10 mm.

**2.4 Laying :** The surface of sub grade shall be cleared wetted and mopped. Mortar of specified mix and thickness shall then be spread on an area sufficient to receive one marble slab, The slab shall be washed clean before laying. It shall be laid on top pressed and tapped gently to bring it in level with other slabs. It shall then be lifted and laid a side. The top surface of the mortar shall then be corrected by adding fresh mortar at hollows, or depressions. The mortar shall then be allowed to harden it over this surface cement slurry of honey like consistency at 4.4 Kg. Of cement per sq. meter. The edges of slabs already paved shall be buttered with gray cement. The slab shall then be gently placed in position and tapped with wooden mallet till it is properly bedded in level with and close to the adjoining slab. The joints shall be as fine as possible : Surplus cement on the surface of the slabs shall be removed. The slab fixed in the floor adjoining the walls shall enter not less 10 mm. under the plaster skirting or dado. The junction between the walls and floors shall be finished neatly. The finished surface shall be true to level and slopes as directed.

**2.5 Curing :** The floor shall be cured for minimum period of seven days.

**2.6 Polishing and finishing:** Unevenness at the meeting edges of slab shall be removed by fine chiseling. Finishing etc. shall be done as per relevant specifications of item no. 14.21 (A) of terrazzo tiles flooring except that cement slurry with/ or without pigments shall not be applied on the surface before each polishing.

## **3.0 Mode measurements & payment :**

**3.1** Marble stone flooring with various kinds of marble shall be measured in sq. meter. The length and breadth shall be measured between the finished face of skirting or dado or wall plaster. No deduction shall be made not extra shall be paid for any openings in the floor or area upto 0.05 sq. mt. Nothing extra shall be paid for laying stone at different levels in the same room. Treads and steps of stairs paved with marble stone slabs shall also be measured under flooring.

**3.2** The rate shall be for a unit of one sq. meter.

**14.43. (A) Kota stone slab (Polished, Green colour) flooring over 20 mm. (average) thick base of cement mortar 1:6 (1 cement : 6 coarse sand) or lime mortar 1:1.5 laid over and joined with gray cement slurry including rubbing and polishing complete 25 mm. thick.**

## **1.0 Materials :**

**1.1** Water shall conform M-1. Lime mortar shall conform to M-10. Cement mortar shall conform to M-11 polished kota stone shall conform to M-49.

## **2.0 Workmanship :**

- 2.1** Each slab shall be cut to the required size and shape and fine chisel dressed at all the edges. The sides thus dressed shall have a full contact if a straight edge is laid along. The sides shall be table rubbed with coarse sand before paving. All angles and edges of the slabs shall be true square and free from chippings and giving plain surface. The thickness shall be 25 mm. (Average) as specified in the item but not less than 20 mm. at any place of the slab.
- 2.2** Bedding for the kota stone slabs shall be cement mortar 1:6 (1 cement : 6 coarse sand) or L.M. 1:1.5 of average thickness 20 mm. as given in the description of the item. Sub grade shall be cleaned, wetted and mopped. Mortar of the specified mix and thickness shall be then be spread on an area sufficient to receive one kota stone slab. The slab shall be washed clean before laying. It shall be laid on top pressed, tapped gently to bring it in level with the other slabs. It shall be lifted and laid a side. Top surface of the mortar shall then be corrected by adding fresh mortar at hollows or depressions. The mortar shall then be allowed to harden bit. Over this surface, cement slurry of honey like consistency shall be applied. The slab shall then be gently place in position and tapped with wooden mallet till it is properly pedded in level with and close to the adjoining slab. The joint shall be as fine as possible. The slabs fixed in the floor adjoining the wall shall enter not less then 10 mm. under the plaster skirting or dado. The junction between the wall floor shall be finished neatly. The finished surface shall be true to levels and slopes as directed.
- 2.3** The floor shall be kept wet for a minimum period of 7 days. So that bedding and joints set properly.
- 2.4** Polishing shall be normally commenced after 14 days of laying the stone slab. First polishing shall be done with ear corundum stones of 120 grade grit fitted in the heavy machine and then second polishing shall be done with carborundum stone of 220 of 350 grade grit fitted in heavy machine. Water shall be properly used during polishing. The stone shall then be washed clean with water. When directed by the Engineer-in-charge wax polish of approved quality shall be applied on the surface with the help of soft cloth over a clean and dry surface. Then the polish machine fitted with bobs shall be run over it.
- 2.5** The holes required for Nahni traps, pipes any other fittings shall be made without any extra cost.
- 3.0 Mode of measurements & payment :**
- 3.1** The rate shall include the cost of all materials and labour involved in all the operations described above. The Kota stone flooring shall be measured in square meters correct to two places of decimal, length and breadth shall be measured correct to a centimeter and between the finished face of skirting dado or wall plaster and no deduction shall be made nor extra paid for any opening in floor of area upto 0.1 sq. mt.
- 3.2** The rate shall be for a unit of one sq. metre.
- 14.43 (B) Kota stone slab flooring over 20 mm. (average) thick base of cement mortar 1:6 (1 cement: 6 coarse sand) L.M. or 1:1.5 laid over and jointed with gray cement slurry including and polishing complete 30 mm. thick.**
- 1.0 Materials & workmanship :**
- 1.1** The relevant specifications of item no. 14.43(A) shall be followed except that the thickness of stone shall be 30 mm.
- 2.0 Mode of measurement & payment :**
- 2.1** The relevant specifications of item no. 14.43(A) shall be followed.
- 2.2** The rate shall be for a unit of one sq. metre.

**14.44.** *The kota stone slab 25 mm. thick in riser of steps, dado and pillars laid on 10 mm. thick cement mortar 1:3 (1 cement : 3 coarse sand) jointed with gray cement slurry including rubbing and polishing etc. complete.*

**1.0** **Materials :** Water shall conform to M-1. Cement mortar shall conform to M-11. Kota stone slab 25 mm. thick shall conform to M-49.

**2.0** **Workmanship :**

**2.1** The relevant specifications of item no. 14.43(A) shall be followed except shall that the kota stone shall be fixed for risers of steps, skirting or dado in C.M. 1:3 and the polishing shall be manually instead of machine polishing.

**3.0** **Mode of measurement & payment :**

**3.1** The risers of steps, skirting or dado shall be measured in sq. metre. Length shall be measured along the finished faces of risers, skirting or dado. Height shall be measured from finished level of treads or floor to top. Lining of pillar shall be measured under this item.

**3.2** The rate shall be for a unit of 1 sq. metre.

**14.46.** *(A) Rough chiselled dressed (kota stone green) stone flooring over 20 mm. thick base of cement mortar 1:5 (1 cement : 5 coarse sand) or L.M. 1:1.5 including pointing with cement mortar 1:2 (1 cement : 2 coarse sand) etc. complete. 25 mm. thick*

**1.0** **Materials :** Water shall conform to M-1 line mortar shall conform to M-10 cement mortar shall conform to M-11 rough chiselled dressed stone shall conform to M-48.

**2.0** **Workmanship :**

**2.1** The relevant specifications of item no. 14.43(A) shall be followed except that the rough chiselled dressed stone of 25 mm. thickness of approved quality are to be fixed on cement mortar bedding in C.M. 1:5 or L.M. 1:1.5 of 25 mm. (average) thickness.

**2.2** **Dressing of stone slab :** Every stone shall be cut to the required size and shape and rough chiselled dressed stone on top, if required so that the dressed surface shall not be more than 6 mm. from straight edge placed on it the sides shall also be chiselled dressed to a minimum depth of 20 mm. so that the dressed edge shall at no place be more than 30 mm. from straight edge butted against it. Beyond this depth the sides may be dressed slightly splayed so as to form an inverted "V" shape joint with adjoining slab. The surface shall be reasonable true and plain and all the angles & edges shall be square and free from chippings where the stone slabs are to be used for nosing, exposed edge shall be rough chiselled dressed to full depth and cut to the uniform thickness.

**2.3** The thickness of the stone slab shall be 25 mm with permissible tolerance of + or - 2 mm.

**2.4** **Laying :** The surface of the sub-grade concrete shall be cleaned, wetted and mopped. The bedding of specified mortar mix shall be spread under each slab shall be washed clean before laying. It shall be then laid-on top dressed so that all hollows underneath filled up and surplus mortar works up through joints. The top shall be tapped and brought level to the adjoining slab. The thickness of joints shall not exceed 5 mm. Subsequent slabs shall be laid in same manner.

**2.5** **Curing & Finishing :** Any surplus mortar on the surface of slab shall be cleaned off and joints finished lush. The joints shall be racked out uniformly to a minimum depth of 12 mm. when the mortar is still green, the slabs which are fixed in the floors adjoining the wall shall be not less than 12 mm under the plaster, skirting and dado. The junctions between wall plasters and floors shall be finished neatly and without waviness. The pointing shall be done with C:M

1:2. The pointing shall be cured for minimum period of seven days. The finished floor shall not sound hollow when tapped with wooden mallet and the finished surface shall be true to level and slopes as directed.

**3.0 Mode of measurement & payment :**

**3.1** The relevant specification of item No. 14.43(A) shall be followed.

**3.2** The rate shall be for a unit of one sq. metre.

**14.46. (B) *Rough chisel dressed (Kota stone green) stone flooring over 20 mm. thick base of cement mortar 1:5 (1 cement : 5 coarse sand) or Lime mortar 1:1.5 including pointing with cement 1:2 (1 cement : 2 stone dust) etc. complete 40 mm. thick.***

**1.0 Materials & workmanship :**

**1.1** The relevant specifications of item no. 14.46(A) shall be followed except that the thickness of stone slab shall be 40 mm. thick.

**2.0 Mode of measurements & payment :**

**2.1** The relevant specifications item no. 14.46(A) shall be followed.

**2.2** The rate shall be for a unit of one sq. metre.

**14.71 (A) *Cement concrete flooring for I.P.S. 1:2:4 (for Indian Patent Stones) (1 cement: 2 coarse sand: 4 graded stone aggregate 20 mm. nominal size) lain in layer finished with a floating coat of net cement 40 mm. thick.***

**1.0 Materials**

**1.1** Water shall conform to M-1. Cement shall conform to M-3. Sand shall conform to M-6. Stone aggregate 20 mm. nominal size shall conform to M-12. Cement concrete 1:2:4 proportion measured by volume shall conform to relevant specification or ordinary grade 1:2:4 concrete.

**2.0 Workmanship :**

**2.1** The cement concrete flooring of 40 mm. thick (average) is to be laid as per the site condition. The concrete shall be mixed in a mechanical mixer at the work. Hand mixer may however be allowed for smaller quantities of work and in case of failure of machines or as permitted by the engineer-in-charge. It shall be carried out on a water tight platform and care shall be taken to ensure that mixing is continued until the mass is uniform in colour and consistency. However in such cases 10% more cement than otherwise required shall have to be used without any cost. The mechanical mixing shall be done for a period of  $\frac{1}{2}$  to 2 minutes. The quantity of water shall be thus sufficient to produce a dense concrete required workability for the purpose. Flooring of specified thickness shall be laid in accordance with approved pattern or as directed. Finishing operation shall start shortly after the cessation of beating and shall be spread over a period of one to six hours depending upon the temperature and atmospheric conditions. The surface shall be left for some time till moisture disappears from it. Fresh quantity of cement shall be mixed with water to form a thick slurry and spread over the surface while the concrete is still green. Use of dry cement or cement and sand mixture sprinkled on this surface to stiffen the concrete or absorb excessive moisture shall not be permitted. The cement slurry shall then be properly paste twice by means of iron flats, once, when the slurry is applied and the second time when cement starts setting and finished smooth. The surface shall be marked with string or B.R.C. fabric jali to make the surface non slippery as and when directed. The junction of floors with wall plaster dado or skirting shall be rounded where so required upto 25 mm. radius. Flooring in lavatories and bath rooms shall be laid after fixing of water closet and squatting pans and floor traps, which shall be plugged while laying the floors and opened after the floors, are completed.



Any damage, done to water supply sanitary fittings during the execution of work shall be made good.

2.2 After the final set, the concrete shall be kept continuously wet, if required ponding for a period of not less than 7 days from the date of placement.

2.3 The form work shall be provided if necessary as directed by the engineer in charge. Concreting shall be done as per alternate bay method with necessary centering wither by mastic or cement mortar as directed.

**3.0 Mode of measurement & payment :**

3.1 The rate shall include the cost of all material and labour involved in all the operations described above. No deduction shall be made or extra paid for any opening upto 0.1 sq. metre in area in the floor, nothing extra shall be paid for laying the floor at different levels in the same room or the court yard.

3.2 The rate shall be for unit of one sq. metre.

**14.71. (B) Cement concrete flooring (Indian Pattern Stone) 1:2:4 (1 cement : 2 coarse sand : 4 graded stone aggregate 20 mm. nominal size) laid in one layer finished with floating coat of neat cement, 50 mm. thick.**

**1.0 Mode of measurement & payment :**

1.1 The relevant specifications of item no. 14.71 (A) shall be followed except that the thickness of concrete flooring shall be 50 mm.

**2.0 Mode measurements & payment :**

2.1 The relevant specifications of item no. 14.71(A) shall be followed.

2.2 The rate shall be for a unit of one sq. metre.

**14.74. Cement concrete pavement (25 mm. to 50 mm. thick) with 1:2:4 (1 cement : 2 coarse sand : 4 stone aggregate 20 mm. nominal size) including finishing with a floating coat neat cement complete.**

**1.0 Materials & Workmanship :**

1.1 The relevant specifications of item no. 14.71(A) shall be followed except that the thickness of concrete flooring vary from 25 mm. to 50 mm.

**2.0 Mode of measurements & payment :**

2.1 The relevant specifications of item no. 14.71 (A) shall be followed except that the thickness shall be measured correct upto 1 mm. flooring laid in borders, margins and treads of steps, shall be measured under item in flooring in respective width.

2.2 The rate shall be for a unit of one cubic metre.

**14.81. (C) 20 mm. thick precast concrete tile with aggregate of size upto 6 mm. laid in floors, treads of steps and landings on 20 mm. thick bed of cement mortar 1:6 (1 cement : 6 coarse sand) or L.M. 1:1.5 jointed with neat cement slurry with pigment to match the shade of the tiles complete with precast tiles of Dark shades using ordinary cement.**

**1.0 Materials :** Water shall conform to M-1. Cement shall conform to M-3. Sand shall conform to M-6. Lime mortar 1:1.5 shall conform to M-10. Cement mortar shall conform to M-11. Tile shall conform to M-47 (A).

Cement concrete tiles shall conform to I.S. 1237-1959 and pigment to admixed with mortar or for grouting shall conform to I.S. 2114-1962.

**2.0 Workmanship :**

2.1 The tiles shall be laid on the sub-grade of concrete of the R.C.C. slab. Bedding shall be in lime mortar 1:1.5 or cement mortar (1:6), The amount of water added shall be minimum required for sufficient plasticity and workability in C.M. or lime mortar where the ingredients shall be thoroughly mixed dry, hard lumps removed and water added to give a good workability.

2.2 The base shall be cleaned of all dust, dirt and scum and properly wetted without allowing water pools. For bedding of cement mortar the mortar shall

be then spread evenly over the base of two rows of tiles and three to five metres in length. The top shall be kept rough so that cement slurry can be absorbed. The thickness of the bedding shall be not less than 10 mm. at any place. The laying of tiles shall be commenced with neat cement slurry of honey – like consistency and shall be spread over the mortar bed over an area sufficient to receive about 20 tiles. The tiles shall then be fixed in this grout one after the other, each tile being gently tapped and properly bedded in line and level with the adjoining tiles. The joints shall be as narrow as possible and normally shall not exceed 1.5 mm. After the days work the excess cement slurry on top shall be cleaned as also the joints with a broomstick and washed before the slurry sets hard. Next day the joints shall be filled with the cement grout of the same shade as the matrix of the tiles. Tiles, which are fixed in the floor adjoining the wall, shall go a minimum of 10 mm. under the wall plaster, skirting or dado. For the purpose, plaster etc. may be left unfinished by about 50 mm. above the proposed finished level of the floor. The unfinished strip shall be plastered after laying the floor tiles. Where full the cannot be used, tile shall be cut to the size to be used.

2.3 The flooring shall be cured for 7 days.

**3.0 Mode of measurements & payment :**

3.1 The rate shall include the cost of all materials and labour involved in all the operations described above.

3.2 The rate shall be for a unit of one sq. metre.

**14.86. Chequered precast concrete tiles 22 mm. thick with aggregate of sizes upto 6 mm. in floors, treads of steps and landings on 20 mm. thick bed of C.M. 1:6 (1 cement: 6 sand) or like mortar 1:1.5 (1 Lime putty, 1.5 coarse sand) jointed with neat cement slurry with pigment to match the shade of tiles.**

**1.0 Materials :**

1.1 The relevant specifications of item no. 14.25 (A) shall be followed.

**2.0 Workmanship :**

2.1 The relevant specifications of item no. 14.21 (A) shall be followed except that chequered precast cement concrete tiles 22 mm. thick shall be used in floors, treads of steps and landings on average 20 mm. thick bed of C.M. 1: or L.M. 1:1.5.

**3.0 Mode of measurement & payment :**

3.1 The relevant specifications of item no. 14.21 (A) shall be followed.

3.2 The rate shall be for a unit of one sq. metre.

**14.87. Extra for rubbing and polishing the precast cement concrete tiles in flooring, skirting or dado.**

**1.0 workmanship :**

1.1 Grinding and rubbing shall normally be commenced after 14 days of laying the tiles, except for skirting or small areas; machine shall be used for the purpose.

1.2 First grinding shall be done with carborundum stones of 48 to 60 grade grit fitted in machine. Water shall be properly used during grinding. When the chips show up and the floor has been uniformly rubbed, it shall be cleaned with water baring all pinholes. It shall then be covered with a thin coat of grey or white cement mixed with or without pigments to match the colour of the topping of the tiles. Pin holes if any shall thus be filled. This grout shall be kept moist for sufficient period as directed. Thereafter, second grinding shall be started with carborundum of 120 grit. Grouting and curing shall be followed again. Final grinding shall be done when other works are finished. The machine shall be fitted with carborundum of grit 220 to 350 using water



in abundance. The floor shall then be washed clean with water. Oxalic acid powder shall then be dusted as needed on the surface and the surface rubbed with machine fitted with hessain bobs or rubbed hard with pad of woolen rags. The floor shall then be washed cleaned and dried with a soft cloth of linen. The finished floor shall not sound hollow when tapped with a mallet.

- 1.3 If any tile is disturbed or damaged it shall be refitted or replaced properly jointed and polished.
- 1.4 For skirting dado or small areas where it is not possible to do machine polishing all the above operations are to be done manually.
- 2.0 **Mode of measurements & payment :**
- 2.1 The rate shall include the cost of all materials and labour involved in all the operations as described above :
- 2.2 The rate shall be for a unit one sq. metre.
- 14.90. ***Providing and laying brick on edge flooring laid dry, grouted with C.M. 1:6 (1 cement: 6 coarse sand) including finishing the joints flush, curing etc. complete.***
- 1.0 **Materials:** Water shall conform to M-1. Cement mortar shall conform to M-11. Brunt bricks shall conform to M-15.
- 2.0 **Workmanship :**
- 2.1 The flooring shall be laid in concrete sub-grade where so provided. The slope in the floor shall be provided in the sub-grade. Where sub-grade is not provided, the earth below shall properly stopped, watered, rammed and consolidated. Before laying the flooring it shall be moistured. Plinth masonry offsets shall be depressed so as to allow the sub-grade concrete to rest on it.
- 2.2 **Laying:** The brick shall be lain in plain, diagonal horring bond, or other pattern as directed. The brick shall be dry laid properly and set home by gentle tapping. On completion of the portion of flooring, the vertical joints shall be grouted with C.M. 1:6 and all joints shall be finished flush. The joints shall be as fine as possible and not exceeding 5 mm. These points shall be filled with cement mortar 1:6
- 2.3 **Curing:** The brick paving shall be cured for 7 days.
- 3.0 **Mode of measurements & payment :**
- 3.1 The length and breadth shall be measured correct to a centimeter between skirting dado or wall plaster. No deductions shall be made nor extra paid for any opening upto 0.1 sq. mt. In area in the floor. Nothings extra shall be paid for laying the floors at different levels in the same room or courtyard.
- 3.2 The rate shall be for a unit of one sq. metre.

## SECTION – 15

### DETAILED SPECIFICATIONS OF ITEMS AS PER ‘SCHEDULE OF RATES’

- 15.1 **Providing corrugated G.I. sheets roofing fixed with galvanized iron ‘J’ or ‘L’ hook bolts, and nuts 8 mm. dia with bitumen and G.I. limpet washers filled with white lead complete excluding the cost of purlines, rafters and trusses. (1) 0.8 mm. thick sheet.**
- 1.0 **Materials:** Corrugated G.I. sheets shall conform to M-24.
- 2.0 **Workmanship :**
- 2.1 Spacing of pulines: One purlin shall be provided at the ridge and one at the eaves. The spacing of other purlines for 0.8 mm. thick G.I. sheet not exceed 1.80 metres. The purlin shall coincide with the centre line of the end lap. The ridge purlin shall be places in such a way that the ridges can be fixed properly.

The portion overhanding the wall support shall not be more than one fourth of the spacing of purlins.

**2.2** The top surface of the purlins shall be painted before the sheets are fixed over them. Embedded portions of purlins shall be finished with two coats of coat-tar.

**2.3 Laying of Sheets :**

**2.3.1** The sheets shall be laid in purlins to a true plane with the line of corrugations truly parallel or normal to the sides of area to be covered. The sheets shall not generally be built into gable parapets. They shall be bent up along their side edges close to the wall, and the junction shall be protected by suitable flushing or by projecting drip course.

**2.3.2** The laps at end shall be provided 150 mm. minimum for roof slopes 1 in 2 (1 vertical: 2 horizontal) and steeper but 200 mm. shall be provided for flatter slopes than those shall above. The side lap shall be provided two ridges of corrugations at each side.

**2.3.3** The sheets shall be cut to the dimensions of the shape of the roof either along their lengths or their width or in slant across the line of corrugations at hips and valleys. The sheets shall be cut carefully with a straight edge and chisel to give a straight finish. The sheets shall be laid such that the laps are turned away from the usual direction of local heavy rain.

**2.3.4 Fixing of Sheets :**

**2.3.4.1** Sheets shall be fixed to the purlins or other roof members such as hips of valley rafter etc. with 'J' or 'L' galvanized hook bolts, and galvanized nuts 8 mm. dia, with bitumen impet washers and G.I. washers. Limpet washers with white lead shall be used. Length of hook bolt shall be varried to suit the site requirement. Bolts shall be sufficiently long so that after fixing the project above the top of their nuts by not less than 12 mm. the grip of 'J' or 'L' hook bolts on the side of purlins shall not be less than 25 mm. There shall be minimum of three hooks bolts places at the ridge of corrugations in each sheets in every purlin, and their spacing shall not exceed 300 mm. coach screw shall not be used for fixing the sheets to purlins, where the slopes of roof are not less than  $2\frac{1}{2}$  horizontal). (1 vertical:  $2\frac{1}{2}$  horizontal). Sheets shall be

jointed together at the side laps by galvanized iron bolts and nuts 25 mm. x 6 mm. size, each bolt with a bitumen and G.I. limpet washer filled with white lead. Where the overlaps at the sides extend to two corrugations these bolts shall be places zigzag over the two over lapping corrugations, so that the end of the overlapping sheets are drawn tightly towards each other. The spacing of same bolts shall not exceed 600 mm. along each of the staggered rows.

**2.3.5** Holes for all bolts shall be drilled and not punched in the ridges of the corrugations from the under side, while the sheets are on the ground. The holes in the sheets shall be atleast 50 mm. from the edge. Sheets drilled wrongly shall be rejected. The holes in the washers shall be of the exact diameter of hook, bolts or the scam bolts. The nuts shall be tightened from above to give a leak proof roof.

**2.3.6** The roof when complete shall be trues to lines and slopes and shall be lead-proof.

**3.0 Mode of measurements & payment :**

**3.1** The measurements of the C.G.I. sheet roof shall be taken for finished work in superficial area in general plane (not girthed on the roof). The laps between

the C.G.I. sheets both at their ends and along the side edges shall not be measured. The overlaps of C.G.I. sheets over the valley piece underlap under the ridge, hip and flashing piece shall be included in the measurements.

**3.2** No deductions in measurements shall be made for openings for chimney stacks, sky light etc., of area upto 0.40 sq. mt. Nor extra be paid for extra labour in cutting and for wastage etc., in forming such openings.

**3.3** The rate of roof shall include the cost of all materials and labour involved in all operations described above. The rate also includes the cost of provision, erection and removal of the scaffolding, benching, ladders, templates and tools required for the proper erection and completion of the work. The rate includes the cost of purlines, rafters and trusses.

**3.4** The rate shall be for a unit of one sq. metre.

**15.7** *Providing ridges or hips 600 mm. overall in plain G.I. sheets fixed with G.I. 'J' or 'L' hooks bolts and nuts 8 mm. dia G.I. limpet and bitumen washer etc, complete 0.80 mm. thick sheet.*

**1.0** **Materials:** The G.I. valley gutters and ridges shall conform M-23 A.

**2.0** **Workmanship :**

**2.1** The relevant specifications of item no. 15.1 shall be followed except that the work shall be carried out for ridges or hips. The overlaps for ridges and hips. The overlips for ridges and hips or either side over the C.G.I. sheets and legs shall be minimum 225 mm. width of the ridges and hips shall be as described in the item.

**2.2** Ridges shall be fixed to the purlins with same 8 mm. dia. G.I. hook bolts and nuts and bitumen and G.I. limpet washers, which fix the sheets for the purlin. Hips shall be fixed to the roof members with the same 8 mm. dia. G.I. hook bolts and nuts and bitumen and G.I. limpet washers which fixed the sheets. Atleast one of the fixing bolts shall pass through the end laps of the ridges and hips on other sides. If this is not possible, extra hook bolt shall be provided. End laps of ridges and hips shall be jointed together by galvanized from seam bolts and G.I. washers. There shall be atleast two such bolts in each end lap.

**2.3** Ridges and hips shall fit in squarely in the sheets.

**3.0** **Mode of measurements & payment :**

**3.1** The measurement of ridges or hips shall be taken for finished work in length along their centre lines.

**3.2** No laps shall be measured.

**3.3** The payment for ridges and hips be made in a similar way as in case of C.G.I sheet roofing.

**3.4** The rate shall be for a unit of one running metre.

**15.8** *Providing valleys 900 mm. overall in plain 1.6 mm. thick G.I. sheet Class – 3 fixed with 'J' or 'L' hook bolts and nuts galvanized from 'J' or 'L' hook bolts and bitumen washers complete.*

**1.0** **Materials :**

**1.1** The G.I. valleys 900 mm. overall in galvanized plain sheet of 1.6 mm. thickness shall be of class-3. The valleys shall be 900 mm. wide overall and flashing shall be 380 mm. wide overall. These shall be bent to the required shape without damage to the sheets in process of bending.

**2.0** **Workmanship :**

**2.1** The relevant specifications of item no. 15.1 shall be followed except that the work shall be carried out for G.I. Valleys 900 mm. overall with G.I. sheets 1.6 mm. thickness.

**2.2** Wherever the edge of a roof sheeting or valley gutter is turned up against a wall, the edge shall be weather proofed with a flashing. Flashing shall be bent

to shape and fixed, Lap over the sheet shall be not less than 150 mm. over the roofing sheets. The end laps between the flashing sheets not be less than 225 mm.

**2.3** The flashing shall be inserted into brick work or masonry joints to a depth of 50 mm. These joints shall be filled with cement plaster (1:3). The flashing shall be well secured to the masonry whenever flashing has to be laid at a slope; it shall be stepped at each course of masonry, the step being out back at angle of not less than 30 degrees to the vertical.

**2.4** Valley shall be bent to shape and shall have end lap and projection on either side under C.G.I. sheet not less than 225 mm. Valley shall be fixed to the roof members below, with same 8 mm. dia. G.I. hook bolts and nuts and bitumen and G.I. limpet washer which fixes the sheets to these members. Atleast one of the fixing bolts shall pass through the end laps of the valley piece. If necessary extra bolts shall be provided for this purpose.

**3.0 Mode of measurements & payment :**

**3.1** The measurement for valley shall be taken for finished work in length along their centre lines.

**3.2** No laps shall be measured.

**3.3** The rate excludes the cost of boarding underneath which shall be paid separately.

**3.4** The rate of flashing includes the cost of mortar for fixing in wall and other labour and materials required for it.

**3.5** The rate shall be for a unit of one running metre.

**15.10** *Providing and fixing 150 mm. wide 450 mm. overall semicircular plain G.I. sheet class-3 Gutter with iron brackets 40 mm. x 3 mm. size bolts nuts, washers etc. including making necessary connections with rain water pipes: 0.80 mm. thick.*

**1.0 Materials :**

**1.1** These shall be of plain galvanized sheets Class-3 of 0.80 mm. thickness. The gutter shall be desired to carry the maximum discharge from the roof without flowing over and shall be constructed wherever possible with shunk channel or gutter.

**2.0 Workmanship :**

**2.1** The longitudinal edges shall be turned back to the extent of 12 mm. and beaten to form a rounded edge. The ends of the sheets at junction of pieces shall be hooked into each other and beaten flush to avoid leakage.

**2.2** The size of gutters shall be as specified in the item.

**2.3** The gutter shall be laid with a minimum fall 1 in 120 Gutter shall be true to line and slope and shall be supported on fixed M.S. Flat iron brackets bent to shape or any other suitable bracket.

**3.0 Mode of measurement & payment :**

**3.1** The measurements of gutter shall be taken for finished work in length along their centre lines. No laps shall be measured.

**3.2** The rate of gutter shall include the cost of all labour and materials specified above, including all specials such as angles, junctions, dropends or funnel shaped connecting pieces, stop ends etc. flat iron brackets and bolts and nuts required for fixing the gutter to the roof members.

**3.3** The rate shall be for a unit of one running metre.

**15.20** *(A) (I) Providing asbestos cement sheets roofing fixed with G.I. plain and bitumen washers complete excluding cost of purlins, rafters and trusses: 7 mm. thick corrugated sheet.*

**1.0 Materials :**

- 1.1 Asbestos cement sheets shall conform to M-24.
- 2.0 **Workmanship :**
- 2.1 The maximum spacing of purlines shall be 1.6 metres in case of 7 mm. thick A.C. sheets and 1.4 metres for 6 mm. thick A.C. sheets.
- 2.2 Laying and fixing of sheets: The sheets shall be laid on the purlines and other roof members as per code practice. Top bearing surfaces of all purlins and other roof members shall be in one plane so that the sheets when being fixed shall not be required to be forced down to rest on the purlins. The finished roof shall present uniform slope and the line of corrugation shall be straight and true. The sheets shall be laid with smooth side upwards. Corrugated sheets shall be laid starting at the eaves either from left to right to right to left depending upon the direction of wind before actual laying of the sheets is started. The purlins spacing and the size of sheets shall be checked to ensure that the arrangements shall provide the laps required and the specified overhang at the eaves. In case the sheets are laid from right to left, the first sheet shall be laid uncut but the remaining sheets in the bottom right row shall have the top left hand corners cut or mitred. The sheets in the second and other immediate rows shall have bottom right hand corner of the first sheet cut. All other sheet except the last sheets shall have both bottom right hand corners and top left hand corners cut. The last sheet shall have only top left hand corner cut. The last of the top row sheets shall have the bottom right hand corner cut with exception of the last sheet, which shall be left uncut. If the sheets are laid from left to right, the first sheet shall be laid and cut and the remaining procedure shall be reversed.
- 2.3 The free overhang of the sheets at the eaves shall not exceed 400 mm. in case of 7 mm. thick sheets and 300 mm., in case of 6 mm. thick sheets.
- 2.4 The mitre described above is necessary to provide snug fit. Where 4 sheets meet at a lap the length of mitre shall be 150 mm. and the width of mitre shall be equal to the width of the side lap. The cutting may be done with ordinary wood saw at site.
- 2.5 **Laps:** The sheets shall be laid with an end lap of 150 mm. minimum. In case of roof with a pitch flatter than 1 vertical to  $2\frac{1}{2}$  horizontal (Approx. 22°) or in the case of very exposed situation approximate larger laps may be provided. The sheets shall be laid with side lap of half a corrugation.
- 2.6 **Fixing Accessories:** The sheets shall be secured to the purlins and other roof members by means of 8 mm. dia. Galvanized iron bolts ('J') type hook bolts in case of angle iron purlins and 'L' type bolts in case of R.S. joints, precast concrete or timber purlins, and nuts bearing on galvanized iron washers and bitumen washers. The grip of 'J' or 'L' bolts on the side of purlins shall not be less than 25 mm. Each galvanized iron 'J' or 'L' hook bolts shall have a bitumen washer and galvanized washer and galvanized iron washer placed over the sheets before the nuts is screwed down from above. On each purlin there shall be one hook bolt on the crown adjacent to the side lap on either side. Bitumen washer shall be of approved quality. The G.I. flat washer shall be 25 mm. in diameter and 1.60 mm. thick and bitumen washer shall be 35 mm. in dia. And 1.5 mm. thick with hole to suit the required size of fixing accessory, Each nut shall be screwed lightly at first. After a dozen or more sheets are laid, the nuts shall be tightened to ensure a leak-proof joint and also nuts tightened only to extent so as to prevent damage to the sheets. The length of the 'J' bolts or crank bolts shall be 75 mm. more than the depth of purlins for single sheets fixing and 90 mm. more where two sheets overlap or where

ridges or other accessories are to be fixed. The minimum length of coach screw for timber purlins shall be 110 mm.

**2.7 Holes:** The holes for fixing the sheet shall be drilled in the centre of end lap of sheets to sir the purlins i.e. on the centre line of the purlins, if these are of timber and square head screws are used, or as close as possible to the back of purlins if 'J' or 'L' bolts are sued as with steel angles or precast concrete or timber purlins. Holes for hood bolts etc. shall be 2 mm. more than the diameter of the fixing bolts. No holes shall be nearer than 40 mm. to any edge of sheet or accessory.

**3.0 Mode of measurements & payment :**

**3.1** The relevant specifications of item 15.1 shall be followed except that the over lap of the corrugated sheets over valley gutters, roof lights, caves, filler pieces and underlay of the corrugated sheets below ridges, hips, north curves, flashing pieces, roof light sheets and barge board shall be included in the measurement.

**3.2** The rate shall be for a unit of one sq. metre.

**15.20 (A) (III) Providing asbestos cement sheets roofing fixed with G.I. plain and bitumen washers complete excluding the cost of purlins, rafters, rafters and trusses: 6 mm. thick corrugated sheets.**

**1.0 Materials & Workmanship:** The relevant specifications of item no. 15.20(A) (I) shall be followed except that the thickness of A.C. sheets be 6 mm.

**2.0 Mode of measurement & payment :**

**2.1** The relevant specifications of item no. 14.20 (A) (I) shall be followed.

**2.2** The rate shall be for unit of one sq. metre.

**15.25 (D) Providing and fixing ridges and hips in asbestos cement sheets roofing with G.I. 'J' or 'L' hook. Bolts and nuts 8 mm. dia. G.I. plain and bitumen washers complete: North light adjustable ridges.**

**1.0 Materials :**

**1.1** The ridges and hips of Asbestos cement sheets roofing shall conform to M-24.

**2.0 Workmanship :**

**2.1** The relevant specifications of item no. 14.21 (A) (I) shall be followed except that the work is to be carried out for ridges and hips in A.C. sheet roofing.

**2.2** The ridges shall be laid as per manufacture's instructions with rolls of the two wings in case of adjustable ridges, fitting closely and with a separation of serrated ridges registering correctly with the sheet underneath. The staggered lapping of two wings of adjustable ridge section and the lap between the adjacent pieces on the same wing of ridges shall be as per manufacture's instructions. The end portion of the wing of the adjustable ridges, which project beyond verges of the roof, shall be cut and trimmed off neatly.

**2.3 Hips:** In laying hip pieces, serration to suit the corrugation in the sheets below should be cut in them so that they shall be snug fit over the sheets. The wings of ridges shall be fixed to the sheet below with seam bolts and nuts 8 mm. dia. G.L. 'J' or 'L' hook bolts and bitumen and G.I. washers which fix the sheets to the purlins. In addition, in north light adjustable ridges, the roll of the two wings shall be jointed together at their crown, with 8 mm. dia. G.I. seam bolts and nuts at the rate of two numbers per pair wings. Each seam bolt shall be provided with one bitumen and a pair of G.I. washers. Where the plain wing angular or plain wing adjustable ridges are used, the gaps formed by roofing corrugation and the wings shall be filled with C.C. (1:2:4) upto a full length of the overlaps. The exposed face shall be finished perpendicular to the sheeting. Wings of hips shall be fixed to the roof members with the same 8 mm. dia. G.I. 'J' or 'L' bolts and end nut, which fix the sheets to the member. In



addition, they shall be secured to the sheet below to the sheet below with 8 mm. dia. G.I. seam bolts nuts and washers so that taken together with hook bolts, there shall be bolt on each wing at least at every fifth corrugation of the sheets below in case of corrugated and at least every second corrugation of sheets below in case of semicorrugated sheets each seam bolt shall be provided with one bitumen and pair of G.I. washers.

**3.0 Mode of measurement & payment :**

**3.1** Measurement of ridges, hips and other accessories shall be furnished work and the length shall be taken along the centre line. The lap shall not be measured. The under lap of ridges under expansion joint pieces shall be measured.

**3.2** The rate shall be for a unit of one running metre.

**15.26** *Filling cement concrete 1:2:4 (1 cement: 2 coarse sand: 4 graded stone aggregate 12.5 nominal size) in gaps of A.C. sheet corrugation and wings of ridges.*

**1.0 Materials:** Water shall conform to M-1. Cement shall conform to M-3. Coarse sand shall conform to M-6. Stone grit shall conform to M-8.

**2.0 Workmanship :**

**2.1** The relevant specifications of item no. 5.4.1 of C.C. shall be followed except that the work shall be for filling gaps of A.C. sheet corrugation and wings of ridges.

**3.0 Mode of measurements & payment :**

**3.1** The measurements of filling gaps in ridges, hips of A.C. sheet corrugation and wings or ridges shall be for finished work. The length shall be measured along the centre line.

**3.2** The rate shall be for a unit of one running metre.

**15.27** *(III) Providing and fixing asbestos cement roofing accessories with galvanized iron 'J' or 'L' hook bolts and nuts, G.I. plain and bitumen washer etc. complete: North light and ventilators curfves.*

**1.0 Materials & workmanship :**

**1.1** The relevant specifications of item no. 15.10 (I) shall be followed except that the work is carried out for accessories for asbestos cement roofing north light and ventilator curfves.

**1.2** The accessories such as north light and ventilator curves shall be laid and secured with same G.I. hook bolts to secure the sheets to the roof or with separate G.I. hook bolts to the roof members below and/or with 8 mm. dia. G.I. seam bolts, nuts and washers to the sheeting, generally as per manufacturer's written instructions.

**2.0 Mode of measurements & payment :**

**2.1** The relevant specifications of item no. 15.25 (D) shall be followed.

**2.2** The rate shall be for a unit of one running metre.

**15.29** *(I) Providing and fixing asbestos cement socketed half round eaves gutter with bolts, nuts, bitumen washer etc. and flat iron brackets 40 mm. x 3 mm. size including asbestos rope and plastic roofing compound in joints complete: 150 mm. nominal size.*

**1.0 Materials & Workmanship :**

**1.1** The relevant specifications of item no. 15.10 (I) shall be followed except that the asbestos cement socketed half round eaves gutter shall be provided. The size of gutter shall be 150 mm. nominal.

**1.2** Gutters shall be laid with a minimum fall of 1 in 120, which should increase where possible. Gutters shall be true to line and slope and shall be laid with requisite accessories such as drop ends, nozzles, angles and union slips, as directed. The size of outlet of drop ends and nozzles shall be the same as the

size of rain water pipe into which they discharge water, Gutters and their accessories shall be supported by M.S. flat/iron bracket. Where these are required to be fixed to the side of rafter they shall be fixed with 40 mm. by 3 mm. section bent to shade and fixed rigidly to the sides of the rafter with 3 nos. of 10 mm. dia. Bolts, nuts and washers. The brackets shall overlap the rafter not less than 300 mm. and connecting bolts shall be 115 mm. centres.

**1.3** Where the bracket are to be fixed with purlins, these shall consist of 40 x 3 M.S. flat iron bent to shade with one/and turned at a right angles and fixed to the purlins face with a 10 mm. bolt but and washer. The perpendicular over handling portion of 40 mm. x 3 mm. bracket shall be stiffened by another 40 x 3 mm. flat bent to right angles shade with its longer leg connected to the bracket with two numbers of 6 mm. dia. M.S. bolts, nuts and washers and its shorter legs fixed to the face of purlins with one number 10 mm. dia. Bolts, nuts and washers. The overhang of the vertical portion of the iron bracket from the face of the purlin shall not exceed 225 mm.

**1.4** Requisite slope in the gutter shall be given in the line of bracket. The brackets shall be placed at not more than 900 mm. centres.

**1.5** The gutters shall be fixed to the brackets with 2 Nos. 8 mm. dia. G.I. seam bolts and nuts, each bolt and nut being equipped with a pair of bitumen and G.I. washers. These connecting bolts shall normally be above the water line of gutter.

**1.6** Spigot and socket end of gutters of socketed half round gutter and their accessories shall be connected together at their laps with one row or 8 mm. dia. G.I. bolts and nuts, Each of the bolts and nuts shall be provided with a pair of bitumen and a pair of G.I. washers. The gap between socket and spigot shall be packed with approved plastic roofing compound and flanked on the both sides with 6.35 mm. dia. asbestos rope. The connecting G.I. bolt shall be then tightened so that the lapped joint becomes leak-proof. The outer face of packed asbestos rope shall not be further than 6 mm. from the edges of the spigot and socketed ends. Where both ends of gutters and/or their accessories to be connected together are spigot ends, they shall be laid as butt jointed with 1.5 mm. gap in between over union clips. The union clips connected to the two butt ends of the gutter or other sections with two rows. The gap between union clips and ends of gutter sections or accessories shall be packed with plastic roofing compound flanked with edges of 6.35 mm. dia. asbestos ropes as before. The whole joint shall be made leak proof tightening the bolt.

**2.0 Mode of measurement & payment :**

**2.1** The asbestos socketed half round eaves gutter shall be measured for finished work and the length shall be measured along the centre line.

**2.2** The rate of gutters shall include the cost of providing and fixing accessories such as drops ends, stop ends, nozzles and fixing union clips together with bolts, nuts and washers.

**2.3** The rate shall be for a unit of one running metre.

**15.29 (II) Providing and fixing Asbestos cement socketed half round eaves gutters with bolts, nuts, bitumen washers etc. and flat iron brackets 40 mm. x 3 mm. size including Asbestos rope and plastic compound in joints etc. complete. 300 mm. nominal size.**

**1.0 Materials & Workmanship :**

**1.1** The relevant specifications of item no. 15.29 (I) shall be followed except that the size of the Asbestos socketed eaves half round gutter shall be 300 mm. nominal size.

**2.0 Mode of measurement & payment :**



- 2.1 The relevant specifications of item no. 15.29 (I) shall be followed.
- 2.2 The rate shall be for a unit of one running metre.
- 15.51 ***Tiled roofing with Manglore pattern roof tiles including teak reepers of size 50 mm. x 25 mm.***
- 1.0 **Materials :**
- (1) Manglore pattern roof tiles shall conform to M-25
- (2) Teak wood pattern shall conform to M-29.
- 2.0 **Workmanship :**
- 2.1 **Laying:** The maximum distance between centre to centre of rafters shall be not more than 600 mm. Teak wood reepers 50 mm. x 25 mm. shall be nailed to each rafter at central distances suited to the size of the tiles by means of nail 50 mm. long. The reepers shall be well-seasoned teak wood and shall be straight places of uniform size and colour and not shorter than the length necessary to cover at least four rafters. The joints of two adjacent rows of reepers shall not come over the same rafter. At the eaves, there shall be two reepers of such thickness and shape that the uniformly of the top slope of the roof shall be preserved.
- 2.2 The work of valleys shall be executed as under :
- Galvanized iron sheet 1200 mm. wide and 1.25 mm. thick shall be used for valleys. The sheet shall extended by about 450 mm. under tiles on either side in a depth of 100 mm. at centre. The sheet shall be carried 75 mm. into the wall and set with cement mortar unless flashing is specified. The laps, if any, on the slope shall be 300 m. the sheets shall be laid over the reepers and nailed. Two reepers 50 mm. x 25 mm. each shall be fixed over the galvanized iron sheet 150 mm. away from the centre line of the valey on either side to keep the tiles and mortar from falling into the gutter of the valley.
- 2.3 **Laying:** The tiles shall be laid from the eaves towards the ridges after fitting of the reepers, the rebate of the resting fully against the reepers. The joints of the hips and ridges tiles and also those between them and the plain tiles shall be set in and well grouted with lime mortar and, the mortar surface painted and finished off with a mixture of red paint and Portland cement to preserve of colour. The finished slope of roof shall be uniform shall be uniform ridges to eaves. The eaves line shall be perfectly straight, horizontal and parallel to each other. The end over gables shall be protected by lime borders and neatly finished.
- 2.4 At the side of valleys and for 230 mm. on either side of the roof at valleys, cement plastering 12 mm. thick shall be done to prevent the rain water from the gutter leaking by the side of valleys.
- 2.5 At the eaves, wind tie shall be placed over the ends of the last tiles and secured by means of galvanized iron washers and screws 25 mm. into the rafter to prevent tiles from being blown up. Care shall be taken to put the screw in the ridges and not in the gutter of the tiles, where full tiles are not necessary, half tiles manufactured for the purpose shall be used.
- 3.0 **Mode of measurement & payment :**
- 3.1 The measurement of the roof shall be taken for finished work for superficial area flat in the plane of the roof and not girthed, Laps shall not be measured.
- 3.2 No deduction in measurements of roof shall be made for openings of area upto 0.40 sq. mt. Not shall any extra be paid for labour and wastage in forming such openings.
- 3.3 The rate includes the cost of all materials and labour including ridges, hips, eaves and battens.
- 3.4 The rate shall be for a unit of one sq. metre.

**15.75** *Providing and fixing five course water proofing treatment felt consisting of second and fourth course of blown bitumen or/and residual bitumen applied hot 1.20 kg. /sq.mt. of area for each course and first course and first course with fibre base self finished felt type 2 Grade – I, fifth and final course of stone grit 6 mm. and down size or pea sized gravel spreaded at 0.008 cum/sq.mt. including preparation of surface, excluding grading complete.*

**1.0** **Materials:** The tarfelt shall conform to M-76. The bitumen primer shall conform to I.X. 3388-1965. The bitumen shall conform to I.S. 702-1961. The grit or gravel shall conform to M-8.

**2.0** **Workmanship :**

**2.1** **Preparation of surface :**

**2.1.1** Well defined cracks other than hair cracks in the roof structure shall be cut to 'V' section cleaned and filled up flush with cement sand slurry or with bitumen conforming to I.S. 702-1961. The surface to be treated shall have a minimum slope of 1 in 120. The grading shall be carried out prior to the application of water proofing treatment by cement mortar or line surkhi mortar or as specified in description of item.

**2.1.2** The surface of room, part of parapet and gutters, drain mouths etc. over which the water proofing treatment is to be applied, shall be cleaned of all foreign matter such as fungus, moss and dust by wire brushing and dusting.

**2.1.3** Drain outlet shall be suitable placed with respect to the roof gradient to ensure rapid drainage and prevent local accumulation of water on the roof, surface masonry drain mouth, shall be widen sufficiently and rounded with cement mortar.

**2.1.4** Form cast iron drain outlets, a groove shall be cut all round to touch the treatment.

**2.1.5** When a pipe passes through a roof on which water-proofing treatment is to be laid, a cement, concrete angle filler shall be built round it and the water proofing treatment taken over the fillet.

**2.1.6** In case of parapet wall over 450 mm. in height for tucking in the water proofing treatment, a horizontal groove 75 mm. wide and 65 mm. deep at minimum height of 150 mm. above roof level shall be left in the vertical face at the time of construction, the horizontal face of the groove shall be shaped with cement mortar 1:4.

**2.1.7** In case of low parapet where the height does not exceed 450 mm. no groove shall be provided and the water proofing treatment shall be carried right over the top.

**2.1.8** In case of existing R.C.C. and stone walls cutting the chase for tacking in the water proofing treatment is not recommended.

**2.1.9** At the junction between the roof and vertical face of the parapet wall, a fillet 75 mm. in radius shall be constructed.

**2.1.10** At the drain mouths the fillet shall be suitably cut back and rounded off for each application of water proofing treatment and easy flow of water.

**2.1.11** Out let at every low dividing wall about less than 300 mm. in height shall be rounded smooth and corners rounded off for easy application of water proofing treatment.

**2.2** **Priming coat :**

**2.2.1** Bitumen primer shall conform to I.S. 3385-1965. A priming coat of bitumenous solution of low viscosity shall be applied with brush on the roof and wall surface at specified per unit area to assist adhesion of bonding materials as specified in the description of the item.

**2.2.2** Where a floating treatment of water proofing with self finished bitumen felt is required i.e. where water proofing treatment is required to be isolated from the roof structure, layer of bitumen saturated felt (underlay) shall be spread over the roof surface and tucked into the flashing grooves. To keep the underlay free from the structure no bonding materials shall be use below underly.Overlapping to the adjoining strip of underly shall be minimum 75mm at sides and 10mm at ends and shall be sealed with the same bonding materials as used for the self finished felt treatment. The underlay shall be of type-1 saturated felt conforming to I.S. 1322-1970.

**2.3 Laying of Felt :**

**2.3.1** The self-finished tarfelt shall be cut to the required lengths, brushed clean of dusting materials, laid out flat on the roof to eliminate curls and subsequent stretching. The felt shall be laid in length running at right angles to the direction of run off gradient commencing at the lowest level and working upto crest, so that the lower laps of the adjacent felt layer offer minimum obstruction to the flow of water. The felt shall not be laid in a single piece of very long lengths as it is likely to shrink 6 to 8 metres are suitable length. The roof shall be cleaned and dried before the felt treatment is begun. Each length shall be laid in position and rolled up for a distance of half it lengths. The hot bonding materials heated to correct working temperature as specified by manufacture shall be poured on to the roof across the full width of the felt as the later is steadily unrolled and pressed down. The excess of bonding materials which squeezes out at the ends shall be removed as the laying proceeds. The pouring shall be so regulated that correct weight of the bonding materials as per unit per unit area is spread uniformly over the surface. When the first half of the tarfelt has been bonded to the roof, the other half shall be rolled up and then unrolled on the hot bonding materials in the same way, Subsequent strips shall also be laid in the same manner. Each strip shall overlap the preceding one by at least 75 mm. at the longitudinal edges and 100 mm. at the ends. All overlaps shall be firmly bonded with hot bitumen. Streaks and trailing of bitumen near edges of laps shall be levelled by heating the overlaps with blow lamp and leveling down unevenness.

**2.3.2** Third layer of bonding materials in four course treatment shall be carried out in similar manner after the flashing has been complete.

**2.3.3** Water proofing treatment shall be carried out in the drain pipe or outlets by at least 100 mm. The water proofing treatment laid on the surface shall overlap the upper edge of water proofing treatment in the drain outlets by atleast 100 mm. Flashing felts shall be laid as flashing. Wherever junction of vertical horizontal surface occurs longitudinal laps shall be 100 mm. The lower layer of flashing felt shall overlap the roofing felt by 100 mm. on vertical and sloping faces. Last course of flashing should not be of stone, grit or pea sized gravel but it shall be replaced by provided two coats of bitumen solution of approved quality.

**2.3.4** The lower edge of flashing shall overlap the flat portion of the roof and the upper edge of the flashing shall be tucked into the horizontal groove 75 mm. thick wide, 65 mm. deep provided at minimum height of 150 mm. from top of the roof surface. The flashing treatment shall be firmly held in place in the groove with wooden wedges at intervals and the grooves shall be followed with cement mortar 1:4 (1 cement: 4 coarse sand) or cement concrete (1:2:4) (1 cement: 2 coarse sand: 4 graded stone aggregate 6 mm. nominal size) and surface finished smooth with the rest of wall. The cement work shall be cured for 7 days. When dry, the exposed plaster joints of grooves shall be pointed

with bitumen and two coats of bitumenous solution shall be applied on the vertical and sloping surface of flashing.

**2.3.5** After the top flashing felt layer has been laid, the penultimate layer of bonding materials shall be applied over the roofing felt and horizontal overlap, and vertical and sloping surface of flashing shall be spread uniformly over the hot bonding materials on the horizontal roof surface and pressed into it with wooden roller.

**2.3.6** The materials for surface finish shall be spread as described in the item over top layer.

**2.3.7** If ballooning occurs the defects may be rectified as under :

**2.3.8** Remove the gravel on the ballooned surface. Then cut open and squeeze out the trapped vapour by firm pressure applied by hand, seal the bitumen felt so lifted back on the surface by applying additional bitumen finally seal the cut with piece of bitumen felt with bitumen application.

### **3.0 Mode of measurement & payment :**

**3.1** The measurements for this item shall be taken as under :

(a) Water proofing of roof with bitumen shall be measured in sq. mt. Length and breadth shall be measured correct to centimeter.

(b) Measurement shall be taken for the superficial area of roofing and flashing treatment including flashing over the parapet wall low dividing walls and expansion joints and at the pipe projections etc. Overlapping and tucking into flashing groove shall not be measured.

(c) Sloping and vertical surface of water proofing treatment shall be measured under the four or five course treatment as the case may be irrespective of the fact that the final course of grit or gravel is replaced by bitumen primer.

(d) In measurements, no deduction shall be made for either openings or recesses for chimney stacks roof lights etc. for areas upto 0.40 sq. mt. nor anything extra shall be paid or extra labour and materials in forming such openings.

(e) The grading (coba bedding) shall be paid separately but cleaning of surface and treating the cracks shall not be paid separately.

(f) Cutting of horizontal grooves in parapet walls for tucking in water proofing shall not be measured or paid separately.

**3.2** The rate includes cost of all materials and labour.

**3.3** The rate shall be for a unit of one sq. metre.

**15.87** *(A) Providing and fixing on wall face C.I. rain water pipe including filling the joints spun yarn soaked in neat cement slurry and cement mortar 1:2 (1 cement: 2 fine sand) 75 mm. dia.*

**1.0** **Materials:** Water shall conform to M-1. The C.I. rain water fitting shall conform to M-68. Cement mortar shall conform to M-11.

### **2.0 Workmanship :**

**2.1** C.I. rain water pipes shall be of specified diameter and shall be in full lengths of 1.8 metres including socket ends of the pipes unless shorter lengths are required at junctions with fittings.

**2.2** **Fixing:** The pipe and fittings shall be fixed in vertical alignment unless otherwise specified and shall be secured to the walls at joints with M.S. clamps. The clamps shall be M.S. sheets 30 mm. bent to required shape and size so as to fit tightly on the socket of pipe when tightened with screw bolts. It shall be formed out of two semi-circular pieces, hinged with 6 mm. dia. M.S. pin on one side and provided flanged ends on the other side with holes to fit in the screw bolt and nut 40 mm. long. The clamps shall be provided with hook made out of 275 mm. long, 10 mm. dia. M.S. bar rivetted to the ring at the centre of one semicircular piece. The clamps shall be fixed to the walls.

The clams shall be kept above 25 mm. clear of finished face of wall so as to facilitate cleaning and painting the pipes.

- 2.3 The pipe shall be fixed vertically. The spigot of the upper pipe shall be properly fitted in the socket of the lower pipe such that there is uniform annular space for filling with the jointing materials. The annular space between the spigot and socket shall be filled with a free turns of spun yarn socked in cement slurry or blown bitumen 85/25 grade. These shall be pressed home by caulking tools. The joints shall then be filled with stiff cement mortar 1:2 (1 cement : 2 fine sand) well pressed with caulking tools and finished smooth at top at an angle of 45° sloping up. The joints shall be kept wet atleast for 67 days by typing four fonds of gunny bag to the pope and keeping it moist constantly.

**3.0 Mode of Measurements & payment :**

- 3.1 The relevant specifications of item no. 15.93 (B) of A.C. rain water pipes shall be followed except that the C.I. rain water pipe shall be fixed.

- 3.2 The rate shall be for a unit of one running metre.

**15.88 (A) Providing and fixing M.S. holder bat clamps of approved design to C.I. or S.C.I. pipes embedded and including cement concrete blocks (100 mm. x 100 mm. 100 mm. ) size in 1:2:4 (1 cement : 2 coarse sand : 4 graded stone aggregate 20 mm. nominal size) and cost of cutting holes and making good the walls etc. complete : 75 mm. dia.**

**1.0 Materials & Workmanship :**

- 1.1 The relevant specifications of item no. 15.94(B) shall be followed except that the M.S. holder bat clamps of approved design shall be for C.I. rain water pipe 75 mm. dia.

- 1.2 The bat clamps shall be fixed as directed with C.C. blocks of 100 mm. x 100 mm. x 100 mm. The relevant specification of item no. 5.4.1 shall be followed for concrete work.

**2.0 mode of measurement & payment :**

- 2.1 The bat clamp of M.S. holder suitable for 75 mm. dia. shall be measured for finished item.

- 2.2 The rate includes cost of all materials and labour etc, required for satisfactory completion of this item.

- 2.3 The rate shall be for a unit of one Number.

**15.93 (A) Providing and fixing and embedding sand C.I. rain water pipe in the mason surrounded with 12 mm. thick cement mortar of the same mix as that masonry : 75 mm. dia pipe.**

- 1.0 **Materials :** Water shall conform to M-1.Cement mortar shall conform to M-11. The C.I. pipe and fittings shall conform to M-68.

**2.0 Workmanship :**

- 2.1 The relevant specifications of item no. 15.87 (A) shall be followed except the C.I. pipe 75 mm. dia. Shall be embedded in masonry surrounded with 12 mm. thick cement mortar.

- 2.2 The pipes shall be fixed in the masonry work as it proceeds. The pipe shall be kept vertical or to the line as directed. The pipe shall have minimum surroundings of 12 mm. thick cement mortar at every portion surface. The length shall be caulked with spun yarn and cement mortar as soon as the next length of pipe is placed in position. The socket end the pipe shall be kept closed till the next length of pipe is filled and jointed any brick bats or concrete or pieces of wood falling in and chocking the pipes.

**3.0 Mode of measurements & payment :**

- 3.1 The relevant specifications of item no. 15.87 (A) shall be followed.

- 3.2 The rate shall be for a unit of one running meter.
- 15.93 (B) Providing and fixing on wall face asbestos cement rain water pipe including jointing with spun yarn soaked in bitumen and cement mortar 1:2 (1 cement : 2 coarse sand) complete 80 mm. dia.**
- 1.0 Materials :**
- 1.1 Asbestos cement pipes of 80 mm. dia. shall conform to I.S. : 1626-1960 for pipes fixed on wall face. A.C. pipe shall conform to M-74.
- 2.0 Workmanship :**
- 2.1 Asbestos cement rain water pipes and fittings shall be of the diameter, size and type specified in the item. The pipe shall be fixed in full lengths of 2 metre as far possible. All the pipes shall be fixed on wall face at locations indicated on drawings or as ordered by the Engineer-in-charge. Pipe shall be secured to face of wall below all joints by M.S. clamps with wooden gutties.
- 2.2 The spigot of the upper pipe shall be properly fitted into the socket of the lower pipe such that there is uniform annular space for fitting with the jointing materials. One third depth of annular space between the socket and the spigot shall be filled with spun yarn soaked in bitumatic jointing compound and shall be pressed home by means of a caulking too. The remaining  $\frac{2}{3}$  depth of the joints shall be filled in with stuff cement mortar 1:2 and shall be pressed with caulking tool and finished smooth at top at an angle 45° sloping up.
- 3.0 Mode of measurement & payment :**
- 3.1 The pipe shall be measured including all fitting along its length in running metre. No allowance shall be made for the portion of pipe length entering the sockets of the adjacent pipe or fittings.
- 3.2 The rate includes the cost of all materials and labour involved in all the operations including jointing.
- 3.3 The rate shall be for a unit of one running metre.
- 15.93 (C) Providing and fixing on wall face Asbestos cement rain water pipe including jointing with spun yarn soaked in bitumen and cement mortar 1:2 (1 cement : 2 coarse sand) complete : 100 mm. dia.**
- 1.0 Materials & Workmanship :**
- 1.1 The relevant specifications of item no. 15.93 (B) shall be followed except that the diameter of pipes shall be 100 mm.
- 2.0 mode of measurement & payment :**
- 2.1 The pipe shall be measured including all fittings along its length in running metre. No allowance shall be made for the portion of pipe length entered into the sockets of the adjacent pipe or fittings.
- 2.2 The rate includes the cost of all materials and labour involved in all the operations including jointing.
- 2.3 The rate shall be for a unit of one running metre.
- 15.94 Providing and fixing for A.C. pipe on wall plugs and standard holder bat clamps comprising of two semi circular halves of flat iron and cast iron base screwed on wooden plugs : 80 mm. dia.**
- 1.0 Materials & Workmanship :**
- 1.1 The bat clamps shall consist of a cast iron base with a projecting 'I' shaped lay, teeth web of which the semiconductor halves of the flat iron clamps are bolted. The base on the holder bat clamp shall be screwed on a pair of wooden plugs fixed in the wall with screw sloted driven through the holes in the base. The screws shall be not less 75 mm. long for 80 mm. diameter pipes and 100 mm. for 100 mm. diameter pipes. The plugs shall be fixed in the wall to a depth of 150 mm. in cement mortar 1:2 centrally to the holes in the base of the bat clamps and with their front face projecting to such a length from the brick



face that when the bat clamp is fixed, the outer base of its base shall be flush with the plaster face of the wall. The plugs shall be 110 mm. x 50 mm. wide at face increasing to 160 mm. x 70 mm. width at rear and shall be 70 mm. deep through out.

**2.0 Mode measurement & payment :**

**2.1** The work shall be measured on number basis of clamps prescribed with accession including cost of all materials and labour involved in all the operation including jointing etc. complete fixing in position etc. complete.

**2.2** The rate shall be for a unit of one number.

**15.94 (C) Providing and fixing for A.C. pipe on wall plugs and standard bolder bat clamps comprising of two semi circular halves of flat iron and cast iron base screwed on wooden plugs : 100 mm. dia.**

**1.0 Materials & Workmanship :**

**1.1** The relevant specifications of item no. 15.94 (B) shall be followed except that the standard holder bat clamps shall be for A.C. pipe of 100 mm. dia.

**2.0 Mode of measurement & payment :**

**2.1** The work shall be measured on number basis of clamps including cost of all materials and labour involved in all the operation including jointing, fixing in position etc. complete.

**2.2** The rate shall be for a unit of one number.

**15.95 (A) Providing and fixing on wall face asbestos cement for rain water pipe including jointing with spun yarn soaked in bitumen and cement mortar 1:2 (1 cement : 2 coarse sand) Bend of required degree – 80 mm. dia. Without door. 100 mm. without door.**

**1.0 Materials :**

**1.1** The bend of required degree and size as specified in item shall be of best quality and make as approved by the Engineer-in-charge. The fittings shall conform to I.S. 1626-1960.

**2.0 Workmanship :**

**2.1** The fitting (bends of required degree) shall be fixed as per relevant specifications of item no. 1593 (B), except that the A.C. bends of required degree shall be provided instead of pipe.

**3.0 Mode of measurements & payment :**

**3.1** The rate shall be for a unit of one member.

**15.95 (B) Providing and fixing on wall face Asbestos fittings for rain water pipe including jointing with spun yarn soaked in bitumen and cement mortar 1:2 (1 cement : 2 coarse sand) off set 50 mm. (2) 80 mm. dia. (3) 100 mm. dia.**

**1.0 Materials & Workmanship :**

**1.1** The relevant specifications of item no. 15.95 (A) shall be followed except that the off set 50 mm. of specified size of A.C. pipe shall be used instead of bends.

**2.0 Mode of measurements & payment :**

**2.1** The rate shall be for a unit of one member.

**15.95 (C) Providing and fixing on wall face Asbestos fittings for rain water pipe including jointing with spun yarn soaked in bitumen and cement mortar 1:2 (1 cement : 2 coarse sand) off set 75 mm. (2) 80 mm. dia. (3) 100 mm. dia.**

**1.0 Materials & Workmanship :**

**1.1** The relevant specifications of item no. 15.95 (A) shall be followed except that the off set 75 mm. of specified size of A.C. pipe shall be provided instead of bends.

**2.0 Mode of measurements & payment :**

**2.1** The rate shall be for a unit of one member.

**15.95** *(J) Providing and fixing on wall face Asbestos fittings for rain water pipe including jointing with spun yarn soaked in bitumen and cement mortar 1:2 (1 cement : 2 coarse sand) junction equal angle. (3) 80 mm. dia. without does (5) 100 mm. dia. without door.*

**1.0** **Materials & Workmanship :**

**1.1** The relevant specifications of item no. 15.95 (A) shall be followed except that the junction of angle of specified size of A.C. pipe shall be provided instead of bends.

**2.0** **Mode of measurements & payment :**

**2.1** The rate shall be for a unit of one member.

**15.95** *(K) Providing and fixing on wall face Asbestos fittings for rain water pipe including jointing with spun yarn soaked in bitumen and cement mortar 1:2 (1 cement : 2 coarse sand) 1 junction equal double angle. (3) 80 mm. dia. without does (5) 100 mm. dia. without door.*

**1.0** **Materials & Workmanship :**

**1.1** The relevant specifications of item no. 15.95 (A) shall be followed except that junction of double angles A.C. rain water pipe of specified size shall be provided instead of A.C. bends.

**2.0** **Mode of measurements & payment :**

**2.1** The rate shall be for a unit of one member.

**15.95** *(L) Providing and fixing on wall face Asbestos fittings for A.C. rain water pipe including jointing with spun yarn soaked in bitumen and cement mortar 1:2 (1 cement : 2 coarse sand) : Standard shoe (2) 80 mm. dia. (3) 100 mm. dia.*

**1.0** **Materials & Workmanship :**

**1.1** The relevant specifications of item no. 15.95 (A) shall be followed except that the junction of angle of specified size of A.C. pipe shall be provided instead of bends.

**2.0** **Mode of measurements & payment :**

**2.1** The rate shall be for a unit of one member.

## SECTION – 16

### DETAILED SPECIFICATIONS FOR CEILING LINING AS PER “SCHEDULE OF RATES”

**16.3** *(A) Providing and fixing wooden planks ceiling with tongued and grooved jointing and wood screws (frames work and cover fillets to be measured and paid separately) : India Teak Wood (i) 12 mm. thick (ii) 20 mm. thick (iii) 25 mm. thick.*

**1.0** **Materials :**

**1.1** The India Teak wood shall conform to M-29.

**2.0** **Workmanship :**

**2.1** **General :** The planks shall be clean sawn in the direction of the grain, cut, square and straight. Each plank shall have tongued and grooved jointing. On exposed faces, it shall planed for full face.

**2.2** The frame for supporting the ceiling may be wooden or metal and the size and the other details of frame work shall be as directed. Suspenders of M.S. angles of M.S. angles or other sections may be used for suspending the frame. Use of wooden suspenders shall be permitted. The bottom surface of the frame shall be checked and corrected to true surface and slope.

**2.3** **Fixing :** Planks of specified timber and thickness shall be used. The width of the plank shall not be more than 100 mm. upto 20 mm. thick planks and 150



mm. for planks above 20 mm. thick and length shall not exceed 3 metres. The planks shall be of uniform width except in the first and last lines of planks adjacent to the walls where remaining additional odd width shall be adjusted equally on both sides. The minimum length of planks in finished work shall be such that it will span at least two spacing of the supporting frame work except where shorter lengths are unavoidable. The planks shall be planed true on the exposed sides.

**2.4** The longitudinal edges of the planks shall be jointed with tongued and grooved type joints as described in the item.

**2.5** The outer lines of planks shall be accurately fixed parallel and close to the wall. Each subsequently plank shall be carefully jointed up. The plank shall be fixed to the frame above with two screws at each and joint of frame and one at every intermediate joint. (The screws shall not be thinner than designation 8 and of a length not less than twice the thickness of the boards.) The screws shall be counter sunk and the screws holes filled with putty or sloping out way. The unexpected face of planks shall be treated with wood preservative before the board is fixed.

**3.0 Mode of measurement & payment :**

**3.1** The supporting frame, cover fillets and suspenders shall not be included in rate ceiling.

**3.2** No deductions in measurements shall be made for opening not exceeding 0.40 sq. mt. and extra payment shall be made for forming such openings.

**3.3** Each type work in ceiling shall be measured separately.

**3.4** The rate shall be for a unit of one sq. metre.

**16.4** *Providing and fixing fibre insulation board lining with butt jointing and nails (frame work and cover fillets to be measured and paid separately. (I) 12 mm. thick (ii) 18 mm. thick. (iii) 25 mm. thick.*

**1.0 Materials :**

**1.1** The fibre insulation board of specified thickness shall conform to I.S. 3348-1965.

**2.0 Workmanship :**

**2.1 Fixing :** The work shall be carried out as per detailed drawings for panel arrangements.

**2.2** All boards are subject to slight movements due to moisture and temperature changes, and this shall be allowed for in fixing. Preferably the board shall be stored up for a atleast 24 hours before use in the same environment as the one in they are to be fixed.

**2.3 Frame of Work :** The studs and grounds for fixing the boards shall be spaced at 300 mm. to 450 mm. centres both ways, the actual spacing selected depending on the width of the cur board in the panel arrangements. All edges of the boards shall be supported. Intermediate supports shall be provided at dedo heights for pircurerails and cornices etc.

**2.4** Planked battens 40 mm. x 20 mm. shall be sued for grounds on solid walls. The batten shall be plugged to wall as described under. The batten shall be fixed on tapering plugs with 50 mm. long wood screws. The tapering plug shall be traperszoidal in shape having base 50 x 50 mm. at bottom 38 x 38 mm. at top with depth of 50 mm. Plugs shall be embedded in C.m. 1:3 and shall be placed at 450 x 500 mm. The plugs shall treated with coat tar and battens shall be treated with wood preservative before use. On uneven wall faces the battens shall be plugged and fitted with packing at the back where necessary. The frame shall be treated with wood preservative before boards are nailed on.

Nailing shall be done by nails have shank diameter of 2.5 mm. and head diameter of about 8 mm. Nails shall have length as per requirement. The nails shall be placed supports at 100 mm. to 150 mm. centre in centre and edges 75 mm. centres. Minimum clearance for nails from edges shall be 10 mm. The nails shall be rustless where the nail heads are exposed. Where the joints are to be covered with beading, felt headed (clout) nails shall be used instead of lost head nails.

**3.0 Mode of measurement & payment :**

**3.1** The relevant specifications of item no. 16.3 (A) shall be followed.

**3.2** The rate shall be for a unit of one sq. metre.

**16.13 (I) Providing and fixing plywood lining with butt jointing and nails (frame work and cover filled to be measured and paid for separately) 6 mm. thick ply.**

**1.0 Materials :** 6 mm. thick plywood shall conform to M-37.

**2.0 Workmanship :** The relevant specification of item 16.4 shall be followed except that 6 mm. thick plywood shall be fixed in lining.

**3.0 Mode of measurements & payment :**

**3.1** The relevant specifications of item no. 16.4 shall be followed.

**3.2** The rate shall be for a unit of one sq. metre.

**16.13 (II) Providing and fixing plywood lining with butt jointing and nails (frame work and cover filled to be measured and paid for separately) 9 mm. thick ply.**

**1.0 Materials & Workmanship :**

**1.1** The relevant specification of item 16.13 (I) shall be followed except that the thickness of plywood to be fixed shall be 6 mm.

**2.0 Mode of measurements & payment :**

**2.1** The relevant specifications of item no. 16.4 (A) shall be followed.

**2.2** The rate shall be for a unit of one sq. metre.

**16.21 (I) Providing and fixing plain asbestos sheet lining with butt jointing and wood screws (frame work and cover fillets to be paid for separately). Class-A 6.5 mm. thick.**

**1.0 Materials :**

**1.1** Plain A.C. sheets 6.5 mm. thick shall be conform to M-24.

**2.0 Workmanship :**

**2.1** The relevant specifications of item no. 16.4 shall be followed except that the plain A.C. sheet class –A of 6.5 mm. thickness shall be fixed in lining.

**2.2** In fixing asbestos cement sheets, care shall be taken to avoid fixing as this may cause cracking if the supporting structure expands or shrinks, The sheet shall be fixed with wood screws to wooden ground and the screw holes shall be drilled slightly longer than the screws. Asbestos sheet may also be advantageously fixed on to walls with cement plaster backing. The screws shall be fixed at 150 mm. to 200 at supports. The boards shall be fitted either with wooden cover fillets or asbestos strips as described in item.

**3.0 Mode of measurements & payment :**

**3.1** The relevant specifications of item no. 16.4 shall be followed.

**3.2** The rate shall be for a unit of one sq. metre.

**16.21 (II) Providing and fixing plain asbestos sheet lining with but jointing to wood screws (frame work and cover fillets to be paid for separately). Class-B 5 mm. thick.**

**1.0 Materials & workmanship :**

**1.1** The relevant specifications of item no. 16.21 (I) shall be followed except that the plain A.C. sheet of class-B, 5 mm. thick shall be fixing in lining.

**2.0 Mode of measurements & payment :**

**2.1** The relevant specifications of item no. 16.21 (I) shall be followed.

**2.2** The rate shall be for a unit of one sq. metre.

**SECTION – 17**  
**DETAILED SPECIFICATIONS FOR PLASTERING AND PAINTS PER**  
**“SCHEDULE OF RATES”**

**17.58** *(I) 10 mm. thick cement plaster in single coat on fair side of brick concrete walls for interior plastering upto floor two level and finished even and smooth in (I) C.M. 1:3.*

**1.0 Materials :**

**1.1** Water M-1. The Cement mortar of proportion 1:3 shall conform to M-13.

**2.0 Workmanship :**

**2.1** Scaffolding : Wooden ballies, bamboos, planks, treatles and other scaffolding shall be sound. These shall be properly examined before erection and use Stage scaffolding shall be provided for ceiling plaster, which shall be independent of the walls.

**2.2** Preparation of back-ground :

**2.2.1** The surface shall be cleaned of all dust, loose mortar droppings, traces of algae, afflorescence and other foreign matter by water or by brushing. Smooth surface shall be roughened by wire brushing if it is not hard and by racking if it is hard. In case of concrete surface, if a chemical retarder has been applied to the form work, the surface shall be roughened by wire brushing and all the resulting dust and loose particles cleaned off and care shall be taken that none of the retarder is left on the surface. Trimming of projections on brick/concrete surface where necessary shall be carried out to get an even surface.

**2.2.2** Raking of joints in case of masonry where necessary shall be allowed to dry out for sufficient period before carrying out the plaster work.

**2.2.3** The work shall not be soaked but only damped evenly before applying the plaster. If the surface becomes dry such area shall be moistened again.

**2.2.4** For external plaster, the plastering operation shall be started from top floor and carried downwards. For internal plaster, the plastering operations may be started wherever the building frame and cladding work are ready and the temporary supporting ceiling resting on the wall of the floor have been removed, Ceiling plaster shall be completed before starting plaster to walls.

**2.3 Applications of Plaster :**

**2.3.1** The plaster about 15 x 15 cms. Shall be first applied horizontally and vertically at not more than 2 metre intervals over the entire surface to serve as gauge. The surfaces of these gauges shall be truly inplane of the finished plastered surface. The mortar shall then be applied in uniform surface slightly more than the specified thickness, then brought to a true surface by working a wooden straight edge reaching across the gauges with small upward and sideways movement at a time. Finally, the surface shall be finished off true with a trowel or wooden float according as a smooth or a sandy granular texture is required. Excessive trowelling or overworking the float shall be avoided. All corners, arrises, angles and junctions be truly vertical or horizontal as the case may be and shall be carefully finished. Rounding or chamfering corners, arrises junctions etc. shall be carried out with proper templates to the size required.

- 2.3.2** Cement plaster shall be used within half an hour after addition of water. Any mortar or plaster which is partially set shall be rejected and removed forthwith from the site :
- 2.3.3** In suspending the work at the end of the day, the plaster shall be left out clean to the line both horizontally and vertically. When recommencing the plaster, the edges of the old work shall be scraped clean and wetted with cement putty before plaster is applied to the adjacent area to enable the two to properly joint together. Plastering work shall be closed at the end of the day on the body of the wall and nearer than 15 cm. To any corners or arrises. Horizontal joints in plasterwork shall not also occur on parapet tops and copings as these invariably lead to leakage. No portion of the surface shall be left out initially to be packed up later on.
- 2.3.4** Each coat shall be kept damp continuously till the next coat is applied or for a minimum period of 7 days. Moistening shall commence as soon as plaster is hardened sufficiently. Soaking of walls shall be avoided and only as much water as can be readily absorbed shall be used excessive evaporation on the sunny or windward side of building in hot air or dry weather shall be prevented by handling mattings or gunny bags on the outside of the plaster and keeping them wet.
- 3.0 Mode of measurement & payment :**
- 3.1** The rate shall include the cost of all materials, labour and scaffolding etc, involved in the operations described under workmanship.
- 3.2** All plastering shall be measured in square metres unless, otherwise specified length, breadth or height shall be measured correct to a centimeter.
- 3.3** Thickness of the plaster shall be exclusive of the thickness of the key i.e. grooves or open joints in brick work, stone work etc. or space between laths. Thickness of plaster shall be average thickness with minimum 10 mm. at any point on this surface.
- 3.4** This item includes plastering upto floor two level.
- 3.5** The measurement of wall plastering shall be taken between the walls or partition (dimensions before plastering being taken) for length and from the top of floor or skirting to ceiling for height. Depth of cover of cornices if any shall be deducted.
- 3.6** Soffits of stairs shall be measured as plastering on ceilings, Flowing soffits shall be measured separately.
- 3.7** For jambs, soffits, sills etc. for openings not exceeding 0.5 sq. mt. each in area for ends of joints, beams, posts, girders, steps etc. not exceeding 0.5 sq. mt. each in area and for openings exceeding 0.5 sq.mt. and not exceeding 3.0 sq. mt. in each area deductions and additions shall be made in the following manner :
- (a) No deductions shall be made for ends joints, beams posts etc. and openings not exceeding 0.5 sq. mt. each and no addition shall be made for reveals, jambs, soffits, sills etc. of these opening for finish to plaster around ends of joints, beams, posts etc.
- (b) Deduction for openings exceeding 0.5 sq. mt. but not exceeding 3 sq. mt. each shall be made as follows and no addition shall be made for reveals, jambs, soffits etc. sills etc. of these openings.
- (i) When both faces of all wall are plastered with same plaster, deduction shall be made for one face only.
- (ii) When two faces of wall are plastered with different types of plasters or if one faces is plastered and the other pointed, deductions shall be made from the plaster or pointing on the side of frame for door, window etc. on which width

or reveals is less than that on the other side but no deductions shall be made on the other side. Where width of reveals on both faces of all are equal, deductions of 50% of area of opening on each face shall be made from area of plaster and/or pointing as the case may be.

**3.8** For openings having door frames equal to projecting beyond the thickness of wall, full deduction for opening shall be made from each plastered face of the wall.

**3.9** In case of openings of area above 3 sq. mt. each, deduction shall be made for opening but jambs, soffits and sills shall be measured.

**3.10** The rate shall be for a unit of one sq. metre.

**17.58 (II) 10 mm. cement plaster in single coat on fair side of brick/concrete walls for interior plastering upto floor two level and finished even and smooth in C.M. 1:4.**

**1.0 Materials & Workmanship :**

**1.1** The relevant specifications of item no. 17.84 (I) shall be followed except that the proportion of mortar is C.M. 1:4 instead of C.M. 1:3.

**2.0 Mode of measurements & payment :**

**2.1** The mode of measurements and payment shall be the same as for item no. 17.58 (I).

**2.2** The rate shall be for a unit of one sq. metre.

**17.58 (III) 10 mm. cement plaster in single coat on fair side brick/concrete walls for interior plastering upto floor two level and finished even and smooth in C.M. 1:6.**

**1.0 Materials & Workmanship :**

**1.1** The relevant specifications of item no. 17.58 (I) shall be followed except that the proportion of mortar is Cement mortar 1:6.

**2.0 Mode of measurements & payment :**

**2.1** The mode of measurement and payment shall be followed same as item no. 17.58 (I).

**2.2** The rate shall be for a unit of one sq. metre.

**17.61 (I) 20 mm. thick cement plaster in single coat on rough side of single or half brick wall for interior plastering upto floor two level, finished even and smooth in cement mortar 1:3 1 cement : 3 sand).**

**1.0 Materials & Workmanship :**

**1.1** The relevant specifications of item no. 17.59 (I) shall be followed except that the thickness of item plaster shall be 20 mm. The plastering work shall be in single coat on rough of half brick wall for interior plastering upto floor two level, finished even and smooth in C.M. 1:3.

**2.0 Mode of measurements & payment :**

**2.1** The relevant specifications of item no. 17.59 (I) shall be followed.

**2.2** The rate shall be for a unit of one sq. metre.

**17.61 (II) 20 mm. thick cement plaster in single coat on rough side of single or half brick wall for interior plastering upto floor two level, finished even and smooth in cement mortar 1:4 1 cement : 4 sand).**

**1.0 Materials & Workmanship :**

**1.1** The relevant specifications of item no. 17.59 (II) shall be followed except that the thickness of plastering shall be 20 mm in C.M. 1:4.

**2.0 Mode of measurements & payment :**

**2.1** The relevant specifications of item no. 17.59 (I) shall be followed.

**2.2** The rate shall be for a unit of one sq. metre.

**17.61 (III) 20 mm. thick cement plaster in single coat on rough side of single or half brick wall for interior plastering upto floor two level, finished even and smooth in cement mortar 1:6 (1 cement : 6 sand).**

**1.0 Materials & Workmanship :**

**1.1** The relevant specifications of item no. 17.59 (III) shall be followed except that the thickness of plaster shall be 20 mm in C.M. 1:6.

**2.0 Mode of measurements & payment :**

**2.1** The relevant specifications of item no. 17.59 (I) shall be followed.

**2.2** The rate shall be for a unit of one sq. metre.

**17.69 Extra over item 58 to 64 for finishing with a floating coat of neat cement slurry.**

**1.0 Materials & Workmanship :**

**1.1** The relevant specifications of item 17.58 and 17.61 shall be followed for materials and workmanship except that this work is only of providing smooth cement finish with floating coat of neat cement slurry.

**1.2** The coat of cement and fine sand mortar of proportion 1:1 (1.5 mm. thick about) shall be applied to the plastered surface with a trowel to provide uniform texture while the base coat is still plastic.

**1.3** In any continuous face of wall the finishing treatment should be carried out continuously and day to day braked made to coincide with architectural breaks in order to avoid unsightly junctions.

**1.4 Curing :** All the plaster work shall be kept damp continuously for a period of 7 days.

**2.0 Mode of measurements & payment :**

**2.1** The payment shall be made for a unit of 1.0 sq. mt. of work done over and above the finishing of work of base coat.

**2.2** The relevant specifications of item of base coat shall be followed for measurements and payment.

**2.3** The rate shall be for a unit of one sq. metre.

**17.70 Extra over items 17.58 to 17.61 for providing and mixing water proofing materials in cement mortar in proportion recommended by the manufacturers.**

**1.0 Materials & Workmanship :**

**1.1** The relevant specifications of item no. 17.58 to 17.61 shall be followed except that the water proofing materials of approved make shall be added to the cement at the rate specified or as directed by the Engineer-in-charge. The proportion of water proofing materials to be mixed with 50 kg. Bags shall be as recommended by the manufactures of the water proofing material.

**2.0 Mode of measurements & payment :**

**2.1** The payment shall be made extra for this work over and above the plaster work.

**2.2** The rate shall be for a unit of 1 kg. Of water proofing materials used in 1 bag weighing 50 kg. Cement used extra over the rate of plastering work.

**17.91 Extra over item no. 17.59 to 17.61 for plastering on ceiling and soffits of stair upto floor two level instead of plastering on walls.**

**1.0 Materials & Workmanship :**

**1.1** The relevant specifications of item 17.59 (I) shall be followed except that this work is for ceiling soffits of stairs upto two floor level instead of plaster on walls.

**1.2** The smooth concrete surface shall be suitably roughened to provide necessary bond before plastering.

**2.0 Mode of measurements & payment :**



- 2.1 The payment shall be made for a unit for one sq. metre of work done, extra over and above the payment plaster work on wall surfaces.
- 2.2 The rate shall be for a unit of one sq. metre.
- 17.94 (I) Extra over item no. 1 to 69, 71 to 87 and 90 interior plastering above floor two level for every additional story height (I). Single coat plaster.**
- 1.0 Materials & Workmanship :**
- 1.1 The relevant specifications of item no. 17.59 (I) shall be followed except that the whole work is to be carried out above floor two level.
- 2.0 Mode of measurements & payment :**
- 2.1 The mode of measurements and payment shall be same as item no. 17.59 (I).
- 2.2 The extra payment shall be made over and above the floor two level rate for every additional floor height.
- 2.3 The rate shall be for a unit of one sq. metre.
- 17.94 (II) Extra over item no. 1 to 69, 71 to 87 and 90 interior plastering above floor two level for every additional story height. Two coat plaster.**
- 1.0 Materials & Workmanship :**
- 1.1 The relevant specifications of item no. 17.94 (I) shall be followed except that extra payment for work shall be for a two coat plaster.
- 2.0 Mode of measurements & payment :**
- 2.1 The relevant specifications of item no. 17.94 (I) shall be followed.
- 2.2 The rate shall be for a unit of one sq. metre.
- 17.94 (III) Extra over item no. 1 to 69, 71 to 87 and 90 interior plastering above floor two level for every additional story height. Floating coat of neat cement.**
- 1.0 Materials & Workmanship :**
- 1.1 The relevant specifications of item no. 17.94 (I) shall be followed except that extra payment shall be made for work of floating coat of neat cement slurry.
- 2.0 Mode of measurements & payment :**
- 2.1 The relevant specifications of item no. 17.59 (I) shall be followed.
- 2.2 The rate shall be for a unit of one sq. metre.
- 17.95 20 mm. thick sand face cement plaster on walls upto height of 10 mm. and above ground level consisting of 12 mm. thick backing coating of C.M. 1:3 (1 cement : 3 sand) and 8 mm. thick finishing coat in C.M. 1:1 (1 cement :1 sand) etc. complete.**
- 1.0 Materials :**
- 1.1 Water shall conform to M-12. Cement mortar shall conform to M-11.
- 2.0 Workmanship :**
- 2.1 The work shall be carried out in the coats. The backing coat (base coat) shall be 12 mm. thick in C.M. 1:3. The relevant specifications of item no. 17.58(I) shall be followed except that the thickness of back coat shall be 12 mm. average. Before the first coat hardens its shall be beaten up by edges of wooden tappers and close dents shall be made on the surface.  
The subsequent coat shall be applied after this coat has been allowed to set for 3 to 5 days depending upto the weather conditions. The surface shall not be allowed to dry during this period.
- 2.2 The second coat shall be completed to 8 mm. thickness in C.M. 1:1 as described above, including raising sand facing by bushing. The sample of sand face shall be got approved before the work is started. The whole work shall be carried out uniformly as per sample approved.
- 2.3 **Curing :** The curing shall be started overnight after finishing of plaster. The plaster shall be kept for a period of 7 days. During this period, it shall be protected from all damages.

**3.0 Mode measurements & payment :**

**3.1** The relevant specifications of item no. 17.58 (I) shall be followed except that the sand face plaster on outside upto m. above ground level shall be measured under this item.

**3.2** The rate shall be for a unit of one sq. metre.

**17.116 (A) Pointing on brick work with cement mortar 1:3 (1 cement : 3 coarse sand) flush pointing.**

**1.0 Materials :**

**1.1** Water shall conform to M-12. Cement mortar shall conform to M-11.

**2.0 Workmanship :**

**2.1** The flush pointing work shall be carried out with cement mortar proportion 1:3 (1 part of cement and 3 parts of coarse sand) by volume.

**2.2 Preparation of surface :**

**2.2.1** The joints shall be raked to such a depth that the average of new mortar measured from either the sunk surface of finished pointing or from the edge of the brick shall be average 10 mm.

**2.3 Application of Mortar & Finishing :**

**2.3.1** The mortar shall be pressed into the raked out joints with a pointing trowel according to the type of pointing specified in item. The mortar shall not spread over the corner edges or surface of the masonry. The pointing shall then be finished with the pointed tools.

**2.4 Curing :**

**2.4.1** The pointing shall be kept wet for 7 days. During this period, it shall be suitably protected from all damages.

**3.0 Mode of measurement & payment :**

**3.1** No deductions shall be made for end of joints, beams and posts etc. and openings not exceeding 0.5 sq. mt. each and no addition shall be made for reveals, jambs, soffits, sills etc. of these openings.

**3.2** Deductions for openings exceeding 0.5 sq. mt. but not exceeding 3 sq. mt. each shall be paid as follows and no addition shall be made for reveals, jambs, soffits, sills etc. of these openings.

(i) When both faces of walls are pointed with same type of pointing, deduction shall be made for one face only.

(ii) When both faces of walls are pointed with different type of pointing or if one face is plastered and the other is pointed, deduction shall be made in the plaster or pointing on the side of frame for door, windows etc. on which the width of reveals is less than that on the other side but no deduction shall be made from plaster or pointing on the other side.

(iii) When only one face is treated and the other face is not treated, full deduction shall be made, if the width of the reveals on the treated side is less than on the untreated side, but if the width of the reveal is more, then no deduction shall be made nor any addition shall be made for reveals jambs, soffits, sills etc.

**3.3** In case of openings of area 3 sq. mt. each deduction shall be made for opening but jambs, sills and soffits shall be measured.

**3.4** The rate shall be for a unit of one sq. metre.

**17.116 (B) Pointing on brick work with cement mortar 1:3 (1 cement :3 coarse sand) Ruled pointing.**

**1.0 Materials & Workmanship :**

**1.1** The relevant specifications of item no. 17.116 (A) shall be followed except that the pointing to be done ruled pointing as under :

**1.2** The joints shall be initially formed for flush pointing and then while the mortar is still green a groove of specified shape shall be formed by running



forming tool straight along the centre line of joints till a smooth and hard surface is obtained. The vertical joints shall also be finished on a similar way. The pointing line shall be uniform in width and truly horizontal and parallel in case of floor and ceiling.

**2.0 Mode of measurements & payment :**

**2.1** The mode of measurements and payment shall be the same as per item no. 17.116 (A).

**2.2** The rate shall be for a unit one sq. meter

**17.117 (A) Pointing on brick work with cement mortar 1:4 (1 cement : 4 sand) flush pointing.**

**1.0 Materials & Workmanship :**

**1.1** The relevant specifications of item no. 17.116 (A) shall be followed except that the pointing work shall be carried out C.M. 1:4.

**2.0 Mode of measurement & payment :**

**2.1** The relevant specifications of item no. 17.116 (A) shall be followed.

**2.2** The rate shall be for a unit of one sq. metre.

**17.117 (B) Pointing on brick work with cement mortar 1:4 (1 cement :4 sand) : Ruled pointing.**

**1.0 Materials & Workmanship :**

**1.1** The relevant specifications of item no. 17.116 (B) shall be followed except that the proportion of C.M. 1:4 shall used for ruled pointing.

**2.0 Mode of measurement & payment :**

**2.1** The relevant specifications of item no. 17.117 (A) shall be followed.

**2.2** The rate shall be for a unit of one sq. metre.

**17.140 (A) Pointing on coursed stone masonry with cement mortar 1:3 (1 cement :3 sand) flush pointing.**

**1.0 Materials & Workmanship :**

**1.1** The relevant specifications of item no. 17.116 (A) shall be followed except that the pointing shall be done on coursed stone masonry with C.M. 1:3 and the mortar shall be simply struck off with a trowel and the work left showing the natural irregularities in line and the surface of the stones themselves.

**2.0 Mode of measurements & Payment :**

**2.1** The relevant specifications of item no. 17,116 (A) shall be followed.

**2.2** The rate shall be for a unit one sq. metre.

**17.140 (B) Pointing on course masonry with cement mortar 1:3 (1 cement : 3 sand) Ruled pointing.**

**1.0 Materials & Workmanship :**

**1.1** The relevant specifications of item no. 17.140 (A) and 17.116 (B) shall be followed.

**2.0 Mode of measurements & Payment :**

**2.1** The relevant specifications of item no. 17,116 (A) shall be followed.

**2.2** The rate shall be for a unit one sq. metre.

**17.144 (A) Pointing on uncoursed stone masonry with cement mortar 1:3 (1 cement :3 sand) Flush pointing.**

**1.0 Materials & Workmanship :**

**1.1** The relevant specifications of item no. 17.116 (A) shall be followed except that the flush pointing shall be done on uncoursed rubble masonry work in C.M. 1:3 and the mortar shall be simply struck off with a trowel and the work left showing the natural irregularities in line and the surface of the stones themselves.

**2.0 Mode of measurements & Payment :**

**2.1** The relevant specifications of item no. 17.116 (A) shall be followed.

- 2.2 The rate shall be for a unit one sq. metre.
- 17.144 (B) Pointing on uncoursed stone masonry with cement mortar 1:3 (1 cement : 3 sand) Ruled pointing.**
- 1.0 Materials & Workmanship :**
- 1.1 The relevant specifications of item no. 17.144 (A) and 17.116 (A) shall be followed except that the ruled pointing work shall be carried out on uncoursed rubble masonry work in C.M. 1:3.
- 2.0 Mode of measurements & Payment :**
- 2.1 The relevant specifications of item no. 17.116 (A) shall be followed.
- 2.2 The rate shall be for a unit one sq. metre.
- 17.0.0.1 Providing cement vata (10 cms x 10 cms) size quarter round in cement mortar 1:1 including near cement finishing, watering etc. complete.**
- 1.0 Materials :**
- 1.1 Water shall conform to M-12 . Cement mortar shall conform to M-11.
- 2.0 Workmanship :**
- 2.1 The work of cement vata of 10 cms. x 10 cms. size shall be carried out at junctions of parapets and terraces as directed. The vata shall be finished in quarter round shape. The work shall be carried out in the best workman like manner. The inter portion of rain water pipe shall be rounded off properly during constructing the vata. The work shall be cured for 7 days.
- 3.0 Mode of measurements & payment :**
- 3.1 The work shall be measured for finished item in running meter.
- 3.2 The rate shall be for a unit of one running metre.

## SECTION – 18

### DETAILED SPECIFICATIONS FOR WHITE WASHING & DISTEMPERING AS PER “SCHEDULE OF RATES”

- 18.11 White washing with lime on undecorated wall surfaces (two coats) to give an even shade including thoroughly brooming the surface to remove all dirt, dust mortar drops and other foreign matter.**
- 1.0 Materials :**
- 1.1 The calcearcole shall be made from glue and boiling water by mixing 1 kg. Mixture shall be suitably tinted where required for use under coloured distemper if required. Glue shall conform to I.S. 852-1969 (Specifications for animal glue).
- 1.2 Lime used shall be freshly burnt class ‘C’ Lime (fat lime) and white in colour conforming to I.S. 712-1973. Water shall conform to M-1 Best quality of gum shall be used in the preparation of white wash. Ultramarine blue or Indigo: This shall conform to I.S. 55-1970 for points and shall be used for preparation of white wash. Pigments: mineral colours, not affected by lime shall be used in preparing colour wash.
- 2.0 Workmanship :**
- 2.1 Preparation of white wash solution :  
Surface already white or colour. The fat lime shall be slaked at site and shall be mixed and stirred with about five litres of water for 1 kg. of unslaked lime to make a thin cream. This shall be allowed to stand for a period of 24 hours and then shall be screened through a clean coarse cloth, 4 kg. of gum dissolved in hot water shall be added to each cubic metre of lime cream. Small quantity of ultramarine blue (Upto 3 gms. Per kg. of lime) shall also be added to the last two coats of white wash solution and the whole solution shall be stirred thoroughly before use.

## **2.2 Preparation of surface :**

- 2.2.1 The surface shall be thoroughly cleaned of all dust, dirt, mortar cropping and other foreign matters before white wash is to be applied.
  - 2.2.2 The surface spoiled by smoke soot shall be scraped with steel wire brushes or steel scrappers or shall be rubbed with over burnt surkhi or brick bats. The surface shall be then broomed to remove all dust, dirt and shall be washed with clean water.
  - 2.2.3 Oil or grease spots shall be removed by suitable chemical and smooth surface shall be rubbed wire brushes.
  - 2.2.4 All unsound portion of the surface plaster shall be removed to full depth of plaster in rectangular patches and plastered again after raking the masonry joints properly. Such portion shall be wetted and allowed to dry. They shall then be given one coat of white wash.
  - 2.2.5 All unnecessary nails shall be removed, the holes cracks patches etc. shall be made good with materials similar in composition to the surface to be prepared.
- 2.3 **Scaffolding :** Wherever scaffolding is necessary it shall be erected in such a way that as far as possible on part of scaffolding shall rest against the surface to be white or coloured washed. A properly secured strong and well tied suspended platform (Zoola) may be used for white washing. Where ladders are used, pieces of old gunny bags shall be tied at top and bottom to prevent scratches to the floors and walls. For white washing of ceilings proper stage scaffolding shall be erected where necessary.

## **2.4 Application of white wash :**

- 2.4.1 On the surface so prepared the white wash shall be applied with 'Moon' brush. The first stroke of the brush shall be from top downwards, another from bottom upwards over the first stroke and similarly one stroke from the right another from the left, over the first stroke brush before the it dries. This will form one coat. Each coat shall be allowed to dry before next coat is applied. Number coats as specified in item shall be applied. It shall present smooth and uniform finish free from brush marks and it should not come off easily when rubbed finger.
- 2.4.2 Splashing and dropping if any on the doors and windows, ventilators etc. shall be removed and the surface cleaned.
- 2.4.3 Priming and Alkali resistant treatments, scrapping of surface washing etc. surface spoiled by smoke soot removed of oil and grease spots treatment for infection with effloresces moulds moss, funji and kitchen and patch repairs to plaster wherever done shall not be paid extra.

## **3.0 Mode of measurements & payment :**

3.1 All the work shall be measured in the decimal system as under :

- (a) Dimensions shall be measured to the nearest 0.01 M.
  - (b) Area in individual items shall be worked out to the nearest 0.01 Sq. M.  
All the work shall be measured in sq. mt. Deductions for jambs, soffits, stills etc. for opening not exceeding 0.5 sq. mt. each in area for ends of joints, posts, beams, girders, steps etc. not exceeding 0.5 sq. mt. each in area and for opening exceeding 0.3 sq. mt. and not exceeding 3.0 sq. mt. each in area deductions and additions shall be made as under :
- 3.2 No deductions shall be made for ends of joints beams, posts etc. and openings not exceeding 0.5 sq. mt. each. No addition shall be made for reveals, jambs, soffits, sills etc. of these openings nor for finish around ends of joints, beams, posts etc.

- 3.3** Deductions for openings exceeding 0.5 sq. mt. but not exceeding 3 sq. mt. each shall be made as follows and no addition shall be made for reveals, jambs, soffits etc. of these openings :
- (a) When both the faces or walls are provided with finish, deduction shall be made for one face only.
  - (b) When each face of wall is provided with different finish deduction shall be made for that side of frame for door, windows etc. on which width of reveals is less than that of the other side, where width of reveals on both faces of wall are equal, deduction of 50% of area of opening on each face shall be made from total area of finish.
  - (c) When only one face of wall is treated and the other face is not treated, full deduction shall be made if the width of reveal on the treated side is less than that on the untreated side, but if the width of the reveal is equal or more than on the untreated side neither deductions nor additions be made for reveals, jambs, soffits, sills etc.
- 3.4** In case of area of opening exceeding 3 sq. mt. each, deduction shall be made for openings but jambs, soffits, shall be measured.
- 3.5** No deduction shall be made for attachment such as casing, conducts, pipe, electric wiring and the like.
- 3.6** corrugated surfaces shall be measured flat as fixed and not girth. The quantities so measured shall be increased by the following percentage and the resultant shall be included with the general areas.
- (a) Corrugated steel sheets 14%
  - (b) Corrugated A. C. Sheets 20%
  - (c) Semi corrugated A. C. Sheets 10%
  - (d) Nainital pattern roof (Plain sheeting with rolls) 10%
  - (e) Nainital pattern roof (with corrugated sheets) 25%
- 3.7** Cornices and other wall features, when they are not picked out in a different finish/colour shall be girthed and included in the general area.
- 3.8** The rate shall include the cost of all materials, labour, scaffolding, protective measures etc. involved in all the operations described above.
- 3.9** The rate shall be for a unit of one sq. metre.
- 18.12** *White washing with lime on decorated wall surface (One coat) to give an even shade including thoroughly brooming the surface to remove dirt, dust mortar drops and loose scales of lime wash and other foreign matter.*
- 1.0 Materials & Workmanship :**
- 1.1** The relevant specifications of item No. 18.11 shall be followed except that the white washing work shall be carried out on decorated wall surface in single coat.
- 2.0 Mode of measurements & payment :**
- 2.1** The relevant specifications of item No. 18.11 shall be followed.
- 2.2** The rate shall be for a unit of one sq. metre.
- 18.13** *Extra over item 18.11 and 18.12 for every subsequent coat of white washing with lime on wall surfaces.*
- 1.0 Materials & Workmanship :**
- 1.1** The relevant specifications of item No. 18.11 shall be followed except that this work is for extra coat over and above two coats on wall surface.
- 2.0 Mode of measurements & payment :**
- 2.1** The relevant specifications of item No. 18.11 shall be followed except that the payment of subsequent coat shall be made extra over and above the item No. 18.11 for every subsequent coat applied.
- 2.2** The rate shall be for a unit of one sq. mt.

**18.14** *Extra over item 18.11 for white washing with the lime on ceiling and/or sloping roof.*

**1.0 Materials & Workmanship :**

**1.1** The relevant specifications of item No. 18.11 above shall be followed except that this work is for ceiling and/or sloping roof.

**2.0 Mode of measurements & payment :**

**2.1** The relevant specifications of item No. 18.11 shall be followed except that extra payment for white washing on ceiling and/or sloping roof shall be made and above the payment of item No. 18.11

**2.2** The rate shall be for a unit of one sq. metre.

**18.15** *Extra over 18.12 for white washing with lime on ceilings and sloping roofs.*

**1.0 Materials & Workmanship :**

**1.1** The relevant specifications of item No. 18.123 shall be followed except that the white washing work shall be carried out on decorated ceiling and/or sloping roofs.

**2.0 Mode of measurements & payment :**

**2.1** The relevant specifications of item No. 18.12 shall be followed except that the extra payment for white washing on ceiling and/or sloping roof shall be made over and above the payment of item No. 18.12

**2.2** The rate shall be for a unit of one sq. metre.

**18.16** *Extra over the item No. 18.13 for every subsequent coat of white washing with lime on ceiling and/or sloping roofs.*

**1.0 Materials & Workmanship :**

**1.1** The relevant specifications of item No. 18.11 and 18.13 shall be followed except that this work is for extra coat over and above two coats of ceiling and or sloping roofs.

**2.0 Mode of measurement & payment :**

**2.1** Relevant specifications of item No. 18.11 and 18.13 shall be followed except that the extra payment for white washing shall be made for sloping roof or/and ceiling for every subsequent coat applied over and above item 18.13.

**2.2** The rate shall be for a unit of one sq. metre.

**18.17** *Colour washing with lime on undecorated wall surfaces (Two coats) over and including priming coat of white washing to give even shade including thoroughly brooming the surface to remove all dirt, dust, mortar drops and other foreign matter. The relevant specifications for the materials and workmanship of item No. 18.11 shall be followed except that it shall be for colour wash.*

**1.0 Materials :**

**1.1 Clear-Colle :** This shall be made from glue and boiling water by mixing 1 Kg. of glue to every 15 litres of water. The mixing shall be suitable tinted to match with colour of washing as directed. Glue shall conform to I.S. 852-1969.

**1.2 Lime :** Lime used shall be freshly burnt class 'C' lime (Fat lime) and white in colour conforming to I.S. 712-1973.

**1.3 Water :** Water shall conform to M-1.

**1.4 Gum :** Best quality of gum shall be used in the preparation of white or colour wash. The colour pigment of required tint and shade shall be mixed in lime cream. The mineral colour not affected by lime shall be used in preparing the colour wash.

**2.0 Workmanship :**

**2.1** Sufficient quantity of colour wash enough for the complete job shall be prepared in one operation to avoid any difference in shade. The basic white wash solution shall be prepared in accordance with item 18.11. Mineral colour

not affected by lime shall be added to the white wash solution. No colour wash shall be done until a sample of the colour has been approved. It shall be noted that small samples of colour appears lighter in shade than when the same shades are applied precisely to large surface. The colour shall be of even tint, over the whole surface. If it is patchy or otherwise badly applied, it shall be rejected. Preparation of the colour wash with pigment shall be as under :

- (a) **With Yellow and Red Ochre :** Solid lumps if any in the powder shall be crushed to powder and solution in water prepared and then added to white wash sieving it through a coarse cloth, mixed evenly and thoroughly to white wash in small quantities till the required shade is obtained.
- (b) **With Blue Vitriol :** Fresh crystals of hydrous copper sulphate (i.e. blue vitriol) shall be ground to fine powder and dissolved in small quantity of water. Sufficient quantity of solution enough to produce the colour wash of required shade shall be strained through a clean cloth, the filtrate being mixed evenly and thoroughly to the white wash.
- (c) Colour wash from other colouring pigment shall be prepared in accordance with the instructions of the manufacturer.

**2.2 Preparation of Surface :** The surface shall be prepared by removing mortar droppings and foreign matter and thoroughly cleaned with wire or fibre brush or any other suitable means as directed by the Engineer-in-charge. All loose pieces and scales shall be scrapped off boles filled with mortar.

**2.2.1.** For scaffolding and application of colour wash, relevant specification of item No. 18.11 above shall be followed. The colour wash shall be applied as under : The colour wash shall be applied in accordance with the procedure given in item No. 18.11 "Application of white wash for colour washing on undecorated surface" after the surface has been prepared. The first primary coat shall be of white wash and subsequent coat (minimum two) shall be colour wash and the entire surface shall represent a smooth and uniform finish. To start with, patch of 0.1 sq. mt. on prepared surface shall be colour washed with first coat of white wash and subsequent coats of colour wash solution in full numbers of coats as described in the item and the shade so obtained shall be examined before the entire work of colour washing is taken up in hand. It shall be noted that small areas of colour wash will appear lighter in shade than when the same shade is applied to the large surface.

**2.2.2** For colour washing on decorated surfaces, after the surface has been prepared, a coat of white wash shall be applied for the patches and repairs. Then one coat or more of colour wash shall be applied over the entire surface, such that the colour washed surface shall present a uniform colour shade. No primary coat is needed for a decorated surface bearing colour of same shade on surface requiring change of colour after the surface has been prepared as described above. Two coats of white wash shall be applied before application of specified number (minimum two) of coats of colour wash of the new shade.

**2.3 Protective measure :** The surface of doors, windows, floors, articles of furniture etc, and such other parts of the building not to be white washed shall be protected from being splashed upon. Such surfaces shall be cleaned of white wash splashed if any.

**3.0 Mode of measurements & payment :**

**3.1** The relevant specifications of item No. 18.11 shall be followed.

**3.2** The rate shall be for a unit of one sq. metre.

**18.18** *Colour washing with lime on decorated wall surfaces (one coat) to give an even shade including thoroughly brooming the surface to remove all dirt dust, mortar drops and loose scales of lime wash and other foreign matter.*



- 1.0 Materials & Workmanship :** The relevant specifications of item No. 18.17 shall be followed except that the colour washing shall be carried out on decorated wall surfaces in one coat.
- 2.0 Mode of measurements & payment :**
- 2.1** The relevant specifications of item No. 18.17 shall be followed
- 2.2** The rate shall be for a unit of one sq. metre.
- 18.19 *Extra over item No. 18.17 and 18.18 for every subsequent coat of colour wash with lime on wall surface.***
- 1.0 Materials & Workmanship :**
- 1.1** The relevant specifications of item No. 18.17 shall be followed except that this work is for extra cost of colour wash over and above two coats on wall surface.
- 2.0 Mode of measurements & payment :**
- 2.1** The relevant specifications of item No. 18.17 shall be followed except that the extra payment for every subsequent coat of white wash shall be made over and above the rate of item 18.17 and 18.18.
- 2.2** The rate shall be for a unit of one sq. metre.
- 18.20 *Extra over item 18.17 for colour washing on ceilings and/or sloping roofs.***
- 1.0 Materials & Workmanship :**
- 1.1** The relevant specifications of item No. 18.17 shall be followed except that this work is for colour washing on ceiling and/or sloping roofs.
- 1.2** The rate shall be for a unit of one sq. metre.
- 18.29 *Cement washing with Portland cement slurry on undecorated wall surfaces, (one coat) to give a smooth finish including thoroughly brooming the surface to remove all dirt, dust, mortar drops and other foreign matter.***
- 1.0 Materials :** 1 Water shall conform to M-1. Portland cement shall conform to M-3.
- 2.0 Workmanship :**
- 2.1** The relevant specifications of item No. 18.11 for preparation of surface, scaffolding, application of wash etc. shall be followed except that the cement wash shall be applied instead of white wash. Cement shall be mixed to water to form slurry to the consistency of good ready mix oil paint. The slurry shall be applied with brushed to form a smooth bodies opaque surface.
- 3.0 Mode of measurements & payment :**
- 3.1** The relevant specifications of item No. 18.11 shall be followed.
- 3.2** The rate shall be for a unit of one sq. metre.
- 18.30 *Extra over item No. 18.29 for every subsequent coat of cement washing with Portland cement slurry.***
- 1.0 Materials & Workmanship :**
- 1.1** The relevant specifications of item No. 18.29 shall be followed except that the work of cement slurry wash shall be provided for every subsequent coats above item No. 18.29 to be applied.
- 2.0 Mode of measurements & payment :**
- 2.1** The relevant specifications of item No. 18.29 shall be followed except that the extra rate shall be paid for every subsequent coat applied over and above the rate of item No. 18.29.
- 2.2** The rate shall be for a unit of one sq. metre.
- 18.33 *Removing dry or oil bound distemper by washing and scraping and sand papering the wall surface smooth including necessary repairs to scratches complete.***
- 1.0 Materials & Workmanship :**

**1.1** All loose pieces and scales shall be removed by sand papering and surface shall be cleared of all greasy, dust, dirt, etc. on decorated wall surface. Where heavy scaling has taken place the entire surface shall be scrapped by means of steel scrappers so as to remove all accumulated distemper, leaving clean surfaces. Necessary repairs to the scratches shall be made as directed.

**2.0 Mode of measurements & payment :**

**2.1** The relevant specifications of item No. 18.11 shall be followed.

**2.2** The rate shall be for a unit of one sq. meter.

**18.33** *Removing dry or oil bound distemper by washing and scraping and sand papering the wall surface smooth including necessary repairs to scratches complete.*

**1.0 Materials & Workmanship :**

**1.1** All loose pieces and scales shall be removed by sand papering and surface shall be cleared of all greasy, dust, dirt, etc. on decorated wall surface. Where heavy scaling has taken place, the entire surface shall be scrapped by means of steel scrappers so as to remove all accumulated distemper, leaving clean surfaces. Necessary repairs to the scratches shall be made as directed.

**2.0 Mode of measurements & payment :**

**2.1** The relevant specifications of item No. 18.11 shall be followed.

**2.2** The rate shall be for a unit of one sq. meter.

**18.34** *Extra over item No. 18.33 for removing dry oil bound distemper on ceiling and sloping roofs.*

**1.0 Workmanship :**

**1.1** The relevant specifications of item No. 18.33 shall be followed except that removing dry oil bound distemper from sloping roof, ceiling is to be carried out.

**2.0 Mode of measurements & payment :**

**2.1** The relevant specifications of item No. 18.33 shall be followed except that the payment shall be made for removing dry/oil bound distemper from ceiling/sloping roof over and above the rate of item No. 18.33.

**2.2** The rate shall be for a unit of one sq. meter.

**18.38** *Distemping with dry (water bound) Distemper of approved brand and manufacture (two coats) and of required shade on undecorated wall surfaces to give an even shade over and including a priming coat of white washing after thoroughly brooming the surface free from mortar droppings and other foreign matter.*

**1.0 Materials :**

**1.1** The dry distemper and primer shall be of approved brand and manufacture. The dry distemper shall be of required colour and shade and the same shall conform to I.S. 427-1965. Whiting shall conform to I. S. 63-1964.

**2.0 Workmanship :**

**2.1 Scaffolding :** Where scaffolding is required it shall be erected in such a way that as far as possible no part of scaffolding shall rest against the surface to be distempered. A properly secured strong and well tied suspended platform (Jools) may be used for distemping. Where ladders are used, pieces of old gunny bags shall be tied at top and bottom to prevent scratches to the walls and floors. For distemping to ceiling, proper stage scaffolding shall be erected where necessary.

**2.2 Preparation of Surface :**

**2.2.1** The undecorated surface to be distempered shall be thoroughly brushed free from dust, dirt, grease, mortar, droppings and other foreign matter and sand



papered smooth. New plaster surface shall be allowed to dry at least 2 months, before application of distemper.

- 2.2.2** All unnecessary nails shall be removed. Pitting in plaster shall be made good with plaster of Paris mixed with dry distemper of the colour to be used. The surface shall then be rubbed down again with a fine grades and paper and made smooth. The surface affected by moulds, moss, fungi, algae lichem, efflorescence etc. Shall be treated in accordance with I.S. : 2395 (Part I) - 1966 before applying distemper. Any unevenness shall be made good by applying putty made of plaster of Paris mixed with water on entire surface including filling up the undulations & then papering the same after it is dry.

**2.3 Priming coat :**

- 2.3.1** A priming coat of whiting shall be applied as per item No. 18.11 over the prepared surface in case of new work on undecorated surface. No coat of white washing with lime shall be used as a priming coat for distemper.

- 2.3.2** Application of plaster shall be done as under :

The primer shall be applied with a brush on the clean dry and smooth surface. Horizontal strokes shall be given first and vertical strokes shall be applied immediately afterwards. This entire operation will constitute one coat. The surface shall be finished as uniformly as possible leaving no brush marks. It shall be allowed to dry for atleast 48 hours before oil bound distemper or paint is applied.

- 2.3.3** Distemper is not recommended to be applied within six months of the completion of wall plaster.

- 2.4 Proportion of Distemper :** The distemper shall be diluted with water or any other prescribed thinner in a manner recommended by the manufactures only. Sufficient of distemper required for one day's work shall be prepared.

**2.5 Application of Distemper coat :**

- 2.5.1** For undercoated surfaces, after the primer coat is dried for at least 48 hours, the surfaces shall be lightly sand papered to make them smooth for receiving the distemper, taking care not to rub cut the priming coat; All loose particles shall be dusted off after rubbing. Minimum two coats of distemper shall be applied with brushes in horizontal strokes followed immediately by vertical strokes which together shall constitute one coat. The subsequent coats shall be applied after time interval of at least 24 hours between consecutive coats to permit proper drying of the preceding coat. The finished surfaces shall be even and uniform without patches, brush marks; distemper drops etc.

- 2.5.2** Sufficient quantity of distemper shall be mixed to finish one room at a time. The application of a coat in each room shall be finished in one operation and no work shall be started in any room which cannot be completed on the same day.

- 2.5.3** 15 cm. double bristled distemper brush shall be used. After the days work, brushes shall be thoroughly washed in hot water with a soap solution and hang down to dry. Old brushes which are dirty and caked with distemper shall not be used on the work.

**2.6 Protective Measure :**

- 2.6.1** The surfaces of door, windows, floors, articles of furniture etc. and such other parts of the building as are not to be distempered shall be protected from being a splashes upon. Such surfaces shall be cleaned of distemper a splashes if any.

**3.0 Mode of measurements & payment :**

- 3.1** Priming coat of distemper, Primer scraping of surface spoiled by smoke soot, removal of oil and greast spots, treatment for infection of effloresces,

mouldmoss, fungi, algae and lichen and patch repairs to plaster shall be included in this item for which nothing extra shall be paid.

**3.2** All the work shall be measured net in the decimal system as in places subject to the following limits unless otherwise stated hereinafter.

- (a) Dimensions shall be measured to the nearest 0.01 m.
- (b) Area in individual items shall be worked out to the nearest 0.01 sq.m. all work shall be measured in sq. meter. No deductions shall be made for ends of joints, beams, posts etc. and openings not exceeding 0.5 sq.m. each and no addition shall be made for reveals, jambs, soffits, sills etc. of these openings nor finish around the ends of joints, beams, posts etc.

**3.3** Deductions of openings exceeding 0.5 sq.m. but not exceeding 3 sq.m. each shall be made as follows and no addition shall be made for reveals, jambs, soffits, sills etc. of these openings :

- (a) When both the faces of wall is provided with the same finish deductions shall be made for one face only.
- (b) When each face of wall is provided with different finish, deduction shall be made for that of frame for doors, windows etc. on which width of reveal is less than that of the other side but no deductions shall be made on the other side. Where the width of reveals on the both the faces of wall are equal, deduction of 50% of area of opening on each face shall be made from area of finish.
- (c) When only one face of wall is treated and the other face is not treated, full deductions shall be made if the width of the reveal on treated side is less than that on untreated side but if the width of the reveals is equal or more than that of untreated side neither deductions nor additions to be made for reveals; jambs, soffits, sills etc.

**3.4** In case of area exceeding 3 sq. m. each, openings of deduction shall be made for opening, but jambs, sills and soffits shall be measured.

**3.5** No deductions shall be made for attachments such as casing, conduits, pipes, electric wiring and the like.

**3.6** Item includes removing nails, making good holes, cracks, patches with materials similar in composition to the distemper.

**3.7** The rate includes cost of all materials, labour, scaffolding, protective measures etc. involved in all the operations described above. This shall also include conveyance, delivery, handling, unloading storing etc.

**3.8** The rate shall be for a unit of one sq. meter.

**18.39** *Distemping with dry (water bound) distemper of approved brand and manufacture (one coat) and of required shade, on decorative wall surface to give an even shade after thoroughly brushing the surface clean of all grease dirt, loose pieces of scales including preparing the surfaces and even sand papered smooth.*

**1.0** **Materials & Workmanship :**

**1.1** The relevant specifications of item No. 18.38 shall be followed except that the dry distemper shall be applied on decorative wall surface in one coat.

**2.0** **Mode of measurements & payment :**

**2.1** The relevant specifications of item No. 18.38 shall be followed.

**2.2** The rate shall be for a unit of one sq. metre.

**18.40** *Extra over item 38 & 39 for every subsequent coat of distemper with dry distemper of approved brand and manufacture.*

**1.0** **Materials & Workmanship :** The relevant specifications of item No. 18.38 shall be followed same except that the extra work for applying subsequent coat of dry distemper is to be carried out over and above the work of item No. 18.38 and 18.39.

**2.0 Mode of measurements & payment :**

**2.1** The relevant specifications of item No. 18.38 shall be followed except that extra rate shall be paid for every subsequent coat applied over and above the rate item No. 18.38 and 18.39.

**2.2** The rate shall be for a unit of one sq. metre.

**18.41** *Extra over item 38 for distempering with dry distemper on ceiling and sloping roofs.*

**1.0 Materials & Workmanship :** The relevant specifications of item No. 18.38 shall be followed except that the dry distempering shall carried out on ceiling and sloping roofs on undecorated surface.

**2.0 Mode of measurements & payment :**

**2.1** The relevant specifications of item No. 18.38 shall be followed except that extra rate shall be paid for carrying out work on ceiling/sloping roof on undecorated surface over and above of item 18.38.

**2.2** The rate shall be for a unit of one sq. metre.

**18.42** *Extra over item 18.40 for distempering with dry distemper on ceiling/sloping roofs.*

**1.0 Materials & Workmanship :**

**1.1** The relevant specifications of item No. 18.39 shall be followed except that the work shall be carried out on ceiling/sloping roofs on decorated surfaces.

**2.0 Mode of measurements & payment :**

**2.1** The relevant specifications of item No. 18.39 shall be followed except that the extra rate shall be paid for the distempering work carried out by dry distemper on ceiling/sloping roofs with decorated surface over and above the rate of item No. 18.39.

**2.2** The rate shall be for a unit of one sq. metre.

**18.44** *Distempering (two coats) with oil bound distemper of approved brand and manufacture and or required shade on undecorated wall surfaces to give an even shade, over and including a priming coat with distemper primer of approved brand and manufacturer after thoroughly brushing the surface free from mortar dropping and other foreign matter also including preparing the surface even and sand papered smooth.*

**1.0 Materials :**

**1.1** Oil bound washable distemper and primer shall be of approved brand and manufacture. The distemper shall be of required colour and shade and the same shall conform to I.S. 428-1969.

**2.0 Workmanship :**

**2.1** Scaffolding : Where scaffolding is required, it shall be erected in such a way that as far as possible no part of scaffolding shall rest against the surface to be distempered. A properly secured strong and well tied suspended platform (Jools) may be used for distempering. Where ladders are used, pieces of old gunny bags shall be tied at top and bottom to prevent scratches to the walls and floors. For distempering to ceiling, proper stage scaffolding shall be erected where necessary.

**2.2 Preparation of surface :**

**2.2.1** The undecorated surface to be distempered shall be thoroughly brushed off from dust, dirt, grease, mortar dropping and other foreign matter and sand papered smooth. New plaster surface shall be allowed to dry for atleast 2 months before applications of distemper.

**2.2.2** All unnecessary nails shall be removed. pitting in plaster shall be made good with plaster of paris mixed with dry distemper of colour to be used. The surface shall then be rubbed down again with a fine grade sand paper and

made smooth. A coat of distemper shall be applied over the patches. The surface shall be allowed to dry thoroughly before the regular coat of distemper is allowed. The surface affected by moulds, moss, fungi algae lichens, efflorescence etc. shall be treated in accordance with I. S. 2395 (Part-I) 1966. Before applying distempering, any unevenness shall be made good by applying putty made of plaster of paris mixed with water on entire surface including filling up the undulation and then sand papering the same after it is dry.

### **2.3 Priming coat :**

**2.3.1** A priming coat or distemper prime of approved manufacture and shade shall be applied over the papered surface in case of new work on undecorated surface. If the distemper priming is done after the wall surface dries completely, the distemper primer shall be applied.

**2.3.2** Application of Primer shall be done as under :

The primer shall be applied with a brush on the clean dry and smooth surface. Horizontal strokes shall be given first and vertical strokes shall be applied immediately afterwards. This entire operation will constitute one coat. The surface shall be finished as uniformly as possible leaving no brush marks. It shall be allowed to dry for atleast 48 hours before oil bound distemper or Paint is applied.

**2.3.3** Oil bound distemper is not recommended to be applied within six months of the completion of wall plaster.

### **2.4 Preparation of oil bound distemper :**

**2.4.1** The distemper shall be diluted with water or any other prescribed thinner in a manner recommended by the manner recommended by the manufacture only. Sufficient quantity of distemper required for a day's work shall be prepared.

### **2.5 Application of Distemper coat :**

**2.5.1** For undecorated surfaces, after the primer coat is dried for atleast 48 hours, the surface shall be lightly sand papered to make it smooth for receiving the distemper, taking care not to rub out the priming coat. All loose particles shall be dusted off after rubbing. Minimum two coats of distemper shall be applied with brushes in horizontal strokes followed immediately by vertical strokes which together shall constitute one coat. The subsequent coats shall be applied after a time interval of atleast 24 hours between consecutive coats to permit proper drying of the preceding coat. The finished surface shall be even and uniform without patches, brush marks, distemper drops etc.

**2.5.2** sufficient quantity of distemper shall be mixed to finish one room at a time. The application of a coat in each room shall be finished in one operation and no work shall be started in any room which cannot be completed on the same day.

**2.5.3** 15 cm. double bristled distemper brush shall be used. After day's work brushes shall be thoroughly washed in hot water soap solution and hung down to dry. Old brushes which are dirty and caked with distemper shall not be used on the work.

**2.6 Protective measurements :** The surfaces of doors, windows, floors, articles of furniture etc. and such other parts of the buildings as are not to be distempered shall be protected from being splashed upon. Such surfaces shall be cleaned of distemper splashes if any.

### **3.0 Mode of measurements & payment :**

**3.1** Priming coat of distemper primer, scraping of surface spoiled by stunk soots removal of oil and grease spots, treatment for infection of effloresces mould

moss, fungi, algae and lichen and patch repairs to plaster shall be included in this item for which nothing extra shall be paid.

**3.2** All the work shall be measured net in the decimal system as in place subject to the following limits unless otherwise stated hereinafter :

- (a) Dimensions shall be measured to the nearest 0.01 m.
- (b) Area in individual items shall be worked out to the nearest 0.01 sq. m. all work shall be measured in sq. metre. No deductions shall be made for ends of joints, beams, posts etc., and openings, not exceeding 0.5 sq.m. each and no addition shall be made for reveals, jambs, soffits, sills etc. of these openings nor for finish around ends of joints, beams, posts etc.

**3.3** Deductions of opening exceeding 0.5 sq.m. but not exceeding 3 m. in each shall be made as follows and net addition shall be made for reveals, jambs, soffits etc. of these openings :

- (a) When both the faces of walls are provided with same finish : deductions shall be made on one face only.
- (b) When each face of wall is provided with different finish, deduction shall be made for that side of frame for doors, windows etc. on which width of reveal is less than that of the other side but no deduction shall be made on the other side. Where the width of reveals on the both the faces of wall are equal, deduction of 50% of area of opening of each face shall be made from area of finish.
- (c) When only one face of wall is treated and the other face is not treated, full deduction shall be made if the width of the reveal on treated side is less than that on untreated sides but if the width of the reveal is equal or more than that on untreated side neither deductions nor addition to be made for reveals, jambs, soffits, sills etc.

**3.4** In case opening of area exceeding 3 sq. m. each, deduction shall be made for openings but jambs, sills and soffits shall be measured.

**3.5** No deductions shall be made for attachments such as casings, conduits, pipes, electric wiring and the like.

**3.6** Item includes removing nails, making good holes, cracks, patches with material similar in composition of distemper.

**3.7** The rate includes cost of all materials, labour, scaffolding, protective measures etc. involved in all the operations described above. This shall also include conveyance, delivery, handling, unloading, storing work etc.

**3.8** The rate shall be for a unit of one sq. metre.

**18.45** *Distemping (two coats) with oil bound washable distemper of approved brand and manufacture and of shade required on undecorated wall surfaces to give an even shade, over and including a priming coat with alkali resistance primer of approved brand and manufacture after thoroughly brushing the surface free from mortar droppings, and other foreign matter and also including preparing the surface even and sand -papered smooth.*

**1.0** **Materials & Workmanship :**

**1.1** The relevant specifications of item No. 18.44 shall be followed except that the primer of alkali resistance primer of approved brand and manufacture shall be used instead of distemper primer.

**2.0** **Mode of measurements & payment :**

**2.1** The mode of measurements and payment shall be the same as for item No. 18.44 above.

**2.2** The rate shall be for a unit of one sq. metre.

**18.46** *Distemping (one coat) with oil bound washable distemper of approved brand of required shade on decorated wall surfaces to give an even shade*

*after thoroughly brushing the surfaces clean of all grease, dirt, loose pieces of scales and also including distempering with oil bound washable distemper of preparing the surface even and smooth;*

**1.0 Materials & Workmanship :** The relevant specifications of item No. 18.44 shall be followed except that distempering with oil bound washable distemper shall be carried out on decorated wall surfaces in one coat.

**2.0 Mode of measurements & payment :**

**2.1** The relevant specifications of item No. 18.44 shall be followed.

**2.2** The rate shall be for a unit of one Sq. metre

**18.47** *Extra over items 18.44 to 18.46 for every subsequent coat of distempering with oil bound washable distemper of approved brand and manufacture.*

**1.0 Materials & Workmanship :**

**1.1** The relevant specification of item No. 18.44 shall be followed except that this work is for providing extra coat of oil bound distempering over and above two coats of distempering.

**2.0 Mode of measurements & payment :**

**2.1** the relevant specifications of item No. 18.44 shall be followed except that the extra rate shall be paid over and above the rate for every subsequent coats over two coats of item 18.44 and 18.46.

**2.2** The rate shall be for a unit of one sq. metre.

**18.48** *Extra over item 18.44, 18.45 for distempering with oil bound washable distemper on ceiling and sloping roofs.*

**1.0 Materials & Workmanship :** The relevant specifications of item No. 18.44 shall be followed except that the distempering shall be carried out on ceiling/sloping roofs.

**2.0 Mode of measurements & payment :**

**2.1** The relevant specifications of item No. 18.44 shall be followed except that the extra rate shall be paid for carrying out distempering work on ceiling/sloping roofs over and above the rate of item No. 18.44 and 18.45.

**2.2** The rate shall be for a unit of one sq. metre.

**18.49** *Extra over item 18.46, 18.47, for every subsequent cost of distempering on ceiling and sloping roofs.*

**1.0 Materials & Workmanship :**

**1.1** The relevant specifications of item No. 18.44 shall be followed except that the distempering work shall be carried out for subsequent coats over item No. 18.46 and 18.47.

**2.0 Mode of measurements & payment :**

**2.1** The relevant specifications of item No. 18.46 shall be followed except that the extra rate shall be paid for every subsequent coat of distemper applied over and above the rate of item No. 18.46 and 18.47

**2.2** The rate shall be for a unit of one sq. metre.

**18.51** *Finishing wall with water proofing cement paint on an undecorated wall surfaces (two coats) to give an approved brand and manufacture and of required shape even shade after thoroughly brushing the surface to remove all dirt and remains of loose powered materials.*

**1.0 Materials :**

**1.1** The water shall conform to M-1. Cement water proofing shall conform to I.S. 5410-1969.

**2.0 Workmanship :**

**2.1** Scaffolding : The relevant specifications of item No. 18.11 shall be followed.

**2.2** Preparation of surface : The relevant specifications of item No. 18.11 shall be followed except that the word white wash colour wash shall be substituted



with water proofing cement paint. The surface shall be thoroughly wetted with clean water before cement water proofing paint is applied.

**2.3** Preparation of paint : Portland cement shall be prepared by adding paint powder to water and stirring to obtain a thick paste, which shall then be diluted to a brushable consistency. Generally, equal volumes of paint powder and water make a satisfactory paint. In all cases, the manufacture's instructions shall be followed. The paint shall be mixed in such quantities as can be used up within an hour of mixing as otherwise the mixture will set and thicken, affecting flowing and finish. The lids of cement paint drums shall be kept tightly when not in use.

**2.4 Application of Paint :**

**2.4.1** No painting shall be done when the paint is likely to be exposed to a temperature of below 7°C within 48 hours after application.

**2.4.2** When weather conditions are such as to cause damage the work shall be carried out "in the shadow" as far as possible. This helps the proper hardening of the paint film by keeping the surface moist for a longer period.

**2.4.3** To maintain the uniform mixture and to prevent segregation, the paint shall be stirred frequently in the bucket.

**2.4.4** For undercoated surfaces, the surfaces shall be treated with minimum two coats of water proof cement paint. Not less than 24 hours shall be allowed between two coats. Next coat shall not be started until the preceding coat has become sufficiently hard to resist marking by the brush being used. In hot dry weather, the preceding coat shall be allowed between two coats. Next coat shall not be started until the preceding coat has become sufficiently hard to resist marking by the brush being used. In hot dry weather, the preceding coat shall be slightly moistened before applying the subsequent coat.

**2.4.5** The finished surface shall be even and uniform in shade, without patches, brush marks, paint drops etc.

**2.4.6** The cement paint shall be applied with a brush with relatively short stiff hog or fibre bristles. The paint shall be brushed in uniform thickness and shall be free from excessive heavy brush marks. The lamps shall be well brushed out.

**2.4.7** Water proof cement paint shall not be applied on surfaces already treated with white wash colour wash, distemper dry or oil bound varnishes, paint etc. It shall not be applied on gypsum, wood and metal surfaces.

**2.5 Curing :** Painted surfaces shall be sprinkled with water two or three times a day. This shall be done between coats and for at least two days following the final coat. The curing shall be started as soon as the paint has hardened so as not to be damaged by the sprinkling of water say about 12 hours after the application.

**2.6** Protection measures shall be taken as per item No. 18.11 para 2.6.

**3.0 Mode of measurements & payments :**

**3.1** The relevant specifications of item No. 18.11 shall be followed.

**3.2** The rate shall be for a unit of one sq. metre.

**18.53** *Extra over item 18.51 for every subsequent coat of water proofing cement point of approved brand and manufacture.*

**1.0 Materials & Workmanship :**

**1.1** The relevant specifications of item No. 18.51 shall be followed except that the work is for applying subsequent coat of cement water proofing paint.

**2.0 Mode of measurements & payment :**

**2.1** The relevant specifications of item No. 18.51 shall be followed except that the extra rate shall be paid for applying every subsequent coat of cement water proofing paint over and above the rate of item No. 18.51.

- 2.2 The rate shall be for a unit of one sq. metre.
- 18.54 *Extra over item 18.51 for finishing with cement paint on ceiling/sloping roofs.***
- 1.0 Materials & Workmanship :**
- 1.1 The relevant specifications of item No. 18.51 shall be followed except that the cement water proofing paint shall applied on ceiling and sloping roofs.
- 2.0 Mode of measurements & payment :**
- 2.1 The relevant specifications of item No. 18.51 shall be followed except that the extra shall be paid for applying cement water proofing paint on ceiling and sloping roofs, over and above the rate of item No. 18.51
- 2.2 The rate shall be for a unit of one sq. metre.
- 18.56 *Extra over item 18.53 for every subsequent coat of finishing with cement paint on ceiling and sloping roofs.***
- 1.0 Materials & Workmanship :**
- 1.1 The relevant specifications of item No. 18.51 shall be followed except that the work shall be carried out for subsequent coat one ceiling and sloping roofs.
- 2.0 Mode of measurements & payment :**
- 2.1 The relevant specifications of item No. 18.53 shall be followed except that extra rate shall be paid for every subsequent coat applied with cement water proofing paint over and above the rate of item No. 18.53.
- 18.57 *Wall painting (two coats) with plastic emulsion paint of approved brand and manufacture on undecorated wall surfaces to give an even shade including thoroughly brushing the surface free from mortar dropping and other foreign matter and sand paper smooth.***
- 1.0 Materials :** Water shall be conform to M-1. The plastic emulsion shall conform to I.S. 5411-1969 (part-I)
- 2.0 Workmanship :**
- 2.1 Scaffolding : The relevant specifications of item No. 18.11 para 2.1. shall be followed.
- 2.2 Preparation of Surface : The relevant specifications of item No. 18.44 para 2.2 shall be followed.
- 2.3 Preparation of Mix : This shall be done as per manufacturers instructions. The thinning of emulsion is to be done with water and not with turpentine. The quantity of thinner to be added shall be as per manufacturer instructions.
- 2.4 Applications :**
- 2.4.1 Before pouring into small containers for use, the paint shall be stirred thoroughly in its container. When applying also, the paint shall be continuously stirred in the smaller container, so that its consistency is kept uniform.
- 2.4.2 The paint shall be laid on evenly and smoothly by meant of crossing and laying off the crossing and laying off consist of covering the area over with paint, brushing the surface hard for the first time over and then brushing alternately in opposite direction two or three times and then finally brushing lightly in a direction at right angles to the same. In this process, no brush marks shall be left after the laying off is finished. No hair marks from the brush or clogging of paint puddles in the corners of panels, angles of mouldings, etc. shall be left on the work. The full process of crossing and laying off will constitute one coat.
- 2.4.3 The paint shall be applied with brush or rollers. For undecorated surfaces, the surface shall be treated with minimum two coats of cement water proofing paint. The second or subsequent coat shall not be started until the preceding coat has become sufficiently hard to resist marking by brush being used.



2.4.4 The surface on finishing shall present a flat velvety smooth finish. It shall be even and uniform in shade without patches, brush marks, paint drops etc.

2.5 Precautions :

- (a) Old brushes if they are to be used with emulsion paints, shall be completely dried of turpentine oil paint by washing in warm soap water. Brushes shall be quickly washed in water immediately after use and kept immersed in water during break periods to prevent the paint from hardening on the brush.
- (b) In the preparation of wall for plastic emulsion painting, no oil base putties shall be used in filling cracks, holes etc.
- (c) Splashes on floors etc. shall be cleaned out without delay as they will be difficult to remove after hardening.
- (d) Washing of surfaces treated with emulsion paint shall not be done within 3 to 4 weeks of application.

2.6 **Protective measures :**

2.6.1 The relevant specifications of item No. 18.17 para 2.3 shall be followed.

3.0 **Mode of measurements & payment :**

3.1 The relevant specifications of item No. 18.11 shall be followed.

3.2 The rate shall be for a unit of one sq. metre.

**18.59 *Extra over item No. 18.57 for every subsequent coat of wall painting with plastic emulsion paint of approved brand.***

1.0 **Materials & Workmanship :**

1.1 The relevant specifications of item No. 18.57 shall be followed except that the painting work shall be for subsequent coat of plastic emulsion paint.

2.0 **Mode of measurements & payment :**

2.1 The relevant specifications of item No. 18.57 shall be followed except that the extra shall be paid for every subsequent coat of plastic emulsion paint applied over and above the rate of item No. 18.57.

2.2 The rate shall be for a unit of one sq. metre.

**18.60 *Extra over item 18.57 for painting with plastic emulsion paint of approved brand on ceiling and sloping roofs.***

1.0 **Materials & Workmanship :**

1.1 The relevant specifications of item No. 18.57 shall be followed except that the painting shall be done on ceiling and sloping roofs.

2.0 **Mode of measurements & payment :**

2.1 The relevant specifications of item No. 18.57 shall be followed except that the extra payment shall be made for applying plastic emulsion paint on ceiling and sloping roofs over and above the rate of item No. 18.57.

2.2 The rate shall be for a unit of one sq. metre.

**18.62 *Extra over item 18.59 for paint on ceiling and sloping roofs.***

1.0 **Materials & Workmanship :**

1.1 The relevant specifications of item No. 18.57 shall be followed except that the work for subsequent coat of plastic emulsion paint will be carried out on ceiling and sloping.

2.0 **Mode of measurements & payment :**

2.1 The relevant specifications of item No. 18.57 shall be followed except that the extra rate shall be paid for carrying out painting on sloping roofs and ceiling with plastic emulsion paint over and above the rate of item No. 18.59

2.2 The rate shall be for a unit of one sq. metre.

## SECTION - 19

### ***DETAILED SPECIFICATIONS OF ITEM - PAINTINGS & POLISHING AS PER "SCHEDULE OF RATES"***

- 19.11** *Painting one coat (excluding priming coat) on previously painted steel and other metal surface with enamel paint, brushing to given and even shade including cleaning the surface of all dirt, dust and other foreign matter.*
- 1.0** **Materials & Workmanship :**
- 1.1** The relevant specifications of item No. 19.7 shall be followed except that painting shall be carried out in one coat with enamel paint on previously painted steel and metal surface.
- 2.0** **Mode of measurements & payment :**
- 2.1** The relevant specifications of item No. 19.7 shall be followed.
- 2.2** The rate shall be for a unit of one sq. metre.
- 19.12** *Applying priming coat over new steel and other metal surfaces after and including preparing the surface by thoroughly cleaning oil, grease, dirt and other foreign matter and secured with brushes, fine steel, wood scrapes and sand paper, with ready mixed priming paint, brushing red lead.*
- 1.0** **Materials :**
- 1.1** The ready mixed primer, brushing red lead shall conform to I. S. 102-1962.
- 1.2** The thinner (linseed oil) shall conform to I.S. 75-1973. If for any reason, thinning is necessary in case of ready mix paint, the brand of thinner recommended by manufacturer shall be used.
- 2.0** **Workmanship :**
- 2.1** **Preparation of surfaces :** The surfaces to be painted shall be cleaned of all rust, scale, dirt and other foreign matter sticking to it with wire brushes, steel wool, scrapers, sand paper etc. This surface shall then be wiped finally with mineral turpentine which shall also removed grease and perspiration of hand marks. The surface shall then be allowed to dry.
- 2.2** **Application of primer :**
- 2.2.1** After the preparation of the surface, the priming coat shall be applied immediately. The brushing operations are to be adjusted to the spreading capacity advised by the manufacturer of the particular primer. The paint shall be applied evenly and smoothly by means of crossing and laying off. The crossing and laying off consists of covering the area over with paint, brushing alternately in opposite directions, two or three times and then finally brushing lightly in a direction at right angles to the same. In this process, no brush marks shall be left after the laying off is finished. The full process of crossing and laying off will constitute one coat.
- 2.2.2** During painting, every time after the priming coat has been worked out of the brush bristles or after the brush has been unloaded of the bristles of the brush shall be opened up by striking the brush against portion of the unpainted surface with the end of the bristles, held at right angles to the surface, so that bristles thereafter will collect the correct amount of paint when dipped again into a paint container. The primary coat shall be allowed to dry completely before painting is started.
- 2.2.3** No hair marks from the brush or clogging at paint puddles in the corner or panels angles of mouldings etc. shall be left on the work.
- 2.2.4** Special care shall be taken while painting over bolts, nuts, rivets overlaps etc.
- 2.2.5** The container when not in use shall be kept close and free from air so that paint does not thickness and also shall be kept guarded from dust.

**3.0 Mode of measurements & payment :**

- 3.1** The new steel and other metal surface shall be measured under this item.
- 3.2** All the work shall be measured not in the decimal system as executed subject to the following limits unless otherwise stated hereinafter :
- (a) dimensions shall be measured to the nearest 0.01 metre.
- (b) Areas shall be worked out to the nearest 0.01 Sq. metre.
- 3.3** No deductions shall be made for openings not exceeding 0.5 sq. mt. each and no addition shall be made for painting to beadings, mouldings, edges, jambs, soffits, etc. of such opening.
- 3.4** In case of fabricated structural steel and iron work, priming coat of paint shall be included with fabrication. In case of trusses if measured in sq. m. compound girders, stanchions, Lattices, girder and similar work, actual area shall be measured in sq. M. and no extra shall be paid for painting on bolts, heads, nuts, washers etc. No addition shall be made to the weight calculated for the purpose of measurements of steel and iron works for paint applied on shop or at site.
- 3.5** The different surfaces shall be grouped into one general item, areas of uneven surface being converted into equivalent plain areas in accordance with the table given as per Annexure II for payment.
- 3.6** The rate shall be for a unit of one sq. metre.
- 19.7** *Painting two coats (excluding priming coat) on new steel and other metal surfaces with enamel paint, brushing, interior to given an even shade including cleaning the surface of all dirt, dust and other foreign matter.*

**1.0 Materials :** The enamel paint shall conform to M-44 B.

**2.0 Workmanship :**

**2.1 General :**

- 2.1.1** The materials required for work of painting work shall be obtained directly from approved manufacturers or approved dealer and brought to the site in maker's drums, kege etc. with seal unbroken.
- 2.1.2** All materials not in actual use shall be kept properly protected, lids of containers shall be kept closed and surface of paint in open or partially open containers covered with a thin layer of turpentine to prevent formation of skin. The materials which have become stale or flat due to improper and long storage shall not be used. The paint shall be stirred thoroughly in its container before pouring into small containers. While applying also the paint shall be continuously stirred in smaller container. No left over paint shall be put back into stock tins. When not in use, the containers shall be kept properly closed.
- 2.1.3** If for any seasons, thinning is necessary, the brand of thinner recommended by the manufacturer shall be used.
- 2.1.4** The surface to be painted shall be thoroughly cleaned and dusted. All rust, dirt and grease shall be thoroughly removed before painting is started. No painting on exterior or other exposed parts of the work shall be carried out in wet, damp or otherwise unfavourable weather and all the surfaces shall be thoroughly dry before painting work is started.

**2.2 Application :**

- 2.2.1** Brushing operations are to be adjusted to the spreading capacity advised by the manufacture of particular paint. The paint shall be applied evenly and smoothly by means of crossing and laying off. The crossing and laying off consists of covering the area over with paint, brushing the surface hard for the first time over and then brushing alternately in opposite directions two or three times and then finally brushing lightly in direction at right angles to the same.

In this process, no brush marks shall be left after the laying off is finished. The full process of crossing and laying off will constitute one coat.

**2.2.2** Each coat shall be allowed to dry completely and lightly rubbed with very fine grade of sand paper and loose particles brushed off before next coat is applied. Each coat shall vary slightly in shade and shall be got approved from Engineer-in-charge before next coat is started.

**2.2.3** Each coat except the last coat shall be lightly rubbed down with sand-paper of fine pumice stone and cleaned of dust before the next coat is applied. No hair marks from the brush or clogging of paint puddles in the corners of panels angles of mouldings etc. shall be left on the work.

**2.2.4** special care shall be taken while painting over bolts, nuts, rivets, overlaps etc. Approved best quality brushes shall be used.

**3.0 Mode of measurements & payment :**

**3.1** The relevant specifications of item No. 19.12 shall be followed for mode of measurements and payment. The rate is excluding priming coat.

**3.2** The rate shall be for a unit of one sq. metre.

**19.15** *Extra over item No. 19.7 and 19.11 for every subsequent coat of paint.*

**1.0 Materials & Workmanship :**

**1.1** The relevant specifications of item No. 19.7 shall be followed except that the work of painting shall be carried out for subsequent coat.

**2.0 Mode of measurements & payment :**

**2.1** The relevant specifications of item No. 19.7 shall be followed except that the extra rate shall be paid for every subsequent coat of paints applied over and above the rate of item No. 19.7 and 19.11.

**2.2** The rate shall be for a unit of one sq. metre.

**19.19** *Painting two coats (excluding priming coat) on new steel and other metal surface with synthetic enamel paint, brushing to give an even shade including cleaning the surface of all dirt, dust and other foreign matter.*

**1.0 Materials :** Synthetic enamel paint shall conform to I. S. 1932-1964.

**2.0 Workmanship :**

**2.1** The relevant specifications of item No. 19.7 shall be followed except that the painting shall be carried out with synthetic enamel paint.

**3.0 Mode of measurements & payment :**

**3.1** The relevant specifications of item No. 19.7 shall be followed.

**3.2** The rate shall be for a unit of one sq. metre.

**19.21** *Painting one coat (excluding priming coat) on previously painted steel and other metal surfaces with synthetic enamel paint brushing to give an even shade including cleaning the surface of all dirt, dust and other foreign matter.*

**1.0 Materials & Workmanship :**

**1.1** The relevant specifications of item No. 19.19 shall be followed except that the painting shall be carried out on previously painted steel and other metal surfaces using synthetic enamel paint in one coat.

**2.0 Mode of measurements & payment :**

**2.1** The relevant specifications of item No. 19.19 shall be followed.

**2.2** The rate shall be for a unit of one sq. metre.

**19.23** *Extra over item No. 19.19 and 19.21 for every subsequent coat of paint.*

**1.0 Materials & Workmanship :**

**1.1** The relevant specifications of item No. 19.19 shall be followed except that the work shall be carried out for subsequent coat of paint.

**2.0 Mode of measurements & payment :**

- 2.1 The relevant specifications of item No. 19.19 shall be followed except that the extra rate shall be paid for applying subsequent coat of paint over and above the item No. 19.19 and 19.21.
- 19.50 (B) *Painting two coats (excluding priming coat) on external surfaces of new rain water, soil, waste and vent pipes and fittings with ready mixed bituminous paint brushing, black anticorrosive to give an even shade including cleaning of all dirt, dust and other foreign matter (75 mm. dia.)***
- 1.0 Materials :**
- 1.1 Ready mixed bituminous paint shall conform to I.S. 158 : 1968.
- 2.0 Workmanship :**
- 2.1 The relevant specifications of item No. 19.7 shall be followed except that the painting work of external surfaces of 75 mm. dia. rain water pipe, soil, waste and vent pipe and fitting with ready mixed bituminous paint shall be carried out.
- 3.0 Mode of measurements & payment :**
- 3.1 The rate is excluding the cost of priming coat but including painting of all fittings coming in line.
- 3.2 The rate shall be for a unit of one running metre.
- 19.50 (C) *Painting two coats (excluding priming coat) on external surfaces of rain water, soil waste and vent pipe and fittings with ready mixed bituminous paint brushing, black anticorrosive to give an even shade including cleaning off all dirt dust and other foreign matter : 100 mm. dia.***
- 1.0 Materials & Workmanship :**
- 1.1 The relevant specifications of item No. 19.50 (B) shall be followed except that the pipes to be painted on is 100 mm. dia. metre.
- 2.0 Mode of measurements & payment :**
- 2.1 The relevant specifications of item No. 19.50 (B) shall be followed. The rate is excluding the cost of priming coat but including cost of painting all fitting coming in line.
- 2.2 The rate shall be for a running metre.
- 19.59 (B) *Applying priming coat over new wood and based surfaces after and including preparing the surface by thoroughly cleaning of dirt grease, dust and other foreign matter, sand papering and knotting : Ready mixed paint, brushing wood primer pink.***
- 1.0 Materials :**
- 1.1 The ready mixed paint, brushing, wood primer pink shall conform to I.S. 3536-1966.
- 2.0 Workmanship :**
- 2.1 Preparation of Surfaces:
- 2.2.1 All wood work shall be dry and free from any foreign matter incidental to building operations. Nails shall be punched well below the surface to provide a firm key for stopping. Mouldings shall be carefully smoothed with abrasive paper and projecting fibres shall be removed. Flat portion shall be smoothed off with abrasive paper used across the grain prior to painting and with the grain prior to staining or if the wood is to be left in its natural colour, wood work which is to be stained may be smoothed to scraping instead of by glass papering if so required.
- 2.2.2 Any knots, resinous or streaks or blueish sap wood that are not large enough to justify cutting out shall be treated with two coats of pure shellac knotting applied thinly and extended about 25 mm. beyond the actual area requiring treatment.
- 2.2 Application of primer :**

2.2.1 The relevant specifications of item No. 19.12 (A) shall be followed for application of primer.

**3.0 Mode of measurements & payment :**

3.1 The relevant specifications of item No. 19.32 shall be followed except that work done on wood and wood based surfaces shall be paid under this item.

3.2 The rate shall be for a unit of one sq. metre.

**19.59 (D) Applying priming coat over new wood and wood based surface after and including preparing the surface by thoroughly cleaning oil, grease, dirt and other foreign matter sand papering and knotting; Ready mixed paint brushing priming, for enamel.**

**1.0 Materials :**

1.1 The ready mixed paint for brushing priming for enamels wood shall conform to I.S. 106-1962.

**2.0 Workmanship :**

2.1 The relevant specifications of item No. 19.59 (B) shall be followed except that ready mixed paint brushing priming for enamel shall be used instead of ready mixed paint brushing wood primer pink.

**3.0 Mode of measurements & payment :**

3.1 The relevant specifications of item No. 19.2 shall be followed.

3.2 The rate shall be for a unit of one sq. metre.

**19.62 (B) Extra over item 19.59 (B) for every subsequent coat of priming coat. Ready mix paint brushing wood primer pink.**

**1.0 Materials & Workmanship :**

1.1 The relevant specifications of item No. 19.59 (B) shall be followed except that the painting work shall be carried out with ready mix paint brushing wood prime, pink for subsequent coat.

**2.0 Mode of measurements & payment :**

2.1 The relevant specifications of item No. 19.59 (B) shall be followed except that the extra rate shall be paid for every subsequent coat applied with Ready mix paint; brushing wood primer pink over and above the rate of item No. 19.59 (B).

**19.62 (c) Extra over item No. 19.59 (c) for every subsequent coat of priming coat ready mix paint brushing priming for enamel.**

**1.0 Materials & Workmanship :**

1.1 The relevant specifications of item No. 19.59 (C) shall be followed except that the painting work shall be carried out with ready mix paint brushing priming for enamel.

**2.0 Mode of measurements & payment :**

2.1 The relevant specifications of item No. 19.59 (C) shall be followed except that the extra shall be paid for every subsequent coats of priming coat with ready mixed paint, brushing priming for enamel.

2.2 The rate shall be for a unit of one sq. metre.

**19.71 Painting two coats (excluding priming coat) on new wood and wood based surfaces with enamel paint interior to give an even shade including cleaning the surface off all dirt, dust and other foreign matter sand papering and slopping.**

**1.0 Materials :**

1.1 The enamel paint shall conform to I.S. 133-1975.

**2.0 Workmanship :**

2.1 The relevant specifications of item No. 19.7 shall be followed for general and applications of paint, except that the enamel paint shall be used for painting on new wood/wood based surfaces.



- 2.2 In painting doors and windows the putty, round the glass panes also be painted but care shall be taken to see that no paint, stain etc. are left on the glass. Top of shutters and surfaces in similar hidden locations shall not be left out in painting.
- 3.0 Mode of measurements & payment :**
- 3.1 The relevant specifications of item No. 19.12 shall be followed, for mode of measurements and payments. The rate excludes cost of priming coat.
- 3.2 The rate shall be for a unit of one sq. metre.
- 19.73 *Painting one coat (excluding priming coat) on previously painted wood and wood based surfaces with enamel paint to give even shade including cleaning of all dirt, dust and other foreign matter.***
- 1.0 Materials & Workmanship :**
- 1.1 The relevant specifications of item No. 19.71 shall be followed except that the painting work shall be carried out on previously painted wood and wood based surfaces with enamel paint to give even shade in one coat.
- 2.0 Mode of measurements & payment :**
- 2.1 The relevant specifications of item No. 19.71 shall be followed.
- 2.2 The rate shall be for a unit of one sq. metre.
- 19.75 *Extra over item 19.71 and 19.73 for every subsequent coat of paint.***
- 1.0 Materials & Workmanship :**
- 1.1 The relevant specifications of item No. 19.71 shall be followed except that painting work shall be for subsequent coat with paint.
- 2.0 Mode of measurements & payment :**
- 2.1 The relevant specifications of item No. 19.71 shall be followed except that the extra rate shall be paid for every subsequent coat applied over and above the item No. 19.71 and 19.73.
- 2.2 The rate shall be for a unit of one sq. metre.
- 19.77 *Painting two coats (excluding priming coat) on new wood and wood based surfaces with of ready mixed paint brushing, oil gloss, semi-gloss, to give an even shade including cleaning all dust, dirt and other foreign matter sand papering and stopping.***
- 1.0 Materials :** The ready mixed paint shall conform to M-44. The ready mixed paint brushing gloss, semi-gloss shall conform to I.S. 129-1962 and I.S. 117-1964.
- 2.0 Workmanship :**
- 2.1 The relevant specifications of item No. 19.71 shall be followed for general and application of paint except that ready mixed paint brushing, oil gloss and semi-gloss shall be used of approved colour and shade instead of enamel paint.
- 3.0 Mode of measurements & payment :**
- 3.1 The relevant specifications of item No. 19.12 shall be followed for measurements and payment. The rate excludes cost of priming coat.
- 3.2 The rate shall be for a unit of one sq. metre.
- 19.84 *Varnishing two coat (excluding priming coat) on new wood and wood based surfaces undercoating with flattening varnish and finishing coat varnish to give an even surface of all dirt, dust and sand papering so as to produce a smooth dry surface.***
- 1.0 Materials :** The varnish shall conform I.S. 338-1962.
- 2.0 Mode of measurements & payment :**
- 2.1.1 The surface to be varnished shall be prepared to produce a smooth, dry neat surface. The previous coat of paint or stain, if any shall be allowed to dry and rubbed down slightly wiped off and allowed to dry.

**2.1.2** The operations of varnishing calls for careful attention to cleanliness. All dust and dirt shall be removed from the surface to be varnished and also from the neighbourhood. If surfaces are dampened to avoid raising of dust, they shall be allowed to dry thoroughly before varnishing is commenced. Damp atmosphere and draughts shall be avoided. For exterior work, a normal dry day should be chosen. Exposure to extreme of heat or cold, or to a damp atmosphere will spoil the work.

**2.1.3** In handling and applying varnish care should be taken to avoid forming forth or air bubbles. Brushes and containers shall be kept scrupulously clean.

## **2.2 Applications :**

**2.2.1** The varnish shall be applied liberally with a brush and spread evenly over a portion of the surface with a short light strokes to avoid frothing. It shall be allowed to flow out while the next section is being laid in. Excess varnish then be scrapped out of the brush and the first section be crossed recrossed and then laid off lightly. Too much or too little varnish left on the surface will mar the appearance of the finish. The varnish, once it has begun to set, shall not be retouched. If a mistake is made, the varnish shall be removed and the work started a fresh.

**2.2.2** In case of two coats of varnish work, the first shall be hard drying, undercoating or flattening varnish, this shall be allowed to dry hard and then be flattening down before applying the finishing coat. If two coats are applied, sufficient time shall be allowed between two coats.

**2.2.3** When flat varnish is used for finishing a preparatory coat of hard drying under coating of flattening varnish shall be first applied and shall be allowed to harden thoroughly. It shall then be lightly rubbed down before the flat varnish is applied. Section of the work such as panels, shall be cut in clearly, so as to avoid any overlapping during applications, as this is likely to impart some measure, of gloss to partially dried area, worked up in lapping. On large area the flat varnish shall be applied rapidly and the edges of each patch applied shall not be allowed to set but shall be followed up whilst in free working conditions.

## **3.0 Mode of measurements & payment :**

**3.1** The relevant specifications of item No. 19.71 shall be followed.

**3.2** The rate shall be for a unit of one sq. metre.

**19.86** *Extra over item 19.84 for every subsequent coat of varnish.*

## **1.0 Materials & Workmanship :**

**1.1** The relevant specifications of item No. 19.84 shall be followed except that the work shall be for a subsequent coat of varnishing.

## **2.0 Mode of measurements & payment :**

**2.1** The relevant specifications of item No. 19.84 shall be followed except that the extra rate shall be paid for every subsequent coat of varnishing done over and above the rate of item No. 19.84

**2.2** The rate shall be for a unit of one sq. metre.

**19.87** *Polishing with French polish on new wood and wood based surface to give an even surface including cleaning the surface of all dirt, dust and sand papered smooth and including a coat of wood filler.*

## **1.0 Materials :**

**1.1** The French polish of required tint and shade shall be prepared with the below mentioned ingredients and other necessary materials : (i) Denatured spirit of approved quality (ii) Chadras (iii) Shellac (iv) Pigment. The french polish so prepared shall conform to I. S. 348-1968.

## **2.0 Workmanship :**



- 2.1 Preparation of Surface :**
- 2.1.1** All unevenness shall be rubbed down to smoothness with the paper and the surface shall be well dusted. The pores in the wood shall be filled up with a filler made of paste of whiting in water or methlylated spirit (with a suitable pigment like burnt sienna or umber if required) : Otherwise the French polish will get absorbed and a good gloss will be difficult to obtain.
- 2.2 Application :**
- 2.2.1** A pad of woolen cloth covered by a fine cloth shall be used to apply the polish. The pad shall be moistened with polish and rubbed hard on the surface in a series of over lapping circles applying the polish sparingly but uniformly over the entire area to give an even surface. A trace of linseed oil on the face of the pad shall be covered with a fresh piece of clean fine cloth, slightly damped with methylated spirit and rubbed lightly and quickly with circular motions. The finished surface shall present a uniform texture and high gloss.
- 3.0 Mode of measurements & payment :**
- 3.1** The relevant specifications of item No. 19.12 shall be followed for mode of measurements and payment.
- 3.2** The rate includes cost of wood filler etc. complete.
- 3.3** The rate shall be for a unit of one sq. metre.
- 19.88 *Polishing with french polish on previously polished wood and wood based surface to give an even surface including cleaning the surface of all dirt, dust and sand papered smooth including a coat of wood filler.***
- 1.0 Materials & Workmanship :**
- 1.1** The relevant specifications of item No. 19.87 shall be followed except that the french polish will be applied on previously polished wood and wood based surface.
- 2.0 Mode of measurements & payment :**
- 2.1** The relevant specifications of item No. 19.87 shall be followed.
- 2.2** The rate shall be for a unit of one sq. metre.
- 19.91 *Applying wax polish on new wood work and wood based surfaces with bee's wax polish in proportion 2:1, 5:1, 05:05 (2 Bess Wax, 1.5 linseed oil : 1 Turpentine oil : 0.5 Varnish by weight) to give an even surface including cleaning the surface of all dirt, dust and sand papered smooth.***
- 1.0 Materials :** Bee's Wax shall conform to I.S. : 1504-1968 Linseed oil shall conform to I.S. 75-1967. Turpentine shall conform to I.S. 83-1950. Varnish shall conform to I.S. 337-1952.
- 2.0 Workmanship :**
- 2.1 Preparation of bees wax :**
- 2.1.1** In case of bees wax it shall be prepared locally with following specifications :
- 2.1.2** Pure bees wax free paraffin or stearine adulterants shall be used. The polish shall be prepared from mixture of bees wax, linseed oil, turpentine and varnish in proportion 2 : 1.5 : 1 : 0.5 by weight. The bees wax and boiled linseed oil shall be heated over a slow fire. When the wax is completely dissolved the mixture shall be cooled till it is just warn and turpentine and varnish added to it in the required proportions and entire mixture shall be well stirred.
- 2.0 Preparation of surfaces :**
- 2.1.1** The surface to be waxed shall be prepared to produce a smooth dry neat surface. Previous coat of paint or stain of any shall be allowed to dry and be rubbed down lightly wiped off and all allowed to dry. All dust and dirt shall be removed from the surface to be waxed, and also from the neighbourhood. Damp atmosphere and draughts shall be avoided. For waxing, normal dry day shall be chosen.

**2.3 Application :**

**2.3.1** The polish shall be applied evenly with clean soft pad of cotton cloth in such a way that the surface is completely and fully covered. The surface shall then be rubbed continuously for half an hour. After well rubbing in one coat of wax polish, the work shall be covered with dust proof sheet. (Cloth for preventing dust falling on the work.) Subsequent coat shall be applied after the surface is quite dry and shall be rubbed off with soft fiannel until the surface has assumed a uniform gloss and in dry showing no sign of stickness.

**2.3.2** The final polish depends largely on the amount of rubbing which shall be continuous and with uniform pressure with frequent changes in the direction.

**3.0 Mode of measurements & payment :**

**3.1** The relevant specifications of item No. 19.12 shall be followed.

**3.2** The rate shall be for a unit of one sq. metre.

**19.92** *Applying wax polish on previous wax polished wood and wood based surfaces with bess, wax polish in proportion of 1 : 1.5 : 1 : 0.5 (2 Bess wax 1.5 linseed oil : 1 Turpentine : 0.5 Varnish by weight) to give an even surface including cleaning the surface of all dirt, dust and sand papered smooth.*

**1.0 Materials & Workmanship :**

**1.1** The relevant specifications of item No. 19.91 shall be followed except that the wax polishing shall be carried out on previously was polished wood and wood based surfaces with bess wax polish.

**2.0 Mode of measurements & payment :**

**2.1** The relevant specifications of item No. 19.91 shall be followed.

**2.2** The rate shall be for a unit of one sq. metre.

**19.98** *Coal tarring two coats on new wood and wood based surfaces using 0.15 and 0.12 litres of coal tar per sq. m. in the first and second coat respectively to give an even shade including cleaning of all dirt, dust and other foreign matter :*

**1.0 Materials :** The coal tar shall conform to I.S. 2901-1961.

**2.0 Workmanship :**

**2.1** 200 Cms. of unslaked lime shall be added to every litre of coal tar and heated till it begins to boil. It shall be taken off the fire and kerosene oil added to it slowly at the rate of 1 part kerosene oil and 6 parts or more parts of coal tar by volume and stirred thoroughly. The addition of lime is for preventing the tar from runnings.

**2.2 Preparation of surface :**

**2.2.1** The surface to be painted shall be allowed to dry sufficiently. Any existing fungus of mould growth shall be completely removed. All major cracks or defects in the plaster shall be cut out and made good. Before primer is applied, holes and undulations shall be filled up with plaster of paris and rubbed smooth.

**2.3 Application of paint :**

**2.3.1** The coal tar shall be applied as per relevant specifications of applying mixed paint item No. 19.7 except coal tarring is used instead of enamel paint.

**3.0 Mode of measurements & payment :**

**3.1** The relevant specifications of item No. 19.12 shall be followed.

**3.2** The rate shall be for a unit of one sq. metre.

**19.119** *(I) Writing letter of figures on any surface with black Japan paint (stops, comas, hyphens and the like not be measured and paid for separately) : block (Letters/figures).*

**1.0 Materials :**

- 1.1 Ready mixed the black Japan paint shall conform to I. S. 341-1952.
- 2.0 Workmanship :**
- 2.1 The letters and figures shall be to the heights and widths as per approved drawings or as directed. These shall be stenciled or drawn in pencil and got approved before painting. They shall be of uniform size and finished neatly. The edges shall be straight or in pleasant smooth curves.
- 3.0 Mode of measurements & payment :**
- 3.1 Letters, figures and similar items etc. stops, commas, hyphens and the like shall be deemed to be included in the item.
- 3.2 The rate per cm. height of letter shall hold good irrespective of width of the letters of figures or the thickness of the lettering.
- 3.3 The rate shall be for a unit of per letter per cm. height.
- 19.119 (II) Writing letter of figures on any surface with black Japan paint stops, commas, hyphens and the like not be measured and paid for separations : Indian Letters/figures.**
- 1.0 Materials & Workmanship :** The relevant specifications of item No. 19.119 (I) shall be followed except the writing of letters shall be Indian letters/figures.
- 2.0 Mode of measurements & payment :**
- 2.1 The relevant specifications of item No. 19.119 (I) shall be followed.
- 2.2 The rate shall be for a unit of per letter per cm. height.
- 19.126 (I) Painting lines, dashes, arrows, letters etc. on roads, air fields, and like in two coats with road marking paint, brushing including the surface of all dirt, dust and other foreign matter : Over 10 cms in width.**
- 1.0 Materials :**
- 1.1 The road marking paint shall conform to I. S. 164-1951.
- 2.0 Workmanship :**
- 2.1 The relevant specifications of item No. 19.119 (I) shall be followed except that the painting lines, dashes arrows and letters on roads, air fields and like shall be carried out with road marking paint in two coats : over 10 cms. in width.
- 2.0 Mode of measurements & payment :**
- 2.1 The relevant specifications of item No. 19.119 (I) shall be followed.
- 2.2 The rate shall be for a unit of one sq. metre.
- 19.126 (II) Painting lines, dashes, arrows, letters etc. on roads, fields and like in two coats with road making paint brushing including cleaning the surface of all dirt, dust and other foreign matter : Upto 10 cms. in width.**
- 1.0 Materials & Workmanship :**
- 1.1 The relevant specifications of item No. 12, 126 (I) shall be followed except that painting work shall be upto 10 cms. width.
- 2.0 Mode of measurements & payment :**
- 2.1 The relevant specifications of item No. 19.119 (I) shall be followed.
- 2.2 The rate shall be for a unit of one running metre.
- 19.127 (A) Painting lines, dashes, arrows, letters etc. on roads, airfields and like in one coat with road marking paint, brushing including cleaning the surface of all dirt, dust and other foreign matter : over 10 cms. in width.**
- 1.0 Materials & Workmanship :** The relevant specifications of item No. 19.126 (I) shall be followed except that the painting shall be done in one coat over 10 cms. in width.
- 2.0 Mode of measurements & payment :**
- 2.1 The relevant specifications of item No. 19.126 (I) shall be followed.
- 2.2 The rate shall be for a unit of one sq. metre.

**19.127 (B) *Painting lines, dashes, arrows, letters etc. on roads air fields and like in one coat with road making paint, brushing including cleaning the surface of all dirt, dust and other foreign matter : Upto 10 cms. in width.***

**1.0 Materials & Workmanship :**

**1.1** The relevant specifications of item No. 19.126 (I) shall be followed except that the painting shall be done in one coat upon 10 cms. in width.

**2.0 Mode of measurements & payment :**

**2.1** The relevant specifications of item No. 19.126 (I) shall be followed.

**2.2** The rate shall be for a unit of one running metre.

**SECTION - 20**

***DETAILED SPECIFICATIONS FOR DEMOLITION & DISMANTLING  
AS PER "SCHEDULE OF RATES"***

**20.1 (I) *Demolition and disposal of unserviceable materials with all leads and lifts : Lime Concrete.***

**1.0 Workmanship :**

**1.1** The demolition shall consist of demolition of one or more parts of the building as specified or shown in the drawings. Demolition implies taking up or down or breaking up. This shall consist of demolishing whole or part of work including all relevant item as specified or shown in the drawings.

**1.2** The demolition shall always be planned before hand and shall be done in reverse order of the one in which the structure was constructed. This scheme shall be got approved from the Engineer-in-charge before starting the work. This however will not absolve the contractor from the responsibility of proper and safe demolition.

**1.3** Necessary dropping, shoring and under pinning shall be provided for the safety of the adjoining work or property, which is to be left intact, before dismantling and demolishing is taken up and the work shall be carried out in such a way that no damages is caused to the adjoining property.

**1.4** Wherever required, temporary enclosures or partitions shall also be provide 1. Necessary precautions shall be taken to keep the dust nuisance down as and where necessary.

**1.5** Dismantling shall be commenced in a systematic manner. All materials which are likely to be damaged by dropping from a height or demolishing roof, masonry etc. shall be carefully dismantled first. The dismantled articles shall be properly stacked as directed.

**1.6** All materials obtained from demolition shall be the property of Government unless otherwise specified and shall be kept in safe custody until handed over to the Engineer-in-charge.

**1.7** Any serviceable materials, obtained during dismantling or demolition shall be separated out and stacked properly as directed, with all lead and lift. All unserviceable materials, rubbish etc. shall b stacked as directed by the Engineer-in-charge.

**1.8** On completion of work, the site shall be cleared of all debris rubbish and cleaned as directed.

**2.0 Mode of measurements & payment :**

**2.1** Measurements of all work except hidden work shall be taken before demolition dismantling and no allowance for increase in bulk shall be allowed. The demolition of lime concrete shall be measured under this item. Specification for deduction for voids, openings etc. shall be on same basis as that employed for construction of work.

- 2.2 All work shall be measured in decimal system as fixed in its place subject to the following limits, unless otherwise stated hereinafter : (a) Dimensions shall be measured to the nearest 0.01 mt. (b) Area shall be worked out to the nearest 0.01 sq. mt. (c) Cubical connection shall be worked out to the nearest 0.01 Cu.m.
- 2.3 the rate shall include cost of all labour involved and tools used in demolishing and dismantling including scaffolding. The rate shall also include the charges for separating out and stacking the serviceable materials properly and disposing the unserviceable materials with all lead and lift. The rate also includes for temporary storing for the safety of the portion not required to be pulled down or of adjoining property and providing temporary enclosures or partitions where considered necessary.
- 2.4 The rate shall be for a unit of one cubic metre.
- 20.1 ***(II) Demolition and disposal of unserviceable materials with all leads and lifts. Unreinforced cement concrete.***
- 1.0 **Workmanship :** The relevant specifications of item 10.1 (i) shall be followed except that the unreinforced cement concrete work is to be demolished instead of lime concrete.
- 2.0 **Mode of measurements & payment :**
- 2.1 The relevant specifications of item No. 20.1 (I) shall be followed.
- 2.2 The rate shall be for a unit of one cubic metre.
- 20.3 ***Demolition including stacking of serviceable materials and disposal or unserviceable materials with all leads and lifts : R.C.C. work.***
- 1.0 **Workmanship :**
- 1.1 The relevant specifications of item No. 20.1 (I) shall be followed except that demolition of R.C.C. work is to be done.
- 2.0 **Mode of measurements & payment :**
- 2.1 The relevant specification of item No. 20.1 shall be followed except that the demolition of reinforced concrete structure. The unserviceable materials shall be disposed of at all leads and lifts. The rate excludes scraping straightening of reinforcement but includes cutting of reinforcement.
- 2.2 The rate shall be for a unit of one cubic metre.
- 20.11 ***(II) Demolition of brick work and stone masonry including stacking of serviceable materials and disposal of unserviceable materials with all leads and lifts : in lime mortar.***
- 1.0 **Workmanship :**
- 1.1 The relevant specifications of item No. 20.1 (I) shall be followed except that demolition of brick or stone masonry in lime mortar is to be done.
- 2.0 **Mode of measurements & payment :**
- 2.1 The relevant specifications of item No. 20.1 (I) shall be followed except that the wall and independent piers of columns of brick or stone masonry shall be measured in cubic metres. All copings, corbels, cornices and other projections shall be included with the wall measurements.
- 2.2 In measuring thickness plastered walls, the thickness of plaster shall be included. The unserviceable materials shall be disposed off with all lead and lift. Ashlar face stones dressed stone etc. if required to be taken down intact shall be dismantled and measured separately in cubic metres.
- 2.3 The rate is exclusive of cleaning of bricks or stones. Honey comb works or hollow block walling shall be measured as solid.
- 2.4 The rate shall be for a unit of one cubic metre.

**20.11 (II) Demolition of brick work and stone masonry including stacking of serviceable materials and disposal of unserviceable materials with all leads and lifts : in cement mortar.**

**1.0 Workmanship :** The relevant specifications of item No 20.1(I) shall be followed except demolition of brick or stone masonry in cement mortar is to be done

**2.0 Mode of measurement & payment :**

**2.1** The relevant specifications of item NO 20.11 (II) shall be followed. The unserviceable material shall be stacked as directed by Engineer - in - Charge with all leads and lifts.

**20.21 Demolition in terrace including stacking of serviceable materials and disposal of unserviceable materials with all lead material with all lead and lift : Brick tiles covering**

**1.0 Materials:**

**1.1** The relevant specifications of item no 20.1 (I) shall be followed except that the demolition of terrace brick tiles is to be done .

**2.0 Mode of measurement & payment :**

**2.1** The relevant specifications of item no 20.1 (I) shall be followed except that the brick tiles covering of terrace shall be measured in sq. Mt . The unserviceable materials shall be stacked as directed as all leads and lifts.

**2.2** The rate shall be for a unit of one sq . meter.

**20.23 Dismantling tiled or stone floors laid in mortar including stacking of serviceable material and disposal of uservicalble material with all lead and lifts**

**1.0 Workmanship:**

**1.1** The relevant specifications of item no 20.1 (I) shall be followed except the dismantling of tiled or stone floors laid on mortars shall be done Dismantling implies carefully taking up or down or these are fixed by nail screws bolts etc. the shall be taken out with proper tools

**2.0 Mode of measurement & Payment :**

**2.1** The supporting materials such as joints beams if any etc. shall be measured separately the relevant specification of item no 20.1 (I) shall be followed. The rate shall include stacking the unserviceable materials as directed will lead and lift.

**2.2** The rate shall be for a unit of one sq. meter

**20.25 Dismantling of wooden floors including stacking of serviceable materials and disposal of unserviceable materials with all lead and lifts.**

**1.0 Materials :**

**1.1** The relevant specification of item No 20.1(I) shall be followed except that wooden floors shall be followed except that wooden floors shall be dismantled.

**2.0 Mode of Measurement & Payment :**

**2.1** The relevant specifications of item No 20.1 (I) shall be followed. The supporting members such as joints beams etc. shall be measured separately the rate including disposable of unserviceable materials as directed with all lead all lead and lift.

**2.2** The rate shall be for a unit of one sq meter

**20.27 (I) Dismantling of sheet roofing including ridges ships valleys gutters etc . striking of serviceable material and is of unserviceable materials with all leads and lift G. I sheet roofing.**

**1.0 Materials :**



- 1.1 The relevant specifications of item No 20.1 (I) shall be followed except that G.I. sheet roofing shall be dismantled instead work.
- 2.0 Mode of measurement & payment:**
- 2.1 The area of G.I. sheet roofing shall be measured in sq. meter. Ridge hips and valley shall be girthed and included with roof area. Corrugated and semi-corrugated surfaces shall be measured flat and not girthed.
- 2.2 Supporting memorial such as rafter purlins beams joints trusses etc shall be measured separately.
- 2.3 The rate shall include disposal of unserviceable materials with all leads and lift and stacking the serviceable materials as directed.
- 2.4 The rate shall be for a unit of one sq. meter.
- 20.27 (II) Dismantling of sheet roofing including ridges hips valleys gutters etc stacking or serviceable material and disposal of unserviceable material with all leads and lift : A.C sheet roofing**
- 1.0 Workmanship :**
- 1.1 The relevant specifications of item No. 20.1 (I) Shall be followed except the dismantling work of A C sheet roofing is to be done.
- 2.0 Mode of measurement & payment:**
- 2.1 The relevant specifications of item NO 20.27 Ii) shall be followed except that the A.C. sheets roofing shall be measured in this item
- 2.2 The rate shall be for a unit of sq. meter.
- 20.28 Dismantling Mangalore or country tile roofing with battens boarding etc. including of serviceable materials and disposal of unserviceable materials with all lead & lifts.**
- 1.0 Workmanship :** The relevant specifications of item NO 20.1 (I) shall be followed that the country tile roof of Mangalore roof shall be dismantled.
- 2.0 Mode of measurement & payment :**
- 2.1 The relevant specifications of item NO 20.1(I) shall be followed.
- 2.2 The supporting members shall be measured under separate item.
- 2.3 The rate includes labor required for disposal of unserviceable item with all leads and lifts.
- 2.4 The rate shall be for a unit of one sq. meter.
- 20.30 Dismantling cement asbestos / hard board in ceiling or partition walls wooden trellis work including frames., stacking of the serviceable materials and disposal of unserviceable materials with all leads and lifts.**
- 1.0 Workman ship :**
- 1.1 The relevant specifications of item 20.1(I) shall be followed except that the cement asbestos hard board in ceiling or partition walls wooden trellis work etc.
- 2.0 Mode of measurement & payment :**
- 2.1 The relevant specifications of item NO 20.1(I) shall be followed. The serviceable materials shall be stacked as and where directed and the unserviceable materials shall be disposed off with all leads and lifts.
- 2.2 The rate shall be for a unit of one sq. mete.
- 20.35 Dismantling wood work wrought frame and fixed in frame trusses including stacking the materials with all lead and lift.**
- 1.0 Workmanship :**
- 1.1 The relevant specifications of item NO 20.1(I) shall be followed except that the wood work wrought framed and fixed in frames trusses etc. shall be dismantled.
- 2.0 Mode of measurement & Payment :**
- 2.1 The relevant specifications of item No 20.1(I) shall be followed.

- 2.2 The materials shall be stacked as and where directed with all lead and lifts.
- 2.3 The rate shall be for a unit of one cubic meter.
- 20.39 *Dismantling expanded metal or IRC fabric with necessary battens and beadings including frame work and stacking the serviceable materials with all lead and lift***
- 1.0 Workmanship :**
- 1.1 The relevant specifications of item No 20.1 shall be followed except that the dismantling of expanded metal or IRC fabric shall be done .
- 2.0 Mode of measurement & payment**
- 2.1 The relevant specification of item no 10.1(I) shall be followed
- 2.2 The rate shall be for a unit of one sq meter.
- 20.43 *Dismantling steel work including dismembering and stacking the materials with all leads and lifts.***
- 1.0 Materials :**
- 1.1 The relevant specifications of item NO 20.1 shall be followed except that the dismantling work shall be carried out.
- 2.0 Mode of measurement & payment :**
- 2.1 The relevant specifications or item NO 20.1 (I) shall be followed
- 2.2 The weight of the member shall be computed from standard tables unless actual weight can be readily determined.
- 2.3 Riveted works where riveted are required to be cut the same shall be carried out under that item and nothing extra shall be paid.
- 2.4 In fared steel gate the weight of any converting materials or filling such as iron sheets and expanded metal shall be added to the weight of the main articles if such covering is not ordered to be taken out separately
- 2.5 The rate includes stacking the materials as and where as and where directed with all leads and lifts
- 2.6 The rate shall be for a unit of one Kg..
- 20.49 (I) *The dismantling doors windows ventilatlation etc. (wood or steel ) shutters including chowkhats architraves hold fasts and other attachments etc. complete and stacking them within all lead & lifts Not exceeding 3 sq m in area.***
- 1.0 Workmanship :**
- 1.1 The relevant specifications of item No 20.1(I) shall be followed the exceeding 3 sq m in are to be dismantled.
- 2.0 Mode of measurement & payment**
- 2.1 The relevant specifications of item no 20.1(I) shall be followed
- 2.2 The door windows ventilators etc. not exceeding 3 sq mt in are each including shutters and chowkhats architrave's holdfasts and other attachment to grams etc, will be dismantled and measured under this item
- 2.3 The rate includes stacking serviceable material and where directed with all leads and lifts
- 2.4 The rate shall be for a unit of one number
- 20.49 (II) *Dismantling doors windows ventilation etc(woods or steel shutters including chokhats architraves hold faster and other attachment etc. complte and staking that within all leads and lift exceeding 3 sq meter in area***
- 1.0 Workmanship :**
- 1.1 The relevant specifications of item No 20.49(I) shall be followed except that the doors, windows, ventilators, exceeding 3 sq. metres are to be dismantled under this item.
- 2.0 Mode of measurement & Payment**



- 2.1 The relevant specifications of item No 20.49(I) shall be followed
- 2.2 The rate shall be for a unit of one number
- 20.51 ***Dismantling barbed wire fencing including making rolls and also including dismantling fanning posts including all earth work concrete in the base and making good the disturbed ground stacking unseal materials as directed and disposing all the unserviceable materials with all leads at lifts.***
  - 1.0 **Workmanship :**
  - 1.1 The relevant specifications of item No 20.1(I) shall be followed except that the dismantling of barbed with fencing shall be carried out.
  - 2.0 **Mode of measurement & payment:**
  - 2.1 The relevant specifications of tem No 20.1(I) shall be followed
  - 2.2 The rate including making roll of dismantled wire and including dismantling fencing posts concrete work in case and making good the distilled ground etc, complete.
  - 2.3 The serviceable materials shall be stacked as and where directed and the unserviceable materials shall be disposed with all leads and lifts.
  - 2.4 The rate shall be for unit of one running meter.
- 20.56 ***Dismantling CP pipes GSW pipes and AC rain water pipes with fitting and clamps including stacking the materials with all lead and lift (for any dia of pipe)***
  - 1.0 **Workmanship :**
  - 1.1 The relevant specifications of item No 20.23 shall be followed except that the dismantling work of pipe lines of CI ,GSW & AC Pipes shall be carried out.
  - 2.0 **Mode Of measurement & Payment :**
  - 2.1 The relevant specifications of item No 20.1(I) shall be followed.
  - 2.2 Water pipe lines including rain ware pipe with clamp and specials, sewer pipe lines (salt glazed ware or concrete) etc shall be measured in running meter inclusive of joints(the measurements shall be taken along the center line of pipe and fittings)
  - 2.3 The rate shall be for a unit of one running meter.
- 20.001 ***Dismantling sanitary fitting like wash basin WC pan Indian & European Type flushing tank etc. including stacking the materials with all lead lifts.***
  - 1.0 **Workmanship :**
  - 1.1 The relevant specifications of item No 20.23 shall be followed except that the dismantling work of sanitary fitting such as wash basin , WC pan (all type pans) flushing tank etc. shall be carried out.
  - 2.0 **Mode of measurement & Payment**
  - 2.2 The relevant specifications of item No 20.1(I) shall be followed.
  - 2.2 The rate shall be for a unit of one number.
- 20.002 ***Scraping of oil paint from steel and other metal surface and making the surface even (with hand scraping)***
  - 1.0 **Workmanship :**
  - 1.1 The oil paint from steel and other metal surface shall be scraped thoroughly with hand scraper followed by wire brushing (first with coarse and than with coarse and then with fine brushes) and finally sand papering with coerce and paper (No 3) steel wood (no 2) or emery paper (NO3) or with emery cloths . This shall then be wipped finally with mineral turpentine to remove grease and prospiration of hand marks etc and allowed to dry. The surface shall be made even and smooth.
  - 2.0 **Mode of measurements & Payment:**
  - 2.1 The work shall be measured in actual area of work done.
  - 2.2 The rate shall be for a unit of one sq. metre.

**SECTION-21**  
**DETAILED SPECIFICATIONS FOR PEPAIRS TO BUILDINGS**  
**AS PER "SCHEDULE OF RATES"**

**21.8** Providing and fixing M S fan clamps of shape & size as specified in existing RCC slab including cutting chase & making good

**1.0 Materials :**

**1.1** M.S. Bar shall conform to M-18

**2.0 Workmanship:**

**2.1** The shape and size of fan clamp shall be as directed.

**2.2** For fixing M. S fan clamp in existing RCC slab a chase of size 150 mm X 75 mm Shall be cut from the ceiling so as to expose reinforcement and upto expose reinforcement and upto 25 mm clear round the reinforcement bar This shall be done without any damage to adjoining portion of ceiling The two arms of the ends of the clamp shall be passed through the space over reinforcement bar from the reinforcement bar from the bottom of the slab. the space over reinforcement bar from the bottom of the bottom of the slabe. Then then the end of the clamp shall be passed through the space over reinforcement bar from the bottom of the etslab thin the two arms shall be bent down about 15 mm by means of crow bar the clamp shall be held in position and the chase in the ceiling filled with cement concrete 1:2:4 (1 cement 2 corses and : 4 graded stone 20mm nominal size)The ceiling shall be then finished to match the existing surface and properly cured.

**3.0 Mode of measurement & payment**

**3.1** The rate includes cost of all materials and labor required for satisfactory completion of this item as described above.

**3.2** The rate shall include the cost of all labor and material involved in the operations described above

**3.3** The rate shall be for a unit one number

**21.23** *Cutting out crack of the roof terrace to V section. Cleaning, wetting, grouting, with cement and sand slurry 1:3 (1 cement : 3 sand)*

**1.0 Material :** (i) Water shall conform to M-1 (2) Cement shall conform to M-3 (3) sand M-6

**2.0 Workmanship :**

**2.1** The cracks shall be cleaned out and timed to V shaped cuts ablest 6 mm wide on top. The cracks shall be cleaned of and then cracks shall be thoroughly flooded with water allowed to a soak in cracks and then grouted with cement and sand slurry in proportion 1:3.The required cracks shall be cured attest 7 days.

**3.0 Mode of measurements & payment:**

**3.1** The rate shall included cost of all materials and labor required for satisfactory Completion of item as described above

**3.2** The rate shall be for a unit of one running meter .

**21.24** *Cutting out cracks of roof terrace to V-Section clearing out and filling solidly with a hot mixtures of bitumen and clean dry sand (1:1 by weight)*

**1.0 Materials :** (i) Bitumen shall be 85/25 penetration (20 Sand shall conform to M-6.

**2.0 Workmanship :**

**2.1** The relevant specifications of item No 21.23 shall be followed for opening cracks and cleaning

- 2.2 The cracks shall be absolutely dried and cleaned and filled solidly with a hot mixtures of 85/25 penetrating and sand in ration of 1:1 by weight the filler shall be well filled in to cracks with the edges of trowel and left flush with surface of roof. Repaired cracks shall cause no ridges across the direction of the slope of roof
- 3.0 **Mode of measurements & payment :**
- 3.1 The relevant specifications of item NO 21.23 shall be followed
- 3.2 The rate shall be for a unit of one running meter.

**SECTION - 22**  
**DETAILED SPECIFICATIONS FOR MIS BUILDING ITEM**  
**AS PER "SCHEDULE OF RATES"**

- 22.20 *Providing and fixing 1.20metre high tenting with 2 meter long M S angle posts 40mm X 6 mm and oil painting 3 coats fixed at 2.5 M C/C with five horizontal lines and two diagonals of galvanized steel barbed wire weighting 938 kg per 100 meter (Min) strained and fixed to posts with GI staples including fixed to post in ground with 0.5 M X 0.5 M x 0.5 < block in CC 1:5:10 (1 cement , 5 Sand 10 graded brick aggregate 40 mm nominal size ) etc complete.*
- 1.0 **Materials :** (1) Water shall conform to M-1 (2) Cement shall conform to M-3 (3) Sand shall conform to M-6 (4) Bricks bats aggregate shall conform to M - 14 (5) Oil Paint shall conform to M-44 (6) Barbed wire shall conform to M-78.
- 2.0 **Workmanship :**
- 2.1 The pits of the size 0.5 M X 0.5 M X 0.5 shall first be excavated true to line and level to receive the post at 2.5 M C/C The relevant specifications of item 4.00. I shall be followed for excavations work.
- 2.2 The pits shall be filled with a layer of 0.15 M thick with lean concrete 1:5:10 (1 cement :5 sand :10 graded brick bat aggregates 40 mm nominal size ) The MS angle 40 mm X 40 MM x 6 mm Shall be the pierced over the confute in true to line and plumb. The remaining portion of block shall be filled in with filled in with lean concert 1:5:10 and rammed properly so as to from total 0.5 M x 0.5M x 0.5M concrete block .The concert shall be cured for 7 days to all it to set.
- 2.3 The barbed wire shall be stretched and fixed in 5 horizontal rows and two diagonals. The bottom row shall be 140mm above ground and the rest at 125 mm center to center The concrete shall be stretched between adjacent posts from top of one post of 2nd post The wire shall be fixed to posts by means of staple. The MS Angle posts shall be painted with 3 coats of oil paint of approved tinted shade.
- 3.0 **Mode of Measurements & Payment :**
- 3.1 The work shall be measured for the finished work from center to center of the posts.
- 3.2 The rate shall include the cost of all labour and material involved in the operations described above.
- 3.3 The rate shall be for a unit one running meter.
- 22.00.1 *Constn of BB masonry panniara 23 cm x 75 Cm Wall including fixing precast RRC marble mosaic (Terrazzo) slab of 75 mm thickness on top and smooth finishing to walls to walls in cement plaster in CM 1:3 curing etc. complete including draining out waste water arrangements.*

**1.0** Materials:(1) water shall conform to M-1 (2) Cement shall conform to M-3 sand shall conform to M-6 (4) Burnt bricks shall conform to M-15(5) Preset marble mosaic terrazzo panner of 75 mm thickness shall be of best quality. The width of paniara M-15 directed

**2.0 Workmanship :**

**2.1** The brick masonry shall be constructed for panner for the size as directed in CM 1:6 The thickness of wall shall be 23 cms thick and height shall be 74 cms. The relevant specifications of BB masonry at item 6.13 (b) shall be followed for B B masonry work.

**2.2** The B B masonry work shall be covered with precast marble terrazzo paniara at top of width and length as specified or as directed The terrazzo paniara at top of width and length as specified or as directed .The terrazzo maniac panner shall be 75 mm thickness.

**2.3** The whole masonry work shall be finished smooth with CM 1:3 on both sides The relevant specification of item No 17.59(I) shall be followed.

**2.4** The drainage outlet and water arrangement shall be made as directed.

**3.0 Mode of measurements & payment :**

**3.1** The work shall be measured for the finished work

**3.2** The rate shall include the cost of all labour and materials involved in the operations described above

**3.3** The rate shall be for a unit of one running meter

**22.00.2***Construcing chowkadi with CC cover 12 cm thick B B masonry in front and dwarf wall 1 M high and 23 cms thick cement plaster to masonry in CM (1:3) and cement concrete flooring in 1:2:4 with 5 cm dia A.C Drain pipe etc. complete.*

**1.0 Materials :**

**1.1** Water shall conform to M-I cement shall conform to M-3 Sand shall conform M-3 sand shall conform to M-6 Burnt bricks shall conform to M-15 Stone 20mm nominal size shall conform to M-12 a and AC Drain pope of 5 cms dia shall conform to M-74

**2.0 Workmanship :**

**2.1** The Chowkadi shall be constructed of specified size and directed. The slab shall be cast on B B masonry wall 12 cms thick and dwarf wall 1 M high and 23 cms thick shall be constructed in preparation of CM 1:3 The relevant specifications to item 6.3 (I) shall be followed for masonry partition work and 5.4.1 (c) shall be followed reinforced concrete work.

**2.2** The Whole masonry work shall be finished with cement mortar 1:6 and finished smooth The relevant specifications of item No., 17.59(I) shall followed for plastering work

**2.3** The AC pipe of 5 cms dia shall be fixed as drainage pipe, The bottom shall be finished with CC 1:2:4 finished with cement slurry.

**3.0 Mode of Measurement & Payment.**

**3.1** The work shall be measured for finished work

**3.2** The rate includes cost of all materials labour etc, required for satisfactory completion of work.

**3.3** The rate shall be for a unit of one sq. meter.

**22.00.3***(I) Constructing cooking platform of 60cms width and 70cms height resting on BB masonry Wall 23 cms thick in CM 1:6 with fixing of precast 1:2:4 RCC 0.08 M thick slab with marble mosaic chips set in CM (Tarazo) with Plastering on exposed faces to wall in CM 1:4 etc., complete.*

**1.0 Materials :** Water shall conform to M-1 .Cement shall conform to M-4 Sand shall conform to M-6 .Burnt brick shall conform to M-15 Marble Mosaic chips shall conform to M-46 Stone aggregate 20 mm nominal size shall conform to m12 and MS Bars shall conform to M-18

**2.0 Workmanship :**

**2.1** The cooking platform of size as directed shall be constructed in 60 cms width and 70 cms height .The brick masonry wall in CM 1:6 shall be constructed in 23 cms thickness upto full depth. The relevant specifications of item 6.13(B) shall be followed for masonry work

**2.2** The RCC slab of 8 cms thickness and of adequate design and size shall be put on the BB masonry work.

**2.3** The top and exposed size of the RCC slab shall be finished with marble mosaic tarrazao shall be carried out as per relevant specification of item 14.4(E)

**2.4** The whole masonry work shall be finished with cement mortar in CM 1:4.The relevant specifications of item 17.59(II) shall be followed.

**3.0 Mode of measurements & payment:**

**3.1** The work of cooking platform shall be measured for finished work.

**3.2** The rate includes cost of all labour and materials etc. required for satisfactory completion of this item as described above

**3.3** The rate shall be for a unit of one Running meter

**22.00.3 (II) Constructing cooking platform of 60 cm width and 70cms height resting on BB masonry wall 23 cm thick in CM 1:1 with fixing black kada pastone surface laid on precast RCC slab 1:2:4 with plastering on exposed faces to wall in CM 1:4 etc. complete.**

**1.0 Materials & Workmanship :**

**1.1** The relevant specifications of item NO 22.00.3(I) shall be followed except that the cooking platform shall be constructed by providing black kada pastone of 25 mm to 20mm thickness on percent RCC 1:2:4 slab 8 cms. thick The black stone shall be provided in single piece upto 1.8 M in length and specified width. All the exposed edges of stone shall be matching cut.

**2.0 Mode of measurement & Payment :**

**2.1** The relevant specification of 22.00.3(I) shall be followed.

**2.2** The rate include providing machine cut edges on exposed face of kada pastone.

**2.3** The rate shall be for a unit of one running meter.

**22.00.4 Providing and fixing Rajula stone 75 mm thick 60 cm X 45 cms size including fixing in cement mortar as directed.**

**1.0 Materials :** Water shall conform to M-1 Cement mortar shall conform to M-11 Rajula stone of specified size shall be of best quality and free from any defects. The stone shall not be less than 75 mm in thickness.

**2.0 Workmanship :**

**2.1** The rajula stone of size 60x45 cms size shall be fixed as and where directed in cement mortar in 1:3.All the edges of the stone shall be fixed with cement mortar in CM 1:3 and sloped at 45E and finished smooth. The work shall be cured for 7 days after fixing

**3.0 Mode of measurements & Payment**

**3.1** The work shall be measured for finished work

**3.2** The rate includes cost of all labour and materials required for satisfactory completion of this item.

**3.3** The rate shall be for a unit of one sq. meter.

**22.00.5 Providing and laying Bilimora type brick facing in CM 1:1 laid over bedding of cement mortar 1:3 (13 mm thickness including cleaning watering scaffolding etc complete.**

**1.0 Materials:**

**1.1** Water shall conform to M-1 Cement mortar of specified proportion shall conform to M-11 Bilimora type brick shall be best quality and make as approved .The bricks shall be approved before collecting the same on site.

**2.0 Workmanship :**

**2.1** The surface on which the Bilimra type bricks is to be provided shall be cleaned of all dust , dirt etc. and finished with CM 1:1 The tiles shall be properly wetted before fixing the horizontal and vertical joints shall be maintained in true line and level by wire brushes to give proper grip to the tiles to be fixed .

**2.2** The Bilimora type bricks shall be fixed with CM 1:1 The thick shall be properly wetted before fixing.The horizontal and vertical joints shall be maintained in true line and level by providing 12mm. sq. bars as directed. The tiles shall by trowel so that there shall not be any hollows left behind the tiles.

**2.3** The tiles shall be cut to the required size on ends or at top bottom of beams in best workman like manner

**2.4** The whole work shall be cured for 7 days.

**3.0 Mode of measurement & payment:**

**3.1** The work shall be measured as per relevant specification of item No 17.58 (I)

**3.2** The rate include cost of all materials wastage etc. occurring due to cutting of tiles and ends top and bottom of beams etc including bars cost

**3.3** The rate shall be for a unit of one sq. meter.

**22.00.6 Providing & fixing teak wood rail of 60 mm x 20 mm size and 60cms length incl. 3 coats of oil paint of oil paint to wood work with set of 3 pegs.**

**1.0 Materials :** Teak wood battens of specified size conform M-29. Oil paint shall conform to M-44 .Wall pegs of aluminum 3 Nos of approved quality and make shall be provided.

**2.0 Workmanship :**

**2.1** The teak wood battens of size 60mm x 20 mm and 50cms long shall be planed on all sides. The anodized aluminum wall pegs of approved make shall be fixed on wooden batten prepared with screws as directed. The wooden battens shall be painted with 3 coats. of ready mix paint of approved colour and shade.

**3.0 Mode of measurement & payment:**

**3.1** The work shall be for a finished work.

**3.2** The rate shall be for a unit of one number

**22.00.7 Treating the bottom and side (upto a height of 300mm) of the excavation made for the masonry foundation and basement with chemical clumier at the rate of 5 liters pre sq meter of the surface area.**

**1.0 Materials :** The chemicals used for the treatment shall be only one of the following with concentration shown against each in aqueous emulsion

**Chemicals Concentration**

1 Aldrin 0.50%(by weight)

2 Heptachlor 0.50%(" ")

3 Chordane 1.00%(" ")

**2.0 Workmanship :**

**2.1** The chemical barrier shall be complete and continuous under whole of the structure to be protected.

**2.2** The bottom and the sides of foundations upto a highest of 30 cms from the bottom of excavation made form masonry foundation and for basement



column pits shall be treated with the chemical emulsion at the rate 5 liter/sq meter of the surface area.

- 2.3 The chemical treatment shall be carried out when the surface is quite dry. Chemical treatment shall not be carried out when it is raining or when the soil is wet with rain or sub soil water.
- 2.4 Once formed treated soil barriers shall be not disturbed if by chance treated soil barrier system.
- 2.5 The treatment against termite infection shall remain full effective for a period not less than 10 year from date of issue of the final certificate of completion of work. If at any time during this period any defects in treatment are revealed or any evidence of infection in any part of the building or structure is noticed the contractor shall be rectify the concerned defects within 15 days on receipt of notice from Engineer-in-charge. On contractor's failure to do so the Engineer-in-charge may get the same rectified through any other agency at contractor's risk and cost, and decision Engineer in charge as to the cost payable by the contractor for the same shall be final and binding to the contractor.
- 2.6 A guarantee bond on appropriately stamped paper shall be given by the contractor to the department in the manner and form prescribed below:

#### **FORM OF GUARANTEE BOND**

"I/We.....(Contractor) hereby guarantee that work will remain unaffected and will not be in any way damaged by termite or any other germs of similar type for period of 10 years after completion of the work of anti termite as per the terms and condition of the contract and contractor hereby indemnifies and agrees to save harmless the Government of Gujarat from any loss and or damage that might be caused account of termite and or other similar type of germs and hereby Guarantee to make good any loss or damages suffered by the Government of Gujarat and further guarantee to redo the effective work without claiming any extra cost"

- 2.7 This guarantee shall remain force for the period of 10 year from the completion of the work under the contract and it shall remain binding to the contractor for period of 10years.
- 2.8 The deposit at the rate of 50% of the cost of this item from the running and final bills shall be recovered and retained for the first one year after the completion of the completion of the guarantee period.
- 3.0 **Mode of Measurement :**
- 3.1 The length and breadth shall be measured correct to cm as per the dimensions of sanctioned plans. NO deduction shall be made not extra paid for and opening for pipe etc. upto 0.1 sq mt. The rate shall include the cost of all labour materials required for the operation involved for satisfactory completion of this item. The sides of the trenches 30cms each side and bottom shall be measured under this item.
- 3.2 The rate shall be for a unit of one sq. meter.

**22.00.8 *Treating the backfill immediately in contact with foundation structures with chemical emulsion at the rate 7.5 liter per sq. mt. of vertical surface of sub structure for each side (in case of RCC columns beams and RCC basement wall treating the sides of 50 cms from ground level with chemical emulsion at the rate of 7.5 Liters/Sq meter)***

**1.0 Materials :**

**1.1** The specifications of the item 22.00.7 shall be followed

**2.0 Workmanship :**

2.1 After masonry foundations and retaining wall of basement comp up the backfill immediately in contact with foundation shall be treated with the chemical clumsier at the rate of 7.5 liter per sq. m of the vertical surface of the sub structure for each side the filling of earth is usually carried out in layers and the treatment shall be directed the contract or masonry surfaces of the columns and walls so that the earth in contact with these surfaces iswell treated with chemical.

2.2 In case of RCC framed structure with columns and plinth beams and RCC basements the treatment shall start at the depth of 50 cms below ground level from this depth back fill around the column beams and RCC basement wall shall be treated at 7.5 li/sq m of vertical surface the relevant specifications shall be followed same as item 22.00.7

**3.0 Mode of measurement & Payment:**

3.1 The area of sub-structure in contact with aback fill to be measured the length and breadth shall be measured correct to Cm as per dimension of sanctioned plans for the surface in contact with back fill

3.2 No deduction shall be made nor extra paid for any opening for pipes etc. up to 0.1 sq m.

3.3 The rate includes cost of all labour materials required for satisfactory completion of this item.

3.4 The rate shall be for a unit of one sq. meter.

**20.00.9 Treating the top surface of the plinth filling with chemical emulsion at the rate of 5 liters per sq. meter before th sand bed or sub grade is laid.**

**1.0 Materials :**

1.1 The relevant specifications of item 22.00.7 shall be followed

**2.0 Workmanship :**

2.1 The relevant specifications of item 22.00.7 shall be followed except that the top surface of the consolidated earth within the walls shall be treated with the chemical emulsion at the rate 5 liter/sq meter of the surface to seep through hole up to 50to 758 mm deep at 150 cements both ways may be made with 12 mm dia M S rod on the surface to facilitate absorption of the emulsion.

**3.0 Mode of measurement & payment:**

3.1 The length and breadth shall be measured clean for the actually treated.

3.2 No deduction shall be made nor extra paid for any opening for etc.up to 0.1 sq. meter

3.3 The rate shall be for a one sq. meter

**22.00.10 Treating the junctions of walls and floor area with chemical emulsion at the rate of 7.5 litter by making holes at junction of walls and columns with the floor before laying sub grade to a depth of 15 cms by making holes.**

**1.0 Materials :**

1.1 The relevant specifications of 22.00.7 shall be followed

**2.0 Workmanship :**

2.1 The relevant specification of item. 22.00.7 shall be followed except that the junction of wall and columns with the floor shall be treated with the chemical emulsion at the rate 7.5 liter /sq meter Special cares shall be taken to establish continuity of the vertical chemical barrier on inner wall surface from the ground leave up to the level of filled earth surface. To achive this a small channel 3 x 3 cm shall be made at the junctions of the wall and columns with floor (before laying the sub - grade) and rod holes made in the channels up to the ground level 15 cms apart and the rod moved backward and forward to breakup the earth and chemical emulsion poured along the channel at the rate of 7.5 liter per sq m of the vertical walls or columns surfaces of sub structures



so as to soak the soil right to the bottom The soil should be tamped back into place after this operation.

**3.0 Mode of measurement & payment**

**3.1** The relevant specifications of item 22.00.7 shall be followed

**3.2** The vertical area of sub structure in contact with filled up earth above ground level to top of filled up earth shall be measured for payment.

**3.3** The rate shall be for unit of one sq. meter.

**20.00.11** *Treating the earth along the external perimeter of the building by making holes 15 cms apart upto a depth of 30 cms with chemical emulsion at the rate of 7.5 liter per sq mete along with wall.*

**1.0 Material :**

**1.1** The relevant specifications of item 22.00.7 shall be followed.

**2.0 Workmanship :**

**2.1** The relevant specification of item 22.00.7 shall be followed except that the external perimeter of the building shall be treated with chemicals emulsion After building is complete the earth a long the external perimiter of the building should be rode at internals of 15 cms and to depth of 30cms The rods shall be moved backward and forward paralleled to the wall to breakup the earth and chemical cmulsion poured along the wall at the rate of 7.5 litre per sq mete of vertical surface. After the treatment the earth shall be tamped back into place the earth out side of the buildings should be graded on completion of building. This treatment shall be carried out on the completion of such grading . In event of filling being more than 30cms the external perimiter and treatment shall be extended to the full depth of filling upto ground level so as to ensure continuity of the chemical barrier.

**3.0 Mode of measurements and payment :**

**3.1** The relevant specifications of item No. 22.00.7 shall be followed.

**3.2** The vertical surface area of sub-structure 30 cms. in depth from finished ground level in external periphery only shall be measured and paid under this item. The depth of wall treated under back filled shall not be including in this item.

**3.3** The rate shall be for a unit of one sq. meter.

**22.00.12** *Providing treatment along outside of foundation using chemical emulsion at 7.5 liters per sq. mt. of vertical surface (for each side) of sub-structure.*

**1.0 Materials :**

**1.1** The chemical used for the soil treatment shall be any one of the following with concentration shown against each in aqueous emulsion.

<b>Chemicals</b>	<b>Concentration</b>
1. Aldrin	0.50%(by weight)
2. Heptachlor	0.50%(by weight)
3. Chlordane	1.00%(by weight)

**2.0 Workmanship :**

**2.1** The surface of consolidated earth around the existing shall be treated with chemical emulsion at the rate 7.5 liters/sq. m. of vertical surface of sub structure. The minimum height to sub-structure shall be considered 60 cms. for treatment. If the earth along the perimeter does not allow emulsion to seep through, holes up to 300 mm. depth at 150 mm centers both way be made by 12 mm dia. mild steel rod on the surface on faciliate saturation of the soil with chemical emulsion.

**2.2** The chemical barrier shall be complete and continuous under hole of the structure to be protected.

2.3 The chemical treatment shall be carried out when the surface is quite dry. Chemical treatment shall not be carried out when it is raining or when the soil is wet with rain or sub soil water.

**3.0 Mode of measurements and payment:**

3.1 The length shall be measured along the periphery of the sub-structure. The depth shall be taken 0.60 M.

3.2 No deduction shall be made nor extra paid for any opening for pipes etc. up to 0.1 sq. m.

3.3 The rate includes cost of all labour and material required for the operations involved for satisfactory completion of this item.

3.4 The rate shall be for a unit of one sq. meter.

**22.00.13 Providing treatment along external wall perimeter below concrete or masonry apron using chemical at 5 lt/per linear including drilling and plugging etc.**

**1.0 Materials :**

1.1 The relevant specifications of item No. 22.0.12 shall be followed.

**2.0 Workmanship :**

2.1 The relevant specifications of item No. 22.0.12 shall be followed except that the treatment shall be carried out along external wall perimeter below concrete or masonry apron, using chemical at rate 5 lit/running meter.

**3.0 Mode of measurements and payment:**

3.1 The relevant specifications of item No. 22.0.12 shall be followed.

3.2 The rate includes drilling and plugging holes in apron etc. complete.

3.3 The rate shall be for a unit of one running meter.

**22.00.14 Treatment of soil below existing floor using chemical at 1 liter per hole at 300 mm. including drilling plugging holes etc.**

**1.0 Materials :**

1.1 The relevant specifications of item No. 22.0.12 shall be followed.

**2.0 Workmanship :**

2.1 The relevant specifications of item No. 22.00.9 shall be followed except that the termite control treatment shall be carried out in soil below existing floors.

2.2 The holes of 12 mm dia rod shall be drilled in floor up to 150 mm depth at 300 mm apart both ways. The chemicals shall be then injected with pressure at the rate 1 liters/hole of surface area.

**3.0 Mode of measurement and payment :**

3.1 The relevant specifications of item 22.00.9 shall be followed.

3.2 The rate shall be includes cost of drilling holes and plugging.

3.3 The rate shall be for a unit of one sq. meter.

**22.00.15 Treatment of voids in masonry using chemical at 1 lit/hole at 300 mm apart including drilling holes plugging.**

1.0 **Materials :** The relevant specifications of item 22.0.12 shall be followed.

**2.0 Workmanship :**

2.1 The walls effected by termite shall be cleaned off all live formy hiding inside and holes or voids in masonry wall surface shall be treated by chemical emulsion a rate 1 lit. hole. The holes in cracks in surface of wall shall be drilled at 300 mm apart.

**3.0 Mode of measurement and payment :**

3.1 The rate shall be for a unit of one Number of voids treated.

**22.00.16 Treatment to wood work by chemical emulsion in oil or kerosene based including 6 mm dia. down ward slanted holes 150 mm C/C and plugging the same with cement mortar.**

**1.0 Materials :**

- 1.1 The relevant specifications of item No. 22.00.7 shall be followed.
- 2.0 **Workmanship :**
- 2.1 The wood work effected by Ants shall be cleaned of all live formly hiding inside. The whole wood surface shall be then treated with oil or kerosene based chemical emulsion shall be poured into holes by means of funnels specifically prepared for the same and allowed to seep. After funels become empty, another does of chemical shall be pured in them. This process shall be done repeatedly till the whole wood work fully become saturated with chemical.
- 2.2 The holes drilled in wood work shall be filled in with party and other similar materials as directed and the whole wooden surface shall be made good s before.
- 3.0 **Mode of measurements and payment :**
- 3.1 The work shall be measured for the finished work in sq. meter including frame.
- 3.2 The out to out of frame shall be measured as width and from top flooring to top of frame shall be as height. This area includes for treating frame and shutters both.
- 3.3 The rate includes cost of all labours and materials, required for satisfacotry completion of this item.
- 3.4 The rate includes drilling holes plugging the same after treatment completed and making good as before.
- 3.5 The rate shall be for a unit of one sq. meter.

**SECTION - 23**  
***DETAILED SPECIFICATIONS FOR WATER SUPPLLY***  
***PLUMBING AND SANITARY FITTINGS***

AS PER "SCHEDULE OF RATES"

- 23.2 *Providing and fixing to wall ceiling and floor galvanized mild steel tube (Medium grade) of the following nominal bore, tube fittings and clamps including making good the wall ceiling and floor (A) 15 mm dia. (B) 20 mm dia. (C) 25 mm dia. (D) 342 mm. (E) 40 mm (F) 50 mm.*
- 1.0 **Materials:** Galvanized mild steel tubes of specified dia. nominal bore shall conform to I. S. 1239-1968. The galvanized fittings, clamps, etc. required for specified dia. bore pipes shall be of best quality and make as approved by the Engineer-in-charge.
- 2.0 **Workmanship :**
- 2.1 **Cutting, Laying and Jointing :**
- 2.1.1 When the tubes are to be cut or retheraded, the end shall be carefully filed out so that no obstruction to bore in offered. The ends of the tubes shall then be threaded conforming to the requirements of I. S. 554-1955 with pipe dies and taps carefully in such a manner as will not result in slackness of joints when the two pieces are screwed together.
- 2.1.2 The taps and dies shall be used only for straightening screw threads which have become bent or damaged and dies shall not be used for turning of the threads so as to make them slacks as the latter procedure may not result in watertight joints. The screw threads for tube and fittings shall be protected form edge unit they are fitted.

- 2.1.3** In jointing the tubes, the inside of the socket and the screwed end of the tubes shall be oiled and smeared with white or red lead and wrapped around with a few turns of fine spun yarn round the screwed end of the tube. The end shall then be tightly screwed in the socket, tees etc. with a pipe wrench. Care shall be taken that all pipes and fittings are properly jointed so as to make the joints completely water tight and pipes are kept at all times free from dust, and dirt during fixing. Burr joints shall be removed after screwing. After laying the open ends of the pipes shall be temporarily plugged to prevent access of water, soil or any other foreign matter.
- 2.1.4** Any threads exposed after jointing shall be painted or in the case of underground piping thickly coated with approved anti-corrosive paint to prevent corrosion.
- 2.2 Fixing of the tube fitting to wall ceiling and floors :**
- 2.2.1** In case of fixing of tubes and fittings to the walls or ceilings these shall run on the surface of the wall or ceiling (not in chase) unless otherwise specified. The fixing shall be done by means of standard pattern, holder clamps keeping the pipes about 15 mm clear of the wall. When it is found necessary to conceal the pipes and when specified so, chasing may be adopted or pipe fixed in ducts or recesses etc. provided that there is sufficient space to work on the pipe with usual tools. The pipe shall not ordinarily be buried in walls or solid floor, where unavoidable, pipes may be buried for short distances provided that adequate protection is given against damage and where so required joints are not buried. When required M. S. tube sleeve shall be fixed at a place a pipe is passing through a wall or floor for expansion and contraction and other movements. In case the pipe is embedded in walls or floors, it should be painted with anti-corrosive bitumastic paint of approved quality. The pipe should not come in contact with lime mortar or lime concrete as the pipe is affected by lime. Under the floors, the pipe shall be laid in layer of sand filling.
- 2.2.2** All pipes and fittings shall be fixed truly vertical and horizontal unless unavoidable. The pipes shall be fixed to walls with standard pattern clamps of required size and shape, one end of which shall be properly plugged or cemented into walls with cement mortar 1:3(1 cement : 3 coarse sand) and the other tightened round the pipes to hold it securely. These clamps shall be spaced at regular intervals in straight length at 2 M C/C interval in horizontal run and 2.5 M. interval in vertical run. For pipe of 15 mm dia. up to 25 mm. dia. the holes in the walls and floors shall be made by drilling with chisel or jumper and not by dismantling the brick work or concrete. However for bigger diameter pipes, the holes shall be carefully made of the smallest required size. After fixing the pipe the holes shall be made good with cement mortar 1:3(1 cement : 3 coarse sand) and properly finished to match the adjacent surface.
- 2.3 Testing of joints :**
- 2.3.1** After laying and jointing the pipes and fittings shall be inspected under working conditions of pressure and flow. Any joint found leaking shall be redone, and all leaking pipes removed and replaced without extra cost.
- 2.3.2** The pipes and fittings as they are laid shall be tested to hydraulic pressure of 6 Kg/sq. cm. The pipe shall be slowly and carefully charged with water allowing all air to escape and avoiding all shock and water hammer. The draw off takes and stop cock shall then be closed and specified hydraulic pressure shall be applied gradually. The pressure gauge must be accurate. The pipes and fittings shall be tested in sections as the work of laying proceeds keeping the joints exposed for inspection during the testing.

**3.0 Mode of measurements and payment :**

- 3.1** The description of each item shall unless otherwise stated, be held to include where necessary, conveyance, and delivery, handling unloading, storing fabrication, hoisting, all labour for finishing to required shape and size; testing, fitting in position, straight, cutting and waste, return of packing etc.
- 3.2** The length shall be measured on running meter basis of finished work. The length shall be taken along the center line of the pipe and fittings. The pipes fixed to walls, ceiling, floors etc shall be measured and paid under this item.
- 3.3** All the work shall be measured in decimal system as fixed in its place, subject to tolerance given below unless otherwise stated:
- (i) Dimension shall be measured to the nearest 0.01 meter
  - (ii) Area shall be worked out to the nearest 0.01 sq. meter.
- 3.4** All measurements of cutting shall unless otherwise stated be held to include the consequent waste.
- 3.5** In case of fitting of unequal bore, the largest bore shall be measured for the rest.
- 3.6** Testing of pipe lines fittings and joints include for providing all plant and appliances necessary for obtaining access to the work to be tested and carrying out the tests.
- 3.7** The rate includes galvanized steel tubing with screwed socket joints, together with all fittings (such as bends, sockets, springs, elbows, tees, crosses, short pieces, clamps and plugs unions etc.) and fixing complete with clamping wall-hooks, wooden plugs etc and also cutting ,screwing and waste and for making forged (or hand made) bends on piping as required. Connector shall be inserted, where required or directed. The rate also includes cutting through walls, floors etc. and their making good and painting exposed threads with anti corrosive paint as above and testing. Where tubes are to be fixed to wall, ceiling and flooring, the rate shall not include painting of pipes, providing sleeves and sand filling under floor for which separate payment shall be made.
- 3.8** The rate shall be for a unit of one running meter.

**23.4 *Providing and laying in trenches galvanized mild steel (medium gauge) of the following nominal bore and tube fittings (earth work in trenches to be measured and paid for separately (A) 15 mm. di, (B) 20 mm. (C) 25 mm. (D) 40 mm. (E) 60 mm. (F) 80 mm.***

**1.0 Materials :**

- 1.1** Galvanized mild steel tube of specified dia. nominal bore and fitting shall conform to I.S. 1239-1968.

**2.0 Workmanship :**

- 2.1** The relevant specifications of item 23.2(A) shall be followed for cutting, laying and joining testing of joints except that the fixing of tube shall be done in trenches.
- 2.2** The width and depth of the trenches for different diameters of the tubes shall be as under : For 15 to 80 mm. dia tube width of trenches shall be 30 cms. and depth of trenches 60 cms.
- 2.3** At joints , the trench width shall be widened where necessary. the work of excavation and refilling shall be done true to line and gradient in accordance with general specifications of earth work in trenches.
- 2.4** The pipes shall be painted with two coat of anti-corrosive bitumasic paint of approved quality. The pipe shall be laid on a layer of 75 mm. sand filled upto 150 mm. above the pipe so specified. The remaining portion of trench shall be then filled with excavated earth. the surplus earth shall be disposed of as directed.

**2.5** When the excavation is done in rock, the bottom shall be cut deep enough to permit the pipe to be laid and cushion of sand 75 mm. In case of bigger diameter of tube where the pressure is vary high, thrust bock of cement concrete 1:2:4 (1 cement : 2 coarse sand : 4 graded stone aggregate of 20 mm normal size) shall be constructed on all bends to transmit the hydraulic thrust without imparting the ground and spreading it over a sufficient area if so specified.

**3.0 Mode of measurements & payment :**

**3.1** The relevant specifications of item No 23.2 (A) shall be followed. The authorized quantities shall be measured.

**3.2** For purpose of calculating cubic content cross section shall normally be taken at suitable intervals i.e. at manhole or wall chamber intervals except in abnormal cases like sudden change in strata or undulating ground etc. when they may be taken at closer in travel as approved by the Engineer – in – charge whose decision shall be final conclusive and binding.

**3.3 Authorized Width:**

(a) Upto one meter depth , the width of the trenches for the purpose of measurement of excavation shall be arrived at by adding 40 cms. to the external diameter of the tube (not the socket) where a pipe is laid on concrete bed / cushioning layer. The authorized width shall be the external diameter of tube plus 40 cms. or the width of the concrete bed cushioning layer, whichever is more.

(b) For depths exceeding one meter an allowance of 5 cms. per meter of depth for each side of trench shall be added to the authorized width (i.e. external diameter of pipe of plus 40 cms.)This allowance shall apply to the entire depth of the trench. The authorized width in such cases shall therefore be, equal to the depth or trench,plus external diameter or tube plus 40 cms.

(c) When more than one tube is laid, the diameter shall be reckoned as the horizontal distance for outside to outside of the outermost pipes.

(d) Where sheeting etc. has been provided the authorized width of teachers at bottom shall be increased to accommodate for sheeting etc. so that the clear width available between faces of sheeting is as per provisions of (a),(b) & (c) above.

(e) If the side of the trench are not vertical , the toes of the side slopes shall end at the top of pipe and vertical sided trench of authorized width as per (a), (b), (c) and (d) above shall be excavated from these down to the bed of trenches.

**3.4** Where the tubes are laid in trenches. The work of excavation and refilling shall be paid for separately. The rate also does not include painting of pipes and sand filling all round tubes for which separate payment shall be made. The length shall be measured on running meter basis.

**3.5** The rate shall be for a unit of one running meter.

**23.6** *Making connection of galvanized M.S. distribution branch with galvanized mild steel main 50 mm. to 80 mm. normal bore by providing and fixing tee including cutting and threading the pipes etc. complete.*

**1.0 Materials :** The fitting required of specified dia of pipe shall conform to I.S. 1237 –1968.

**2.0 Workmanship :**

**2.1** A pit of suitable dimensions shall be dug at the point where the connection is to be made with the main and earth removed upto 150 mm. below the main. The flow water in water main shall also be disconnected by closing the sluice or wheel valves on the mains. The main shall first be cut. Water if any, concerned in the pit shall be bailed out, ends of the pipe threaded.



2.2 The Connections of distribution pipe shall be made by fixing malleable galvanized mild steel tee of the required size and fittings such as jam nut, socket , connecting piece etc.

2.3 The testing of the joints shall be done as per relevant specifications of item No 23.2 (A).

**3.0 Mode of Measurements & Payment :**

3.1 The rate includes cost of all labor , materials tolls and plant required for satisfactory completion of this item.

3.2 The rate shall be for a unit of one number.

**23.8 *Providing and fixing to wall ceiling and floor 6 kgs/Sq Cm. Working pressure polythene pipes of the following outside diameter low density complete with special flange compression type fittings wall clips etc. including making good the wall/ceiling and floor, (A) 20 mm. dia. (B) 25 mm dia. (C) 32 mm. dia. (D) 40 mm. dia. (E) 50 mm dia.***

**1.0 Materials :**

1.1 The low density polythene pipe of specified diameter with 6 Kg/Sq.cm. working pressure shall conform to I.S. 3076/1968. The specials and fitting required shall be of best quality.

**2.0 Workmanship :**

2.1 The P.V.C. Pipes of specified diameter shall be fixed as directed. Due to thermal expansion of rigid P.V.C. Pipes, due allowance shall be made particularly in over ground pipe lines for any change in length of pipe line which may occur during installation or when pipe line is in service.

2.2 Above ground installation of rigid P.V.C. pipe should be undertaken after preparations are observed for their protection against direct sun rays and mechanical damage.

2.3 The rigid P.V.C. pipe lines should not be kept exposed above ground when it passes through public places, railway lines, road side and foot paths.

2.4 P.V.C. pipes shall be supported at the following intervals :

20 mm dia. 500 mm. 32 mm. dia. 900 mm.

25 mm. dia. 750 mm.

2.5 Closer support spacing shall be provided if recommended by the manufacture.

2.6 The guide lines indicated by the manufacturer regarding, handling, transportation, storing laying and jointing of pipes shall be kept in view during execution.

2.7 P.V.C. pipes shall be fixed on wall with wooden plugs and suitable plastic clamps.

**2.8 Jointing the pipes :**

2.8.1 The pipes and sockets shall be accurately cut. The ends of the pipes and fittings should be absolutely free from dirt and dust. The outside surface of the pipes and the inside of the fittings shall then be roughened with emery paper, and then solvent cement joint. Since solvent cement is aggressive to P.V.C., care must be taken to avoid applying excessive cement to the inside of pipe sockets as any surplus cement cannot be wiped off after jointing. Empty solvent cement tins, brushes rags, or paper unregnated with cement should not be buried in the trenches. They should be gathered, not left scattered about, as they can prove to be a hazard to animals, which may chew them.

2.8.2 If manufacture recommends its own methods of jointing, the same shall be adopted after necessary approval from the Engineer-in-charge.

**2.9 Laying pipes in Trenches :**

2.9.1 The pipe shall be laid over uniform relatively soft fine grained soil found to be free of presence of hard objects such as large flints, rocky projections, large

tree roots etc. The width of the trenches shall be minimum width required for working.

**2.9.2** The pipes laid underground shall not be less than one metre from the ground level. The pipe shall be positioned in the trenches so as to avoid any induced stresses due to deflection. Any deviation required shall be obtained by using proper type of rubber ring joints.

**3.0 Mode of measurements & payment :**

**3.1** The relevant specifications of item 23.2 (A) shall be followed except that the P.V.C. pipes of specified dia. shall be paid under this item.

**3.2** The unit rate shall be for a unit of one running meter.

**23.111 (A) (I) Providing and fixing water closet squatting pan (Indian type W.C. Pan) size 580 mm. (Earth work, bed concrete, foot-rests and trap to be measured and paid for separately.) Vitreous china. Long pattern white colour.**

**1.0 Materials :**

**1.1** Water closet squatting pan (Indian type W.C. Pan) shall conform to M-62. Cement mortar shall conform to M-11.

**2.0 Workmanship :**

**2.1** The pan shall be sunk into the floor and embedded in a cushion of average 15 cm. cement 1 : 5 : 10 (1 cement : 5 fine sand : 10 graded stone aggregate or brick aggregate 40 mm. nominal size) or as specified. This concrete shall be left 115 mm. below the top level of the pan so as to allow for flooring and its bed concrete. The floor should be suitably sloped so that the waste water is drained into the pan. The pan shall be provided with 100 mm. 'P' or 'S' trap as specified in the item No. 23.113 with approximately 50 mm. seal. The joints between the pan and the trap shall be made leak-proof with cement mortar 1 : 1 (1 cement : 1 fine sand).

**3.0 Mode of measurements & payment :**

**3.1** The rate shall include the cost of all materials and labours involved in the operations described under workmanship.

**3.2** The rate shall be for a unit of one number.

**3.3** The 'P' or 'S' trap shall be paid separately.

**23.79 Providing and fixing cast iron spigot and sockets soil waste water and ventilating pipes of the following normal size (B) 75 mm. dia. (C) 100 mm. dia.**

**1.0 Materials :**

**1.1** The specified dia. C.I. Spigot and socket soil or waste pipe shall conform M-68.

**2.0 Workmanship :**

**2.1** The fixing of C.I. spigot and sockets soil waste and ventilating pipe shall be carried out as per relevant specifications of item 15.93 (B) except the C.I. spigot and socket shall be fixed. The joints shall be fixed with cement mortar 1 : 2 (1 cement : 2 sand) and spun yarn. The pipes without ears shall be fixed tow all with M.S. clamps. The pipes with ears shall be secured with 40 mm. before steel or iron barrel distance pieces or bobils and strout galvanized iron nails 10 cms. long driven into hand wool plugs fixed in walls. Access doors to fittings shall be provided with 3 mm. rubber insertion packing and secured without screws to make air and water tight.

**2.2** All soil pipes shall be carried up above the roof and shall have a wire ballon guard or a cowl.

**2.3** The ventilating pipe or shaft shall be carried out to a height of at least one meter above the outer covering of the roof of the building or in the case of



windows in a gable wall or a dormer windows, it shall be carried up to the ridge of the roof or at least two meters above the top of the windows. In case of flat roof to which access for use is provided, it shall be carried out up to a height of at least one meter above the parapet or two meters measured vertically from the top of any windows opening which may exist up to a horizontal distance of five meters from the vent pipe into such building and in no case shall be carried out to a height less than three meters.

- 2.4** Where ventilating pipe are carried in pipe shafts, the shafts shall be of a minimum size of one meter. If the shafts are also used to give light and air to rooms, the ventilating pipes must be carried out to a horizontal distance at roof level not less than five meter from the site of the shaft.
- 2.5** The sand cast iron pipes above parapet shall be fixed with M.S. clamps and stays. The clamps shall be made from 1.5 mm. thick M. S. flat or 3 mm. width band to the required shape and size to fit tightly on the sockets when tightened with screw bolts. It shall be formed of two semi circular pieces with flanged ends on both sides; with holes to fit in the screw bolts and nut 40 mm, dia M. S. Bars. One end of the stay shall be bent to form a hook to be fixed with clamps by means of bolts and the other end shall be bent for embedding in wall in cement concrete block of size 200 mm. x 100 mm. x 100 mm. in 1 : 2 : 4 mix. The concrete shall be finished to match the surrounding surfaces.
- 2.6** The connection between the main pipe and branch pipes shall be made by using branches and bends with access doors for cleaning.
- 2.7** The waste from lavatories, kitchens basins, sinks, baths and other floor traps shall be separately connected to respective stacks of upper floors. The waste stack of lavatories shall be connected directly to main hole while the waste stack of other shall be separately discharged over gulley trap.

**3.0 Mode of measurements & payment :**

- 3.1** The length of pipe shall be measured including all fittings along its length in running meters correct to a centimeter. No allowance shall be made for the portion of pipe length entered in the sockets of the adjacent pipe or fittings.
- 3.2** The rate includes all labour, and materials, tools and plant etc. required for satisfactory completion of this item.
- 3.3** The rate shall be for a unit of one running meter.
- 23.87** *Providing and fixing cast iron (spun) Nahni trap of the following nominal diameter of self cleaning design with C.I. Screwed down or hinged grating including cost of cutting and making good the walls and floors : 100 mm. Intel and 50 mm. outlet.*

**1.0 Materials :**

- 1.1** The cast iron (spun) Nahni trap shall be conform to M-69. The C.I. hinged or screwed down cover shall be of best quality.

**2.0 Workmanship :**

- 2.1** The Nahni trap with 100 mm. dia. inlet and 50 mm. dia. outlet shall be fixed as per drawings or as directed.
- 2.2** The Nahni trap shall be jointed with C.I. Pipe, 75 mm. dia. with lead joints. The lead joints shall be done in conformation with I.S. 782-1976.

**3.0 Mode of measurements & payment :**

- 3.1** The rate includes cost of all labour, materials, tools and plants etc. required for satisfactory completion of this item including lead jointing and testing.
- 3.2** The payment of seat and cover shall be made separately.
- 3.3** The rate shall be for a unit of one number.

**23.112 (A) (I)** *Providing and fixing wash down water closet (European type W.C. Pan) with integral 'P' or 'S' trap including joining the trap with soil pipe in*

*C.M. 1 : 1 (1 cement : 1 fine sand) (seat and cover to be measured and paid for separately) : vitreous china pattern : In white colour)*

- 1.0 **Materials :** Wash down water closet (European type W.C. Pan) shall conform to M-60. Cement mortar shall conform to M-11.
  - 2.0 **Workmanship :** Closet shall be fixed to the floor by means of 75 mm. long 6.5 mm. diameter counter sunk bolts and nuts embedded in the floor concrete using rubber or fibre washers so as not to allow any lateral displacement. The joint between the trap of W.C. and soil pipe shall be made with C.M. 1 : 1 (1 cement : 1 fine sand)
  - 3.0 **Mode of measurements & payment :**
    - 3.1 The rate shall include the cost of all labour for fixing pans and seat and cover, inlet, connections etc. complete including testing the same.
    - 3.2 The payment of seat and cover shall be made separately.
    - 3.3 The rate shall be for a unit of one number.
- 23.113 *(A) Providing and fixing 100 mm. size 'P' or 'S' trap for water closet squatting pan including jointing the trap with the pan and soil pipe in cement mortar 1 : 1 (1 cement : 1 fine sand) Vitreous china.*
- 1.0 **Materials :** The 100 mm. size 'P' or 'S' trap for water closet shall conform to M.62 Cement mortar shall conform to M.11
  - 2.0 **Workmanship :** Workmanship 'P' or 'S' trap shall be fixed with pan and cast iron pipe with C.M. 1 : 1. The pan shall be provided with a 100 mm. 'P' or 'S' trap as specified in the item with an approximately 50 mm. Seal. The joint between the pan and the trap shall be made peak-proof with cement 1 : 1 (1 cement : 1 fine sand).
  - 3.0 **Mode of measurements & payment :**
    - 3.1 The rate shall be include the cost of all materials and labour involved in the operations described under workmanship including testing.
    - 3.2 The rate shall be for a unit of one number.
- 23.114 *Providing and fixing in C.M. 1 : 3 (1 cement : 3 coarse sand) a pair of white vitreous china 250 mm. x 130 mm. x 30 mm. foot rest for long pattern squatting pan water closet.*
- 1.0 **Materials :**
    - 1.1 The pair of white vitreous china foot-rests shall conform to M-62. Cement mortar shall conform to M-11.
  - 2.0 **Workmanship :**
    - 2.1 After laying the floor, the floor, shall be suitably sloped so that the waste water is drained into the pan. A pair of foot-rests of size 250 mm x 130 mm x 30 mm. of white vitreous china shall be set in cement mortar 1 : 3 (1 cement : 3 coarse sand). The foot-rests shall be fixed at a distance of 175 mm. from the inner edge of the back side of the pan and shall be fixed at convenient angle.
  - 3.0 **Mode of measurements of payment :**
    - 3.1 The rate shall include the cost of all materials and labour involved in all the operations described under workmanship.
    - 3.2 The rate shall be for a unit of one pair.
- 23.115 *(A) (I) Providing and fixing 12.5 litres low level flushing cistern with a pair of C.I. or mild steel brackets complete with fittings such as lead valve less syphon, 15 mm. nominal size brass ball valve with polythene float, C. P. brass ball handle, unions and coupling for connections with inlet, outlet and overflow pipes, 40 mm. dia. porcelain enamelled flush including cutting holes in walls and making good the same and connecting the flush bend with cistern and closet. (overflow pipe to be measured and paid for separately) : Vitreous China. In white colour.*

**1.0 Materials :**

**1.1** The low level vitreous china (Enamel) flushing tank shall conform to M-65, except that the flushing cistern shall be 12.5 litres low level type as mentioned in the item.

**2.0 Workmanship :**

**2.1** The low level cistern shall be fixed firmly on two C.I. or mild steel brackets which shall be firmly embedded in the wall in C.M. 1 : 4 (1 cement : 4 fine sand).

**2.2** The height of the bottom of the cistern from the top of the pan shall be 30 cms. The low level flushing cistern shall be connected to the closet by means of 40 mm. dia. white porcelain enamelled flush bend using Indian rubber adapts joint. The flush pipe shall be securely connected to the cistern outlet by means of coupling nut made of any non-corrosive materials non-ferrous metal or galvanized steel. The flush pipe from the cistern shall be connected to the closet by means of cement or red-lead.

**3.0 Mode of measurements & payment :**

**3.1** The rate shall include the cost of all materials, fitting and labour involved in all the operations described under workmanship including testing.

**3.2** The rate shall be for a unit of one number.

**23.116** *Providing and fixing 12.5 litres high level C.I. flushing cistern with a pair C.I. or mild steel brackets, complete with fittings such as syphonic arrangement, 15 mm. nominal size brass ball valve with polythene flat, lever G.I. China (60 cms.) and pull unions an 1 couplings for connections with inlet outlet and overflow pipes etc. including cutting holes in walls and making good the same. (overflow pipe to be measured and paid for separately).*

**1.0 Materials :**

**1.1** The high level C.I. flushing cistern shall conform to M-66, except that the flushing cistern shall be of 12.5 litres high level C.I. flushing cistern as mentioned in the item.

**2.0 Workmanship :**

**2.1** The cistern shall be fixed on two C.I. or mild steel brackets which shall be firmly embedded in the wall in cement mortal 1 : 4 (1 cement : 4 fine sand)

**2.2** The height of the bottom of the cistern from the top of the pan shall be two meters.

**2.3** The W.C. Pan shall be connected to the cistern by galvanized steel flushed pipes of 32 mm. nominal internal diameter. The flush pipe shall be fixed to wall by using clamps. The flush pipe from the cistern shall be connected to the closet by means of cement or red-lead. The flush pipe shall be securely connected to the cistern outlet by means of coupling out made of any corrosive material non-ferrous metal or galvanized steel.

**2.4** The china and the pull union shall be fixed to the protruding lever arm of the flushing cistern.

**2.5** The whole installation shall be tested for leak-proof joints and satisfactory functioning.

**3.0 Mode of measurements & payment :**

**3.1** The rate shall be include the cost of all materials, fittings and labour involved in all operations, described under workmanship including testing.

**3.2** The rate shall be for a unit of one number.

**23.117** *Providing and fixing in position with clamps etc. 32 mm. nominal internal dia. galvanized steel tube flush pipe for high level flushing cistern including*

*connecting the flush pipe with cistern and closet and making good the walls and floors.*

**1.0 Materials :**

1.1 The 32 mm. nominal internal dia. galvanized steel tube flush pipe shall conform to M-56.

**2.0 Workmanship :**

2.1 The W.C. pan shall be connected to the cistern by galvanized steel flush pipe of 32 mm. nominal internal diameter. The pipe shall be fixed to wall by using clamps.

2.2 The flush pipe from the cistern shall be connected to the closet by means of cement or red-lead.

2.3 The flush pipe shall be securely connected to the cistern outlet by means of coupling nut made of any non-corrosive materials, non-ferrous metal or galvanized steel.

**3.0 Mode of measurements & payment :**

3.1 The rate shall include the cost of all materials, fittings and labour involved in all the operations described under workmanship including testing.

3.2 The rate shall be for a unit of one running meter.

**23.120 Providing and fixing G.I. inlet connection for flush pipe with W.C. Pan.**

**1.0 Materials :**

1.1 The G.I. inlet connection for flush pipe shall conform to M-56.

**2.0 Workmanship :**

2.1 The flush pipe from the cistern shall be connected to the closet by means of cement or read-lead.

**3.0 Mode of measurements & payment :**

3.1 The rate shall include the cost of all materials, fittings and labour involved in all the operations described under workmanship including testing.

3.2 The rate shall be for a unit of one number.

**23.127 Providing and fixing wash basin with single hole for pillar top white C.I. or M.S. brackets painted white including cutting holes, and making good the same but excluding fittings, vitreous china flat back wash basin 550 mm. x 400 mm. in white colour.**

**1.0 Materials :**

1.1 The white glazed earthenware wash basin shall be 550 cm. x 400 mm of 1st quality and make as approved by the Engineer-in-charge. The wash basin shall conform to M-59.

**2.0 Workmanship :**

2.1 The wash basin shall be fixed on the wall as and where directed. The wash basin shall be supported on a pair of M. S. or C.I. brackets fixed in C.M. 1 : 3 (1 cement : 3 sand). The bracket shall conform to I. S. : 775-1962. The wall plaster on the rear shall be cut to rest the top edge of the wash basin. After fixing the basin, plaster shall be made good and surface finished to match with the existing one.

2.2 The bracket shall be painted white with ready-mixed paint.

2.3 The C.I. brass trap and union shall be connected to 32 mm. dia. waste pipe which shall be suitably bent towards the wall and which shall discharge into an open drain leading to a gully trap or direct into the gully-trap on the ground floor and shall be connected to a waste pipe through a floor trap on the upper floors. C. P. brass trap and union may not be provided where the surface drain or a floor trap is placed directly under the basin and the waste is discharged into vertically.

- 2.4 The height of the front edge of the wash basin from the floor level shall be 80 cms.
- 2.5 The necessary inlet, outlet connections and fittings such as pillar cocks. C. P. dress waste trap waste pipe, stop cock, chain wish rubber plug etc. shall be fixed.
- 2.6 The payment of fittings shall be made separately under separate item.

**3.0 Mode of measurements & payment :**

- 3.1 The rate includes cost of all labour, materials; tools and plant etc. required for satisfactory completion of this item as specified in workmanship.
- 3.2 The rate shall be for a unit of one number.

**23.130 (C) Providing and fixing kitchen sink with C.I. or M.S. Brackets painted white including cutting holes in walls and making good the same but excluding fittings, Vitreous china Sink 600 mm. x 450 mm. x 150 mm. size.**

**1.0 Materials :**

- 1.1 White glazed vitreous china sink 600 mm. x 450 mm. x 150 mm. size shall conform to M-63.

**2.0 Workmanship :**

- 2.1 The kitchen sink shall be supported on a pair of M.S. or C.I. brackets fixed in cement mortar 1 : 3 (1 cement : 3 coarse sand). The M.S. or C.I. brackets shall conform to I.S. 775-1972. The wall plaster on the rear shall be cut to rest over the top edge of the sink. After fixing the sink plaster shall be made good and the surface finished to match with the existing one.

- 2.2 The C.P. brass trap and union shall be connected to 40 mm. dia. nominal bore galvanized mild steel waste pipe which shall be suitably bent towards the wall and which shall discharge into an open drain leading to a gully-trap or direct into the gully-trap on the ground floor and shall be connected to a waste pipe through a floor trap on the upper floors, C.P. brass trap and union may not be provided where surface drain or a floor trap is placed directly under the sink and the waste is discharged to it vertically.

- 2.3 The height to front edge of the wash basin from the floor level shall be 80 cms.

**3.0 Mode of measurements & payment :**

- 3.1 The rate includes cost of all labour, materials tools and plant and other equipment required for satisfactory completion of this item as described in workmanship.
- 3.2 The rate shall be for a unit of one number.

**23.135 (A) Providing and fixing 32 mm dia. C. P. brass waste for wash basin or sink.**

**1.0 Materials :**

- 1.1 The C. P. brass waste trap and unions shall be of 32 mm. dia. and of best quality and make as approved by the Engineer-in-charge.

**2.0 Workmanship :**

- 2.1 C. P. brass waste trap and union shall be connected to 32 mm. dia. waste pipe which shall be suitably bent towards the wall and which shall discharge into drain through a floor trap. The C. P. brass waste trap shall be provided for wash basin or sink as the case may be.

**3.0 Mode of measurements & payment :**

- 3.1 The rate includes all labour and providing C.P. brass waste trap and union including waste coupling of 32 mm. dia. The rate excludes the cost of waste pipe of 32 mm. dia.
- 3.2 The rate shall be for a unit of one number.

**23.135 (B) Providing and fixing 40 mm. dia. C. P. Brass waste for wash basin of sink.**

**1.0 Materials & workmanship :**

**1.1** The relevant specifications of item 23.135 (A) shall be followed except that the diameter of C. P. brass waste is 40 mm. dia.

**2.0 Mode of measurements & payment :**

**2.1** The rate shall be for a unit of one number.

**23.136 (A) Providing and fixing 32 mm. dia. M. I. Fisher union shall be of best quality and make as approved by the Engineer-in-charge.**

**1.0 Materials :**

**1.1** The 32 mm. dia. M. I. Fisher union shall be of best quality and make as approved by the Engineer-in-charge.

**2.0 Workmanship :**

**2.1** The 32 mm. dia. M. I. Fisher union shall be fixed to wash basin or sink in best workman like manner.

**3.0 Mode of measurements & payment :**

**3.1** The rate includes all labour and materials, tools & Plants etc. required for satisfactory completion of the item.

**23.136 (B) Providing and fixing 40 mm. dia. M. I. fisher union for wash basin or sink.**

**1.0 Materials & Workmanship :**

**1.1** The relevant specifications of item No. 23.136 (A) shall be followed except the diameter of M.I. Fisher union shall be 40 mm. dia.

**2.0 Mode of measurements & payment :** The rate shall be for a unit of one number.

**23.139 Providing and fixing 100 mm. dia. sand cast iron grating for gulley floor or Nahni trap.**

**1.0 Materials :**

**1.1** The 100 mm. dia. sand cast iron gratings for gulley floor or Nahni trap shall be of best quality and make as approved.

**2.0 Workmanship :**

**2.1** The cast iron grating shall be provided to gully trap floor or Nahni trap as the case may be in best workman like manner.

**3.0 Mode of measurements & payment :**

**3.1** The rate includes cost of all labour, materials tools, and plants, etc. required for satisfactory completion of this item.

**3.2** The rate shall be for a unit of one number.

**23.141 (A) Providing and fixing 100 mm. dia. C. P. brass shower rose with 15 mm. or 20 mm. inlet.**

**1.0 Materials :**

**1.1** 100 mm. dia. C. P. brass shower rose shall conform to I.S. : 2556-1972 part XI and of best quality and make as approved by the Engineer-in-charge. The inlet of shower rose shall be 15 mm. dia. or 20 mm. dia. as directed.

**2.0 Workmanship :**

**2.1** The C. P. brass shower rose shall be fixed as directed 15 mm. dia. or 20 mm. dia. G. I. inlet pipe as the case may be.

**3.0 Mode of measurements & payment :**

**3.1** The rate includes all labour and materials, tools and plant etc. required for satisfactory completion of this item.

**3.2** The rate shall be for a unit of one number.

**23.143 *Providing and fixing 600 mm. x 450 mm. bevelled edge mirror of superior glass mounted on 6 mm. thick A. C. Sheet or plywood sheet and fixed to wooden plugs with C. P. brass screws and washers.***

**1.0 Materials :**

**1.1** The 600 x 450 mm. size mirror shall be of superior glass with edge rounded off or beveled as specified. It shall be free from flaws specks, or bubbles and its thickness shall not be less than 6 mm. The glass for the mirror shall be uniformly silver plated at the back and shall be free from silvering defects. Silvering shall have a protective uniform covering of red-lead paint. The 6 mm. thick plywood shall conform to M-37.

**1.2** The 6 mm. thick A. C. Sheets shall conform to M-24.

**2.0 Workmanship :**

**2.1** The mirror of 500 mm. x 450 mm. size mounted on A. C. sheet or plywood 6 mm. thick with C. P. brass clips shall be fixed as directed, by fixing wooden plugs in wall and C. P. brass screws and washers. The work shall be carried out in best workman like manner.

**3.0 Mode of measurements & payment :**

**3.1** The rate includes cost of all labour and materials, tools and plant etc. required for satisfactory completion of this item. The rate shall be for a unit of one number.

**23.144 (B) *Providing and fixing 600 x 20 mm. C. P. brass towel rail complete with C. P. brass brackets fixed to wooden plugs with and C. P. brass screws.***

**1.0 Materials :**

**1.1** The C. P. brass towel rail shall be 600 x 20 mm. of best quality as approved by the Engineer-in-charge. The brackets shall be of C. P. brass. The rail shall conform to I.S. 1068-1958.

**2.0 Workmanship :**

**2.1** The brackets of the towel rail shall be fixed by means of C. P. brass to screws wooden plugs firmly embedded in the wall with C.M. 1: 3 (1 cement : 3 coarse sand). The towel rail shall be fixed as and where directed.

**3.0 Mode of measurements & payment :**

**3.1** The rate includes cost of all labour and materials, tools and plant etc. required for satisfactory completion of this item.

**3.2** The rate shall be for a unit of one number.

**23.145 *Providing and fixing 600 mm. x 120 mm. glass shelf with C. P. brackets and guard rail complete, fixed to wooden plugs with C. P. brass screws.***

**1.0 Materials :**

**1.1** The glass shelf of 600 mm. x 120 mm. size shall be of 5 mm. thick plate glass. The edge of the glass shall be grounded. The C. P. over brass guard rail shall be of best quality and make.

**2.0 Workmanship :**

**2.1** The C. P. brass brackets of the glass shelf shall be fixed with C.P. brass screws to wooden plug firmly embedded in the wall C. M. 1 : 3 (1 cement : 3 coarse sand). The c. P. guard rail shall be fixed to glass shelf as directed.

**3.0 Mode of measurements & payment :**

**3.1** The rate includes all labour and materials, tools and plant etc. required for satisfactory completion of this item.

**3.2** The rate shall be for a unit of one number.

**23.146 (A) *Providing and fixing C. P. brass toilet paper holder.***

**1.0 Materials :**

**1.1** The C. P. brass toilet paper holder shall be of best quality and make. The chromium plating shall be of grade 'B' type conforming to I.S. 1068-2958



**2.0 Workmanship :**

**2.1** The toilet paper holder shall be fixed in position by means of screws and wooden plugs embedded in wall with cement mortar 1 : 3 (1 cement : 3 coarse sand).

**3.0 Mode of measurements & payment :**

**3.1** The rate includes cost of all labour and materials, tools and plant etc. required for satisfactory completion of the item.

**3.2** The rate shall be for a unit of one number.

**23.92 (A) (I) Providing and fixing brass screw down bib taps of following size : Polished bright 14 mm. dia.**

**1.0 Materials :**

**1.1** 15 mm. dia. brass screw down with bright polished finish shall conform to I.S. 781-1977. The bib cock shall be best Indian make and quality.

**2.0 Workmanship :**

**2.1** The screw down bib cock 15 mm. dia. as specified above shall be fixed as directed. The threaded portion shall be smeared with white or red lead and around with a few turns of fine spun yarn round the screwed end of the pipe. The bib cock shall be than screwed and fixed to water tight position.

**3.0 Mode of measurements & payment :**

**3.1** The rate includes cost of all labour, materials, tools and plant etc. required for satisfactory completion of this item.

**3.2** The rate shall be for a unit of one number.

**23.92 (A) (II) Providing and fixing brass screw down bib taps of following size : Polished bright : 20 mm dia.**

**1.0 Materials & Workmanship :**

**1.1** The relevant specifications of item 23.92 (A) (I) shall be followed except that the bib taps of 20 mm. dia. shall be fixed.

**2.0 Mode of measurements & payment :**

**2.1** The relevant specifications of item 23.92 (A) (I) shall be followed.

**2.2** The rate shall be for a unit of one number.

**23.92 (B) (I) : Providing and fixing chromium plated brass screw down bib taps of the following size : 15 mm dia.**

**1.0 Materials & Workmanship :**

**1.1** The relevant specifications of item No. 23.92 (A) (I) shall be followed except that the brass chromium placed screw down bib tap shall be fixed.

**2.0 Mode of measurements & payment :**

**2.1** The rate shall be for a unit of one number.

**1.1 (B) (II) Providing and fixing chromium plated brass screw down bib taps of the following size : 15mm dia.**

**1.0 Materials & Workmanship :**

**1.2** The relevant specifications of item No. 23.92 (A) (i) shall be followed except that the brass chromium placed screw down bib tap shall be fixed.

**1.3 Mode of measurements & payment :**

**1.4** The rate shall be for a unit of one number.

**23.92 (C) (I) Providing and fixing gun metal screw down bib taps of the following size : 15 mm. dia.**

**1.0 Materials & Workmanship :**

**1.5** The relevant specifications of item No. 23.92 (A) (I) shall be followed except that the 20 mm. dia. gun screw down bib tap shall be fixed.

**2.0 Mode of measurements & payment :**

**1.6** The rate shall be for a unit of one number.



**23.92 (C) (II) Providing and fixing gun metal screw down bib taps following size : 20 mm dia.**

**1.7 Materials & Workmanship :**

1.8 The relevant specifications of item No. 23.92 (A) (I) shall be followed except that the 20 mm. dia. gun screw down bib tap shall be fixed.

**1.9 Mode of measurements & payment :**

1.10 The rate shall be for a unit of one number.

**23.95 (A) Providing and fixing biller tap capsten head screw down high pressure with screw shank and back outs : (A) 15 mm. dia. (B) 20 mm. dia.**

**1.0 Materials :**

1.11 The capsten head pillar tap of specified dia. of C.P. over brass shall be of best quality and shall conform to I.S. : 1975-1961. The pillar taps shall be of tested quality.

1.12 **Workmanship :** The capstan head pillar tap of specified dia. shall be fixed as directed with required washer of selected leather or rubber asbestos composition or of plastic as directed. The cock shall fixed with pipe line with white zink end spun yarn to make joint water tight. The work shall be carried out in best workman like manner.

**1.13 Mode of measurements & payment :**

1.14 The rate includes cost of all labour, materials tolls and plant etc. required for satisfactory completion of this item.

1.15 The rate shall be for a unit of one number.

**23.96 (A) Providing and fixing brass screw down stop cock (A) 15 mm. dia. (B) 20 mm. dia. (C) 25 mm. dia.**

**2.0 Materials :**

2.1 The brass screw down stop cock of specified dia. shall conform to I.S. : 781-1977. The stop cock shall be tested quality.

**3.0 Workmanship :**

3.1 The stop cock shall be fixed in position by means of Jam nut and socket. The stop cock shall be fixed near the inlet of the water metre or as directed. The joints shall be done with white zinc and spun yarn. The joint shall be tested for leak proofing.

**4.0 Mode of measurements & payment :**

**3.1** The rate includes cost of all labour, materials, tools and plant etc. required for satisfactory completion of this item.

**3.2** The rate shall be for a unit of one number.

**23.99 Providing and fixing gun metal check or non-return valve (A) 15 mm. dia. (B) 20 mm. dia. (C) 25 mm. dia. (D) 32 mm. dia. (E) 40 mm. dia.**

**1.0 Materials :**

**1.1** The gun metal check or non return full way wheel valve of specified dia. shall conform to I.S. 778-1964. The non return valve shall be of tested quality.

**2.0 Workmanship :**

**2.1** The gun metal check or non return valve shall be fully cleared of all foreign matter before fixing. The fixing of valve shall be done by means of bolts nuts and 3 mm. rubber insertions with flanges of spigot and socketed tail pieces, drilled to the same specification as in case of socket and spigot and with flanges in case of flanged pipes. The jointing shall be done leak proof.

**3.0 Mode of measurements & payment :**

**3.1** The rate includes all labour, materials, tools and plant etc. required for satisfactory completion of this item.

**3.2** The rate shall be for a unit of one number.

**23.00.1** *Providing and fixing chromium plated brass half turn flush cock of approved quality incl. fixing in pipe line etc. complete (I) 20 mm. dia. (II) 25 mm. dia. (III) 32 mm. dia.*

**1.0** **Materials :**

**1.1** Chromium plated brass half turn flush cock shall conform to M-67.

**2.0** **Workmanship :** The half turn flush cock of specified diameter shall be fixed as directed. The flush cock shall be fixed in G. I. pipe line with necessary fittings. The joints shall be made leak proof by using spun yarn and white zink. The fixing work shall be carried out as per relevant specifications of item No. 23.2 (4).

**3.0** **Mode of measurements & payment :**

**3.1** The rate includes cost of all materials and labour required for satisfactory completion of this item including fittings.

**3.2** The rate shall be for a unit of one number.

**23.04** *Providing and fixing chromium plated bottle trap with necessary coupling of approved quality for wash basin.*

**1.0** **Materials :** The chromium plated bottle trap shall be of approved make and of best quality. The bottle trap shall be provided with coupling.

**2.0** **Workmanship :** The bottle trap shall be fixed on hand wash basin with wooden gullies and screws as directed. The work shall be carried out in best workman like manner.

**3.0** **Mode of measurements & payment :**

**3.1** The rate includes cost of all materials and labour involved for satisfactory completion of this item.

**3.2** The rate shall be for a unit of one number.

**23.122** *(A) Providing and fixing urinal of approved quality including connecting the urinal with waste pipe, trap etc. complete : white earthen ware flat back or corner type size 430 mm. x 260 mm. x 350 mm.*

**1.0** **Materials :**

**1.1** The white earthenware flat pack or corner type urinal of size 430 mm. 260 mm. x 350 mm. shall conform to M-64.

**2.0** **Workmanship :**

**2.1** The urinals shall be fixed in position by using wooden plugs and screws and shall be at a height 65 cms. from the floor level to the top of the lip or urinal, unless otherwise directed. The wooden plugs shall be 50 mm. x 50 mm. at base lapping to 38 mm. x 38 mm. at top and 50 mm. in length shall be fixed in wall in cement mortar 1 : 3 (1 cement : 3 coarse sand). The urinal shall be connected to 32 mm. dia. galvanized mild steel waste pipe which shall discharge in the channel or floor trap. The connection between the urinal and flush or waste pipe shall be made by means of putty or white lead mixed with chopped hemp.

**3.0** **Mode of measurements & payment :**

**3.1** The rate includes cost of all labour, materials, tools and plants etc. required for satisfactory completion of this item.

**3.2** The rate shall be for a unit of one number.

**22.124** *(A) Providing and fixing urinal of approved quality including connection with trap and with integral longitudinal flush pipe squatting plate pattern white earthenware 550 mm x 300 mm.*

**1.0** **Materials :**

**1.1** The squatting plate pattern, white glazed earthenware urinal of 550 mm. x 300 mm. shall conform to I.S. 771-1063. It shall be of best Indian Make.

**2.0** **Workmanship :**

- 2.1 The squatting plate urinal shall be fixed as directed.
- 2.2 The top edge of the squatting plate shall be flush with the finished floor level adjacent to it. It shall be embedded on a layer of 25 mm. thick cement mortar 1 : 8 (1 cement : 8 fine sand) laid over a bed of burnt brick bat cement 1 : 5 : 10 (1 cement : 5 fine sand : 10 graded brick aggregate 20 mm. nominal size). There shall be 100 mm. dia. glazed earthenware of vitreous china channels as specified with stop and outlet pieces suitably fixed in floor in cement mortar 1 : 3 (1 cement : 3 coarse sand) and joint finished with white cement. The earthenware vitreous china shall discharge into 65 mm. C.P. brass outlet grating. The trap and fitting shall be fixed as directed.
- 3.0 Mode of measurements & payment :**
- 3.1 The rate includes cost of all materials, tools and plants and labour required for satisfactory completion of this item.
- 3.2 The rate shall be for a unit of one number.
- 23.134 Providing and fixing rubber plug for sink or wash basin.**
- 1.0 Materials :**
- 1.1 The rubber plug for sink or wash hand basin shall be best quality and make as approved by the Engineer-in-charge.
- 2.0 Workmanship :**
- 2.1 The rubber plug with chain shall be fixed in wash basin or sink as directed.
- 3.0 Mode of measurements & payment :**
- 3.1 The rate shall for a unit of one number.
- 23.00.5 (A) Providing and fixing ball cock of approved quality as directed (Copper metal) (I) 25 mm. dia. (II) 50 mm. dia.**
- 1.0 Materials :** The ball cock of specified diameter shall conform to M-75.
- 2.0 Workmanship :** The ball cock of specified diameter shall be fixed as directed. The fixing of ball cock shall be carried out as per relevant specifications of item No. 23 (A) for joints etc.
- 3.0 Mode of measurements & payment :**
- 3.1 The rate includes cost of all materials and labour involved for carrying out satisfactory work.
- 3.2 The rate shall be for a unit of one number.
- 23.00.5 (B) Providing and fixing ball cock of approved quality as directed : (Abonite) (I) 25 mm. dia. (II) 50 mm. dia.)**
- 1.0 Materials & Workmanship :** The relevant specifications of item No. 23.00.5 (I) shall be followed except that the ball cock of specified dia. of Abonite shall be fixed.
- 2.0 Mode of measurements & payments :**
- 2.1 The relevant specifications of item No. 23.00.5. (A) shall be followed.
- 2.2 The shall be for a unit of one number.
- 22.00.6 Providing and fixing C.I. Manhole cover 0.60 CM x 0.45 CM size having weight not less than 35 Kg.**
- 1.0 Materials :** C.I. Manhole cover of 0.60 x 0.45 Cms. size shall be of best quality. The weight of C.I. cover and frame shall not be less than 35 Kg. The C.I. manhole cover shall be of light duty and conform relevant I.S.
- 2.0 Workmanship :**
- 2.1 C.I. Manhole cover shall be fixed as per relevant specifications of item No. 24.44 except that the C.I. cover shall be fixed as and where directed.
- 3.0 Mode of measurements & payment :**
- 3.1 The rate includes cost of all labour and materials required for satisfactory completion of this item.
- 3.2 The rate shall be for a unit of one number.

**23.007 Providing and fixing G.I. rainwater spout of 50 mm. dia. and 20 cms. length.**

**1.0 Materials :** G.I. M.S. pipe of 50 mm. dia. shall conform to M-56.

**2.0 Workmanship :**

**2.1** The G.I. pipe of 30 cms. fixed as rain water pipe as directed. The pipe shall be fixed about 1/4 dia. below the floor level so as to make approach of water easy. The inlet of pipe shall be rounded off for easy entry of rain water pipe. The pipe shall be fixed in C.M. 1 : 3.

**3.0 Mode of measurements & payment :**

**3.1** The rate includes of all labour and materials required for satisfactory completion of this item.

**3.2** The rate shall be for a unit of one number.

**23.8 Providing and fixing to wall ceiling and floor polythene pipe of specified diameter will 6 Kg. F/Sq.cm. working pressure outside diameter, low density completion with special flange compression type fittings wall clips, etc., incl. making good the wall, ceiling and floor. (A) 20 mm. dia. (B) 25 mm dia. (C) 32 mm. dia. (D) 40 mm. dia. (F) 50 mm. dia.**

**1.0 Materials :**

**1.1** The low density polythene pipe of specified diameter with 6 Kg.F/Sq.Cm. working pressure shall conform to I.S. 3076-1968. The specials and fittings required shall be of best quality.

**2.0 Workmanship :**

**2.1** The P.V.C. Pipes of specified diameter shall be fixed as directed. Due to thermal expansion of rigid P.V.C. Pipes, due allowance shall be made particularly in over ground pipe lines for any change in length of pipe line which may occur during installation or when pipe line is in service.

**2.2** Above ground installation of rigid P.V.C. pipe should be undertaken after precautions are observed for their protection against dirt sun rays and mechanical damage.

**2.3** The rigid P.V.C. pipe lines should not be kept exposed above ground when it passes through public place, railway lines, roads, road side and footpaths.

**2.4** P.V.C. pipes shall be supported at the followings intervals :

20 mm. dia.                      500 mm.

25 mm. dia.                      750 mm.

32 mm. dia.                      900 mm.

**2.5** Closet support spacing shall be provided, if recommended by the manufacturer.

**2.6** The guide line indicated by the manufacturer regarding handling, transportation, storing, laying and jointing of pipes shall be kept in view during execution.

**2.7** P.V.C.V. pipes shall be fixed on wall with wooden plugs and suitable clamps.

**2.8 Jointing the pipes :**

**2.8.1** The pipes and sockets shall be accurately cut. The ends of the pipes and fitting should be absolutely free from dirt and dust. The outside surface of the pipes and the inside of the fittings shall then be roughened with emery paper, and then solvent cement shall be applied to the matching surface and pushed home and joint. Since solvent cement is aggressive to P.V.C. care must be taken to avoid applying excessive cement to the inside of pipe sockets as any surplus cement cannot be wiped off after jointing. Empty solvent cement tins, brushes, rags, of paper unpregnated with cement should not be buried in the trenches. They should be gathered, not left scattered about, as they can prove to be a hazard to animals which may chew them.

- 2.8.2 If any manufacturer recommends its own methods of jointing the same shall be adopted after necessary approval from the Engineer-in-charge.
- 2.9 Laying pipes in trenches :
- 2.9.1 The pipes shall be laid over uniform relatively soft fine grained soil found to be free of presence of hard objects such as large flints, rocky projections, large tree roots etc. The width of the trenches shall be minimum width required for working.
- 2.9.2 The pipes laid underground shall not be less than one metre from the ground level. The pipe shall be positioned in the trenches so as to avoid any induced stresses due to reflection. Any deviation required shall be obtained by using proper type of rubber ring joints.
- 3.0 **Mode of measurements & payment :**
- 3.1 The relevant specifications of item No. 23.2 (A) shall be followed except that the P.V.C. pipes specified dia. shall be paid under this item.
- 3.2 The rate shall be for a unit of one running metre.

## SECTION - 24

### ***DETAILED SPECIFICATION FOR DRAINAGE & SEWERAGE***

- 24.1. *(A) Providing and laying (Two level or slopes) and jointing with stiff mixture of cement mortar in proportion 1 : 1 salt glazed stone-ware pipes, following nominal internal diametres including testing of pipes and joints complete : 100 mm. dia.*
- 1.0 **Materials :** (1) Water shall conform to M-1, (2) Cement mortar of proportion 1 : 1 shall conform to M-11 (3) 100 mm. dia. glazed stoneware pipe shall conform to M-71.
- 2.0 **Workmanship :**
- 2.1 The trenches for stoneware pipe drains shall be carried out as per relevant specifications of item No. 23.4 (A) except that the work is for stoneware pipes of 100 mm. dia.
- 2.2 **Laying :**
- 2.2.1 The pipes shall be laid accurately and perfectly true to line, levels and gradients. Great care shall be taken to prevent sand etc., from entering the pipes. The pipes between two manholes shall be laid truly in a straight line without vertical or horizontal undulation. All junctions and changes in direction and diameter shall be made inside manholes by means of curved tapered channels formed in cement concrete finished smooth and benched on both sides. The body of the pipe shall rest for its entire length, on an even level bed grips being made or left on the bed to receive the sockets of the pipes.
- 2.3 **Jointing :**
- 2.3.1 Tarred gaskin or yarn socket in neat cement slurry first be placed around the spigot of each pipe and the spigot shall then be placed well home into the socket of the pipe previously laid. The pipe shall then be adjusted and fixed in the correct position and gaskin cculked home so as to fill not more than 1/4th of the total dept or (13 mm. in depth) of the socket.
- 2.3.2 The remainder of the socket shall be filled with stiff mixture of cement mortar in proportion of one part of cement and one part of sharp sand. When the socket is filled, a fillet, shall be formed round the joints trowel, forming an angle of 45<sup>o</sup> with the barrel of the pipe.
- 2.3.3 The mortar shall be mixed as necessary for immediate use.
- 2.3.4 After the joint is made, any extraneous materials shall be removed from the inside of the joints with a suitable scraper of 'badger'. The newly made joint

shall be protected, until set, from the sun, dry winds, rain or frost, sacking or other suitable materials which shall be used for the purpose.

2.3.5 The mortar shall be cured to 10 days.

2.4 **Testing of Joints :** The pipe line shall be tested as directed.

2.4.1 If any leakage is visible, the defective part of the work shall be made good at no extra cost.

2.4.2 A slight amount of sweating which is uniform may be overlooked, but excessive sweating from a particular pipe or joints shall be watched for and taken as indicating a defect to be made good.

3.0 **Mode of measurements & payment :**

3.1 Pounding or bottaning of the trenches bed to fit the lower part of the pipe and 'Grips' left to take socket, collars etc. are included in the rate of laying the pipes.

3.2 The measurements shall be net without any allowance for cutting and waste. The length of bends, junctions and other connections shall be included in the total length of the drain pipes. Nothing extra shall be paid for the same. The rate includes necessary excavation refilling trenches etc. complete.

3.3 The rate shall be for a unit of one running meter.

24.1 *(B) Providing and laying and jointing salt glazed stoneware pipes with the lime concrete 1 : 2 : 4 (1 lime : 2 fine sand : 4 graded brick aggregate 40 mm. nominal size) bedding with necessary form work and curing etc. complete : 150 mm. dia.*

1.0 **Materials & Workmanship :** The relevant specifications of item 24.1. (A) shall be followed except that the diameter of pipe shall be 150 mm. dia.

2.0 **Mode of measurements & payment :**

2.1 The relevant specifications of item 24.1. (A) shall be followed.

2.2 The rate shall be for a unit of one running meter.

24.2 *(A) Providing and laying cement concrete 1 : 5 : 10 (1 cement : 5 fine sand : 10 graded stone : aggregate 40 mm. nominal size) bedding for stoneware pipe of following internal diameter with necessary formwork and curing complete : 100 mm. dia. 300 mm. width (112 mm. average bed thickness)*

1.0 **Materials :** (1) Water shall conform to M-1. (2) Cement shall conform to M-3. (3) Sand shall conform to M-6. (4) Stone aggregate 40 mm. nominal size shall conform to M-12.

2.0 **Workmanship :**

2.1 The relevant specifications of item 5.3.4 shall be followed except that the concrete work shall be carried out in trenches as bedding for stoneware pipes. The width of concrete work shall be 300 mm. and average thickness of bedding shall be 112 mm. The concrete shall be brought up atleast to the invert level of the pipe to form a cradle and to avoid line contact between the pipe and the bed.

3.0 **Mode of measurements & payment :**

3.1 The rate includes cost of all labour and materials required for satisfactory completion of this item.

3.2 The rate includes cost of necessary formwork required if any.

3.3 The rate shall be for a unit of one running meter.

24.2 *(B) Providing and laying cement concrete 1 : 5 : 10 (1 cement : 5 fine sand : 10 graded stone aggregate 40 mm. nominal size) bedding for stoneware pipe of following internal diametres with necessary form work and curing complete : 150 mm. dia. 450 mm. width (166 mm. average bed thickness)*

1.0 **Materials & Workmanship :**



1.1 The relevant specification of item 24.2 (A) shall be followed except that the cement concrete work shall be carried out for bedding for stoneware pipe of 150 mm. dia. The average thickness of bedding shall be 166 mm. and width shall be 450 mm.

**2.0 Mode of measurement & payment :**

2.1 The relevant specifications of item 24.2 (A) shall be followed.

2.2 The rate shall be for a unit of one running meter.

**24.19 (I) Providing and fixing S.W. gully trap with C.I. grating, brick masonry chamber and watertight C.I. cover with frame of 300 mm. x 300 mm. size (Inside) with standard weight : (A) square mount traps 100 mm. x 100 mm. size P. type.**

**1.0 Materials :** (1) Water shall conform to M-1. (2) Cement mortar of proportion 1 : 5 shall conform to to M-11. (3) Burnt brick shall conform to M-15. (4) The S.W. Gulley trap of 100 mm. x 10-0 mm. size shall conform to M-70.

**2.0 Workmanship :**

2.1 Excavation for gully trap shall be done true to dimensions and levels as indicated on plans or as directed. The excavation work shall generally be done as per relevant specification of item 4.0.0 of earth work.

**2.2 Fixing :**

2.2.1 The gulley trap shall be fixed over cement concrete 1 : 5 : 10 (1 cement : 5 sand : 10 graded brick bats aggregate 40 mm. nominal size) foundation, 650 mm. square and 100 mm. thick. The depth of top of concrete below the ground level shall be 675 mm. The jointing of gulley outlet to the branch drain shall be done similar to jointing of S. W. pipe as described in item No. 24.1 (A).

2.3 **Brick masonry chamber :** After fixing and testing gulley and branch drain, a brick masonry 300 x 300 mm. inside with bricks in C. M. 1 : 5 (1 cement : 5 sand) shall be built be built with a 100 mm. brick work round the gulley trap from the top of bed concrete upto ground level. The space between the chamber walls and the trap shall be filled with cement concrete 1 : 5 : 10. The upper portion of the chamber i.e. above the top level of the trap shall be plastered inside with cement mortar 1 : 3 (1 cement : 3 sand) finished with floating coat of neat cement. The corners and bottom of the chamber shall be rounded of so as to slope towards the grating.

2.4 C.I. cover with frame 300 mm. x 300 mm. (inside) size shall than be fixed on the top of the brick masonry with C. C. 1 : 2 : 4 (1 cement : 2 coarse sand : 4 graded stone aggregate 20 mm nominal size) 40 mm. thick and rendered smooth. The finished top of the cover shall be left about 40 mm. above the adjoining ground level so as to exclude the surface water from entering the gully trap.

**3.0 Mode of measurements & payment :**

3.1 The rate includes cost of all labour, materials, tools and plant etc. required for satisfactory completion of this item as described above.

3.2 The rate shall be for a unit of one number basis.

**24.22 Providing and laying (to level or slopes and jointing reinforced concrete light duty non-pressure pipes I.S. class N.P. 2 of the following internal diametres with collars and butt-ends prepared for collar joints incl. testing of joints etc. complete (B) 150 mm. (C) 250 mm. (D) 300 mm. (E) 450 mm. (F) 500 mm. (G) 600 mm. (H) 900 mm. (K) 1000 mm. (M) 1200 mm.**

**1.0 Materials :**

1.1 The reinforced concrete light duty non-pressure pipes of specified diameter shall conform to I.S. 458-1971.

**2.0 Workmanship :**

**2.1.** The relevant specifications of item No. 24.1. (A) shall be followed for work of trenches except that the excavation in trenches shall be for reinforced concrete pipes of specified diameter.

**2.2. Laying :**

**2.2.1** The pipes shall be lowered into the trenches carefully. Mechanical appliances may be used. Where necessary pipe shall be laid in straight lines or with easy curves and true to line and gradient as specified. The laying of pipe shall proceed up grade of a slope. In the pipe with loose collars, the collars shall be slipped on before the next pipe is laid.

**2.2.2** In case where the foundation conditions are unusual such as the proximity of trees or holes, under existing or proposed around in 150 mm. thick cement concrete 1 : 5 : 10 (1 cement : 5 fine sand : 10 graded stone aggregate 40 mm. nominal size) or compacted sand or gravel.

**2.2.3** In case where the natural foundation is inadequate the pipe shall be laid either in concrete cradle, supported on proper foundation or on any other suitably designed structure. If concrete bedding is used, the depth of concrete below bottom of the pipe shall be atleast  $\frac{1}{4}$  th of the internal diameter of the pipe subject to a minimum of 100 mm. and maximum 300 mm. The concrete shall be extended upto the sides of the pipe atleast a distance of  $\frac{1}{4}$  th of the outsided diameter for pipes 300 mm. and over in diameter.

**2.2.4** The pipes shall be laid in the concrete bedding before the concrete has set. Pipes laid in trenches in earth shall be bedded evenly and firmly and as far as upto the haunches of the pipe as to safely transmit the load expected from the back fill through the pipe to the bed. This shall be done either by excavating the bottom of the trenches to fit the curve of the pipe or by compacting the earth under round curve of the pipe to form an even bed. Necessary provision shall be made for joints wherever required.

**2.3 Jointing :**

**2.3.1.** The joints shall be done by slipping the collar over and clear of the end of the pipe. The recess of the end of the pipe shall be filled with jute threading dipped in hot bitumen. The new pipe shall then be brought forward until the bitumen ring in recess of first pipe is set into the recess of the second pipe. This process shall be repeated for two or three pipes which shall then be jacked up so as to thoroughly compress the bitumen. The quantity of jute and bitumen shall be just enough to fill the recess when pressed hard by jacking, care being taken that no offset of the jute braiding shall be visible either outside or inside of pipe. The collar shall then be set up over the joints covering equally both the pipe and leaving an even caulking space all round. Cement and sand mortar 1 :  $1\frac{1}{2}$  shall then be well punched or pressed home with a caulking tool within this caulking space. Care shall be taken that the underside of the joints is properly filled with mortar.

**2.4 Curing :**

**2.4.1** Every joints shall be kept wet for about 10 days for maturing the section of the pipe line laid and jointed shall be covered immediately to protect from weather effects. Minimum bore of 100 mm. is considered adequate.

**2.4.2** The joints shall be left exposed for observation.

**2.5 Testing of joints :**

**2.5.1** The testing of joints shall be done as per relevant specifications of item No. 24.1 (A) except that the testing of reinforced concrete pipes shall be done.



**3.0 Mode of measurements & payment :**

- 3.1** The relevant specification of item No. 24.1. (A) shall be followed except that the rate includes for laying (to level or slope in trenches etc. measured separately) making the joints as indicate and testing to stand the water test.
- 3.2** The measurements shall be net without any allowance for cutting and waste. The length of bends, junctions and other connections (measured along the center line) shall be including in the total length of the pipes, the connections being numbered afterwards and paid for extra over pipes.
- 3.3** The size of bends, junctions etc. shall suit the size of pipe. The bore (internal diameter of pipe) shall be the criterion for payment.
- 3.4** Nothing extra shall be paid separately for the use of mechanical appliances, where necessary, as described above.
- 3.5** The rate shall be for a unit of one running meter.

**24.27** *Constg. Manhole with R.C.C. top slab in 1 : 2 : 4 mix (1 cement : 2 coarse sand : 4 graded stone aggregate 20 mm. nominal size) foundation concrete 1 : 3 : 6 (1 cement : 3 coarse sand : 6 brick bats 40 to 50 mm. size) inside plastering 15 mm. thick with C.M. 1 : 5 (1 cement : 5 coarse sand) finished with floating coat of neat cement and making channels in C.C. 1 : 2 : 4 (1 cement : 2 coarse sand : 4 stone aggregate 20 mm. nominal size) finished smooth complete incl. curing and testing (1) inside size 900 mm. x 120 mm. and 1.5 mm. deep including C.I. cover with frame size 560 mm. diameter, total weight of cover and frame to be not less than '18 Kgs. (Wt. of cover 64 Kg. and Wt. of frame 64 Kg.) (A) with 230 mm. thick walls of masonry using brick shaving crushing strength not less than 35 Kg./sq.cm. in C.M. 1 : 5 (1 cement : 5 coarse sand).*

- i. A type depth 0.90 metre for 150 mm. sewer ii. B type depth 150 metre for 150 sewer  
iii. C type depth 2.25 metre for 150 mm. sewer iv. D type depth 315 metre for 150 sewer

**1.0 Materials :** Water shall conform to M-1. Cement shall conform to M-6. Burnt bricks shall conform to M-15. Brick bats of 40 to 50 mm. size shall conform to M-14. Stone coarse aggregate of 20 mm. nominal size shall conform to M-12. Grit shall conform to M-8. Cement mortar of specified proportion shall conform to M-11. The cast iron manhole cover of 560 mm. dia. with frame shall conform to I.S. 1726-1966.

**2.0 Workmanship :**

**2.1** The manholes of different types and sizes as specified shall be constructed in sewer line at such places and to such levels and dimension as shown in drawings or as directed.

**2.2 Bed concrete :**

**2.2.1** The manhole shall be built on a bed of cement concrete 1 : 3 : 6 (1 cement : 3 coarse sand : 6 brick bats) (40 to 20 mm. nominal size) to the thickness of the bed concrete shall be 15 cms. for manhole upto 1 M. depth and 20 cms. for manholes over meter and upto 2 meters. depth and 30 cms. for manholes of greater depth.

**2.2.2** Projection of bed concrete beyond the masonry wall shall be 15 cms.

**2.3 Walls :**

**2.3.1** The walls or manhole shall be carried out with burnt bricks using bricks, having crushing strength not less than 35 Kg./Cm<sup>2</sup> in C.M. 1 : 5 (1 cement : 5 coarse sand). The thickness of brick masonry wall shall be 230 mm. The jointing face of such brick shall be well buttered with cement mortar before laying so as to ensure full joints.

## **2.4 Plaster :**

**2.4.1.** The inside of walls shall be plastered 15 mm. thick with C.M. 1 : 5 (1 cement : 5 coarse sand) and finished with floating coat of neat cement. All angles shall be rounded to 7.50 cms. radius and all rendered internal surfaces shall have impervious finish obtained by using a steel trowel. The external joints of masonry shall be finished smooth.

## **2.5 Channels & Benching :**

**2.5.1** Channels shall be semicircular in the bottom half and of diameter equal to the sewer. Above the horizontal diameter, the sides shall be extended vertically to the same level as the crown of the outgoing pipe and the top edge shall be suitably rounded off. The branch channels shall also be similarly constructed with respect to the benching but at their junction with the main channel and appropriate fall suitably rounded off in the direction of flow in the main channel shall be given.

**2.5.2** The channel and benching shall be done C.C. 1 : 2 : 4 (1 cement : 2 coarse sand : 4 graded stone aggregate 20 mm. nominal size) rising at a slope in line from edges of channel. The channels of the bottom of the chamber shall be plastered with C.M. 1 : 2 (1 cement : 2 coarse sand) and steel trowelled smooth.

## **2.6 Cover slab :**

**2.6.1** The cover slab of R.C.C. 1 : 2 : 4 (1 cement : 2 coarse sand : 4 graded stone aggregate 20 mm. nominal size) 15 cms. thick reinforced with 10 mm. brass at 15 cms. C/C both ways, surface and edges finished fair. Full bearing equal to the width of wall shall be given to the slab on all sides. The frame of manhole cover shall be embedded firmly in R.C.C. Slab so that the top of the frame remains flush with the top of R.C.C. slab.

## **2.7 Testing :**

**2.7.1** Manhole shall be tested by filling with water to a depth not exceeding 1.2 M. as directed.

**2.7.2** After completion of work, manhole covers shall be sealed by means of thick grease.

## **3.0 Mode of measurements & payments :**

**3.1** The depth of manhole shall be distance between the top of the manhole cover and the invert level of the main drain. The rate includes all labour, materials, tools and plant etc. required for satisfactory completion of this item as directed above.

**3.2** The rate shall be for a unit of one number.

**24.28 (I) Extra rate for costing B. B. masonry or every additional depth of 0.1 M. or part thereof over item 24.27 (I) for depth from 0.90 M to 1.5 M.**

**1.0 Materials & Workmanship :** The relevant specifications of item No. 24.27 (I) shall be followed for excavation except that the depth of manhole shall be done 0.1 M. or part thereof more than 0.90 meter up to 1.5 M. the extra payment shall be made for additional depth of 0.1 M. or part thereof manhole done over and above the depth 0.90 meter.

## **2.0 Mode of measurements & payment :**

**2.1** The relevant specifications of item 24:27 (I) shall be followed except that the extra rate shall be paid for every additional depth of 0.1 M. and part thereof shall be paid over and above the rate of item No. 24.27 (I).

**2.2** The rate shall be for a unit of one number.

**24.28 (II) Extra rate for constg. B. B. masonry for every additional depth of 0.1 M. and part thereof over item 24.27 (I) for depth from 1.5 M. to 2.25 M.**

**1.0 Materials & Workmanship :**

- 1.1 The relevant specifications of item 24.27 (I) shall be followed except that the depth of manhole shall be done 0.1 M. or part thereof more than 1.5 M. upto 2.25 M. The extra payment shall be made for additional depth of 0.1 M. or part thereof manhole done over and above the depth 1.50 M. upto 2.25 M.
- 2.0 Mode of measurements & payment :**
- 2.1 The relevant specifications of item 24.27(II) shall be followed except that the extra rate shall be paid for 0.1 M or part there of additional depth of manhole provided over and above item 24.27(I)
- 2.2 The rate shall be for a unit of one number
- 24.28 (III) Extra rate for Constg B.B masonry for every additional depth of 0.1 M or part thereof over item 24.27(I) for depth from 2.25 to 3.15 M.**
- 1.0 Materials & Workmanship :**
- 1.1 The relevant specifications of item 24.27(I) shall be followed except that the depth of manhole shall be done 0.1 M or part thereof more than 2.25 M up to 3.15 M. extra payment shall be made for additional depth of 0.1 or part thereof manhole done over and above depth 2.25 M up to 3.15M.
- 2.0 Mode of measurements & payment :**
- 2.1 The relevant specification of item 24.27(I) shall be followed except that extra rate shall be paid for every additional 0.1 M or part thereof depth provided for above item 24.27 (I).
- 2.2 The rate shall be for a unit of one number.
- 24.28 (IV) Extra rate of constg. B. B. masonry for every additional depth of 0.1 M. or part thereof over item 24.27 (I) for depth above 3.15 M.**
- 1.0 Materials & Workmanship :**
- 1.1 The relevant specifications of item 24.27 (I) shall be followed except that the depth of manhole shall be done 0.1 M or part thereof more than 3.15 M. above.
- 1.2 Extra payment shall be made for additional depth of manhole 0.1 M. or part thereof done above 3.15 M. and above depth.
- 2.0 Mode of measurements & payment :**
- 2.1 The relevant specifications of item 24.27 (I) shall be followed except that extra rate shall be paid for every additional 0.1 M. or part thereof depth provided for above item 24.27 (I).
- 2.2 The rate shall be for a unit of one number.
- 24.13 Providing and fixing C.I. steps of size 500 x 150 mm. x 22.5 m. and painting with two coats of anti-corrosive paint etc. complete.**
- 1.0 Materials :**
- 1.1 The C. I. Steps of size 500 x 150 x 22.5 mm. size shall conform I.S. 5455-1969. Paint shall conform to M-44.
- 2.0 Workmanship :**
- 2.1 The C. I. steps of size 500 x 150 x 22.5 mm. size shall be fixed in manhole as and where directed. The steps shall be staggered in vertical runs 380 mm. apart horizontally. The top step shall be 450 mm. below the manhole cover and lowest not more than 300 mm. above the benching. The steps shall be embedded in well of manhole with C.C. 1 : 3 : upto 200 m. depth and the surface finished with cement plaster 15 mm. thick in C.M. 1 : 5. The steps shall be painted with two coats of anti-corrosive paint.
- 3.0 Mode of measurements & payment :**
- 3.1 The rate includes all labour, materials, tools and plants etc. required for satisfactory completion of this item.
- 3.2 The rate shall be for a unit of one number.

**24.30** *Providing and erecting at the site of work steel ventilating column of 150 mm. internal dia. and 12.20 M. high from G. L. to bottom of top grill incl. C.I. grill and base plate, bolts and nuts etc. and excavation in foundation of size 120 x 120 x 165 cms. and filling the pit with 1st layer of cement concrete 1 : 3 : 6 mix (1 cement : 3 coarse sand : 6 graded stone aggregate 20 mm. nominal size) of size 120 x 120 x 90 cm. and remaining pit with B.B.C.C. 1 : 3 : 6 mix (1 cement : 3 coarse sand 6 brick bats, 40 to 50 mm. size) and providing filled in cement concrete 1 : 2 : 4 mix (1 cement : 2 coarse sand : 4 graded stone aggregate 20 mm. nominal size) at G.L. and 3 coats of silver paint etc. Complete.*

**1.0 Materials :**

**1.1** The steel ventilating column internal dia. 150 mm. 12.20 m. high shall be of standard make and best quality as approved. Stone aggregate of 20 mm. nominal size shall conform to M-12. Brick-bats 40 to 50 mm. nominal size shall conform to M-14. Cement shall conform to M-3. Water shall conform to M-1. Silver (Aluminum) paint shall conform to I.S. 2339-1963.

**2.0 Workmanship :**

**2.1** The vent shaft shall be provided at the starting point of main sewer and at such points where the flow of sewerage is disturbed i.e. at falls, syphons etc. As far as possible, the location shall be such a place where it receives sun rays for the maximum period of the day.

**2.2** A pit of 120 x 120 x 165 cms. size shall be dug. The cement concrete of 1 : 3 : 6 (1 cement : 3 coarse sand : 6 graded stone aggregate 20 mm. nominal size) shall be first laid in the pit to form 90 cms. thick concrete foundation which shall be allowed to set for 24 hours. The vent shaft shall then be erected at the center of the pit truly in plumb by means of such as shear legs, pullies, tackles and rope etc.

**2.3** The connections with sewer manhole shall be made using 150 mm. diameter cement concrete pipe. After the connection is completed the pit shall be filled with cement concrete 1 : 3 : 6 (1 cement : 3 coarse sand : 6 brick bats 40 to 50 mm. nominal size) round the vent shaft upto ground level except top 150 mm. which shall be filled with C.C. 1 : 2 : 4 (1 cement : 2 coarse sand : 4 graded stone aggregate 20 mm. nominal size) and rendered smooth. The junction of vent shaft with cement concrete shall be grouted with cement mortar 1 : 1 (1 cement : 1 sand). The concrete work shall be cured for 7 days.

**2.4** The steel shaft shall be painted with silver paint (aluminum paint) 3 coats. The relevant specifications of item of painting shall be followed for painting.

**3.0 Mode of measurements & payment :**

**3.1** The rate shall include the cost of all labour and materials tools and plant etc. required for satisfactory completion of this item as directed above.

**3.2** The rate shall be for a unit of one number.

**24.00.1 (A)** *Providing and laying lime concrete 1 : 2 : 4 (1 cement : 2 fine sand : 4 graded brick aggregates 40 mm. nominal size) bedding for stoneware pipes of following internal diameters with necessary form work and curing complete 100 mm. dia. (112 mm. average bed thickness)*

**1.0 Materials :** Water shall conform to M-1. Lime mortar shall conform to M-10. Brick aggregate 40 mm. nominal size shall conform to M-14.

**2.0 Workmanship :** The relevant specifications of item No. 5.1, 8 shall be followed except that the proportion of mix shall be 1 : 2 : 4 (1 Lime putty : 2 fine sand : 4 graded brick bats aggregate 40 mm. nominal size) and the concrete work shall be done in trenches for bedding of stoneware pipes of 100

mm. dia. The width of concrete shall be 300 mm. and the thickness of bedding shall be 112 mm. average.

**3.0 Mode of measurements & payment :**

**3.1** The relevant specifications of item 24.2 (A) shall be followed.

**3.2** The rate shall be for a unit of one running meter.

**24.00.1 (B) Providing and laying lime concrete 1 : 2 : 4 (1 Lime putty : 2 fine sand : 4 graded brick aggregates 40 mm. nominal size) bedding for stoneware pipes of followings internal diameter with necessary form work and curing complete 150 mm. dia. (166 mm. average bed thickness)**

**1.0 Materials & Workmanship :** The relevant specifications of item No. 24.00.1 (A) shall be followed except that the concrete bedding shall be carried out for 150 mm. dia. stoneware pipe. The width of concrete bedding shall be 450 mm. and the average thickness shall be 166 mm.

**2.0 Mode of measurements & payment :**

**2.1** The relevant specifications of item No. 24.2 (A) shall be followed.

**2.2** The rate shall be for a unit of one running meter.

**24.17 (I) Extra over item 24.1. for providing salt glazed stoneware fittings : Bends of required degree (Any Radius) of following internal diameters : A-100 mm. dia. B-150 mm. dia.**

**1.0 Materials & Workmanship :** The relevant specifications of item No. 24.1 (A) shall be followed except that the salt glazed stone ware bends of any degree of specified diameter shall be provided.

**2.0 Mode of measurements & payment :**

**2.1** The relevant specifications of item No. 24.1 (A) shall be followed except that the extra payment shall be made for providing salt glazed stoneware bend of specified diameter of required degree of any radius over and above the rate of item No. 24.1.

**2.2** The rate shall be for a unit of one number.

**24.17 (II) Extra over item 24.1 for providing salt glazed stoneware fittings : Taper bend of required degree of following internal diameters : 100 mm. x 150 mm.**

**1.0 Materials & Workmanship :** The relevant specifications of item No. 24.1 (A) shall be followed except that the salt glazed stoneware taper bend of required degree of 100 mm. x 150 mm. shall be fixed.

**2.0 Mode of measurements & payment :**

**2.1** The relevant specifications of item No. 24.1 (A) shall be followed except that the extra payment shall be made for providing salt glazed stoneware taper bend of required degree of 100 mm. x 150 mm. size over and above the rate of item No. 24.1.

**2.2** The rate shall be for a unit of one number.

**24.17 (III) Extra over item 24.1 for providing salt glazed stoneware fittings : Single junction of required angle of following internal diameter (A) 100 mm. dia. (B) 150 mm. dia.**

**1.0 Materials & Workmanship :** The relevant specifications of item No. 24.1 (A) shall be followed except that the salt glazed stoneware single junction of required angle of specified diameter shall be fixed.

**2.0 Mode of measurements & payment :**

**2.1** The relevant specifications of item 24.1 (A) shall be followed except that the extra shall be paid for providing salt glazed stoneware single junction of required angle for specified diameters over and above the rate of item 24.1

**2.2** The rate shall be for a unit of one number.

**24.18** *Providing and laying jointing and pointing with stiff mixture of C.M. 1 : 1 (1 cement : 1 fine sand) 150 mm. internal diameter salt glazed stoneware half round channels.*

**1.0** **Materials & Workmanship :** The relevant specifications of item 24.1 shall be followed except that the half round channels of 150 mm. internal diameters shall be fixed in cement mortar 1 : 1.

**2.0** **Mode of measurements & payment :**

**2.1** The relevant specifications of item 24.1 (A) shall be followed.

**2.2** The rate shall be for a unit of one running metre.

**24.35** *Supplying and fixing C.I. cover 300 x 300 mm. without frame for gully trap (Standard pattern). The weight of cover to be not less than 4.53 Kg.*

**1.0** **Materials :** The C.I. cover of 300 x 300 mm. size shall be standard pattern and approved make the weight of C.I. cover shall not be less than 4.53 Kg. without frame.

**2.0** **Workmanship :** The C.I. cover 300 x 300 mm. size without frame shall be fixed on top of the brick masonry with cement concrete 1 : 2 : 4 (1 cement : 2 sand : 4 graded stone aggregate 20 mm. nominal size) 40 mm. thick and rendered smooth. The finished top of the cover shall be left about 40 mm. above the adjoining ground level so as to exclude the surface water from entering the gully trap.

**3.0** **Mode of measurements & payment :**

**3.1** The relevant specifications of item 24.19 shall be followed.

**3.2** The rate shall be for a unit of one number.

**24.41** *Constg brick masonry road gully chamber 500 mm. x 450 mm. 600 mm. incl. 500 mm. x 450 mm. C.I. horizontal gratings with frame complete.*

**1.0** **Materials :** Water shall conform to M-1. Cement shall conform to M-3. Sand shall conform to M-6. Brick shall conform size shall conform to M-12. Coal tar shall conform to relevant M-5.

**2.0** **Workmanship :**

**2.1** The chamber shall be of size 500 mm. x 450 mm. internal clear dimensions between the masonry wall faces. The height of 500 mm. shall be measured from the top of the bed concrete to the top of the C.I. frame. The size of the grating indicates the clear internal dimensions of the C.I. frame of the gratings.

**2.2** The excavation shall be done to true dimensions and levels.

**2.3** The foundation concrete shall consist of 150 cms. x 130 cms. 15 cms. thick C.C. 1 : 5 : 10 (1 cement : 5 sand : 10 graded stone aggregate 40 mm. nominal size).

**2.4** The wall of the chamber shall be constructed in brick work with C.M. 1 : 5 and 23 Cms. thick as per relevant specifications of item 6.12 (B).

**2.5** The walls and the bed concrete of chamber shall be plastered inside with 12 mm. thick cement plaster 1 : 3 (1 cement : 3 coarse sand) finished smooth.

**2.6** The gully grating cover shall be hinged to frame to facilitate its opening for leaning and repairs. The frame of the gully gratings shall be fixed on the top of masonry walls of the chamber in 15 cms. thick C.C. 1 : 2 : 4 (1 cement : 2 coarse sand : 4 graded stone aggregate 20 mm. nominal size) laid over the full thickness of walls.

**2.7** The chamber shall have connection pipe, the length of which in metre between the road gully chamber and the manhole of the drain shall not be less than 1/40 times the nominal diameter of the pipe in MM for 150 mm. connection pipe, the length shall not be less than 3.75 metre. The invert of the pipe at the junction with the wall shall be flush with the top of the cement plaster on the bed concrete.



- 2.8 Painting : After the completion of the work the exposed surface of the grating and the frame shall be painted with a thick coat of coaltar.
- 3.0 **Mode of measurements & payment :**
- 3.1 The cost of connection pipes is not included in the item and shall be paid separately. However fixing connection pipes in the walls of gully chambers is included in the rate for gully chambers and nothing extra shall be paid for this separately.
- 3.2 The rate includes all labour, and materials required for satisfactory completion of this item as described above.
- 3.3 The rate shall be for a unit of one sq. metre.
- 24.41 **Constg. brick masonry road gully chamber 450 mm. x 450 mm. x 775 with vertical grating complete.**
- 1.0 **Materials & Workmanship :** The relevant specifications of item 24.40 shall be followed except the size of road gully chamber is 450 mm. x 450 mm. 775 mm. with vertical grating complete.
- 2.0 **Mode of measurements & payment :**
- 2.1 The relevant specifications of item 24.40 shall be followed.
- 2.2 The rate shall be for a unit of one number.
- 24.42 **Constg. brick masonry road gully chamber 1100 mm. x 500 mm. x 775 mm. incl. 500 mm. x 450 mm. C. I. horizontal grating with frame and vertical grating complete.**
- 1.0 **Materials & Workmanship :** The relevant specifications of item 24.40 shall be followed except that the size of road gully chamber shall be 1100 mm. x 500 mm. x 775 mm. incl. 500 mm. x 450 mm. C.I. horizontal grating with frame and vertical grating with frame and vertical grating complete.
- 2.0 **Mode of measurements & payment :**
- 2.1 The relevant specifications of item 24.40 shall be followed.
- 2.2 The rate shall be for a unit of one sq. metre.
- 24.44 **(I) Constg. brick masonry chamber for underground C.I. inspection chamber and bends with brick having crushing strength not less than 35 Kg./Cm. in C.I. 1 : 5 C.M. cover with frame (light duty) 455 x 610 mm. internal dimensions, total weight of cover with frame to be not less than 38 Kg. (Wt. of cover 23 Kg. and Wt. of frame 15 Kg.) R.C.C. top slab with C.C. 1 : 2 : 4 mix (1 cement : 2 coarse sand : 4 graded aggregate 20 mm. size) foundation concrete 1 : 5 : 10 inside plaster 15 mm. thick with C.M. 1 : 3 finished smooth with a finishing coat of neat cement on walls and bed concrete etc. complete. Inside dimensions 450 mm. x 610 mm. and 450 mm. deep for single pipe line.**
- 1.0 **Materials :** Water shall conform to M-1. Cement shall conform to M-3. Coarse sand shall conform to M-5. Brick shall conform to M-15. Stone aggregate shall conform to M-12. Brick bat shaft shall conform to M-14. M.S. bar shall conform to M-18.
- 2.0 **Workmanship :**
- 2.1 C.I. inspection chamber with provision of C.I. bends of specified size with bolts, nuts and left washers for underground drain shall be enclosed in masonry chamber which shall be constructed as under :
- 2.2 The excavation shall be done true to dimensions and levels shown on the plans or as directed.
- 2.3 Bed concrete shall be of 15 cms. thick C.C. 1 : 5 : 10 (1 cement : 5 coarse sand : 10 graded brick bat aggregates). The projection of bed concrete beyond the masonry walls shall be 7.5 cms.

- 2.4 Masonry walls and plaster work shall be carried out as per relevant specifications of item 24-40.
- 2.5 The cover slab shall be constructed as per relevant specifications of 24.27 (I).
- 3.0 Mode of measurements & payment :**
- 3.1 The earth work in excavation providing and laying C.I. inspection chamber and bends shall be measured and paid for separately.
- 3.2 The rate shall be for a unit of one number.
- 24.44 (II) Constg. brick masonry chamber for underground C.I. inspection chamber and bends with brick having crushing strength not less than 35 Kg./CM<sup>2</sup> in C.M. 1 : 5 C.I. cover with frame (light duty) 455 x 610 mm. internal dimensions, total weight of cover with frame to be not less than 38 Kg. (Wt. of cover 23 Kg. and Wt. of frame 15 Kg.) R.C.C. slab with C.C. 1 : 2 : 4 mix (1 cement : 2 coarse sand : 4 graded stone aggregate 20 mm. size) foundation concrete 1 : 5 : 10 inside plaster 15 mm. thick with C. M. 1 : 3 finished smooth with a floating coat of neat cement on walls and bed concrete etc. complete. Inside dimensions 500 mm. 700 mm. and 450 mm. deep for pipe line with one or two inlets.**
- 1.0 Materials & Workmanship :** The relevant specifications of item 24.44 (I) shall be followed except that the inside dimension of brick masonry chamber shall be 500 mm. x 700 mm. and 450 mm. deep for pipe line with one or two inlets.
- 2.0 Mode of measurements & payment :**
- 2.1 The relevant specifications of item 24.44 (I) shall be followed.
- 2.2 The rate shall be for a unit of one number.
- 24.44 (III) Constg. brick masonry chamber for underground C.I. inspection chamber and bends with brick having crushing strength not less than 35 Kg./CM<sup>2</sup> in C.I. 1 : 5 C.M. cover with frame (light duty) 455 x 610 mm. internal dimensions, total weight of cover with frame to be not less than 38 Kg. (Wt. of cover 23 Ktg. and Wt. of frame 15 Kg.) R.C.C. top slab with 1 : 2 : 4 mix (1 cement : 2 coarse sand : 4 graded stone aggregate 20 mm. size) foundation concrete 1 : 5 : 10 inside plaster 15 mm. thick with C.M. 1 : 3 finished smooth with a finishing coat of neat cement on walls and bed concrete etc. complete. Inside dimensions 600 mm. 850 mm. and 450 mm. deep for pipe line with three or more inlets.**
- 1.0 Materials & Workmanship :** The relevant specifications of item 24.44 (I) shall be followed except that the inside dimension of brick masonry chamber shall be 600 mm. x 850 mm. and 450 mm. deep for pipe lines with three or more inlets.
- 2.0 Mode of measurements & payment :**
- 2.1 The relevant specifications of item 24.44 (I) shall be followed.
- 2.2 The rate shall be for a unit of one number.
- 24.46 Extra over item 24.44 for every additional depth 0.1 M or part thereof beyond 450 mm. depth for brick masonry chamber. (I) For 455 mm. x 610 mm. size (ii) For 500 mm. 760 mm. size (iii) For 600 mm. x 850 mm. size.**
- 1.0 Materials & Workmanship :** The relevant specification of item 24.44 (I), (ii), (III) shall be followed except that extra depth of 0.1 M. or part thereof shall be constructed over and above the depth of chambers of respective items.
- 2.1 The relevant specifications of item 24.4 (I) shall be followed except that extra shall be paid for providing additional dept. of 0.1 M. or part thereof over and above the item No. 24.44 (I), 24.44 (II), 24.44 (III) as the case may be.
- 2.2 The rate shall be for a unit of one number.
- 2.0 Mode of measurements & payment :**



**24.00.2 (A) Providing soak pit of 2 cum. volume incl. excavating and filling brick bats with dry masonry work at top for 450 cms. height incl. covering the top with stone incl. providing Vatas in C.M. 1 : 3 with finishing, curing etc. complete as directed.**

**1.0 Materials :** Water conform to M-1. Cement mortar shall conform to M-11. Burnt Bricks shall conform to M-15. Rough stone slab 40 x 50 mm. thick shall conform to M-48. Brick bat shall conform to M-14.

**2.0 Workmanship :**

**2.1** The excavation for soak pit shall be carried out as per relevant specifications of item 4.00.1. (A) except that the size of soak pit shall be such that the clear volume shall remain 2 cum. The diameter and depth shall be as directed.

**2.2** The periphery of the soak pit shall be provided with dry masonry with burnt bricks in 23 cm. thick. The masonry wall be done with best workman like manner in true line and plumb.

**2.3** The soak pit shall be filled in with brick bats of burnt brick 40 mm. nominal size in 45 cms. height. The work of filling brick-bats shall be done in such a way that no dry masonry shall be damaged during filling of brick bats.

**2.4** The top of the soak pit shall be covered with rough kotah stone slab 40 to 50 mm. thickness. The length of the stone shall be in single piece in length.

**2.5** The cement mortar 1 : 3 shall be used to fill up the joints and preparing vata as directed.

**2.6** The cement work shall be cured for 4 days.

**3.0 Mode of measurements & payment :**

**3.1** The rate includes coat of all labour and materials required for satisfactory completion of this item as described above.

**3.2** The rate shall be for a unit of one number.

**24.00.2 (B) Providing soak-pit of 5 cum. volume incl. excavating and filling brick-bats with dry masonry work at top for 45 cms. height incl. covering the top with stone incl. Providing Vatas in C.M. 1 : 3 with finishing curing etc. complete as directed.**

**1.0 Materials & Workmanship :** The relevant specifications of item 24.00.2 (A) shall be followed except that the volume of soak pit shall be 5 cum. clear.

**2.0 Mode of measurements & payment :**

**2.1** The relevant specifications of item 24.00.2 (A) shall be followed.

**2.2** The rate shall be for a unit of one number.

**EQUIVALENT PLAIN AREAS OF UNEVEN SURFACES***(Vide specifications for items relating to : Painting & Polishing)*

Sr. No.	Description of work	How measured	Multiplying Factor
1	Panelled or framed and braced or ledged and battened or ledged and braced joinery.	Measured flat (not girthed) including chowkhat or frame. Edges, chocks, cleats etc. shall be deemed to be included in the item.	1.30 (for each side)
2	Flush joinery	Measured flat (not girthed) including chowkhat or frame. Edges, chocks, cleats etc. shall be deemed to be included in the item.	1.30 (for each side)
3	Fully glazed or gauzed joinery	Measured flat (not girthed) including chowkhat or frame. Edges, chocks, cleats etc. shall be deemed to be included in the item.	0.80 (For each side)
4	Partly panelled and partly glazed or gauzed joinery.	Measured flat (not girthed) including chowkhat or frame. Edges, chocks, cleats etc. shall be deemed to be included in the item.	1.00 (For each side)
5	Fully venetioned or louvered joinery	Measured flat (not girthed) including chowkhat or frame. Edges, chocks, cleats etc. shall be deemed to be included in the item.	1.80 (For each side)
6	Weather boarding	Measured flat (not girthed) supporting frame work shall not be measured separately.	1.20 (For each side)
7	Wood single roofing	Measured flat (not girthed)	1.10 (For each side)
8	Boarding with cover fillets and match boarding.	Measured flat, (not girthed)	1.05 (For each side)
9	Tilo and State battening	Measured flat, over all : No deduction shall be made for open space.	0.80 (for painting all over)
10	Trellies (or Jafri) work one way or two way	Measured flat, over all : No deduction shall be made for open spaces, supporting members shall not be measured separately.	1.00 (For painting all over)
11	Guard bars, balustrades gates, gratings, grills, expanded metal and railings.	Measured flat, over all : No deduction shall be made for open spaces, supporting members shall not be measured separately.	1.00 (For painting all over)
12	Gates and open palisade fencing including standards.	Measured flat, over all : No deduction shall be made for open spaces, supporting members shall not be measured separately. (See Note)	1.00 (For painting all over)
13	Curved or enriched work	Measured flat	2.0 (For each side)
14	Steel roller shutters	Measured flat (size of opening) over	1.10 (For each

		all, jamb, guides bottom rails and locking arrangement etc. shall be included in the item (top cover shall be measured separately).	side)
15	Plain sheet steel door and windows	Measured flat (not girthed) including frame.	1.10 (For each side)
16	Measured flat (not girthed) including frame edges etc.		0.50 (For each side)
17	Partly paneled and partly glazed or gauzed steel doors.	Measured flat (not girthed) including frame edges etc.	0.80 (For each side)
18	Collapsible gate	Measured flat (size of opening) : no separate measurement shall be taken for the top and bottom guide rails rollers, fittings etc.	1.50 (For painting all over)

Note : The height shall be taken from the bottom of the lowest rail if the palisades do not go below it (or from the lower end of palisades, if they protect below the lowest rail) upto the top of palisades, but not upto the top of standards if they are higher than the palisades.

**CODE OF PRACTICE-13 (B) SCHEDULE OF FIXTURES AND FASTENINGS FOR DOORS, WINDOWS, VENTILATORS, WARDROBES AND CUPBOARDS.**

**NOTATIONS :**

Da	-	Teak wood doors fully panelled or fully glazed or partly panelled and glazed.
Db	-	Bathroom and W.C. door with single shutter
Dd	-	Doors battened ledged and braced
De	-	Doors battened ledged and braced.
Wa	-	Teakwood windows fully panelled or fully glazed or partly panelled and glazed.
Va : lud	-	Teakwood ventilators (independent)
S.W.	-	Steel Windows
SV-Ind	-	Steel ventilators (independent)
CB	-	Cupboard
S.1	-	Single shutter
S.2	-	Double shutter
S.4	-	Four shutter
B	-	Breadth of door shutter
T	-	Thickness of door shutter
H	-	Height of window shutter
900	-	900 mm and below
900	-	above 900 mm.
1200	-	1200 mm. & below
1200	-	above 1200 mm.





	Hinges									
27	Continuous Plano Hinges	30 width	-	-	-	-	-	-	-	-
28	Hasps and Staples (Safety types0	115x40	-	-	-	-	-	-	-	-
29	Hasps and Staples (Safety type)	90x40	-	-	-	-	-	-	-	-
30	Cupboard Lock (6 Levers)		-	-	-	-	-	-	-	-
31	Cupboard Lock		-	-	-	-	-	-	-	-





**NOTE : PLEASE READ CAREFULLY**

- (1) Where detailed specification of an item provides for specific size of any fixture or fastening that shall prevail over the provisions in this schedule.
- (2) Fixtures and fastenings (except hold fasts which shall be of M.S. Plate only) shall be of brass, copper oxidised brass, chromium plated brass, Iron, copper oxidised iron, or chromium plated iron as specified in the item of the work detailed specifications.
- (3) External door and door falling in staircase excepting the door in balcony shall have sliding door bolt of size 300 mm. x 18 mm. in place of 250 mm. 16 mm as shown in this schedule.
- (4) The length of tower bolts shown is for a door having shutter height upto 2100 mm. only. For door having shutter height more than 2100 mm., the length of tower bolt is to be increased to the extent of increase door shutter height beyond 2100 mm.
- (5) 150 mm. x 150 mm. size glass vision panel shall be provided in the doors of officer's chamber in addition to the scheduled provisions if so directed by the Engineer-in-charge.
- (6) Diamond shape chromium plated brass peeping plate of approved quality shall be provided in one entrance door in residential building in addition to the scheduled provisions.
- (7) Drawer in a wardrobe shall be provided with one furniture handle and one drawer lock (4 levers) in addition to its scheduled provision.
- (8) For door and window with steel frame, 75 mm. size screws shall be provided both in top and bottom frame for fixity as shown below.
  - (a) For width upto 1200 mm. 2 No.
  - (b) For width above 1200 mm. and upto 1800 mm. 3 No. 2
  - (c) For every additional width of 500 mm. over and above 1800 mm. 1 Nos.
- (9) When the mortice local (6 levers) and latch is specified to be provided to a door enter in the item of work itself or by a separate item, the requirement of providing sliding door bolt door latch and handles as per this schedules shall be dispense with.
- (10) For door/window with ventilator at top, fixtures and fastenings of door/window plus those of ventilator (excluding ho fasts) shall be used.
- (11) Where the item of work or its specification provides for anodised aluminium fixtures, all the fixtures except hinges and screws will be of anodised aluminium and chromium plated iron hinges and screws will be of anodised aluminium and chromium plated iron hinges and screws shall be used.
- (12) For door, window, or cupboard frame abutting concrete section, instead of hold fasts as shown in the schedule, coard screws of size as mentioned below shall be used :
  - (a) Teak wood frame 00.125 mm
  - (b) Steel frame 00.75 mm
- (13) The locking etc. in the door latch shall be so positioned that the door can be properly locked even if part of the latch when fully, slided, remains in the frame or masonry.
- (14) Showcase cupboards having single shutter shall be provided with ball catcher instead of tower bolt (barrel type) as per schedule.
- (15) The size of the handle shown in the schedule indicates grip length.
- (16) Door stopper shall be either floor door stopper or door catches directed by the Engineer-in-charge.
- (17) Piano hinges shall be for the fall height of the shutter.

- (18) Shutters with piano arrangements shall be provided with two pivots of approved size instead of hinges as per the schedule.
- (19) For butt hinges, only lengths are indicated in the schedule. The width of each flap being 5 mm. less than the thickness of the shutter to which they are to be fixed and the thickness of the flap shall be as specified in the relevant I.S.S. for heavy medium or light as specified in the of the item of work.

## SCHEDULE FOR TESTING OF MATERIALS (BUILDING)

For ensuring quality control and workmanship, various tests prescribed below corresponding to the material concerned shall be taken as periodic intervals below.

The material shall be got tested at GERI or Govt. recognized Laboratory or field Laboratory of GERI for which 1% of the estimated amount to tender shall be recovered from the R.A. Bill and Final Bill as the testing charges shall be paid by the govt. to the laboratory however if the charges increase over 1% no excess recovery shall be made from the contractor as per resolution of B & C department dated 10th May 1985 vide TNC/1085 (4) S.

Item No as per Sch. "B"	Brief Description of materials to be tested	Prescription of test which shall be carried out	Frequency @ which test shall be carried out (As per GERI Q.C. Vol,2002)	Qty. of materials	Total No. of test to be carried out
1	2	3	4	5	6
	Coarse Aggregate (Metal, gravel etc.)	Gradation test, impact, value, flakiness index, water absorption, stripping value	1/150 M3 for concrete or as per specification		
	Fine aggregate (Sand)	Gradation fineness modulus, specific gravity, water absorption, silt content	1/150 M3 for concrete or as per requirement of relevant specification		
	Bricks	Dimension and tolerance, water absorption, compressive strength, efflorescence	1 test per 50,000 Bricks 5 Bricks from (Sample) 5 Bricks from (Sample) 5 Bricks from (Sample)		
	C.C.Tiles	Water absorption Transverse strength abrasion size tolerances	1/2000 tiles (18 tiles for sample)		
	Cement Concrete	Compressive strength (I.S. 516-1959)	Qty. of C.C.M3      No. of Test 1-5                      1 Test 6-15                     2 Test 16-30                    3 Test 31-50                    4 Test 51 & Above            4+1 For		

			each Addnl. 50M3 or part thereof)	
	Cement	Consistency, setting time, compressive strength, fineness, chemical analysis, soundness	Up to 50 T 50-100 100-200 200-300 300-500 500-800 800-1300 and 8 test for lager consignment	1 Test 2 Test 3 Test 4 Test 5 Test 6 Test 7 Test
	Steel	Tensile strength yield stress elongation	1/40 tonnes / per category	
	Teak Wood	Anatomy test, density test, moisture content test	1 Test	

SIGN OF CONTRACTOR

EXECUTIVE ENGINEER

**GENERAL TECHNICAL SPECIFICATIONS OF ROAD WORK**

**Table of Content**

Sr.	Brief Description	Page No.
<b>General</b>		
1.	General	5
2.	Measurement of Lead for materials	5
3.	Surface Regularity of sub-grade & Pavement Course	5
4.	Quality control tests during construction	6
5.	Tests on Earthwork for Embankment construction	6
6.	Materials to conform to I.S.I	6
7.	Barrel Thickness of pipes of different class	7
<b>Standardized Items</b>		
1.	Earth work for embankment	8
1.A	from borrow pits within land width (including watering and consolidation at OMC)	8
1.B	from borrow pits within land (excluding watering and consolidation)	10
1.C	from borrow area (excluding watering and consolidation)	11
1.D	from borrow area (including watering and consolidation)	13
1.E	Rolling and watering of Earthwork	16
2.	Earth work in cutting in all sorts of soil and soft murrum including spreading the stuff	17
	(a) Within 200 metre lead in all lift, and	17
	(b) In spoil bank	18
3.	Supplying soft murrum or sand or yellow earth	18
4.	(a to f) Supplying standard size metal	19
4(a)	Supplying hand broken Stone Coarse aggregate of size 25mm to 90mm	19
4(b)	Supplying hand broken Stone Coarse aggregate of size 40mm to 63mm	20
4(c)	Supplying & Stacking machine crushed black trap metal of size 40mm to 50mm	21
4(d)	Supplying & Stacking machine crushed black trap metal of size 25mm to 40mm	21
4(e)	Supplying & Stacking quarry spauls at site of work	22
4(f)	Supplying & Stacking rubble of hard stone on road site with all lead & lifts	22
4A.	Providing and laying WBM of - mm. compacted thickness	23
5.	Spreading soft murrum or sand or yellow earth	28
6.	Spreading metal	28
7.	Compaction of metal	28
8.	Providing and fixing indicator stone	30
9.	Providing and fixing ordinary kilometre stone	30
10.	Providing and fixing fifth kilometre stone	30
11.	Providing and fixing hectometre stone	30
12.	Providing and fixing Guard stones	31
13.	Providing and fixing sign boards	31
14.	Providing and fixing village name boards	31
15.	Supplying machine crushed stone chips	32
	(a) Kapachi and	32
	(b) Grit	32
16.	Supplying Bitumen	32
17.	Laying 20 mm. thick open graded premix carpet with Seal Coat with departmental rolling	33
18.	Machine Laid Semidense bituminous carpet	35
19.	Semi Dense Carpet	39
	Ann. A-Technical Requirements of Hot Mix Plant	41
20.	40 mm Thick Asphaltic Concrete	41
21.	75 mm L B M in one or two layers each of 37.5 mm thickness	44
22.	DBM 50 mm Thick	46
23.	Pre-Mix Seal coat of 0.18 Cmt. per 10 Smt	48
24.	Special Conditions for Bituminius Surface work with use of Hot Mix Plant paver Finisher	50
25.	Dismantling [road and bridge items]	51
26.	Excavation for foundation in all sorts of soils and murrum including dewatering (for pipe culverts and slab drains only)	52
27.	-Do- in hard murrum	53
28.	-Do- in soft roack	53

**General Technical Specifications for Road Works**

Sr.	Brief Description .....	Page No.
<b>29.</b>	<b>-DO- ih hard roack .....</b>	<b>54</b>
	(a) requiring blasting and	
	(b) blasting prohibited	
30.	U.C.R. masonry for foundation and plinth in C.M.....	55
31.	C.R masonry for super structure in C.M.....	57
32.	Brick masonry in C.M .....	57
33.	Supplying and fixing NP. 3 class R.C.C. Pipes .....	58
34.	Supplying and fixing NP 2 class R.C.C. Pipes .....	59
35.	Supplying and fixing NP 1 class R.C.C. Pipes .....	59
36.	Filling around pipes.....	59
37.	Ordinary concrete [without reinforcement].....	59
38.	Ordinary reinforced concrete .....	63
39.	Providing steel reinforcement	
	(a) Mild Steel reinforcement.....	63
	(b) High yield strength deformed bars reinforcement.....	63
40.	Cement Pointing C.M.....	65
41.	Stone pitching and murrum bedding [without cement pointing].....	65
42.	Premoulded Expansion joints .....	66
43.	R.C.C. parapet wall .....	66
44.	Cement plaster in C.M .....	66
45.	Box cutting of the road surface to proper, slope and camber for making abase for road work ....	67
46.	Providing open graded carpet with premix H.M.P. and P.F.....	67
47.	Providing mix seal surfacing (H.M.P.) .....	68
48.	Providing and laying 20/25 mm thick asphalt (H.M.P.).....	68
49.	Surface dressing ..-.....	69
50.	Providing and laying built up spray grout (B.S.G.) .....	71
51.	Providing and laying L.C.C. (1:5:10) in foundation and plinth .....	72
52.	White washing.....	73
53.	Providing and fixing 4" DIA G.I. water spouts... ..	73
54.	Providing year plate and number plate .....	73
55.	Numbering the C.D. works .....	74
56.	Providing and fixing junction board of R.C.C. precast .....	74
<b>56(A).</b>	<b>Providing and fixing board of M.S. plate with two angles iron posts &amp; fixing concretes 1:2:4 ....</b>	<b>74</b>
57.	Providing and fixing boundary stone .....	75
58.	Clearing the site before commencement and after completion of work.....	75
59.	Supplying and fixing Kota stone 60 to 80 mm. size including fixing line and level etc. complete	75
60.	Providing and laying Kota stone for kerbing on both side of stone paving etc. complete :	75
61.	Supplying Hard Murrum .....	75
62.	White stone bela masonry in c.m. 1:5 including curing etc. complete .....	76
63.	40 mm Thick asphalt carpet.....	76
64.	Providing 75 mm thick premix asphalt macadam using 611.0 Kg asphalt 10.80 cu. mt. chips for 100 sq. Mts .....	77
65.	Earth work in cutting in hard murrum and builders .....	79
66.	U.C.R. Masonary for super structure in c.m. 1: 6 .....	79
67.	Earth work in cutting in soft rock not requirng blasting .....	79
68.	Supplying and stacking rubble.....	79
69.	Carting and stacking of scarcity hand broken metal on site with all lead including filling the boxes	79
70.	Providing & laying 50 mm. thick bituminous macadam .....	80
71.	Providing and laying C.C. (1:5:10).....	82
72.	Supplying unscreened gravel.....	84
73.	Filling available excavated earth .....	85
74.	Providing and fixing junction board of. M.S. Plate.....	85
75.	Scaryfying gravelled macadam .....	86
76.	Extra for dewatering in foundation .....	86
77.	Supplying and stacking of rubble .....	86
<b>78.</b>	<b>Jungle cutting for road side.....</b>	<b>86</b>
	Schedule for testing of material .....	87

**BHAVNAGAR MUNICIPAL CORPORATION - BHAVNAGAR**

<b>Sr. No. of the item In the Schedule "B" of the tender</b>	<b>Sr. No. of the applicable enclosed specifications</b>
1	
2	
3	
4	
5	
6	
7	
8	
9	
10	
11	
12	
13	
14	
15	
16	
17	
18	
19	
20	
21	
22	
23	
24	
25	
26	
27	
28	
29	
30	
31	
32	
33	
34	
35	
36	
37	
38	
39	
40	
41	
42	
43	
44	
45	
46	
47	
48	

<b>Sr.No. of the item in the Schedule "B" of the tender.</b>	<b>Sr.No. of the applicable enclosed specifications</b>
49	
50	
51	
52	
53	
54	
55	
56	
57	
58	
59	
60	
61	
62	
63	
64	
65	
66	
67	
68	
69	
70	
71	
72	
73	
74	
75	
76	
77	
78	
79	
80	
81	
82	
83	
84	
85	
86	
87	
88	
89	
90	
91	
92	
93	
94	
95	
96	

# GENERAL TECHNICAL SPECIFICATIONS

## 1.0 General :

All measurements shall be made in the metric system. Different items of work shall be measured in accordance with the procedures set forth in the relevant sections read in conjunction with General Conditions of Contract. The same shall not however apply in the case of lump-sum items. All measurements and computations; unless otherwise indicated, shall be carried nearest to the following limits :

- (i) length and breadth..... 10mm
- (ii) height, depth or thickness of earthwork,  
sub-base, bases, surfacing, and structural members...5mm
- (iii) areas,..... 0.01 Sq. Metre
- (iv) cubic contents..... 0.01 cubic metre

in recording dimensions of work the sequence of length, width and height or depth or thickness shall be followed.

## 2.0 Measurement of lead for Materials :

Where lead is specified in the contract for construction materials, the same shall be measured as described hereunder.

Lead shall be measured over the shortest practicable route and not the one actually taken and the decision of the Engineer-in-charge in this regard shall be taken as final. Distance upto and including 100 metres shall be measured in units of 50 metres, exceeding 100 metres but not exceeding 1 KM. in units of 100 metres, and exceeding 1 km. in units of 500 metres. The half and greater than half of the units shall be reckoned as one and less than half of the units ignored. In this regard, the source of the material shall be divided into suitable blocks and for each block the distance from the centre of the block to the centre of placing pertaining to that block shall be taken as the lead distance.

## 3. Surface Regularity of Sub grade & Pavement Courses :

The surface regularity of completed sub-base courses and wearing surfaces in the longitudinal and transverse directions shall be within the tolerances indicated in Table below. The longitudinal profile shall be checked with a 3 metre long straight edge, at the middle of each traffic lane along a line parallel to the centre line of the road. The transverse profile shall be checked with a set of three camber boards at intervals of 10 metres.

**PERMITTED TOLERANCES OF SURFACE REGULARITY FOR PAVEMENT COURSES**

Sr.	Type of Construction	Longitudinal Profile with 3 metre straight edge				Cross Profile Maximum permissible variation from specified profile camber template – mm	
		Maximum Permissible undulation in mm	Maximum number of undulation permitted in any 300m. length exceeding in mm.				
			18	12	10	6	
1	2	3	4	5	6	7	8
1	Earth Sub grade	36	30	-	-	-	15
2	Granular / lime / Cement Stabilised Sub – base.	23	-	30	-	-	12
3	Water Bound Macadam with nominal size metal (20-50) mm	18	-	-	30	-	8
4	Semi – Dense Carpet @	15	-	-	-	20	6



**Notes:-**

1 . @ @ These are for machine laid surfaces. If laid manually, due to unavoidable reason, tolerance upto 50 percent above these values in this column may be permitted. However, this relaxation does not apply to the values of maximum undulation for longitudinal and cross profiles mentioned in columns 3 and 8 in the table.

2. Surface evenness requirements in respect of both the longitudinal and cross profiles should be simultaneously satisfied.

3. **Rectification** : Where the surface irregularity of subgrade and the various pavement courses fall outside the specified tolerances, the contractor shall be liable to rectify these in the manner described below and to the satisfaction of the Engineer-in-charge at his own cost.

**(i) Subgrade** : Where the surface is high, it shall be trimmed and suitably compacted. Where the same is low, the deficiency shall be corrected by adding fresh material. The degree of compaction and the type of material to be used shall conform to the specified requirements.

**(ii) Granular/Sub-base** : Same as at (i) above except that the degree of compaction and the type of material to be used shall conform to the specified requirements.

**(iii) Lime/Cement stabilized soil sub-base** : For Lime/Cement treated materials where the surface is high, the same shall be suitably trimmed while taking care that the material below is not disturbed due to this operation. However, where the surface is low, the same shall be corrected as described herein below.

For cement treated material, when the time elapsed between detection of irregularity and the time of mixing of the material, is less than 2 hours, the surface shall be scarified to a depth of 50 mm, supplemented with freshly mixed material as necessary and recomposed to the relevant specification. When this time is more than 2 hours, the full depth of the layer shall be removed from the pavement and replaced with fresh material, to specification. In either case, the area treated shall not be less than 5 metres long by 2 metres wide. This shall also apply to lime treated material except that the time criterion shall be 3 hours instead of 2 hours.

**(iv) Water Bound Macadam Base** : Where the surface is high or low, the top 75mm shall be scarified, reshaped with added material as necessary and recompacted. The area treated at a place shall not be less than 5 metres long and 2 metres wide.

**(v) Bituminous Constructions** : For bituminous constructions, other than wearing course, where the surface is low, the deficiency shall be corrected by adding fresh material and recompaction to specifications. Where the surface is high, the full depth of the layer shall be removed and replaced with fresh material and compacted to specifications. For wearing course, where the surface is high or low; the full depth of the layer shall be removed and replaced with fresh material and compacted to specifications in all cases where the removal and replacement of a bituminous layer is involved, the area treated shall not be less than 5 metre long and not less than 1 lane wide.

**4. Quality Control Tests During Construction :**

The materials supplied and the works carried out by the Contractor shall conform to the enclosed relevant specifications. For ensuring the requisite quality of construction, the materials and works shall be subjected to quality control test as described hereinafter, by the Engineer-in-charge. The testing frequencies set forth are the desirable minimum and the Engineer-in-charge shall have the full authority to carry out test as frequently as he may deem necessary to satisfy that the materials at work comply with the appropriate specifications. Test procedures for the various quality control tests are indicated in the respective sections of the specifications or for certain tests within this section. Where no specific testing procedure is mentioned, the test shall be carried out as per prevalent accepted engineering practice to the directions of the Engineer-in-charge.

**5. Tests on Earthwork for Embankment Construction :**

**5.1 Borrow Material :**

- (a) Sand Content (IS : 2720 Part IV)  
Two test per 8000 Cubic Metres of soil.
- (b) Plasticity Test (IS : 2720 Part-V)  
Each type to be tested. Two tests per 8000 Cubic Metres of soil.

- (c) Density test (IS : 2720 Part VII)  
Each soil type to be tested. Two tests per 8000 Cubic Metres of soil.
- (d) Moisture Content Test (IS : 2720 Part-II) One test for every 250 Cubic Metres of soil.

**5.2 Compaction Control :**

Control shall be exercised by taking at least one measurement of density for each 1000 square metres of compacted area, or closer as required to yield the minimum number of test results for evaluating day's work on statistical basis. The determination of density shall be in accordance with IS. : 2720 (Part XXVMI). Test locations shall be chosen only through random sampling techniques. Control shall not be based on the result of any one test but on the mean value of a set of 5-10 density determinations. The number of tests in one set of measurements shall be 5 as long as it is felt that sufficient control over borrow material and the method of compactions is being exercised-. If considerable variations are observed between individual density results, the minimum number of tests in one set of measurement shall be increase to 10.. The acceptance of work shall be subject to the condition that the mean dry density equals or exceeds the specified density and the standard deviation for any set of results is below 0.08 gm/cc. However for earthwork in shoulders and in top 500 mm portion of the embankment below the sub grade, at least one density measurement shall be taken for every 500 square meters of the compacted area provided further that the number of the tests in each set-of measurement shall be at least 10. In other respects, the control shall be similar to that described earlier.

**6. Following materials shall conform to the Indian Standards shown against them :**

- (1)....Cement..... IS : 269
- (2)....Sand for masonry. IS :2116
- (3).....Sand for concrete. IS : 383
- (4)... Coarse aggregate. IS : 383
- (5).....Mild Steel... IS : 432
- (6)....High yield strength deformed bars
- .....(a) Hot Rolled ..... IS : 1139
- .....(b) Cold Twisted ..... ' ..... IS : 1786

**7. Barrel thickness of pipes of different class shall be as under :**

Sr.No.	Internal Diametre of pipe in mm	Barrel thickness ( in mm).		
		NP1	NP2	NP2
1	80	25	25	-
2	100	25	25	-
3	150	25	25	-
4	250	25	25	-
5	300	30	30	-
6	350	32	32	75
7	400	32	32	75
8	450	35	35	75
9	500	-	35	75
10	600	-	40	80
11	700	-	40	80
12	800	-	45	90
13	900	-	50	100
14	1000	-	55	100
15	1100	-	60	115
16	1200	-	65	115

**STANDARD TECHNICAL SPECIFICATIONS FOR ROADWORKS**

**ITEM 1-A Earthwork for embankment including clods, dressing with ail lead and lift (including watering and consolidation) (a) From 'borrow pits within Sand width.**

1. The land width on which the earth work is to be done shall be cleared of all trees having a girth of 30 cm and less, loose stones, vegetation, bushes, stumps and all other objectionable materials. All the materials cleared will be the property of Government. Useful material shall be arranged in convenient stacks along the roads boundary or as directed at places within 50 metres lead, and handed over to the department in convenient sections. Unsuitable material shall be burnt or otherwise disposed off by the contractor at his own cost without causing any nuisance, inconvenience or damage to the works, property or people in the neighborhood. In all cases, the materials shall be disposed off in a neat manner.
2. After clearing the site, the alignment of the road shall be properly set out true to line, curves, slopes, grades and sections as shown on then plan or directed by the Engineer-in-charge. The contractor shall provide all labours and materials such as lime, string, pegs, nails, bamboos, stones, mortar, concrete etc. required for setting out, establishing Bench Marks and giving profiles. The contractor shall be responsible for maintaining the B.M.S. profiles alignments and other marks as long as they are required for the work in the opinion of the Engineer-in-charge. If the contractor defaults in this respect they may be restored by the department at the cost of the contractor.
3. When an existing embankment is to be widened, continuous, horizontal benches, each at least 0.3 metre wide, shall be cut into existing slope for ensuring adequate bond with the fresh embankment material to be added. The material obtained from the cutting of benches can be utilised in the widening of the embankment. Where the width of the widened portions is insufficient to permit the use of usual rollers, compactions shall be carried out with the help of tandem/sheepfoot rollers, mechanical tampers or other approved plant. The dumping of material from trucks for widening operations shall be avoided except in difficult circumstances when the extra width is too narrow to permit the movement of any other type of hauling equipment.
4. The soil to be used for embankment shall be free from trees, stumps, roots, rubbish or any other objectionable materials. Only materials considered suitable by the Engineer-in-charge shall be used for the construction and that considered unsuitable shall be disposed off as directed by him. The selection of materials to be used in the construction of embankment shall be made after soil survey and investigations are carried out by the Department. The embankment shall consist of earth available from road-side borrow pits on either side' with all lead and lifts.
5. The materials satisfying the density requirements given the table shall be employed for embankment construction.

Type of work	Laboratory Dry Density when tested as per IS : 2720 (Pt.VII)
- Embankment up to 3 metre height	Not less than 1.44 gm/cc
- Embankment exceeding 3 metre height or embankment of any height subject to long period of inundation.	Not less than 1.52 gm/cc
- Top 0.5 metre of embankment below the sub grade level and shoulder [Where earth shoulder are specified]	Not less than 1.65 gm/cc

Field density shall be a percentage of laboratory density as recommended by the Gujarat Engineering research institute. Location, shape and size of borrow pits shall be as indicated by the Engineer-m-charge. Pits shall not be dug continuously. Ridges of not less than 8 metres width should be left at intervals not exceeding 300 metre. Small drain shall be cut through the ridges of facilities drainage. The outer edge of borrow pits shall be so regulated that the bottom does not cut an imaginary line having a slope of 1 vertical to 4 horizontal projected from the edge of final section of the bank, the maximum depth in any case being limited to 1.5 metres. Also no pits shall be dug within 5 metres of the tow of the final section of the road embankment.

- 5.1 No borrow pits shall be allowed at the following sites along the road.
  - (i) upto 30 metres on either side of C.D. Works;
  - (ii) upto 15 metres on either side of cart rack crossing for which approaches are to be constructed
  - (iii) in the length in which earth obtained from cutting is specified to be used in the embankment.
- 5.2 If there is top layer of black cotton or other objectionable soils, the same shall be removed and disposed off elsewhere and usable material found at lower level will only be used in earthen embankment.

6. The embankment shall be constructed in uniform layers not exceeding 250 mm in loose thickness. The soil shall be spread uniformly over the entire width of the embankment. Unless otherwise directed by The Engineer-in-charge. The consolidation including watering and rolling of earthwork shall be carried out by the Department, The operation of laying the successive layer of earth shall have to be suitably synchronized with the consolidation work. If the soil as delivered to the road is too wet, it shall be dried by exposure to the sun till the moisture content is acceptable for compaction. All clods of hard lumps of earth shall be broken to have maximum size of 15 cm. when being placed in the embankment and a maximum size of 5 cm. when being placed in the top 45 cm. of the embankment. The work of next layers shall be allowed only after the first layer below it has been thoroughly compacted to the density specified.

7. Where an embankment is to be placed on sloping ground, the surface of the ground shall be benched in the step of trenches or broken up in such a manner that the new material shall have perfect bond with the existing surface. Where the embankment is to be placed over an existing surface, the new material. However when the embankment is to be placed over an old concrete, pavement shall be broken up in pieces not to exceed 0.1 m and may be left under the new-embankment. If the existing road surface is of granular or bituminous type and lies within 1 mt. of the new subgrade level, the same shall be scarified to a depth of minimum 50 mm. so as to provide ample bond between the old and the new material.

8. To avoid interference with construction of abutments, wing walls or return walls of culverts/bridge structures, the contractor shall, at point to be determined by the Engineer-in-charge, suspend work on embankments forming approaches to such structures, until such time as the construction of the latter is sufficiently advanced to permit the completion of approaches without the risk of interference of damage to the bridge work. Unless directed otherwise the filling around culverts, bridge and other structures up to a distance of twice the height of the embankment from the back of the embankment shall be carried out independent of the work on the main embankment. The fill materials shall not be placed against any abutment or wing wall unless permission has been given by the Engineer-in-charge but in any case not until the concrete or masonry has been in position for 14 days. The embankment shall be brought up simultaneously in equal layers on each side of the structure to avoid displacement and unequal pressure. The sequence of work in this regard shall be got approved from the Engineer-in-charge. Where the provision of any filter medium is specified behind the abutment, the same shall be laid in layers simultaneously with the laying of fill material the material used for the filler shall confirm to the requirement rollers or other heavy equipment, the compaction shall be carried out by mechanical tampers or other methods approved by the Engineer-in-charge. Care shall be taken to see that the compaction plant does not hit or come too close to any structural members so as to cause any damage to them.

9. The embankment shall be finished in conformity with the alignment, level, cross sections and dimensions shown on the plans or as directed by the Engineer-in-charge. Where the alignment of the road is in a curve, the top of the embankment shall be formed with the super elevation and the increased width shown on the drawings or as the Engineer-in-charge may direct. Finishing operations shall include the work of shaping and dressing the shoulder, road bed and the slopes to conform to the cross section.

10. The consolidation of earth work including rolling and watering at O.M.C. as per laboratory requirement shall be carried out by the Department, the field and laboratory investigations and testing of samples shall be carried out by the department. However, the contractor shall give full co-operation and shall bear the charges for layout and collection of samples for testing at authorized Government laboratory. The work of laying of earthwork in layers shall be synchronized with the work of compaction and consolidation of the earth work and the operations shall also be synchronized with the field and laboratory testing. When density measurements reveal any soft areas in the embankment, the Engineer-in-charge shall direct that these areas shall be compacted further. In spite of that, specified compactions is not achieved, the materials in the soft area shall be removed as directed and replaced by the approved materials. Deduction of 15% shall be made for the shrinkage from the sectional measurements to be paid to the contractor, if measured before first monsoon and 10% measured after one or more monsoon have passed over the earth embankment.

11. The earth work measurements shall be paid on cross sectional measurements and computing the volumes of earth-work in cubic metres by average area method. The contractor shall sign day to day leveling work and also original cross sections in token of his acceptance etc. The working sections both longitudinal and cross of the ground shall be taken by the Engineer-in-charge before the actual earth work is started. The contractor or his authorised representative shall attend day to day leveling work and sign with date the field book daily, in token of this acceptance. If there is any disagreement the contractor shall inform of it in writing to the officer concerned of any complaint shall be taken. Merely not signing of the level book shall not be deemed as disagreement. The Executive Engineer shall also verify leveling work to the extent of 5% before commencement of earth work and on finalisation. The contractor shall maintain the embankment by filling in ruts, rain cuts depression due to shrinkage

etc. to proper formation and grade till this item is finally measured and accepted by the Department. The measurement shall be taken on compacted earth work, no deduction for shrinkage shall be made from gross measured quantity of compacted earth work. However the contractor shall have to bear loss of quantity due to all settlement as well as other types of deformations etc. if any that might have taken place at the time of taking the final measurement of this item. If the Compaction as stipulated in para-10 is not done by the department in that case shrinkage from such earthwork quantity shall be deducted as per norms, i.e. 10% after monsoon and 15% before monsoon. 12. The rate of earthwork includes clearing jungles, dogbelling, fixing profiles, erecting necessary pillars or stones for bench mark for leveling purpose, excavating earth from borrow pits, breaking clods, conveying and spreading earth in layers with all lead and lift, finishing the entire embankment to the proper profile camber, grade and slopes. The rate also includes all labour, materials, tools, equipment and incidentals necessary to complete the work according to the specifications. Cutting stuff of cutting in ordinary soil, soft murrum, soft rock, hard murrum and hard rock shall be utilised in embankment construction under this item within the lead specified in that particular item. No payment shall be made under this item for the cutting stuff used in the embankment but labour for cutting will be paid as per specifications in the particular item and only balance quantity brought from borrow pits will be paid in this item.

**ITEM 1-B Earthwork for embankment including breaking clods, dressing with all lead and lift (excluding watering and consolidation) (a) From borrow pits within land width.**

1 . The land width on which the earth work is to be done shall be cleared of all tree having a girth of 30 cm and less, loose, stones, vegetation, bushes, stumps and all other objectionable materials. All the materials cleared will be the property of Government. Useful material shall be arranged in convenient stacks along the road boundary or as directed at places within 50 metres lead, and handed over to the department in convenient section. Unsuitable material shall be burnt or otherwise disposed off by the contractor at his own cost without causing any nuisance, inconvenience or damage to the works property or people in the neighborhood. In all cases, the materials shall be disposed, off in a neat manner.

2. After clearing the site, the alignment of the road shall be properly set out true to line, curves, slopes, grades and sections as shown on the plan or directed by the Engineer in-charge. The contractor shall provide all labours and materials such as lime, strings, pegs, nails, bamboos, stone, mortar, concrete, etc. required for setting out, establishing. Bench Marks and giving profiles. The contractor shall be responsible for maintaining the B. Ms. profiles alignments and other marks as long as they are required for the work in the opinion of the Engineer-in-charge. If the contractor defaults in this respect they may be restored by the department at the cost of the contractor.

3. When an existing embankment is to be widened, continuous, horizontal benches, each at least 0.3 metre wide shall be cut into the existing slope for ensuring adequate bond with the fresh embankment of the embankment. The dumping of material from trucks for widening operations shall be avoided except in difficult circumstances when the extra width is too narrow to permit the movement of any other type of hauling equipment.

4. The soil to be used for embankment shall be free from trees, stumps, roots, rubbish or any other objectionable materials. Only material considered suitable by the Engineer-in-charge shall be used for the "construction and that considered unsuitable other disposed off as directed by him. The selection of the materials to be used in the construction of embankment shall be made after soil surveys and investigations carried out by the Department. The embankment shall consist of earth available from road side borrow pits on either side with all lead and all lifts.

5. Location, shape and size of borrow pits shall be as indicated by the Engineer-in-charge. Pits shall' not be dug continuously. Ridges of not less than 8 metres width should be left at interval not exceeding 300 metres. Small drain shall be cut through the ridges of facilitate drainage. The outer edge of borrow pits shall be so regulated that the bottom does not cut an imaginary line having a slope of 1 vertical to 4 horizontal projected from the edge of final section of the bank, the maximum depth in any case being limited to 1.5 metres. Also no pits shall be dug within 5 metres of the toe of the final section of the road embankment.

5.1 No borrow pits shall be allowed at the following sites along the road,

(i) up to 30 metres on either side of C.D. Works.

(ii) up to 15 metres on either side of cart track crossing for which approaches are to be constructed.

5.2 If there is top layer of black cotton or other objectional soils, the same shall be removed and disposed off elsewhere and usable material found at lower level will only be used in the embankment.

6. The embankment shall be constructed in uniform layers not exceeding 250 mm in loose thickness. The soil shall be spread uniformly over the entire width of the embankment, unless otherwise directed by the Engineer-in-charge. The consolidation including watering and rolling of earth work shall be carried out by the



Department. The operation of Laying the successive layer of earth shall have to be suitably. All clods of hard lumps if earth shall be broken to have maximum size of 15 cm. when being placed in the embankment and a maximum of size 5 cm when being placed in the top 45 cm of the embankment. The work of next layer shall be allowed only after the first layer below it has been thoroughly compacted.

7. Where an embankment is to be placed on sloping ground, the surface of the ground shall be benched in the steps of trenches or broken up in such a manner that the new material shall have perfect bond with the existing surface. Where the embankment is to be placed over an existing road surface, the surface shall be scarified to minimum depth of a 5 cm so as to provide ample bond between the old and new material. However when the embankment is to be placed over an old concrete pavement and lies within 1 metre of new subgrade level the pavement shall be broken up in pieces not to exceed 0.1 m. and may be left under the new embankment. If the existing road surface is of granulate or bituminous type and lies within 1 mt. of the new subgrade level, the same shall be scarified to a depth of minimum 50 mm. so as to provide ample bond between the old and the new material.

8. To avoid interference with the construction of abutment, wing walls or return walls of culverts/bridge structures, the contractor shall, at point to be determined by the Engineer-in-charge, suspend work on embankments forming approaches to such structures, until such time as the construction of the latter is sufficiently advanced to permit the completion of approaches without the risk of interference or damage to the bridge work. Unless directed otherwise, the filling ground culverts, bridges and other structures up to a distance of twice the height of the embankment. The fill material shall not be placed against any abutment or wing wall unless permission has been given for 14 days, the embankment shall be brought up simultaneously in equal layers on each side of the structure to avoid displacement it and unequal pressure. The sequence of work in this regard shall be got approved from the Engineer-in-charge. Where the provision of any filter medium is specified behind the abutment, the same shall be laid in layers simultaneously with the laying of fill material. The material used for the filter shall conform to the requirements for filler medium and will be paid extra in the relevant item.

9. The embankment shall be finished in conformity with the alignment, levels, cross sections and dimension shown on the plans or as directed by Engineer-in-charge. Where the alignment of the road is in a curve, the top of the embankment shall be formed with the super elevation and the increased width shown on the drawings or as the Engineer-in-charge may direct. Finishing operations shall include the work of shaping and dressing the shoulders, road bed and the side slopes to conform the cross section.

10. The earthwork measurements shall be paid on cross sectional measurements and computing the volumes of earth work in cubic metres by average area method. The contractor shall sign day to day leveling work and also original cross section, longitudinal section etc. in token of his acceptance. The working sections both longitudinal and cross of the ground shall be taken by the Engineer-in-charge before the actual work is started. The contractor or his authorised representative shall attend day to day leveling work and sign with date the field book daily, in token of his acceptance. If there is any disagreement the contractor shall inform of it in writing to the officer concerned with specific reference to the sections before starting further work. Once the work is started, no cognizance of any complaint will be taken. Merely not signing of level book shall not be deemed as disagreement. The Executive Engineer shall also verify leveling work to the extent of 5% before commencement of earth work and on finalisation. The contractor shall maintain the embankment by filling in ruts, rain cuts, depression due to shrinkage etc. to proper formation and grade till this item is finally measured and accepted by the Department. The measurements shall be taken on compacted earth work. If the compaction as stipulated in para above is not done by the department in that case shrinkage from such earth work quantity shall be deducted as per norms i.e. 10 percent after monsoon and 15% before monsoon. However the contractor shall have to bear loss of quantity due to all settlements as well as other types of deformations etc. if any, that might have taken place at the time of taking the final measurements of this item.

11. The rate of earthwork includes, clearing jungles, bogoelling, fixing profiles, erecting necessary pillars for stones for bench marks for leveling purpose, excavating earth from borrow areas, breaking clods, conveying and spreading earth in layers with all lead and lift, finishing the entire embankment and incidentals necessary to complete the work to the specifications. The cutting stuff of cutting in ordinary soil, soft murrum, soft rock, hard murrum and hard rock shall be utilised in embankment construction under this item within the lead specified in the particular item. No payment shall be made under this item for the cutting stuff used in the embankment but labour for cutting will be paid as per specifications in the particular item, and only balance quantity of earthwork brought from borrow areas will be paid in this item.

**ITEM 1-C Earthwork for embankment for side shoulders including breaking clods, dressing with all lead and lift (excluding watering and consolidation) (b) From borrow pits within \_ kms. lead.**

1. The land width on which the earth work is to be done shall be cleared of all trees having a girth of 30 cm and less, loose stones, vegetation, bushes, stumps and all other objectionable materials. All the materials cleared will

be the property of Government. Useful material shall be arranged in convenient stacks along the road boundary or as directed at places within 50 meters lead, and handed over to the department in convenient section. Unsuitable materials shall be burnt or otherwise disposed off by the contractor at his own cost without causing any nuisance, inconvenience or damage to the works property or people in the neighborhood. In all cases, the materials shall be disposed off in a neat manner.

2. After clearing the site, the alignment of the road shall be properly set out true to line, curves, slopes, grades and sections as shown on the plan or directed by the Engineer-in-charge. The contractor shall provide all labours and materials such as lime, strings, pegs, nails, bamboos, stone, mortar, concrete, etc.. required for setting out. establishing. Bench Marks and giving profiles. The contractor shall be responsible for maintaining the B. Ms. profiles alignments and other marks as long as they are required for the work in the opinion of the Engineer-in-charge. If the contractor defaults in this respect they may be restored by the department at the cost of the contractor.

3. When an existing embankment is to be widened, continuous, horizontal benches, each at least 0.3 metre wide shall be cut into the existing slope for ensuring adequate bond with the fresh embankment materials to be added. The material obtained from the cutting of benches can be utilised in the widening of the embankment. The dumping of material from trucks for widening operations shall be avoided except in difficult circumstances when the extra width is too narrow to permit the movement of any other type of hauling equipment.

4. The soil to be used for embankment shall be free from trees, stumps, roots, rubbish or any other objectionable materials Only material considered suitable by the Engineer-in-charge shall be used for the construction and that considered unsuitable other disposed off as directed by him. The selection of the materials to be used in the construction of embankment shall be made after soil surveys and investigations carried out by the Department The embankment shall consist of earth available from road-side borrow pits on either side with all lead and all lifts and within land width in the manner specified in para 11 bellow. The road, if any required for the purpose of haulage of earth by men, animals or vehicles will be constructed.(if not existing)and maintained by the contractor at his own cost.

5. Department ill extend all necessary co-operation in helping contractor to get borrow area from nearby Government or Panchayat land, if available. However. department is not responsible if not such area is made available to the contractor and in the case, contractor will have-to make his own arrangement to get borrow area for borrowing earth of the quantity even by making temporary arrangement with the private land owners.

6. The embankment shall be constructed in uniform layers not exceeding 250 mm in loose thickness. The soil shall be spread uniformly over the entire width of the embankment, unless otherwise directed by the Engineer-in-charge. All clods of hard lumps of earth shall be broken to have maximum size of 15 cm .when being placed in the embankment and a maximum of size 5 cm when being placed in the top 45 cm of the embankment. The work of next layer shall be allowed only after the first layer below it has been thoroughly compacted.

7. Where an embankment is to be placed on sloping ground the surface of the ground shall be benched in the steps of trenches or broken up in such a manner that the new material shall have perfect bond with the existing surface. Where the embankment is to be placed over an existing road surface the surface shall be scarified to minimum depth of a 5 cm so as to provide ample bond between the old and new material. However when the embankment is to be placed over an old concrete pavement and lies within 1 metre of new sub grade level, the pavement shall be broken up in pieces not to exceed 0.1 m and may be left under the new embankment. If the existing road surface is of granular or bituminous type and lies within 1 mt. of the new sub grade level, the same shall be scarified to a depth of minimum 50mm.so as to provide ample bond between the old and the new material.

8-. To avoid interference with the construction of abutment, wing walls of culverts/bridge structures, the contractor shall, at point to be determined by. the Engineer-in-charge. suspend work on embankments forming approaches to such structures, until such time as the construction of the latter is sufficiently advanced to permit the completion of approaches without the risk of interference or damage to the bridge work. Unless directed otherwise, the filling ground culverts bridge and other structures up to a distance of twice the height of the embankment from the back of the embankment shall be carried out independent of the work on the main embankment. The fill material shall not be placed against any abutment or wing wall unless permission has been given by the Engineer-in-charge but in any case not until the concrete or masonry has been in position for 14 days the embankment shall be brought up simultaneously in equal layers on each side of the structure to avoid displacement and unequal pressure. The sequence of work in this regard shall be got approved from the Engineer-in-charge. Where the provision of any filter medium is specified behind the abutment, the same shall be laid in layers with the laying of fill material. The material used for the filter shall conform to the requirements for filler medium and will be paid extra in the relevant item.

9. The embankment shall be finished in conformity with the alignment, levels cross sections and dimension shown on the plans or as directed by Engineer-in-charge. Where the alignment of the road is in a curve, the top of the embankment shall be formed with the super elevation and the increased width shown on the drawings or as the Engineer-in-charge may direct. Finishing operations shall include the work of shaping and dressing the shoulders road bed and the side slopes to conform the cross section.

10. The earthwork measurements shall be paid on cross sectional measurements and computing the volumes of earth work in cubic metres by average area method. The contractor shall sign day to day leveling work and also original cross sections longitudinal section etc, in token of his acceptance. The working sections both longitudinal and cross of the ground shall be taken by the Engineer-in-charge before the actual work has started. The contractor or his authorised representative shall attend day to day leveling work and sign with date the field book daily, in token of his acceptance. If there is any disagreement the contractor shall inform of it in writing to the officer concerned with specific reference to the sections. Before starting further work. Once the work is started, no cognizance of any complaint will be taken. Merely not signing of level book shall not be deemed as disagreement. The Executive Engineer shall also verify leveling work to the extent of 5% before commencement of earth work and on finalisation. The contractor shall maintain the embankment by filling in ruts rain cuts depression due to shrinkage etc. to proper formation and grade till this item is finally measured and accepted by the Department. The measurements shall be taken on compacted earth work. Deduction of 15% for shrinkage shall be made from gross measured quantity if measured before first monsoon and 10% if measured after one or more monsoon have been passed over the earth embankment. However the contractor shall have to bear loss of deformations etc. if any due to all settlements as well as other type of deformations etc. if any, that might have taken place at the time of taking final measurement of the item.

11. If usable approved material is available within the land width of road, the same shall be permitted for use in the road embankment subject to the following conditions :-

- (i) The borrow pits will be so excavated as to from a road side longitudinal gutter to drain the-water, interrupted by such gutter,
- (ii) The width of the drain shall be restricted to 1.5mts, only. The depth will be restricted to such grade so as to drain the water efficiently. All balance quantity of earth shall be brought from distant borrow areas only,
- (iii) If there is top layer of black cotton or other objectionable soils, the same shall be removed and disposed off elsewhere and usable material found at the lower level will only be used in the earthen embankment, if the contractor choose to utilize this material,
- (iv) The drain should be aligned along the boundary of the land width of the road. Not pit, other than this drain, shall be dug within 5 meters of the toe to the final section of the road embankment,
- (v) No borrow pits shall be allowed in the length in which earth obtained for cutting from cutting is specified to be used in embankment.

12. The rate of earthwork includes, clearing jungles, dogbelling, fixing profiles, erecting necessary pillars for stones for bench marks for leveling purpose, excavating earth from borrow areas, breaking clods, conveying and spreading earth in layers with all lead and lift, finishing the entire embankment and incidentals necessary to complete the work to the specifications. The cutting stuff of cutting in ordinary soil, soft murrum, soft rock, hard murrum and hard rock shall be utilised in embankment construction under this item within the lead specified in the particular item. No payment shall be made under this item for the cutting stuff used in embankment but labour for cutting will be paid as per specifications in the particular item, and only balance quantity of earthwork brought from borrow areas will be paid in this item.

**ITEM 1-D Earthwork for embankment including breaking clods, dressing with all lead and lift (including watering and consolidation) (b) From borrowpits within \_\_\_\_\_ kms. lead.**

1. The land width on which the earth work is to be done shall be cleared of all trees having a girth of 30 cm and less, loose, stones, vegetation, bushes, stumps and all other objectionable materials. All the materials cleared will be the property of Government. Useful material shall be arranged in convenient stacks along the road boundary or as directed at places within 50 metres lead, and handed over to the department in convenient section. Unsuitable material shall be burnt or otherwise disposed off by the contractor at his own cost without causing any nuisance, inconvenience or damage to the works property or people in the neighborhood. In all cases, the materials shall be disposed off in a neat manner.

2. After clearing the site, the alignment of the road shall be properly set out true to line, curves, slopes grades and sections as shown on the plan or directed by the Engineer-in-charge. The contractor shall provide all labours and materials such as lime, strings, pegs, nails, bamboos, stone, mortar, concrete etc. required for setting out, establishing. Bench Marks and giving profiles. The contractor shall be responsible for maintaining the B.Ms, profiles alignments and other marks as long as they are required for the work in the opinion of the Engineer-in-charge. If the contractor defaults in this respect they may be restored by the department at the cost of the contractor.



3. When an existing embankment is to be widened, continuous. Horizontal benches, each at least 0.3 metre wide shall be cut into the existing slope for ensuring adequate bond with the fresh embankment materials to be added. The material obtained from the cutting of benches can be utilised in the widening of the embankment. Where the width of the widened portions is insufficient to permit the use of usual rollers, compaction shall be carried out with the help of tandem/sheeps foot rollers, hand rollers, mechanical tampers or other approved plant. The dumping of material from trucks for widening operations shall be avoided except in difficult circumstances when the extra width is too narrow to permit the movement of any other type of hauling equipment.

4. The soil to be used for embankment shall be free from trees, stumps, roots, rubbish or any other objectionable materials. Only material considered suitable by the Engineer-in-charge shall be used for the construction and that considered unsuitable other disposed off as directed by him. The selection of the materials to be used in the construction of embankment shall be made after soil surveys and investigations are carried out by the Department. The embankment shall consist of earth available from road-side borrow pits on either side with lead and all lifts, and within land-width in the manner specified in para 12 below./The road, if any, required for the purpose of haulage of earth by men, animals or vehicles will be constructed (if not existing) and maintained by the contractor at his own cost, the material satisfying the density requirements given in the table below shall be employed for embankment construction.

<b>Type of Work</b>	<b>Laboratory Dry Density when tested as per IS : 2720 (Pt. VII)</b>
- Embankment up to 3 metre height	Not less than 1.44 gm/cc
- Embankment exceeding 3 metre height or embankment of any height subject to long period of inundation.	Not less than 1.52 gm/cc
- Top 0.5 metre of embankment below the subgrade level and shoulder [Where earth shoulder are specified]	Not less than 1.65 gm/cc

Field density shall be percentage of laboratory density as recommended by Gujarat Engineering Research Institute

5. Department will extend all necessary co-operation in helping contractor to get borrow area from nearby Government or Panchayat land, if available. However, department is not responsible if no such area is made available to the contractor and in that case, contractor will have to make his own arrangement to get borrow area for borrowing earth of the approved quantity even by making temporary arrangement with the private land owners.

6. The embankment shall be constructed in uniform layers not exceeding 250mm in loose thickness. The soil shall be spread uniformly over the entire width of the embankment, unless otherwise directed by the Engineer-in-charge. The consolidation including watering and rolling of earthwork shall be carried out by the Department. The operation of laying the successive layer of earth shall have to be suitably synchronized with the consolidation work. If the soil as delivered to the road bed is too wet, it shall be dried by exposure to the sun till the moisture content is acceptable for compaction. All clods of hard lumps of earth shall be broken to have maximum size of 15cm when being placed in the embankment and a maximum of size 5 cm when being placed in the top 45 cm of the embankment. The work of next layer shall be allowed only after the first layer below it has been thoroughly compacted to the density specified.

7. Where an embankment is to be placed on sloping ground, the surface of the ground shall be benched in the steps of trenches or broken up in such a manner that the new material shall have perfect bond with the existing surface. Where the embankment is to be placed over an existing road surface, the surface shall be scarified to minimum depth of a 5 cm so as to provide ample bond between the old and new material. However when the embankment is to be placed over an old concrete pavement and lies within 1 metre of new subgrade level the pavement shall be broken up in pieces not to exceed 0.1 m and may be left under the new embankment. If the existing road surface is of granular or bituminous type and lies within 1 m of the new subgrade level, the same shall be scarified to a depth of minimum 50 mm. so as to provide ample bond between the old and the new material.

8. To avoid interference with the construction of abutment, wing walls or return walls of culverts/bridge structures, the contractor shall, at point to be determined by the Engineer-in-charge, suspend work on embankments forming approaches to such structures, until such time as the construction of the latter is sufficiently advanced to permit the completion of approaches without the risk of interference or damage to the bridge work. Unless directed otherwise, the filling ground culverts, bridges and other structures up to a distance of twice the height of the embankment from the back of the embankment shall be carried out independent of the

work on the main embankment. The fill material shall not be placed against any abutment or wing wall unless permission has been given by the Engineer-in-charge but in any case not until the concrete or masonry has been in position for 14 days, the embankment shall be brought up simultaneously in equal layers on each side of the structure to avoid displacement and unequal pressure. The sequence of work in this regard shall be got approved from the Engineer-in-charge. Where the provision of any filter medium is specified behind the abutment, the same shall be laid in layers simultaneously with the laying of fill material. The material used for the filter shall conform to the requirements for filler medium and will be paid extra in the relevant item. Where it may be impracticable to use power rollers or other heavy equipment, the compaction shall be carried out by mechanical tampers or other methods approved by the Engineer-in-charge. Care shall be taken to see that the compaction plant does not hit or come too close to any structural member so as to cause any damage to them

9. The embankment shall be finished in conformity with the alignment, levels, cross sections and dimension shown on the plans or as directed by Engineer-in-charge. Where the alignment of the road is in a curve, the top of the embankment shall be formed with the super elevation and the increased width shown on the drawings or as the Engineer-in-charge may direct. Finishing operations shall include the work of shaping and dressing the shoulders, road bed and the side slopes to conform the cross section.

10. The consolidation of earth work including rolling and watering at O.M.C as per laboratory requirements shall be carried out by the department. The field and laboratory investigations and testing of sample shall be carried out by the Department. However, the contractor shall give full co-operation and shall be the charges for labours and collection of samples for testing at authorised Government laboratory. The work of laying of earthwork in layers shall be synchronized with the field and laboratory testing. When density measurements reveal any soft area as in the embankment the Engineer-in-charge shall direct that these areas shall be compacted further. If in spite of that, specified compaction is not achieved the materials in the soft areas shall be removed as directed and replaced by the approved materials.

11. The earthwork measurements shall be paid on cross sectional measurements and computing the volumes of earth work in cubic metres by average area method. The contractor shall sign day to day leveling work and also original cross section, longitudinal section etc. in token of his acceptance. The working sections both longitudinal and cross of the ground shall be taken by the Engineer-in-charge before the actual work is started. The contractor or his authorised representative shall attend day to day leveling work and sign with date the field book daily, in token of his acceptance. If there is any disagreement the contractor shall inform of it in writing to the officer concerned with specific reference to the sectioned before starting further work. Once the work is started, no cognizance of any complaint will be taken. Merely not signing of level book shall not be deemed as disagreement. The Executive Engineer shall also verify leveling work to the extent of 5% before commencement of earth work and on finalisation. The contractor shall maintain the embankment by tilling in ruts, rain cuts, depression due to shrinkage etc. to proper formation and grade till this item is finally measured and accepted by the Department. The measurements shall be taken on compacted earth work. No deduction for shrinkage shall be made from gross measured quantity of compacted earth work. However the contractor shall have to bear loss of quantity due to all settlements as well as other types of deformations etc. if any, that might have taken place at the time of taking the final measurements of this item.

12. If usable approved materials is available within the land width of road, the same shall be permitted for use in the road embankment subject to the following conditions :-

- (i) The borrow pits will be so excavated as to form a road side longitudinal gutter to drain the water. interrupted by such gutter,
- (ii) The width of the drain shall be restricted to 1.5 mts, only. The depth will be restricted to such grade so as to drain the water efficiently. All balance quantity of earth shall be brought from distant borrow areas only.
- (iii) If there is top layer of black cotton or other objectionable soils, the same be removed and disposed off elsewhere and usable material found at the lower level will only be used in the earthen embankment, if the contractor chooses to utilize this material.
- (iv) The drain should be aligned along the boundary of the land width of the road. No pit, other than this drain, shall be dug within 5 metres of the toe to the final section of the road embankment,
- (v) No borrow pits shall be allowed in the length in which earth obtained from cutting is specified to be used in embankments.

13. The rate of earthwork includes clearing jungles, dogbelling, fixing profiles, erecting necessary pillars for stones for bench marks for leveling purpose, excavating earth from borrow areas, breaking clods, conveying and spreading earth in layers with all lead and Lift, finishing the entire embankment and incidentals necessary to complete the work to the specifications. The cutting stuff of cutting in ordinary soil, soft murrum, soft rock, hard murrum and hard rock shall be utilised in embankment construction under this item within the lead specified in that particular item. No payment shall be made under this item for the cutting stuff used in the embankment but labour

for cutting will be paid as per specifications in that particular item, and only balance quantity of earthwork brought from borrow areas will be paid in this item.

**ITEM 1 (E) Rolling and Watering of earth work in layer with power roller including filling in depression which occurs during the process.**

1 . For spreading materials in layers and bringing the appropriate moisture content, the embankment materials shall be spread uniformly over the entire width of the embankment in layers not exceeding 250mm in loose thickness. Successive layers of embankment shall not be placed until the layer under construction has been thoroughly compacted to the requirements set down hereunder :-

Mositure content of the materials shall be checked at the source of supply and if found less than that specified for compaction, the same, shall be made good either at the source or after spreading the soil in loose thickness for compaction. In the latter case, water shall be sprinkled directly from a hoseline or from a truck mounted water tank, and flooding shall not be permitted under any circumstances.

If the materials delivered to the road bed is too wet it shall be dried, by evaporation and exposure to the sun. till the moisture content is brought doen to acceptable standard for compaction Should circumstances arise. where owing to wet weather, the moisture content cannot be reduced to the required level by the above procedure, work of compaction shall be suspended.

Mositure content of each layer of soil shall be checked in accordance with 1ST 2720 (Part-II) and unless otherwise mentioned shall be so adjusted, making due allowance for evaporation losses, that at the time of the compaction it is in the range of 1 percent to 2 percent below the optimum moisture content determined in accordance with ISI (Part-VII). Highly expansive clays shall however be compacted at 2 to 4 percent above the optimum moisture content

After adding the required amount of water, the soil shall be processed by means of harrows, rotary mixers or as otherwise approved until the layer is uniformly wet.

Clods or hard lumps of earth shall be broken to have maximum size of 150mm when being placed in the lower layers of the embankment and a maximum size of 60mm when being placed in the top 0.5 meter portion of the embankment below the subgrade.

Hauling equipment shall be dispered uniformly over entire surface of the previously constructed layer to minimise cutting of uneven compaction

Where the embankment is to be constructed on low area ground that will not support the weight of trucks of other hauling equipment, the lower part of the fill should be constructed by dumping successive loads in a uniformly distributed layers of a thickness not greater than that necessary to support the hauling equipment while placing subsequent layers.

**2. COMPACTION** : Only compacting equipment approved by the Engineer-in-charge shall be employed to compact the materials The contractor shall demonstrate the efficiency of the plants he intents to use tor carrying out compaction trials.

Each layer of the materials shall be thoroughly compacted to the densities specified in Table 1.2 Table 1.2 Compaction requirements for embankment.

<b>Sr. No.</b>	<b>Type of Work/materials</b>	<b>Field dry density as per centage of maximum laboratory dry density as per IS:2720 (Part-VII)</b>
1 .	Top 0.5 meter portion of embankment below subgrade level and shoulders.	Not less than 100.
2.	Other portion of embankment.	Not less than 95
3.	Highly expensive class	85 to 90

Subsequent layers shall be placed only after finished layer has been tested according to M.O.S.T. specification clause 902 and accepted by the Engineer-in-charge.

When density measurements reveal any soft areas in the embankment further compaction shall be carried out as directed by the Engineer-in-charge. If insite of that the specifcated compaction is not achieved, the materials in the soft areas shall be removed and replaced by approved materials and compacted to the density requirement. to the satisfaction of the Engineer-in-charge.

3. Measurements for Payment : Consolidation of earth embankment construction shall be measured by taking cross section at intervals in the origninal position before the work starts and after its completion and computing of the volume of earthwork in cubic meters by the method of average and areas. The measurement of fill material from borrow are a shall be the difference between the net quantities of suitable materials brought from roadway and drainage excavation. For this purpose it shall be assumed that one cubic meter of suitable materials brought to site

from roadway and drainage excavation froms one cubic meter of compacted fill and all bulking or shrinkage shall be ignored

Stripping including storing and reapplication of top soil shall be measured as volume in cubic meter.

4. The contract unit rate includes cost of mechanical roller required for consolidation including ail labour, equipments fuel, hire charges, tolls, and incidentals necessary.

**ITEM-2 Earth Work In cutting In all sorts of Soil and Soft Murrum including conveying and putting the stuff spoil bank maintaining minimum distance of five meter between top edge of cutting and top of bank, (a) within 200 metres from the ends of the cutting with alt required Lead and Lift.**

1. The land width required for the roadway, gutter side slopes and catch water gutters shall be cleared of all trees having a girth of 30 cms and less, loose, stones, vegetation, bushes, stumps and all other objectionable materials. The roots of trees and stumps shall be removed to a depth of 30 cms below the grade formation and slopes and excavation filled up with excavated materials and compacted. All the materials cleared will be the property of Government. Useful materials shall be arranged in convenient stacks along the road boundary or as directed at places within 50 mts. lead, and handed over to the department in convenient sections. Unsuitable material shall be burnt or otherwise disposed off by the contractor at his own cost without causing any nuisance, inconvenience or damage to the work, property or people in the neighborhood. If the materials are to be disposed off outside the road land, necessary permission from the private land owners shall be taken by the contractor and royalty etc. If any paid by him without claiming compensations In all cases, the materials shall be disposed off in a neat manner.

2. After clearing the site, the alignment of the road shall be properly set out true to lines, curves slopes, grades and sections as shown on the plans or directed by the Engineer-in-charge. The contractor shall provide all labour and materials such as lime, strings, pegs, nails, bamboos, stones mortar, concrete etc required for setting out alignment establishing bench marks and giving profiles. The contractor shall be responsible for maintaining the B. Ms. profiles alignments and other stakes and marks as long as they are required for the work in the opinion of the Engineer. If the contractor defaults in this respect even after the direction by the Engineer within the specified time. they may be restored by the Engineer at the levels etc. If there is any disagreement the contractor shall inform of it in writing to the officer concerned with the specific reference to the sections before starting further work. Once the work has started, no cognizance of any complaint shall be taken. Merely not signing of the book shall not be deemed as disagreement.

3. Profiles of the section including the road side gutters to be excavated shall be laid at suitable intervals of 10m to 50 m. or other intervals as directed by Engineer to conform t8 the curved or straight alignment, sections, grades and side slopes. The line out shall be clearly marked and profiles of embankments where excavated materials are to be used shall be set up with the toe line marked on each side. The road way section shall first be excavated with vertical side for each lift and the sides slopes for that lift shall be excavated in steps. These steps shall be smoothed to the required slope when the excavation reaches the road formation. The contractor shall on no account excavate beyond the slopes or below the specified grade unless so directed by the Engineer in writing. If excavation is done below the specified level or outside the section, it shall not be paid for and the contractor shall be required to fill up at his own cost such extra excavation in the road portion, with approved materials of the embankment grade in layers, watered and fully compacted to attain maximum density laid down for the embankment

in its relevant item. The Engineer may require measurement ridges and dead man to be left at specified intervals or places and kept intact till ordered to be removed for the purpose of check measurements. The excavation shall be finished neatly, smoothly, and evenly to the correct lines, curves, grades, if loose shall be scarified, watered and compacted to the same density as the embankment. The section, side slopes and catch water gutter shall be maintained by the contractor at his own cost in such a way that the formation and gutters will be drained by providing for necessary diversions etc, and not damaged due to obstruction of any drainage. Necessary passages shall be provided for leading away seepage, springs, surface flow or rainwater safely without damaging the work If any damage occurs due to default of the contractor in this respect, he shall make good the damage at his own cost. If it is necessary in the execution of the work to interrupt existing surface drainage, irrigation channels, sewers or under drainage, temporary arrangements shall be provided till such time as is necessary. The contractor at his own cost shall make the existing works or work in hand caused as a result of his operations or negligence shall be made good by the contractor at his own cost. Road side gutters shall be excavated to the specified sections and shall be measured along with the main cutting in cubic meters

4. If slides occur in the cutting they shall be removed as ordered by the Engineer. If finished slopes slide into the roadways before the final acceptance of the work, such slides shall be removed by the contractor and shall be paid for at the contract rate for the class of excavation involved provided the slides are not due to any negligence of the contractor. The classification of the material in slides shall conform to its conditions at the time of removal



and payment made accordingly regardless of its prior condition. Care shall be taken to see that excavation is arranged in a safe way so that there will be no risk to the workmen by slides, falling materials, boulders and collapsing sides etc.

5. If there is traffic nearby or if there are towns and villages in the neighborhood, barricades and or traffic signals shall be provided day and night for the duration of the work in such a way as to prevent accidents. Warning signals shall be displayed at 7mt from the danger point on both sides giving sufficient warning. If necessary, signalers shall be stationed at each end to regulate traffic where it is heavy. Measures shall be taken to see that the excavation does not affect or damage adjoining structures or property. If there is damage to property, injury to workers, the members of the public, animals etc.. due to the negligence of the contractor, he will be responsible and liable to all the consequences including compensation.

6. All the excavated materials shall be property of Government. When the useful excavated material is to be used in embankment within a lead of 200 metre and all lift, it shall be directly deposited at the required location in specified layers. No handing or conveyance charges shall be paid if the material is temporarily deposited elsewhere and subsequently conveyed to site of deposition. The sequence of operations at convenient places, without interfering with the drainage in any way. If no Government land is available but the excavated useful stuff is to be stacked temporarily before use under the same agreement, the contractor shall make his own arrangements for the stacking of this material not required for use on embankment or unsuitable materials may be used on his own to uniformly widen embankment to flatten slopes and to fill low places in the road land, if so permitted by the Engineer. Material not required for any use whatsoever may be disposed off by the contractor at his own cost in a manner approved by the Engineer. The excavated material shall not be deposited within 3 m from the top edge of slope or toe of the bank. The lead shall be measured from the junction point of cutting and embankment up to 200 mt. on either side.

7. If the contractor does not wish to utilise the quantity of cutting within the specified lead for any reason, then he may do the embankment work with the earth from other sources (except borrow pits in the length of the road where cutting stuff is to be utilised) but in that case the full or part quantity of acceptable quality stuff for which payment is made or to be made will be deducted from the net quantity of the earth work in the embankment arrived at within the chainage measured as above.

8. The Contract rate shall be a unit of one cubic metre for the start mentioned in the wording of the item of excavation acceptably completed, limited to the dimensions shown on the plans or as directed by the Engineer. Excavation shall be measured in its original positions by taking cross sections before the work starts and after it is entirely completed. The quality shall be worked by the average end area method. When the classification of the strata changes, the contractor shall bring this to notice of the Engineer, who will then verify and if necessary take levels for the changed strata for purpose of measurement.

(b) In Spoil Bank :Specification shall be as per Item 2(a) except that the excavated stuff shall be deposited in spoil Bank instead of using same in road embankment.

**ITEM 3 Supplying and Stacking murrum binding materials including materials on road side including filling boxes with all lead & lift etc. complete.**

1. Material for the purpose shall be of approved quality Any material which is found inferior shall be rejected and the contractor shall remove such rejected material from the site at his own cost The material shall be collected from quarries approved by the Executive Engineer The material shall be granular and gritty\*

2. The material shall be got approved by the Executive Engineer prior to collection on site It shall be free from all rubbish, dust and any organic materials as well as clods of black cotton soils Materials shall not be allowed to be collected from within the road boundary. Material to be used as crust and for side shoulders shall be as per C.B.R. report and that to be use bindaga in W.B.M. road construction shall have P.I. value of less than 6 as determined in accordance with IS 2720 (Part-V). The material to be used should be got tested prior to its use in road construction. Testing charges shall be borne by the contractor.

3. River or nala or sea sand required for the work shall be clear, sound, properly, graded, free from organic materials silt clay etc. and shall be got approved by the Engineer-in-charge. The sand shall be obtained and brought from the source approved by the Engineer-in-charge. The sand shall be well graded.

The payment shall be made on Cubic Metre basis

4. Stacking shall be done by filling in the standard steel boxes of 2 m x 1.5 m x 0.5 m size which shall be supplied by the Department if available on rent. Otherwise contractor shall make his own arrangement No deduction for voids shall be made from the grade measurements. Where any doubt exists as to whether the quantity of slacks of murrum in an hectometre is not confirming with the cubic content of the standard pharas (2 x 1.5 x 0.5 M) the same shall be got corrected by the contractor if so ordered by the Engineer-in-charge for which no extra payment shall be claimed by the contractor. If the quantity of murrum in any stack in a particular hectometre is found to be less than the standard measurements viz.. 1.5 cmt the entire collection in the

BHAVNAGAR MUNICIPAL CORPORATION - BHAVNAGAR

hectometre shall be paid on the basis of the quantity so found. Regular stacks shall be done by the Contractor on a fairly level ground. Stacking of the murrum shall be done in a manner as directed by the Engineer-in-charge. 5. For road work completed stacking of murrum as per requirement shall be earned out in 2 K.M. length before spreading. The collection shall always, be commenced at one end of the K.M. and be carried continuously toward the other end unless the Engineer-in-charge shall direct otherwise.

6. The payment shall be made on cubic metre basis without deduction for voids. The contractor shall maintain all stacks in regular and proper size till the whole materials are collected, measured and finally accepted by the Department. The spreading of materials shall not be allowed till the materials are fully stacked and completed kilometer wise,

7. The rate includes cost of collection, conveyance to the site with all lead and lift and filling the boxes including all labour, tools, equipment and other incidental expenses.

8. The rate quoted are inclusive of all shall such tools, duties, fees, royalties, taxes etc.

**Item-3(A) Supplying and Stacking hard murrum / sand/yellow earth/ binding materials on road site including filling boxes with all leads and lifts etc. complete on site of work as per specification.**

1. The materials for the purpose shall be of approved quality. Any materials which is found inferior shall be rejected and the contractor shall remove such rejected materials from the site at his own cost. The material shall be approved by the Executive Engineer or his authorised agent Para 3 to 8 of Item No. 3 shall apply. The sand used as crust shall be as per C.B.R. Report

9. The measurements shall be taken on cubic metre basis.

**ITEM NO 4 : Supplying standard size stone aggregate.**

**ITEM NO.4(A) Supplying and stacking of hand broken stone coarse aggregates shippings etc of hard stone of size 25mm.to 90 mm size nominal size free of disintegrated pieces, deleterious and organic matter including Filling boxes with all lead and lift etc complete for W.B.M. road.**

1. The stone metal shall be obtained from quarries approved by the Executive Engineer prior to collections. The metal shall be of approved quality with all leads and lift. The metal shall be obtained from hard tough, sound durable .stone of close texture as is locally available and reasonably free from decay and weathering. Pieces of the stone shall be angular and roughly cubical in shape and round .elongated or flaky materials shall be allowed. The size of metal shall be 25 mm to 90 mm and shall be hand broken. All unsound weathered or disintegrated stone obtained form the upper surface layer of the quarry or other layers of boulders shall be rejected.

2. The samples of metal collected from approved quarries shall be got tested at Government recognized laboratory as may be directed to the contractor at his own cost. The test results shall conform to the standard requirements laid down for metal to be used for W.B.M. work.

3. The physical requirement for standard size metal shall conform to the test results indicated in the Table below :-

Type of Const,	Test	Test Method	Requirement
Base	(a) Los Angeles Abrasion Value	IS 2386 Part IV	50% (Maximum)
	(b) Aggregate Impact value Flakiness Index	IS 2386 Part- IV IS 5640 IS 2386 Part - 1	or 40% (Maximum) 15% (Maximum)

Frequency of test shall be as per Ministry of Surface Transport Specifications. The

4. grading requirements of the metal to be used for W.B.M. shall be as under ;

Sr. NO	Size Range	Sieve designation	Percentage by weight Passing through the sieve
1.	25 mm to 90 mm	100 mm	100
		90 mm	90-100
		50 mm	40-60
		25 mm	0-10
		20 mm	0-5

The size of metal for W.B.M shall be 25 mm to 90 mm. wherein tolerance limit for oversize shall be up to 10% and that for lower size should be up to 10%.

5. Wherever any doubt exists as to whether the above requirements are satisfied, in whole or any part of the collection, metal shall be got screened by the contractor at his own cost, if so ordered by Engineer-in-charge.

6. Stacking shall be done by filling in the standard steel boxes of 2 m x 1.5 m x 0.5 m size which shall be supplied by the Department if available on rent. Otherwise contractor shall make his own arrangements. No deduction for voids shall be made from the gross measurements. Where any doubt exists as to whether the quantity of stacks of metal in any hectometre is not confirming with the cubical content of the standard pharas ( 2 m x 1.5 m x 0.5 m) shall be got corrected by the contractor if so ordered by the Engineer-in-charge for which no extra payment shall be claimed by the contractor. If the quantity of metal in any stack in a particular Hectometre shall be paid on the basis of the quantity so found. Regular stacks shall be done by the contractor on a fairly level ground. Stacking of the metal shall be done in a manner as directed by the Engineer-in-charge. Collection of metal shall be completed in two hectometre wise as per the final requirement and measurement shall be recorded two hectometre-wise. Until the quantity of metal as per the final requirement is not collected in any two consecutive HM. and std. boxes are not filled in completely in two hectometres, measurements shall not be recorded and payments shall not be done.

7. For road work complete staking of metal as per requirement shall be carried out in 2 Km. length before spreading. The metal stacks shall be measured and recorded and got cross checked by other Deputy Executive Engineer as per rules before spreading. The collection shall always, commence at one end of the Km. and be carried continuously towards the other end unless the Engineer-in-charge shall direct otherwise.

8. The payment shall be on cubic metre basis without deduction for voids. The contractor shall maintain all stacks in regular and proper size till the whole materials shall not measure and finally accepted by the Department.

The spreading of materials shall not be allowed till the materials are fully stacked and completed kilometre wise.

9. The rate includes cost of collection, conveyance to the site with all lead and lift and filling the boxes including all labour, tools, equipment and other incidental expenses. The rates quoted are inclusive of all such tools, duties, fees, royalties, taxes, etc.

**ITEM 4 (B) Supplying & stacking of hand broken crushed stone aggregate Chippings etc of hard stone of**

**40mm to 63mm size nominal size free of disintegrated pieces, deleterious and organic matter including filling boxes with all lead and lift etc. complete for road work.**

Para to 1 to 9 of item of hand broken metal size 25 mm to 90 mm size will apply except the size of metal mentioned in para 1 and the table of grading requirements. These will be as under

(i) Para 1 to size will be 40 mm. to 63 mm. instead of 25 mm. to 90 mm. in para 1.

**(4)** The grading requirements of the metal to be used for W.B.M shall be as under:-

Sr. No.	Size range	Sieve Designation	Percentage by weight Passing through the sieve
1	2	3	4
1.	40 mm to 63 mm	75 mm	100-100
		63 mm	90-100
		50 mm	60-80
		40 mm	0-15
		25 mm	0-5

The size of metal for W.B.M shall be 40 mm. to 63 mm. wherein tolerance limit for oversize shall be 10 percent and that for lower size should be upto 15 percent and below 25 mm it shall be upto 5 percent. 10. Standard for acceptance at reduced rates and rejection shall be as under :-

- (a) Retained on 63 mm. square mesh sieve : Not more than 30%
- (b) Retained on 75 mm. square mesh sieve : Nothing will be retained & 100% metal shall be pass through the sieve. For the over size metal, payment at reduced Rate should be made as under;
  - (A) 90% of accepted tender rates for the metal retained between 10% and 20% square mesh sieve of 63 mm. gauge.
  - (B) 75% of accepted tender rates for the metal retained more than 20% and upto 30% on square mesh sieve of 63 gauge.

If more than 30% of metal is retained on specified sieve, (i.e. 63 mm. square sieve) the stack shall be

rejected. Also if any stone aggregate retained on 75 mm. sieve the stack shall be rejected.

The quality for which reduced rate will be applicable is the quantity retained on the above mentioned square mesh sieve and not the whole quantity.

For example in a stack of 1.5 cum. metal if 18% is retained on square mesh sieve of the prescribed size (i.e. 63 mm) the reduced rate of 90% will be applicable to 0,27 cu.m. only and the balance quantity size shall be paid for the accepted rates for standard size metal.

Before any secured advance for metal is paid to the contractor, the metal shall have to be tested for its quality in the laboratory. Contractors' request for such secured advance will be considered only after test results of metals are received and results are satisfactory.

[As per Government circular No. SSR 1070-1B-191-22-S of 5-3-92]

**ITEM 4 (C) Supplying and Stacking of machine Crushed Stone aggregate Chipping etc of hard Stone of 20 to 50 mm nominal size free of disintegrated pieces, deleterious and organic matter (for bitumen surface dressing etc.) as per I.R.C. Code including filling the boxes with all toad and lift etc. complete.**

1. The field of M.C. metal shall be of approved quarry as shown on the quarry chart as well as approved by the Executive Engineer prior to collection.
2. The M.C. metal shall be hard, tough, sound, durable, black trap field metal of close texture, free from decay and weathering. Each piece of the stone shall be angular and roughly cubical in shape and round elongated or flaky material shall be rejected. No round or oblong pebbles or angular chips larger or smaller than specified size shall be allowed.
3. All unsound, weathered or disintegrated stone obtained from the upper surface layer of the quarry or other layer of boulders shall be rejected. The physical requirement for standard size metal shall conform to the test results indicated in para 3 of item 4.
4. The M.C. metal shall be a\$ nearly uniform in size as possible and shall conform to following minimum requirements of passing through the rings:

<b>Sieve Size.</b>	<b>Percentage Passing through</b>
63mm	100
50mm	95-100
40mm	35-70
20mm	0-10

5. Wherever and doubt exists as to whether the above requirement are satisfied in whole or part, the collection of M.C. metal shall be got screened by the contractor if so ordered by the Executive Engineer and for which no extra payments shall be claimed by the contractor.
- 6: Any collection which does not fully satisfy the above requirements is'liable to be rejected altogether.
7. Stacking shall be done by filling in the standard steel pharas of 2.00 x-1.50 x 0.50 metre and no deduction of voids shall be made from the gross measurements.-
8. Regular stacks shall be done by the contractors on a fairly level ground. All the stacks shall be marked by white wash immediate on being measured and recorded by the Engineer-in-charge.
9. The rate includes blasting the rock, it any, breaking the metal, stacking, measuring in pharas etc. complete.

**ITEM - 4 (d) Supplying & stacking machine crushed stone aggregate chipping etc. of hard stone of 25 mm to 40 mm nominal size free of disintegrated pieces, deleterious and organic matter including filling the boxes with all lead and lift etc. complete on site of the work for bituminous surface dressing etc. as per I.R.C. Code.**

as per item No. 4 (c) except that gradation of Aggregate shall be a\$ under.

<b>Sieve Size</b>	<b>% by weight passing through</b>
50mm	95-100
40mm	65-90
20mm	0-10
10mm	0-5



**ITEM-4(e) Supplying and stacking of quarry spauls materials at site including filling boxes with all lead and lift.**

1. The quarry spauls shall be approved quarry as approved by the Ex. Engineer prior to collection. Filling of boxes, shall not be allowed till the metal is broken to the specified site.
2. The quarry spaul shall be as uniform in size as possible. The quarry spaul shall be hard, tough, solid, durable of black trap quarry of close texture, free from decay and weathering. The stone shall be angular and roughly cubical in shape and round elongated or flaky materials shall be rejected. No sound or long rubble or angular chips smaller than specified size shall be allowed.
3. All unsound, weathered or disintegrated stone obtained from the under surface layer of the quarry or other layers of boulders shall be rejected.
4. Wherever any doubt as to whether above requirement are satisfied in whole or part of the collection it shall be got screened by the Contractor if so ordered by the Executive Engineer, and for which no extra payment shall be claimed by the contractor
5. Any collection which does not fully satisfy the above requirements is liable to be rejected all together.
6. Stacking shall be made by the Contractor by steel pharas of 2 M x 1.5 M x 0.5 M and no deduction of voids shall be made from the gross measurements.
7. Regular stacks shall be made by the contractor on a fairly level ground. All the stack shall be marked by white wash immediately on being measured and recorded by the Engineer-in-charge.
8. The rate includes blasting the rock, if any, breaking the quarry spauls. stacking measuring in pharas etc. complete.
9. Stacks shall as per actual requirements and any materials in excess shall have to be transported by the contractor at the places directed by the Executive Engineer at the risk and cost of the contractor.
10. While stacking materials the depositing should commence at one end of the K.M. and carried continuously towards the other end unless the Executive Engineer shall direct otherwise and as a rule measurements shall be taken after metal for half kilometer or Km. has been fully collected. Any fraction of these distance shall not be measured up.

11. The measurements shall be recorded in on Cum, basis & shall be paid accordingly,

**ITEM-4(f) Supplying and stacking rubble of hard stone on road side with all leads and lift as directed.**

1. The rubble stones shall be black in colour, shall be hard, tough, sound durable and of close texture, free from cracks and it shall be obtained from the approved quarries.
2. The rubble obtained from the top surface of the quarry is soft one and hence such soft variety shall not be accepted. All unsound weathered or disintegrated stones obtained from the upper portion of the quarry shall be rejected.
3. The quarry shall be well protected shall be dug by removing all the katcha and weathered stuff till approved quality of materials is available.
4. The length and breadth shall not exceed 1/ (f .2) times the thickness of the stones.
5. The rubble stacks shall be made on a fairly level ground and stacks shall be so made that rubble stones are stacked as close as possible so as to leave no excessive voids and no hollows are left out.
6. The tendency to prepare the stacks by keeping excessive voids or keeping hollow places shall not be tolerated.
7. The stacks shall be uniform in length and breadth and top portion shall be in level so that height at any point is uniform.
8. All the stacks shall be of standard dimensions which shall be prescribed by the Executive Engineer deduction for voids shall not be made.
9. The rubble shall be got approved by the Executive engineer, prior to collector on site or otherwise it is liable to rejection for which no claim shall be entertained.
10. The contractor shall maintain all stacks in regular and proper sizes till the whole material is collected Measured and finally accepted by the department. 15 percent spauls will be allowed for filling in interstices.
11. The rubble shall be stacked in quantities as per hectometre wise requirement as directed by the Executive Engineer or his agent.
12. Measurement shall be given only when the full quantity of a half kilometer is stacked measurements shall be recorded and paid only once in a hectometre and no piecemeal measurements shall be recorded and paid.

13. Stacks shall be made as per actual requirements and any material in excess shall have to be transported by the contractor at the places directed by the Executive Engineer at the risk and cost of the contractor.

**ITEM-4A { As approved by R & B. D Circular No. SSR / 080 / IB / 547 (28) C dl. 15.3.88}**

**1.0 Specifications for W.B.M. : (Sub base/Base Course)**

**1.0 Item :** Providing and laying water bound macadam of crushed/broken stone aggregates of .... mm compacted thickness mechanically interlocked by rolling and bonded together with screenings/approved quality of murrum or gritty material and water in accordance with the requirements of specifications, etc. complete.

**2.0 Materials :**

**2.1 Coarse aggregates: General requirements:** The coarse aggregates shall be stone metal obtained from quarries approved by the Executive Engineer prior to collection. The metals shall be of approved quality with all leads and lifts The metal shall be obtained from hard, tough, sound, durable, stone of close texture as is locally available and reasonably free from decay and weathering. Pieces of the stone shall be angular and roughly cubical in shape and round, elongated or flaky materials shall be rejected. No round or oblong pebbles or angular chips larger or smaller than specified size shall be allowed. The size of metal shall be 40 mm to 63 mm and shall be crushed/hand broken. All unsound weathered or disintegrated tone obtained from the upper surface layer of the quarry or other layers & boulders shall be rejected.

**2.1.1 Physical requirements:** The aggregates shall conform to the physical requirements as indicated in the Table No. 1 hereafter.

**Table No. 1:**

**Physical requirements of Coarse Aggregates for Water Bound**

S.N.	Type of Construction	Test	Test Method	Requirement
1.	Sub Base	(a) Los Angeles Abrasion value	IS : 2386 (Part IV)	50% (Max.)
		Or Aggregate Impact Value	IS : 2386 (Part IV) or IS : 5640**	40% (Max.)
2.	Base	(a) Los Angeles Abrasion value *	IS : 2386 (Part IV)	50% (Max )
		Or Aggregate Impact Value	IS : 2386 (Part IV) or IS : 5640**	40% (Max.)  15% (Max.)
		(b) Flakiness Index	IS : 2386 (Part 1)	

\* Aggregates may satisfy requirements of either Two tests.

\*\* Aggregates like vricks, metal kankar laterite etc. which get softened in presence of water, shall be tested for impact value under wet condition in accordance with IS : 5640

**2.1.2 Grading requirement :** The coarse aggregates shall conform to the grading requirement as indicated in Table No. 2 below :

**Table No. 2 :**

**Grading Requirements of Coarse Aggregates**

Grading No.	Size range	Sieve Designation	Percent by weight
2	63 mm to 40 mm	80	100
		63	85-100
		40	0-15

**2.2 Screenings/approved quality of murrum/grtity materials:** Screenings/murmm/gritty materials to fill voids in the coarse aggregate and to act as binding materials shall generally consist of predominantly non-plastic material such as murrum or gravel (other than rounded river borne material) provided the liquid limit and plasticity index of the material is below 20 & 6 respectively & fraction passing 75 micron sieve does not exceed 10 percent.

**2.2.1** As far as possible, screening/murrum/gritty materials shall conform to the gradings set forth in Table No. 3 below:

**Table No. 3 :  
Grading for Screenings/approved quality or murrum/gritty materials.**

Grading Classification	Size of Screenings	Sieve Designation	Percent by weight passing the Sieve
A	12-5 mm	12.5 mm	100
		10.0 mm	90-100
		4.75 mm	10-30
		1 50 micron	0-8
B	10 mm	10 mm	100
		4.75 mm	85-100
		150 mm	10-30

**3.0 Construction Operations :**

3.1 **Preparation of base :** The subgrade/sub-base/base to receive the water bound macadam course shall be prepared to the specified grade and camber and made free of dust and other extraneous material. Any ruts or soft yielding places shall be corrected in an approved manner and rolled until firm. Where water bound macadam is to be laid over an existing black topped surface.50 mm x 50 mm furrows shall be cut at an angle of 45 degrees to the road at 1 metre intervals in the latter before laying the coarse aggregate.

3.2 **Spreading course aggregate :** The coarse aggregates shall be spread uniformly upon the prepared base in such quantities that the thickness of the compacted layer is 100 mm for grading 1 and 75-100 mm for gradings 2 and 3 as specified.

The spreading shall be done from stock piles along the side of the roadway or directly from vehicles. In no case shall the aggregate be dumped in heaps directly on the surface prepared to receive the aggregate nor shall hauling over uncompacted or partially compacted base be permitted.

The surface of the aggregates spread shall be carefully checked with templates and all high or low spots remedied by removing or adding aggregate as may be required. No segregation of large or fine particles shall be allowed and the coarse aggregate as may be required. No segregation of large or fine particles shall be allowed and the coarse aggregate as spread shall be of uniform gradation with no pockets of fine material.

The coarse aggregate shall not normally be spread more than 3 days-in advance of the subsequent construction operations.

3.3 **Rolling :** Immediately following the spreading of the coarse aggregate, rolling shall be started with three wheeled power rollers of 6 to 10 tonne capacity or tandem or vibratory rollers of approved type. The weight of the roller shall depend upon the type of the aggregate and as may be indicated by the Engineer-in-charge.

Except on super elevated portions where the rolling shall proceed from inner edge to the outer rolling shall begin from the edges gradually progressing towards the centre. First the edge/edges shall be compacted with roller running forward and backward. The roller shall then move inwards parallel to the centre line of the road, in successive passes uniformly lapping preceding tracks by at least one half width.

Rolling shall continue until the aggregate are thoroughly keyed and the creeping of aggregates ahead of roller is longer visible. During rolling slight sprinkling of water may be done, if necessary. Rolling shall not be done when the sub grade is soft or yielding or when it causes a wave-like motion in the subgrade or sub-base course.

The rolled surface shall be checked transversely and longitudinally with templates and any irregularities corrected by loosening the surface, adding and removing necessary amounts of aggregates and re-rolling until the entire surface conforms to desired number and grade. In no case shall the use of screenings be permitted to make up depressions

3.4 **Application of screenings/ murrum/ gritty material :** After the coarse aggregate has been rolled to Clause 3.3 screenings/murrum/gritty material to completely fill the interstices shall be applied gradually over the surface. These shall not be damp or wet at the time of application. Dry rolling shall be done while the screenings/murrum/gritty material are being spread so that vibrations of the roller cause them to settle into the voids of the coarse aggregate. The screenings/murrum/gritty material shall not be dumped in piles but spread uniformly in successive thin layers either by the spreading motion of hand shovels or by mechanical spreaders or directly from trucks. Trucks operation for spreading the screenings/murrum/gritty material shall be driven as not to disturb the coarse aggregate.

The screenings/approved quality murrum/gritty material shall be applied at a slow and uniform rate (in three or more applications) so as to ensure filling of all voids. This shall be accompanied by dry rolling and brooming with mechanical brooms, hand-brooms or both. In no case shall the screenings; be applied so fast

and thick as to form cakes or ridges on the surface in such a manner as would prevent filling of voids or prevent the direct bearing of the roller on the coarse aggregate. These operations shall continue until no more screenings can be forced into the voids of the coarse aggregate.

The spreading, rolling and brooming of screenings/murrum/gritty material shall be carried out in only such lengths of the road which could be completed within one day's operation.

**3.5 Sprinkling and grouting :** After the screenings/murrum/gritty material have been applied. the surface shall be copiously sprinkled with water, swept and rolled Hand brooms shall be used to sweep the wet screenings/murrum/gritty material into void and to distribute them evenly. The sprinkling, sweeping and rolling operations shall be continued with additional screenings applied as necessary until the coarse aggregate has been thoroughly well-bonded and firmly set in full depth and a grout has been formed of screenings/murrum/gritty material Care shall be taken to see that the base or sub grade does not get damaged due to the addition of excessive quantities of water during construction.

**3.6 Setting and drying:** After the final compaction of water bound macadam course, the road shall be allowed to dry overnight Next morning hungry spots shall be filled with screenings/murrum/gritty material as directed, slightly sprinkled with water if necessary and rolled. No traffic shall be allowed on the road until the macadam has set. The Engineer-in-charge shall have the discretion to stop having traffic from using the completed water bound macadam course if in his opinion it would cause excessive from to the surface.

**4.0 Surface Finish :**

The surface finish of construction shall conform to the following requirements :

**4.1 General :** All works performed shall conform to the lines, grades, cross sections and dimensions shown on the drawings or as directed by the Engineer-in-charge subject to the permitted tolerances described hereinafter.

**4.2 Horizontal Alignments :**Horizontal alignments shall be reckoned with respect to the centre line of the carriage way as shown on the drawings The edges of the carriage way as constructed shall be correct within a tolerance of  $\pm 25$  mm therefrom. The corresponding tolerance for edges the roadway and lower layers of payments shall  $\pm 40$  mm.

**4.3 Longitudinal profile :** The levels of the subgrade and different pavement course as constructed shall not vary from those calculated with reference to the longitudinal and cross-profile of the road shown on the drawings or as directed by the Engineer-in-charge, beyond the tolerances mentioned below:

Subgrade	$\pm 25$ mm
Sub-base	$\pm 20$ mm
Base course	$\pm 15$ mm
Wearing course	$\pm 10$ mm

provided, however, that the negative tolerance for wearing coarse shall not be permitted in conjunction with the positive tolerance for base course if the thickness of the former is thereby reduced by more than 6 mm.

**4.4 Surface Regularity :** The surface regularity of completed sub-base, base course and wearing surface in the longitudinal and transverse directions shall be within the tolerance indicated in Table No.4 below:

**Table No. 4:  
Permitted tolerance of surface Regularity for payment course**

Sr.No.	Type of Construction		Longitudinal Profile	Cross Profile
	Template	Maximum Permissible undulation mm	With 3metre Straight edge Maximum number of undulations permitted in any 300 mm length exceeding mm	Maximum Permissible variation from specified Profile under camber
1	2	3	4	5

1 .	Water Bound Macadam with normal size metal (20-50 mm and 40-63 mm size)	12	30	8
-----	---	----	----	---

The longitudinal profile shall be checked with a 3 metre long straight edge at the middle of each traffic lane along a line parallel to the centre line of the road. The transverse profile shall be checked with a set of three camber at intervals of 10 metres.

**4.5 Rectification :** Where the surface irregularly of subgrade and the various pavement course fall outside the specified tolerances the shall be liable to rectify these in the manner described below and to the

satisfaction of the Engineer-in-charge

When the surface is high or low, the top 75 mm shall be scarified, reshaped with added material as necessary and recompactd as per the specification of W.B.M. The area treated at a place shall not be less than 5 metres long and 2 metres wide.

**5.0 Quality Control tests during Construction :**

**5.1 General :** The materials supplied and the works carried out by the contractor shall conform to the specification prescribed in the preceding Clauses

For ensuring the requisite quality of Construction, the materials and works shall be subjected to quality control test as describe hereinafter, by the Engineer-in-charge. The testing frequencies set forth are desirable minimum and the Engineer-in-charge shall have the full authority to carry out tests as frequently as he may deem necessary to satisfy himself that the materials and works comply with the appropriate specifications.

Test procedures for the various quality control tests are indicated in the sections of the specifications or for certain test within this section. Where no specific testing procedure is mentioned the tests shall be carried out as per the prevalent engineering practice to the directions of the Engineer-in-charge

**5.2 Test on Sub-bases & Bases :**

**5.2.1** The tests and their frequencies for W.B.M. types of Bases & sub-base shall be as given in Table No.5 below :

**Table No. 5  
Control tests & their frequency for sub-base & bases of water bound macadam**

<b>Sr. No.</b>	<b>Type of Construction</b>	<b>Test</b>	<b>Frequency</b>
1 .	Water Bound Macadam	(i) Agregate impact value (ii) Grading (iii) Flakiness index (iv) Atterberg limit	One test per 1200 cu.m. One test per 100 cu.m. One test per 200 cu.m. One test per 25 cu.m. of materials for screenings.

**5.2.2 Compaction Control:** Control shall be exercised by tacking at least one measurement of density for each 1000 square metres of compacted area, or closer as required to yield the minimum number of test results for evaluating a day's work on statistical basis. The determination of density shall be in accordance with IS 2720 (Part XX VIII). Test locations shall not be based on the results of any one test but on the mean value of a set of 5-10 density determinations. The number of tests in one set of measurements shall be 5 as long as it is felt that sufficient control over materials and the method of compaction is being exercised. If considerable variations are observed between individual density results, the minimum number of tests in one set of measurement shall be increased to 10. The acceptance of work shall be subject to the condition that the mean dry density equals or exceeds the specified density and the standard deviation for any set of results is below 0.08 gm/cc. 6.0 Arrangement of Traffic during Construction:

**6.1 General:** The contractor shall at all times carry out work on the highway in a manner creating least interference to the flow of traffic while consistent with the satisfactory execution of the same. For all work involving improvements to the existing highway the contractor shall, in accordance with the directives of the Engineer-in-charge, provided and maintain, during the execution of the work, a passage for traffic along a part of the existing way under improvement, or along a temporary diversion constructed close to the highway.

**6.2 Passage of Traffic along a part of the Existing Carriage way Improvement:** This method shall be adopted where, in the opinion of the Engineer-in-charge, the improvement works, namely widening of the existing pavement or reconstruction/repairs to cross-drainge works, could be carried out on part widths at a time and the traffic could simultaneously be passed without undue delay and difficulty on the other part. The road shoulder shall be dressed and brought in line with the pavement and maintained throughout the duration of the work to the satisfaction of the Engineer-in-charge. Where works is in progress in continuous long stretches, passing places, at least 20 metre long 6 metre wide, inclusive of the width of the existing carriage way shall be provided at half to one-kilometre intervals as directed by the Engineer-in-charge. Extra treatment to shoulders where necessary, shall be given as ordered by the Engineer-in-charge.

**6.3 Passage of traffic along a Temporary Diversion:** If in the opinion of the Engineer-in-charge it is not possible to pass the traffic on part width of the carriage way for any reason, a temporary diversion close to the highway shall be constructed as directed. It shall *be* paved with locally available materials such as hard Murrum. gravel, brick or stone metal to the specified thickness and provided with bituminous surfacing, where directed. In all case, the alignment. gradients and surface type of the diversion, including its junctions, shall be



approved by the Engineer-in-charge before the highway is detoured and closed to traffic. At cross drainage points, the contractor shall provide temporary crossings for the diversion according to the designs approved by the Engineer-in-charge.

**6.4 Traffic Safety and control:** The contractor shall take all necessary measures for the safety of traffic during construction and provide, erect and maintain such barricades, including signs, markings, flags, lights and flagmen as may be required by the Engineer-in-charge for the information and protection of traffic approaching or passing through the section of the highway under improvement. Before taking up any construction, an agreed phased programme for the diversion of traffic on the highway shall be drawn up in consultation with the Engineer-in-charge.

The barricades erected on either side of the carriage/portion of the carriage way closed to traffic, shall be of strong design to resist violation, and painted with alternate black and white stripes. Red lanterns or warning lights of similar type shall be mounted on the barricades at night and kept throughout from sunset to sunrise.

At the point where traffic is to deviate from its normal path whether on temporary diversion or part width of the carriage way the channel for traffic shall be clearly marked with the aid of pavement markings painted drums or a similar device to the directions of the Engineer-in-charge. At night the passage shall be delineated with lanterns or other suitable light source.

One way traffic operation shall be established wherever the traffic is to be passed over part of the carriage way inadequate for two-lane traffic. This shall be done with the help of flagmen kept positioned on opposite sides during all hours for regulation of traffic. The flagmen shall be equipped with red and green flags and lanterns/lights.

On both sides suitable regulatory/warning signs shall be installed for the guidance of road users, on each approach at least two signs shall be put up one close to the point where transition of carriage way begins and the other 120 metres away. The signs shall be of approved design and of refractory type if so directed.

**6.5 Maintenance of Diversion and traffic control Devices:** Signs, lights, barrier and other traffic control devices, as well as the riding surface of diversions shall be maintained, in satisfactory conditions till such time they are required as directed by the Engineer-in-charge. The temporary travel way shall be kept free of dust by frequent application of water if necessary.

**6.6 Measurements for payment traffic Arrangement:** All arrangements for traffic during construction including maintenance thereof but excluding initial dressing and/or extra treatment of the shoulders and construction of temporary diversions shall be considered as incidental to the works and Contractor responsibility.

Construction of temporary diversions, initial dressing of the shoulders and extra paving at passing places shall, however be paid for as provision sum, if written order is issued to do so by the Engineer-in-charge.

#### **7.0 Measurements for payments for W.B.M.**

**7.1** Water bound macadam shall be measured as finished work in position is cubic metres. The finished thickness of sub-base and base courses to be paid on volume basis shall be computed in the following manner:

Levels shall be taken before and after construction, at a grid of points 10 metres centre to centre longitudinally in straight reaches but 5 metres at curves. Normally, on two-lane roads the levels shall be taken at four positions transversely, at 0.75 and 2.75 metres from either edge of the carriage way and on single lane roads these shafts be taken at two positions transversely being at 1.25 metre from either edge of the carriage way.

Suitable reference for the transverse grid line should be left in the form of embedded bricks on either ends or by the oilier means so that it is possible to locate the grid points for level measurements after each successive course is laid.

For pavements courses laid only over widening portion, at least one line of levels shall be taken on each strip of widening or more depending on the width of widening as decided by the Engineer-in-charge; notwithstanding the above, if the need may arise particularly in the case of estimation of the volume of the material for levelling course. The average thickness of the pavement source in any area shall be the arithmetical mean of the difference of levels before and after construction at all the grid points falling in that area; provided that thickness of finished work shall be limited to those shown on the drawings or approved by the Engineer-in charge.

As supplement to level measurement, the Engineer-in-charge shall have the portion to cut cores/holes to check on the depth of construction.

The contractor shall sign day to day levelling work and also original cross section, longitudinal section in token of his acceptance etc. The working sections both longitudinal and cross of the sub-grade shall be taken by the Engineer-in-charge before the actual W.B.M. work is started, the contractor, or his authorised representative shall attend day to day levelling work and sign with date the field book daily in token of his

acceptance. If there is any disagreement the contractor shall inform of it in writing to the officer concerned with specific reference to the sections before starting further work. Once the work is started no cognizance of any complaint taken. Merely not signing of the level book shall not be deemed as disagreement. The Executive Engineer shall also verify leveling work to the extent of 5 percent before commencement of WBM. WBM shall be maintained by the contractor to proper formation and grade till this item is finally measured and accepted by the Department. The measurement shall be taken on compacted WBM.

Any crack formation of screenings observed in between any layer of WBM work shall be deducted from the measurements so taken and net quantity of WBM work shall be considered for payment.

## **8.0 Rate**

**8.1** The contract unit rate for water bound macadam sub-base/base course shall be payment in full for carrying out the required operations including full compensation for all components listed below :

- (j) Making arrangements for traffic to Clause-6 except for initial treatment to shoulders and construction of diversions.
- (ii) Furnishing all materials to be incorporated in the work including all royalties, fees, rents where necessary and all leads and lifts.
- (iii) All labour, tool, equipment and incidentals to complete the work to the specifications and
- (iv) Carrying out the work in part widths of roadway where directed.

### **ITEM - 5 Spreading Soft murrum/murrum/sand/yellow/earth/bindage or road crust filling the gaps in metal and leveling to camber and gradient as directed.**

Spreading of material shall be started after the full supply in a particular K.M. is collected, measured and recorded in the measurement books. Permission of the Engineer-in-charge shall be obtained before spreading. It shall be seen that the formation is dressed to the required camber and grade. If the murrum is to be spread over the metaled surface then the spreading shall be uniform and as it has to act as binding surface it shall be used for filling the interstices of metal and forming a smooth running surface as far as possible. Murrum blindage shall be specified as blindage shall be spread evenly with a twisting motion of the baskets. No more Murrum shall be used then specified as blindage. The rate is for gross measurements and no deduction of voids shall be made. I. the murrum is to be spread over earthen embankment as a sub-base or for side shoulders or as blindage it shall be spread in a manner as directed by the Engineer-in-charge and as per required width and thickness. The contractor shall make good all unevenness, depression, projections etc. during consolidation work. Rate of this item includes all these operation except consolidation. The payment shall be made on cmt. basis.

### **ITEM - 6 Spreading the stone aggregates for soiling and W.B.M. including filling the interstices to required camber and gradient (excluding spreading of blindage) (i) 40 mm to 63 mm size H.B. Stone aggregates (H.B.) (ii) 25 mm to 90 mm size H.B. stone aggregate, (iii) Chipping varying from 6 mm to 25 mm size (iv) 20 mm to 50mm size crushed.**

1. Metal shall not be spread without permission of the Engineer-in-charge. Metal should be spread under careful supervision by trained coolies. Contractor shall see that uniform spreading as per collection of metal is done. The contractor shall spread the metal fully from the stacks without keeping any balance unless directed by the Engineer-in-charge to keep some stack in balance for making good unevenness or depressions during rolling works. To ensure that the material is spread to the required thickness, the road surface shall be marked out in to length over which the contents of heaps are to be spread. The bounds of earth or murrum (one on either side) shall be laid with a distance between them equal to the width of road to be metaled and shall be enough to prevent the loose metal from spreading during consolidation as well as to retain water used for consolidation. Payment for bunds will be made in the respective item,

2. The metal (including old metal) shall be screened and rubbish, dust, grass shall be removed and spread evenly on the prepared surface in grade and camber by using camber board etc. so as to ensure that the surface is true to camber and grade. At least two camber by using camber boards shall be in use at site. The surface shall be checked at every 50 ft. by means of template white the correctness of the camber in between shall be tested by string and corrected as required. Between the straight lengths and the curves in camber of road to superelevation shall be made very gradually as may be directed by the Engineer-in-charge.

3. The spreading of metal shall proceed only 200 mt. (max.) advance of the rolling operations. The collection and spreading of the metal shall not be carried out in one and the same kilometer.

4. At the time of rolling all surface irregularities, hollows, depressions, humps etc. shall be straight. The spreading of metal in required layer shall be done by the contractor. The rate for this item shall be paid on cmt. basis and includes all the above operations with all lead and lift except consolidation

**Item-6(A) Spreading the stone aggregates for soiling and W.B.M. including tilling the interstices forming the surface to required camber and gradient by paver finisher (Labour charges only but including hire and operating charges of paver)**

Specification same as item No.6 except that metal or stone aggregate shall be spread by paver finisher and not manually. Besides all the labour charges, the rate also includes the hire and operating charges of paver. The contractor shall have to make his own arrangement for procuring appropriate paver.

**Item-6(B) Spreading quarry spalls in grade & camber complete.**

1. The quarry spalls shall be only be allowed to be spread after the written permission of the Executive Engineer is obtained.
2. The permission for spreading the metal shall be given by the Executive Engineer if
  - (i) The full quantity of a particular mile(kilometer)is completely collected.
  - (ii) The collection of metal-is also completed in the adjoining two miles (Kilometers)
  - (iii) The measurements are recorded in the Measurement book.
3. Q. S. shall if required, be screened, if containing rubbish dust, grass etc. it shall then be filled in basket & conveyed where required and spread evenly on the prepared surface be given twisting motion to the basket at the time of spreading. The surface shall then (15 m) by means of templates and strings as well as with camber boards and spirit level.
4. Between the straight length and curves and at the meeting points of the convex and concave portions of the reverse curves, the change in camber of the road, due to super elevations shall be made as well as with camber boards and spirit level.
5. At the time of spreading Q. S. a small quantity (about 4 to 5 percent) of metal as directed, shall be retained at the first instance. It shall be spread later 0:1 after partial consolidated as required to rectify the camber and to fill up the hollows if any. No extra amount shall be paid for this.
6. Measurements shall be paid as per the measurements of collection less the quantity remained to be spread and on cubic metre basis.
7. The rate includes the cost of screening the Q. S. if any spreading, sectioning, with template and adding reserved quota of metal, while/oiling is in progress for making good hollows and camber.
8. The surface shall be brought to the required camber which shall be checked at every 50 ft. (15 M) by means of templates of while the necessary of the in between shall tested by strings and corrected as required.
9. The centre line shall first be marked in the subgrade which is properly consolidated and has uniform camber and grade as required
10. The Q. S. shall be laid for a small length on 25 ft. (8 M.) and then the edge stones shall be laid.
11. Pegs shall be driven on either side of the road and joined with strings true and parallel with a distance between them equal to the width be laid with over metal Similarly.
12. The Q.S. shall be laid as close as possible so as to leave minimum possible interstices and voids.
13. Before roiling is allowed on soling the side berms shall be filled upto the top of the soling and at least 3'-0" (1 m.) on either side so as to prevent metal layer getting disturbed at times during rolling. The rate is inclusive of all the operations as stated above.

**ITEM-7 Rolling & Consolidating water bound macadam (except laterite & kankar) incl. watering not exceeding 150 mm thickness (main layer including binding materials) including filling in depression which occur during the process with power roller exceeding 8.0 M.T. but not exceeding 12.0 M.T.**

1. Immediately following the spreading of the coarse aggregates rolling shall be with three wheeled power rollers of 8 to 10 tonne capacity or tandem roller or equivalent vibratory roller. The weight of the roller shall depend upon the type of the aggregate and be indicated by Engineer in-charge.
2. Except on super elevated portions where the tolling shall proceed from inner edge to outer, rolling shall begin from the edges gradually progressing towards the centre. First the edge/edges shall be compacted with roller running forward and backward. The roller shall then move inwards parallel to centre line of the road in successive passes uniformly lapping preceding tracks by at least one half the width.
3. Rolling shall continue until the aggregate is thoroughly keyed and the creeping of the aggregate ahead of the roller is no longer visible. During Tolling slight sprinkling of water may be done, if necessary. Rolling shall not be done when the sub-grade is soft or yielding or when it causes a wave like motion in the sub-grade or sub-base course.
4. The rolled surface shall be checked transversely and longitudinal with templates and any irregularities corrected by loosening the surface, adding or removing necessary amounts of aggregate and rerolling until, the entire surface conforms to desired camber and grade. In no case shall the use of screening be permitted to make up depression.



5. The blindage material where it is required to be used shall be applied successively in two or more thin layers at a slow and uniform rate. After each application, the surface shall be copiously sprinkled with water, the resulting slurry swept in with hand brooms or mechanical brooms to fill the voids properly and rolled during which water shall be applied to the wheels of the rollers if necessary to wash down the binding material sticking to them. These operations shall continue until the resulting slurry after filling of voids forms a wave ahead of the moving roller.

6. After the final compaction of water bound macadam course the road shall be allowed to dry overnight Next morning hungry spots shall be filled with screenings of binding materials as directed lightly sprinkled with water if necessary and rolled. No traffic shall be allowed on the road until the macadam has set. The Engineer-in-charge shall have the discretion to stop hauling traffic from using the completed water bound macadam course if in his opinion it would cause excessive damage to the surface.

7. Payment will be made on Smt. basis of the finished work and shall include cost of watering rent of machinery cost fuel, wages of drivers and cleaners and murrum bund etc.

**ITEM-8 Providing and fixing indicator stone of approved stone as per I.R.C. type design in C.C. 1:4:8 including whitewashing etc. complete.**

**(1) Fixing in earth.**

1. Indicator stones shall be of approved quality and of the size 20 cm x 20 cm its length shall not be less than 80 cms. The top. 38 cm shall be chisel dressed on all sides. The size shape and dimension of the indicator stone shall be exact and stones shall be neatly dressed and finished before fixing. The indicator stones shall be fixed firmly in position in embankment or cutting as the case may be. The exposed part of the indicator stone shall be done by the contractor at his own cost. The measurement for payment shall be per number of indicator stone fixed in position.

2. Unit rate indicator stone includes the cost of all materials labour, tools, fixing, and white washing as directed by the Engineer-in-charge.

**(2) Fixing in C.C. 1:5:10**

Specification same as 8(1) above except that the indicator stone shall be fixed in C.C. 1:5:10 which will consist of one part of cement five part of good sand and ten parts of good brick bats. Rate includes all labour and curing etc necessary for concrete.

**ITEM-9 Providing and fixing ordinary kilometre stone of precast C.C. 1:2:4 including necessary reinforcement as per I.R.C. type design in C.C. 1:4:8 including and paints and letter etc. complete, (for N.H., 5.H. and M.D.R.)**

1. Kilometer stone shall be of approved quality and shall be either black Rajula stone or of precast 1:2:4 R.C.C. as specified in the item.

2. The size manner of fixing painting and lettering of K.M. stone shall conform specification as per I.R.C.-8 (Type design for Highway kilometre stones). The fixing of K.M. stone shall be carried out in ordinary concrete of grade specified in the item using hand broken metal field metal or gravel. The measurement for payment shall be made per No. of K.M. stone fixed in position.

3. Unit rate for kilometre stone includes the cost of all materials, labour, tools, fixing, finishing curing, lettering and painting as directed by the Engineer-in-charge.

**ITEM-10 Providing and fixing fifth kilometre stone of precast C.C. 1:2:4 including necessary reinforcement as per I.R.C. type design in C. C. 1:4:8 including painting and lettering etc. complete, (for N.H.. S.H. and M.D.R.)**

1. The work shall be carried out as per the item of ordinary kilometre stone except that the size of the fifth kilometre stone shall be bigger than that of ordinary kilometre stone as per I.R.C.-8 (Type design for highway kilometre stones). The fixing of K. M. stone shall be in ordinary concrete of grade specified in the item. The measurement for payment as well as the operation included in the unit rate shall be as per ordinary kilometre stone.

**ITEM-11 Providing and fixing hectometre stone as per I.R.C. type design including painting lettering etc. complete.**

**(1) Fixing in Earth :**

The work shall be carried out as per the item of ordinary kilometre stone except that the size of Hectometre stone shall be smaller than that of ordinary kilometre stone as per I.R.C. 26 (Type design for 200 metre stones) and fixing shall be in earth. The measurement for payment as well as the operations included in the unit rate shall be as per ordinary kilometres stone.

**(2) Fixing in C. C. 1:5:10**

Specification same as 11 (1) above except that the indicator stone shall be fixed in C.C. 1:5:10 which will consist of one part of cement, five part of good sand and ten parts of good brick bats. Rate includes all labour and curing etc. necessary for concrete.

**ITEM-12 Providing and fixing guard stone as per I.R.C. type design including white washing etc. Complete.**

**(1) Fixing in Earth/Wearing Coat:**

- 1 . The guard stone shall be of approved quality and of 20 cm x 15 cm. size and its length shall not be less than 75 cms. The top portion shall be rounded. The top 38 cm. shall be chisel dressed on all sides. The size, shape and dimensions of the guard stones shall be exact and shall be neatly dressed and finished.
2. The guard stone shall be fixed in position as directed by the Engineer-in-charge in earth/wearing coat. If the guard stone shall be fixed in wearing coat, the equivalent volume covered by the guard stones shall be deducted from the gross measured quantity of wearing coat. The exposed part of the guard stones shall be given three coats of white wash. Any excavation necessary for fixing of the guard stones shall be done by the contractor at his own cost; The measurement for payment shall be per number of guard stone fixed in position.
3. Unit rate of guard stone includes the cost of all materials, labours, tools, fixing & white washing as directed by the Engineer-in-charge.
4. In case of Deep/Causeway the guard stone shall be fixed in masonry of head wall as directed by Engineer-in-charge.

**(2) Fixing in C.C. 1:5:10**

Specification same as 12 (1) above except that the indicator stone shall be fixed in C.C. 1:5:10 which will consist of one part of cement, five part of good sand and ten parts of good brick bats. Rate includes all labour and curing etc. necessary for concrete.

**ITEM-13 Supplying and fixing road sign board of M.S. Plates and angle iron including painting, lettering etc. complete including fixing in C.C. 1:4:8 with necessary excavation etc. complete as per I.R.C. design.**

**(1) Non reflective type :**

- 1 . The board shall consist of a 90 cm x 90 cm triangular plate of 6 mm thickness at the top and a 90 cm x 61 cm rectangular plate of 6 mm thickness below if fixed at suitable distance. This shall be fixed to the angles iron post of 75 mm x 75 mm x 6 mm size by means of welding or reeling as directed by the Engineer-in-charge. The angle iron post shall be split at the bottom end to 10 cm (minimum) in length and shall be fixed at right angle to the central line of the road in ordinary concrete of grade as specified in the item/using hand broken metal, field metal or gravel. Two steel bars of 12 mm dia, shall also be embedded in concrete for fixing as directed by the Engineer-in-charge. The top of the post shall be at a height of 25 cm. as above the ground level. Concrete platform shall be of the size 45 cm x 45 cm and shall project 2.5 cm above ground level and shall be at least 60 cm below ground level. Total height of post shall be 3 mt. (minimum). The exposed platform shall be neatly finished and its shape shall be as directed by the Engineer-in-charge.
2. The post will be painted with two coats alternatively in black and white strips 23 cm in height after applying one coat of anticorrosive paint. The paint shall be of approved quality. The board shall be painted with approved colour and lettering shall be in accordance with I.R.C. 30 (Standard Letters and Numerals of Different Heights for use on Highway designs) and as per notified signs of Motor Vehicle Act. respectively.
3. The measurement for payment shall be per number of sign board fixed in position.
4. The unit rate includes the cost of materials, labour tools, drilling of holes, riveting or welding, fixing, curing, lettering, painting as directed by the Engineer-in-charge.

**(2) Reflective Type**

Specifications will be same as 13 (1) above except that signs shall be reflective type.

**ITEM-14 Providing and fixing village name boards as per standard I.R.C. type design of steel plate including painting, lettering etc. complete with fixing in C.C. 1:4:8 block with necessary excavation.**

- 1 . The work shall be carried out as per the item of sign boards except that there shall not be top plate of 90 cm x 90 cm triangular shape and lower plate of 90 cm x 61 cm rectangular plate of 6 mm thickness shall be fixed at top facing towards the direction of the village.
2. The board plate shall be painted in black colour Letters & figures shall be painted in white colour with an arrow directing towards the village painting & lettering shall be done both sides. The size of the letters & figures as well as thickness of arrow will be as directed by the Engineer-in-charge.
3. The measurement for payment as well as operations included in the unit rate shall be .as per item of sign boards.

**ITEM-15 Supplying of machine crushed stone aggregate chipping etc. of hard stone following nominal size free of disintegrated pieces deleterious and organic matter including filling the boxes with all lead and lift etc. complete on site of road.**

**(a) Kapchi and (b) Grit**

1. Stone chips shall consist of regular fragments of clean, hard, tough and durable rock of uniform quality throughout. They shall be obtained by crushing rock, and shall be free of elongated and flaky pieces, soft and disintegrated materials, and vegetable or deleterious matter They shall satisfy the quality requirements set forth as shown hereafter.

Sr.No.	Test	Test Method.	Requirement.
1	Los Angeles Abrasion Value	IS : 2386 (part IV)*	35% Maximum
2.	Aggregate Impact Value	-do-*	30% Maximum
3	Flakiness Index	IS : 2385 (Part I)	30% Maximum
4.	Stripping Value	IS : 6241	25% Maximum
5.	Water Absorption	IS : 2386 (Part III)	2% Maximum

\* Aggregate may satisfy requirement of either of the two tests.

Size of stone chips shall be as under :-

(a) Kapchi : 12 mm size : Passing 20 mm sieve and retained on 10 mm sieve.

(b) Grit : 5 mm size : Passing 10 mm sieve and retained on 2.36 mm sieve.

3. The samples of stones chips collected from approved quarries shall be got tested at Government recognised laboratory as may be directed to the contractor at his own cost. The result shall conform to the standard requirements laid down in para (i) above. Collection of stone chips as per approved samples shall be allowed by the Engineer-in-charge. Testing charges shall be borne by the contractor Payment at full rates for the stones chips shall not be made till the test results from the laboratory are received and found acceptable

4. Stacking shall be done by filling in standard steel boxes of 2.0 m x 1.5 m x 0.5 m size which shall be supplied by the Department if available on rent, otherwise contractor shall make his own arrangements. No deduction for voids shall be made from the gross measurements. Where any doubt exist as to whether the quantity of stacks in any hectometre is not confirming with the cubic content of the standard pharas (2.5 m x 1.5 m x 0.5 m) it shall be got corrected by the Contractor if so ordered by the Engineer-in-charge for which no extra payment shall be claimed by the Contractor If the quantity in any stack in a particular hectometre is found to be less than the standard measurements viz.. 1.5 cmt. the entire collection in the hectometre shall be paid on the quantity of the smallest stack so found Regular stacks shall be done by the Contractor on a fairly level ground. Stacking shall be done in a manner as directed by the Engineer-in-charge.

5. The collection shall always commence at one end of the Kilometre and be carried out continuously towards the other end, unless the Engineer-in -charge directs otherwise.

6. Control on quality of material shall be exercised by the Engineer-in-charge by carrying out the following tests at the frequencies shown against each.

Sr. No.	Type of Construction Material	Test	Frequency
1.	Grit/Kapchi for open graded Carpet and seal coat.	(i) Aggregate impact value	One test per 100 cu.m.
		(ii) Flakiness Index of aggregate	One test per 100 cu.m.
		(iii) Stripping value & water absorption of aggregates	initially one set of 3 representative specimens for each source of supply subsequently when warranted by changes in the quality of aggregates
		(iv) Grading of aggregates	One test per 100 cu.m. of aggregate

8. The payment shall be made on cubic metre basis without deduction for voids. The contractor shall be responsible for preserving the materials throughout the period the contract remains in force The use of materials shall not be allowed till the materials conveyance to the site with al' lead and lift and filling boxes including all labour, tools, equipment and other incidental expenses.

**ITEM - 16(A)Supplying and Stacking 80/10C asphalt as per requirement including carting, stacking, and protecting on road side etc. complete. (If asphalt is supplied by Department)**

1. Bitumen shall be issued by the Department at the rate and place mentioned in Schedule 'A' of the tender. It shall have to be carted by the contractor to the site of work at his own cost Empty asphalt drums shall have to be returned free of cost to P.W.D. store from where they are issued or as directed, if so provided in

Schedule 'A' Any damage caused to the asphalt drum or loss of asphalt after issue from the store shall be the responsibility of the contractor. Drums of asphalt shall be so stored as to allow easy inspection and in such place a will not damage the drums and cause leakage or allow water and other foreign matter to enter, (dilute may be included in labour)

2. Bitumen shall be issued by department in bulk at the rate and places as shown in Schedule-A. For bulk asphalt contractor shall have to make adequate arrangement taking bulk asphalt at plant site according to requirement.

Bulk asphalt shall be used as per instructions of the Engineer in charge of work. The tanker of bulk asphalt should be unloaded in asphalt tank or in empty drums on site of work as directed Proper rate for carting shall be deducted as per carting rate, if the bulk asphalt is given on site of work instead of place shown in Schedule-A. The carting of bulk asphalt shall be made by the contractor from Koyali Refinery as per Schedule-A.

**Keeping Records : -**

The department shall keep a day to day account of the supply and use of the asphalt in separate bound registers having number pages and in the proforma prescribed by the department. The contractor's responsible representatives shall also sign day to day in the register

3. The payment shall be made on tonnage basis.

4. The contract unit rate of supplying bitumen shall include

(1) Obtaining the bitumen from the Department.

(2) Transporting to- site.

(3) Storing, stacking and protecting

(4) Keeping record of supply and use and

(5) Returning of handing over the empty drums in good condition to the Department if so provided in Schedule -'A'.

**ITEM - 16(B) Supplying and Stacking 80/100 asphalt as per requirement including carting, stacking, testing and protecting on road side etc. complete. (If asphalt is supplied by Contractor)**

1. Bitumen shall be procured directly from refinery by the Contractor. The contractor shall make adequate arrangements for storing bulk asphalt at plant site. The Contractor will produce in original the bill of Refinery all the gate passes issued by the refinery and the number of transport tanker. The Contractor will also produce the Test Certificate regarding the grade of asphalt issued by Refinery. The Department does not undertake to furnish "P" form (regarding Sales Tax Concessions) for purchase of asphalt.

2. On receipt and storage of bitumen, The bitumen shall be got tested in GERI Laboratory or other Laboratories approved by R. & B Department. The frequency of test is specified in Para 5.

3. The Contractor will establish OR site of work site laboratory in area not less than 25 sq.m. with pucca construction and equipped with instruments to enable to carry out the following tests.

1. Penetration test as per I.S. 1203

2. Softing point test as per I.S. 1204

3. Ductility test as per I.S. 1208

4. Viscosity test as per I.S. 1206

5. Specification Gravity test as for I.S. 1202

The above instruments should be certified as per I.S. standard, the same should be regularly calibrated and should be maintained in efficient condition.

4. The Registers for use, temperature and other quality requirements of bitumen will be maintained at Plant site. The registers will be printed, as per formats approved by R.&B. Department and authorised for use by the Engineer-in-charge. The entries in the registers will be made by the departmental representative and signed by the contractor or his authorised representative.

5. Frequency of Tests :

As regards quality of binder, three tests of one sample per two tankers will be done on plant site. The tests will be carried out as per Table 900.4 of Section 900 of M.O.S.T. standard specifications. The frequency of use of specifications will be as under:

No. of Tanker	No. of Tests	No. of Tanker	No. of Tests
Upto 10	One	50. to 100	Four
11 to 20	Two	For further every 50 tanker	One
20 to 50	Three		

**ITEM-17 2 cm thick open graded pre-mix carpet surfacing with 0.27 cum. of stone chipping (12 mm size 0.18 cum and 10 mm size 0.09 cum) mixed with 14.4 kg. of bitumen per 10 sq.m. of road**

**Surface excluding rolling and consolidation etc. complete. (Stone chipping and bitumen shall be paid seperately).**

**1. With tack coat at rate of 5.00 Kg/10 sq.m.**

**2. With tack coat at rate of 10.0 kg/10 sq.m.**

1. This work shall consist of laying an open graded carpet of 2 cm thickness in a single course and seal coat ( excluding cost of asphalt, stone chips and rolling) composed of suitable small size aggregates premixed with a bituminous binder on a previously prepared base.

2. The materials shall be proportioned as per quantities given in the following table.

Quantities of materials required for 10 smt. of road surface for 2 cm. thick open – graded premix carpet with seal coat.

**Aggregate for Carpet**

(A)	Stone Chipping	12mm size	0.18 cubic metre
(B)	Stone Chipping	6mm size	0.09 cubic metre
		<b>Total</b>	<b>0.27 cubic metre</b>

**Aggregate for seal coat :**

Stone chipping	6mm size	0.12 cubic metre
----------------	----------	------------------

**Binder for premixing ( Quantities in terms of straight run bitumen)**

**(i) For Carpet**

(A)	For 0.18 cmt of 12mm size stone chipping at 52Kg/cmt	9.36	Kg.
(B)	For 0.18 cmt of 6mm size stone chpping at 64kg/cmt	5.04	Kg.
		<b>Total</b>	<b>14.40 Kg.</b>

**(ii) For Seal coat**

(A)	For 0.12 cmt 10mm size stone chipping at 64kg/cmt.	7.68	Kg.
-----	--	------	-----

3. Carpet shall not be laid during rainy weather or when the base course is damp or wet or when the atmospheric temperature in shade is 16 degree centigrade or below.

4. The underlying base on which the bituminous carpet is to be laid shall be prepared, shaped and conditioned to the specified lines, grade and cross – section as directed by the Engineer in charge. The surface shall be well cleaned with wire brushed, sweeping with brooms and finally dusting with sacks as necessary.

5. **Tack coat** : This work shall consist of application of a single coat of bituminous material to an existing road surface preparatory to another bituminous construction. The temperature of bitumen at the time of application shall be in the range of 160.0 deg. Centigrade to 175.0 deg. Centigrade.

6. Binder shall be heated to temperature appropriate to the grade of bitumen used and approved by the Engineer in charge at the rate specified hereafter. The rate of spread in terms of straight run bitumen shall be 5 kg per 10 square metre area for untreated water bound macadam surface. The binder shall be applied uniformly. The tack coat shall be applied just ahead of the on coming bituminous construction. For the purpose of calculating consumption, wastage of bitumen will not be permitted beyond 2.5% Excess consumption over 2.5% will be charged at panel rate.

7. Mixers of approved type shall be employed for mixing the aggregates with the bituminous binder. The binder shall be heated to the temperature approved by the Engineer in charge, avoiding local overheating and ensuring a continuous supply. The aggregates shall be dry before they are placed in the mixer. After about 15 seconds of dry mixing, the heated binder shall be distributed over the aggregates at the rate specified. Kerosene to an extent of 4% to 6% of asphalt shall be provided by the contractor according to the requirement at the contractors cost. The mixing of binder with chipping shall be continued until the chipping are thoroughly coated with the binder. The mix shall be immediately transported from the mixer to the point of use in suitable vehicles or wheel barrows. The vehicles employed for transport shall be clean & be covered over in transit, if so directed.

8. The premixed material shall be spread on the road surface with rakes to the required thickness and camber, or distributed evenly with the help of a drag spreader, without any undue loss of time. The chamber shall be checked by means of camber boards and inequalities evened out. As soon as sufficient length of bituminous material has been laid rolling shall commence ( Rolling shall be done departmentally) When the roller has passed over the whole area once, any high spots or depressions which become apparent shall be corrected by removing or adding premixed materials. The contractor shall provide necessary labour for keeping the roller wheels damp during rolling so as to prevent the premix from adhering to the wheels and being picked



BHAVNAGAR MUNICIPAL CORPORATION - BHAVNAGAR

up. The edges along and transverse of the carpet laid and compacted earlier shall be cut to their full depth so as to expose fresh surface which shall be painted with a thin surface coat of appropriate binder before the new mix is placed against.

9. Seal coat for preparation of premix and spreading, etc Para 7 & 8 above shall apply. The coat shall be applied immediately after the laying of bituminous course of carpet. Before application of seal coat, materials surface shall be cleaned free of any dust or other extraneous matter.

10. Coarse sand or stone dust flushing at the rate of 0.03 cmt/10 smt shall be done on asphalt surface at the contractor's own cost.

11. Traffic may be allowed soon after final rolling when the premixed materials has cooled down to surrounding temperature.

12. Control on quality works shall be exercised by the Engineer-in-charge by carrying out the following tests at the frequencies shown against each :

Sr.No.	Type of Const. Material.	Test.	Frequency.
1	Tack Coat	(i) Binder temperature for application	At regular close intervals.
		(ii) Rate of Spread of binder of aggregate.	Two test per day.
2	Open graded premix carpet with seal coat.	(i) Temperature of binder at application.	At regular close intervals.
		(ii) Binder content (vide As/TM : D2172).	Two tests per day for work of every 3km length in one lane.
		(iii) Rate of spread of mixed material.	Regular control throughout checks on material & layer thickness.

13. Para 13 to 17 : As regards arrangements for traffic para 29 of 33 of semi dense carpet shall apply.

18. Open graded carpet and seal coat shall be measured in cubic metres on the basis of stone chips actually used.

19. The contract unit rate for open grade carpet and seal coat (excluding cost of asphalt. stone chips and rolling) shall be payment in full for carrying out the required operations including full compensation for

- (1) Preparation of base.
- (2) Providing all materials like fuel, lubricants, kerosene and coarse sand or stone dust for flushing with all-leads and lifts.
- (3) All labours, tools, equipment and incidentals.
- (4) Making arrangements for control and safety of traffic.

**ITEM-18 Providing and laying 20/25mm thick bituminous open graded carpet with B.T. aggregates 0.66 cm/M.T. using bitumenous for tack coat at the rate of @ rate of 10 Kg./10 Smt. on W.B.M. surface and 5 Kg.710 Smt. for B.T. surface and for mixing at the rate of 32.8 kg/M.T. of total mix i.e.3.28 per M.T. of total mix and heating asphalt & aggregate by continuous batching hot mix plant and spreading the same by paver finisher including consolidation with power road roller including providing equipment T & P oil, fire wood ,kerosene labour charges etc. compt. using contractor's own machineries hot mix plant and paver finisher including . flushing of sand 0.30 cmt/100 sq.mt.**

The work shall consist of construction in a single course of 20/25 mm. thick premixed carpet as course, on a previously prepared base Single course shall also include additional thickness if any to remove unevenness of the existing surface.

1. The coarse aggregates shall consist of crushed stone only. These, shall be clean, strong durable of fairly cubical shape. free of disintegrated pieces, organic or other deleterious matter and adherent coatings. The aggregates shall preferably be hydrophobic and of low porosity and shall satisfy the physical requirements set forth as under.

Physical Requirements of Aggregates for Bituminous Macadam.

Sr. No.	Test	Test Method	Requirement.
1	Los Angles Abrasion Value	IS : 2386 (Part IV)*	35% Maximum
2	Aggregate Impact Value	-do-	30% Maximum
3	Flakiness Index	IS : 2386 (Part I)	30% Maximum
4	Stripping Value	IS : 6241	25% Maximum
5	Water Absorption	IS : 2386 (Part III)	2% Maximum

\* Aggregate may satisfy requirements of either of the two tests.

3. The fine aggregates shall consist of crushed run screening, natural sand or mixture of both. There shall be clean hard durable, uncoated, dry and free from injurious, soft or flaky pieces and organic or deleterious substance.
4. The filler, where required, shall be an inert material, the whole of which passes 600 micron sieve at least 90 percent passing 150 micron sieve and not less than 70 percent passing 75 micron sieve. The filler shall be cement, stone dust, hydrated lime or fly ash approved by the Engineer in charge.
5. The mineral aggregates, including mineral filler, shall be so graded or combined as to conform to the grading as under.

**Table Aggregate gradation for Asphalt carpet.**

Sieve Size	% by weight passing the Sieve for 20/35 mm
20 mm	100
12.5 mm	70-100
10.0 mm	20-40
4.75 mm	0-5
2.36 mm	

6. The samples of aggregate of requires gradings for the work shall be got approved from the Engineer-in-charge prior to transportation and collection on plant site. Unapproved materials shall have to be removed from the plant site by the contractor at his own cost. If contractor fails to remove the inferior type of materials from the plant site, the same will be removed by the Department at the cost of the Contractor Collection of aggregate shall be in different stacks according to various sizes of aggregates.

7. For the purpose of collection of materials, plant site shall be established at suitable place, where hot mix plant shall be installed. Department will extend all necessary co-operation in helping Contractor to get nearby Government land of establishing plant site. However, department is not responsible if no such land is made available to the Contractor and in that case, the Contractor will have to make his own arrangement for the same. Incoming material shall be recorded in a register for the purpose of record.

8. The binder shall be straight run bitumen of a suitable grade satisfying the requirements of IS:73. Bitumen shall be 60/80/100 grade and shall be supplied by the department at the rate and place as mentioned in Schedule "A" of the tender and it shall have to be carted, by the Contractor to the site of work at his own cost. Empty asphalt drums shall have to be returned free of cost to P.W.D. Store from where they are issued or as directed, if so provided in Schedule 'A' Any damage caused to the asphalt drums or loss of asphalt after issue from store shall be the responsibility of the Contractor. Drums of asphalt shall be so stored so as to allow easy inspection and in such place as will not damage the drums and cause the leakage of allow water and other foreign matter to enter For the purpose of calculating consumption, wastage will not be allowed beyond 2.5 percent Excess consumption over 2.5 percent will be charged at a panel rate.

9. In case bitumen is to be issued by department in bulk, the same shall be issued to the Contractor at plant site by tankers at the same rate as shown in Schedule 'A'. Contractor shall have to make adequate arrangement for slacking bulk asphalt at plant site according to the requirement No deduction in rate will be made for supplying heated bulk asphalt.

10. The asphalt should not be used as a fuel. If however, Contractor is found to be using asphalt as fuel, The quantity of asphalt utilised shall be assessed, by the Executive Engineer whose decision will be final and binding to the Contractor who will be charged at double the rate provided in Schedule 'A' of the agreement even though the total consumption of asphalt may be within the theoretical consumption.

11. Department shall keep a day to day account of the supply and consumption of bitumen in a separate bound register having numbered pages and the proforma prescribed by the Department. Day to day signature of the Contractor's representative shall be obtained in this register Issue rate of bitumen includes (i) Obtaining asphalt from Department's store, (ii) Transporting to site, (iii) Storing and stacking, (iv) Keeping records of supply and consumption and (v) returning the empty drums in good condition to the Department.

12. Semi dense carpet shall not be laid during rainy weather or when the base course is damp or wet.

13. The base on which semi dense carpet is to be laid shall be thoroughly swept and scraped clean and free of dust and foreign matter.

BHAVNAGAR MUNICIPAL CORPORATION - BHAVNAGAR

14. The work shall consist of application of a single coat of bituminous to an existing road surface preparatory to another bituminous construction. The temperature of bitumen at the time of application shall be in the range of 160 Degree centigrade to 175 degree centigrade.

15. Binder shall be heated to the temperature appropriate to the grade of bitumen used and approved by the Engineer-in-charge and sprayed on the base at the rate specified hereafter. The rate, of spread of straight run" bitumen for tack coat shall be 5 kg per 10 square meter area for an existing bitumen treated surface. The binder shall be applied uniformly. The tack coat shall be applied just ahead of the on coming bituminous construction. In case carpe Us to be laid on W.B.M. surface. rate of spread of Bitumen for tack cost will be 40 kg./10smt.

16; The binder content for premixing shall be 3.28 percent by weight of the total mix unless otherwise specified. The quantities of aggregates shall be sufficient to yield the specified thickness after compaction.

17. The contractor shall get the job-mix formula for the mix approved, by the Engineer-in-charge before starting the work. In order to obtain the required type of mix, the department may change the proportion of bitumen and gradings of aggregate and contractor shall have to collect the materials accordingly. In case of increase in proportion of bitumen the increased or decreased quantity will be adjusted at the rate provided in Schedule 'A' The contractor shall have the responsibility of ensuring proper proportioning of materials in accordance with the approved job-mix formula and producing a uniform mix,

18. Hot mix plant of adequate capacity and capable of producing a proper and uniform quality shall be used for preparing the mix. The plant may be either a batch type or a continuous one, having coordinated set of essential unit such as dryer for heating the aggregates, a binder heating and control unit for metering out the correct quantity of heated binder together with a paddle mixer for intimate mixing of the binder and aggregate. .

19. The temperature of binder at the time of mixing shall be the range of 150 -177 degree centigrade and of "aggregates in the range of 155 - 163 degree centigrade. .Provided also that, at no time shall the difference in temperature between the aggregates and the binder exceed 14 degree centigrade.

20. Mixing shall be thorough to ensure that a homogeneous mixture is obtained in which all the particles to the mineral aggregates are coated uniformly.

21. The mix shall be transported from the mixing plant to the point of use in suitable vehicles. The vehicles employed for transport shaft be clean and be covered over during transit if so directed by the Engineer-in-charge.

22. The mix transported from the hot mix plant to the site, shall be spread by means of a self propelled mechanical paver with suitable screeds capable of spreading, tamping and finishing the mix, to specified grade, lines and cross sections. The temperature of mix at the time of laying shall be in range 121-163 degree centigrade.

23. Longitudinal joints and edges shall be constructed true to the delineating lines parallel to the centre line of the road. Longitudinal joints shall be offset by at least 150 mm. from those in the binder course. All joints shall be cut vertical to the full thickness of the previously laid mix and the surface painted with hot bitumen before placing fresh material.

24. Immediately after the spreading of mix, it shall be thoroughly compacted by 8-10 tonnes 3 Wheel . roller moving at a speed not exceeding 5 km per hour.

25. The roller wheels shall be kept damp to prevent the mix from adhering to them but in no case shall fuel lubricating oil be used for this purpose. Rolling shall commence longitudinally from the edge arid progress towards the centre except on super elevated portions. When it shall progress from the lower to upper edge parallel to the centre line of the pavement. The roller should/proceed on the fresh material with rear or mixed wheel leading or as to minimise the pushing of the mix and each pass of the roller shall uniformly overlap not less than one third of the track made in the preceding pass. Rolling shall continue until the entire surface has been rolled to compaction and all the roller marks eliminated.

26. Sand or stone dust flushing at the rate of 0.03 cmt / 10 smt. shall be done on asphalt surface for which no separate payment will be made.

27. Traffic may be allowed immediately after completion of the final rolling when the mix has cooled down to the surrounding temperature.

28. Surface finish and quality control of work : Control on the quality of materials and works shall be exercised by the Engineer-in-charge by carrying out the following test at the frequencies shown against each :-

**37 General Technical Specification of Roads.**



**BHAVNAGAR MUNICIPAL CORPORATION - BHAVNAGAR**

Sr. No.	Type of Construction	Test	Frequency.
1.	Tack Coat	(i) Binder temperature for application	At regular close intervals.
2.	Semi-Dense Carpet	(ii) Rate of spread of binder (i) Aggregate Impact Value (ii) Flakiness Index of Aggre. (iii) Stripping Value (iv) Mix Grading  (v) Temperature of binder in the boiler, aggregate in the dryer and mix at the time of laying and rolling (vi) Control of binder content and gradation in the mix (Binder Content test vide ASTM D-2172) (vii) rate of spread mix material	Two test per day One test per 100 Cu. m. of aggre. -Do- -Do- One set of test on individual constituents and mixed aggregates from the dryer for each 100 tonnes of mix subject to a minimum of two test per day At regular close intervals.  One test for each 100 tonnes of mix subject to max. of two test per day per plant  Regular control through checks on layer thickness

29. The contractor shall at all times carry out work on the highway in a manner creating least interference to the flow of traffic while consistent with the satisfactory execution of the same. For all work involving improvements to the existing highway, the contractor shall in accordance with the directives if the Engineer-in-charge provide and maintain, during the execution of the work, a passage for traffic either along a part of the existing carriage way under improvement or on diversion.

30. In case of the improvement works, namely widening strengthening of the existing pavement or reconstruction repairs-to cross-drainage works. Where such works could be carried out on part widths at a time and the traffic could simultaneously be passed without undue delay and difficulty on the other part; the road shoulder shall be dressed and brought in-line with the pavement and maintained throughout the duration of the work to the satisfaction of the Engineer-in-charge Where work is continued on long stretches, passing places, at least 20 metre long and 6 metre wide inclusive of the width of the existing carriage way shall be provided at

half or one kilometer intervals as directed by the Engineer-in-charge. Extra treatment to shoulders where necessary, shall be given as ordered by the Engineer-in-charge

31. The contractor shall take the all necessary measures for the safety of traffic during construction and provide, erect and maintain such barricades including signs, marking lights and flagmen as may be required, by the Engineer-in-charge for the information and protection of traffic approaching or passing through the section, of the highway under improvement. Before taking up any construction an agreed phased programme for the control of traffic on the highway shall be drawn up in consultation with the Engineer-in-charge.

32. The barricades erected on either side of the carriage way/portion of the carriage way closed to traffic shall be strong to resist violation, and painted with alternate black and white stripes. Red lanterns or warning lights of similar type shall be mounted on the barricades at night and kept lit throughout from sunset to sunrise. At the points where traffic is to deviate from its normal path the channel for traffic shall be clearly marked with the aid of pavement marking painted drums or a similar device to the direction of the Engineer-in-charge. At night the passages shall be delineated with lanterns or other suitable light source.

33. One way traffic operation shall be established whenever the traffic is to be passed over part of the carriage way inadequate for two lane traffic. This shall be done with the help of flagmen kept positioned on opposite side during all hours. For regulation of traffic, the flagmen shall be equipped with red and green flags and lanterns lights. On both sides, suitable regulatory/warning signs shall be installed for the guidance of carriage way begins and the other 120 metres away. The signs shall be of approved design and the refractory type if so directed.

34. The payment shall be made on the tonnage basis of the weight of mix of aggregate and bitumen. For this purpose the contractor shall have to install a weigh bridge of suitable capacity for the purpose of weight of dumpers at suitable place at his cost as directed. Weight of empty dumper and weight of loaded dumper will be recorded in bound and numbered register on plant site.

Department will be free to get some loaded dumpers test checked at other weigh bridges. Weigh bridge will be

periodically got calibrated and verified from weight and measure authorities.

35. Weight of mix materials will be done in presence of responsible person, not less than the rank of supervisor of Department and the measurements shall be recorded by the Deputy Engineer. Junior Engineer of Supervisor, if so authorised. Record of each dumper will be maintained separately in bound and numbered register which will be maintained by the department representatives and signed by the contractor. Proper gate pass system shall be established, for the vehicles coming to the plants, site and out going from the plant site. The location of hectometre in which individual dumpers are unloaded shall be recorded carefully.

36. The contract unit rate for semidense carpet shall be in full for carrying out the required operation including lull compensation for :-

1. Making arrangements of control and safety of traffic.
2. Preparation of base.
3. Providing all materials to be incorporated in the works with all lead and lifts.
4. All labour, tools, equipment and incidentals to complete the work to the specification.

**ITEM 19 Semi Dense Carpet**

(As standardized by R & B Circular No. SSR-1087-205 (21) (C) dated : 29-10-1987.

**1. Description**

The work shall consist of construction in a single course of 20/25 mm. thick semi-dense carpet as wearing course, on a previously prepared base, to the requirements of these specifications.

**2. Materials**

**2.1 Binder :** The binder shall be straight run bitumen of 60/70 or 80/100 grade satisfying the requirement of IS . 73. The actual grade of the binder to be used shall be decided by the Engineer-in-charge.

**2.2 Coarse aggregates :** The coarse aggregate shall consist of crushed stone or crushed gravel. These shall be clean, durable, of cubical shape, free from disintegrated pieces, organic or other deleterious matter and adherent coatings. The aggregates shall preferably be hydrophobic and of low porosity and shall satisfy the physical requirements set forth in Table given in Item No. 18 Para 2.

**2.3 Fine aggregates :** The fine aggregates shall consist of crusher run screenings, natural sand or a mixture of both. These shall be clean, hard, durable, uncoated, dry and free from injurious, soft of flaky pieces and organic or deleterious substances.

**2.4 Filler :** The filler, where required, shall be an inert material the whole of which passes 600 micron sieve at least 90 percent passing 150 micron sieve and not less than 70 percent passing 75 micron sieve. The filler shall be cement, stone dust, hydrated lime, fly ash and other non-plastic mineral matter approved by the Engineer-in-charge.

**2.5 Aggregate gradation :** The mineral aggregates, including mineral filler, shall be so graded or combined as to conform to gradings set forth in tables below :

**Table : Aggregate gradation For Semi-Dense Carpet**

Sieve Designation	% by weight passing the Sieve		Sieve Designation	% by weight passing the Sieve	
	For 25 mm thickness	For 20 mm thickness		For 25 mm thickness	For 20 mm thickness
20 mm	100		600 micron	10-22	10-22
12.5 mm	75-100	100	300 micron	6-16	6-16
10 mm	60-85	75-100	1 50 micron	4-12	4-12
4.75 mm	35-55	35-55	75 micron	2-8	2-8
2.36 mm	20-35	20-35			

**2.6 Proportioning of materials :** The binder content for premixing shall be 4.28 percent by weight of the total mix.

The quantities of aggregates shall be sufficient to yield the specified thickness after compaction. The contractor shall get the job-mix formula for the mix approved by the Engineer-in-charge before starting the work.

**2.7 Variation in Proportioning of material :** The Contractor shall have the responsibility of ensuring proper proportioning of materials in accordance with the approved job mix formula and producing a uniform mix. variation in binder content of  $\pm 0.3$  percent by weight of total mix shall, however, be permissible in individual specimen taken for quality control tests vide MOST Specification Section 900.

**3. CONSTRUCTION OPERATIONS**

3.1 **Weather and seasonal limitation** : Semi dense carpet shall not be laid during rainy weather or when the base course is damp or wet.

3.2 **Preparation of base** : The base on which semi-dense carpet is to be laid shall be prepared shaped and conditioned to the specified, lines grade and cross section in accordance with MOST Specification Clause 601 as directed by the Engineer-in-charge. The surface shall be thoroughly swept and scraped clean and free of dust and foreign matter.

3.3 **Tack coat : Application of binder** : Binder shall be heated to the temperature appropriate to the grade of bitumen used and approved by the Engineer-in-charge and sprayed on the base at the rate specified hereafter. The rate of spread in terms of straight run bitumen shall be 5 kg per 10 square metre area for an existing bitumen treated surface and 10 kg per 10 per square metre area for an untreated water bound macadam surface. The binder shall be applied uniformly with the aid of sprayers. The tack coat shall be applied just ahead of the oncoming bituminous construction.

3.4 **Preparation of the mix** : Hot mix plant of adequate capacity and capable of producing a proper and uniform quality shall be used for preparing the mix. The plant should be continuous type having a co-ordinated set of essential units such as dryer for heating the aggregates, device for feeding by weight or volume the required quantities of aggregates, a binder heating and control unit for metering out the correct quantity of heated binder together with a paddle heating and control unit for metering out the correct quantity of heated binder together with a paddle mixer for intimately mixing of the binder and aggregates. For details regarding Hot mix plant the Annexure 'A' may be referred.

The temperature of binder at the time of mixing shall be in the range of 150°C - 177°C and aggregates in the range of 150°C – 163°C provided also that at no time shall the difference in temperature of the aggregates and the binder exceed 14°C.

Mixing shall be through to ensure that a homogeneous mixture is obtained in which all the particles of the mineral aggregates are coated uniformly.

The mix shall be transported from the mixing plant to the point of use in suitable vehicles. The vehicles employed for transport shall be clean and be covered over in the transit if so directed by the Engineer-in-charge.

3.5 **Spreading** : The mix, transported from the hot mix plant to the site, shall be spread by means of self propelled mechanical paver with suitable screens capable of spreading, tamping and finishing the mix, true to specified grade, line and cross sections. The temperature of mix at the time of laying shall be in the range of 121°C- 163°C.

Longitudinal joints and edges shall be constructed true to the delineating lines parallel to the centre line of the road. Longitudinal joints shall be offset by at least 150 mm from those in the binder course. All joints shall be cut vertical to the full thickness of the previously laid mix and the surface painted with hot bitumen before placing fresh material.

3.6 **Rolling** : Immediately after the spreading of mix, it shall be thoroughly compacted by rolling with a set of rollers moving at a speed not exceeding 5 km per hour. The initial or break-down rolling shall be with 8-12 tonne three wheeled rollers and the surface finished by final rolling with 8-10 tonne tandem rollers, or suitable pneumatic rollers.

The roller wheels shall be kept damp to prevent the mix adhering to them but in no case shall fuel lubricating oil be used for this purpose. Rolling shall commence longitudinally from the edge and progress towards the centre except that at super elevated portions, it shall progress from the lower to upper edges parallel to the centre line of the pavement. The roller should proceed on the fresh material with rear or fixed wheel leading so as to minimise the pushing of the mix and each pass of the roller shall uniformly overlap not less than one third of the track made in the preceding pass Rolling shall continue until the entire surface has been rolled to compaction and all the roller marks eliminated.

#### **4. OPENING TO TRAFFIC**

Traffic may be allowed immediately after completion of the final rolling when the mix has cooled down to the surrounding temperature.

#### **5. SURFACE FINISH AND QUALITY CONTROL OF WORK**

The surface finish of construction shall conform to the requirements of most specification Clause 901 Control on the quality of material and works shall be exercised by the Engineer-in-charge in accordance with MOST Specification Clause 902.

#### **6. ARRANGEMENT FOR TRAFFIC**

The provision of MOST Specification Clause 112 shall apply as regards the flow to traffic during construction.

## 7. MEASUREMENT FOR PAYMENT

The payment shall be made on the tonnage basis of the weight of mix of aggregates and bitumen. For this purpose the contractor shall have to install a weigh bridge of suitable capacity, for the purpose of weighing of dumpers at suitable place, at his cost as directed. Weight of "empty dumper and weight of loaded dumper will be recorded in bound and numbered register on plant side.

Department will be free to get some loaded dumpers test checked at other, weigh bridge. Weigh bridge will be periodically got calibrated and verified from weight and measure authorities.

For the purpose of application at tack coat if the theoretical area as per sanctioned estimate for basis of tonne differs with the actual area of work done in the field, then the reduction in or addition to payment shall have to be effected to the contractor on proportionate basis depending upon the area, reduced or exceeded respectively.

Weight of mix materials will be done in presence of Responsible person, not less than the rank of-supervisor of Department Deputy Executive Engineer or Assistant Engineer or Addl. Assistant Engineer if so authorised. Record of each dumper will be maintained separately in bound and numbered register which will be maintained by the departmental representatives and signed by the contractor, proper gate pass system shall be established for the vehicles coming to the plant site and but going from the plan site. The location of the kilometer, hectometer in which individual dumper are unloaded will -be recorded\* carefully.

## 8. RATE

The Contract unit rate for semi-dense carpet shall be payment in full for carrying out the required operations including full compensation for all components listed in MOST Specification Clause 503.8.

### ANNEXURE-A

#### TECHNICAL REQUIREMENTS OF HOT MIX PLANT

**Composition of plant :** The Hot Mix Plant shall conform generally to IS Specifications No. I S 3066/ 1965 as amended from time to time and shall be equipped with the following arrangements :-

1. **Cold Aggregate Feeder :** The cold aggregate feeder shall have minimum three independent bins or compartment, each provided with accurate mechanical pre-determined rate to the cold elevator-or to some intermediate conveyor or directly into the dryer. The feeder shall provide for the adjustment of total and proportional feed and shall be capable of being locked in any setting.
2. **Dryer :** The dryer shall be capable of continuously agitating the aggregates while heating to the desired temperature. At the discharge end of the dryer or any other -suitable location, means, shall be provided for ascertaining the temperature of the heated aggregate.
3. **Screening Unit and Gradation Control :** The dried aggregate shall be screened into not less than three size. The plant shall include means for accurately proportioning each bin size of aggregate-either by weight or volumetric measurement, When the gradation control is by volume, the unit shall include a feeder mounted under the compartment bins. Each bin shall have an accurately controlled, individual gate to form an orifice for proportioning the material drawn from each respective bin compartment. The orifice shall have positive mechanical adjustment and provided with a lock Indicators shall be provided on each gate to show the opening in centimeters.
4. **Mixer Unit :** The plant shall include a mixer of an approved twin shaft pugmill type capable of producing a uniform mix. If not enclosed, the mixer box shall be equipped with-a dust hood to prevent loss of fines.
5. **Mineral Filler Supply Unit :** There shall be an Independent arrangement to feed mineral filler directly into the pugmill. The hopper to bin for mineral filler shall provide for the adjustment to proportion the feed with the aggregate and bitumen feeds and shall be capable of being locked in any setting.
6. **Bitumen Heating :** A heating system for bitumen always with effective and positive control of temperature shall be provided, to maintain proper temperature and for allowing continuous circulation between storage tank and proportioning units during the entire operating period. Suitable arrangements shall be provided for recording the temperature at the tanks and in the circulating system.
7. **Synchronization :** For Synchronization of Aggregate, Bitumen and filler feeds satisfactory means shall be provided to afford positive inter-locking control between the flow of aggregate from the bins or compartment, flow of bitumen from the tank and flow of mineral filler.

#### ITEM - 20 40 mm Thick Asphaltic Concrete

##### 1. DESCRIPTION

The work shall consist of construction in a single course, of 40 mm thick asphaltic concrete as wearing surface, on a previously prepared base to the requirements of these specifications

**2. MATERIALS**

**2.1. Binder :** The binder shall be straight run bitumen of 60/70 or 80/100 grade satisfying the requirement of IS: 73. The actual grade of the binder to be used shall be decided by the Engineer in charge.

**2.2 Coarse aggregate :** The coarse aggregate shall consist of crushed stone or crushed gravel. These shall be clean, durable, of cubical shape, free of disintegrated pieces, organic or other deleterious matter and adherent coatings. The aggregates shall preferably be hydrophobic and of low porosity and shall satisfy the physical requirements set forth in Table given in Item No.18 Para 12.

**2.3 Fine aggregate :** The fine aggregates shall consist of crushed run screenings, natural sand or a mixture of both. These shall be clean, hard, durable, uncoated, dry and free from injurious, soft or flaky pieces and organic or deleterious substances.

**2.4 Filler :** The filler, where required, shall be an inert material the whole of which passes 600 micron sieve at least 90 percent passing 150 micron sieve and not less than 70 percent passing 75 micron sieve. The filler shall be cement, stone dust, hydrated lime, fly ash and other non – plastic mineral matter approved by the Engineer in charge.

**2.5 Aggregate gradation :** The mineral aggregates, including mineral filler, shall be so graded or combined as to conform to gradings set forth in table below :

**Table : Aggregate gradation For Asphaltic Concrete**

Sieve Designation.	% by the weight passing the sieve	Sieve Designation.	% by weight passing the Sieve.
20mm	100	600 micron	18 – 29
12.5mm	80 – 100	300 micron	13 – 23
10mm	70 – 90	150 micron	8 – 16
4.75 mm	50 – 70	75 micron	4 - 10

**2.6 Proportioning of materials :** The binder content for premixing shall be 5.5 percent by weight of the total mix.

The quantities of aggregates shall be sufficient to yield the specified thickness after compaction. The contractor shall get the job – mix formula for the mix approved by the Engineer – in – charge before starting the work.

**2.7 Variation in Proportioning of material :** The Contractor shall have the responsibility of ensuring proper proportioning of materials in accordance with the approved job mix formula and producing a uniform mix. A variation in binder content of  $\pm 0.3$  percent by weight of total mix shall, however, be permissible in individual specimen taken for quality control tests vide MOST Specification Section 900.

**3. CONSTRUCTION OPERATIONS**

**3.1 Weather and seasonal limitation :** Asphaltic Concrete shall not be laid during rainy weather or when the base course is damp or wet.

**3.2 Preparation of base :** The base on which asphaltic concrete is to be laid shall be prepared shaped and conditioned to the specified, lines grade and cross section in accordance with MOST Specification Clause 601 as directed by the Engineer in charge. The surface shall be thoroughly swept and scraped clean and free of dust and foreign matter.

**3.3 Tack coat : Application of binder :** Binder shall be heated to the temperature appropriate to the grade of bitumen used and approved by the Engineer in charge and sprayed on the base at the rate specified hereafter. The rate of spread in terms of straight run bitumen shall be 5 kg per 10 square metre area for an existing bitumen treated surface and 10 kg per 10 square metre area for an untreated water bound macadam surface. The binder shall be applied uniformly with the aid of sprayers. The tack coat shall be applied just ahead of the oncoming bituminous construction.

**3.4 Preparation of the mix :** Hot mix plant of adequate capacity and capable of producing a proper and uniform quality shall be used for preparing the mix. The plant should be continuous type having a co-ordinated set of essential units such as dryer for heating the aggregates, device for feeding by weight or volume the required quantities of aggregates, a binder heating and control unit for metering out the correct quantity of heated binder together with a paddle mixer for intimately mixing of the binder and aggregates. For details regarding Hot mix plant the Annexure 'A' may be referred.

The temperature of binder at the time of mixing shall be in the range of 150° C - 177° C and aggregates in the range of 150° C - 163° C provided also that at no time shall the difference in temperature of the aggregates and the binder exceed 14° C.



Mixing shall be through to ensure that a homogeneous mixture is obtained in which all the particles of the mineral aggregates are coated uniformly.

The mix shall be transported from the mixing plant to the point of use in suitable vehicles. The vehicles employed for transport shall be clean and be covered over in the transit if so directed by the Engineer-in-charge.

**3.5 Spreading :** The mix, transported from the hot mix plant to the site, shall be spread by means of self propelled mechanical paver with suitable screens capable of spreading, tamping and finishing the mix, true to specified grade, line and cross sections. The temperature of mix at the time of laying shall be in the range of 121°C- 163°C.

Longitudinal joints and edges shall be constructed true to the delineating lines parallel to the centre line of the road. Longitudinal joints shall be offset by at least 150 mm from those in the binder course. All joints shall be cut vertical to the full thickness of the previously laid mix and the surface painted with hot bitumen before placing fresh material.

**3.6 Rolling :** Immediately after the spreading of mix, it shall be thoroughly compacted by rolling with a set of rollers moving at a speed not exceeding 5 km per hour. The initial or break-down rolling shall be with 8-12 tonne three wheeled rollers and the surface finished by final rolling with 8-10 tonne tandem rollers, or suitable pneumatic rollers.

The roller wheels shall be kept damp to prevent the mix adhering to them but in no case shall fuel lubricating oil be used for this purpose. Rolling shall commence longitudinally from the edge and progress towards the centre except that at super elevated portions, it shall progress from the lower to upper edges parallel to the centre line of the pavement. The roller should proceed on the fresh material with rear or fixed wheel leading so as to minimise the pushing of the mix and each pass of the roller shall uniformly overlap not less than one third of the track made in the preceding pass. Rolling shall continue until the entire surface has been rolled to compaction and all the roller marks eliminated.

#### **4. OPENING TO TRAFFIC**

Traffic may be allowed immediately after completion of the final rolling when the mix has cooled down to the surrounding temperature.

#### **5. SURFACE FINISH AND QUALITY CONTROL OF WORK**

The surface finish of construction shall conform to the requirements of most specification Clause 901. Control on the quality of material and works shall be exercised by the Engineer-in-charge in accordance with MOST Specification Clause 902.

#### **6. ARRANGEMENT FOR TRAFFIC**

The provision of MOST Specification Clause 112 shall apply as regards the flow of traffic during construction.

#### **7. MEASUREMENT FOR PAYMENT**

The payment shall be made on the tonnage basis of the weight of mix of aggregates and bitumen. For this purpose the contractor shall have to install a weigh bridge of suitable capacity, for the purpose of weighing of dumpers at suitable place, at his cost as directed. Weight of empty dumper and weight of loaded dumper will be recorded in bound and numbered register on plant side.

Department will be free to get some loaded dumpers test checked at other, weigh bridge. Weigh bridge will be periodically got calibrated and verified from weight and measure authorities.

For the purpose of application at tack coat if the theoretical area as per sanctioned estimate for basis of tonne differs with the actual area of work done in the field, then the reduction in or addition to payment shall have to be effected to the contractor on proportionate basis depending upon the area, reduced or exceeded respectively.

Weight of mix materials will be done in presence of Responsible person, not less than the rank of supervisor of Department Deputy Executive Engineer or Assistant Engineer or Addl. Assistant Engineer if so authorised. Record of each dumper will be maintained separately in bound and numbered register which will be maintained by the departmental representatives and signed by the contractor, proper gate pass system shall be established for the vehicles coming to the plant site and but going from the plant site. The location of the kilometer, hectometer in which individual dumper are unloaded will be recorded\* carefully.

#### **8. RATE**

The Contract unit rate for semi-dense carpet shall be payment in full for carrying out the required operations including full compensation for all components listed in MOST Specification Clause 503.8.

**ITEM-21 Providing and laying bituminous 37.5 mm thick lean bound macadam in one or two layers considering 0.66 cum. per M.T. mix materials with machine crushed stone aggregate and asphalt for tack coat @ the rate of 10 Kg /10 sq. mt. (on metaled surface) / 5 kg per 10 sq. mt. (on existing B. T. surface) using 30 kg. of bitumen per asphalt including mixing the aggregate, heating the asphalt including mixing by continuous batching of hot mix plant and spreading the same by paver finisher and consolidation with power roller including providing at equipment's by the contractor and flushing's and at the rate of 0,30 cu.m /100 sq. mt.**

**1. DESCRIPTION**

The work shall consist of construction in one layer each 37.5 mm thick LBM 'on previously prepared base, to the requirements of these specifications.

**2. MATERIALS**

2.1 **Binder** : The binder shall be straight run bitumen of 60/70 or 80/100 grade satisfying the requirement of IS.73. The actual grade of the binder to be used shall be decided by the Engineer-in-charge and it shall have to be brought by the contractor to the site of work at his own cost.

2.2 **Coarse aggregates** : The coarse aggregate shall consist of crushed stone or crushed gravel. These shall be clean, durable, of cubical shape, free disintegrated pieces, organic or other deleterious matter and adherent coatings. The aggregates shall preferably be hydrophobic and of low porosity and shall satisfy the physical requirements set forth in Table given in Item No. 18 Para 2.

2.3 **Fine aggregates** : The fine aggregates shall consist or crusher run screenings, natural sand or a mixture of both. These shall be clean, hard, durable, uncoated, dry and free from injurious, soft of flaky pieces and organic or deleterious substances.

2.4 **Filler** : The filler, where required, shall be an inert material the whole of which passes 600 micron sieve at least 90 percent passing 150 micron sieve and not less than 70 percent passing 75 micron sieve. The filler shall be cement, stone dust, hydrated lime, fly ash and other non-plastic mineral matter approved by the Engineer-in-charge.

2.5 **Aggregate gradation** : The mineral aggregates, including mineral filler, shall be so graded or combined as to conform to gradings set forth in tables below :

**Table : Aggregate gradation For LBM**

Sieve Size	%by weight passing the Sieve		Sieve Size	%by weight passing the Sieve	
	37.5	75 m.m.		37.5	75 m.m
40mm	-	100			
25mm	100	75-100	4.75 mm	15-35	15-35
20.0 mm	70-100	60-95	2.36mm	5-20	5-20
10.0mm	35 -60	30-55	0.75 mm	0-5	0-5

The above gradation is tentative. To achieve Correct quantity the contractor shall get the job mix formula for the mix approved by Engineer-in-charge before starting the work.

2.6 **Proportioning of materials:** The binder content for premixing shall be 3.0 percent by weight of the total mix. The quantities of aggregates shall be sufficient to yield the specified thickness after compaction The contractor shall get the job-mix formula for the mix approved by the Engineer-in-charge before starting the work Variation in Proportioning of material: The Contractor shall have the responsibility of ensuring proper proportioning of materials in accordance with the approved job mix formula and producing a uniform mix. A variation in binder content of ± 0.3 percent by weight of total mix shall, however, be permissible in Individual specimen taken for quality control tests vide MOST Specification Section 900.

**3. CONSTRUCTION OPERATIONS**

3.1 **Weather and seasonal limitation:** Lean bound Macadam shall not be laid during rainy weather or when the base course is damp or wet.

3.2 **Preparation of base:** The base on which LBM is to be laid shall be prepared shaped and conditioned to the specified, lines, grade and cross section in accordance with MOST Specification Clause 601 as directed by the Engineer-in-charge. The surface shall be thoroughly swept and scraped clean and free of dust and foreign matter

3.3 **Tack coat:** Application of binder: Binder shall be heated to the temperature appropriate to the grade of bitumen used and approved by the Engineer-in-charge and sprayed on the base at the rate specified hereafter. The rate of spread in terms of straight run bitumen shall be 5 kg per 10 square metre area for an existing bitumen treated surface and 10 kg per 10 square metre area for an untreated water bound macadam surface. The binder shall be applied uniformly with the aid of sprayers. At specified temperature, so as to provide uniformly rate and unbroken spread bitumen. The tack coat shall be applied just ahead of the oncoming bituminous construction.

3.4 Preparation of the mix: Hot mix plant of adequate capacity and capable of producing a proper and

uniform quality shall be used for preparing the mix. The plant should be continuous type having a co-ordinated set of essential units such as dryer for heating the aggregates, device-for feeding by weight or volume the required quantities of aggregates, a binder heating and control unit for metering out the correct quantity of heated binder together with a paddle mixer for intimately mixing of the binder and aggregates. For details regarding Hot mix plant the Annexure 'A' may be referred.

The temperature of binder at the time of mixing shall be in the range of 150 C - 177° C and aggregates in the range of 150 C - 163° C provided also that at no time shall the difference in temperature of the aggregates and the binder exceed 14 C.

Mixing shall be throughout to ensure that a homogeneous mixture is obtained in which all the particles of the mineral aggregates are coated uniformly.

The mix shall be transported from the mixing plant to the point of use in suitable vehicles. The vehicles employed for transport shall be clean and be covered over in the transit if so directed by the Engineer-in-charge

**3.5 Spreading :** The mix, transported from the hot mix plant to the site, shall be spread by means of self propelled mechanical paver with suitable screens capable of spreading, tamping and finishing the mix, true to specified grade, line and cross sections. The temperature of mix at the time of laying, shall be in the range of 121 C-163° C.

Longitudinal joints and edges shall be constructed true to the delineating lines parallel to the centre line of the road, Longitudinal joints shall be offset by at least 150 mm from those, in the binder course. All joints shall be cut vertical to the full thickness of the previously laid mix and the surface painted with hot bitumen before placing fresh material.

**3.6 Rolling :** Immediately after the spreading of mix, it shall be thoroughly compacted by rolling with a set of rollers moving at a speed not exceeding 5 km per hour. The initial or break down rolling shall be with 8-12 tonne three wheeled rollers and the surface finished by final rolling with 8-10 tonne tandem rollers, or suitable pneumatic rollers.

The roller wheels shall be kept damp to prevent the mix adhering to them but in no case shall fuel lubricating oil be used for this purpose. Rolling shall commence longitudinally from the edge and progress towards the centre except that at super elevated portions, it shall progress from the lower to upper edges parallel to the centre line of the payment. The roller should proceed on the fresh material with rear or fixed wheel leading so as to minimise the pushing of the mix and each pass of the roller shall uniformly overlap not less than one third of the track made in the preceding pass Rolling shall continue until the entire surface has been rolled to compaction and all the roller marks eliminated

#### **4. OPENING TO TRAFFIC**

Traffic may be allowed immediately after completion of the final rolling when the mix has cooled down to the surrounding temperature.

#### **5. SURFACE FINISH AND QUALITY CONTROL OF WORK**

The surface finish of construction shall conform to the requirements of most specification Clause 901 Control on the quality of material and works shall be exercised by the Engineer-in-charge in accordance with MOST Specification Clause 902.

#### **6. ARRANGEMENT FOR TRAFFIC**

The provision of MOST Specification Clause 105 shall apply as regards the flow to traffic during construction.

#### **7. MEASUREMENT FOR PAYMENT**

The payment shall be made on the tonnage basis of the weight of mix of aggregates and bitumen for this purpose the contractor shall have to install a weigh bridge of suitable capacity for the purpose of weightment of dumpers at suitable place at his cost as directed; Weight of empty dumper and weight of loaded dumper will be recorded in bound and numbered register on plant side.

Department will be free to get some loaded dumper test checked at other weigh bridge. Weigh bridge will be periodically got calibrated and verified from weight and measure authorities.

For the purpose of application of tack coat if the theoretical area as per sanctioned estimate for basis of tonne differs with the actual area of work done in the field, then the reduction in or addition to payment shall have to be effected to the contractor on proportionate basis depending upon the area reduced or exceeded respectively.

Weight of mix materials will be done in presence of responsible person, not less than the rank of supervisor of Department Deputy Executive Engineer or Assistant Engineer or Addl. Assistant Engineer if so authorised. Record of each dumper will be maintained separately in bound and numbered register which will be maintained by the departmental representatives and, signed by the contractor. Proper gate pass system shall be established for the vehicles coming to the plant Site and out going from the plant site. The location of the kilometre, hectometre in which individual dumper are unloaded will be recorded carefully.



7.2 In case of LBM, DBM and asphaltic concrete of thickness 50 mm and above, initial levels before commencement of the work and final levels after completion of the work will be taken as indicated below for working out the average thickness of pavement laid, also the actual area of work done will be measured and the quantity of the work actually done shall be computed in Cu. M. basis. The article tonnage of the mix shall then be worked out based on the designed density, for broad cross check on the actual tonnage of total mix used in the works.

Surface levels before and after laying the pavement course shall be taken as below:

Cross profiles will be taken at least at every ten meters longitudinally as shown below :

(a) For single Lane : Levels at 15 Cms & 75 from both the edges and centre point.

(Levels at 5 points)

(b) For double Lane: Levels at 15 Cms & 75 cms : 175 Cms. 275 Cms. from both the edges and the centre point. (Levels at 9 Points)

(c) Widening single to double lane : Levels at 15 Cms. from both the edges and the centre Carriage way (Up to 2 meters widening) point (levels at 3 Points)

However, in special cases if necessary, the cross profiles may be taken at closer length up to 3 meters.

8. RATE

The contract unit rate for LBM shall be for payment in full for carrying out the required operations including full compensation for all components listed in MOST Specification Clause 503.8.

**ITEM 22 DBM 50MM THICK.**

**1. DESCRIPTION**

The work shall consist of construction in a single course of 50 mm thick DBM on previously prepared base, to the requirements of these specifications.

**2. MATERIALS**

**2.1 Binder :** The binder shall be straight run bitumen of 60/70 or 80/100 grade satisfying the requirement of IS.73. The actual grade of the binder to be used shall be decided by the Engineer-in-charge.

**2.2 Coarse aggregates :** The coarse aggregate shall consist of crushed stone or crushed gravel. These shall be clean, durable, of cubical shape, free disintegrated pieces, organic or other deleterious matter and adherent coatings. The aggregates shall preferably be hydrophobic and of low porosity and shall satisfy the physical requirements set forth in Table given in Item No. 18 Para 2.

**2.3 Fine aggregates :** The fine aggregates shall consist of crusher run screenings, natural sand or a mixture of both. These shall be clean, hard, durable, uncoated, dry and free from injurious, soft or flaky pieces and organic or deleterious substances.

**2.4 Filler :** The filler, where required, shall be an inert material the whole of which passes 600 micron sieve at least 90 percent passing 150 micron sieve and not less than 70 percent passing 75 micron sieve. The filler shall be cement, stone dust, hydrated lime, fly ash and other non-plastic mineral matter approved by the Engineer-in-charge.

**2.5 Aggregate gradation :** The mineral aggregates, including mineral filler, shall be so graded or combined as to conform to gradings set forth in tables below :

**Table : Aggregate gradation For LBM**

Sieve Size	%by weight passing the Sieve	Sieve Size	%by weight passing the Sieve
25mm	100	10mm	35-60
20mm	70 – 100	4.75mm	15-35
12.5mm	55 – 80	2.60mm	5-20
		0.75mm	0-5

**2.6. Proportioning of materials :** The binder content for premixing shall be 3.0 percent by weight of the total mix.

The quantities of aggregates shall be sufficient to yield the specified thickness after compaction.

The contractor shall get the job-mix formula for the mix approved by the Engineer-in-charge before starting the work.

**2.7. Variation in Proportioning of material :** The Contractor shall have the responsibility of ensuring proper proportioning of materials in accordance with the approved job mix formula and producing a uniform mix. A variation in binder content of  $\pm 0.3$  percent by weight of total mix shall, however, be permissible in Individual specimen taken for quality control tests vide MOST Specification Section 900.

### **3. CONSTRUCTION OPERATIONS**

**3.1 Weather and seasonal limitation:** DBM shall not be laid during rainy weather or when the base course is damp or wet.

**3.2 Preparation of base:** The base on which DBM is to be laid shall be prepared, shaped and conditioned to the specified, lines, grade and cross section in accordance with MOST Specification Clause 601 as directed by the Engineer-in-charge. The surface shall be thoroughly swept and scraped clean and free of dust and foreign matter.

**3.3 Tack coat :** Application of binder : Binder shall be heated to the temperature appropriate to the grade of bitumen used and approved by the Engineer-in-charge and sprayed on the base at the rate specified hereafter. The rate of spread in terms of straight run bitumen shall be 5 kg per 10 square metre area for an existing bitumen treated surface and 10 kg per 10 square metre area for an untreated water bound macadam surface. The binder shall be applied uniformly with the aid of sprayers. At specified temperature, so as to provide uniform rate and unbroken spread bitumen. The tack coat shall be applied just ahead of the oncoming bituminous construction.

**3.4 Preparation of the mix:** Hot mix plant of adequate capacity and capable of producing a proper and uniform quality shall be used for preparing the mix. The plant should be continuous type having a co-ordinated set of essential units such as dryer for heating the aggregates, device for feeding by weight or volume the required quantities of aggregates, a binder heating and control unit for metering out the correct quantity of heated binder together with a paddle mixer for intimately mixing of the binder and aggregates. For details regarding Hot mix plant the Annexure 'A' may be referred.

The temperature of binder at the time of mixing shall be in the range of 150°C - 177°C and aggregates in the range of 150°C - 163°C provided also that at no time shall the difference in temperature of the aggregates and the binder exceed 14°C.

Mixing shall be throughout to ensure that a homogeneous mixture is obtained in which all the particles of the mineral aggregates are coated uniformly.

The mix shall be transported from the mixing plant to the point of use in suitable vehicles. The vehicles employed for transport shall be clean and be covered over in the transit if so directed by the Engineer-in-charge.

**3.5 Spreading:** The mix, transported from the hot mix plant to the site, shall be spread by means of self-propelled mechanical paver with suitable screens capable of spreading, tamping and finishing the mix, true to specified grade, line and cross sections. The temperature of mix at the time of laying, shall be in the range of 121°C-163°C.

Longitudinal joints and edges shall be constructed true to the delineating lines parallel to the centre line of the road, Longitudinal joints shall be offset by at least 150 mm from those, in the binder course. All joints shall be cut vertical to the full thickness of the previously laid mix and the surface painted with hot bitumen before placing fresh material.

**3.6 Rolling:** Immediately after the spreading of mix, it shall be thoroughly compacted by rolling with a set of rollers moving at a speed not exceeding 5 km per hour. The initial or break down rolling shall be with 8-12 tonne three wheeled rollers and the surface finished by final rolling with 8-10 tonne tandem rollers, or suitable pneumatic rollers.

The roller wheels shall be kept damp to prevent the mix adhering to them but in no case shall fuel lubricating oil be used for this purpose. Rolling shall commence longitudinally from the edge and progress towards the centre except that at super elevated portions, it shall progress from the lower to upper edges parallel to the centre line of the pavement. The roller should proceed on the fresh material with rear or fixed wheel leading so as to minimise the pushing of the mix and each pass of the roller shall uniformly overlap not less than one third of the track made in the preceding pass. Rolling shall continue until the entire surface has been rolled to compaction and all the roller marks eliminated.

### **4. OPENING TO TRAFFIC**

Traffic may be allowed immediately after completion of the final rolling when the mix has cooled down to the surrounding temperature.

### **5. SURFACE FINISH AND QUALITY CONTROL OF WORK**

The surface finish of construction shall conform to the requirements of most specification Clause 901. Control on the quality of material and works shall be exercised by the Engineer-in-charge in accordance with MOST Specification Clause 902.

### **6. ARRANGEMENT FOR TRAFFIC**

The provision of MOST Specification Clause 105 shall apply as regards the flow to traffic during construction.

### **7. MEASUREMENT FOR PAYMENT**

The payment shall be made on the tonnage basis of the weight of mix of aggregates and bitumen For

this purpose the contractor shall have to install a weigh bridge of suitable capacity for the purpose of weighing of dumpers at suitable place at his cost as directed; Weight of empty dumper and weight of loaded dumper will be recorded in bound and numbered register on plant side.

Department will be free to get some loaded dumper test checked at other weigh bridge. Weigh bridge will be periodically got calibrated and verified from weight and measure authorities.

For the purpose of application of tack coat if the theoretical area as per sanctioned estimate for basis of tonne differs with the actual area of work done in the field, then the reduction in or addition to payment shall have to be affected to the contractor on proportionate basis depending upon the area reduced or exceeded respectively.

Weight of mix materials will be done in presence of responsible person, not less than the rank of supervisor of Department Deputy Executive Engineer or Assistant Engineer or Addl. Assistant Engineer if so authorised. Record of each dumper will be maintained separately in bound and numbered register which will be maintained by the departmental representatives and, signed by the contractor. Proper gate pass system shall be established for the vehicles coming to the plant Site and out going from the plant site. The location of the kilometer, hectometer in which individual dumper are unloaded will be recorded carefully.

7.2 In case of LBM, DBM and asphaltic concrete of thickness 50 mm and above, initial levels before commencement of the work and final levels after completion of the work will be taken as indicated below for working out the average thickness of pavement laid, also the actual area of work done will be measured and the quantity of the work actually done shall be computed in Cu. M. basis. The article tonnage of the mix shall then be worked out based on the designed density, for broad cross check on the actual tonnage of total mix used in the works.

Surface levels before and after laying the pavement course shall be taken as below:

Cross profiles will be taken at least at every ten meters longitudinally as shown below :

- (a) For single Lane: Levels at 15 Cms & 75 from both the edges and centre point. (Levels at 5 points)
- (b) For double Lane: Levels at 15 Cms & 75 cms : 175 Cms. 275 Cms. from both the edges and the centre point. (Levels at 9 Points)
- (c) Widening single to double lane: Levels at 15 Cms. from both the edges and the centre Carriage way (Up to 2 meters widening) point (levels at 3 Points)

However, in special cases, if necessary, the cross profiles may be taken at closer length upto 3 meters.

## **8. RATE**

The contract unit rate for DBM shall be for payment in full for carrying out the required operations including full compensation for all components listed in MOST Specification Clause 503.8.

**ITEM-23 Providing and laying seal coat with 0.18 cum stone chips i.e. 0.2727 M. T. per 10 sq. nit. using 42.50 kgs of bitumen per M.T. (4.25% by weight) for mixing the aggregates, heating the asphalt including mixing by continuous batching of hot mix plant and spreading the same by paver finisher and consolidation with power roller including providing all equipments by the contractor and flushing sand at the rate of 0.30 cu. m /100 sq. mt.**

### **1 DESCRIPTION**

The work shall consist of construction of premix seal coat as wearing course, on a previously prepared base, to the requirement of these specification.

### **2. MATERIALS**

2.1 **Binder:** The binder shall be straight run bitumen of 60/70 or 80/100 grade satisfying the requirement of IS:73. The actual grade of the binder to be used shall be decided by the Engineer-in-charge and it shall have to be brought by contractor to the site at his own cost unless otherwise specified in schedule 'A'.

2.2 **Coarse aggregates:** The coarse aggregate shall consist of crushed stone or crushed gravel. These shall be clean, durable, of cubical shape, free disintegrated pieces, organic or other deleterious matter and adherent coatings. The aggregates shall preferably be hydrophobic and of low porosity and shall satisfy the physical requirements set forth in Table given in Item No. 18 Para 2. Except that the upper limit for water absorption value shall be one percent.

2.3 **Fine aggregates;** The fine aggregates shall consist of crusher run screenings, natural sand or a mixture of both. These shall be clean, hard, durable, uncoated, dry and free from injurious, soft of flaky pieces and organic or deleterious substances.

2-4 **Filter:** The filler, where required, shall be an inert material the whole of which passes 600 micron sieve at least 90 percent passing 150 micron sieve and not less than 70 percent passing 75 micron sieve. The filler shall be cement, stone dust, hydrated lime, fly ash and other non-plastic mineral matter approved by the Engineer-in-charge.

2.5 **Aggregate gradation:** The mineral aggregates, including mineral filler, shall be so graded or combined as to conform to gradings set forth in tables below:

**Table : Aggregate gradation Pre-Mix Seal Coat**

Sieve Designation	Percentage by wt passing through Sieve	
	For type 'A'	For Type 'g.'
12.5 mm		100 70-
10 mm	100	100 20-
4.75 mm	40-85	40
2.35	5-20	5-20
75micron	0-4	0-4

**2.6 Proportioning of materials :** The binder content for premixing shall be 42.50 kg per M.T. (4.25% by weight) for mixing aggregate.

The quantities of aggregates shall be sufficient to yield the specified thickness after compaction. The contractor, shall get the job-mix formula for the mix approved by the Engineer-in-charge before starting the work.

**2.7 Variation in Proportioning of material :** The Contractor shall have the responsibility of ensuring proper proportioning of materials in accordance with the approved job mix formula and producing a uniform mix. A variation in binder content of  $\pm 0.3$  percent by weight of total mix shall, however, be permissible in individual specimen taken for quality control tests vide MOST Specification Section 900.

### 3. CONSTRUCTION OPERATIONS

**3.1 Weather and seasonal limitation :** Premix seal coat shall not be laid during rainy weather or when the base course is damp or wet.

**3.2 Preparation of base :** The base on which premix seal coat is to be laid shall be prepared shaped and conditioned to the specified, lines, grade and cross section in accordance with MOST Specification Clause 601 as directed by the Engineer-in-charge. The surface shall be thoroughly swept" and scraped clean and free of dust and foreign matter.

**3.3 Tack coat :** Application of binder : Binder shall be heated to the temperature appropriate to the grade of bitumen used and approved by the Engineer-in-charge and sprayed on the base at the rate specified hereafter. The rate of spread in terms of straight run bitumen shall be 5 kg per 10 square metre area for an existing bitumen treated surface and 10 kg per 10 square metre area for an untreated water bound macadam surface. The binder shall be applied uniformly with the aid of sprayers. The tack coat shall be applied just ahead of the oncoming bituminous construction.

**3.4 Preparation of the mix :** Hot mix plant of adequate capacity and capable of producing a proper and uniform quality shall be used for preparing the mix. The plant should be continuous type having a co-ordinated set of essential units such as dryer for heating the aggregates, device for feeding by weight or volume the required quantities of aggregates, a binder heating and control unit for metering out the correct quantity of heated binder together with a paddle mixer for intimately mixing of the binder and aggregates. For details regarding Hot mix plant the Annexure 'A' may be referred.

The temperature of-binder at the time of mixing shall be in the range of 150°C - 177°C and aggregates in the range of 150°C -163°C provided also that at no time shall the difference in temperature of the aggregates and the binder exceed 14°C.

Mixing shall be throughout to ensure that a homogeneous mixture is obtained in which all the particles of the mineral aggregates are coated uniformly.

The mix shall be transported from the mixing plant to the point of use in suitable vehicles. The vehicles employed for transport shall be clean and be covered over in the transit if so directed by the Engineer-in-charge.

**3.5 Spreading :** The mix, transported from the hot mix plant to the site, shall be spread by means of self propelled mechanical paver with suitable screens capable of spreading, tamping and finishing the mix, true to specified grade, line and cross sections. The temperature of mix at the time of laying shall be in the range of 121°C -163°C.

Longitudinal joints and edges shall be constructed true to the delineating lines parallel to the centre line of the road, Longitudinal joints shall be offset by at least 150 mm from those in the binder course. All joints shall be cut vertical to the full thickness of the previously laid mix and the surface painted with hot bitumen before placing fresh material.

**3.6 Rolling :** Immediately after the spreading of mix, it shall be thoroughly compacted by rolling with a set of rollers moving at a speed not exceeding 5 km per hour. The initial or break-down rolling shall be with 8-12 tonne three wheeled rollers and the surface finished by final rolling with 8-10 tonne tandem rollers, or suitable pneumatic rollers. Rolling temperature shall not be-less than 100°C in any case the rolling shall be completed the temperature of mix falls about 80 °C.

The roller wheels shall be kept damp to prevent the mix adhering to them but in no case shall fuel lubricating oil be used for this purpose. Rolling shall commence longitudinally from the edge and progress towards the centre except that at super elevated portions, it shall progress from the lower to upper edges parallel to the centre line of the pavement. The roller stipuld proceed on the fresh material with rear or fixed wheel leading so as to minimise the pushing of the mix and each pass of the roller shall uniformly overlap not less than one third of the track made in the preceding pass Rolling shall continue until the entire surface has been rolled to compaction and all the roller marks eliminated.

**4. OPENING TO TRAFFIC**

Traffic may be allowed immediately after completion of the final rolling when the mix has cooled down to the surrounding temperature.

**5. SURFACE FINISH AND QUALITY CONTROL OF WORK**

The surface finish of construction shall conform to the requirements of most specification Clause 901. Control on the quality of material and works shall be exercised by the Engineer-in-charge in accordance with MOST Specification Clause 902.

**6. ARRANGEMENT FOR TRAFFIC**

The provision of MOST Specification Clause 105 shall apply as regards the flow to traffic during construction.

**7. MEASUREMENT FOR PAYMENT**

The payment shall be made on the tonnage basis of the weight of mix of aggregates and bitumen. For this purpose the contractor shall have to install a weigh bridge of suitable capacity for the purpose of weighing of dumpers at suitable place at his cost as directed. Weight of empty dumper and weight of loaded dumper will be recorded in bound and numbered register on plant side.

Department will be free to get some loaded dumper test checked at other weigh bridge. Weigh bridge will be periodically got calibrated and verified from weight and measure authorities.

For the purpose of application of tack coat if the theoretical area as per sanctioned estimate for basis of tonne differs with the actual area of work done in the field, then the reduction in or addition to payment shall have to be effected to the contractor on proportionate basis depending upon the area reduced or exceeded respectively.

Weigh of mix materials will be done in presence of responsible person, not less than the rank of supervisor of Department, Deputy Executive Engineer or Assistant Engineer or Addl. Assistant Engineer if so authorised. Record of each dumper will be maintained separately in bound and numbered register which will be maintained by the departmental representatives and signed by the contractor. Proper gate pass system shall be established for the vehicles coming to the plant site and out going from the plant site. The location of the kilometer, hectometer in which individual dumper are unloaded will be recorded carefully.

**8. RATE**

The Contract unit rate for seal coat shall be for payment for carrying out the required operations including full compensation for all components listed in MOST Specification Clause 503.7

**ITEM - 24 Special Conditions for Bituminous surface work with use of Hot Mix Plant paver Finisher.**

1. The Hot Mix Plant and accessories to be used for the work shall be in conformity with the specifications prescribed vide Govt. of India, Ministry of Transport Circular No. RQ/RMP/1613784 dt.1-1-87 The plant shall be equipped with all units and accessories as per latest I.S. 3066/1965, as amended from time to time. The Contractor will have to modify their plants suitably within a period of six months from the date of issue of latest I.S. Specification or Codes.

2. The work of laying aggregate mixed with bitumen shall start on site of work only after 8.00 hours in the morning and continue upto 17.00 hours in winter season and upto 18.30 hours in summer. No work shall be done except during the period mentioned above and also on Sundays and National holidays viz. 26th January, 15th August & 2nd October.

3. Quantity of bituminous aggregate mix to be laid shall be restricted to 250 tones per day for 30/40 capacity plant and may be more\* or less depending upon the rated capacity of the plant.

4. The work of laying asphalt mix shall start latest within 60 days from the date of issue of work order except when work is closed for few days due to breakdown of machinery and during such period the contractor has not shifted paver plant to any other paver work not carried out by the same plant and will be completed as per time limit. Reasons for delay in starting of work after 60 days shall result into sufficient cause for levying compensation for disproportionate progress. However, the period from 15th June to 15th October monsoon shall not be counted for the purpose of disproportionate progress and consequent cause for levy of compensation. The contractors shall commence the work of laying pavement on or before the last date of the period mentioned above failing which he shall pay for every day that he shall delay the commencement of the work as above in accordance with clause-2 of the contract.



કોન્ટ્રાક્ટર ૬૦ દિવસની અંદર કામ શરૂ કર્યા પછી થોડુંક કામ કરીને નીચે દર્શાવેલ સંજોગો સિવાય કામ અધૂરું મુકશે તો જે દિવસ થી કામ અધૂરું મુકશે તેજ દિવસ થી કામ શરૂ કરે ત્યાં સુધી દરરોજ ના રૂ. ૫૦૦ /- લેખે વળતર વસૂલ કરવામાં આવશે.

૧. મશીનરી બ્રેક ડાઉન થયેલ હોય અને તેટલા જજ સમય પૂરતું કામ બંધ કરેલ હોય.
૨. મશીનરી બ્રેક ડાઉન સમય દરમ્યાન પેવર પ્લાન્ટ પણ ત્યાંથી ખસેડવામાં આવેલ ન હોય અથવા જે પ્લાન્ટ પેવર થી અન્ય જગ્યાએ કામગીરી કરવામાં આવેલ ન હોય.

5. The Contractor shall invariably get the job mix formula for the mix approved by the Engineer-in-charge before starting the work.

6. These special conditions shall be applicable to the specifications of all the items included in this contractor where work is to be carried out with Hot Mix Plant and paver finisher.

7. No asphalt work shall be executed in monsoon as per condition 4 of same Item 24. However in critical circumstances asphalt work may be executed during monsoon with permission of Superintending Engineer who may give permission after ascertaining the proportion of moisture in existing surface & atmosphere (R & B D. G R. dated 24-10-94 & No. S.S.R.-102004 (23)-C dated 23-6-2004).

**SCHEDULE OF WORK TO BE EXECUTED SHALL BE AS UNDER**

Time Limit:-

Sr.No.	Period	Description of items to be executed
1	Month.....Month	1. Collection of Materials on site
2	From Month 2 to 4 Month	2. Erection of Plant Machinery as required
3	From Month....to...Month	3. Laying of asphalt work carpet & Seal coat & Flushing of sand over surface, side with filling with earth as required-and directed

**ITEM-25 Dismantling [Road and bridge items]**

1. The work shall consist of removing, as herein after set forth, existing, culverts, bridges, pavement, kerbs and other structures like guards-rails, fences, utility poles, manholes, catch basins, inlets, etc Which are in place but interfere with the new construction or are not suitable to remain in place and of salvaging and disposing of the resulting materials and back filling the resulting trenches and pits.

2. Existing culverts, bridge, pavements and other structures which are within the highway and which are designated to be removed, shall be removed upto the limits and extent specified in the drawings or as indicated by the Engineer-in-charge.

3. Dismantling and removal operations shall be carried out with such equipment and in such a manner as to leave undisturbed, adjacent pavement, structures and other work to be left in tact.

4. All operations necessary for the removal of any existing structure which might endanger new construction shall be completed prior to the start of new work.

5. The structures shall be dismantled carefully and the resulting materials so removed as not to cause and damage to the serviceable materials to be salvaged, the part of the structure to be retained and any other properties or structures nearby.

6. Unless otherwise specified, the superstructure portion of culverts/bridges shall be entirely removed and other parts removed to below the ground level or as necessary depending upon the interference they cause to the new construction. Removal of overlying of adjacent material if required in connection with the dismantling of the structures shall be incidental to this item.

7. Where existing culverts/bridges are to be extended or otherwise incorporated in the new Work only such part of parts of the existing structure shall be removed as are necessary to provide a proper connection to the new work. The connecting edges shall be cut, chipped and trimmed to the required lines and grades without weakening or damaging any part of the structure to be retained. Reinforcing bars which are to be left in place so as to project into new work as dowels or ties shall not be injured during removal of concrete.

8. Pipe culverts shall be carefully removed in such a manner as to avoid damage to the pipes.

9. Steel structures shall unless otherwise provided be 'carefully dismantled in such a manner as to avoid damage to members thereof/If specified-in the drawing or directed-by the Engineer-in-charge that structure is to be removed in a condition suitable for re-erection all-members shall be match marked by the contractor with white lead paint before dismantling. End pins, nuts, loose, plates, etc. shall be painted with a mixture of white lead and tallow and loose parts shall be securely wired to adjacent members or packed in boxes.

10. Timber structures shall be removed in such a manner as to avoid damages to such timber or lumber as is designated by the Engineer-in-charge to be salvaged.

11. In removing pavements, kerbs, gutters, and other structure, like guards rails, fences, manholes, catch, basins, inlets etc. where portions of the existing construction are to be left in the finished work, the same, shall be

removed to an existing joint or cut and chipped to a true line with a face perpendicular to the surface of the existing structure. Sufficient removal shall be made to provide for proper grades and connections with the new work as directed by the Engineer-in-charge.

12. All concrete pavements base course in carriage way and shoulders etc. designated for removal shall be broken to pieces whose volumes shall not be exceed 0.02. cubic metre and stockpiled at designated locations if the material is to be used later or otherwise arranged for disposal as directed,

13. Where directed by the Engineer-in-charge holes and depressions caused by, dismantling operations shall be back filled with excavated or other approved materials and thoroughly compacted in line with surrounding area.

14. All materials obtained by dismantling shall be the property of Government. Unless otherwise specified, materials having any salvage value shall be placed in neat stack of like material within the right-of-way as directed by, the Engineer-in-charge, for which contractor will remain responsible for its safe custody and preservation for 60 days after recording measurements of the salvaged material.

15. Pipe culverts that are removed shall be cleared and neatly piled on the right-of-way at points designated by the Engineer-in-charge.

16. Structural steel removed from old structure shall, unless otherwise specified or directed be stored in a neat and presentable manner on blocking in locations suitable for loading. Structures or portions thereof which are specified in the contract for re-erections shall be stored in separate piles.

17. Timber or lumber from old structures which is designated by the Engineer-in-charge as materials to be salvaged shall have all nuts and bolts removed from and shall be stored in neat piles in locations suitable for loading.

18. All the products of dismantling operations which in the opinion of the Engineer-in-charge cannot be used or auctioned shall be disposed as directed, within 100 metres.

19. The work of dismantling structure shall be paid for in units indicated below by taking measurement before and after, as applicable ;

(i) Dismantling brick stone/concrete (Plain and Reinforced) masonry	Cubic Metre
(ii) Dismantling flexible and cement concrete pavement	Cubic Metre
(iii) Dismantling steel structure	Tonne
(iv) Dismantling timber structure.	Cubic Metre
(v) Dismantling pipes, guard rails, kerbs gutters and fencing	Linear metre
(vi) Utility poles	Nos.

20. The contract unit rates for the various items of dismantling shall be for payment in full for carrying out the required operations including full compensation for all labour, materials, tools equipment, safeguard and incidentals necessary to complete the work. These will also include excavation and back filling where necessary and for handling, salvaging, piling and disposing of the dismantled material within all lifts and upto a lead of 100 metres.

**ITEM-26 Excavation for foundation up to 1.5 m depth including sorting out and stacking of useful material and disposing stuff 50 metre lead. (A) in loose or soft soil (B) in dense or hard soil.**

1. Excavation for structures shall consist of the removal of material for the construction of foundations for culverts, retaining walls, cut of walls pipe culverts and other similar structures, in accordance with the requirements of these specifications and the lines and dimensions shown on the drawing or as indicated by the Engineer-in-charge The work shall include all necessary sheeting, shoring, bracing draining and pumping and the removal of all logs, stumps, grubs and other deleterious matter and obstructions necessary for placing the foundations, trimming bottoms of excavations, back filling and clearing up the site and the disposal of all surplus material.

2. After the site has been cleared the limits of excavation shall be set out true to lines, curves and slopes.

3. Excavation shall be taken to the width of the lowest step of the footing. The contractor at his own expense shall put up necessary shoring, strutting and planking or cut slopes to a safer angle or both with due regard to the safety of persons and works and to the satisfaction of the Engineer-in-charge.

4. The depth to which the excavation is to be carried out shall be as shown, on the drawings, unless the type of material encountered is such as to require changes, in which case the depth shall be as ordered by the Engineer-in-charge.

5. Where waters is met with in excavation due to stream-flow, seepage springs, rain or other reasons, the contractor shall take adequate measures such as bailing, pumping, constructing diversion channels drainage channels, and other necessary work to keep the foundation trenches dry when so required and to protect green

concrete/masonry against damage by erosion or sudden rising of water level. The method to be accepted in this regard and other details there of shall be left to the choice of (he contractor but subject to approval of the Engineer-in charge, Approval of the Engineer-in-charge shall, however, not relieve the contractor of the responsibility for the adequacy of dewatering. and protection arrangements and for the quality and safety of the work.

6. Pumping from the interior of any foundation enclosures shall be done in such manner as to preclude the possibility of the movement of water through any fresh concrete. No pumping shall be permitted during the placing of concrete or for any period of at least 24 hours thereafter unless it is done from a suitable sump separated from the concrete work by a water tight wall or other similar means.

7. The bottom of the foundation shall be leveled both longitudinally and transversely or stepped as directed by the Engineer-in-charge. Before tooling is laid, the surface shall be slightly watered and rammed. In the event of excavation having been made deeper than that shown on the drawings or as otherwise ordered by the Engineer-in-charge, the extra depth shall be made up with concrete or masonry of the foundation grade at (he cost of the contractor Ordinary filling shall not be used for the purpose of bringing the foundation to level. If there are any slips or blows in the excavation these shall be removed by the contractor at his own cost.

8- Near towns, villages and all frequented places, trenches and foundation pits shall be securely fenced, provided with proper caution signs and marked with red lights at night to avoid accidents. The contractor shall be required to take adequate protective measures to see that the excavation operations do not affect or damage adjoining structures.

9. Back filling shall be done with approved material after concrete or masonry is fully set and carried out in such a way as not to cause under thrust on any part of the structure. All space between foundation masonry or concrete and the sides of excavation shall be refilled to the original surface, making due allowance for settlement in 250 mm loose layers. Which shall be watered and compacted.

10. All the excavated materials shall be the property of the Government. Where the excavated material is directed to be used in the construction of embankment, it shall be directly deposited at the required locations.

11. All useful materials, not intended for use in the bank, shall be stacked neatly on Government land as directed by the Engineer-in-charge within 50 metres lead. Unsuitable and surplus materials not intended for use in any part of the road shall be disposed off as directed by the Engineer-in-charge.

12. Excavation for structures shall be measured in cubic metres for each class of material encountered, limited to the dimensions shown on the drawings or as directed by the Engineer-in-charge. Excavation over increased width, cutting of slopes, shoring, shattering and planking shall be deemed as convenience for the Contractor in executing the work and shall not be measured and paid for separately.

13. The contract unit rate for the items of excavation for structures shall be paid in full for carrying out the required operations including.

1. Setting out
2. Construction of necessary shoring and bracing and their subsequent removal:
3. Removal of ail logs stumps, grubs and other deleterious matter and obstructions for placing the foundations including trimming of bottoms of excavations;
4. Foundation sealing, dewatering including pumping;
5. Backfilling, clearing up the site and disposal of all surplus material within all lifts and leads upto 100 metres;
6. All labour, materials, tools, equipment, safeguards and incidentals necessary to complete the work to the specification.

14. Excavation shall be for ordinary soil such as vegetable or organic soil, turf slit, and loam, clay, mud, plat, black cotton soil, soft shale or soft murrum a mixture of these and similar material which yields to the ordinary application of pick and shovel, rake or other ordinary digging equipment. Removal of g<sub>1</sub>avei or any other nodular material having diametre in any one direction not exceeding 75 mm occurring in such strata shall be deemed to be covered under this category. The classification of excavation shall be decided by the Engineer-in-charge and his decision shall be final and binding on the Contractor.

**ITEM - 27 -DO- in hard murrum**

1.0 Para 1 to 13 of the item of excavation for foundation in all softs of soil shall apply.

14. Excavation shall be in hard soil such as stiff heavy clay, hard shale or compact murrum requiring grafting tool or pick or both and shovel. Closely applied and gravel and rubble stone having maximum diametre in any one direction between 75 and 300 mm and soft conglomerate. The classification of excavation shall be decided by the Engineer in-charge and his decision shall be final and binding on the Contractor

**ITEM - 28 - DO - in hard rock**

1. Para 1 to 13 of the item of excavation for foundation is all sorts of soil shall apply.



14. Excavation shall be in soft rock such as limestone, sand stone, laterite, hard conglomerate or other softer disintegrated rock which may be quarried or split with crow bars, boulders which do not requiring and any rock which in dry state may be hard, requiring blasting but which when wet becomes soft and manageable by means other than blasting. The classification of excavation shall be decided by the Engineer-in-charge and his decision shall be final and binding on the Contractor.

**ITEM-29 - DO - in hard rock**

1. Para 1 to 13 of the item of excavation for foundation in all sorts of soil shall apply.

14. Excavation shall be in any rock or boulders for which the use of mechanical plant for blasting is required. The classification of excavation shall be decided by the Engineer-in-charge and his decision shall be final and binding on the Contractor. Merely the use of explosives in excavation will not be considered as a reason for higher classification unless blasting is clearly necessary in the opinion of the Engineer-in-charge.

15. In the opinion of the Engineer-in-charge where blasting is prohibited for any reason, excavation shall be carried out by chiselling, wedging or any other agreed method.

16. Blasting shall be carried out with the written permission of the Engineer-in-charge. All the statutory law, regulation rules, etc. pertaining to the acquisition, transport, storage, handling and use of explosives shall be strictly followed.

17. The Contractor may adopt any method or methods of blasting consistent with the safety and job requirements, after approval from the Engineer-in-charge.

18. The magazine for the storage of explosives shall be built to the designs and specifications of the Explosives Department concerned and located at the approval site, No unauthorised person shall be admitted into the magazine which when not in use shall be kept securely locked. No matches or inflammable material shall be allowed in the magazine. The magazine shall have an effective lightning conductor. The following shall be hang in the lobby of magazine.

(a) A copy of the relevant rules regarding safe storage both in English and in the language with which the workers concerned are familiar.

(b) A statement of upto date stock in the magazine.

(c) A certificate showing the last date of testing of the lightning conductor.

(d) A notice that smoking is strictly prohibited.

19. In addition to these, the Contractor shall also observe the following instructions and any further additional instructions which may be given by the Engineer-in-charge and shall be responsible for damage to property and any accident which may occur to workmen or the public on account of any operations connected with the storage/handling or use of explosive and blasting. The Engineer-in-charge shall frequently check the Contractor's compliance with these precautions.

20. All the materials, tools and equipments used for blasting operations shall be approved type. The Engineer-in-charge may specify the type of explosives to be allowed in special cases. The fuse to be used in wet locations shall be sufficiently water resistant as to be unaffected when immersed in water for 30 minutes. The rate of burning of the fuse shall be uniform and definitely known to permit such a safe length being cut as will permit sufficient time to the fires or reach safely before explosion takes place. Detonators shall be capable of giving effective blasting of the explosives. The blasting powder explosives, detonators etc. shall be fresh and not damaged due to damp., moisture or any other cause. They shall be inspected totally and removed immediately.

21. The blasting operation shall remain in the charge of competent and experienced supervisor and workmen who are thoroughly acquainted with the handling explosives and blasting operations.

22. The blasting shall be carried out during fixed hours of the day preferably during the midday lunch hour or at the close of the works as ordered in writing by the Engineer-in-charge. The hours shall be made known to the people in the vicinity. All the charges shall be prepared by the man in charge only.

23. Red danger flags shall be displayed prominently in all directions during the blasting operations. People except those who actually light the fuse, shall be prohibited from entering this areas. The flags shall be planted 200 meters from the blasting site in all directions and all persons including workmen shall be excluded from the flagged area at least 10 minutes before the firing, a warning whistle being sounded for the purpose.

24. The enlarge holes shall be drilled to required depths and in suitable places. Blasting should be as light as possible consistent with through breakage of the material necessary for economic loading and hauling. Any method of blasting which leads to overshooting shall be discontinued.

25. When blasting is done with powder, the fuse cut to the required length shall be inserted into the hole and powder dropped in. The powder shall be gently tamped with copper rods with rounded ends. The explosive powder shall then, be covered with tamping materials which shall be tamped light but firmly.

26. When blasting is done with dynamite and other high explosives, dynamite cartridges shall be prepared by inserting the square cut end of a fuse into the detonator and finishing it with nippers at the open end, the detonator gently pushed into the primer leaving 1/3rd copper tube exposed outside. The paper of the cartridge shall then be closed up and securely bound with wire, or twine,. The primer shall be housed into the explosive. Bore holes shall be of such size that the cartirdge can easily go down. The holes shall be cleared of all debris and explosive inserted. The space of about 20 cm. above the charge shall then be gently filled with dry clay, passed home and the rest of the tamping formed of any convenient material gently packed with a wooden hammer.

27. At a time, not more than 10 such charges will be prepared and fired: The man in charge shall blow a whistle in a recognised manner for cautioning the people. All the people shall then be required to move to safe distances. The charge shall be lighted by the man in charge only. The mean in charge shall count "the numbers explosions, He shall satisfy himself that all the charges have been exploded before allowing the workmen to go back top the work site.

28. In case of a misfire, the following procedure shall be observed.

(1) Sufficient time shall be allowed to account for the delayed blast. The man incharge shall inspect all the charges and determine the missed charges.

(2) If it is the blasting powder charge it shall be completely flooded with water. A new hole shall be drilled at about 45 cm from the old hole and fired. This should blast the old charge should it not blast the old charge the procedure shall be repeated till the old charge is blasted.

(3) In case of charges of gelatin, dynamite, etc. the man in charge shall gently remove the tramping and the primer with the detonator. A fresh detonator and primer shall then be used to blast the charge alternatively the hole may be cleared of 30 cm. of tamping and the direction then ascertained by placing a stick in the hole. Another hole may then be drilled 15 cm away and parallel of H,. This hole shall then be charged and fired. The misfired hole should explode at the same time. The man in charge shall at once report to the contractor's offic and Engineer-in-charge all cases of misfire, the cause of the same and what steps were taken in connection therewith.

29. If a misfire has been\* found to be due to defective detonator or dynamite, the whole quantity in the box from which defective article was taken must be sent to the authority by the Engineer-in-charge for inspection to ascertain whether all the remaining materials in the box are also defective.

30. A careful and day to day account of the explosive shall be maintained by the contractor in the approved register and manner which shall be open to inspection by the Engineer-in-charge at all times.

31. Excavation shall be measured after removal of over burden by taking cross Sections at suitable intervals in the original position before the work starts and after it completion, and computing the volumes in cubic meters by the methods of average end areas. Where it is not feasible to compute volumes by this method because of erratic location of isolated deposits, the volumes shall be computed by other accepted methods. At the option of the Engineer-in-charge, the Contractor shall leave depth indicators during excavation of such shape and size, and in such positions as directed so as to indicate the original ground level as accurately as possible. The contractor shall see that these remain intact till the final measurements are taken. Where cross sectional measurements could not be taken due to irregular configuration, or where the rock is admixed with other classes of materials, the volumes shall be computed on the basis of stacks of excavated rubble after making 40 percent deduction therefrom.

**ITEM 30 Providing and laying uncoursed rubble masonry with hard stone of approved quality in foundations and plinth in cement mortar 1:6 (1 cement: 6 course sand) including levelling up etc. complete.**

1 . Stone shall be hard, sound, free from cracks, decay and weathering and shall be freshly quarried from an approved quarry. Stone with round surface shall not be used. The stones when immersed in water for 24 hours shall not absorb water by more than 5 percent of their dry weight when tested in accordance with IS : 1124. The length of stone shall not exceed three times its height and the breadth on base shall not be greater than three fourths of the thickness of wail nor less than 15 cm.

2. Cement and sand shall be mixed in proportion as specified in the item. Cement and sand shall be proportioned by volume after making due allowance for bulking. The required quantity of water shall then be added and the mortar mixed to produce workable consistency.

3. The mixing shall be done intimately. The operation shall be carried out on a clean water tight platform, and cement and sand shall be first mixed dry in the required proportion to obtain as uniform colour and then the mortar shall be mixed for at least two minutes after addition of "water. In case of cement mortar, that has stiffened because of evaporation of water the same shall be retempered by adding water as frequently as needed to restore the requisite consistency, but this retempering shall be permitted only, within thirty minutes from the time of addition of water at the time of initial mixing.

4. The dressing of stone shall conform to the general requirements of dressing of stone covered in IS : 1129. Stones shall be sufficiently wetted before laying to prevent absorption of water from mortar. The bed which is to receive the stone shall be cleaned, wetted and covered with a layer of fresh mortar. All stones shall be laid full in mortar both in bed and in vertical joints and settled carefully in place with a wooden mallet immediately on placement so that it is solidly bedded in mortar before the same has set. Clean chips and spalls shall be edges into the mortar joints and beds wherever necessary to avoid thick beds or joints of mortar. Whenever foundation masonry is laid directly on rock, the face of the first course shall be dressed to fit into the rock snugly when pressed down in the mortar bedding over the rock. No dry or hollow space shall be left anywhere in the masonry and each stone shall have all the embedded faces completely covered with mortar. Vertical joints, shall be staggered as far as possible. Sufficient transverse bond shall be provided by the use of bond stones extending from the front to the back of the masonry. In case of thick walls bond stones shall overlap each other in their arrangement. Bed shaped bond stones or headers shall not be used.

5. At all angular junctions, stones at each alternate course shall be well bonded into the respective course of the adjacent wall. All connected masonry in structure shall be carried up at one uniform level throughout as far as possible, but when breaks are unavoidable, the masonry shall be raked in sufficient long steps to facilitate joining of new work with old. The stepping of taking shall not be more than 45 degree with horizontal wing walls. Abutments and piers etc. shall be carried up truly plumb or with the specified batter. Face work and hearting shall be brought up evenly. The top of each course, however, shall not be levelled up by use of flat chips.

6. Stone shall be hammer dressed on the face, the sides and beds to enable it to come in proximity with the neighboring stone. The bushing on the face shall not be more than 4 cm on exposed face chips and spalls of stone may be used where necessary to avoid thick mortar beds or joints and it shall also be ensured that no hollow spaces are left anywhere in the masonry. The chips shall not be used below hearting stone to bring these up to the level of face stone. Use of chips shall be restricted to filling of interstices between the adjacent stones in hearting and they shall not exceed 20 percent of the quantity of store masonry.

7. The hearting or interior filling of wall face shall consist of rubble stones not less than 15 cm. in any direction, carefully laid, hammered down with a wooden mallet into position and solidly bedded in the mortar. The hearting should be laid nearly level with facing and backing. Through bond stone shall be provided in masonry up to 60 cm. thickness and in case of masonry above 60 cm. thickness a set of two or more than bond stones overlapping each other at least by 15 cm shall be provided in a line from face to back. In case of highly absorbent types of stone (Porous lime stone and sand stones etc.) the bond stone shall extend only about two third into the wall, as through stone in such cases may give rise to penetration of dampness and therefore for all thickness of such masonry a set of two or more bond stones, overlapped each other by at least 15 cm shall be approved. One bond stone or a set of bond stones shall be provided for every 0.50 square metres of the masonry surface, bond stones shall be stacked separately and marked to distinguish from other stones. Masonry work shall be started after sufficient number of bond stones are collected on site as directed by the Engineer-in-charge.

8. The quoins shall be laid header and stretcher alternately. Every stone shall be tilted to the adjacent stone so as to form neat and close joint. Face stone shall extend and bond well in the back. These shall be arranged to break joints, as such as possible and to avoid long vertical lines of joints.

9. The face joints shall not be more than 20mm thick, but shall be sufficiently thick to prevent stone to stone contact and shall be completely filled with mortar.

10. Green work shall be protected from rain by suitable covering. Masonry work in cement or composite mortar shall be kept constantly wet on all faces for a minimum period of seven days. The top of the masonry work shall be left flooded with water at the close of the day. During hot weather all finished or partly completed work shall be covered for wetted in such manner as will prevent rapid drying. The racking of joints where necessary shall be done at the end of day's work when mortar is green.

11. The scaffolding shall be sound and strong to withstand all loads likely to come upon it. The holes which provide resting space for horizontal members shall not be left in masonry under or on metre in width or immediately near the skew backs of arches. The holes left in the masonry work for supporting the scaffolding shall be filled and made good.

12. When fresh masonry is to be placed against existing surface of structures, these shall be cleaned of all loose material, roughened and wetted as directed by the Engineer-in-charge so as to effect a good bond with the new work.

13. Stone masonry shall be measured cubic meters

14. The contract unit for stone masonry work shall include the cost of all labour, materials, tools and plant. Scaffolding and other expenses incidental to the satisfactory completion of the work as described herein above.

**ITEM-31 Providing and laying coursed rubble masonry hard stone of approved quality for super structure -and plinth in cement mortar 1:5 (1 cement :5 course sand) etc. complete.**

1. Para 1 to 14 of item of U.C.R. masonry shall apply.

15. Masonry shall be laid with course, where there is variation in the height of course. Large courses shall be placed at lower levels with height of courses decreasing gradually towards the top.

16. In case of abutment and wing walls, weep holes shall be provided in the masonry to drain moisture from the backfilling, Weep holes shall be 8 cm wide, 15 cm high or circular of 15 cm. diameter and shall extend through the full width of the masonry with slopes of about 12 vertical to 20 horizontal towards the draining face. The spacing of weep holes shall be generally 1 metre in either direction with the lowest one at about 1,5 cm. above the low water level or ground level whichever is higher or as directed by the Engineer-in-charge.

**ITEM-32 Providing and laying Brick work using common burnt clay building bricks having crushing strength not less than 35 kg/sq.m. in foundation and plinth in cement mortar 1:5 (1 cement: 5 fine sand)**

1. Burnt clay bricks shall conform to the requirements of IS: 1017, except that the minimum compressive strength when tested flat shall not be less than 35 Kg/square cm. and that the size may be according to local practice with a tolerance of 5 percent.

2. Cement and sand shall be mixed in proportions as specified in the item. Cement and sand shall be proportioned by volume after making due allowance for bulking. The required quantity of water shall then be added and the mortar mixed to produce workable consistency.

3. The mixing shall be done intimately. The operation shall be carried out on a clean waster tight platform, and cement sand shall be first mixed dry in the required proportion to obtain uniform colour and then the mortar shall be mixed for at least two minutes after addition of water. In case of cement mortar, that has suffered because of evaporation of water the same shall be re-tempered by adding water as frequently as needed to restore the requisite consistency but this retempering shall be permitted only within thirty minutes from the time of addition of water at the time of initial mixing.

4. Bricks shall be soaked in water for a minimum period of one hour before use. When bricks are soaked they shall be removed from the tanks sufficiently in advance so that at the time of laying they are skin-dry. Such soaked bricks shall be stacked on a clean place where they are not spoiled by dirt, earth etc.

5. All brick work shall be laid in English bond, even and true to line, plumb level and all joints accurately kept. The bricks used on the face shall be selected whole ones of uniform size and with true rectangular face.

5.1 Bricks shall be laid frogs up, if any, on a full bed of mortar, When laying bricks shall be slightly pressed so that the mortar gets into all the surface pores of bricks to ensure proper adhesion. All joints shall be properly flushed and packed with mortar so that no hollow spaces are left.

5.2 Before laying bricks in foundations, a layer of not less than 12 mm. of mortar shall be spread to make the surface on which the work will be laid even.

5.3 The brick work shall be built in uniform layer, corners and other advanced work shall be raked back. Brick work shall be done true to, plumb or in specified manner. No part of it, during construction, shall rise more than one metre above the general construction level to avoid unequal settlement and improper jointing.

5.4 Tothing may be done where future extension is contemplated but shall be used as an alternative to raking back.

5.5 The thickness of joints shall not exceed 12 mm.

6. When fresh masonry is to be placed against existing surface of structures, these shall be cleaned of all loose material, roughened and wetted as-directed by the Engineer-in-charge so as to effect a good bond with the new work.

7. Green work shall be protected from rain by suitable covering. Masonry work in cement or composite mortar shall be kept constantly moist on all faces for a minimum period of seven days. The top of the masonry work shall be left flooded with water at the close of the day.

7.1 During hot weather, all finished or partly completed work shall be covered or wetted in such manner as will, prevent rapid drying of the brick work.

8. The scaffolding shall be sound and strong to withstand all loads to come upon it. The holes which provide resting space for horizontal members shall not be left in masonry under one metre in width or immediately near the skew backs or arches. The holes left in the masonry work for supporting the scaffolding shall be filled and made good.

9. In case of abutment and wing wall, weep holes as shown on the drawing or directed by the Engineer-in-charge shall be provided in the masonry to drain moisture from the backfilling. Weep holes shall



be 8 cm wide 15 cm. high or circular 15 cm. diameter and shall extend through the full width of the masonry with slope of about t vertical to 20 horizontal high or circular of 15 cm towards the draining face. The spacing of weep holes shall be generally 1 m. in either direction with the lowest one at about 15 cm. above the low water level or ground level whichever is higher or as directed by the Engineer-in-charge.

10. All brick work shall be measured in cubic metres.

11. The contract unit for brick work shall include the cost of all labour, materials tools and plant, scaffolding and other expenses incidental to the satisfactory completion of the work as described herein above and provision of weep holes.

**ITEM-33 Supplying and fixing reinforced concrete heavy duty non-pressure pipes with collars for culverts carrying heavy traffic as per Indian Railway Standard specifications including setting the pipes in C.M. 1:2 watering and laying (to level or slope) of class NP3 of following internal diameters, (i) 300 mm dia. (ii) 450 mm dia. (iii) 600 mm dia. (iv) 750 mm dia (v) 900 mm dia. (vi) 1050 mm dia. (vii) 1200 mm dia.**

1. The work shall consist of furnishing and installing reinforced cement concrete pipe of the type dia metre and length required at the location shown on the drawings or as ordered by the Engineer-in-charge.

2. Reinforced concrete pipe shall be NP3 type conforming to the requirements of IS : 458 and shall be of dia as specified in the item. Each consignment of cement concrete pipes shall be inspected, if necessary and approved by the Engineer-in-charge, either at the palce of manufacture or at the site before their incorporation in the works.

NP3, NP2, NP1 pipes are used for R. C. C. Pipes, where testing of pipes will not be feasible the contractors will have to produce a certificate from the manufacturers on company's latter head the given hereinafter form.

Production of such certificate will not however relieve the contractor from his responsibility of supplying pipes of required standard and will have to bear the loss or damage caused to the work on account of defects found subsequently during the execution. It will also be necessary to purchase these pipes from manufacturer having standard equipments for carrying out various test as per IS : 458 at his factory.

**FORM OF CERTIFICATE FOR NP3, NP2, NP1 PIPES**

We \_\_\_\_\_ manufacturer of R.C.C. pipes produce B.C.C. pipes as per the requirement of IS: 458 and also carry out the required test at our place. We have acquired equipments for carrying out test and are prepared to carryout test at our factory sites.

We have experience of manufacturing of pipes of \_\_\_\_\_ years  
The pipes supplied by us to M/s. \_\_\_\_\_ satisfy the requirement of IS : 458

Date: \_\_\_\_\_

Place : \_\_\_\_\_

Manufacturer's Sign \_\_\_\_\_

3. No pipe shall be palced in position until the foundations have been approved by the Engineer-in-charge. Where two pr more pipes are to be laid adjacent to each other, they shall be separated by a distance equal to at feat half the diametre of the pipe subject to minimum of 450 mm. The laying of pipes on the prepared foundation shall start from the outlet and proceed towards the inlet and be completed to the specified lines and grades. The pipes shall be fitted and matched so that when laid in works they form a culvert with a smooth uniform invert. Any pipe found defective or damaged during laying shall be removed at there cost of Contractor.

4. The pipes shall be jointed either by collar joint or by flush joint. In the former case, the collars shall be of R.C.C., 150 to 200 mm wide and having the same strength as the pipes to be jointed. Caulking, space shall be between 13 and 20 mm according to the diametre of the pipes., Caulking material shall be slightly wet mix of cement and sand in the ratio of 1:2 rammed with Caulking irons. Before caulking the collar shall be so placed that its centre coincides with that of pipe and an even annular space is left between the collar and the pipes. Flush joint may be shaped to form a self centering joint with a joining space 13 cm wide. The joining space shall be filled with cement mortar. 1 cement to 2 sand, mixed sufficiently dry to remain in position when forced with a trowel or rammer. Care shall be taken to fill all voids and excess mortar shall be removed. All joints shall be made with care so that their interior surface is smooth and consistent with the interior surface of the pipes. After finishing, the joint shall be kept covered and damp for at least four days.

5. R. C. C. pipe shall be measured along their centre between their inlet and outlet ends in linear metres.

6. The rate for the pipes shall include the cost of pipe including loading, unloading, handling storing laying in position and joining complete.

**ITEM-34 Supplying and fixing reinforced concrete heavy duty non-pressure pipes with collars for culverts including setting and jointing the pipes in C. M. 1:2 watering and laying (to level or slope) of I.S. class of NP2 of following internal diameter, (i) 300 mm dia. (ii) 450 mm dia. (iii) 600 mm dia. (iv) 750 mm dia (v) 900 mm dia. (vi) 1050 mm dia (vii) 1200 mm dia.**

1. The work shall be carried out as per item of NP3 pipes except that the pipes will be of NP2 class instead of NP3 class conforming to requirements of IS : 458 and of the dia as specified in this item.

**ITEM-35 Supplying and fixing NP1 class R.C.C. pipes**

1. The work shall be carried out as per item of NP3 pipes except that the pipes will be ordinary irrigation pipes of NP 1 class instead of NP 3 class conforming to requirements of IS'458 and of the dia. as specified in this item. Please see Item No 53 for detailed information.

**ITEM-36 Filling around the pipes with murrum including dressing, tampering etc. complete.**

1. Area around pipes shall be filled with murrum, chhara or other gritty material immediately after the pipes have been laid and the joining material has hardened. The material shall be clean, free from boulders large roots, excessive amount of sods or other vegetable matter, and lumps and shall be approved by the Engineer-in-charge. Filling upto 0.3 metre above the top of the pipe shall be carefully done and the soil thoroughly rammed, tampered or vibrated in layers of not exceeding 150 mm: particular care being taken to thoroughly consolidate the materials under the haunches of the pipe. Filling shall be carried out simultaneously on both sides of the pipes in such a manner that unequal pressures do not occur. In case of high embankments, after filling upto the top pin the above said manner a loose fill of a depth equal to external diameter of the pipe shall be placed over the pipe before further layers are added and compacted. Materials shall be filled in pharas 3m. x 1.5m x 0.5m size and shall be measured in cubic metres. Unit rate includes cost of materials and spreading including labour and tools needed for the above operations.

**ITEM-37 Providing and laying ordinary (unreinforced) concrete 1:2:4 (1 cement :2 coarse sand :4 crushed stone aggregate 20 mm nominal size) & curing complete including cost of form work (without reinforcement)**

1. In case of ordinary concrete, mix is not required to be designed by preliminary tests and proportions of cement, fine aggregates and coarse aggregates are specified by volume as given in table below for different four grades designated as ordinary M.100: M.150: M.200 and M.250.

2. In the designation of a concrete mix .letter 'M' refers to the mix and the number to the specified 28 days works cube compressive strength of that mix on 150 mm cubes, expressed in kg./cm.

3. The ordinary concrete mix shall generally be specified by volume. For cement which normally comes in bags and is used by weight, volume shall be worked out taking 50 kg. of cement as 0.035 cubic metre in volume. While measuring aggregate by volume, shaking, ramming or hammering shall not be done, proportioning of sand be as per its dry volume. In case it is damp allowance lor bulking shall be made as per IS:2386 (Part III).

4. In gradients required for ordinary concrete cotaining one 50 kg bag of cement for different proportions ofmix shall be as given in Table below.

TABLE

Grade of Concrete	Mix by Volume	Total quantity of dry aggregate by volume per 50 kg cement to be taken as sum of individual volume of fine % coarse aggregate maximum (1 cubic metre = 1000 Litres)	Proportion of fine aggregate to Coarse aggregate	Quantity of water per 50 kg of cement maximum
1.	2.	3.	4.	5.
Ordinary M200	1:3:6	300	Generally 1:2 for fine aggregate to coarse aggregate by volume but to a upper limit of 1:1.5 and Limit of 1 :3	34
Ordinary M150	1:2:4	220		32
Ordinary M200	1:1.5:3	160		30
Ordinary M250	1:1:2	100		27

**Note :** The proportions of the aggregates shall be adjusted from upper limit to lower limit progressively as the grading of the final aggregate becomes finer and the maximum size of coarse aggregate becomes larger.

**Example :** For an average grading of fine aggregate (that is Zone II of IS:383-1963) the proportions shall be 1:1 1/

BHAVNAGAR MUNICIPAL CORPORATION - BHAVNAGAR

2. 1:2 and 1:3 for maximum size of aggregates 10 mm, 20 mm and 40 mm respectively.

Note : K mix leaner than M 100 (1:3:6) may be used for non-structural part, if provided in the contract. In such cases grading of aggregates shall be by volume. Other requirements for mixing, placing and curing shall be the same.

5. Following shall be the maximum nominal size of coarse aggregate for the different items of work.

- |  |       |
|--|-------|
| (i) Plain C.C.   | 63 mm |
| (ii) Soild type piers, abutments and wing walls, and their per caps. (Coarse aggregate of size upto 40 mm shall be machine crushed.) | 40 mm |
| (iii) C.C. Wearing Coat M-150<br>(Coarse aggregate of size upto 40 mm shall be machine crushed.)                                     | 20mm  |

6. Fine aggregate shall be clean, hard coarse sand. It shall be free from dust and such other substanes. The sand shall be got approved by the Engineer in-charge.

7. All materials shall be stored as to prevent their deterioration or intrusion of their quality and fitness for the work. Any material which has deteriorated or has been damaged or is otherwise considered defective by the Engineer-in-charge shall not be used in the work.

8. Cement shall be stored above the ground level in perfectly dry and watertight sheds and 'shall be stocked not more than eight, bags high. Wherever bulk storage containers are used, their capacity should be sufficient to cater to the requirements at site and should be cleaned atleast once every 3 to 4 months. Cement more than 3 to 4 months old shall invariably be tested to ascertain that it satisfies the acceptability requirements. The aggregates shall be stored in such a way as to prevent admixture of foreign materials. Different sizes of fine or coarse aggregate shall be stored in separate stock piles sufficiently removed from each other to prevent intermixing the materials at edges of the pipes.

9. The water for mixing shall be potable water to the satisfaction of the Engineer-in-charge. The quantity of water shall be just sufficient to produce a dense concrete of required workability for the job,

10. For all work, concrete shall be mixed in a mechanical mixer along with other accessories shall be kept in first class working condition and so maintained throughout the construction. Mixing shall be. continued till materials are uniformly distributed and an uniform colour of the entire mass is obtained and each individual particles of the coarse aggregate shows complete coating of mortar containing its proportionate amount of cement. In no case shall the mixing be done for less than 2 minutes after all ingredients have been put into the mixer.

11. When hand mixing is permitted by the Engineer-in-charge for small jobs or for certain other reasons, it shall be done on a smooth watertight platform large enough to allow efficient turning over of the ingrediets of concrete before and after adding water. Mixing platform shall be so arranged that no foreign material shall get mixed with concrete nor does the mixing water flow out. Cement in required number of bags shall be placed in a uniform layer on top of the measured quantity of fine and coarse aggregate. Which shall also be spread in a layer of uniform thickness on the mixing platform. Dry coarse" and fine aggregate and cement. Then shall be mixed thoroughly by turning over to mass turned over till a mix of required consistency is obtained. In hand mixing quantity of cement shall be increased by 10 percent above that specified.

12. Mixers which have been out of use for more than 30 minutes shall be thoroughly cleaned before putting in a new batch. Unless otherwise agreed to by the Engineer-in-charge the first batch of concrete from the mixer shall contain only two third of normal quantity of course aggregate. Mixing plants shall be thoroughly cleaned before chnging from one type of cement to another.

13. The method of transporting and placing concrete shall be approved by the Engineer-in-charge Concrete shall be so transported and placed that no contamination, segregation or loss of its constituent material takes place. All form work and reinforcement contained in it shall be cleaned and made free from standing water, dust snow or ice immediately before placing of concrete. No concrete shall be placed in any part of the structure until the approval of the Engineer-in-charge has been obtained.

If concreting is not started with 24 hours of the approval being given, it shall have to be obtained again from the Engineer-in-charge. Concreting then shall proceed continuously over the area between construction joints. Fresh concrete shall not be placed against concrete which has been in position for more than 30 minutes unless a proper construction joint is formed. Concrete shall be compacted in its final position within 30 minutes of its discharge from the mixer unless carried in properly designed agitators, operating continuously, when this time shall be within 2 hours of the addition of cement to the mix and within 30 minutes of its discharge from the agitator. Except where otherwise agreed to by the Engineer-in-charge, concrete shall be disposed in horizontal layer to a compacted depth of not more than 0.45 metre when internal vibrators are used and not exceeding 0.30 metre in all other cases.

15. Unless otherwise agreed to by the Engineer-in-charge. concrete shall not be dropped into place from a height exceeding 2 metres. When trucking or chutes are used they shall be kept clean and used in such way as to avoid segregation. When concreting has to be resumed on a surface which has hardened, it shall be roughened, swept clean, thoroughly wetted, and cleaned with a 13mm.thick layer of mortar composed of cement and sand in the same ratio as in the concrete mix itself. This 13 mm layer of mortar shall be freshly mixed and placed immediately before placing of new concrete. Where concrete has not fully hardened, all laitance shall be removed by scrubbing the new surface with wire or bristle brushed. Care being taken to avoid dislodgement of particulars of coarse aggregate. The surface shall then be thoroughly wetted, all free water removed and then coated with neat cement grout. The first layer of concrete to be placed on this surface shall not exceed 150 mm. in thickness, and shall be well rammed against old work particular attention being given to corner and close spots.

16. All concrete shall be compacted to produce a dense homogeneous mass with the assistance of vibrators, unless otherwise permitted by the Engineer-in-charge for exceptional cases, such as concreting under water, where vibrator cannot be used sufficient vibrators in serviceable condition shall be kept at site so that spare equipments is always available in the event of break downs.

17. Immediately after compaction, concrete shall be protected against harmful effects of weather, including rain, running water, shocks, vibrations due to traffic, rapid temperature changes, fast drying put process. It shall be covered with wet sacking hessian or other similar absorbent material approved by the Engineer-in-charge soon after the initial set. It shall be kept continuously wet for a period of not less than 14 days from the date of placement. Masonry work over the foundation concrete may be started after 48 hours of its laying but the curing of concrete shall be continued for a minimum period of 14 days.

18. Form work shall include all temporary or permanent forms required for forming the concrete, together with all temporary construction required for their support. Forms for concrete shall be constructed of metal or timber suitably lined and be of substantial and rigid construction true to shape and dimensions shown on the drawings. Where metal forms are used, all bolts and rivets shall be counter sunk and well ground to provided a smooth, plain surface. Where timber is used it shall be well seasoned, free from loose knots, projecting nails, splits or other defects that may mark the cement surface of concrete. For exposed concrete faces, timber for shuttering shall be wrought on all faces in contact with concrete.

19. Forms shall be mortar tight and shall be made sufficiently rigid by the use of ties and bracings to prevent any displacement or sagging between supports. They shall be strong enough to withstand all pressure, ramming and vibration, without deflection from the prescribed lines occurring during and after placing the concrete. Screw jacks or hardwood wedges where required shall be provided to make up any settlement in the form work either before or during the placing of concrete. Suitable camber shall be provided in horizontal members of surface specially in long spans to counteract the effects of any deflection. The frame work shall be so fixed as to provide for such camber. Forms shall be so constructed as to be removable in sections in the desired sequence, without damaging the surface of concrete or disturbing other sections. Unless otherwise specified or directed. Chamfers or fillets of size 25 mm x 25 mm shall be provided at all angles of form work to avoid sharp corners.

20. The inside surface of forms shall, except in the case of permanent form work or where otherwise agreed to by the Engineer-in-charge. be coated with an approved material to prevent adhesion of concrete to the form work. Release agents shall be applied strictly in accordance with the manufacturer's instructions and shall not be allowed to come into contact with any reinforcement of prestressing tendons and anchorage. Different release agents shall not be used in form work of concrete which will be visible in the finished works.

21. Special measures shall be taken to ensure that the formwork does not hinder the shrinkage of concrete because without these cracking could occur before the form work is removed Where applicable arrangements must be made to ensure that the form does not restrain the shortening and hogging of the beams of slabs during tensioning of the tendons. The formwork should take due account of the calculated amount at positive or negative camber so as to ensure the correct final shape of the structures having regard to the deformation of false work, scaffolding or propping and the instantaneous deformation due to various causes affecting prestressed structures. Where there are re-entrant angles in the concrete sections, the formwork should be removed at these sections as soon as possible after the concrete has set in order to avoid cracking due to shrinking of concrete. Formwork shall be tight enough to prevent any appreciable loss of cement during vibrations. Suitable tolerances should be provided in the formwork, immediately before concreting all forms shall be thoroughly cleaned Contractor shall give the Engineer-in-charge due notice before placing any concrete in the forms to permit him to inspect and accept the false work and forms as to their strength alignment and general fitness, but such inspection shall not relieve the contractor of his responsibility for safety of machinery, materials and for results obtained.



22. The Engineer-in-charge shall be informed in advance by the contractor of his intention to strike any formwork. While fixing the time for removal of formworks, due consideration shall be given to local conditions, character of the structure, the weather and other conditions that influence the setting of concrete the removal of the load supporting or soffit forms may commence when concrete has attained strength and of the materials used in the ix. Where field operations are controlled by the strength test of concrete, the removal of the load supporting or soffit forms may commence when concrete has attained strength equal to at least twice the stress to which the concrete will be subject at the time of striking props including the effect of any further addition of loads, When field operations are not controlled by strength tests of concrete the vertical forms of beams, columns and walls may be removed after 2 days. The props of slabs and beams may be removed after 14 and 21 days respectively. All form work shall be removed without causing any damage to the concrete. Centering shall be gradually and uniformly lowered in such a manner as to avoid any shock or vibrations. Supports shall be removed in such a manner as to permit the concrete to take stresses due to its own weight uniformly and gradually. Where internal metal ties are permitted they or their removable parts shall be extracted without causing any damage to the concrete and remaining holes filled with mortars. No permanently embedded metal part shall have less than 25mm. cover to the finished concrete surface. Where it is intended to reuse the formwork it shall be cleaned and made good to the satisfaction of the Engineer-in-charge.

23. Immediately after the removal of forms, all exposed bars or bolts passing through the Cement Concrete member and used for shuttering or any other purpose shall be cut inside the Cement Concrete member to a depth of at least 25 mm. below the surface of the concrete and the resulting holes filled by cement mortar. All fins cause by form joints, all cavities produced by the removal of form ties and all other holes and depressions, honeycomb spots, broken edges or corners and other defects, shall be thoroughly cleaned, saturated with water and carefully pointed and rendered true with mortar of cement and fine aggregate mixed in the proportions used in the grade of concrete that is being finished and of as dry a consistency as is possible to use. Considerable pressure shall be applied in filling and pointing to ensure thorough filling in all voids. Surface which have been pointed shall be kept moist for a period of 24 hours. If rock, pockets/honeycombs, in the opinion of the Engineer-in-charge are of such an extent and character as to affect structure materially or to endanger the life of the strength of the steel reinforcement, he may declare the concrete defective and require the removal and replacement of the portions of the structure affected. Joint shall be filled up with bitumen as directed by Engineer-in-charge in case of C.C. wearing surface.

24. The unit rate for concrete shall include the cost of all materials, labour, tools and plants required for mixing, placing in positions, vibrating and compacting, finishing as per directions of the Engineer-in-charge, curing and all other incidental expenses for producing concrete of specified strength to complete the structure or its components as shown in the drawings and according to these specifications, The rate shall also include the cost of making, fixing and removing of all centering and forms required for the work centering.

25. The payment will be made on cmt. basis of the finished work.

**Item No. 37 A : Providing & laying C.C.1:4:8 (1=Cement, 4=coarse sand, 8=grade agg 40 m.m. nominal size) and curing comp of form work.**

**Item No. 37 B : Providing & laying C.C.1:5:10 (1=Cement, 4=coarse sand, 8=grade agg 40 m.m. nominal size) and curing comp. incl. cost of form work.**

Materials : Specification for all the ingredients to be used shall be as per the details given in the central specifications for materials attached.

**PROPORTION** : The concrete shall consist for the part of cement, sand and metal as per (40 to 63 m.m. size) the above description of items.

**MIXING** : Mixing of the materials shall be done as for specified volumetric proportion as a possible after water is added, so that every place of agg. is uniformly coated by cement plaster. The concrete must be used immediately after it is prepared and in any case shall be used after the cement has attained final set. Generally concrete prepared before more than half an hour shall not be permitted to be used.

**LAYING** : Consolidation shall be rapidly carried out sufficient labour being employed to permit of ramming reading be spreading etc. being comp. within as short items as possible causing the mortar to cream up in no case shall ramming be prolonged after the cement has been to take its initial sets.

**CURING** : As soon as the concrete has set sufficiently i.e. after about an hour of laying the surface must be protected from rapid curing out by being covered with at sand wet sunny of where possible curing shall done by forming the shall be allowed pools of water by means of sand pollics. The curing shall be continued or atleast 10 (ten) days broadly two or three weeks and where possible for longer period. The rate includes all necessary equipments, labour etc. Payment shall be made on cubic measurement of cement concrete. The entire work shall be carried out as per the specification for the PWD Hand book Vol. I Page No. 166 to the satisfaction of the Engineer-in-charge.

**ITEM-38 Providing and laying ordinary (reinforced) concrete 1:2:4 (1 cement :2 coarse sand :4 crushed stone aggregate 20 mm nominal size) & curing complete (excluding cost of reinforcement)**

1. Para 1 to 25 of ordinary concrete [without reinforcement] shall apply.

26. In the case of reinforced concrete work, workability shall be such that the concrete surrounds and properly grips all reinforcement. The degree of consistency which must depend upon the nature of work and methods of vibration of concrete, shall be determined by regular slumps test. Following test slump shall be adopted for different types of works:

Type of work	Stumps where vibrators are used	Stumps Where vibrators are not used
(i) Mass concrete in R.C.C. foundation, footings and retaining walls,	10mm to 25 mm	80mm
(ii) Beams, slabs and column simply reinforced	25 mm to 40 mm	100mm to 120 mm
(iii) Thin R.C.C. section or sections with congested steel	40 mm to 50 mm	125mm to 150mm

Maximum nominal size of the concrete aggregate shall be 20 mm. and shall machine crushed.

Works strength test shall be made in accordance with IS : 516. Each test shall be conducted on ten specimens five of which shall be taken on each day of concreting and cubes shall be made at the rate of one for every 5 cubic metre to concrete or a part thereof. However, if concreting done in a day is less than 15 cubic metre, the minimum number of cubes can be reduced to 6 with the 15 cubic metre of concrete or a part thereof. However, if concreting done in a day is less than 15 cubic metre, the minimum number of cubes can be reduced to 6 with the specific permission of the Engineer-in-charge. Similar works test shall be carried out whenever the quality and grading of materials is changed irrespective of the quantity of concrete poured. The number of specimens may be suitably increased as deemed necessary by the Engineer-in charge, when procedure of test given above reveals a poor quality to concrete and in other special cases.

26. All necessary labour, materials, equipment, etc. for sampling, preparing test cubes, curing etc. shall be provided by the contractor. Testing of the materials and concrete may be arranged by the Engineer-in-charge in an approved laboratory at the cost of the contractor.

29. The average strength of the group of cubes for each day shall be less than the specified works cube strength 20 percent of the cubes cast for each day may have values less than the specified strength, provided the lowest value is not less than 85 per cent of the specified strength.

30. R.C.C. work shall have exposed concrete surface. Centering design and its erection shall be approved by the Deputy Engineer-in-charge. One carpenter with helper will invariably be kept present through out the period of concreting. Movement of labour and other persons shall be totally prohibited over reinforcement laid in position. For access to different part as suitable platforms shall be provided so that steel reinforcement in positions is not disturbed. For ensuring proper cover, mortar blocks of suitable size shall be cast and tied to the reinforcement. Timber, kapachi or metal pieces shall not be used for this purpose. Concreting of important structural members shall always be done in the presence and under the supervision of department person not below the rank of Junior Engineer/ Supervisor/Overseer. After removal of form work and shuttering, the Executive Engineer shall inspect the work and satisfy by random checks that concrete of good quality. Plastering shall not be allowed to the exposed face of concrete.

32. In reinforced concrete, the volume occupied by reinforcement shall not be deducted. The slab shall be measured as running continuously through and the beam as the portion below the slab.

**ITEM-39 Providing steel reinforcement.**

- (a) Providing & placing in position mild steel bar reinforcement including cutting, bending, Hooking & tying complete as per details.
- (b) High yield strength deformed bars reinforcement.

1. The work shall consist of furnishing and placing, reinforcement of the shape and dimensions shown on the drawings or as-directed by the Engineer-in-charge.

2. Steel shall be clean and free from loose rust and loose mill scale at the time of fixing in position and of subsequent concreting.

3. Reinforcing steel shall conform accurately to the dimensions given in bar bending schedules shown on relevant drawings. Bars shall be bent cold to the specified shape and dimensions or as directed by the Engineer-in-charge using a proper bar bender, operated by hand or power to attain proper radius of bends. Bars shall not be bent or straightened in manner that will injure the material. Bars bent during transporting or handling

shall be straightened before use on work; they shall not be invariably be provided. The radius of the bend shall not less than twice the diameter of the round bar and length of the straight part of the bar-beyond the end of the curve shall be at least four times the diameter of the round bar. In the case of bars which are not round and in the case of deformed bars, the diameter shall be taken as the diameter of a circle having an equivalent effective area. The work shall be suitably encased to prevent any splitting of the concrete.

4. All reinforcement bars shall be accurately placed in exact position on the drawings, and shall be securely held in position during placing of concrete by annealed binding wire not less than 1 mm, in size and conforming to IS : 280 and by using stay blocks or metal chairs spacers, metal hangers, supporting wires or other approved devices at sufficiently close intervals. Bars will not be allowed to sag between supports or displaced during concreting or any of their operations over the work. All devices used for positioning shall be non corrodible material. Wooden and metal supports will not extend to the surface of concrete except where shown on the drawings. Placing bars on layers of freshly laid concrete as the work progress or adjusting bar spacing will not be allowed. Pieces of broken stone of brick and wooden blocks shall not be used. Layers of bars shall be separated by spacer bars, precast mortar block, or other approved device. Reinforcement after being placed in position shall be maintained in clean condition until completely embedded in concrete. Special care shall be exercised to prevent any displacement of reinforcement in concrete already placed. To protect reinforcement from corrosion, concrete cover shall be provided as indicated on the drawings. All bars protruding from concrete and to which other bars are to be spliced and which are likely to be exposed for an indefinite period shall be protected by a thick coat of neat cement grout.

5. Bars crossing each other, where required, shall Lie secured by binding wire (annealed) of size not less than 1 mm, and conforming to IS : 280 in such a manner that they do not slip over each other at the time of fixing and concreting.

6. As far as possible, bars of full length shall be used. In case this is not possible, overlapping of bars shall be done as directed by the engineer-in-charge. When practicable, overlapping bars shall not touch each other, but be kept apart by 25 mm or 1.25 times the maximum size of the coarse aggregate which ever is greater, by concrete between them. Where not feasible, overlapping bars shall be bound with annealed steel wire, not less than 1 mm. thickness twisted right. The overlaps shall be staggered for different bars and located at points, along the span where neither shear nor bending movement is maximum.

7. Whenever indicated on the drawings or desired by the Engineer-in-charge, bar shall be joined by couplings which shall have a cross-section sufficient to transmit the full strength of bars. The end of the bars that are joined by coupling shall be upset for a sufficient length so that the effective cross-section at the base of threads shall be standard white worth threads. Steel for coupling shall conform to IS :226.

8. When permitted or specified on the drawings joints of reinforcement bars shall be butt welded so as to transmit their full strength. Welded joints shall preferably be located at points where steel will not be subject to more than 75 per cent of the maximum permissible stresses and welds so staggered that at any one section not more than 20 per cent of the rods are welded. Only electric are welded using a process which excludes air from the molten metal and conforms to any or all other special provisions for the work .will be accepted. Suitable means shall be provided for holding the bars securely in position during welding. It must be ensured that no voids are left in welding and when welding is done in 2 or 3 stages, previous surface shall be cleaned properly. Ends of the bars shall be cleaned of all loose scale rust grease ,paint and other foreign matter before welding. Only competent welders shall be employed on the work. The M.S. Electrodes used for welding shall conform, to IS :814, Welded pieces of reinforcement shall be tested. Specimen shall be taken from the actual site and their number and frequency to test shall be as directed by the Engineer-in-charge.

9. Wastage shall be permitted upto 5 per cent maximum. Useful pieces of steel, as may be decided by the Engineer-in-charge shall be taken back by the Government at issue rate and at P.W.D. Store from where the steel was supplied. All the expenses of loading, carting, unloading and returning the waste will be borne by the contractor.

10. Reinforcement shall be measured in length separately for different diameters as actually used in the work. From the length so measured the weight of reinforcement shall be calculated in tones on the same basis of IS: 1732 even though steel is supplied to the contractor by the Department on actual weighment Lengths shall include hooks at ends. Wastage and annealed steel wire for binding shall not be measured and cost of these items shall be deemed to be included in the rates for reinforcement.

11. Rate for reinforcement shall include cost of all steel, its carting from P.W.D. Store to work site, its bending, placing binding and fixing in position as shown on the drawings and as directed by the Engineer in charge It shall also include cost of all devices for keeping reinforcement in approved position, cost of joining as per approved methods, and all wastage, & spacer bars, & also returning the useful wastage of the Department.

**ITEM – 40 Providing Cement pointing on uncoursed / coursed stone / brick wall masonry with cement mortar 1:3 (1 cement : 3 sand) (A) Flush pointing (B) Ruled Pointing.**

1. For surface which is to be subsequently jointed, the joints shall be squarely raked out to a depth of 15 mm while the mortar is still green. The raked joints shall be well brushed to removed dust and loose particles and the surface shall be thoroughly washed with water, cleaned and wetted.
2. Cement and sand shall be mixed in proportions as specified in the item. Cement and sand shall be proportioned by volume after making due allowance for bulking. The required quantity of water shall then be added and the mortar mixed to produce workable consistency.
3. The mixing shall be done intimately by hand – mixing. The operation shall be carried out on a clean watertight platform and cement and sand shall be first mixed dry in the required proportion to obtain a uniform colour and then the mortar shall be mixed for at least two minutes after addition of water. In case of cement mortar, that has stiffened because of evaporation of water, the same shall be re-tempered by adding water as frequently as needed to restore the requisite consistency but this re-tempering shall be permitted only with thirty minutes from the time of addition of water at the time of initial mixing.
4. For pointing, the mortar shall be filled and pressed into the raked-out joints before giving the required finish. The pointing shall then be finished to proper type given on the drawings. If type of pointing after the mortar has been filled and pressed into the joints and finished off level with the edge of the bricks, it shall while still green be ruled along the centre with a half round tool of such width as may be specified by the Engineer – in – charge. The superfluous mortar shall then be cut off from the edges of the lines and the surface of masonry shall also be cleaned of all mortar.
5. Curing shall be started as soon as the mortar used for finished has hardened sufficiently not to be damaged when watered. It shall be kept wet for a period of at least 7 days. During this period it shall be suitably protected from all damage.
6. Stage scaffolding shall be approved for the work. This shall be independent of the structure.
7. The work of pointing shall be measured in square metres of the surface treated.
8. The rate for pointing shall include erecting the removal of scaffolding all labour, materials and equipment incidental to complete the pointing, raking out joints, wetting filling with mortar, trowelling, point and watering.

**ITEM – 41 Providing and laying 22.50 cms thick rubble stone pitching including preparing surface, lying 15 cms thick murrum layer over prepared surface and arranging rubbles on it by hand packing and in level & lined surface in slope camber including filling the interstices between adjacent stone by spalls of proper size & wedged for right packing as directed etc. complete without cement pointing.**

1. The work shall consist of covering the slopes of guide banks, training works and road embankment with stone or boulders, over a layer of murrum bedding.
2. Stone subject to marked deterioration by water or weather will not be accepted. The stone shall be sound, hard, durable and fairly regular in shape and its thickness in any one direction shall not be less than the thickness of pitching as specified in the item and thickness of the stone at any place shall not be less by 15% of the thickness specified. The largest stones procurable shall be supplied on site. The sizes of spalls shall be minimum 25mm and shall be suitable to fill the voids in the pitching. Thickness of the pitching shall be as specified in the pitching item. ( G.C.No.SSR/2080 IB 547/28/C, dated 6<sup>th</sup> March, 1982)
3. Before laying the pitching, the sides of banks shall be trimmed to the required slope and profiles put up by means of line and pegs at intervals of 3 metres of ensure regular straight work and uniform slope throughout. Depressions shall be filled and thoroughly compacted.
4. Murrum for bedding shall be laid over the prepared base and suitably compacted to a thickness 150mm. Quality of murrum will be as per its relevant specifications.
5. The stone pitching shall commence in a trench below the toe of the slope. Stone shall be placed by derrick or by hand to the required length, thickness and depth conforming to the drawing. Stones shall be set normal to the slope and placed so that the largest dimensions is perpendicular to the face of the slope, unless such dimensions are greater than the specified thickness of pitching. The largest stones shall be placed in the bottom courses and for use as headers for subsequent course. When full depth of pitching can be formed with a single stone, the stones shall be laid breaking joints and all interstices between adjacent stones shall be filled in with spalls of the proper size and wedged in with hammers to ensure tight packing. Pitching shall be done in panles of 3.0 M x 3.0 M with a 30 CM wide and 8 Cm. deeper band all around.



6. Payment shall be made on Square Meter basis of the-finished work. If directed by the Engineer-in-charge, for measurement the materials may have to be stacked at site before laying and nothing extra will be paid to the Contractor for this stacking. Preparation of base for laying bedding shall be deemed indicated to the work.

7. The rate shall include the cost of preparing the base, putting to the profiles, providing, laying and compacting the murrum bedding and stone pitching of dry rubble as per embankment slopes to specified thickness, lines, curves, slopes levels and all labour and materials as well as tools and plant required of the work.

**1TEM-42 Providing 12 mm thick premoulded asphalt filler joints as per drawings.**

1. Open joints shall be constructed at the location as directed by the Engineer-in-charge using a wood strip metal plate or other suitable material which is subsequently removed. When removing the material, care shall be exercised to avoid chipping or breaking the corners of the concrete. The edge of the concrete, at the joints, shall be well finished. Reinforcement shall not extend across an open joint.

2. When preformed filler is to be provided, the filler shall be placed in correct position before concrete is placed against the filler. The filler material shall form part of the joint and while concreting the slab. Care shall be taken to prevent the former form being displaced, After the work is completed, the exposed face of the joint shall be cleaned of all loose materials sticking to it.

3. The material used for filling expansion joint shall be bitumen impregnated felt. Impregnated felt shall conform to the requirement of IS:1838, and shall be got approved from the Engineer-in-charge. The joint shall consist of large pieces and assembly of small places to make up the required size shall be avoided.

4. The expansion joint shall be measured in running metres. Thickness of the expansion joint will be 20 to 25 mm. Width of expansion joint shall be equal to full depth of the slab.

5. The rate shall include the cost of all materials, labour, equipments 'incidental charges for fixing the joints complete in all respects as per these specifications and as shown on the drawings.

**ITEM-43 Providing parapet of controlled cement concrete M 150 as per detailed drawing with necessary reinforcement including shuttering laying, vibrating & finishing to line level complete precast consistency.**

1. Railings shall not be placed until the centering or false work for the span has been released, and is self supporting. The type of railing to be constructed shall be as shown on the drawing. The railing shall be carefully erected true to the line and grade. Posts shall be vertical with a tolerance not to exceed 6 mm in 3 metres.

2. The portion of the railing or parapet which is to be casting in place shall be constructed in accordance with the relevant specification for reinforced cement concrete. Forms shall either be of single width boards or shall be lined with suitable materials duly approved by the Engineer-in-charge. Form joints in plane surfaces will not be permitted. All mouldings, panels in the finished work shall be constructed according to the details shown on the drawings. All corners in the finished work shall be true, sharp and clean cut and shall be free from cracks, spall or other defects.

3. Railing shall be measured in running metres.

4. The rate of railing shall include the cost of all labour, material, tools and plant required, for doing the work complete in all respects in accordance with these specifications, and as shown on the drawing.

**ITEM-44 Providing 15 mm thick cement plaster in single coat on brick/Concrete wall for interior plastering up to floor two level finished even and smooth in (i) Cement mortar 1:3 (1 cement :3 sand) (ii) Cement mortar 1:4 (1 cement :4 sand) (iii) Cement mortar 1:6 (1 cement :6 sand)**

1. For a surface which is to be subsequently plastered the joints shall be squarely raked out to a depth of 15 mm, while the mortar is still green. The raked joints shall be well brushed to remove dust and loose particles and the surface shall be thoroughly washed with water, cleaned and wetted.

2. Cement and sand shall be mixed in proportion as specified in the item, Cement and sand shall be proportioned by volume after making due allowance for bulking. The required quantity of water shall then be added and the mortar mixed to produce workable consistency.

3. The mixing shall be done intimately by hand mixing. The operation shall be carried out on a clean watertight platform, and cement and sand shall be first mixed dry in the required proportion to obtain a uniform colour and then the mortar shall be mixed thoroughly after addition of water. In case of cement mortar that has stiffened because of evaporation of water, the same shall be retamped by adding water as frequently as needed to restore the requisite consistency but this retamping shall be permitted only within thirty minutes from the time of addition of initial mixing.

4. Plastering shall be started from top & worked down All pitlog holes shall be properly filled in advance

of the plastering as the scaffolding is being taken down. Wooden screeds 75 mm wide and of the thickness of the plaster shall be fixed vertically 2.5 metres to 4 meters apart to act as gauges and guides in applying the plaster. The mortar shall be laid on the wall between the screeds using the plaster float and pressing the mortar to the raked joints are properly filled.

The plaster shall then be finished off with a wooden straight edge reaching across the screeds. The straight edge shall be worked on the screeds with a small upward and side way motion 50 mm or 75 mm at a time. Finally, the surface shall be finished off with a plaster's wooden float. Metal floats shall not be used.

5. When recommencing plastering beyond the work suspended earlier the edge of the old plaster shall be scrapped, cleaned and wetted before plaster is applied to the adjacent areas. No portion of the surface shall be left out initially or be patched by later on. The plaster shall be finished to a true and plumb surface and to the proper degree of smoothness as required by the Engineer-in-charge. The average thickness of plaster shall not be less than the thickness specified in the item with a tolerance of 3 mm thickness which appear in the surface and all portions, which sound hollow when tapped, or are found to be otherwise defective, shall be cut out in rectangular shape and re-done as directed by the Engineer-in-charge.

6. Curing shall be started as soon as the mortar used for finished has hardened sufficiently not to be damaged when watered. It shall be kept wet for a period of atleast 7 days. During this period, it shall be suitably protected from all damages.

7. Stage scaffolding shall be provided for the work. This shall be independent of the structure.

8. The work of plastering shall be measured in sq. metre of the surface treated.

9. The rate of plastering shall include the cost of all labour, materials tools and plant scaffolding and all incidental expenses as described herein above.

**ITEM-45 Box cutting of the road surface to proper, slope and camber for making a base for road work including removing the excavated stuff and depositing the road side as directed upto 50 M. lead etc. comp.**

1. Specification No. 162 and 553 of P.W.D. Hand book volume II and the following additional specifications shall be applicable here.

2. Cutting shall be done in proper grade & camber as per measurements given. Care must be taken the tall slopes are evenly and truly dressed. Cutting shall be done to the exact depth required and shall be as per formation level in proper grade and the camber. If extra depth of cutting is done due to negligence of contractor the same shall be refilled with approved quality of materials duly consolidated to the satisfaction of the Engineer-in-charge (without extra cost). Box cutting for soling and metalling in required width the depth shall be done.

3. The stuff received from the cutting shall be utilised for filling cuts and correcting side slopes of bank with all lead and lift as directed. Useful stuff shall be carefully stacked separately as directed.

4. The measurement shall be taken as per cross section measurement of the cutting based on length, breadth, depth measured with tape at every 25 metres interval.

5. The payment shall be made on Cmt. basis.

**ITEM - 46 Providing open graded carpet with Premix H.M.P. & P.P.:**

1. The work shall consist of construction in a single course of 20. 25 mm thick open graded carpet on a previously prepared base. Single course shall also include additional material @ 20% to remove unevenness of the existing surface.

Para 1 to 4 of item of semidense carpet (Item - 18) shall apply.

5. Proportioning of materials. The material shall be proportioned as quantities given below.

(a) Stone chipping 12 mm size and retained on 10 mm sieve. 67%

(b) Stone chipping 10mm size passing 12.5 mm sieve and retained on 6.3 mm sieve 33%

Para 6 to 11 of item of semidense carpet (Item - 18) shall apply.

12. Open graded carpet shall not be laid during rainy weather or when the base course is damp or wet.

13. The base on which open graded carpet is to be laid shall be thoroughly swept and scrapped clean and free of dust and foreign matter.

14. The work shall consist of application of single coat of bituminous material to an existing road surface preparatory to bituminous construction. The temperature of bitumen at the time of application shall be in the range of 160 degree centigrade to 175 degree centigrade

15. Binder shall be heated to the temperature appropriate to the grade of bitumen used and approved by the Engineer-in-charge and sprayed at the rate specified below. The rate of spread of straight run bitumen for tack coat shall be 5/10 Kg / 10 Sq. metre are for an existing B.T./W.B.M. surface. The binder shall be applied uniformly. The tack coat shall be applied, just ahead of the coming bituminous constructions.

16. The binder content for premixing shall be 3.50/3.28 percent by weight of the total mix unless otherwise specified.  
The quantities of aggregate shall be sufficient to yield the specified thickness after compaction. Para 17 to 35 of item of semi dense carpet (Item No. 18) shall apply.

36. The contract unit rate of open-graded carpet shall be paid in full for carrying out the required operations including full compensation for :

- 1 . Making arrangement of control and safety of traffic.
2. Preparation of base
3. Providing all materials to be incorporated in the works with all lead and lift.
4. All labours, tools, equipments and incidental to complete the works to the specification.

**TTEM-47 Providing & laying bituminous mix seal coat surfacing considering 0.66 cmt / 1 M.T. with m/c stone chipping as per gradation and asphalt of 4.25% by wt. of mixing by heating asphalt & mixing by continuous batching of hot mix plant and spreading by paver finisher consolidation by power roller & providing & operating plant machineries with cost of fuel, oil, lubricants etc, with sand / dust flushing at 0.30 cmt /100 smt.**

1. The work shall consist of constructing in a single course of mix seal surfacing as course on a previously prepared base of carpet single course shall also include additional thickness. If any. to remove unevenness of the existing surface.

Para 3 to 4 of item No. 18 shall apply.

5. The aggregates shall be so graded or combined as to conform to the grading as under.

Sieve Designation	Percent by weight passing Sieve for type 'A' Mix seal surfacing.
20mm	100
7.75mm	40 –85
7.36mm	5 – 10
75 micron	0 - 4

Para 6 to 11 of item of Semi-Dense carper (Item No. 18) shall apply.

12. Mix seal surfacing shall not be laid during rainy weather or when the base course is damp or wet.

13. The base on which mix seal surfacing is to be laid shall be thoroughly cleaned and free of dust and foreign matter.

14. The work shall consist of application of mix seal surfacing of single coat of bituminous mateial to an existing carpet surface preparatory to. bituminous construction. The temperature of bitumen at the time of application shall be in the range of 160 degree centigrade to 175 degree centigrade.

16. Tack coast for mix seal surfacing shall be applied as the work of laying mix seal surfacing is being preceded by a bituminous open graded carpet.

17. The binder content for pre mixing shall be 4% by weight of the total unless otherwise specified in item of schedule B of the work. Quantity of aggregate shall be sufficient to yield the specified thickness after compaction.

Para 18 to 35 of the item of Semi-dense carpet) (item 18) shall apply.

36. The contract unit rate for mix seal surfacing shall be paid in full for carrying out the required operation including full compaction for:

- 1 . Making arrangement of control and safety of traffic.
2. Preparation of base.
3. Providing all materials to be incoporated in the works with all lead and lift.
4. All labours, tools, equipments and incidental to complete the works to the specification.

**1TEM-48(A) Providing and laying 20 mm. thick (completed asphalt carpet using asphalt for tack coat at the rate of 5-10 kg./10 sq. mt. using crushed stone aggregates as per the gradation and bitumen at the rate of 3.26% by wt. of total mix for binder using hot mix plant and laid by paver finisher including consolidation by Power road roller providing and operating plant, machineries and equipment, cost of fuel oil, lubricant and charges, including flushing sand @ 0.30 cmt/100 sq. mt. at directed etc. complete.**

The specification of this item, shall be the same as per item No. 18 except for aggregate gradation and weather and seasonal limitation which shall be as below and the binder shall be as specified.

**2. Table Aggregate gradation for Asphalt carpet.**

BHAVNAGAR MUNICIPAL CORPORATION - BHAVNAGAR

<u>Sieve Size</u>	<u>% by .weight passing the Sieve</u>
20mm	100
12.5mm	70-100
10.0mm	20-40
4.75 mm	0-5
2-36 mm	

**3.1 Weather and seasonal limitation:** Carpet shall not be laid during rainy weather or when base course is damp or wet.

**ITEM-48(B) Providing and laying 25 mm. thick (completed asphalt carpet using asphalt for tack coat at the rate of 5-10 kg./10 sq. mt. using crushed stone aggregates as per the gradation and bitumen at the rate of 3.28% by wt. of total mix for binder using hot mix plant and laid by paver finisher including consolidation by Power road roller providing and operating plant, machineries and equipment, cost of fuel oil. lubricant and charges, including flushing sand & 0.30 cmt/100 sq. mt. at directed etc. complete.**

The specification of this item, shall be the same as per item No. 18 except for aggregate gradation and weather and seasonal limitation which shall be as below and the binder shall be as specified.

**2. Table Aggregate gradation for Asphalt carpet.**

<b>Sieve Size</b>	<b>% by weight passing the Sieve.</b>
20mm	100
12.5mm	70-100
10.0mm	20-40
4 75 mm	0-5
2.36mm	

3.1 Weather and seasonal limitation: Carpet shall not be laid during rainy weather or when base course is damp or wet.

**ITEM-49 (1) Surface dressing one coat with paving bitumen using 18 kg. bitumen per 10.0 Sqm. with 0.15 cum of Stone chipping 12 mm. nominal size per 10.0 sq.m of road surface excluding rolling and consolidation (stone chipping and bitumen shall be paid separately). (2) Surface dressing in two coats with bitumen using 18 Kg. per 10sqm. with 0.15 sqm of stone chipping 12mm nominal size per 10sqm. for first size 11kg. of bitumen with 0.10 cum of stone chipping 10mm nominal size per 10 sqm. of road surface for second coat excluding consolidation etc. complete, (stone chipping and bitumen shall be paid separately)**

**1. DESCRIPTION**

This work shall consist of the application of one coat of surface dressing, consisting of a layer of bituminous binder sprayed on a base prepared previously followed by a cover of stone chipping properly rolled to form a wearing course to the requirements of these specifications.

**2. MATERIALS**

2.1 Stone chipping : The machine crushed B.T. stone chipping shall consist of fairly cubical fragments of clean, hard, tough and durable rock of uniform quality throughout. These shall be obtained by crushing B T. stone. The chipping shall be free of elongated or flaky pieces, soft or disintegrated stone, salt, alkali, vegetable matter, dust and adherent coatings.

2.2 Binder : The binder shall be straight run bitumen of 80/100 or 60/70 penetration and satisfying the requirement of I.S. 73 or other type of bitumen as may be approved by the Department

Necessary storage arrangements i.e. provision of tanks etc for bulk asphalt shall be done by the contractor without any extra charges.

In the case of bitumen is to be supplied by Department in bulk at the rate and place shown in Schedule "A" for bulk asphalt, contractor shall have to make adequate arrangement for stacking bulk asphalt at plant site, according to requirement. If the asphalt is supplied as bulk on plant site, the rate of conveyance for lead difference from store to plant site shall be recovered at S.O.R. for Qty of asphalt supplied

2.3 Keeping Records : The Department shall keep a day account of the supply and use of the asphalt in separate bound register having numbered pages in the proforma prescribed by the Department. Day to day signature of the responsible contractor or his representative as may be directed by Engineer-in-charge shall be obtained in this register. The register shall be maintained by the Department and shall be produced with each bill.



**TABLE. Physical requirements of aggregates**

Sr. No.	Test	Test Method	Requirement
1	Los Angeles Abrasion Value*	IS : 2386 (Part IV)	40% Maximum
2	Aggregate Impact Value*	-do-	30% Maximum
3	Flakiness Index	IS : 2386 (Part I)	30% Maximum
4	Stripping Value	IS : 6241	25% Maximum
5	Soundness		
	(i) Loss with Sodium Sulphate 5 cycles		12%
	(ii) Loss with Magnesium		18%
6	Water Absorption	IS ; 2386 (Part III)	1% Maximum

" Aggregate may satisfy requirements of either of the two tests.

Note : If crushed slag is used. Clause 404.2 3 shall apply.

Requirements of stone chipping and binder content for surface dressing for 10 sq.mt.

Sr. No.	Type of Construction	Nominal Size of stone chipping	Specifications percent passing through Sieve and retained on Sieve	Quantity of materials	Binder content
1	Single coat surface dressing of first coating of two coat surface coating	12mm	Passing 20 mm Sieve & Retained on 10 mm Sieve	0.15 CM	18 Kg.
2	Second Coat of two coat surface dressing	10mm	Passing 12 mm Sieve & retained on 4.5mm sieve	0.10 CM	11 Kg.

### 3. CONSTRUCTION OPERATION

3.1 **Weather & seasonal limitations;** The surface dressing work shall be carried on only when the atmospheric temperature in shade is above 15°C. No bituminous materials shall normally be applied when the surface of cover material is damp. when the weather is foggy or rainy or during dust storms.

3.2 **Preparation of base :** The base on which surface dressing is to be laid shall be prepared, shaped and conditional to the specified lines, grade and cross section as directed by the Engineer-in-charge.

The surface shall be thoroughly swept and scraped cleans of dust and any other extraneous matter before the spraying of binder. As necessary the cleaning shall be Hone first with hard brushed, then with softer brushes and finally by blowing with sacks or gunny bags

3.3 **Application of binder :** Binders shall be heated to 163°C to 177°C. and sprayed on the dry surface in uniform manner with the help of self-propelled mechanical sprayers having, self-heating arrangement and bitumen pressure pump and spray nozzle bar capable of spraying bitumen uniformly at specified rate as given in above table. Excessive deposits of binder caused by stopping or starting of the sprayer or Through leakage or any other reasons shall be suitably corrected before the stone chipping are spread.

3.4 **Application of stone chippings :** The cover material i e. machine crushed B T chips of 11.2 mm nominal size shall be stacked on road side by filling standard boxes of 2.0 m x 1.50 m x 0.50 m the measurement shall be recorded in the measurement book after collection in two kilometer length is complete. The material shall be cross checked by another D .E. E. as per rules. There after, the spreading shall be allowed. The permission of Engineer-in-charge shall be obtained before spreading.

Immediately after the application of binder, stone chippings in a dry and clean, state shall be spread uniformly on the surface, preferably by means of mechanical gritter. otherwise, manually so as to cover the surface completely. If necessary, the surface shall be broomed to ensure uniform spread of chippings.

3.5 **Rolling :** Immediately alter the application of the cover material, the entire surface shall be rolled with a 8-10 tones three wheeled roller. Rolling shall commence at the edges and progress towards the center except in super elevated portions, where it shall proceed from the inner edge to the other. Each pass of the roller shall uniformly be not less than one third, of the track made in the preceding pass. While rolling is in progress additional chippings shall be spread by hand in whatever quantities required to make up irregularities. Rolling shall continue until aggregate particles are firmly bedded in the binder and present a uniform closed surface.

3.6 **Application of second coat of surface dressing :** Where surface dressing in two coats is specified the second coat shall be applied immediately after laying the first cost. The operation shall be the same as describe in para 8.3.3 to 8.3.5.

**4. OPENING TO TRAFFIC**

Traffic shall not be permitted to run on any newly surface dressed area until the following day. In circumstances, however, the Engineer-in-charge may open the road to traffic immediately after rolling, but in such cases its speed shall be limited to 16 k.m. per hour till the following day.

**5. SURFACE FINISH AND QUALITY CONTROL OF WORK**

The surface finish of construction shall conform to requirements of M.O.S.T. No. 902 Specification. Control on the quality of materials and works shall be exercised by the Engineer-in-charge in accordance with section 900.

**6. ARRANGEMENTS FOR TRAFFIC**

During the period of construction flow of traffic shall be maintained as per clause-112.

**7. MEASUREMENTS FOR PAYMENT**

Surface dressing shall be measured as finished work in square metres.

**8. RATE**

The contract until rate for surface dressing shall be payment in full for carrying out the required operations including full compensation for all components listed in item No. 1 para 2.8

**ITEM 50 Providing & laying with built up spray grout (B.S.G.) base course in one layer with asphalt for tack coat at rate of 5kg/10sq.mt and then bitumen at the rate of 15kg/10sq.mt. with 0.50 CMT aggregate per 10 SMT of road surface for first layer and then spraying over it key aggregate at the rate of 0.13 cmt per. 10 smt. including rolling and consolidation.**

**1. Description:**

This work shall consist at a one layer/two layer composite construction of compacted crushed coarse aggregates with application of bituminous binder after each layer and key aggregates on the top of the second layer, in accordance with requirement of these specifications and in conformity with the lines, grades and cross-sections shown on the drawing or directed by the Engineer-in-charge.

**2. Materials:**

2.1 **Binder** : The binder shall be straight run bitumen of a suitable grade, 60/70 or 80/100 as directed by the Engineer-in-charge, satisfying the requirements of IS-73 or approved cutback.

2.2 **Aggregates** : The aggregates shall, durable, of fairly cubical shape and free of disintegrated pieces, organic or other deleterious matter and adherent coatings. The aggregates shall preferably be hydrophobic and of low porosity.

The aggregates shall satisfy the physical requirements set fort in Annexure-B except that the upper limit for Los Angeles Abrasion Value and Aggregate impact Value shall be 50 and 40 respectively. The coarse and key aggregates for built-up spray grout shall conform to the gradings given below.

Gradings requirements of coarse and key aggregates for built-up spray grout

Steve Designation	Percent by weight passing the Sieve	
	Coarse Aggregate	Key Aggregate
50.0 mm	100	-
25.0 mm	35-70	—
20.0 mm	—	100.0
12.5mm	0-15	35-70
4.75 mm	—	0-15
2.36 mm	0-5	0-5

**3. Construction Operations**

3.1 **Weather and seasonal limitations** : Built-up spray grout shall not be constructed during rainy weather, when the base is damp or wet or when the atmospheric temperature in shade is 16°C or below.

3.2 **Preparation of base** : The base on which built-up spray grout is to constructed shall be prepared, shaped and conditioned to the specified lines, grades and cross-sections as directed by the Engineer-in-charge. The surface be thoroughly swept and scrapped clean of dust and other foreign matter.

3.3 **Tack coat**: A tack coat as per item No. 21 para 3.3 shall be applied over the base preparatory to construction of the spray grout course.

3.4 **Spreading and rolling coarse aggregates** : Immediately after the application of tack coat the coarse aggregates in a dry and clean from shall be spread uniformly, and evenly at the rate of 0.5 cum per 10 Sq. m. area. The surface of the layer shall be carefully checked with templates and all high and low spots remedied by removing or adding as may be required.

Immediately after spreading of the coarse aggregates, dry rolling shall be done with a 8-10 tonne smooth wheeled roller Rolling shall commence at the edge and progress towards the centre except in super-elevated portions where it shall proceed from the inner edge to the outer. Each pass of the roller shall uniformly overlap not less than one third of the track made in the preceding pass.

After initial rolling the surface shall be checked transversely and longitudinally with templates and any irregularities corrected by loosening the surface, adding or removing necessary amounts of aggregate followed by rolling.

Rolling shall be stopped before voids in the aggregate layer are-closed to such an extent as to prevent free and uniform penetration of the binder.

**3.5 Application of binder - First spray :** The binder shall be heated to the temperature appropriate to grade of bitumen approved by the Engineer-in-charge and sprayed on aggregate layer at the rate of 15 kg/ 10 m<sup>2</sup> (In terms of straight-run bitumen) in a uniform manner with the help of mechanical sprayers. Excessive deposits of caused by stopping or starting of the sprayers or through leakage or any other reason shall be corrected promptly.

**3.6 Spreading and rolling for coarse aggregate for the second layer :** Immediately after the first application of binder the second layer of coarse aggregates shall be spread and rolled to 3.4 above.

**3.7 Application of binder - second spray :** The second aggregate layer shall then be given a binder spray at the rate of 15 kg/10 m<sup>3</sup> (in terms, of straight-run bitumen) to 3.5 above.

**3.8 Application of key aggregate :** immediately after second application of the binder key aggregate in a clean and dry state shall be spread uniformly at the rate of 0.13 m<sup>3</sup> / 10m<sup>2</sup> so as to cover the surface completely. If necessary, the surface shall be broomed to ensure uniform application of the key aggregates. The entire surface shall then be rolled with a 8-10 tonne smooth wheeled roller. While rolling is in progress, additional key aggregates where required shall be spread by hand. Rolling shall continue until the entire course is thoroughly compacted and the key aggregates are firmly in position.

**4. Surface Finish and Quality Control :** The surface finish of construction shall conform to the requirements of 9O2 of M.O.S.T.

5. The built-up spray -grout shall be provided with final surfacing without any delay.

6. **Arrangements for Traffic :** During period of construction, arrangements of traffic shall be done as per para 112 of M.O.S.T. Specification.

7. **Measurements for Payment :** Built-up spray grout shall be measured as finished work in square meters.

8. **Rate :** The contract unit rate for built-up spray grout shall be payment in full for carrying out the required operations including full compensation for all components as follows :

(1) Providing all materials to be used in the work including royalty charges, fees, rent where necessary with all lead & lift.

(2) All labour, tools, plants, equipments and incidental to complete the work to the specification.

(3) Providing and maintaining diversion and controlling traffic.

Asphalt if used less than as specified on account of deviation in tack coat or modification in rate of asphalt consumption in the item, it will be recovered at the rate as mentioned in Schedule "A" for quantity used less.

**ITEM-51 Providing & Laying L.C.C. from working foundation & plinth.**

**(A) Providing and laying C.C. 1:5:10 (1 cement : 5 coarse sand : 10 graded stone aggregates, of 40 mm. nominal size) & curing etc. complete excluding cost of form work in foundation & plinth.**

**Material :** The specifications for graded stone shall be as per details given in the General Specification for materials attached,

**Proportions :** The concrete shall consist of one part of Cement, Five parts of Sand and Ten parts of Metal (40 to 63 mm size)

**Mixing :** Mixing of the materials shall be as thorough as possible after water is added so that every pieces of aggregate is uniformly coated by cement. The concrete must be used immediately after it is prepared and in no case shall it be used after the cement has achieved final set. Generally concrete which has been standing for more than half an hour shall not be permitted to be used.

**Laying :** The concrete must be laid gently (not dumped from height) as not to permit the segregation of the concrete.

**Consolidation :** Consolidation shall be strictly earned out. Sufficient labour shall be employed to permit ramming, rodding, spreading etc. being complete within as short time as possible causing the mortar come up. In no cases shall ramming be permitted after the cement has begun to take initial set.

**Curing** : As soon as the concrete has set sufficiently i.e. about an hour of laying the surface must be protected from rapid drying out by being covered with sand quarry dust or where possible the curing shall be done by forming pond. The watering shall be continued for at later 10 (Ten) days usually two to three weeks and where possible for longer period.

The rate includes all necessary equipment etc. complete.. Payment shall be made on cubic measurement of concrete.

The entire work shall be carried out as per the specification for PWD Hand Book Vol. 1 to the satisfaction of the Engineer-in-charge.

**(B) Providing & laying L.C.C. 1:5:10 (1 cement : 5 coarse sand : 10 graded brick bats of 40 to 50 mm. nominal size) & curing complete excluding cost of form work in foundation and plinth.**

The specification shall be same as per item No 51 (A) except that coarse aggregate shall be brick bats of 40 mm to 50 mm nominal size instead of graded metal.

**(C) Providing & laying L.C.C. 1:5:10 (1 cement : 5 coarse sand : 10 graded stone aggregate of 40 to 63 mm. nominal size) including curing etc. complete excluding cost of form an work in the foundation and plinth.**

The specification shall be same as per Hem No. 51 (A).

**ITEM-52 Whitewashing :**

**White washing with lime on wall surface two coat to give an even shade including thoroughly brooming the surface to remove all dirt, and mortar drops and other foreign matter.**

1. **General:** Lime shall be hydraulic lime of approved quality

The slaked lime, if stored, shall be kept in a weather proof and damp roof shed with impervious floor and sides to protect it against rain, moisture, weather and extraneous materials mixing with it. All lime that has been damaged to any ways shall be rejected and all rejected materials shall be removed from site of work

2. **Workmanship** : The fat lime shall be slaked at site and shall be mixed and stirred with about five liters of water and 1 Kg of unslaked lime to make a thin cream. This shall be allowed to stand for a period of 24 hours and then shall be added to each cubic meter of lime cream. Small quantity of ultra marine blue shall also be added to the last two coat of while wash solution and the whole solution shall be stirred thoroughly before use.

3. **Preparation of surface** : The surface shall be thoroughly cleaned of all dust mortar dropping and other foreign matter before white wash is to be applied. Oil or grease spots shall be removed by suitable chemicals and smooth, surface shall be rubbed with wire brush

All unsound portion of the surface plaster shall be removed to full depth of plaster in rectangular patches and plastered again after raking the masonry joints properly.

4. **Application of white wash** : On the surface so prepared the white wash shall be applied with brush. The first stroke of the brush shall be from top to downwards and another from bottom to upwards over the first stoke and similarly one stroke from the right and another from the left over the first stroke before it dries.

Each coat shall be allowed to dry before next coat is applied number of coats as specified in item shall be applied.

5. **Mode of Measurement & Payment** : All work shall be measured in the decimal system i.e. in sq meters. Deduction for pipe openings shall be made fully both sides of openings. The rates shall includes the cost of all materials, labour, scaffolding protective etc. involved in all the operations described. The rate shall be for a unit of one sq. meter.

**ITEM-53 Providing and fixing 4" (100 mm) dia. G.I. water spouts 2'6" long in CM necessary iron grating as per design etc. complete (10 CM dia pipe)**

The galvanized water spouts of the size 10 cm dia and the Galvanize iron gritting shall be o! the approved quality and type, and shad be first got approved from the Engineer-in-charge before actual use.. The G.I. pipe shall be of sufficient length projecting. Out beyond the concrete surface for sufficient discharge. Iron grating shall be fixed rigidly into the concrete. The galvanized pipe iron as well as gratings shall be painted with two coats of anticorrosive paint.

The measurement shall be recorded and paid on the basis of each Mo. of pipe fixed in position

**ITEM-54 Providing and fixing 30 cm x 22 cm x 2.5 cm thick year plate of marble stone set in cm 1:4 including finishing and engraving letters etc complete.**

Providing and fixing 30 cms x 22 cms x 2.5 cms No and year plate of marble and of standard lettering with leads or paint including finishing etc. complete.

Marble plate shall be white and of approved quality and shall be 25 mm thick and of standard size as

directed by the Engineer – in – charge of the work.

Lettering shall be done by U-shape engraving and shall be filled with black paint of approved quality, Lettering shall be done as directed by the Engineer – in – charge. The marble plate shall be fixed in neat cement at a place as directed by the Engineer – in – charge. Cement shall conform to relevant I.S. Specification.

Measurement shall be per number of marble plate fixed.

Unit rate includes cost of all material, labour etc. for complete work.

**ITEM – 55      Numbering the C.D. works with approved paint including all materials for painting etc. complete.**

Numbering the C.D. works shall be carried out as per relevant I.R.C. specification. Oil paint of approved quality and make shall be used for the purpose. Numbering shall be very neat and clean Arrow shall be marked on the Head wall in the correct direction of flow of water. Payment shall be made on the number basis. Unit rate include the cost of all materials, labours for painting & lettering as directed by Engineer – in – charge.

**ITEM – 56      Providing and fixing junction Board of R.C.C. precast as per standard design of I.R.S. including fixing in C.C. block of 1:4:8 with necessary excavation enamel painting, lettering figures etc. complete.**

1.      These boards should be fixed at a distance of 120 metre from the centre line of the crossing and they should be located on the left hand side of the road in the direction of the traffic and facing the traffic.

2.      The board will be located in such a way that the edge of the board towards the centre of the road will be at a distance of 4.57 metres from the centre of a National Highway and 3.66 meters from the centre of State Highway or Major District Road.

3.      The bottom of the board should be 1 metre above the road surface and the board shall be at right angle to the centre line of the road facing the direction of traffic.

4.      The board shall be of the size of 107 cm in length and 91 cm in height for “T” and “Y” junctions shall be 145 C.M. in length and 91 C.M. in height for cross roads.

5.      The board shall be painted by two coarse, the Board and posts shall be R.C.C. as shown in the type design.

6.      The post shall be fixed in concrete and the projection of this above the road level shall be 45 cm x 45 cm and height of 24 cms above the road level and the top to be finished in plaster from the height of 15cm.

7.      The size of letter and figures shall be 8 cm for English and 10 C.M. for devnagri and Gujarati scripts.

8.      The post shall be painted in black and white reflective strips 23 cm in height.

9.      The board shall be painted in white with border 2 C.M. wide.

10.     On this board tablets shall be painted in yellow with black and the tablets shall have 5 cm clear distance from the board.

11.     Each such tablet shall be 61 cm in length and 33 cm in height, arrow lines indicating the direction of the road at the junctions shall be painted in black and shall have a thickness of ..... C.M. for National Highway and 4 C.M. on a State Highway and a ..... C.M. for a Major district road.

12.     All letters and figures shall be painted in black.

13.     The work shall be carried out as per design as per the instructions of the Engineer – in – charges. The measurements shall be recorded and paid on number basis for board fixed in position.

**ITEM – 56 A      Providing & fixing Board of M.S. Plate with two angles iron post and fixing in C.C. Concrete 1:4:8.**

The size of the board shall be 110 cm in length & 60 cm in height. It shall be prepared from M.S. plate of 6 mm thickness. The angle iron post shall be of size 75 mm x 75 mm and 6mm thick. The length of iron post shall be 2.1 metres. The post shall be fixed to the board by welding. The welding shall be true and strong and neat in appearance.

The board shall be fixed in C.C. 1:4:8 concrete. The concrete block for each post shall be 30 cm x 30 cm in size. The depth of the concrete block shall be 85 cm of which 60 cm will be below ground and 25cm above ground level. The exposed concrete block i.e. its portion above ground level shall be neatly finished and its shape should be truly square.

The post shall be painted with two coats of paint, alternatively in black & white strips 23 cms in height after applying one coat of anticorrosive paint. The paint shall be of approved quality. The board shall be painted with colour, as directed by Engineer – in – charge. The information as per instruction of engineer-in-charge shall be written on board with letters & signs in accordance with IRC The information may be one or more of the three script. viz. Hindi, English & Gujarati.

The board shall be fixed truly vertical & workmanship of the board shall be neat, clean & good in appearance.

The measurement for payment shall be for number of board fixed in position & complete in all respect.

The unit rate includes cost of material, labour, tools, welding, concreting, painting, lettering etc.



**ITEM – 57 Providing & fixing Boundary stone as per I.R.C. type design including painting, carving, lettering etc. complete.**

**(i) Fixing earth / Fixing in C.C. 1:5:10.**

1. Boundary stone shall be of the size 20 x 15 x 75 cms true to all the faces.
2. Boundary stones shall be neatly finished shall be chisel dressed on all the sides and at top.
3. Boundary stones shall be fixed at the border line of acquired length so that the land width is properly demarcated. The width between boundary stones shall be fixed at a distance of 330 feet (100 mt) a part in the direction of length of the road.
4. The letter B.B. of (Border) as directed by the Engineer in charge shall be carved on the face of the boundary stone & letter shall be painted with black Japan.
5. The measurement shall be recorded per No. of boundary stone fixed in position and paid accordingly.

**ITEM – 58 Clearing the site before commencement and after completion of the work:**

1. Before starting the work, the site shown on plans shall be cleared of all obstructions, loose stones and materials, rubbish of all kinds as well as all trees and brush wooden except those marked for preservation, the roots being entirely grubbed up. No trees are to be cut down before obtaining the instruction from Engineer – in – charge.
2. The stuff obtained from clearance shall be stacked in such a place and in such a manner as ordered by the Engineer – in – charge and the ground shall be left in a perfectly clean condition.
3. In jungle clearing, all trees, not specifically marked for preservation, bamboos, jungle wood & brush wood shall be cut down, their roots rubbed up. All wood and material available as directed by the Engineer – in – charge.
4. All holes or hollows, whether originally or produced by digging up roots shall be carefully filled up with earth, well rammed and levelled up neatly as directed.
5. After completion of the work, but before its acceptance, the site shall be cleared of all scaffolding, surplus materials and rubbish etc. as per contract. No extra payment shall be made for site.
6. The rate for this item of work shall be for the complete job and shall be paid at the lump sum rate tendered for the work on completion of the entire work.

**ITEM – 59 Supplying and fixing rough kota stone 60 to 80 mm size including fixing in line & level etc. complete.**

The stone to be used shall be approved quality kota stone. It shall be sound, hard, durable and fairly regular in shape and its thickness of the stone at any place shall not be less b 15% of the thickness specified.

The stone shall be laid in line and level with camber as directed & set properly in sand. The whole work shall be generally carried out to the entire satisfaction of Engineer in charge of the work.

The rate shall include the cost of all materials and labour involved in all the operations described above. The kota stone flooring shall be measured in square metre correct to two places of decimal. Length and breadth shall be measured correct to be centimetre & between the finished faces of skirting or Dado and no deduction shall be made extra paid for any opening in floor of a unit of one sqm.

**ITEM – 60 Providing & laying Kota stone for kerbing on both sides of stone paving including fixing kota stone kerbing in 0.30 Mtrs. depth (Kerbing stone of 60 to 80 mm thick size) etc. complete.**

The stone shall be of approved quality kota stone. Specifications for the materials & laying as per item No.59 above. The rate shall per unit of one Rmt.

**ITEM – 61 Supplying and stacking hard murrum on site of work etc. as directed.**

1. Hard murrum should be of approved quality. Any material which is found interior shall be rejected and contractor shall remove such rejected material from the site at his own cost. The material of Hard Murrum shall be collected from quarries approved by the Executive Engineer.

2. The materials shall be got approved by the Executive Engineer prior to collection on site and shall be free from all, rubbish, dust and any organic materials as well as clods of black cotton soil. Material shall not be allowed to be collected from within the road boundary. The materials to be used shall be got tested prior to its use in road construction.

For road work complete stacking of materials as per requirement shall be carried out in 2 Km. length before spreading. The materials stacks shall be got cross checked by other Deputy Executive Engineer as per rules before spreading. The collection shall always commence at one end of K.M and be carried continuously towards the other end.

The materials shall be stacked by filling standard boxes of size 2m x 1.5m x 0.5m on a fairly level ground. It shall be stacked on road land beyond the top of the bank and on a level ground. The rate includes supplying the hard murrum with all lead and lift on road site and stacking the same in regular pharas of the required dimensions. Materials shall be collected in required quantity only at required site of work.

The payment shall be made on cubic metre basis.

**ITEM-62 White stone Bela masonry in C.M. 1:5 including curing etc. complete.**

The stone shall be fine dressed chisel draft one incl. the drafts on all beds and joints.

The stone shall be laid in regular course. The height of the course shall be as approved by the Executive Engineer. All the course shall be of same height unless otherwise ordered but no course will be thicker than any course below it. No stone shall be less in breadth than in height and less in length than twice the width.

BHAVNAGAR MUNICIPAL CORPORATION - BHAVNAGAR

The stone shall break the joints in each course and to be carried out in cement mortar 1:6 and thickness of the joints shall not be more than 10 mm. The side joints and beds of all stone shall be vertical and horizontal respectively and all stones shall be rough, true and square.

The work shall be measured and paid for cubic measurements of the work carried out as per approved drawing or as directed by the Engineer-in-charge.

**ITEM-63 40 mm. thick asphalt carpet:**

1. This work shall consist of (laying an open graded carpet of 40 mm thickness in a single course and seal coat (excluding cost of asphalt) composed of suitable small sized aggregates premixed with a bituminous binder on a previously prepared basis.

2. The materials shall be proportioned as per quantities given within the following table.

Quantities of materials required for 10 Smt. of road surface for 4 cm. thick open graded premix carpet with seal coat.

**Aggregate for carpet:**

(A) Stone chipping-20 mm size	0.27 Cum.
(B) Stone Chipping-12 mm size	0.24 Cum.
(C) Stone Chipping-10 mm size	0.06 Cum.

**Aggregate for Seal Coat :**

Stone Chipping-6mm size	0.09 Cum.
-------------------------	-----------

**Binder for premixing (Quantities in item of strengthened bitumen)**

1. For Carpet

(A) For 0.27 Cum. of 20mm size stone chipping at 48 kg./Cum.	12.96kgs
(B) For 0.24 Cum. of 12 mm size stone chipping of 52 kg./Cum	12.48 kgs
(C) For 0.06 cum of 10mm size stone chipping at 56 kg/Cum	3.36 kgs

**Seal Coat :**

For 0.09 Cum. of 6 mm size grit at 80 kg./Cum	7.20 kgs
---	----------

**36.00 kgs**

3. Carpet shall not be laid during rainy weather or when the base course is damp or wet or when the atmospheric temperature in shade is 16% degree centigrade or below.

4. The underlying base on which the bituminous carpet is to be laid shall be prepared, shaped and conditioned to the specified line, grade and cross-section as directed by the Engineer-in-charge. The surface shall be well wire cleaned with brushes. Sweeping with brooms and finally dusting with sacks as necessary.

5. **Tack coat :** This work shall consist of application of a single coat of bituminous material to an existing road surface preparatory to another bituminous construction. The temperature of bitumen at the time of application shall be in the range of 160.0 deg, centigrade.

6. Binder shall be heated to the temperature appropriate to the grade of bitumen used and approved by the Engineer-in-charge at the rate specified below. The rate of spread in terms of straight run bitumen shall be 9.75 Kgs per 10 square meter area for a surface untreated water bound macadam surface. The binder shall be applied uniformly. The tack coat shall be applied just ahead of the oncoming bituminous construction. For the purpose of calculating consumption wastage of bitumen will not be permitted beyond 2.5% Excess consumption over 2.5% will be charge at penal rate.

7. Mixers of approved type shall be employed for mixing the aggregates with the bituminous binder. The binder shall be heated to the temperature approved by the Engineer-in-charge, avoiding local overheating and ensuring a continuous supply. The aggregates shall be dried before they are placed in the mixer. After about 15 seconds of dry mixing the heated binder shall be distributed over the aggregates at the rate specified. Kerosene to an extent of 4% to 6% of asphalt shall be provided the contractor according to the requirement at the contractor cost. The mixing of binder with chipping shall be continued until the chippings are thoroughly coated with the binder. The mixing of binder with chipping shall be continued until the chippings are thoroughly coated with the binder. The mix shall be immediately transported from the mixer to the point of using suitable vehicles or wheel barrows. The vehicle employed for transport shall be clean and be covered over in transit if so directed.

8. The premixed materials shall be spread on the road surface with rakes to the required thickness and camber or distributed evenly with the help of a drag spreader, without any undue loss of time. The camber shall be checked by means of camber boards and inequalities evented out. As soon as sufficient length of bituminous material has been laid, rolling shall commence (rolling shall be done departmentally) when the roller has passed over the whole area once any. Stops or depressions which become apparent shall be corrected by removing or adding premixed materials. The contractor shall provide necessary labour for keeping the roller wheels damp during rolling so as prevent the premix from adhering to the wheels and being packed up. The edges both longitudinal and transverse of the carpet laid and compacted earlier shall be cut to their full depth so as to expose fresh surface which shall be painted with thin surface coat of appropriate binder before the new mix is placed against.

9. Seal coat: for. preparation of premix and spreading etc. para 7 & 8 above shall apply. The coat shall be applied immediately after the laying of bituminous course of carpet. Before application of seal coat materials surface shall be cleaned free of any dust of other Extraneous matter.

10. Coarse sand or stone dust flush in as the rate of 0.03 Cmt/10 Smt. Shall be done on asphalt surface at the contractor's own cost.

11. Traffic may be allowed to proceed after final rolling when the premixed material had cooled down to surrounding temperature.

12. Control on quality of works shall be exercised by the Engineer-in-charge by carrying out the following tests as shown against each.

Sr.No.	Type of Const. Material.	Test	Frequency
1	Tack Coat	(i) Binder temperature for application (ii) Rate of spread of binder of aggregate	At regular close intervals Two test per day
	Open graded premix carpet with seal coat	(i) Temperature of binder at application (ii) Binder Content (videAs/TM:D2172) (iii) Rate of spread of mixed material	At regular close intervals Two test per day for work of every 3 Km length in one lane Regular control through checks on material and layer thickness.

13. Para 13 to 17 as regards arrangements for traffic para 29 to 33 of semidense carpet shall apply.

18. Open graded carpet and seal coat shall be measured in cubic metres on the basis of stone chips actually used.

19. The contract unit rate for open grade carpet and seal coat (excluding cost of asphalt, stone chips and rolling) shall be payment in full for carrying out the required operation including full compensation for

- (1) Preparation of base.
- (2) Providing all materials like fuel, lubricants, kerosene and coarse sand or stone dust for flushing with all lead and lifts.
- (3) All labours, tools equipment and incidentals.
- (4) Making arrangements for control and safety of traffic.

**ITEM-64 Providing 75 mm thick premix asphalt macadam using 611.00 Kg. Asphalt 10.80 CU.MT. chips for 100sq.M.**

1. This work shall consist of laying an open graded carpet of 7.5 cm. thickness in a single course and seal coat (excluding cost of asphalt stone chips) composed of suitable small aggregated premixed with a bituminous binder on a previously prepared base.



BHAVNAGAR MUNICIPAL CORPORATION - BHAVNAGAR

2. The materials shall be proportioned as per quantities given in the table.

Quantities of materials required for 100 smt. of road surface for 7.5 cm thick open graded premixed cement.

<b>Aggregate for carpet</b>		
(A) Stone Chipping	40 to 50mm size	4.80 Cum.
(B) Stone Chipping	25 to 40mm size	3.60 Cum.
(C) Stone Chipping	12 to 20mm size	2.40 Cum.
	<b>Total...</b>	<b>10.80 Cum.</b>
Asphalt	611.00 Kg per 100 SM.	

3. Carpet shall be laid during rainy weather or when the base course damp or whether or when the atmospheric temperature in shade is 160 Centigrade or below.

**Asphalt Requirement**

Size of Chips	Quantity of Chips	Rate of Asphalt	Total Qty. of Asphalt.
1. Tack coat	-	73.40 Kg/Cum.	73.40
2. 50 to 40mm	4.80	48.00 Kg/Cum.	230.40
3. 40 to 20mm	3.60	58.80 Kg/Cum.	172.80
4. 20 to 10mm	2.40	56.00 Kg/Cum.	134.40
			<b>611.00 Kg.</b>

i.e. 0.611 tonnes per 100 sq. metres.

4. The under laying base on which the bituminous carpet is to laid shall be prepared , shaped and conditioned to the specified line , grade and cross section as directed by the Engineer-in –charge . The surface shall be well cleaned with brushes. Swipping with brooms and final dusting with sacks as necessary .

5 **Tack coat** : This work shall consist of application of a single coat of bituminous material to an existing road surface preparatory to another bituminous construction . The temperature of bitumen at the time of application shall be in range of 160.0 deg. Centigrade to 175.0 deg. Centigrade.

6 Binder shall be heated to the appropriate temperature grade of bitumen used and approved by the Engineer-in-charge at the rate of specified below. The rate of spread in terms of straight run bitumen shall be 611 kgs. per 100 sq. Mt . area. The binder shall be applied uniformly . Wastage of bitumen will not be permitted beyond 2.5 %

7 Mixers of approved type shall be employed for mixing the aggregate with the bitumens binder. The binders shall be heated to the temperature approved by the Engineer-in-charge avoiding local overheating and ensuring a continuous supply .The aggregates shall be dried before they are placed in the mixture. After is seconds of dry mixing the aggregates at the rate specified. Kerosene to an extent of 4 % to 6% of asphalt shall be provided by the contractor or all to the requirement at the contractors cost.

8 The premixed materials shall be spread on the road surface with rates to the required thickness and camber and distributed evenly with the help of a drag spread , without any induce loss of time. The camber shall be checked by means of camber boards and inequalities evented out . As soon as sufficient length of bituminous material has been laid rolling has pass over the wheels clean during so as to prevent the premix from adhering to the wheels and being packed up. The edge along and of carpet laid and compacted earlier shall be cut to their depth so as to expose fresh surface which will be cut to their full depth so as to expose fresh surface which shall be pointed with a thin surface coat of appropriate binder before the new mix is placed against.

Control on quality of the work shall be exercised by the Engineer – in – charge by carrying out the following tests at the frequencies shown against each.

Sr No.	Type of Const. Material.	Test.	Frequency.
1.	Tack coat for application	(i) Binder temperature (ii) Rate of spread of binder.	At regular close intervals Two test per day.
2	Open graded premix carpet with seal coat.	(i) Temperature of binder at application. (ii) Binder Content (vide As/TM:D2172) (iii) Rate of spread of mixed material.	At regular close intervals.  Two test per day for work of every 3 Km length in one line. Regular control through checks On materials and layer thickness.

13. Para 13 to 17 as regards arrangements for traffic para 29 to 33 of semi-dense carpet shall apply.

18. Open graded carpet and seal coat shall be measured in cubic metres on the basis of stone chips actually used.

19. The contract unit rate for open grade carpet and seal coat (excluding cost of asphalt, stone chips and rolling) shall be payment in full for carrying out the required operation including full compensation for

(1) Preparation of base.

(2) Providing all materials like fuel, lubricants, kerosene and coarse sand or stone dust for flushing with all lead and lifts.

(3) All labours, tools, equipment and incidentals.

(4) Making arrangements for control and safety of traffic.

**TEM-65 Earthwork in cutting including preparing the slope and camber and stacking or utilising the cutting stuff in bank as directed up to 200 mt. from the end of cutting with all lead and lift (I) Hard Murrum**

(1) Para 1 to 8 of Item "Earth work in cutting in all sort of soil" shall apply except that the work shall be carried out in hard murrum.

(9) Earth work in cutting shall be made in hard soil such as stiff heavy clay, hard shale or compact murrum, requiring grafting tool or pick or both and shovel, closely applied and gravel and rubble stone having maximum diameter direction between 75 and 300 mm and soft conglomerate. The classification of cutting shall be decided by the Engineer-in-charge and his decision shall be binding on the contractor. Mode of measurement shall be measured after removal of over burden by tucking cross section at suitable intervals in the original position before the work starts and after its completion areas. Payment shall be made in CMT basis. The rate shall include the cost of labour tools to complete the Job.

**ITEM-66 U.C.R. Masonry for super structure in C.M.:**

Para\* 1 to 14 item No. 30 of the roads specification booklet shall apply for the work of this item.

**ITEM-67 Earthwork in cutting including preparing the slope and camber and stacking or utilising the cutting stuff in bank as directed up to 200 mt. from the end of cutting with all lead and lift (I) Soft Roack (not requiring blasting)**

(1) Para 1 to 8 of Item "Earth work in cutting in all sort of soil" shall apply except that the work shall be carried out in soft rock.

(9) Earth work in cutting shall be in soft rock such as lime stone, sand stone, laterite, hard conglomerate or other soft rock which may be quarried or split with crow bars, boulders which do not require blasting and any rock which dry state may be hard, requiring blasting but which when wet becomes soft and manageable by means other than blasting. The classification shall be decided by the Engineer-in-charge and his decision shall be final and binding on the contractor.

(10) Mode of measurement shall be measured after removal of over burden by taking cross sections at suitable intervals in the original position, the work starts and after its completion and computing the volumes in cubic meter by method of average and areas, payment shall be made on CMT basis. The rate shall include the cost of labour, tools to complete the job, Name of the works :

**ITEM-68 Supplying and Stacking Rubble on site of work etc. as directed.**

The stone shall be hard, sound free from cracks decay and weathering and shall be freshly quarried from and approved quarry stone. with round surface shall be used. The stone when immersed in water for 24 hours shall not absorb water by more than 5 percent of their dry weight when tested in accordance with I.S. fl 124. The length of stone shall not exceed three times its height and the breadth on base shall not be greater than three fourth of the thickness of wall. The rubble shall be stacked on fairly levelled ground.

Stacking shall be done as per the instruction; given by Engineer-in-charge. 15% deductions for voids shall be made from the gross measurement. The payment shall be made on cubic meter basis.

**ITEM-69 Carting and stacking of scarcity hand broken metal on site with all lead including filling the boxes.**

The stone metal shall be obtained from stacking of security metal which is broken in previously scarcity period carting shall be done as per instruction of Engineer-in-charge.

Stacking shall be done by filling the standard steel boxes of 2m x 1.5 m x 0.5 m size which shall be supplied by the Department, if available, on rent otherwise contractor shall make his own arrangement and no

deduction for voids shall be made from the gross measurements. Where any doubt exists as to whether the quantity of stacks of metal in any hectometer is not confirming with the cubical content of the standard para (2m x 1.5m x 0.5 m) shall be got corrected by the contractor, if so order by the Engineer-in-charge, for which extra payment shall be claimed by the contractor. If the quantity of metal in any stack in particular Hectometer to found to be less than the standard measurement viz 1.5 cm, the entire collection the Hectometre shall be paid on the basis of the quantity so found. Regular stacks shall be done by the contractor on a fairly level ground. Stacking of the metal shall be done in a manner as directed by the Engineer-in-charge. The standard size box measurement for aggregate will be recorded as final and no subsequent change will be permitted.

The payment shall be made on cubic meter basis without deduction for voids. The contractor shall maintain all stacks in regular and proper size till the whole materials are collected, measured and finally accepted by the Department. The rate includes conveyance to the site with all lead and lift and filling the boxes including all labour, tools, equipment and other incidental expenses.

**ITEM-70 Providing and laying 50 mm thick compacted bituminous macadam with tack coat at 5 kg/10 sq. mt. using stone aggregate as per M.O.S.T. gradation specification and asphalt mixing at the rate of 4% (40 kg/H.T.) using hot mix plant and spreading the same with paver finished including consolidation with power rollers including fuel, labour charges, equipments etc. complete.**

**1. DESCRIPTION**

The work shall consist of construction, in a single course, of 50 mm/75 mm thickness of compacted crushed aggregates premixed with bituminous binder, laid immediately after mixing, on a base prepared previously in accordance with the requirement of these specification and in conformity with lines, grades and cross sections shown on the drawings or as directed by the Engineer-in-charge.

**2. MATERIALS**

2.1 **Binder** : The binder shall be straight run bitumen of a suitable grade as directed by the Engineer-in-charge complying with IS : 73

2.2 **Aggregates** : The aggregates shall consist of crushed stone, crushed gravel (shingle) or other stones. They shall be clean, strong, durable of fairly cubical shape and free of disintegrated pieces, organic and other deleterious matters and adherent coatings. The aggregates shall preferably be hydrophobic and of low porosity.

The aggregates shall satisfy the physical requirements set forth in Table hereafter.

**Table-1 PHYSICAL REQUIREMENTS OF AGGREGATES FOR BITUMINOUS MACADAM**

SR.NO.	Test	Test Method	Requirement
1	Los Angeles Abrasion Value'	IS : 2386 (part IV)	35% Maximum
2	Aggregate Impact Value*	-do-	30% Maximum
3	Flakiness Index	IS : 2386 (Part 1)	30% Maximum
4	Stripping Value	TS:6241	25% Maximum
5	Water Absorption	IS: 2386 (Part III)	2% Maximum

\* Aggregates may satisfy requirements of either of the two tests.

The aggregate for bituminous macadam for different thicknesses shall conform to the Grading A or B given in Tables 2 and 3. The actual grading to be used shall be specified in the contract).

**TABLE 2 AGGREGATES GRADING FOR 75 mm COMPACTED THICKNESS OF BITUMINOUS MACADAM**

Steve Designation	Percentage by wt. passing through Sieve	
	For typo'A'	For Type 'B'
63mm	100	-
50mm	90-100	-
40 mm	35-65	100
25mm	20-40	70-100
20mm	—	50-80
12.5mm	5-20	-
4.75 mm	—	10-30
236mm	—	5-20
75 micron	0-5	0-4

**TABLE 3 AGGREGATES GRADING FOR 50 MM  
COMPACTED THICKNESS OF BITUMINOUS MACADAM**

Sieve Designation	Percentage by wt pasting through Sieve	
	For type 'A'	For Type 'B'
50 mm	100	—
40mm	90-100	—
25 mm	50-80	100
20mm	-	70-100
12.5mm	10-30	—
10mm	-	35-60
4.75 mm	—	15-35
2.36mm	—	5-20
75 micron	0-5	0-4

**2.3 Proportioning of materials** : The binder content for pre mixing shall be 3.5 and 4.0 percent by weight of the total mix for aggregate grading A and B respectively, except when otherwise directed by the Engineer-in-charge.

The quantities of aggregates to be used shall be sufficient to yield the specified thickness after compaction.

**2.4 Variation in proportioning of material** : The Contractor shall have the responsibility for ensuring proper proportioning of materials and producing a uniform mix. A variation in "binder content of  $\pm 0.3$  percent by weight of total mix shall, however, be permissible for individual specimens taken for quality control tests vide Section 900 V

### 3. CONSTRUCTION OPERATION

**3.1 Weather and seasonal limitation** : Bituminous macadam shall not be laid during rainy weather or when the base course is damp or wet.

**3.2 Preparation of the base** : The base on which bituminous macadam is to be laid shall be prepared, shaped and conditioned to the specified lines, grades and cross sections in accordance with Clause 501', as directed by the Engineer-in-charge. The surface shall be thoroughly swept and scraped clean and free from dust and foreign matter.

**3.3 Tack coat** : A tack coat as per Clause 503' shall be applied over the base except when the laying of bituminous macadam is being preceded by a bituminous leveling course.

**3.4 Preparation and transport of mix** : Hot mix plant of adequate capacity shall be used for preparing the mix.

The temperature of binder at the time of mixing shall be in the range of  $150^{\circ}$  to  $165^{\circ}$  C, Provided that the difference in temperature between the binder and aggregate at no time exceeds  $25^{\circ}$  C.

Mixing shall be thorough to ensure that a homogeneous mixture is obtained in which all particles of the aggregates are coated uniformly.

The mixture shall be transported from the mixing plant to the point of use in suitable vehicles. The vehicles employed (or transport shall be dean and be covered over tn transit if so directed by the Engineer-in-charge.

**3.5 Spreading** :The mix shall be spread immediately after mixing by means of self propelled mechanical paver with suitable screeds capable of spreading, tamping and finishing the mix true to the specified lines, grade and cross sections. However, in restricted and in narrow widths, where the available plants cannot operate in the opinion of the Engineer-in-charge, he may permit manual laying of the mix.

The temperature of the mix at the time of laying shall be in the range of  $110^{\circ}$  to  $135^{\circ}$  C. In multi layer construction the longitudinal joint in one layer shall offset that in the layer below by about 150 mm. However, the joint in the most layer shall be at the center line of the pavement.

Longitudinal joint and edges shall be constructed true to the delineating line parallel to the centre line of the road. All joints shall be cut vertical to the full thickness of the previously laid mix and the surface painted with hot bitumen-placing fresh material.

**3.6 Rolling** : After the spreading of mix, rolling shall be done by 8 to 10 tonne power rollers or other approved plant. Rolling should start as soon as possible after the material has been spread. Rolling should be done with care to keep from unduly roughening the pavement surface.

Rolling of the longitudinal joints shall be done immediately behing the paving operation. After this the rolling shall commence at the edge and progress towards the centre longitudinally except that on super elevated portions it shall progress from the lower to the upper edge parallel to the centre line of the pavement.

The initial or break down rolling shall be done, as soon as it is possible to roll the mixture without cracking the surface or having the mix pick up on the roller wheels. The second or intermediate rolling shall follow the break down rolling as lossely as possible and be done while the paving mix is still at a temperature that will result in maximum density. The final rolling shall be done while material is still workable enough for removal of roller marks.

When the roller has passed over the whole area once, any high spots or depressions which, become apparent shall be corrected by removing or adding fresh material. The rolling shall then be continued till the entire surface has been rolled to compaction, there is no crushing of aggregates and all roller marks have been eliminated. Each pass of the roller marks have been eliminated. Each pass of the roller shall uniformly overlap not less than one-third of the track made in the preceding pass. The roller wheel shall be kept damp if necessary to avoid bituminous material from sticking to the wheels and being picked up. in no case shall fuel lubricating oil be used for the purpose.

Rolling operation shall be completed in every respect the temperature of the mix falls below 80°C.

Rollers shall not stand on newly laid material while there, is a risk that it will be deformed thereby. The edges along and transverse of the bituminous macadam laid and compacted earlier shall be cut to their full depth so as to expose fresh surface which shall be painted with a thin surface coat of appropriate binder before the new mix is placed against it.

#### **4. SURFACE FINISH AND QUALITY CONTROL OF WORK**

The surface finish of construction shall conform to the requirements of Clause 90,1.

Control on the quality of materials of materials and works shall be exercised by the Engineer-in-charge in accordance with Clause 902\*.

5. The bituminous macadam shall be provided with final surfacing without any delay. If there is to be any delay, the course shall be covered by a seal coat to the requirement of Clause 511 before allowing any traffic over it.

#### **6. ARRANGEMENTS OF TRAFFIC**

The provision of Clause 105 shall apply as regards the flow of traffic during construction.

#### **7. MEASUREMENTS FOR PAYMENT**

Bituminous macadam shall be measured as finished work in cubic metres.

#### **8. RATE**

The contract unit rate for bituminous macadam shall be payment in full for carrying out the required operations including full compensation for:

(i) making arrangements for traffic to clause 105 except for initial treatment to shoulders and construction of diversions.

(ii) preparation of base except for laying of levelling course but including filling of potholes;

(iii) providing all materials to be incorporated in the work, including all royalties, frees, rents where necessary and all leads and lifts.

(iv) all labour, tools, equipments and incidentals to complete the work to the specifications, and

(v) carrying out the work in par widths where directed.

### **ITEM-71 Providing and laying C.C. 1:5:10 (1 Cement: 5 Coarse sand : 10 graded stone aggregate of 40 mm nominal size) and curing etc. complete excluding cost of form work in foundation & plinth**

#### **1.0 Material**

##### **1. Water**

1.1 Water shall not be salty or brackish and shall be clean, reasonably clear and free from objectionable quantities of slit and traces of oil and injurious alkalis, salts organic matter and other deleterious material which will either weaken the mortar or concrete or our cause efflorescence or attack the steel in RCC contrainer for transport, storage and handling of water shall be clean water shall conform to the standards specifications in I.S. 456-1978

1.2 If required by the Engineer-in-charge it shall be tested by comparison with distilled water.

Compression shall be and means of standard cement tests for soundness, time of setting and mortar strength as specified in I.S. 269-1976. Any indication on unsoundness, change in time of setting by 30 minutes or more of decrease or more than 10 percentage of mortar prepared with water .sample when compared with the results obtained with mortar prepared with distilled wate shall be sufficient cause for rejection of water under test.

1.3 Water for curing mortar, concrete or masonry should not be too acidic or too alkaline. It shall be free of elements which significantly effect the hydration reaction or otherwise interface with the hardening of mortar or concrete during curing or those which produce objectionable stains or other unsightly deposits on concrete or

\* M.O.S.T. Specifications



mortar surfaces.

- 1.4 Hard and bitter water shall not be used for curing
- 1.5 Portable water will generally be found suitable for curing mortar or concrete.

**2.0 SAND**

2.1 Sand shall be natural sand, clean well graded, hard strong durable and gritty particles free from immures amounts of dust, clay kanker modules, soft or flaky particles shall alkali salts, organic matter, learn mica or other deleterious substance and shall be got approved from the Engineer-in-charge. The sand shall not contain more than 8 percent of slit as determined by field test. If necessary the sand.

**2.2 Course Sand**

The fineness modules of coarse sand shall not be less than 2.5 and shall not exceed 3.0. The sieve analysis of coarse sand shall be as under:-

4.75 mm	100
2.36 mm	90 to 100
1.18mm	70 to 100
600 MC	30to 100
300 MC	85 to 70
150 MC	00 to 50

**Fine Sand**

**2.3** The fineness module shall not exceed 1.0 the sieve analysis of fine sand be as unde

% by wt. passing	
1. S. Sieve Designation	% by wt. passing
4 75 mm	100
2.36 mm	100
1.18mm	75 to 100
600 MC	40 to 85
300 MC	05 to 50 '
150 MC	00 to 10

**3.0 Cement**

3.1 Cement shall be ordinary portland slab cement as per I.S. 1975 pr portlar alag cement as per I.S 455 1976

**4.0 Stone coarse Aggregate for Nominal Mix Concrete:**

Coarse aggregate shall be or machine crushed stone of black trap of equivalent and hand, strong, dense, durable, clean and free from skin and coating likely to proven! proper adhesion of mortar.

4.1 The aggregate shall be generally be cubical in shape unless special stones of particular quarries are mentioned aggregates shall be machine crushed from the best blackstrap or equivalent hard stone as approved. Aggregate shall have no deleterious reaction with cement. The size of the coarse aggregate for plain cement concrete and ordinary reinforced cement the concrete shall generally be as per the table given below. However, in case of reinforced cement concrete the Minimum limit may be restricted to 6 mm less than the minimum lateral clear distance between bars or 6 mm. less than the cover whichever is smaller.

IS Sieve Designation	Percentage passing for single sized aggregate of nominal size		
	40mm	20. mm	16 mm
80 mm	-	-	-
63 mm	100	-	-
40 mm	85-100	100	-
20mm	0-20	85-100	100
16 mm	-	-	85-100

IS Sieve. Designation	Percentage passing for single sized aggregate of nominal size		
	40 mm	20 mm	16mm
12.5 mm	-	-	-
10mm	0.5	0.20	0.30
4.75 mm	—	0.5	0.5
2.35 mm	-	-	—

Note : This percentage may be varied somewhat by the Engineer-in-charge when considered necessary containing better density and strength of concrete.

4.3 The grading test shall be taken in the beginning and at the change of source of material. This necessary that indicates in I.S. 383-1970 and I.S. 456-1978 shall have to be carried pit to ensure the acceptability. Aggregate shall be stored separately and handled in such a member as to prevent the intermixing diff. aggregate if

- M.O.S.T. Specifications

the aggregate are covered with dust. they shall be washed with water to make them clean.

**2.00 Workmanship :-**

**2.1 General :-**

2.1.1 Before starting concreting the bed of foundation trenches shall be cleared of all loose materials level watered and rammed as directed.

**2.2 Proportion of Mix :**

2.2.1 The proportion of cement sand and coarse aggregate shall be one part of cement 5 parts of sand and 10 parts of bricks bats aggregate and shall be measured by volume

**2.3 Mixing -**

2.3.1 The concrete shall be mixed in a mechanical mixer at the site of hand mixing may however be allowed for collar quantity work if approved by the Engineer-in-charge when hand mixing is permitted by Engineer-in-charge in case of break down of machineries and in the interest of work it shall be carried out on water tight platform and care shall be taken to ensure that mixing is continued until the mass is uniform in colour and consistency. However in such cases 10% more cement extra case. One mixing in mechanical mixer shall be done period of 1.5 to 2 minutes and the quantity of water shall be just sufficient to provide a dense concrete of required workability for the purpose.

**2.4 Transporting and Placing the Concrete :-**

2.4.1 The concrete shall be handled from the place of mixing to the final position in not more than 15 minutes by the method as directed and shall be placed into its final position completed and finished within 30 minutes of mixing with water i.e. before the setting commences.

2.4.2 The concrete shall be laid in layer of 15 cms to 20 cms.

**2.5 Compacting**

2.5.1 The concrete shall be rammed with heavy iron rammer and rapidly to get the required compaction and to allow all the interstices to be filled with mortar.

**2.6 Curing :-**

2.6.1 After final set the concrete shall be kept continuously wet if required by ponding for a period of not less than 7 days the date of placement

**2.7 Mode of Measurements and Payments :**

2.7.1 The concrete shall be measured for its length, Breadth and depth limiting dimensions to those specified on plan or as directed.

2.7.2 The rate shall be for a unit of one cubic meter.

**ITEM-72 Supplying and stacking unscreened gravel on site of work etc. as directed.**

The unscreened gravel shall be obtained from quarries approved by Executive Engineer prior to collection. The material shall be of approved quality with all lead and lift. The material shall be clear and free from organic material, silt, clay etc. and shall be got approved from Engineer-in-charge

Wherever any doubt exists as to whether the above requirements are satisfied in work or any part of the collection, it shall be rectified by the contractor at his own cost, if so ordered by Engineer-in-charge.

Stacking shall be done by filling in the standard steel boxes of 2 mt. X 1.5 mt. x 0.5 mt. size which shall be supplied by the department if available on rent otherwise contractor shall make his own arrangements. No deduction for voids shall be made from the gross measurement... its. Where any doubt exists as to whether the quantity of stacks of material in any hectometer is not conforming with the cubical content of the standard pharas (2 mt. x 1.5 mt. x 0.5 mt.) shall be got corrected by the contractor if so ordered by the Engineer-in-charge for which no extra payment shall be claimed by the contractor. If the quantity of material in any stack in a particular Hectometer is found to be less than the standard measurements viz. 1.5 cmt. the entire collection in the Hectometer shall be paid on the basis of the quantity so found. Regular stacks shall be done by the contractor on fairly level ground Stacking of material shall done in a manner as directed by the Engineer-in-charge.

For road work complete stacking of material as per requirements shall be carried out in 2 k.m. length before spreading. The material stacks shall be measured and recorded and got cross checked by the other Deputy Executive Engineer as per rules before spreading. The collection shall always commence at one end of the k m. and be carried out continuously towards the other end unless the Engineer-in-charge direct otherwise.

The payment shall be made on cubic metre basis without deduction for voids/ The contractor shall maintain all stacks in regular and proper size till the whole materials shall not measured and finally accepted by the Department. The spreading of materials shall not be allowed till the materials are fully stacked and completed kilometer wise.

The rate includes cost of collection, conveyance to the site with all lead and lift and filling be boxes including all labour, tools, equipments and other incidental expenses. The rates quoted are inclusive of all such tools, duties, fees, royalties, taxes etc.

**ITEM-73 Filling available excavated earth (excluding rock) in trenches, plinth, sides of foundations etc. in layers not exceeding 20 cm. in depth consolidating each deposited layer by ramming and watering.**

1.0 The earth to be used for filling shall be free from salts, organic or other foreign matter. All clods at earth shall be broken.

2.0 As soon as the work in foundation has been completed and measured, the site of foundation shall be cleared of all debris, stone, motar droppings etc and filled with earth in layers not exceeding 20 cms. each layer shall be adequately watered, rammed and consolidated before the succeeding layers is laid. The earth shall be rammed with iron rammers where feasible and with the butt ends of crow-bars where rammer can not be used. With iron rammers finished level, the surface shall be flooded with water for atleast 24 hours and allowed to dry and then rammed and consolidated.

3.0 The excavated stuff of the selected type shall be allowed to be used in tilling the trenches and plinth under no circumstances black cotton soil be used for filling.

4.0 The payment shall be made for filling in trenches and plinth. No deduction shall be made for shrinkage or voids if consolidated as instructed above.

5.0 The rate shall be for a unit of one cubic metre.

**ITEM-74 Providing and fixing junction board of M.S. Plate and angle as per standard I.R.C. design including fixing in C.C. 1:4:8 with necessary excavation, painting, lettering, figuring and lettering on board etc. complete.**

1.0 The boards shall be fixed at a distance of 120 mtr. from the centre line of the crossing and they should be located on the left hand side of the road in the direction of the traffic and facing the traffic.

2.0 The board will be located in such a way that the edges of the board towards the centre line of the road will be at a distance of 4.57 mt. from the centre of a N.H. and 3.56 mtr. from the centre of a S.H. or M.D R or as directed by the Engineer-in-charge

3.0 The bottom of the board shall be 1 m above the road surface and the board shall be at right angles of the centre line of the road facing the direction of the traffic.

4.0 The size for the junction board M.S plate and angles shall be as per standard confirming to I.R.C type design.

5.0 The board shall be fixed in concrete and the projection of this above the road level shall be 4 cms x 45 cms. and a height of 24 cms. above the road level and the top is to be finished tapering from to the height of 15 cms.

6.0 The board shall be supported by the angle iron parts of M.S. angle as shown in the standard type design.

7.0 The size of letters and figures shall be 8 cm. for English and 10 cms for Davnagri and Gujarati scripts.

8.0 The post shall be painted in black and white alternative strips of 23 cms. in height. 9.0 The board shall be painted in white with blackboard 2 cm. wide.

10.0 On this board tablets shall be painted in yellow with a black border and the tablets shall have 5 cms. clear distance from the board.

11.0 Each such tablets shall be 61 cms in length and 33 cms. in height arrow lines indicating the direction of the road at a junction shall be painted in black and shall have a thickness of 5 cms for N.H. and 4 cms of S.H and 2.5cms.for M.D.R.

12.0 All letters and figures shall be painted in black.

13.0 The work shall be carried out as per design and as per the instructions of the Engineer-in-charge.



**ITEM-75 Scarifying gravelled macadam of bitumen macadam surface 6 cm to 10 cm. depth including stacking useful materials on road side and depositing or remaining stuff.**

1.0 The layer of the existing layer metalling shall L-U excavated and shall be screened on site of work. Stacking of 75% of metal obtained from screening shall be done by filling in the standard steel boxes of 2 m x 1.5 m x 0.5 mt. size which shall be supplied by department if available on rent, otherwise contractor shall make his own arrangements. No deductions for voids shall be made from the gross measurements. Where any doubt exist as to whether the quantity of stacks of metal in any hectometer is not confirming with cubical content of the standard pharas { 2m x IS m x 0.5 m) shall be got corrected by the contractor if so ordered by the Engineer-in-charge for which no extra pavement shall be claimed by the contractor. If the quantity of metal in -any stack in a particular hectometer is found to be less then the standard measurements viz. 1.5 cmt. the entire collection in the hectometre shall be paid on the basis of the quantity so found. Regular stacks shall be done by the contractor on a tairiy level ground. Stacking of the metal shall be done in a manner as directed by the Engineer-in-charge.

2.0 The remaining material except 75% of metal obtained from screening process shall be used in embankment with all lead and lift. It shall be directly deposited at the required location in specified layers. No handling or conveyance charges shall be paid if the materials is temporarily deposited else where and subsequently convey to site of deposition. The sequence of operations should be arranged properly. Material not required for any use whatsoever may be disposed off by the contractor at his own cost in manner approved by the Engineer-in-charge The material utilised in the embankment will be deducted irom the net quantity oi earthwork in embankment arrived at within the chainage measured.

3.0 The payment shall be made on sq. mt. basis, the contractor shall maintain all stacks in regular and proper size till the whole materials shall not be measured and finally accepted by the department. The spreading of materials shall not be allowed till the materials are fully stacked and completed kilometer wise.

4.0 The rate includes the cost of scarifying macadam, screening, deposting. conveyance with all lead and lift, filling the boxes including ail labour, tools, equipments and all other incidental expenses.

**ITEM-76 Extra for dewatering in foundation etc. as directed.**

1.0 Where water is met within excavation due to stream flow, seepage, springs, rain or other reasons, the contractor shall take adequate measures such as bailing, pumbing. to keep the foundation trenches dry when so required and protect green concrete/masonry against damage by erosion or sudden rising of water level. The methods to be adopted in this regard and other details thereof shall be left to the choice of the contractor but subject to approval of Engineer-in-charge shall, however, not relieve the contractor of the responsibility for the adequacy of dewatering and protection arrangements and for the quality and safely of the work.

2.0 Pumping from the inferior of any foundation enclosure shall be done in such a manner as to preclude the possibility of movement of water through any fresh concree. No pumping shall be permitted during the placing of concrete or tot any period of atleast 24 hours thereafter, unless it is done from a suitable pump separated from the concrete work by a water height wall or other similar means.

3.0 The measurements shall be paid on Cubic Meter basis for each class of materials encountered.

4.0 The rate includes the cost of dewatering including pumping.

**ITEM-77 Supplying and stacking of rubble including rubble dumping as and where required as directed.**

1.0 Stone shall be hard, sound, free from cracks, decay and weathering and shall be freshly quarried from an approved quarry. Stone with round surface shall not be used The length of stone shall not exceed three times its height and the breadth on base shall not be greater than three fourth of the thickness of wall nor less than 15 cm. The rubble shall be stacked in chhattas manner on fairly levelled ground as and where directed as per the instruction of the Engineer-in-charge. 16% for voids shall be deducted from gross measured quantity. The rate includes all labours, materials, tools and equipments, dumping the rubble and all other incidental expenses occured. The payment shall be made on cmt. basis

**ITEM-78 Jungle cutting for road side clearance on road site as directed.**

The land width shall be cleared i.e. cutting of trees of any diameter, grass, vegetation etc. as per the instruction of the Engineer-in-charge, The wood obtained if any by clearing off the jungle shall be the property of department and the same shall be casted and stacked to the place and hand over the same to the Deputy Executive Engineer as r«r the instructions laid by him.

**CONTRACTOR'S SIGNATURE**

**EXECUTIVE ENGINEER**

**SCHEDULE FOR TESTING OF MATERIALS**

For ensuring quality control and workmanship. Various tests prescribed below for materials shall be taken at periodical intervals as stipulated below.

The materials shall be a got tested at Government recognised Laboratory, (R & B) or field Laboratory of GERI (R & B) for which 1% of the estimated amount put to Tender shall be recovered from the contractor from the R. A. bills and final bills at the testing charges shall be paid to the GERI by the Government. However if the charges increase over 1% no exceeds recovery shall be made from the contractor as per resolution of B & C Department dated 10th May. 1985 Vide TNC/1085 (4) s.

Item No as per schedule 'B'	Brief Description of Materials to be tested	Qty. of Material	Prescription of test which shall be carried out	Frequency @ which test shall be carried out	Total No. of Test to be taken
1	25 to 90 H. B Metal 40 to 63 H. B. Metal 40 to 50 M. C.Metal 20 to 50 M.C. Metal Kapachi		- Gradation Test - Impact value - Flakiness Index	(1 to 100 Cmt - 1 Test 100 to 500Cmt-3 Test 500 to 1500Cmt-5 Test 1500 to 5000 Cmt - 7 Test)	
2	Grit		- Stripping Value	— As Above —	
3	Murrum		- P.I- Value	One test per / 50 cmt	
4	Sand Quarry Spaul CBR-1test per work		- Silt Content – Gradation	One test per work One test per 200 cmt.	
5	Asphalt		1 Penetration Test as per I.S.1203  2 Ductility Test 3 Specification Gravily Test 4 Softening point Test 5 Viscosity Test	No. of Tanker                      Test 1 to 10                                      1 11 to 20                                    2 21 to 50                                    3 51 to 100                                   4 Remaining every 50 tank. 1 As per I.S. 1208 As per I.S. 1202 As per I.S. 1204 As per I.S. 1206	
6.	Tack coat		- Binder temperature for application. - Rate of spread of binder	Irregular close in intervals Two tests per day.	
7.	Carpet & seal coat mix		- grading - temperature of binder in boiler, aggregates in the dryer and mix at the time of laying and rolling (Binder content vide 45 IMD 2172)  - Rate of Spreaded mix materials	One Test on individual contituents and mixed aggregates from the dryer for each 100 tonnes of mix subject to minimum of Two tests per plant per day. One Test for each 100 tons of mix subjects to mini, of Two per day plant Regular control through checks on layer thickness.	
8	Bricks		- Water absorption Efflorence -Size -Compressive Strength	1 test per 50,000 Bricks	

**BHAVNAGAR MUNICIPAL CORPORATION - BHAVNAGAR**

Item No. As per Schedule 'B'	Brief Description of Materials to be tested	Qty of Materials	Prescription of test which shall be carried out.	Frequency @ which test shall be carried out	Total No. of Test to be taken
9.	Cement		- Consistency - Setting time - Compressive Strength - Fineness - Chemical analysis - Soundness	Upto 50 T 1 test (As per 100 T 2 tests GERt 200 T 3 tests Manual 300 T 4 tests 2002) 500 T 5 tests 800 T 6 tests 1300T 7 tests and 8 test for larger consingment	
10.	Steel		- Tensile Strength - Yield Stress - Elongation -Size	1 test / 40 tonnes / per category	
11.	C.C. cube 1:2:4		- Compressive Strength {I.S. 516 - 1959}	Qty. C.C.M <sup>3</sup> No. of test 1 to 5                    - 1 no. 6 to 15                   - 2 no. 16 to 30                 - 3 no. 31 to 50                 - 4 no. 51 & above             -4+1 (For each additional 50 M <sup>3</sup> or part thereof).	

The number of tests will be as per Manual of Quality Control or latest Govt. G.R. / Circulars will be final.

The contractor shall have to pay 1% of the estimate cost put to tender towards all testing of materials & the same shall be deducted from their bills for the works. The testing of various materials shall be carried out in GER1 and result received shall be binding to all i.e. the contractor and Govt.

Testing charges of GER1 shall be born by Govt. No refund be made nor extra charges over 1% shall be recoverable from the contractor

SIGNATURE OF CONTRACTOR

EXECUTIVE ENGINEER

## Annexure-III Technical Specification.

### 1.0 LED FIXTURES SPECIFICATIONS

The LED Street light system will have to meet the following Specifications:

#### 1.1 Electrical Specifications

Parameter	Value
input Voltage	AC 120 to 260 V
input Frequency	50 Hz+/- 3Hz
Power Factor	20.8
Usage hours	Dusk to dawn (12 hours)
Distortion Current	< 10 %
Voltage	<3%
Working humidity	10% to 90% RH

#### 1.2 LED luminaire Specification :

Life expectancy to the product at least 50,000 hrs maintaining lumen output at 70% or above compared with the luminaries initial output.

Colour temperature Minimum 4,000 K

Colour rendering index > 70%

Lumen/Watt(luminary) Lead wire with minimum 1 m long

Lamp Housing High quality housing such as pressure die cast aluminum with smooth finish powder coated for better environmental protection.

Efficiency of Driver >85%

Junction temp 65 OC

Uniformity ratio 0.4

Maintenance factor 0.8

Index of protection level IP 66

1.3 Particulars and Details to be submitted by the in order to properly assess and due diligence submissions, the proponent should provide following information on the quality and photometric of proposed luminaries.

#### 1.4 General description

Following details of the proposed luminaire shall be submitted as per Annexure I

1. Luminaire manufacturer

2 Luminaire model name

3 Wattage

4 Stated lumen output

5 IP rating

6 Lumen output ( as per LM 79 report, mentioning current in MA)

7. Lumen deprecation (L70 mentioning emperature in OC and current in mA)

8 Correlated colour temperature (CCT)

9 Colour rendering index (CRI)

9.4.2 Electrical Specifications

Electrical ratings of the proposed luminaire prod for the following criteria shall be submitted in Annexure

1. Voltage range or rating on single Phase AC

2 Amperage range or rating

3. Frequency Range

4 power factor

5 Total harmonic distortion

6 Working humidity

7 Working temprature

8 ingress protection

9 Electrical conector

10 Ability to operate under conditions of unpredictable voltage variations

Submit the information whether and how the proposed luminare product might accommodate adaptive controls that allow remote dimming or switching on, off and indicate what types of controls may beintegrated in to the proposed luminaire product

1.5 LED Chip and driver information : details to be filled up by bidder

LED Chip and driver information of the proposed luminaire product for the following criteria in Annexure .III



1. Name of the LED Chip manufacturer
2. LED chip model name and number
3. LM 80 report from the LED chip manufacturer on the lumen depreciation characteristics of the specific LED Chip employed in the proposed luminaire product
- 4 junction temperature (OC)
- 5 information on drivers employed in the proposed luminaire
- 6 Name of the manufacturer
- 7 Model name and number.
8. Expected lifetime of the LED driver used in the proposed luminaire
- 9 Estimated cost of driver replacement by your company, including component and installation cost
- 10 Name of the LED chip manufacturer

1.6 Bidder shall have to offer the following minimum warranty :

- a. Provide a five year on-site replacement warranty covering warranty covering material fixture finish and workmanship, to include transportation, removal, and installation of new products.
- b. provide five year replacement warranty for defective or non -starting LED source assemblies and all drivers.

c. Provide a five year warranty for luminaries exhibiting inadequate lumen maintenance at the end of the warranty period in compliance with the following table:

L 70 lifetime claim Min.Lumen maint @ 5Year.

30,000 Hours	80%
50,000 Hours	85.50%
1,00,000 Hours	92.50%

d. A luminaire dirt depreciation (LDD) factor may be included in the above calculation, such a value be determined by mutual agreement between AMC and the manufacturer, consistent with local ambient environmental conditions and practice.

e. A luminaries dirt depreciation (LDD) factor may be included in the above calculation, such a value be determined by mutual agreement between AMC and the manufacturer, consistent with local ambient environmental conditions and practice

f. A monitoring programme to implement 6.6(c) above will be determined by mutual agreement between AMC and the Bidder. The costs of the monitoring programme over the five year warranty period will be borne by the bidder, unless agreed otherwise by AMC and the Bidder.

g The warranty shall cover all LED light sources ( Packages or modules/arrays) including but not limited to the LED die, enclosure, and phosphor. if the expected life of the luminaire system is not maintained net of LDD, then the Bidder shall replace the light source(s) and /or luminaries as needed.

#### 1.7 Photometric information

The proponent needs to submit the following photometric

1. photometric modeling results, preferably within a LM79 report, from an independent accredited laboratory showing generic candlepower traces and isofootcandle plots for the proposed luminaries product.

2. Photometric information, data and diagrams that model the luminance flux distribution of the proposed luminaire referencing the site characteristics given in section 6.2 above. The proponent should consider the following during the modeling exercise.

- 3 Such modeling should verify that the proponent's proposed luminaire will meet Indian Roadway lighting standard IS 1944, which specifies average luminance (Eavg) and uniformity ( Emin/Eavg) for roads at the above sites.

4. Use industry accepted, standardized software like Dialux for the above modeling while modeling, a maintenance factor of 0.8 should be used.

Note: the proponent needs to submit a soft copy of the IES file of the proposed luminaire along with the bid

#### 1.8 Lumen maintenance statement

1. The proponent must submit a lumen maintenance statement that estimates how many operating hours can be expected from the proposed luminaire product until its light output declines to 70% of its initial output (L70) given the specific climactic character, including extremes of temperature and high humidity, associated with the thane local condition.

2. The lumen maintenance statement should also clearly explain that how or what method was used to determine the rated life time.

3. Describe in details the thermal management: how the physical and thermal design of the luminaire will prevent the LED chips from overheating on extremely hot days.

4. Other trials or pilot projects: submit information and contacts for other relevant trials in which the proponent's proposed luminaire product, or similar products sold by the agency have been tested in the field.

5. Such information should include : LM 80 report for the LED chip package employed in the product

illuminance or luminance measurements, if available, taken over a minimum of two years of operation from pilot projects that have tested the proposed luminaire product, or a similar luminaire product, in the field .

1.9 Luminaire Specifications - others

The proponent shall provide information and certifications

1. Luminaries : General Requirements, Tests, and Certifications specified in IS 10322
2. Electrical safety certifications such as ISI and CII
- 3 ingress protection certification IP 66

Superintending Engineer,(Elect)  
R & B Deptt. Gandhinagar





PLAN

**CLIENT**  
 BHAVNAGAR MUNICIPAL CORPORATION

**TITLE**  
 DOG HOME SHELTER

**DRAWN BY**  
 Ar. Devanshi.R

**CHECKED BY**

**DATE**  
 17-06-2024

**REVISED DATE**  
 29-03-2024    29-04-2024

COPYRIGHT © MANISH RUPARELIA  
 THIS IS DRAWING IS AN INSTRUMENT OF  
 SERVICE AND IS THE SOLE PROPERTY OF  
 MANISH RUPARELIA. ANY USE OF THIS  
 DRAWING WITHOUT WRITTEN CONSTAT BY  
 MANISH RUPARELIA IS PROHIBITED.

**ALTERNATE NO.**  
 00

**MANISH RUPARELIA PVT.LTD.**  
 PLANNER-INTERIOR- INFRASTRUCTURE &  
 PROJECT MANAGEMENT CONSULTANT & VALUERS

901-902, Time Square,  
 Ayodhya Circle, 150 Feet Ring road,  
 Rajkot-360006.  
 Mo. :- 9374107306

web: [www.manishruparelia.in](http://www.manishruparelia.in)  
 e-mail: [rupareliamanish@hotmail.com](mailto:rupareliamanish@hotmail.com)

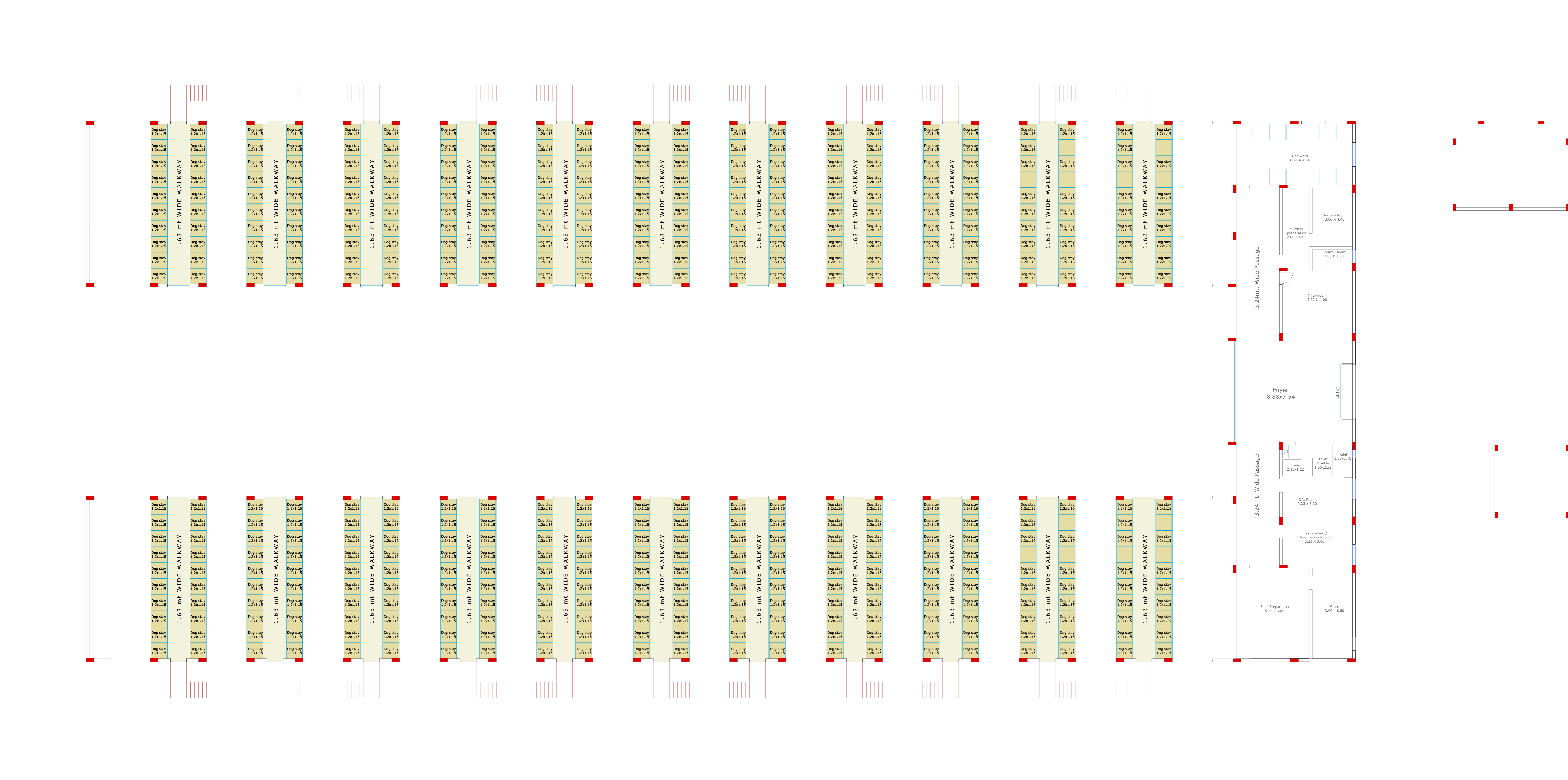

PLAN

**CLIENT**  
 BHAVNAGAR MUNICIPAL CORPORATION

**TITLE**  
 DOG HOME SHELTER

**DRAWN BY** Ar. Devanshi.R

**CHECKED BY**

**DATE** 29-04-2024

**REVISED DATE** 29-03-2024 29-04-2024

COPYRIGHT © MANISH RUPARELIA  
 THIS IS DRAWING IS AN INSTRUMENT OF  
 SERVICE AND IS THE SOLE PROPERTY OF  
 MANISH RUPARELIA. ANY USE OF THIS  
 DRAWING WITHOUT WRITTEN CONSTAT BY  
 MANISH RUPARELIA IS PROHIBITED.

**ALTERNATE NO.**  
 00

**MANISH RUPARELIA PVT.LTD.**

PLANNER-INTERIOR- INFRASTRUCTURE &  
 PROJECT MANAGEMENT CONSULTANT & VALUERS

901-902, Time Square,  
 Ayodhya Circle, 150 Feet Ring road,  
 Rajkot-360006.  
 Mo. :- 9374107306

web: www.manishruparelia.in  
 e-mail: rupareliamanish@hotmail.com



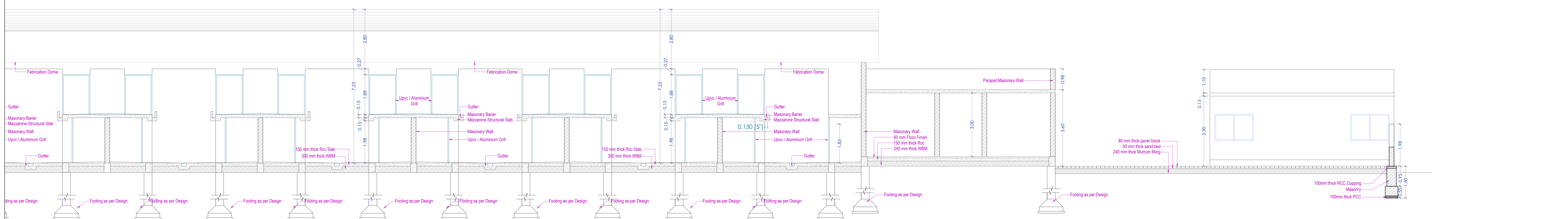
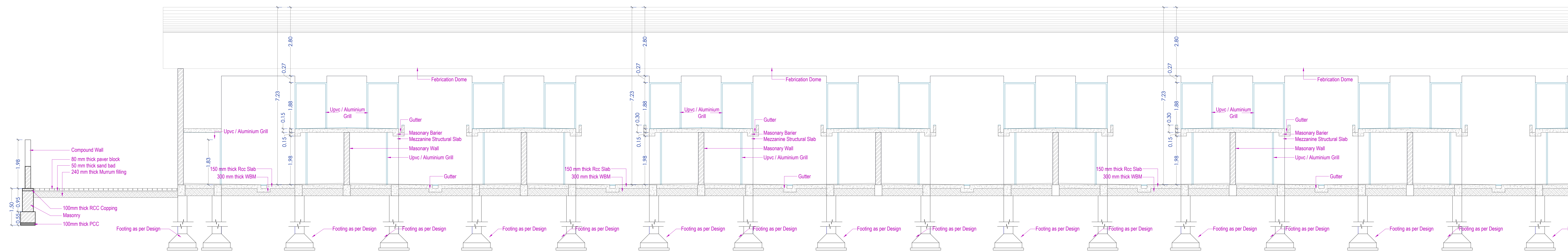

Sections

<b>CLIENT</b>
BHAVNAGAR MUNICIPAL CORPORATION
<b>TITLE</b>
<b>DOG HOME SHELTER</b>

<b>DRAWN BY</b>	Ar. Devanshi.R
<b>CHECKED BY</b>	
<b>DATE</b>	29-04-2024
<b>REVISED DATE</b>	29-03-2024    29-04-2024



**MANISH RUPARELIA PVT.LTD.**

PLANNER-INTERIOR- INFRASTRUCTURE &  
PROJECT MANAGEMENT CONSULTANT & VALUERS

901-902, Time Square,  
Ayodhya Circle, 150 Feet Ring road,  
Rajkot-360006.  
Mo. :- 9374107306

web: [www.manishruparelia.in](http://www.manishruparelia.in)  
e-mail: [rupareliamanish@hotmail.com](mailto:rupareliamanish@hotmail.com)

COPYRIGHT © MANISH RUPARELIA  
THIS IS DRAWING IS AN INSTRUMENT OF  
SERVICE AND IS THE SOLE PROPERTY OF  
MANISH RUPARELIA. ANY USE OF THIS  
DRAWING WITHOUT WRITTEN CONSTAT BY  
MANISH RUPARELIA IS PROHIBITED.

<b>ALTERNATE NO.</b>	
00	





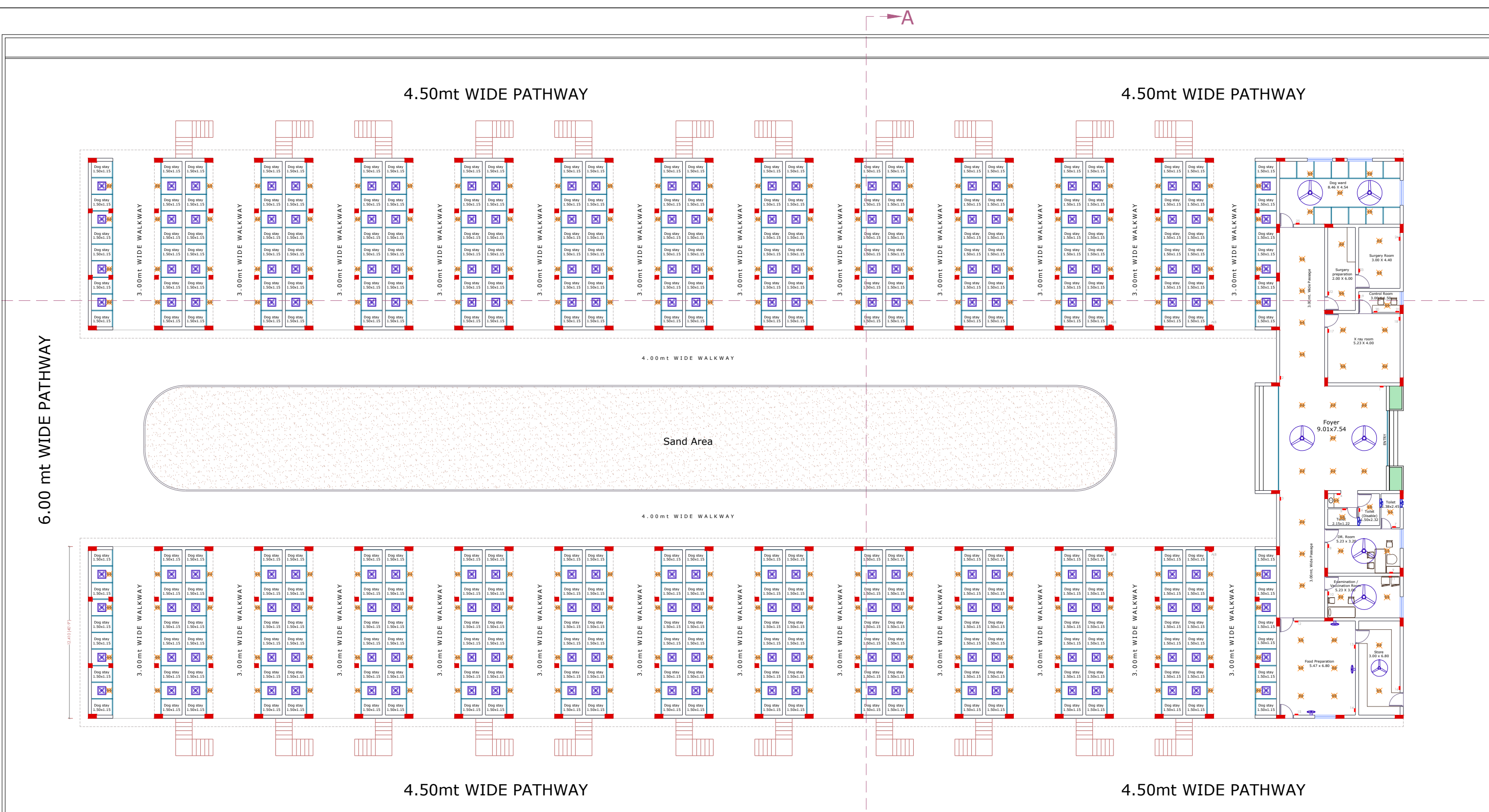

PLAN

<b>CLIENT</b>	<b>DRAWN BY</b>	Ar. Devanshi.R	
BHAVNAGAR MUNICIPAL CORPORATION	<b>CHECKED BY</b>		
<b>TITLE</b>	<b>DATE</b>	19-04-2024	
PROPOSED DOG HOME SHELTER & ANIMAL VACCINATION CENTRE AT NARI ROAD, KUMBHARWADA, BHAVNAGAR	<b>REVISED DATE</b>		
Z:\02_P R O J E C T - M.R. Pvt. Ltd\BHAVNAGAR MUNI. CORPORATION\002-DOG HOME SHELTER\SKETCH PLAN\004_sketch plan_recover.dwg	COPYRIGHT © MANISH RUPARELIA THIS IS DRAWING IS AN INSTRUMENT OF SERVICE AND IS THE SOLE PROPERTY OF MANISH RUPARELIA. ANY USE OF THIS DRAWING WITHOUT WRITTEN CONSTANT BY MANISH RUPARELIA IS PROHIBITED.	<b>ALTERNATE NO.</b>	 <p><b>MANISH RUPARELIA PVT.LTD.</b>          PLANNER-INTERIOR- INFRASTRUCTURE &amp; PROJECT MANAGEMENT CONSULTANT &amp; VALUERS          901-902, Time Square,          Ayodhya Circle, 150 Feet Ring road,          Rajkot-360006.          Mo. :- 9374107306          web: www.manishruparelia.in          e-mail: rupareliamanish@hotmail.com</p>

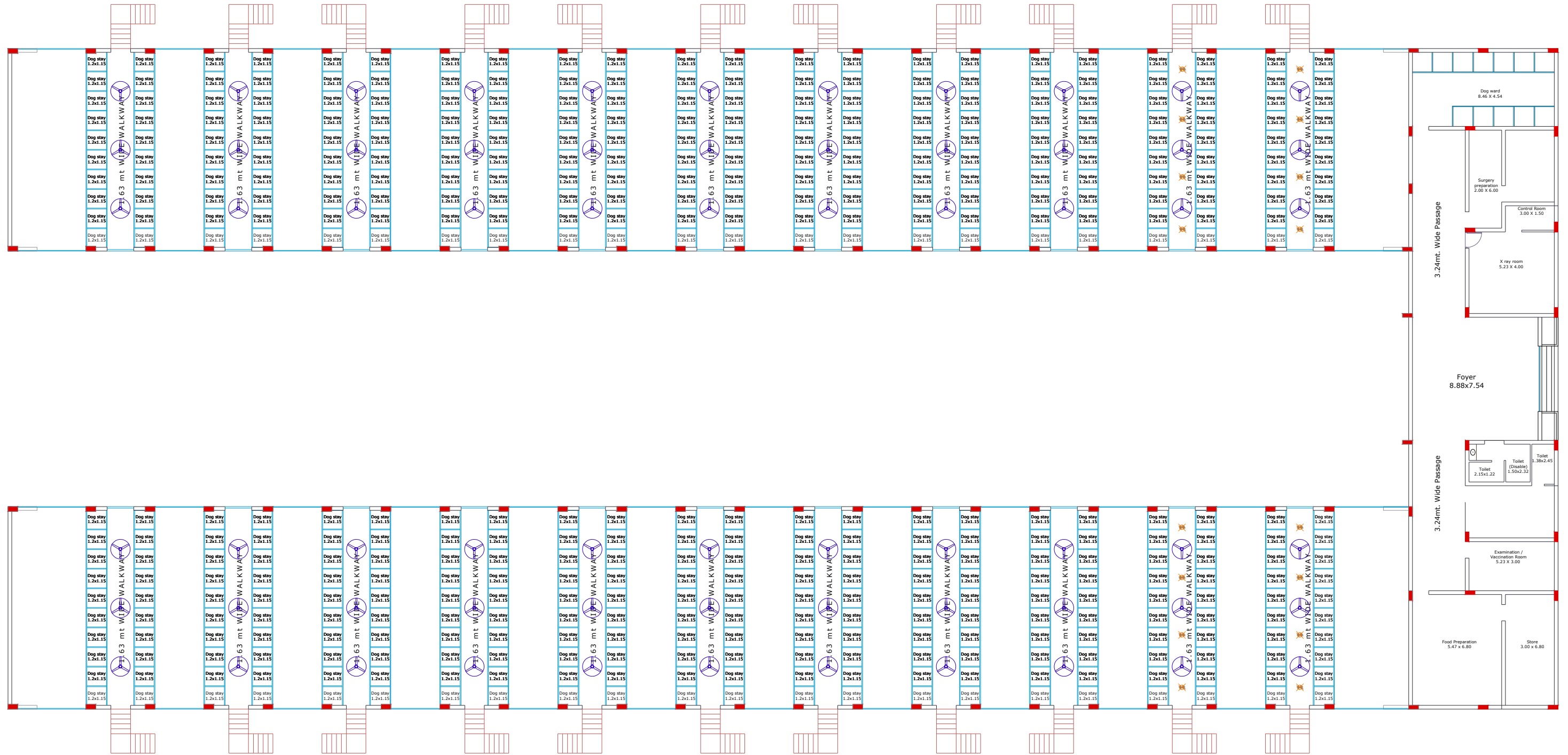

PLAN

**CLIENT**

BHAVNAGAR MUNICIPAL CORPORATION

**TITLE**

PROPOSED DOG HOME SHELTER & ANIMAL VACCINATION CENTRE AT NARI ROAD, KUMBHARWADA, BHAVNAGAR

Z:\02\_P R O J E C T - M.R. Pvt. Ltd\BHAVNAGAR MUNI. CORPORATION\002-DOG HOME SHELTER\SKETCH PLAN\004\_sketch plan\_recover.dwg

**DRAWN BY**

Ar. Devanshi.R

**CHECKED BY**

**DATE**

19-04-2024

**REVISED DATE**

COPYRIGHT © MANISH RUPARELIA THIS IS DRAWING IS AN INSTRUMENT OF SERVICE AND IS THE SOLE PROPERTY OF MANISH RUPARELIA. ANY USE OF THIS DRAWING WITHOUT WRITTEN CONSTANT BY MANISH RUPARELIA IS PROHIBITED.

ALTERNATE NO.

00

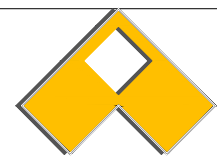

**MANISH RUPARELIA PVT.LTD.**

PLANNER-INTERIOR- INFRASTRUCTURE & PROJECT MANAGEMENT CONSULTANT & VALUERS

901-902, Time Square,  
Ayodhya Circle, 150 Feet Ring road,  
Rajkot-360006.  
Mo. :- 9374107306

web: [www.manishruparelia.in](http://www.manishruparelia.in)  
e-mail: [rupareliamanish@hotmail.com](mailto:rupareliamanish@hotmail.com)

**PILE FOR COLUMN C2 & COLUMN 1 TO 37**

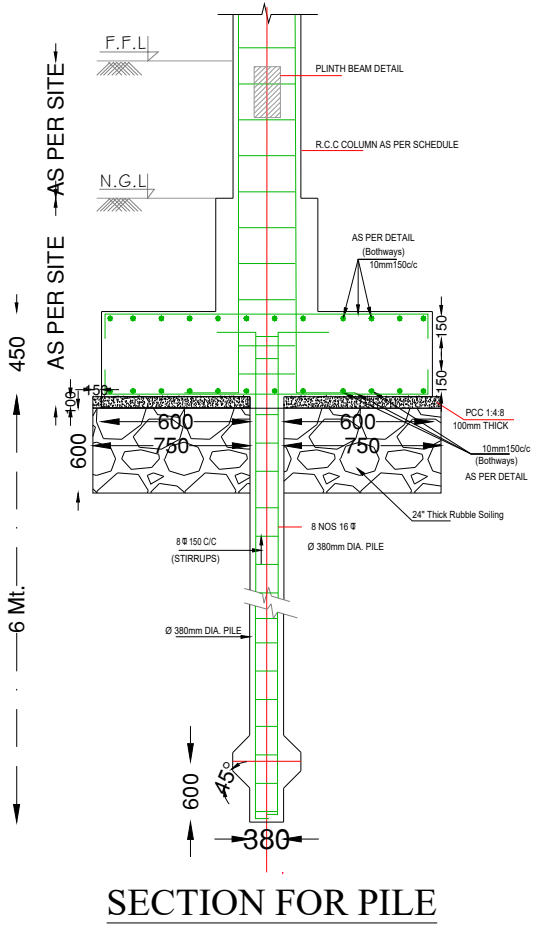
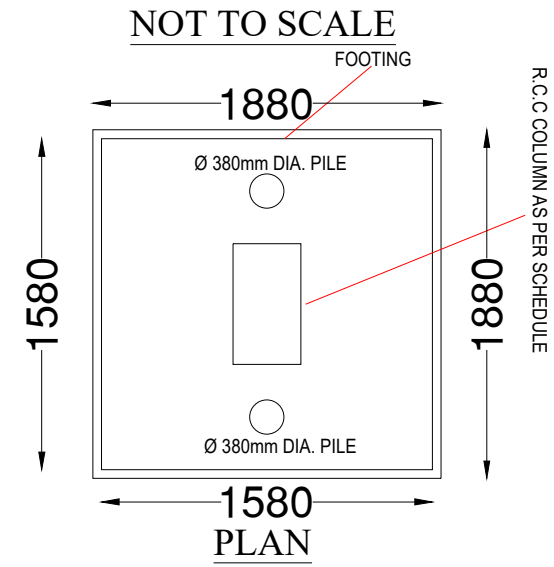

**PILE FOR COLUMN C1**

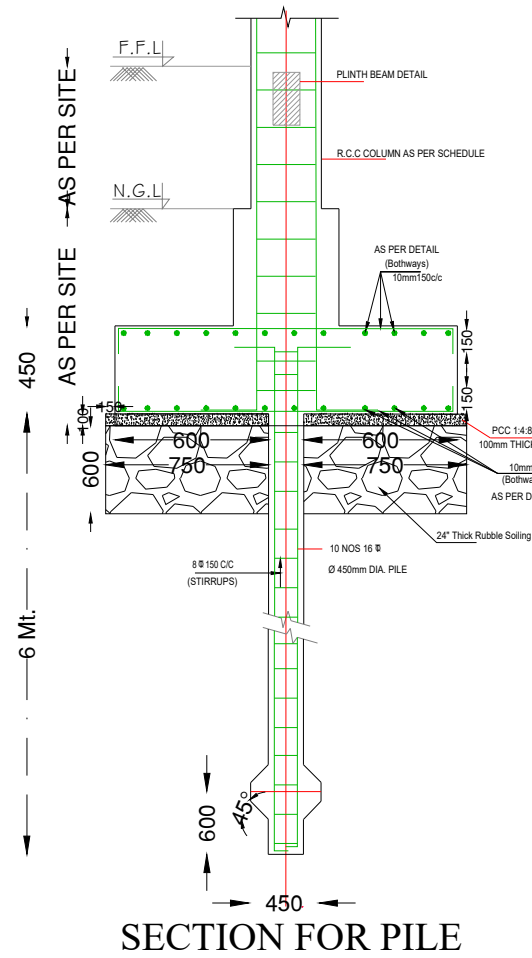
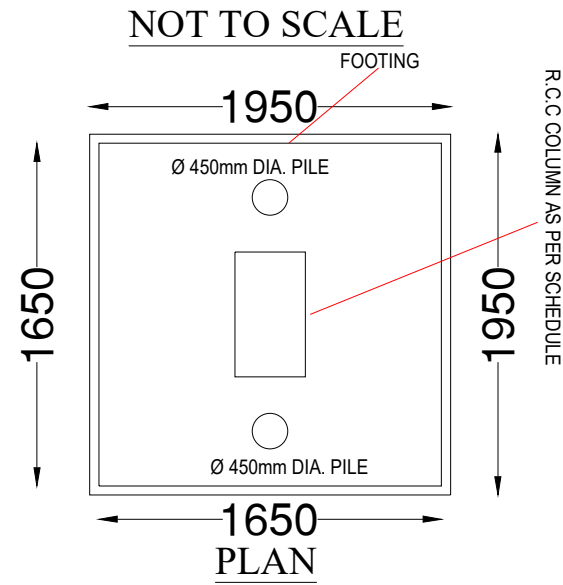

**PILE FOR COLUMN CW1**

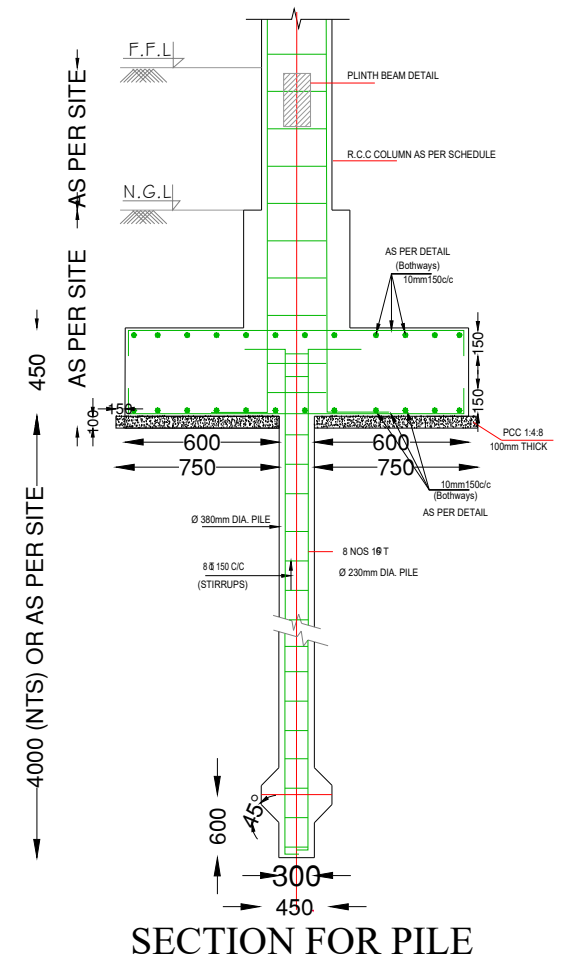
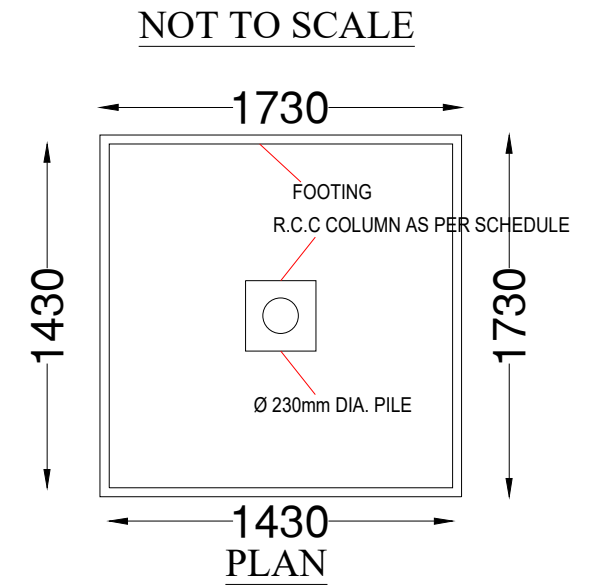

**CLIENT**

BHAVNAGAR MUNICIPAL CORPORATION

**TITLE**

**DOG FRIENDLY CENTER**

Z:\02\_P R O J E C T - M.R. Pvt. Ltd\BHAVNAGAR MUNI. CORPORATION\002-DOG HOME SHELTER\STRUCTURE DESIGN\RECEIVE\DOG FRIENDLY CENTER BHAVNAGAR...REVI.COL & FOOTING.dwg

**DRAWN BY**

Ar. Devanshi.R

**CHECKED BY**

**DATE**

31-08-2024

**REVISED DATE**

COPYRIGHT © MANISH RUPARELIA THIS IS DRAWING IS AN INSTRUMENT OF SERVICE AND IS THE SOLE PROPERTY OF MANISH RUPARELIA. ANY USE OF THIS DRAWING WITHOUT WRITTEN CONSTANT BY MANISH RUPARELIA IS PROHIBITED.

ALTERNATE NO.

**00**

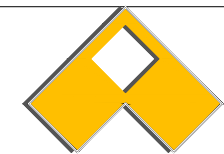

**MANISH RUPARELIA PVT.LTD.**

PLANNER-INTERIOR- INFRASTRUCTURE & PROJECT MANAGEMENT CONSULTANT & VALUERS

901-902, Time Square,  
Ayodhya Circle, 150 Feet Ring road,  
Rajkot-360006.  
Mo. :- 9374107306

web: [www.manishruparelia.in](http://www.manishruparelia.in)  
e-mail: [rupareliamanish@hotmail.com](mailto:rupareliamanish@hotmail.com)

# COMPOUND WALL COLUMN AT EVERY 12'0" C/C

# SECTION OF CONCENTRIC #  
# COLUMN & FOOTING #

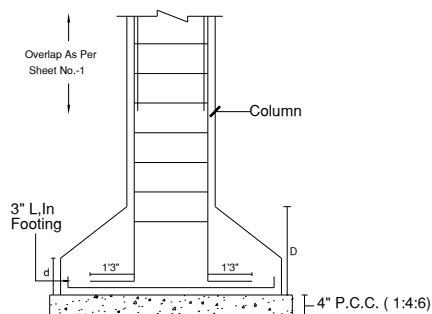

Sectional Elevation

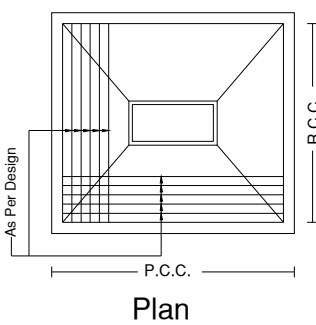

Plan

COLUMN NO. :-

# SECTION OF ONE SIDE ECCENTRIC #  
# COLUMN & FOOTING #

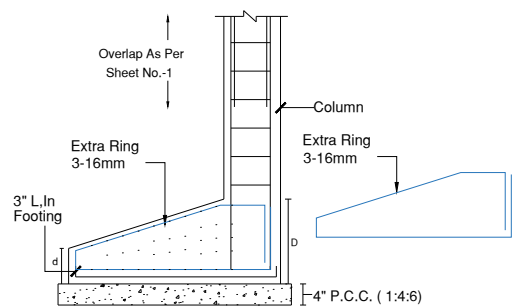

Sectional Elevation

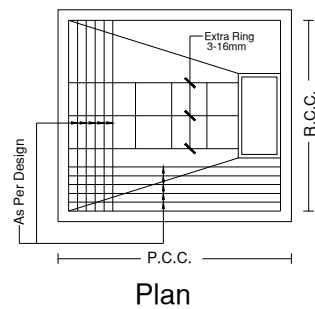

Plan

UP TO GROUND LEVEL	SIZE	9" X 15"
	VERT STEEL	6-@12mm
	CONC MIX	M-20
	STIRRUPS	8mm6"c/c
	AS PER 13920	AS PER DRG,
FOUNDATION	SIZE LXB	1430 X 1430
	DEPTH (D)	450
	PEDESTA (d)	450
	STEEL	10mm150c/c Both-Way (Top Steel) 10mm150c/c Both-Way (Bottom Steel)
	P.C.C.	1730 X 1730
	CONCRET	M-20
	COLUMN MARK	<b>CW1</b>

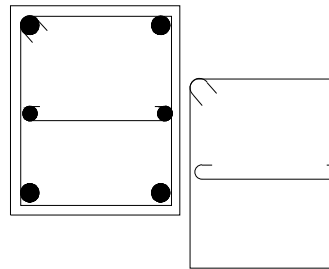

NOTES:-

PH: C- (9099448051)

REVISIONS :-

DATE

DRG.NO.

Name Of Work  
Structural detail of Resi./Comm.  
COLUMN & FOOTING

Note:- Refer notes from dwg. no.-1

ARCHITECT/ENGINEER  
MANISH RUPARELIA

CLIENT  
DOG FRIENDLY CENTER BHAVNAGAR

**CLIENT**

BHAVNAGAR MUNICIPAL CORPORATION

**TITLE**

**DOG FRIENDLY CENTER**

**DRAWN BY**

Ar. Devanshi.R

**CHECKED BY**

**DATE**

31-08-2024

**REVISED DATE**

COPYRIGHT © MANISH RUPARELIA  
THIS IS DRAWING IS AN INSTRUMENT OF  
SERVICE AND IS THE SOLE PROPERTY OF  
MANISH RUPARELIA. ANY USE OF THIS  
DRAWING WITHOUT WRITTEN CONSTAT BY  
MANISH RUPARELIA IS PROHIBITED.

ALTERNATE  
NO.

**00**

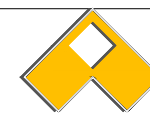

**MANISH RUPARELIA PVT.LTD.**

PLANNER-INTERIOR- INFRASTRUCTURE &  
PROJECT MANAGEMENT CONSULTANT & VALUERS

901-902, Time Square,  
Ayodhya Circle, 150 Feet Ring road,  
Rajkot-360006

No. :- 9374107306

web: www.manishruparelia.in  
e-mail: rupareliamanish@hotmail.com



PLAN

**CLIENT**

BHAVNAGAR MUNICIPAL CORPORATION

**TITLE**

**DOG FRIENDLY CENTER**

Z:\02\_P R O J E C T - M.R. Pvt. Ltd\BHAVNAGAR MUNI. CORPORATION\002-DOG HOME SHELTER\STRUCTURE DESIGN\RECEIVE\DOG FRIENDLY CENTER BHAVNAGAR...REVI.COL & FOOTING.dwg

**DRAWN BY**

Ar. Devanshi.R

**CHECKED BY**

**DATE**

31-08-2024

**REVISED DATE**

COPYRIGHT © MANISH RUPARELIA  
THIS IS DRAWING IS AN INSTRUMENT OF  
SERVICE AND IS THE SOLE PROPERTY OF  
MANISH RUPARELIA. ANY USE OF THIS  
DRAWING WITHOUT WRITTEN CONSTANT BY  
MANISH RUPARELIA IS PROHIBITED.

**ALTERNATE NO.**

**00**

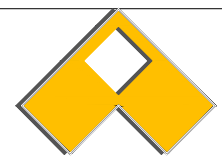

**MANISH RUPARELIA PVT.LTD.**

PLANNER-INTERIOR- INFRASTRUCTURE &  
PROJECT MANAGEMENT CONSULTANT & VALUERS

901-902, Time Square,  
Ayodhya Circle, 150 Feet Ring road,  
Rajkot-360006,  
Mo. :- 9374107306

web: [www.manishruparelia.in](http://www.manishruparelia.in)  
e-mail: [rupareliamanish@hotmail.com](mailto:rupareliamanish@hotmail.com)

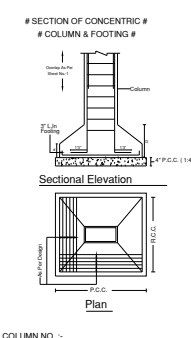
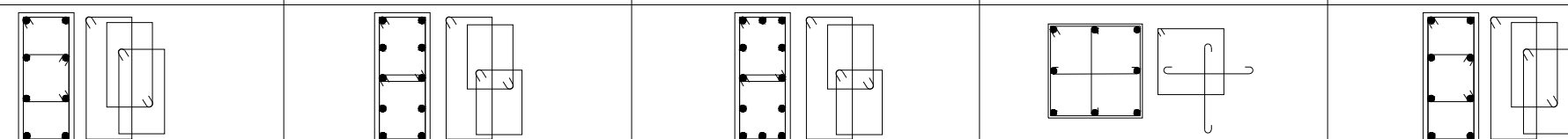
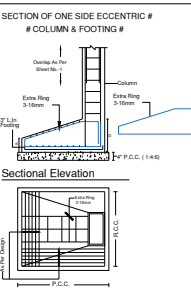
SECTION	UP TO FIRST LEVEL					
	SIZE	VERT STEEL	CONC MIX	STIRRUPS	AS PER 13920	
# SECTION OF CONCENTRIC # # COLUMN & FOOTING # 	SIZE	9" X 24"	9" X 24"	12" X 24"	12" X 12"	9" X 18"
	VERT STEEL	4-@16mm +4-@12mm	6-@16mm(a) +4-@12mm	12-@16mm	8-@12mm	8-@12mm
	CONC MIX	M-25	M-25	M-25	M-25	M-25
	STIRRUPS	8mm6"/c/c	8mm6"/c/c	8mm6"/c/c	8mm6"/c/c	8mm6"/c/c
	AS PER 13920	AS PER DRG,	AS PER DRG,	AS PER DRG,	AS PER DRG,	AS PER DRG,
						
# SECTION OF ONE SIDE ECCENTRIC # # COLUMN & FOOTING # 	SIZE LXB	1580 X 1580	1580 X 1580	1650 X 1650	1580 X 1580	1580 X 1580
	DEPTH (D)	450	450	450	450	450
	PEDESTA (d)	450	450	450	450	450
	STEEL	10mm150c/c Both-Way (Top Steel) 10mm150c/c Both-Way (Bottom Steel)	10mm150c/c Both-Way (Top Steel) 10mm150c/c Both-Way (Bottom Steel)	10mm150c/c Both-Way (Top Steel) 10mm150c/c Both-Way (Bottom Steel)	10mm150c/c Both-Way (Top Steel) 10mm150c/c Both-Way (Bottom Steel)	10mm150c/c Both-Way (Top Steel) 10mm150c/c Both-Way (Bottom Steel)
	P.C.C.	1880 X 1880	1880 X 1880	1950 X 1950	1880 X 1880	1880 X 1880
	CONCRET	M-25	M-25	M-25	M-25	M-25
COLUMN MARK	G+1	1,2,3,4,5,6,7,8,9,10,17, 18,19	11,12,13,14,15,16,20,21, 22,23,24,25	C1	C2	26,27,28,29,30,31,32,33, 34,35,36,37
NOTES:-						

**NOTES -1:-**  
 1. OUR RESPONSIBILITY SHALL REMAIN LIMITED TO SAFE AND SOUND STRUCTURAL DESIGN AS TRANSMITTED BY THIS DRAWING AND WE SHALL NOT REMAIN RESPONSIBLE FOR:  
 a) SAFETY OF OLD STRUCTURE DURING DEMOLITION.  
 b) SAFETY OF ANY ADJOINING BUILDING / PERSONS STAYING IN ADJOINING BUILDING-PERSONS & PROPERTIES ON ADJOINING ROADS.  
 c) SAFETY OF CONSTRUCTION WORKER/ANY PERSONNEL AT WORK SITE DURING CONSTRUCTION.  
 d) CORRECTNESS / SAFETY OF ANY TEMPORARY STRUCTURE, SCAFFOLDING, SHUTTERING.  
 e) ACCIDENT OCCURRING DUE TO PREMATURE DESHUTTERING FAULTY / SUBSTANDARD CENTERING ERECTED @ SITE AND ANY INJURY TO ANY PERSONNEL ARISING OUT OF CONSTRUCTION MATERIAL OR WORKMANSHIP / FAULTY CONSTRUCTION PROCEDURE. THEIR ACCIDENTS.  
 f) ANY ACCIDENT OCCURRING DUE TO CONSTRUCTION OF ELEMENTS OF BUILDINGS NOT DESIGN BY US. MATERIAL OR WORKMANSHIP / FAULTY CONSTRUCTION PROCEDURE.  
 2. SUPERVISION IF SPECIFICALLY ASKED FOR WILL BE PROVIDED TO THE EXTENT OF VERIFICATION OF REINFORCEMENT ON SITE BUT RESPONSIBILITY REGARDING CORRECT & SOUND CONSTRUCTION SHALL SOLELY REST WITH CONTRACTOR / BUILDER / OWNER.  
 3. ALL STRUCTURAL CONCRETE SHOULD BE WEIGH BATCHED, MACHINE MIXED & MECHANICALLY VIBRATED.  
 4. ANY DISCREPANCY BETWEEN OUR DRAWING & ARCHITECT/ENGINEERS DRAWING SHALL BE BROUGHT TO OUR NOTICE BEFORE CONSTRUCTION.  
 5. THIS DRAWING IS PROPERTY OF FRAMES (STRUCTURAL CONSULTANT) AND SHALL NOT BE REPRODUCED OR USED WITHOUT EXPLICIT PERMISSION OF THIS OFFICE

**NOTES:-**  
 1) THIS DRAWING TO BE CHECKED & CORRELATED WITH ARCH DRG. & TO BE READ ALONG WITH ARCH DRAWING FOR DIMENSIONS, COLUMN LOCATIONS, CENTRE LINE, LEVELS, ELEV. TREATMENTS, OPENSPACES, CUTOUTS, SUNKEN SLABS, ELEVATIONAL SLABS LEVELS, ETC. DO NOT SCALE THE DRG. ONLY WRITTEN DIMENSIONS SHALL BE FOLLOWED.  
 2) WORK SHOULD BE CARRIED OUT ONLY AFTER THE APPROVAL OF PLANS FROM AUTHORITIES AND ARCHITECT/ENGINEERS APPROVAL.  
 3) SBC CONSIDERED AS 17MG AT 1.5M TO 1.8M FROM EXISTING GROUND LEVEL AND FOOTING TO BE RESTED ON HARD ROCK.  
 4) CUBE & STEEL TESTING RESULTS TO BE SUBMITTED IN OUR OFFICE.  
 5) FOR SIMPLY SUPPORTED & CONTINUOUS BEAMS, BOTTOM BARS TO BE LAPPED NEAR SUPPORTS & TOP BARS TO BE LAPPED AT THE CENTRE.  
 6) GRADE OF THE CONCRETE MIM. M-20 & STEEL Fe-500 UNLESS NOTED.  
 7) CONCRETE COVER  
 Clear Cover for Main Steel Shall Be: a) Foundation = 50mm b) Column = 40mm  
 c) Beam = 25mm c-1) Plinth beam = 35mm d) Slab = 20mm d-1) Shear wall = 25mm g) Footing pilecap = 75mm h) Raft slab = 30mm.  
 Bond Length / Lap Length / Development Length L:  
 a) 41 X Dia. of Bar for M25 (1:1.2)  
 b) 47 X Dia. of Bar for M20 (1:1.5:3)  
 c) 57 X Dia. of Bar for M15 (1:2:4)  
 7a) CONCRETE GRADE: M-10 - 1:3:6; M-15 - 1:2:4; M-20 - 1:1.5:3; M-25 - 1:1:2  
 7b) TIME OF CENTRING OPEN:  
 a) Column minimum 24 to 48 hours  
 b) Slab 4 mt. span - 7 days b-1) Slab above 4 mt. span - 14 days  
 c) Beam 6 mt. span - 14 days c-1) Beam above 6 mt. span - 21 days  
 8) PROPER CARE SHALL BE TAKEN WHILE EXCAVATING NEAR EXISTING BUILDING.  
 9) COLUMN BARS TO BE LAPPED AT THE CENTRE. 50% OF BARS TO BE LAPPED AT ANY POINT.  
 10) LIFT PIT DEPTH TO BE AS PER LIFT AGENCY REQUIREMENT.  
 11) DESIGN IS VALID FOR NO. OF FLOORS INDICATED IN THE COLUMN SCHEDULE.  
 12) CEMENT, SAND & AGGREGATES USED TO PREPARE CONCRETE TO BE OF GOOD QUALITY AND SHOULD CONFIRM TO THEIR RESPECTIVE IS CODES.  
 13) FOR CANTILEVERS, TOP BARS TO BE ANCHORED BEHIND FOR - 60 X DIA OF BARS OR SPAN OF CANTILEVERS - WHICHEVER IS GREATER  
 14) PROVIDE CHAIRS TO SUPPORT EACH TOP BARS.

OWNER:	ARCHITECT/ENGINEER:-
DOG FRIENDLY CENTER BHAVNAGAR	MANISH RUPARELIA
TITLE:- COLUMN FOOTING DETAIL	
DATE: 30/05/2024	
REV./DT. 19/07/2024	
DRG. NO. [2]	
	PH: 0- 9099448051

<b>CLIENT</b>	<b>DRAWN BY</b>	Ar. Devanshi.R
BHAVNAGAR MUNICIPAL CORPORATION	<b>CHECKED BY</b>	
<b>TITLE</b>	<b>DATE</b>	31-08-2024
<b>DOG FRIENDLY CENTER</b>	<b>REVISED DATE</b>	

COPYRIGHT © MANISH RUPARELIA THIS IS DRAWING IS AN INSTRUMENT OF SERVICE AND IS THE SOLE PROPERTY OF MANISH RUPARELIA. ANY USE OF THIS DRAWING WITHOUT WRITTEN CONSTANT BY MANISH RUPARELIA IS PROHIBITED.	<b>ALTERNATE NO.</b>	
	<b>00</b>	



**MANISH RUPARELIA PVT.LTD.**  
 PLANNER-INTERIOR- INFRASTRUCTURE & PROJECT MANAGEMENT CONSULTANT & VALUERS  
 901-902, Time Square,  
 Ayodhya Circle, 150 Feet Ring road,  
 Rajkot-360006.  
 Mo. :- 9374107306  
 web: www.manishruparelia.in  
 e-mail: rupareliamanish@hotmail.com